



Panasonic®

Operating Instructions Portable DVD/CD Player

Model No. **DVD-LS50**
DVD-LS55
DVD-LS53

DVD-LS50

Dear customer

Thank you for purchasing this product. For optimum performance and safety, please read these instructions carefully before connecting, operating or adjusting this product. Please keep this manual for future reference.



PalmTheater

Region number

The player plays DVD-Video marked with labels containing the region number "1" or "ALL".

Example:



Operations in these instructions are described mainly with the main unit, but you can do the operations on the remote control if the remote controls are the same (→ back cover)

Unless otherwise indicated, illustrations in these operating instructions are of DVD-LS50.



This manual was printed with soy based ink.



Table of contents

IMPORTANT SAFETY INSTRUCTIONS . . .	4
Discs that can be played	5
Accessories	6
Preparations	
① Attaching the battery	6
② Recharging the battery	6
③ The remote control	7
④ Adjusting the LCD angle	7
Play	8
Useful functions	10
Enjoying higher quality audio and video . . .	13
Changing the play sequences	14
RAM disc play	15
Playing a HighMAT™ CD	15
Playing data discs	16
Using the contents screen to find a track	17
Operating with On-Screen Menus	18
Changing the player settings	20
Using this unit with other equipment	23
Battery pack	24
Using a car adaptor	25
FM transmitter DVD-LS55	26
Creating files on a computer	27
Frequently asked questions	28
Specifications	29
Troubleshooting guide	30
Maintenance	33
Limited Warranty (ONLY FOR U.S.A.)	34
Product Service	35
Main feature index	Back cover

RQT7682-2P

WARNING:

TO REDUCE THE RISK OF FIRE, ELECTRIC SHOCK OR PRODUCT DAMAGE, DO NOT EXPOSE THIS APPARATUS TO RAIN, MOISTURE, DRIPPING OR SPLASHING AND THAT NO OBJECTS FILLED WITH LIQUIDS, SUCH AS VASES, SHALL BE PLACED ON THE APPARATUS.

CAUTION!

THIS PRODUCT UTILIZES A LASER. USE OF CONTROLS OR ADJUSTMENTS OR PERFORMANCE OF PROCEDURES OTHER THAN THOSE SPECIFIED HEREIN MAY RESULT IN HAZARDOUS RADIATION EXPOSURE. DO NOT OPEN COVERS AND DO NOT REPAIR YOURSELF. REFER SERVICING TO QUALIFIED PERSONNEL.

CAUTION!

DO NOT INSTALL OR PLACE THIS UNIT IN A BOOKCASE, BUILT-IN CABINET OR IN ANOTHER CONFINED SPACE. ENSURE THE UNIT IS WELL VENTILATED. TO PREVENT RISK OF ELECTRIC SHOCK OR FIRE HAZARD DUE TO OVERHEATING, ENSURE THAT CURTAINS AND ANY OTHER MATERIALS DO NOT OBSTRUCT THE VENTILATION VENTS.

The following mark and symbols are located on bottom of the unit.



CAUTION
RISK OF ELECTRIC SHOCK
DO NOT OPEN



CAUTION: TO REDUCE THE RISK OF ELECTRIC SHOCK, DO NOT REMOVE SCREWS. NO USER-SERVICEABLE PARTS INSIDE. REFER SERVICING TO QUALIFIED SERVICE PERSONNEL.



The lightning flash with arrowhead symbol, within an equilateral triangle, is intended to alert the user to the presence of uninsulated "dangerous voltage" within the product's enclosure that may be of sufficient magnitude to constitute a risk of electric shock to persons.



The exclamation point within an equilateral triangle is intended to alert the user to the presence of important operating and maintenance (servicing) instructions in the literature accompanying the appliance.

Marking sign is located on bottom of the unit.

CAUTION- LASER RADIATION WHEN OPEN AND INTERLOCK DEFEATED. DO NOT STARE INTO BEAM. FDA 21 CFR / Class II

CAUTION- VISIBLE AND INVISIBLE LASER RADIATION WHEN OPEN AND INTERLOCKS DEFEATED.

AVOID EXPOSURE TO BEAM. IEC60825-1/ Class 3b

ATTENTION- RAYONNEMENT LASER VISIBLE ET INVISIBLE DANGEREUX EN CAS D'OUVERTURE ET LORSQUE LA SÉCURITÉ EST NEUTRALISÉE. EXPOSITION DANGEREUSE AU FAISCEAU. (Bottom of product)

THE FOLLOWING APPLIES ONLY IN THE U.S.A.

CAUTION:

This equipment has been tested and found to comply with the limits for a Class B digital device, pursuant to Part 15 of the FCC Rules. These limits are designed to provide reasonable protection against harmful interference in a residential installation. This equipment generates, uses and can radiate radio frequency energy and, if not installed and used in accordance with the instructions, may cause harmful interference to radio communications. However, there is no guarantee that interference will not occur in a particular installation. If this equipment does cause harmful interference to radio or television reception, which can be determined by turning the equipment off and on, the user is encouraged to try to correct the interference by one or more of the following measures:

Reorient or relocate the receiving antenna. Increase the separation between the equipment and receiver. Connect the equipment into an outlet on a circuit different from that to which the receiver is connected. Consult the dealer or an experienced radio/TV technician for help.

Any unauthorized changes or modifications to this equipment would void the user's authority to operate this device.

This device complies with Part 15 of the FCC Rules. Operation is subject to the following two conditions: (1) This device may not cause harmful interference, and (2) this device must accept any interference received, including interference that may cause undesired operation.

Batteries

1. Battery pack (Lithium ion battery pack)

Use this unit to recharge the battery pack.

Do not use the battery pack with equipment other than the specified player.

Do not use the player outside if it is snowing or raining. (The battery pack is not waterproof.)

Do not get dirt, sand, liquids, or other foreign matter on the terminals.

Do not touch the plug terminals (i and j) with metal objects.

Do not disassemble, remodel, heat or throw into fire.

If any electrolyte should come into contact with your hands or clothes, wash it off thoroughly with water.

If any electrolyte should come into contact with your eyes, never rub the eyes.

Rinse eyes thoroughly with water, and then consult a doctor.

2. Disposing of the batteries

Check and follow your local regulations before disposal.

CAUTION:

The batteries used in this device may present a risk of fire or chemical burn if mistreated. Do not disassemble or incinerate the batteries. Do not heat the batteries above the following temperatures.

Battery Pack 60 °C (140 °F)

Replace only with Panasonic part number indicated below:

Battery pack (Lithium ion battery pack)

CGR-H701

CGR-H703

Use of other batteries may present a risk of fire or explosion.

AC adaptor

This AC adaptor operates on AC between 100 V and 240 V.

But

In the U.S.A. and Canada, the AC power supply cord must be connected to a 120 V AC power supply only.

When connecting to an AC supply outside of the U.S.A. or Canada, use a plug adaptor to suit the AC outlet configuration.

When connecting to a supply of greater than AC 125 V, ensure the cord you use is suited to the voltage of the AC supply and the rated current of the AC adaptor.

Contact an electrical parts distributor for assistance in selecting a suitable AC plug adaptor or AC cord set.

CAUTION:

Use only Panasonic car adaptor DY-DC95.

A lithium ion/polymer battery that is recyclable powers the product you have purchased. Please call 1-800-8-BATTERY for information on how to recycle this battery.



THE FOLLOWING APPLIES ONLY IN THE U.S.A.

Notice:

This product has parts that contains a small amount of mercury. It also contains lead in some components. Disposal of these materials may be regulated in your community due to environmental considerations. For disposal or recycling information please contact your local authorities, or the Electronics Industries Alliance: <<http://www.eiae.org>>

DVD-LS55

THE FOLLOWING APPLIES ONLY IN CANADA NOTICE:

Operation is subject to the following two conditions: (1) this device may not cause interference, and (2) this device must accept any interference, including interference that may cause undesired operation of the device.

IMPORTANT SAFETY INSTRUCTIONS

Read these operating instructions carefully before using the unit. Follow the safety instructions on the unit and the applicable safety instructions listed below. Keep these operating instructions handy for future reference.

- 1) Read these instructions.
- 2) Keep these instructions.
- 3) Heed all warnings.
- 4) Follow all instructions.
- 5) Do not use this apparatus near water.
- 6) Clean only with dry cloth.
- 7) Do not block any ventilation openings.
Install in accordance with the manufacturer's instructions.
- 8) Do not install near any heat sources such as radiators, heat registers, stoves, or other apparatus (including amplifiers) that produce heat.
- 9) Do not defeat the safety purpose of the polarized or grounding-type plug. A polarized plug has two blades with one wider than the other. A grounding-type plug has two blades and a third grounding prong. The wide blade or the third prong are provided for your safety. If the provided plug does not fit into your outlet, consult an electrician for replacement of the obsolete outlet.
- 10) Protect the power cord from being walked on or pinched particularly at plugs, convenience receptacles, and the point where they exit from the apparatus.
- 11) Only use attachments/accessories specified by the manufacturer.
- 12) Use only with the cart, stand, tripod, bracket, or table specified by the manufacturer, or sold with the apparatus. When a cart is used, use caution when moving the cart/apparatus combination to avoid injury from tip-over.
- 13) Unplug this apparatus during lightning storms or when unused for long periods of time.
- 14) Refer all servicing to qualified service personnel. Servicing is required when the apparatus has been damaged in any way, such as power-supply cord or plug is damaged, liquid has been spilled or objects have fallen into the apparatus, the apparatus has been exposed to rain or moisture, does not operate normally, or has been dropped.



Do not rest the unit on your lap for a long time while using it. The unit can become hot and cause burns.

To prevent damage

Avoid the following:

Spraying flammable insecticides near the unit.

Pressing the LCD.

Touching the lens and other parts of the laser pickup.

Do not use the unit in the following places;

Sandy places such as beaches.

On top of cushions, sofas, or hot equipment such as amplifiers.



Listening caution



Do not play your headphones or earphones at a high volume. Hearing experts advise against continuous extended play.

If you experience a ringing in your ears, reduce volume or discontinue use.

Do not use while operating a motorized vehicle. It may create a traffic hazard and is illegal in many areas.

You should use extreme caution or temporarily discontinue use in potentially hazardous situations.

Even if your headphones or earphones are the open-air type designed to let you hear outside sounds, don't turn up the volume so high that you can't hear what's around you.

Sound can be deceiving. Over time your hearing "comfort level" adapts to higher volumes of sound. So what sounds "normal" can actually be loud and harmful to your hearing.

Guard against this by setting your equipment at a safe level BEFORE your hearing adapts.

To establish a safe level:

Start your volume control at a low setting.







Slowly increase the sound until you can hear it comfortably and clearly, and without distortion.

Once you have established a comfortable sound level:

Leave it there.

Discs that can be played

This operating instruction manual uses the following icons such as **RAM**.

	RAM	Recorded using Version 1.1 of the Video Recording Format (a unified video recording standard).	Recorded with DVD video recorders, DVD video cameras, personal computers, etc. Remove discs from their cartridges before use.
	JPEG	Recorded using the DCF (Design rule for Camera File system) standard.	Recorded with Panasonic DVD-Video recorders To play JPEG files, select "Play as Data Disc" in Other Menu (→ page 19).
	DVD-A	Played on this unit in 2 channels.	
	DVD-V	Some DVD-Audio discs contain DVD-Video content. To play DVD-Video content, select "Play as DVD-Video" in Other Menu (→ page 19).	
		—	
	DVD-V	Panasonic DVD-R recorded and finalized ⁵ on Panasonic DVD-Video recorders or DVD-Video cameras are played as DVD-Video on this unit.	
		—	
	VCD	Conforming to IEC62107	
	CD	—	
—	WMA MP3 JPEG CD VCD	This unit can play CD-R/RW (audio recording disc) recorded with the formats on the left. Close the sessions or finalize ⁵ the disc after recording. HighMAT discs WMA, MP3 or JPEG files only. To play without using the HighMAT function, select "Play as Data Disc" in Other Menu (→ page 19).	

⁵ A process that allows play on compatible equipment.

It may not be possible to play the above discs in all cases due to the type of disc or condition of the recording.

Discs that cannot be played

DVD-ROM, CD-ROM, CDV, CD-G, DVD^I R, I RW, DVD-RW, SACD, Divx Video Discs and Photo CD, DVD-RAM that cannot be removed from their cartridge, 2.6-GB and 5.2-GB DVD-RAM, and "Chaoji VCD" available on the market including CVD, DVCD and SVCD that do not conform to IEC62107.

Audio format of DVDs

You can play discs in stereo with these symbols.



Accessories



Use numbers indicated in parentheses when asking for replacement parts. The included AC power supply cord and AC adaptor are for use with this unit only. Do not use them with other equipment.

(Only for U.S.A.) To order accessories, refer to "Accessory Purchases" on page 35. (For other areas) To order accessories, call the dealer from whom you have made your purchase.

- 1 Remote control (N2QAJB000105)
- 2 Remote control batteries
- 1 Audio/video cable (K2KA6CB00003)
- 1 AC adaptor (RFEA906W-W)
- 1 AC power supply cord (K2CB2CB00006)

- 1 Rechargeable battery pack
DVD-LS50 (CGR-H701)
DVD-LS55 DVD-LS53 (CGR-H703)

For replacement: Available from Panasonic dealers

Preparations

1 Attaching the battery (When the unit is off)

The illustrations show connection for CGR-H701. Connect CGR-H703 in the same way.

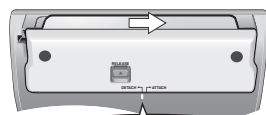
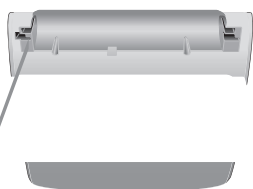

Clicks into place

Check to make sure it is securely fastened.

③ The remote control

Batteries

Insert so the poles (i and j) match those in the remote control.
Do not use rechargeable type batteries.

Do not:

- mix old and new batteries.
- use different types at the same time.
- heat or expose to flame.
- take apart or short circuit.
- attempt to recharge alkaline or manganese batteries.
- use batteries if the covering has been peeled off.





Mishandling of batteries can cause electrolyte leakage which can damage items the fluid contacts and may cause a fire.
Remove if the remote control is not going to be used for a long period of time. Store in a cool, dark place.

Range of use

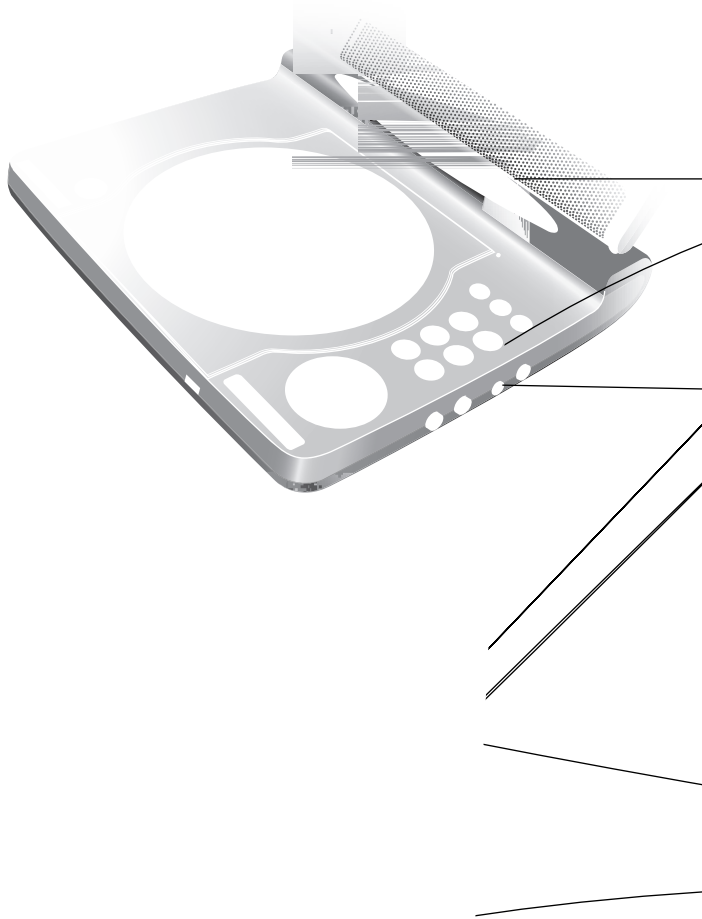

④ Adjusting the LCD angle



	Skip	Skips items.
TOP MENU 	Top menu	DVD-A DVD-V
	Direct navigator	RAM (→ page 15)
MENU 	Menu	DVD-V
	Playlist play	RAM (→ page 15)
	Navigation menu	WMA MP3 JPEG (→ page 16)
RETURN 	Return	Returns to the previous screen. VCD (with PBC) Returns to the menu.
	Search	Turn the shuttle dial. Release the shuttle dial to return to normal play.
	Slow play	Turn the shuttle dial while paused. Press [1, ON] to return to normal play. VCD [5] only.
	Menu operation	Use [3 4 2 1] to select an item and press [ENTER] to confirm.
	Frame by Frame	While paused, use [2 1]. VCD [1] only.
	Group skip	WMA MP3 JPEG Use [3 4].

Remote control operations

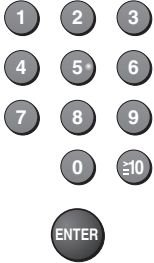
	Search (During play)/Slow play (While paused) (→ above)	j
	Enter number	RAM DVD-A DVD-V VCD CD e.g. To select 12: [S 10] → [1] → [2] VCD with playback control While stopped, press the numbered buttons. WMA MP3 JPEG e.g. To select 123: [1] → [2] → [3] → [ENTER]

Useful functions

Repeat play § Can only be used with discs that show the elapsed time display.
For JPEG, you can use even if there is no elapsed time display.

REPEAT Press to select the content to repeat.



To repeat a specified section (A-B Repeat)

Except **JPEG** and **RAM** (still picture part)

A-B
REPEAT



(Remote control)

Press at the starting and ending points.

Press again to cancel.



Changing play speed **RAM DVD-V**



PLAY SPEED



(Remote control)

–from k 0.6 to k 1.4 (in 0.1 units)

After you change the speed

–Digital output switches to PCM-2ch.

–Sampling frequency of 96 kHz is converted to 48 kHz.

DVD-VR

×0.9 ▶

To return to normal play

Press [1] (PLAY).

Quick replay *Except JPEG* (Only when the elapsed play time can be displayed)

QUICK
REPLAY



(Remote control)

Press to skip back a few seconds.



Select a group and play **DVD-A WMA MP3 JPEG**

1 While stopped



(Remote control)



2

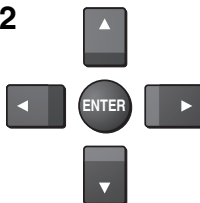

(Remote control)

Press [3 4] to select the item and press [ENTER].

Audio **RAM** **DVD-A** **DVD-V** **VCD** (For discs recorded with multiple audio)

AUDIO

(Remote control)

Press to change.



RAM **VCD**

You can use this button to select "L", "R" or "L R".

DVD-V (Karaoke discs)

Press [2 1] to select "On" or "Off" for vocals. Read the disc's instructions for details.

Signal type/data

LPCM/PPCM/i Digital/DTS/MPEG: Signal type
kHz (Sampling frequency)/bit/ch (Number of channels)

Example: 3/2_1ch

- 1: 1: Low frequency effect (not displayed if there is no signal)
- 0: No surround
- 1: Mono surround
- 2: Stereo surround (left/right)
- 1: Center
- 2: Front lefti Front right
- 3: Front lefti Front righti Center

Subtitle **RAM** (On/Off only) **DVD-V** (with multiple subtitles) **VCD** (SVCD only)

SUBTITLE

(Remote control)

Press to change.



To clear/display the subtitles

Press [2 1] to select "On" or "Off".

RAM (Only discs that contain subtitle on/off information)

Subtitle on/off information cannot be recorded using Panasonic DVD Recorders. (Subtitle on/off information is also not recordable on Panasonic DVD-R finalized with a Panasonic DVD Recorder.)

Angle select and Still picture rotation

ANGLE

(Remote control)

DVD-V (with multiple angles)–Angle select

JPEG –Still picture rotation

Still picture advance **DVD-A**

PAGE

(Remote control)

Useful functions

Selecting how to show 4:3 aspect pictures on the LCD

MONITOR
MODE



NORMAL:

Normal

FULL:

Stretched horizontally

ZOOM:

Stretched vertically and horizontally

OFF:

No picture

... LCD on this unit, select "OFF" to conserve power.

... if you close it.

ed

... the item, and
... ting.

Enjoying higher quality audio and video

Remote control only

AV Enhancer

By just pressing one button the disc type is automatically determined and the best audio and video settings which are indicated below are configured.

AV ENHANCER



Press to select "On".



Audio settings:

Multi Re-master (→ see below), Advanced Surround (→ page 12),
Dialogue Enhancer (→ page 19, Audio Menu)

Video settings:

Picture Mode (→ see below)

When AV Enhancer is on, individual settings can no longer be changed.

Multi Re-master

RAM DVD-V (Discs recorded with 48 kHz only)

DVD-A (Discs recorded with 44.1 kHz and 48 kHz only)

VCD CD

This feature gives you a more natural sound by adding the higher frequency signals not recorded on the disc.

WMA MP3 (Disc recording is other than 8 kHz, 16 kHz and 32 kHz)

This feature reproduces the frequencies lost during recording to give you a sound closer to the original.

RE-MASTER



Press to select "1" "2" or "3".



Setting	DVD-A DVD-V CD (LPCM/PPCM) Type of music	Other discs Effect level
1	High tempo (e.g., pop and rock)	Light
2	Various tempos (e.g., jazz)	Medium
3	Low tempo (e.g., classical)	Strong
Off	Off	Off

Multi Re-master may not work when connecting with a digital optical cable (→ page 23) .

Picture Mode

CINEMA



Normal

Cinema1: Mellow images and enhances detail in dark scenes.

Cinema2: Sharpens images and enhances detail in dark scenes.



The above indicated features may not work depending on the disc's recording.

Changing the play sequences Remote control only

DVD-A **DVD-V** **VCD** **CD** **WMA** **MP3** **JPEG**

PLAY MODE While stopped



Press to change. All group (**DVD-A**) → Program → Random

↑ Normal play ←

Disable HighMAT disc play to use random and program play.

Select "Play as Data Disc" in Other Menu. (→ page 19).

To exit the all group, program or random mode, press [PLAY MODE] several times while stopped.

All group play **DVD-A**

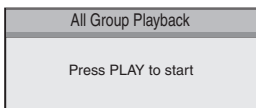

Changing the play sequences

Program play (Max. 32 items)

e.g.) DVD-Video

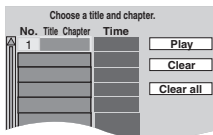

1

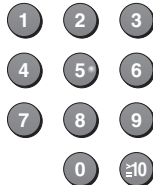

Press to select an item (→ page 9).

2



To continue selecting, repeat this operation.

Selecting all the items (on the disc or in the title or group)

Press [ENTER] and [3 4] to select "ALL", then press [ENTER] again to register.

Changing the program

Press [3 4] to select an item.

–To change an item, repeat step 1.

–To clear an item, press [CANCEL] (or select "Clear" and press [ENTER]).

Press [PAGE] to skip page by page.

Clearing the whole program

Select "Clear all" and press [ENTER]. The whole program is also cleared when the unit is turned off or the disc lid is opened.

Random play

e.g.) DVD-Video

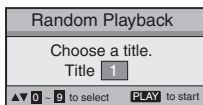

1

DVD-A **DVD-V** **WMA** **MP3** **JPEG**

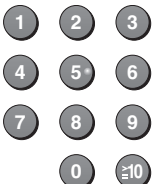

Press to select an item (→ page 9).

2



RAM disc play RAM § You cannot edit titles or playlists on this unit.

Selecting programs to play (DIRECT NAVIGATOR)

1 TOP MENU

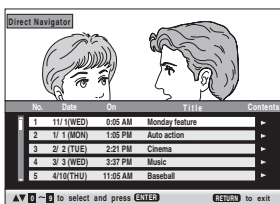

2



Use [3 4] to select the program and press [ENTER].

You can also use the numbered buttons on the remote control (→ page 9). Use [1] to show the contents of the program.

To cancel the menu, press [TOP MENU].

Playlist play § Only for discs created with playlists

1 MENU

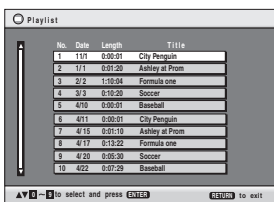

2



Use [3 4] to select the playlist and press [ENTER].

You can also use the numbered buttons on the remote control (→ page 9).

To cancel the menu, press [MENU].

Playing a HighMAT™ CD WMA MP3 JPEG



While the menu is displayed Use [3 4 2 1] to select items and press [ENTER].



Menu:
Takes you to the next menu which shows playlists or another menu.



Playlist:
Play starts.

To return to the menu, press [TOP MENU].

To change to the menu background recorded on disc, press [DISPLAY] while the menu is displayed.

Selecting from the list menu to play

1. During play, press [MENU].
2. Use [2] then [3 4] to change the list.
3. Use [1] then [3 4] to select an item and press [ENTER].

Press [PAGE] to skip page by page.

To cancel the menu, press [MENU].



HighMAT and the HighMAT logo are either trademarks or registered trademarks of Microsoft Corporation in the United States and/or other countries.

Playing data discs WMA MP3 JPEG

You can play JPEG files on DVD-RAM or play HighMAT discs without using the HighMAT function (→ page 19, "Play as Data Disc" in Other Menu).

Using playback menus (except JPEG files on DVD-RAM)



While the menu is displayed

Use [3 4] to select "All", "Audio", or "Picture" and press [ENTER].

To display/exit the screen

Press [TOP MENU].

Using navigation menus

1 MENU



2



Use [3 4 2 1] to select the group or audio/picture content and press [ENTER].

To enjoy listening to WMA/MP3 contents while showing a JPEG image on the screen

Select a JPEG file first, and then select audio contents. (The opposite order is not effective.)

To exit the screen

Press [MENU].

Using the submenu

While the navigation menu (→ see left) is displayed.

1 DISPLAY



2



Use [3 4] to select the submenu (→ see below) and press [ENTER].

Submenu

✓ Multi	Groups and content
List	Content only
Tree	Groups only
Thumbnail	Thumbnail images JPEG
Next group	To the next group WMA MP3
Previous group	To the previous group WMA MP3
All	WMA/MP3 and JPEG files
Audio	WMA/MP3 files only
Picture	JPEG files only
Help display	To switch between guide messages and the elapsed play time indicator
Find	To search by content or group title (→ see below)

Searching by a content or group title

Place the cursor on the group title to search a group, or place the cursor on the content title to search content.

- 1 Select "Find" (→ see above).
- 2 Use [3 4] to select a character and press [ENTER].
Repeat to enter another character.
Lower case is also searched.
Use [6 5] to skip between A, E, I, O and U.
Use [2] to erase a character.
Erase the asterisk (*) to search for the titles starting with that character.
- 3 Use [1] to select "Find" and press [ENTER].
The search result screen appears.
- 4 Use [3 4] to select the content or group and press [ENTER].

Using the contents screen to find a track

CD (CD text only)

1 MENU

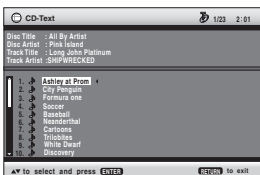

2



Use [3 4] to move through the tracks and press [ENTER].

Press [PAGE] (on the remote control) to skip page by page.

Operating with On-Screen Menus

1 **DISPLAY** Press once.



2 **ENTER** Use [3 4] to select the menu.
Use [1] to go to the next menu and [3 4] to set.



Use [2] to go to the previous menu

Items shown differ depending on the type of software.

There are items which you can select using the **numbered buttons** and [ENTER] on the remote control.

If the setting does not change, press [ENTER].

To finish, press [RETURN].

Main menus

Program, Group, Title	To start from a specific item
Chapter, Track, Playlist	
Content	
Time	<p>To skip incrementally or decrementally (Time Slip for play only)</p> <p>1 Press [ENTER] twice to show Time Slip indicator.</p> <p>2. Use [3 4] to select the time and press [ENTER]. Move and hold [3 4] to alter faster.</p> <p>To start from a specific time (Time Search) To change remaining/elapsed time display</p>
Audio	(→ page 11)
	To display the current bitrate or sampling frequency
Still Picture	(→ page 11)
Thumbnail	To show thumbnail images
Subtitle	(→ page 11)
Marker(VR)	To recall a marker recorded on DVD-Video recorders
Angle	(→ page 11)
Rotate picture	(→ page 11)
Slideshow	<p>To turn on/off slideshow</p> <p>To change the slideshow timing (0–30 sec)</p>

Other settings

Play Speed	(→ page 10, "Changing play speed")
AV Enhancer	(→ page 13)

Play Menu (Only when the elapsed play time can be displayed / [JPEG]: Works with all JPEG content.)

Repeat	(→ page 10, Repeat play)
A-B Repeat	(→ page 10, A-B Repeat)
Marker	<p>To mark up to 5 positions to play again</p> <p>[ENTER] (The unit is now ready to accept markers.)</p> <p>To mark a position: [2 1] → [ENTER] (at the desired point)</p> <p>To mark another position: [2 1] → [ENTER]</p> <p>To recall a marker: [2 1] → [ENTER]</p> <p>To erase a marker: [2 1] → [CANCEL] (Remote control)</p> <p>This feature doesn't work during program and random play.</p>

Picture Menu

Picture Mode (→ page 13)

Audio Menu

Advanced Surround (→ page 12)

Dialogue Enhancer
To make the dialogue in movies easier to hear
DVD-V (Dolby Digital, DTS, 3-channel or over, with the dialogue recorded in the center channel)
On ←→ Off

Multi Re-master (→ page 13)

Display Menu

Information On ←→ Off (**JPEG**: Off, Date, Details)

Subtitle Position 0 to s 60 (in 2 units)

Subtitle Brightness Auto, 0 to s 7

Just Fit Zoom
RAM DVD-V VCD
To expand the letterbox picture to fit the screen.
Use [3 4] to select the preset aspect ratio or "Auto".

Manual Zoom
RAM DVD-V VCD
Use [3 4] for fine adjustments.
-from k 1.00 to k 1.60 (in 0.01 units)
-from k 1.60 to k 2.00 (in 0.02 units)

Bitrate Display **RAM DVD-V VCD** On ←→ Off

GUI See-through On ←→ Off

Other Menu

Setup (→ page 20)

Play as DVD-Video
or
Play as DVD-Audio
While stopped, select "Play as DVD-Video" to play DVD-Video contents on DVD-Audio.

Play as DVD-VR
Play as HighMAT
or
Play as Data Disc
While stopped, select "Play as Data Disc" to play JPEG files on DVD-RAM or to play a HighMAT disc without using the HighMAT function.

Checking the play status (Elapsed play time indicator)

Press [DISPLAY] twice.

Condition—play, pause or slow/search

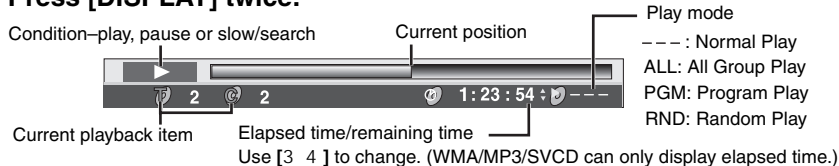

Changing the player settings

Referring to pages 20 to 22, change as required.

Underlined items are the factory presets.

The settings remain intact even if you switch the unit to standby.

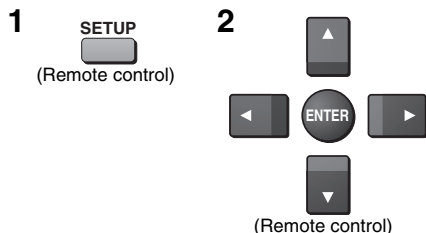

Press [3 4 2 1] to select the menu, item, content and press [ENTER].

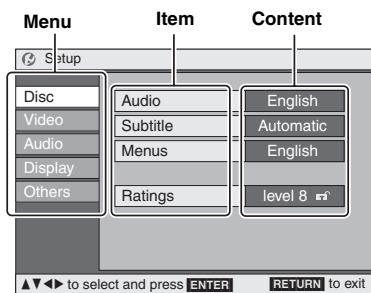

To return to the previous screen, press [RETURN].

To finish the SETUP menu, press [SETUP].

While stopped, the menu is also displayed when [MENU] on the main unit is pressed, however, when a DVD-RAM or HighMAT CD is being used a playlist menu appears.

Disc

Audio	<u>English</u> French Spanish Original (The original language designated on the disc is selected) OtherⒸ Ⓒ Ⓒ Ⓒ §
Subtitle	<u>Automatic</u> [If the language selected for "Audio" is not available, subtitles appear in that language (If available on the disc).] English French Spanish OtherⒸ Ⓒ Ⓒ Ⓒ §
Menus	<u>English</u> French Spanish OtherⒸ Ⓒ Ⓒ Ⓒ §
Ratings Set a ratings level to limit DVD-Video play.	<u>8 No Limit.</u> 1 to 7: Prohibits play corresponding to ratings recorded on the disc. 0 Lock All: To prevent play of discs without ratings levels. Once level 0 to 7 is set, a password entry screen is displayed. Follow the on-screen instructions.
	Do not forget your password. When you insert a disc that exceeds the ratings limit, a message appears on the screen. Follow the on-screen instructions.

§ Input a code number referring to the table on page 22.

Changing the player settings

Display

Menu Language	English	Français	Español
On-Screen Messages	On	Off	

Others

HighMAT Selects the play method for HighMAT discs	Enable: Plays as HighMAT Disable: Plays as WMA/MP3/JPEG
Re-initialize Setting This returns all values in the Setup menus to the default settings.	Yes: The password screen is shown if "Ratings" (→ page 20) are set. Please enter the same password. Turn the unit off and on again. No

Changing the player settings

Language code list

Abkhazian: 6566	Chinese: 9072	Hindi: 7273	Malagasy: 7771	Samoan: 8377	Tibetan: 6679
Afar: 6565	Corsican: 6779	Hungarian: 7285	Malay: 7783	Sanskrit: 8365	Tigrinya: 8473
Afrikaans: 6570	Croatian: 7282	Icelandic: 7383	Malayalam: 7776	Scots Gaelic: 7168	Tonga: 8479
Albanian: 8381	Czech: 6783	Indonesian: 7378	Maltese: 7784	Serbian: 8382	Turkish: 8482
Ameharic: 6577	Danish: 6865	Interlingua: 7365	Maori: 7773	Serbo-Croatian: 8372	Turkmen: 8475
Arabic: 6582	Dutch: 7876	Irish: 7165	Marathi: 7782	Shona: 8378	Tw: 8487
Armenian: 7289	English: 6978	Italian: 7384	Moldavian: 7779	Sindhi: 8368	Ukrainian: 8575
Assamese: 6583	Esperanto: 6979	Japanese: 7465	Mongolian: 7778	Singhalese: 8373	Urdu: 8582
Aymara: 6588	Estonian: 6984	Javanese: 7487	Nauru: 7865	Slovak: 8375	Uzbek: 8590
Azerbaijani: 6590	Faroese: 7079	Kannada: 7578	Nepali: 7869	Slovenian: 8376	Vietnamese: 8673
Bashkir: 6665	Fiji: 7074	Kashmiri: 7583	Norwegian: 7879	Somali: 8379	Volapük: 8679
Basque: 6985	Finnish: 7073	Kazakh: 7575	Oriya: 7982	Spanish: 6983	Welsh: 6789
Bengali, Bangla: 6678	French: 7082	Kirghiz: 7589	Pashto, Pushto: 8083	Sundanese: 8385	Wolof: 8779
Bhutani: 6890	Frisian: 7089	Korean: 7579	Persian: 7065	Swahili: 8387	Xhosa: 8872
Bihari: 6672	Galician: 7176	Kurdish: 7585	Polish: 8076	Swedish: 8386	Yiddish: 7473
Breton: 6682	Georgian: 7565	Laotian: 7679	Portuguese: 8084	Tagalog: 8476	Yoruba: 8979
Bulgarian: 6671	German: 6869	Latin: 7665	Punjabi: 8065	Tajik: 8471	Zulu: 9085
Burmese: 7789	Greek: 6976	Latvian, Lettish: 7686	Quechua: 8185	Tamil: 8465	
Byelorussian: 6669	Greenlandic: 7576	Lingala: 7678	Rhaeto-Romance: 8277	Tatar: 8484	
Cambodian: 7577	Guarani: 7178	Lithuanian: 7684	Romanian: 8279	Telugu: 8469	
Catalan: 6765	Hausa: 7265	Macedonian: 7775	Russian: 8285	Thai: 8472	
	Hebrew: 7387				

Using this unit with other equipment

Turn off all equipment before connecting and read the appropriate operating instructions.

Enjoying with 5.1ch audio

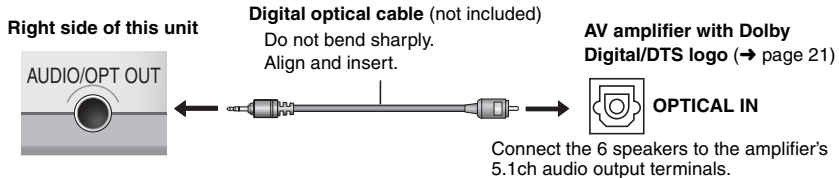

Change "PCM Digital Output", "Dolby Digital", and "DTS Digital Surround" (→ page 21).

DVD-A Output will be only 2 channels.

Enjoying stereo audio

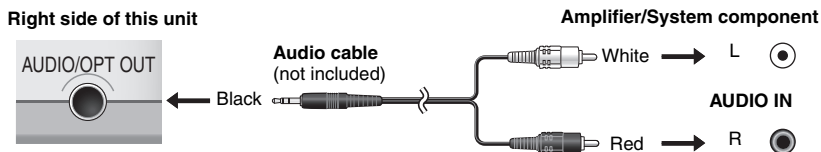

Television connections

Connect the video output from this unit directly to the television.

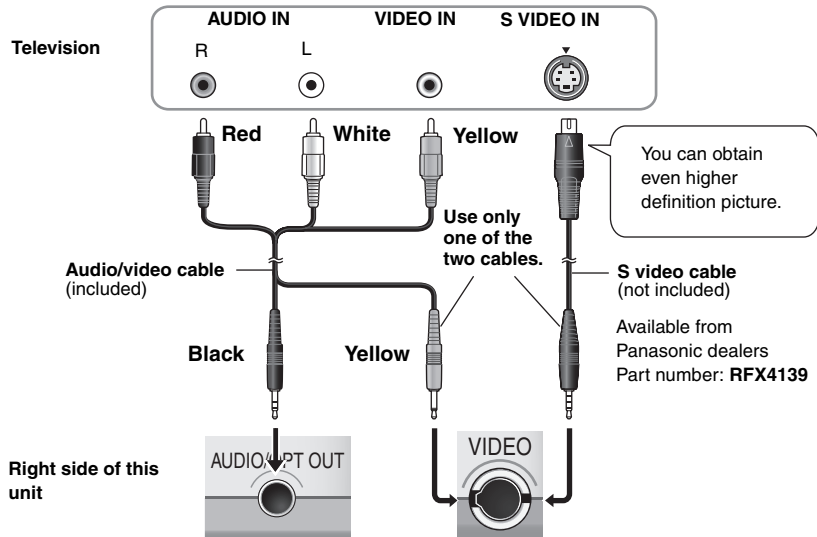

If you raise the volume on the television while playing this unit, the volume may abruptly become very loud when you switch to a television broadcast. Return the volume to its normal level before changing.

Download from www.Somanuals.com. All Manuals Search And Download.

Battery pack

Checking the remaining battery charge

When the unit is on (→ page 8) and powered by the battery pack.

Press **[DISPLAY]** 3 times to check on the LCD (Displays for a few seconds).



Approximate play times (Hours)

Battery pack	Play (at room temperature using headphones)			
	LCD brightness level			LCD Off
	j 5	0 (factory preset)	i 5	
CGR-H701	2.5	2	1.5	4
CGR-H703	10	8	6	16

The times indicated above may differ depending on use.

To change the LCD brightness (→ page 12, Adjusting the picture quality on the LCD).

Detaching

Turn the unit off before detaching the battery pack.

The illustrations show connection for CGR-H701. Connect CGR-H703 in the same way.

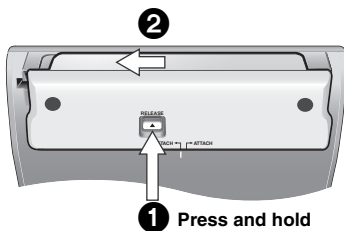

When not using for long periods of time

Remove the battery pack (→ see above). (Even when the unit is turned off, there is a small amount of voltage running through the unit, and this may result in a malfunction.)

Recharge the battery for re-use.

Using a car adaptor

In the interest of traffic safety, do not perform operations on this unit or view video software while driving a vehicle.

Read the car adaptor's operating instructions carefully.

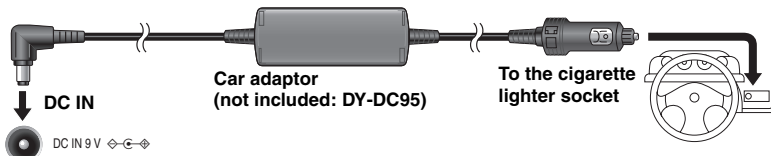

Left side of this unit

Place the unit on a stable surface.



(Right side of this unit)

You can enjoy audio through your car audio system by connecting a car stereo cassette adaptor (not included: RP-CC20) to the headphone jack on the right side of this unit.

FM transmitter DVD-LS55

You can enjoy listening to discs through your FM radio channel (e.g. car stereo) by transmitting audio signals from this unit.

- 1** **Press to switch the FM transmitter on.**



(Left side of this unit)

On position



- 2** **Play.**



- 3** **Adjust the volume using this unit.**



• No sound is heard from this unit. (When playing a music CD, adjust to a level near the center of the volume scale on the LCD as the guideline; when playing a DVD movie, etc., adjust to a level near the maximum as the guideline.)

- 4** **Tune the radio to the 88.3 MHz FM frequency.**

- 5** **Adjust the volume using the radio.**

To turn off the FM transmitter

Press [FM-TM ON/OFF] to return to the original position.

FM transmitter

When this has not been successful

- 1** **Press to display the menu.**



```
FM TRANSMITTER
▶ * STEREO      MONO
  88.3 MHz
                                [ON]
```

- 2** **– Noise is heard**
Select “MONO” using [◀ ▶].



– When there is interference with the local FM stations

- ① **Select “88.3 MHz” (factory preset) using [▼].**

- ② **Using [◀ ▶], select a frequency between 88.3 MHz and 90.3 MHz which is not being used by a broadcasting station.**

• The frequency can be set in 0.1 MHz increments.

- 3** **Tune the FM radio into the frequency selected in step 2.**

To exit from the FM transmitter menu

Press [FM-TM MODE].

Creating files on a computer WMA MP3 JPEG

Folders and files created on a computer are displayed as group names and track/picture names on this unit.
Root

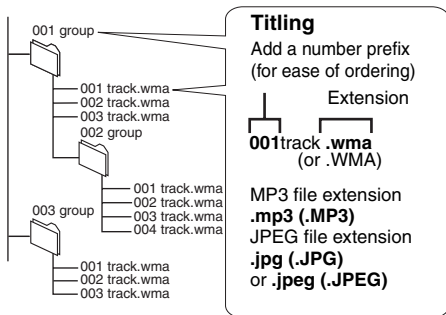

Unit limitations

Discs must conform to ISO9660 level 1 or 2 (except for extended formats).

This unit is compatible with multi-session but if there are a lot of sessions it takes more time for play to start. Keep the number of sessions to a minimum to avoid this.

Groups below the 8th tree level are displayed on the same level as the 8th level.

The menu display on this unit and on a computer may be different.

Depending on how a disc was created, the play order may change.

Files created using packet write cannot be played.

WMA

You cannot play WMA files that are copy protected.

MP3

This unit is not compatible with ID3 tags.

Compatible sampling rate: 8, 11.02, 12, 16, 22.05, 24, 32, 44.1, and 48 kHz

JPEG

To view JPEG files on this unit:

–Take them on a digital camera that meets the DCF Standard (Design rule for Camera File system)

Version 1.0. Some digital cameras have functions that are not supported by the DCF Standard Version 1.0 like automatic picture rotation which may render a picture un-viewable.

–Do not alter the files in any way or save them under a different name.

This unit cannot display moving pictures, MOTION JPEG and other such formats, still pictures other than JPEG (e.g. TIFF) or play associated sound.

MPEG Layer-3 audio decoding technology licensed from Fraunhofer IIS and Thomson multimedia.

Windows Media, and the Windows logo are trademarks, or registered trademarks of Microsoft Corporation in the United States and/or other countries.

WMA is a compression format developed by Microsoft Corporation. It achieves the same sound quality as MP3 with a file size that is smaller than that of MP3.



Frequently asked questions

Reference pages are shown in parentheses.

What kind of equipment is necessary to enjoy 5.1ch audio?	Connect to an AV amplifier (that has 5.1ch audio output terminals) displaying the Dolby Digital/DTS logo. (21) DVD-A: This unit plays DVD-Audio in 2 channels. You cannot play multi channel surround sound.
Can I play a DVD-Video bought in another country?	You can play if the region number includes "1" or "ALL" and the video standard is NTSC. Check the disc jacket.
Can I use on an airplane or in a hospital?	Electromagnetic waves that are emitted from this unit may affect equipment on an airplane or in a hospital. Please obey the rules and or instructions indicated by the hospital or airline.
Can I use in a car?	You can use this unit by connecting with the separately sold car adaptor (part no. DY-DC95) for power. Damage may occur if you do not use the specified car adaptor. (25)
Can I connect with a computer?	You can enjoy use of the computer as a television monitor when connecting with the AV input terminal on a computer. However, you cannot operate this unit as the peripheral equipment.

Manufactured under license from Dolby Laboratories.
"Dolby" and the double-D symbol are trademarks of Dolby Laboratories.

"DTS" and "DTS 2.0i Digital Out" are trademarks of Digital Theater Systems, Inc.

Apparatus Claims of U.S. Patent Nos. 4,631,603, 4,577,216, and 4,819,098, licensed for limited viewing uses only.

This product incorporates copyright protection technology that is protected by method claims of certain U.S. patents and other intellectual property rights owned by Macrovision Corporation and other rights owners. Use of this copyright protection technology must be authorized by Macrovision Corporation, and is intended for home and other limited viewing uses only unless otherwise authorized by Macrovision Corporation. Reverse engineering or disassembly is prohibited.

Specifications

■ Main unit

Discs played:

- (1) DVD-RAM (DVD-VR compatible, JPEG formatted discs)
- (2) DVD-Video (3) DVD-Audio
- (4) Music CD [CD-DA (CD-TEXT compatible)]
- (5) Video CD
- (6) CD-R/RW [CD-DA (CD-TEXT compatible), Video-CD, SVCD, MP3, WMA, JPEG, HighMAT Level 2 (Audio and Image)]
- (7) DVD-R (DVD-Video compatible)
- (8) MP3/WMA
Compatible compression rate:
 - Between 32 kbps and 320 kbps (MP3)
 - Between 48 kbps and 320 kbps (WMA)
- (9) JPEG
 - Exif Ver 2.1 JPEG Baseline files
 - Picture resolution:
between 320×240 and 6144×4096 pixels
(sub sampling is 4:2:2 or 4:2:0)

Signal system: NTSC

LCD screen: 7" α -Si, TFT wide-screen LCD

Composite-video output:

Output level: 1 V_{p-p} (75 Ω)
Output terminal: Mini-jack
Number of terminals: 1 system

S-video output:

Y output level: 1 V_{p-p} (75 Ω)
C output level: 0.286 V_{p-p} (75 Ω)
Output terminal: Mini-jack
Number of terminals: 1 system
(also used for composite-video output)

Audio output:

Output level: 1.5 V_{rms} (1 kHz, 0 dB, 10 k Ω)
Output terminal: Stereo mini-jack
Number of terminals: 1 system

Audio performance:

- (1) Frequency response:
 - DVD (linear audio):
4 Hz–22 kHz (48 kHz sampling)
4 Hz–44 kHz (96 kHz sampling)
 - DVD-Audio:
4 Hz–88 kHz (192 kHz sampling)
 - CD audio: 4 Hz–20 kHz
- (2) S/N ratio:
 - CD audio: 115 dB
- (3) Dynamic range:
 - DVD (linear audio): 98 dB
 - CD audio: 97 dB
- (4) Total harmonic distortion:
 - CD audio: 0.008 %

Digital audio output:

Optical digital output: Mini optical terminal
Number of terminals: 1 system
(also used for audio output)

FM transmitter **DVD-LS55**:

Frequency Modulation: 88.3 MHz–90.3 MHz
(Digital tuning in 0.1 MHz steps)
Output system: Stereo / Mono
(selection is possible)

Pickup:

Wave length: 662 nm/785 nm
Laser power: CLASS II/CLASS I

Power supply:

DC 9 V (DC In terminal)/
DC 7.2 V (Exclusive battery terminal)

Power consumption (using included AC adaptor):

DVD-LS50: 12 W (Unit only: 9 W) / Recharging 12 W

DVD-LS55: 12 W (Unit only: 9 W) / Recharging 20 W

DVD-LS53: 12 W (Unit only: 9 W) / Recharging 12 W

Battery pack (lithium ion)

CGR-H701 (**DVD-LS50** included):

Voltage: 7.2 V

Capacity: 2150 mAh

CGR-H703 (**DVD-LS55** **DVD-LS53** included):

Voltage: 7.2 V

Capacity: 8600 mAh

Dimensions (W×D×H)

(excluding protrusions and battery):

Troubleshooting guide

Before requesting service, make the following checks. If you are in doubt about some of the check points, or if the remedies indicated in the chart do not solve the problem, refer to the "Customer Services Directory" on page 35 if you reside in the U.S.A., or refer to the "Product information" on page 35 if you reside in Canada.

The following do not indicate malfunction.

- Sound from the AC adaptor during recharging.
- The battery pack warming up when recharging or during use.
- The surface and area around the unit becoming warm when used for long periods.

Reference pages are shown in parentheses.

Power

No power.

Check connections to the AC adaptor or battery pack. **(6)**
You cannot turn on the unit with the remote control if the unit is powered by the battery pack.

Unit turns off automatically.

The unit turns off after it has been stopped for about 15 minutes (5 minutes when the unit is powered by the battery pack) to conserve power. Turn the unit on again.

Unit doesn't work when powered by battery pack.

The unit and battery pack have protection circuitry that activate if they become too hot or too cold. They will not work if this occurs. Use the unit and battery pack between 5 °C (41 °F) and 35 °C (95 °F).

Cannot charge or the [CHG] indicator fails to light.

The battery pack can only be recharged when the unit is off. The charging time increases when the temperature is too hot or too cold, and charging may not be possible under some circumstances. Check connections to the AC adaptor or battery pack. **(6)**

Play time dramatically reduced after recharging.

The battery pack has reached the end of its service life (It can be recharged about 300 times).

Operation

It takes time before play starts. **[MP3]**

Play may take time to begin when an MP3 track has still picture data. Even after the track starts, the correct play time will not be displayed, however this is normal.

Programmed items are not played. **[DVD-V]**

Some items cannot be played even if you have programmed them.

A menu screen appears during skip or search. **[VCD]**

This is normal for Video CDs.

The on-screen menu shows "2" as a soundtrack option when [AUDIO] is pressed, but the audio does not change. **[DVD-A]**

Even if a second soundtrack isn't recorded, two numbers will normally be shown.

Play restarts from the beginning of the track when soundtrack is changed. **[DVD-A]**

This is normal on DVD-Audio.

In A-B repeat, Point B is automatically set.

The end of an item becomes point B when it is reached.

Subtitle position is wrong.

Adjust the position. **(19, "Subtitle Position")**

No subtitles.

Display the subtitles. **(11)**

The subtitles overlap closed captions recorded on discs.

Clear the subtitles. **(11)**

You have forgotten your ratings password. Reset all the settings to Factory Preset.

While stopped, press and hold [] and [] on the unit and then also press and hold [1 , ON] on the unit until "Initialized" disappears from the screen. Turn the unit off and on again. All settings will return to the default values.

Operation

No response when any buttons pressed.

Some discs prohibit certain operations.

If there is no response at all, the unit may have been affected by lightning or static electricity. Turn the unit off and on again. Alternatively, turn the unit off, disconnect the power source (AC or battery pack), reconnect the power and turn the unit on again.

Play fails to start or stops soon after starting.

Condensation has formed: Wait 1 to 2 hours for it to evaporate.

This unit cannot play discs other than those specified. (5)

Clean the disc. (33)

Ensure the disc is inserted correctly. (8)

Check that the disc has something recorded on it.

No response when remote control buttons pressed.

Check that the batteries are installed correctly. (7)

The batteries are depleted: Replace it with new ones. (7)

Point the remote control at the remote control sensor and operate. (7)

Cannot add markers.

You cannot add markers while playing a playlist or discs that do not show the elapsed time.

There are already markers. **RAM**

The unit reads and displays the markers added with a DVD video recorder.

Sound

There is a lot of noise.

Move unit away from mobile phones.

Noise may occur when playing WMA files.

No sound from the unit's speaker.

The speaker is off if the LCD is closed or headphones are connected.

Turn up the volume. (8)

No sound from other speakers.

Check all connections and settings. (21), (23)

Cannot play multi channel surround sound

Output is in stereo (PCM) if you have changed the play speed.

This unit plays DVD-Audio in 2 channels.

Distorted sound.

Turn Advanced Surround off if this occurs. (12)

Piercing noise comes from the speakers.

If you have connected a digital amplifier which does not include a decoder, be sure to select "PCM" in "Dolby Digital" or "DTS Digital Surround" in "Audio". (21)

Sound effects do not work.

Dialogue enhancer and Advanced Surround do not work when the unit is outputting bitstream signals. (21)

Advanced Surround does not work if you have changed the play speed. (10)

Some audio effects do not work or have less effect with some discs.

Cannot record to digital recording equipment. (Incorrect sound recorded.)

You cannot record WMA/MP3.

You cannot record DVDs that have protection preventing digital recording.

You cannot record DVDs if the recording equipment cannot handle signals with a sampling frequency of 48 kHz.

Make the following settings:

- Advanced Surround: Off (12)
- PCM Digital Output: Up to 48 kHz (21)
- Dolby Digital/DTS Digital Surround: PCM (21)

FM transmitter does not work.

FM transmitter does not work when the audio/video cable or headphones are connected.

Troubleshooting guide

Picture

The LCD is dark.

Adjust the brightness. (12)

Picture distorted.

Some disruption is normal during SEARCH.

Menu not displayed correctly.

Restore the zoom ratio to k 1.00. (19)

Set the "Subtitle Position" to 0. (19)

Auto zoom function does not work well.

Turn off TV's zoom function.

Use the other preset aspect ratios or manual adjustment.

Zoom function may not work well, especially in dark scenes and may not work depending on the type of disc.

No picture on the LCD.

Select a monitor mode other than "OFF" (no picture). (12, **Selecting how to show 4:3 aspect pictures on the LCD**)

Picture doesn't appear on the television (or the size of the picture seems wrong).

Check connections. (23)

Check that the television is on.

Check that the input mode on the television is correct.

Check the settings in "Video—TV Aspect". (21)

Turn off the zooming feature on your television if you are using Zoom. (19)

Ensure that the unit is connected directly to the television, and is not connected through a video cassette recorder. (23)

LCD pixels turn black or radiate different colors.

The LCD is constructed with precision technology so 99.99 % of the pixels are active, but of the remaining of 0.01 %, there are pixels that may be black or emit light constantly. This phenomenon is not a malfunction.

Displays

"⊘"

The operation is prohibited by the unit or disc.

No On-Screen display.

Select "On" for "On-Screen Messages" in Display menu. (22)

"Check the disc."

Clean the disc. (33)

You inserted a DVD-R that has not been finalized.

" ERROR 01"

A problem has occurred with the battery pack. Consult your dealer.

" ERROR 02"

The battery pack has been recharging for 12 hours but has failed to recharge for some reason. Recharge again.

" ERROR 03"

You are recharging in a location that is too hot or too cold. Recharge at normal temperature [i 5 to i 35 ℃ (i 41 to i 95 ℉)].

"H" stands for a number.

Trouble has occurred. The number appearing after "H" depends on the problem. Turn the unit off and on again. Alternatively, turn the unit off, disconnect the power source (AC or battery pack) reconnect the power and turn the unit on again.

If the service numbers fail to clear, note the service number and consult your dealer.

"No Select"

Press [, -OFF], then retry the operation again.

[] and [CHG] indicators

The [] indicator flashes rapidly.

The [] indicator flashes slowly.

The [CHG] indicator flashes rapidly.

The [CHG] indicator flashes slowly.

The unit has malfunctioned. Consult your dealer.

The unit is on and the LCD is closed or the monitor mode is set to "OFF" (no picture). Turn the unit off when you have finished.

There is a problem with the battery pack. Turn the unit on and check the message on the LCD. (32)

Battery pack charge is low. The unit will turn off automatically after a few minutes.

Maintenance

To clean this unit, wipe with a soft, dry cloth.

Use eyeglass cleaner to remove stubborn dirt from the LCD.

Never use alcohol, paint thinner or benzine to clean this unit.

Maintenance of the lens

Remove dust carefully with an air blower for camera lenses (optional).

Recommended product:

Lens cleaner kit (SZZP1038C)

(Available from Panasonic dealers.)

Be careful not to touch the lens with your fingers.

To clean discs

DVD-A, DVD-V, VCD, CD

Wipe with a damp cloth and then wipe dry.

RAM, DVD-R

Clean with an optional DVD-RAM/PD disc cleaner (LF-K200DCA1, where available).

Never use cloths or cleaners for CDs etc.

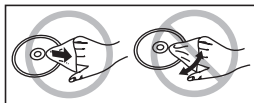

Disc handling precautions

Do not attach labels or stickers to discs (This may cause disc warping, rendering it unusable).

Do not write on the label side with a ball-point pen or other writing instrument.

Do not use record cleaning sprays, benzine, thinner, static electricity prevention liquids or any other solvent.

Do not use scratch-proof protectors or covers.

Do not use the following discs:

– Discs with exposed adhesive from removed stickers or labels (rented discs etc).

– Discs that are badly warped or cracked.

–Irregularly shaped discs, such as heart shapes.

Limited Warranty (ONLY FOR U.S.A.)

Panasonic Consumer Electronics Company,
Division of Matsushita Electric Corporation
of America

One Panasonic Way Secaucus, New Jersey 07094

Panasonic Sales Company, Division of
Matsushita Electric of Puerto Rico, Inc.,
Ave. 65 de Infantería, Km. 9.5

San Gabriel Industrial Park, Carolina, Puerto Rico 00985

Panasonic DVD Player Limited Warranty

Limited Warranty Coverage

If your product does not work properly because of a defect in materials or workmanship, Panasonic Consumer Electronics Company or Panasonic Sales Company (collectively referred to as "the warrantor") will, for the length of the period indicated on the chart below, which starts with the date of original purchase ("Limited Warranty period"), at its option either (a) repair your product with new or refurbished parts, or (b) replace it with a new or a refurbished product. The decision to repair or replace will be made by the warrantor.

Product or Part Name	Parts	Labor
DVD Player	One (1) Year	Ninety (90) Days
Rechargeable Batteries (in exchange for defective item)	Ten (10) Days	Not Applicable

During the "Labor" Limited Warranty period there will be no charge for labor. During the "Parts" warranty period, there will be no charge for parts. You must mail-in your product during the warranty period. If non-rechargeable batteries are included, they are not warranted. This Limited Warranty only applies to products purchased and serviced in the United States or Puerto Rico. This Limited Warranty is extended only to the original purchaser and only covers product purchased as new. A purchase receipt or other proof of original purchase date is required for Limited Warranty service.

Mail-In Service

For assistance in the continental U.S.A. in obtaining repairs please ship the product to:

**Panasonic Services Company
Customer Servicerter
Suite B
4900 George McVay Drive
McAllen, TX 78503**

For assistance in Puerto Rico call Panasonic Sales Company (787)-750-4300 or fax (787)-768-2910.

When shipping the unit carefully pack and send it prepaid, adequately insured and preferably in the original carton. Include a letter detailing the complaint and provide a day time phone and/or email address where you can be reached.

IF REPAIR IS NEEDED DURING THE LIMITED WARRANTY PERIOD THE PURCHASER WILL BE REQUIRED TO FURNISH A SALES RECEIPT/PROOF OF PURCHASE INDICATING DATE OF PURCHASE, AMOUNT PAID AND PLACE OF PURCHASE. CUSTOMER WILL BE CHARGED FOR THE REPAIR OF ANY UNIT RECEIVED WITHOUT SUCH PROOF OF PURCHASE.

Limited Warranty Limits And Exclusions

This Limited Warranty ONLY COVERS failures due to defects in materials or workmanship, and DOES NOT COVER normal wear and tear or cosmetic damage. The Limited Warranty ALSO DOES NOT COVER damages which occurred in shipment, or failures which are caused by products not supplied by the warrantor, or failures which result from accidents, misuse, abuse, neglect, mishandling, misapplication, alteration, faulty installation, set-up adjustments, misadjustment of consumer controls, improper maintenance, power line surge, lightning damage, modification, or commercial use (such as hotel, office, restaurant, or other business), rental use of the product, or service by anyone other than a Factory Servicenter or other Authorized Servicer, or damage that is attributable to acts of God.

THERE ARE NO EXPRESS WARRANTIES EXCEPT AS LISTED UNDER "LIMITED WARRANTY COVERAGE". THE WARRANTOR IS NOT LIABLE FOR INCIDENTAL OR CONSEQUENTIAL DAMAGES RESULTING FROM THE USE OF THIS PRODUCT, OR ARISING OUT OF ANY BREACH OF THIS WARRANTY. (As examples, this excludes damages for lost time, cost of having someone remove or re-install an installed unit if applicable, travel to and from the servicer, loss of or damage to media or images, data or other recorded content. The items listed are not exclusive, but are for illustration only.)
ALL EXPRESS AND IMPLIED WARRANTIES, INCLUDING THE WARRANTY OF MERCHANTABILITY, ARE LIMITED TO THE PERIOD OF THE LIMITED WARRANTY.

Some states do not allow the exclusion or limitation of incidental or consequential damages, or limitations on how long an implied Limited Warranty lasts, so the exclusions may not apply to you.

This Limited Warranty gives you specific legal rights and you may also have other rights which vary from state to state. If a problem with this product develops during or after the Limited Warranty period, you may contact your dealer or Servicenter. If the problem is not handled to your satisfaction, then write to the warrantor's Consumer Affairs Department at the addresses listed for the warrantor.

PARTS AND SERVICE, WHICH ARE NOT COVERED BY THIS LIMITED WARRANTY, ARE YOUR RESPONSIBILITY.

Customer Services Directory

Obtain Product Information and Operating Assistance; locate your nearest Dealer or Servicenter; purchase Parts and Accessories; or make Customer Service and Literature requests by visiting our Web Site at:

<http://www.panasonic.com/support>

or, contact us via the web at:

<http://www.panasonic.com/contactinfo>

You may also contact us directly at:

1-800-211-PANA (7262),

Monday-Friday 9 am-9 pm; Saturday-Sunday 10 am-7 pm, EST.

For hearing or speech impaired TTY users, TTY: 1-877-833-8855

Accessory Purchases

Purchase Parts, Accessories and Instruction Books online for all Panasonic Products by visiting our Web Site at:

<http://www.pasc.panasonic.com>

or, send your request by E-mail to:

npcparts@panasonic.com

You may also contact us directly at:

1-800-332-5368 (Phone) 1-800-237-9080 (Fax Only) (Monday – Friday 9 am to 8 pm, EST.)

Panasonic Services Company

20421 84th Avenue South, Kent, WA 98032

(We Accept Visa, MasterCard, Discover Card, American Express, and Personal Checks)

For hearing or speech impaired TTY users, TTY : 1-866-605-1277

Service in Puerto Rico

Matsushita Electric of Puerto Rico, Inc. Panasonic Sales Company

Factory Servicenter:

Ave. 65 de Infantería, Km. 9.5, San Gabriel Industrial Park, Carolina, Puerto Rico 00985

Phone (787)750-4300, Fax (787)768-2910

F1003

Product Service

- 1. Damage requiring service**—The unit should be serviced by qualified service personnel if:
 - (a) The AC power supply cord or AC adaptor has been damaged; or
 - (b) Objects or liquids have gotten into the unit; or
 - (c) The unit has been exposed to rain; or
 - (d) The unit does not operate normally or exhibits a marked change in performance; or
 - (e) The unit has been dropped or the cabinet damaged.
- 2. Servicing**—Do not attempt to service the unit beyond that described in these operating instructions. Refer all other servicing to authorized servicing personnel.
- 3. Replacement parts**—When parts need replacing ensure the servicer uses parts specified by the manufacturer or parts that have the same characteristics as the original parts. Unauthorized substitutes may result in fire, electric shock, or other hazards.
- 4. Safety check**—After repairs or service, ask the servicer to perform safety checks to confirm that the unit is in proper working condition.

Product information

For product information or assistance with product operation:

In the U.S.A., refer to “Customer Services Directory” above.

In Canada, contact the Panasonic Canada Inc. Customer Care Centre at 1-800-561-5505, or visit the website (www.panasonic.ca), or an authorized Servicentre closest to you.

Main feature index

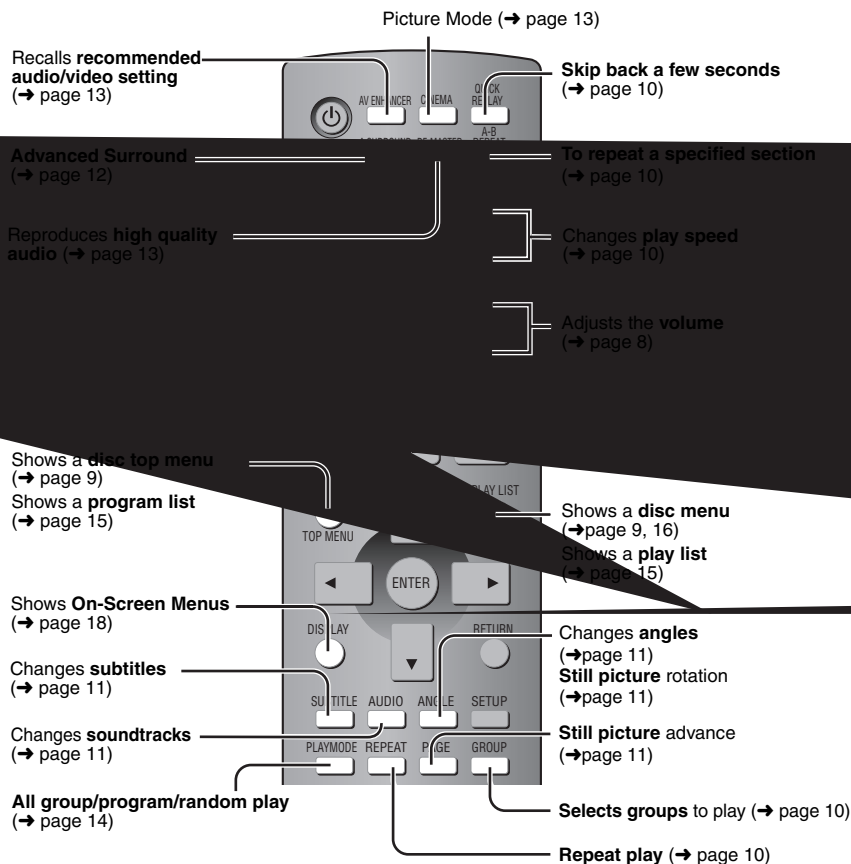

Panasonic Consumer Electronics Company,
Division of Matsushita Electric Corporation of America
One Panasonic Way Secaucus, New Jersey 07094
<http://www.panasonic.com>

Panasonic Sales Company,
Division of Matsushita Electric of Puerto Rico, Inc. ("PSC")
Ave. 65 de Infantería, Km. 9.5
San Gabriel Industrial Park, Carolina, Puerto Rico 00985

Panasonic Canada Inc.
5770 Ambler Drive, Mississauga, Ontario L4W 2T3
www.panasonic.ca

© 2004 Matsushita Electric Industrial Co., Ltd.
Printed in Japan

En

RQT7682-2P
F0304AT2054

Free Manuals Download Website

<http://myh66.com>

<http://usermanuals.us>

<http://www.somanuals.com>

<http://www.4manuals.cc>

<http://www.manual-lib.com>

<http://www.404manual.com>

<http://www.luxmanual.com>

<http://aubethermostatmanual.com>

Golf course search by state

<http://golfingnear.com>

Email search by domain

<http://emailbydomain.com>

Auto manuals search

<http://auto.somanuals.com>

TV manuals search

<http://tv.somanuals.com>