

Panasonic

Quad Speed

PORTABLE CD-ROM Player

Model No. **KXL-D742**

Operating Instructions



Please read before using and store in a safe place.

Download from www.Somanuals.com. All Manuals Search And Download.

End-User License Agreement for CD-ROM ToolKit™

THIS IS A LEGAL AGREEMENT BETWEEN YOU AND PANASONIC. CAREFULLY READ ALL THE TERMS AND CONDITIONS OF THIS AGREEMENT PRIOR TO OPENING THE PACKET OF SOFTWARE PROGRAM. OPENING THE PACKET INDICATES YOUR ACCEPTANCE OF THESE TERMS AND CONDITIONS. If you do not agree to these terms and conditions, return the unopened packet and the other components of the Panasonic CD-ROM Player to the place of purchase and your money will be refunded. No refunds will be given for the product that have an opened packet or missing components.

1. COPYRIGHT:

Panasonic has the right to license or has been granted to license the enclosed FWB CD-ROM ToolKit software program ("SOFTWARE"), developed and copyrighted by FWB Software Inc. , 1555 Adams Drive, Menlo Park, CA94025, U.S.A. ("FWB").

You acknowledge that you are receiving only a LIMITED LICENSE TO USE the SOFTWARE and related documentation, and that you shall obtain no title, ownership nor any other rights in or to the SOFTWARE and related documentation, all of which title and rights shall remain with FWB and Panasonic.

2. LICENSE:

(1) You have the non-exclusive right to use the one copy of the SOFTWARE on a single computer used by single user. Installation of the SOFTWARE on a network server for the purpose of distribution to one or more other computers shall not be granted in this Agreement. (2) You may not copy, reproduce, or permit to be copied or reproduced, the SOFTWARE or related documentation for any purpose, except that you may either (a) make a reasonable quantity of copies of the SOFTWARE solely for backup or archival purposes, or (b) transfer the SOFTWARE to a single hard disk, provided that you keep the original solely for backup or archival purposes. All other copies of the SOFTWARE are in violation of this Agreement.

(3) You may not rent or lease the SOFTWARE, but you may transfer your right under this License Agreement on a permanent basis, provided that you transfer this Agreement, all copies of the SOFTWARE, all related documentation and your Panasonic CD-ROM Player, and the recipient thereof agrees the terms of this Agreement. (4) You may not reverse engineer, decompile or disassemble the SOFTWARE, except that in European Union and European Free Trade Association, you may have the limited right to reverse engineer, decompile or disassemble the SOFTWARE solely to the extent specifically permitted by the terms and conditions of Article 6 of the European Community's Directive for the Legal Protection of Computer Programs, OJL 122/42 (17 May 1991). (5) You may not use, copy, modify, alter, or transfer the SOFTWARE, or any copy thereof, in whole or in part, except as expressly provided in this Agreement.

3. TERM:

This license is effective until terminated. You may terminate this Agreement at any time by destroying the SOFTWARE and related documentation and all copies thereof. This license will also terminate if you fail to comply with any term or condition of this Agreement. Upon such termination, you agree to destroy all copies of the SOFTWARE and related documentation.

4. LIMITATION OF LIABILITY:

EXCEPT AS STATED ABOVE, NEITHER PANASONIC, PANASONIC'S SUPPLIER NOR FWB MAKES OR PASSES ON TO YOU OR OTHER THIRD PARTY, ANY WARRANTY OR REPRESENTATION INCLUDING, BUT NOT LIMITED TO, THE IMPLIED WARRANTY OF MERCHANTABILITY AND FITNESS FOR A PARTICULAR PURPOSE.

NEITHER PANASONIC, PANASONIC'S SUPPLIER NOR FWB SHALL BE LIABLE FOR ANY DAMAGE SUFFERED BY YOU INCLUDING, BUT NOT LIMITED TO, CONSEQUENTIAL, INCIDENTAL SPECIAL OR PUNITIVE DAMAGES. THE ABOVE LIMITATIONS SHALL APPLY REGARDLESS OF THE FORM OF ACTION WHETHER IN CONTRACT, TORT (INCLUDING NEGLIGENCE), STRICT PRODUCT LIABILITY OR OTHERWISE, EVEN IF SUCH PARTY HAS BEEN ADVISED OF THE POSSIBILITY OF SUCH DAMAGES.

5. U.S. Government Restricted Rights

The SOFTWARE and documentation are provided with RESTRICTED RIGHTS. Use, duplication or disclosure by the Government is subject to restrictions as set forth in subparagraph (c)(1)(A) of the Rights in Technical Data and Computer Software clause at DFARS 252.227-7013 or subparagraph (c)(1) and (c)(2) of the Commercial Computer Software -- Restricted Rights at 48 CFR 52.227-19, as applicable. Manufacture is FWB Software Inc. / 1555 Adams Drive / Menlo Park, CA 94025, U.S.A. Subcontractor is Panasonic.

6. U.S. Export Control

You agree and certify that neither the SOFTWARE will be transferred or reexported, directly or indirectly, into any country where such transfer or reexport is prohibited by the U.S. Export Administration Act and Regulations thereunder, without the proper authorization of U.S. Government, if required.

7. Control Law

This Agreement is governed by the law of Japan.

Copyright Notice

This manual, the software described in it, the product design, and design concepts are copyrighted by FWB Software, Inc. (FWB) with all rights reserved. Your rights with regard to the software and manual are subject to the restrictions and limitations imposed by the copyright laws of the United States of America. Under the copyright laws, neither the programs nor the manual may be copied, reproduced, translated, transmitted or reduced to any printed or electronic medium or to any machine-readable form, in whole or in part, without the written consent of FWB.

© 1995 FWB Software, Inc.
1555 Adams Drive
Menlo Park, CA94025
U.S.A.

WARNING

- The power source voltage of this AC adaptor is listed on the nameplate. Plug the AC adaptor only into an outlet with the proper voltage.
- To prevent fire or shock hazard, do not expose this product to rain or any type of moisture.

CAUTION

- When you operate this equipment, the outlet should be near the equipment and should be easily accessible.
- To prevent the SCSI interface connector from static electricity damage, before you touch it, discharge any static electricity from your hands by touching a grounded metal surface, such as the screw on the plate cover of an electrical outlet.

The serial number of this unit may be found on the label located at the bottom of the unit. Write this number below and keep this book along with your proof of purchase to serve as a permanent record of your purchase or for future reference.

MODEL NO. KXL-D742 NAME OF DEALER _____

SERIAL NO. _____ DATE OF PURCHASE _____

FWB, CD-ROM ToolKit™, CDT Remote™ and the FWB logo are trademarks of FWB Software, Inc.
Apple, PowerBook, Macintosh, QuickTime, AppleLink, Finder and Apple logo are trademarks of Apple Computer, Inc.
Photo CD is a trademark of Eastman Kodak Company.

All other brand and product names are trademarks or registered trademarks of their respective companies.

Any details given in these Operating Instructions are subject to change without notice.

All Rights Reserved, © COPYRIGHT 1995 KYUSHU MATSUSHITA ELECTRIC CO., LTD.

CAUTION FOR LASER

This product utilizes a laser.

Use of control, adjustment or performance of procedures other than those specified herein may result in hazardous radiation exposure.

Do not open covers and do not repair yourself. Refer servicing to qualified personnel.

Laser diode properties

Material	GaAlAs
Laser output	Less than 52.65 μ W
Wave length	790 nm
Emission duration	Continuous

(This output is the value measured at the distance of 200 mm from the objective lens surface.)

FOR USERS IN UNITED STATES ONLY

This equipment has been tested and found to comply with the limits for a Class B digital device, pursuant to Part 15 of FCC Rules. These limits are designed to provide reasonable protection against harmful interference in a residential installation.

This equipment generates, uses and can radiate radio frequency energy and, if not installed and used in accordance with the instructions, may cause harmful interference to radio communications.

However, there is no guarantee that interference will not occur in a particular installation. If this equipment does cause harmful interference to radio or television reception, which can be determined by turning the equipment off and on, the user is encouraged to try to correct the interference by one or more of the following measures:

- Reorient or relocate the receiving antenna.
- Increase the separation between the equipment and receiver.
- Connect the equipment into an outlet on a circuit different from that to which the receiver is connected.
- Consult the dealer or an experienced radio/TV technician for help.

The user may find the booklet "Something About Interference" available from FCC local regional offices helpful.

FCC Warning: To assure continued FCC emission limit compliance, the user must use only the recommended shield interfacing cable when connecting to a host computer. Also, any unauthorized changes or modifications to this equipment would void the users authority to operate this device.

■ Features:

- **Quad Speed external drive (Max. 600 KB/s).**
- **Operates on AC Adaptor, six (6) "AA" size Batteries (not supplied) or Rechargeable Battery (Option).** (☞ P. 12~15)
- **Can be connected to a PowerBook with the supplied SCSI cable.** (☞ P. 16)
- **Can be connected to a desktop Macintosh with purchase of SCSI cable (D-sub25 pin ↔ half-pitch 50 pin) for Macintosh.** (☞ P. 17)
- **Both CD-ROM and audio CD can be played when attached to your computer.** (☞ P. 24~27)
- **Can be used independently as an audio CD player.** (☞ P. 28)
- **High performance SCSI CD-ROM device driver, an integral caching utility for CD-ROM drives and an application for playing audio CDs are included in setup software.**
- **Supports CD-DA, CD-ROM XA, CD-ROM, Photo CD Multi-session.**

Use the player with
computer (☞ P. 24)

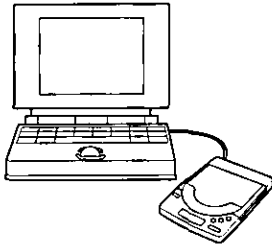

Use the player
independently (☞ P. 28)



Headphones are not
supplied.

Important:

■ Please use CD-ROMs
with the marking below.

COMPACT
disc

■ Please use audio CDs
with the marking below.

COMPACT
disc
DIGITAL AUDIO

Precautions

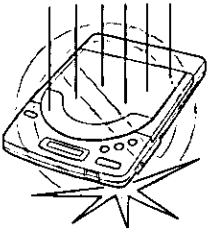

- Do not drop or jar the player.

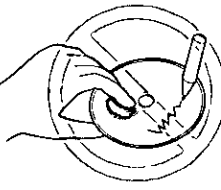

- Do not scratch or smudge the surface of CD.

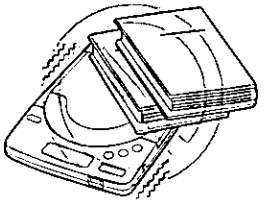

- Do not place heavy objects on the player.
- Do not shake or subject to intense vibration.

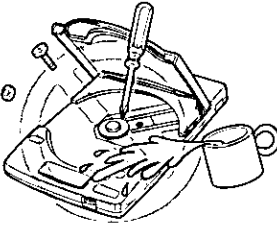

- Do not disassemble the player.
- Do not spill liquid.

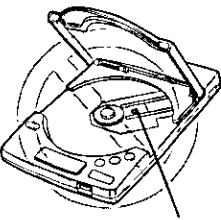

lens

- Do not touch the lens.

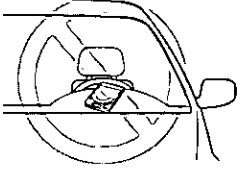

- Do not expose the player to direct sunlight or heat. Especially do not leave it in a hot automobile.

- Keep disc cover closed to protect from dust.
- Do not play CD-ROM/audio CD while transporting.
- Do not use near any appliance that may cause vibration.

Accessories

Make sure that the following accessories are included with the player.

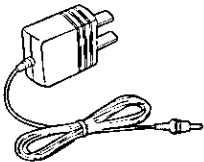

AC adaptor (KX-WZ315)
(P. 12)

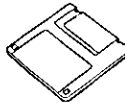

Setup disk
(P. 19)

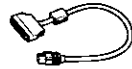

SCSI cable
(for PowerBook)
(P. 16)

- Operating instructions
- Warranty card

Table of Contents

End-User License Agreement	3
Precautions	8
Accessories	8

Part Names and Functions	10
Power Supply	12
Using supplied AC adaptor	12
Using rechargeable battery (option)	12
Using alkaline batteries (not supplied)	15

Before using



Connecting Player to Computer	16
To a PowerBook	16
To a Desktop Macintosh	17
Power On	18
Software Installation	19
Before installing software	19
Installation	19

Setup



Inserting/Removing a CD	23
Using the Player with Computer	24
Playing a CD-ROM	24
Playing an audio CD	24
Using the Player Independently	28
Playing an audio CD	28

Operation



Details of CD-ROM ToolKit	29
Troubleshooting	30
SCSI ID Number and Terminator	35
Maintenance	36
Specifications	37
Index	38
Option	39
Technical Support and Service Parts Calls	40

General Information



Part Names and Functions

Top view

Disc cover (P. 23)

Lock switch (P. 23)

Locks the disc cover by sliding the Lock switch toward the rear of the player.

OPEN button (P. 23)

Opens the disc cover.

Display (P. 11)

VOLUME control

(P. 28)

Adjusts the volume of headphones (0~10).

▶|| /CHG (PLAY/PAUSE/CHARGE button)

Starts/pauses playing audio CD (P. 28) or charges the optional rechargeable battery by pressing this button (P. 13).

POWER switch (P. 18)

Turns the power on/off.

■ (STOP button) (P. 28)

Stops playing audio CD.

▶▶ (Forward skip button)

(P. 28)

Skips to the next track(s).

PHONES jack (P. 28)

Connects your headphones (not supplied).

◀◀ (Reverse skip button)

(P. 28)

Skips to the previous track(s) or returns to the beginning of the track being played.

Rear/Bottom view

Battery cover

(P. 12, 15)

DC IN jack

(P. 12)

DIP switch (P. 35)







Sets the SCSI ID number.

Sets the terminator ON or OFF.

SCSI interface connector

(P. 16)

Display messages

Message/Indication	Description
-AUDIO DISC ONLY-	With a CD-ROM inserted in the player, if you press  ,  ,  or  /CHG  , a blinking message "AUDIO DISC ONLY" appears.
BUSY	When data is being transferred, a blinking message "BUSY" appears.
no disc	CD is not inserted, or the inserted CD is not recognized because either the CD is placed with the label side facing down, or it is damaged, dirty, wet, etc.
on	When CD-ROM is inserted, a message "on" is displayed. While CD-ROM or audio CD is recognizing, a blinking message "on" appears.
01 00:00	Audio CD is recognized.
OPEN	The disc cover is open.
	When the battery is low, this blinking indication appears.
CHG 	This blinking indication appears while the rechargeable battery (option) is being charged.



Power Supply

The supplied AC adaptor, rechargeable battery (option) or alkaline batteries (not supplied) can be used for power source of the player.

Using supplied AC adaptor

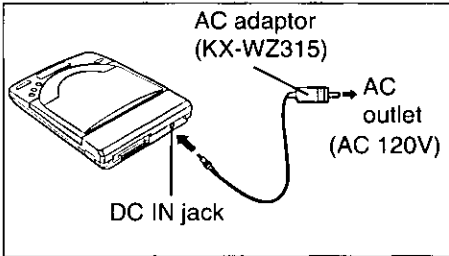

Connect one end of the AC adaptor to DC IN jack and the other end to household AC outlet.

Caution:

- Use only the supplied AC adaptor (KX-WZ315), since other adaptors may damage the player.

Using rechargeable battery (option)

Optional rechargeable battery (KXL-D30) needs to be purchased. Before initial use, please charge the rechargeable battery (P. 13).

Note:

- When using the rechargeable battery, the data transfer rate may decrease and the access time may increase.

Installing rechargeable battery

Make sure the player is off.

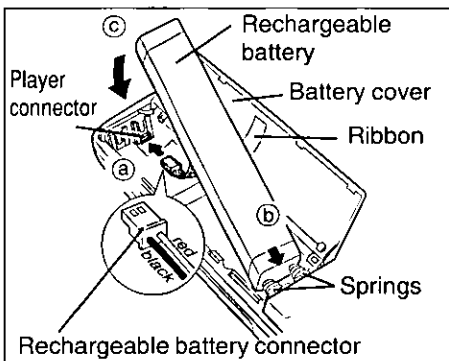

- ① Open the battery cover by sliding and lifting it up (P. 15).
- ② Insert the rechargeable battery connector into the player connector (a).
- ③ Install the rechargeable battery (c) placing the ribbon underneath it and pressing the springs (b).
- ④ Close the battery cover by pressing it down and sliding it back.

Note:

- If the player is not going to be used for more than two (2) months, remove the rechargeable battery to maintain the battery life.

Charging rechargeable battery

Charge the rechargeable battery:

- Before initial use.
- When the blinking mark “” appears on the player's display.

Caution:

- Do not charge the rechargeable battery using a charger other than this player.



1 Install the rechargeable battery ( P. 12 “Installing rechargeable battery”).

2 Connect the supplied AC adaptor ( P. 12).

3 Turn on the player by pressing the POWER switch ( P. 18).

4 Press  on the player until the mark “CHG ” appears.

Charging starts and it will complete automatically when the mark “CHG ” disappears and the power goes off. A full battery charge requires a maximum of three (3) hours.

- To stop charging, turn off the power.

Notes:

- While charging no operation can be performed.
- If you charge the rechargeable battery under extremely low or high temperature, the charging capacity may reduce. Please charge the rechargeable battery within an appropriate temperature range of 5°C to 35°C.
- If the blinking mark “” appears while using the rechargeable battery with the computer attached, connect the AC adaptor. Otherwise the computer/CD-ROM player may not function properly.





■ Supplemental charging function:

Charging will start automatically when the rechargeable battery is installed, and the AC adaptor is connected and the power is on. In this charging mode, no mark appears on the player's display.

In this case, a full charge may not be achieved. To charge the rechargeable battery fully, follow steps 1 to 4 above.

Refreshing rechargeable battery

If the rechargeable battery seems to run down sooner than usual (maybe because of repetitive short-term charging and discharging), refresh the rechargeable battery two or three times by following the instructions below.

1. Disconnect the AC adaptor.
2. Play an audio CD repeatedly until the blinking mark "  " appears and the power goes off automatically.
 - When the audio CD finishes playing, power will go off automatically. Turn the power on and play an audio CD again.
3. Connect the AC adaptor, turn on the player and press  on the player until the mark "CHG  " disappears.
4. Charge the rechargeable battery until the mark "CHG  " appears and the power goes off.

Replacing rechargeable battery (option)

Replace the rechargeable battery:

- If the rechargeable battery quickly runs down even after refreshing, it has reached the end of its life.

Note:

- The rechargeable battery will charge approximately 300 times under optimum conditions.

■ Removing the rechargeable battery:

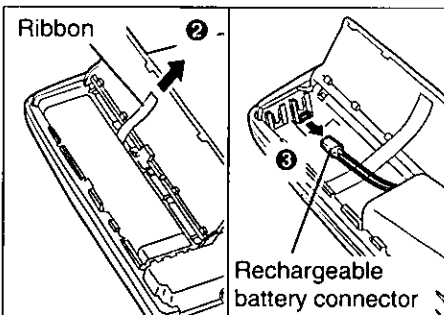

- ① Open the battery cover.
- ② Pull the ribbon upward.
- ③ Disconnect the rechargeable battery connector by pulling its cable carefully, then remove the rechargeable battery.
- ④ Close the battery cover.

Using alkaline batteries (not supplied)

Six (6) "AA" size alkaline batteries are required.

Alkaline battery Precautions:

If improperly used, the batteries may leak and cause corrosion. Therefore, observe the following:

- Install batteries according to the diagram.
- Do not mix old and new batteries, or carbon and alkaline battery types.
- Remove all batteries when not using the player for extended periods.
- **Do not charge, short-circuit, disassemble, heat, or dispose of in fire.**

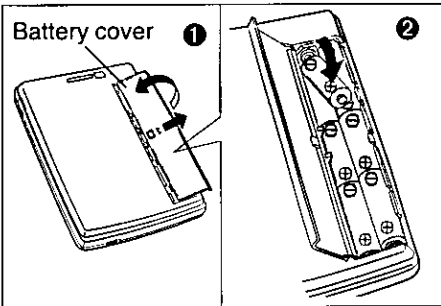

- 1 Open the battery cover by sliding and lifting it up.
- 2 Install six "AA" size batteries (not supplied).
Make sure the polarities (+, -) match the diagram.
- 3 Close the battery cover.

■ Replacing the Batteries:

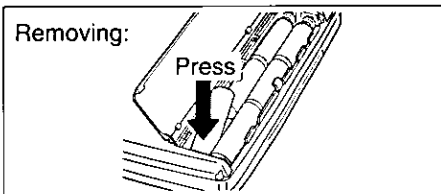

Replace the batteries when blinking mark "  " appears on the display.

Notes:

- When using the alkaline battery, the data transfer rate may decrease and the access time may increase.
- If the blinking mark "  " appears while using the alkaline battery with the computer attached, connect the AC adaptor. Otherwise the computer/CD-ROM player may not function properly.
- If batteries are installed with the ribbon placed underneath, it is easier to remove the batteries by pulling the ribbon upward.



Connecting Player to Computer

To a PowerBook

You can connect the player to a PowerBook by using the supplied SCSI cable.

Note:

- If you want to connect the player to the Duo series, an extension unit (MiniDock) will be required.

Make sure both the PowerBook and the player are off.

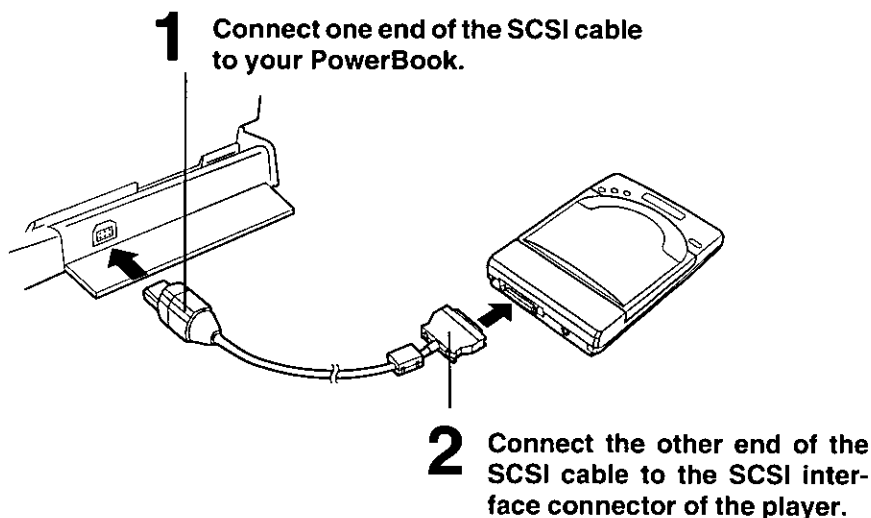

Note:

- Make sure that the terminator is set to ON (P. 35).

■ *Disconnecting SCSI cable from PowerBook:*

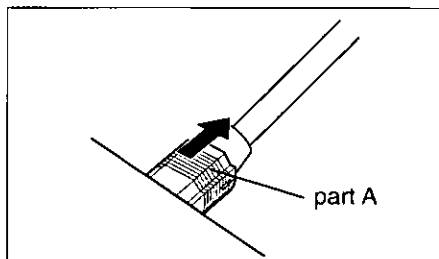

Hold the part A of the SCSI cable and pull it outward.

To a Desktop Macintosh

For connection, a SCSI cable for Macintosh is required.

Note:

- Use a shielded SCSI cable of 1 m (3.2 ft.) or shorter.

Make sure both the Desktop Macintosh and the player are off.

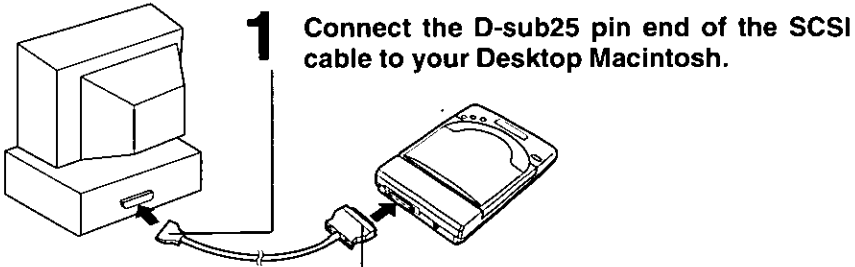

Note:

- Make sure that the terminator is set to ON (P. 35).

■ Daisy chain connection:

You can connect this player to computer devices (up to seven devices). Make sure that each SCSI device has different SCSI ID number.

For setting the SCSI ID number and terminator of this player, refer to "SCSI ID Number and Terminator" (P. 35).

<Example>

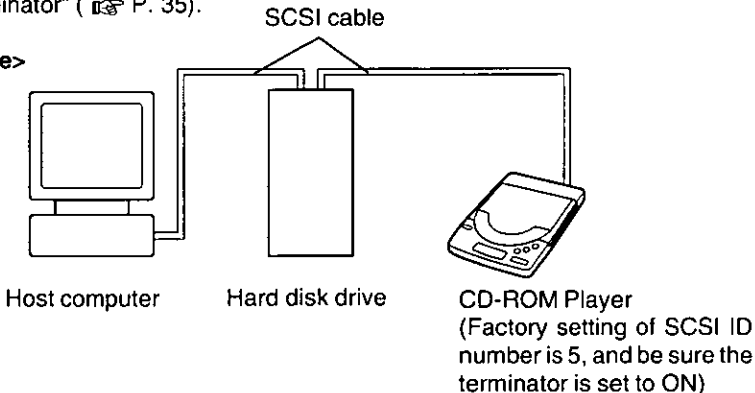

Power On

Turn on the player by pressing the **POWER** switch, and then turn on the computer.

A blinking message "on" appears on the display of the player.

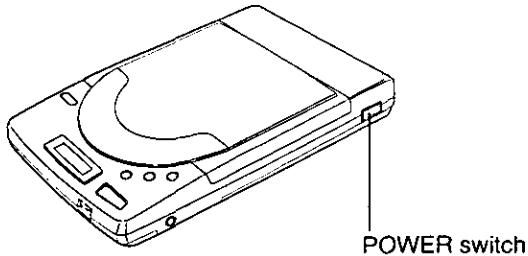

- To turn off the player, press the **POWER** switch again. The display message(s) will disappear.

Notes:

- If the computer is turned on before the player, the player may not be recognized and cause a malfunction.
- If the player is not going to be used for an extended period, unplug the AC adaptor from both the player and AC outlet to save power consumption. (Approximately 1.0 W power is consumed when the player is OFF and the AC adaptor is connected.)
- Do not turn off the player before the computer. This may cause malfunction of the computer. If this happens, turn on the player or reset the computer.

■ **Power Save Function** *(except when charging the optional rechargeable battery):*

The player enters the Sleep Mode under the following conditions to save power.



- When using with computer, and no command is sent to the player from the computer for more than 4 minutes.
- When using the player independently, CD is not being played, and no button of the player is pressed for more than 4 minutes.

During the Sleep Mode, the laser and spindle motor stop.

The player automatically re-starts when it receives a command from the computer or a button on the player is pressed.

Software Installation

Before installing software

Make sure that you have connected the player to your computer ( P. 16, 17), and both the player and your computer are turned on ( P. 18).

System requirement

The Setup disk can be used only in Macintosh with a 3.5" floppy disk drive. Hardware and Software requirements are:

- Macintosh Plus or later
- System 6.0.4 or later (System 7 or later is recommended)
- 4 MB of RAM or greater (More is helpful)
- Disk caching requires 1.5 MB of free contiguous hard disk space (More is helpful)

Making back-up copy

Before installing software, it is recommended that you make a back-up copy and store the original in a safe place. To make a back-up copy, refer to your Macintosh manual.

Disabling old CD-ROM device driver

Before installing this software, you must disable any previously installed driver software on your computer to load and activate this software smoothly.
To disable Apple's or any third-party device driver, simply drag the file from the System folder and restart your computer.

Installation

Notes:

- Before proceeding with the installation, restart your computer with all Extensions off, making sure to disable any virus protection software.
- The installation will place Foreign File Access, Audio CD Access, High Sierra File Access, and ISO 9660 File Access into the Extensions Folder inside your System Folder. If these files have already been placed into the Folder, they will be re-written.



Software Installation

1 Insert the supplied Setup disk into the floppy drive.

The CD-ROM ToolKit window will automatically appear.

“Read Me for Panasonic” File describes the information which is not mentioned in this manual. Please read it when it is necessary.

2 Double click the “CD-ROM ToolKit Installer” icon.

The CD-ROM ToolKit Installer dialog will appear.

3 Click **Continue**. The following screen will appear.

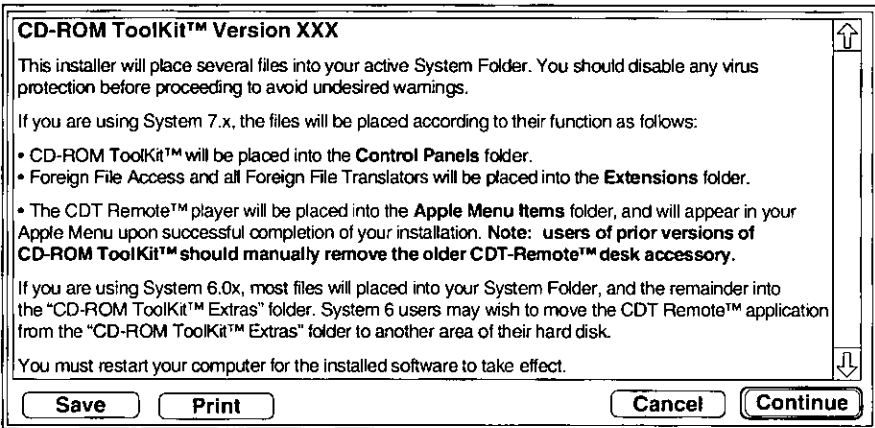

- Version number may change without notice.

If you want to save the screen as a text file, click **Save**.

If you want to print out the screen, click **Print**.

If you want to return to the CD-ROM ToolKit window, click **Cancel**.

4 Click **Continue**. The following screen will appear.

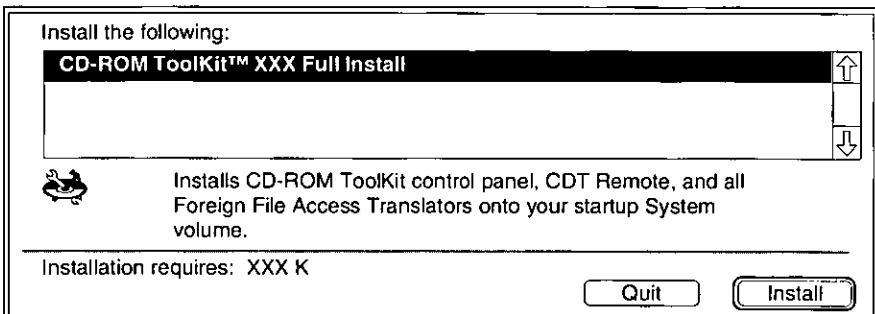

5 Click **Install**.

When the installation has completed, the following message will appear.

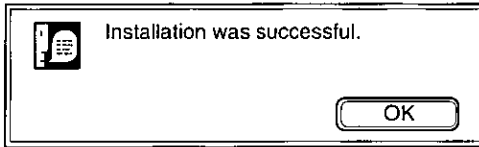

6 Click **OK**.

7 Restart your computer.

The original Setup disk will be ejected automatically.

Note:

- Store the original Setup disk in a safe place.

8 Personalize CD-ROM ToolKit if you are running it for the first time.

- 1 Open the Control Panels Folder from Apple () Menu.
- 2 Double click "CD-ROM ToolKit" icon.
(If you are using System 6.0.x click "CD-ROM Tool..." icon.)
The following screen will appear.

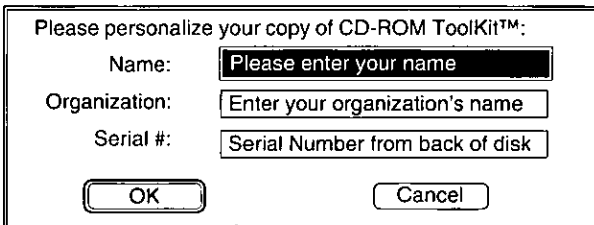
A rectangular dialog box with a thin border. The title bar text reads "Please personalize your copy of CD-ROM ToolKit™:". Below the title bar, there are three labels with corresponding input fields: "Name:" followed by a text box containing "Please enter your name"; "Organization:" followed by a text box containing "Enter your organization's name"; and "Serial #:" followed by a text box containing "Serial Number from back of disk". At the bottom of the dialog box, there are two rounded rectangular buttons: "OK" on the left and "Cancel" on the right.

- 3 Enter the information in the provided spaces.

Note:

- Name and Serial # "M53006585" must be entered.



Software Installation

4 Click .

The CD-ROM ToolKit Control Panel will appear.

Confirm that the check box next to SCSI ID No. of this player is on. The factory setting of SCSI ID No. of this player is set to 5.

ID (SCSI Address)	ON (Load at Startup)	Fast (Enable Acceleration)	vXXX
0	<input type="checkbox"/>	<input type="checkbox"/>	
1	<input type="checkbox"/>	<input type="checkbox"/>	
2	<input type="checkbox"/>	<input type="checkbox"/>	
3	<input type="checkbox"/>	<input type="checkbox"/>	
4	<input type="checkbox"/>	<input type="checkbox"/>	
5	<input checked="" type="checkbox"/>	<input checked="" type="checkbox"/>	CD-ROM: MATSHITA
6	<input type="checkbox"/>	<input type="checkbox"/>	

Automatically Build CD-ROM Cache Files:

CD-ROM File Cache (KB)

CD-ROM RAM Cache (KB)

: OFF
 : ON

For detailed information about CD-ROM ToolKit Control Panel, refer to "Details of CD-ROM ToolKit" (P. 29).

9 Click the close box.

The following message will appear.

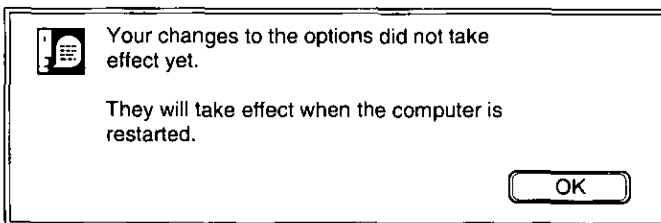

10 Click .

Inserting / Removing a CD

Inserting a CD

To insert a CD, follow the instructions below.

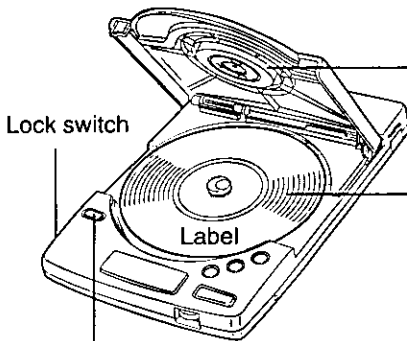

1 Press **OPEN** to open the disc cover and then raise it.

3 Close the disc cover.

2 Place a CD onto the center spindle.

Note:

- Insert CD with the disc's label facing up.

Note:

- To transport the player, remove the CD and slide the Lock switch toward the rear of the player, otherwise the disc cover may open and the player or the CD may get damaged.

Removing a CD

To remove a CD, follow the instructions below. Make sure that a blinking message "BUSY" does not appear on the player's display, and the Lock switch is not slid toward the rear of the player.

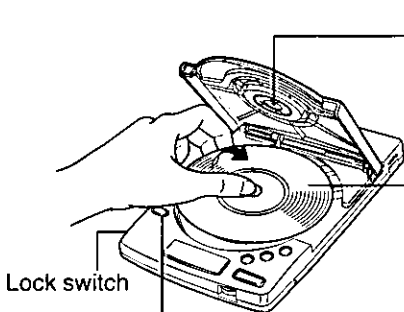

1 Press **OPEN** to open the disc cover and then raise it.

3 Close the disc cover.

2 Carefully remove the CD by lifting it.

Note:

- Replace the CD in its original case.



Using the Player with Computer

After the software installation (P. 19), you are ready to play game/photo/audio CDs.

Playing a CD-ROM

Notes:

- Some CD-ROMs are soundless.
- The computer sound of some CD-ROMs can be listened only through the PHONES jack of the player. Connect your headphones or amplified speaker to the PHONES jack of the player.

Playing a Photo CD

For best use of kodak's Photo CDs, we recommend using two Apple Extensions: QuickTime 1.5 *1 or later and Apple Photo Access *2.

*1 This is available through reseller, on several on-line service and on AppleLink.

*2 This is available on the Internet and on AppleLink.

To view images stored on Photo CDs, use any program that can view PICT files in conjunction with QuickTime.

To view and edit the images, you can use a specialized program such as Adobe's Photo shop.



Notes:



- QuickTime does not operate on some Macintosh such as Macintosh Plus, SE, Classic, Portable and Powerbook 100.
- If you are using System 6.0.x, Photo CD can not be played without MultiFinder.

Playing an audio CD

Notes:

- To listen to the music, connect your headphones or amplified speaker to the PHONES jack of the player.

- While playing an audio CD with your computer, the buttons ( ,  ,

 and ) on the player cannot be used.

Using the Player with Computer

Audio discs appear on the screen when mounted with files named track 1, track 2, etc., as follows.

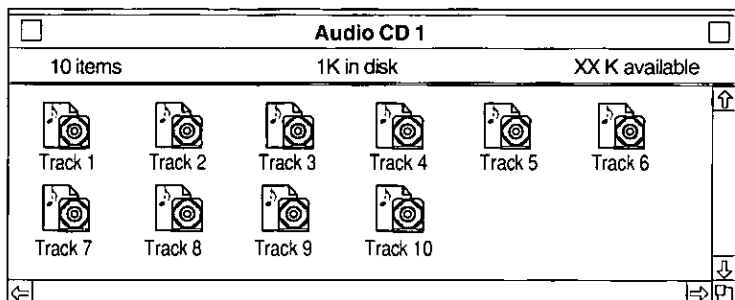

You can play these by simply double-clicking on individual tracks. CDT Remote Panel ( below) will appear and CDT Remote automatically scans the disc inserted in the player and displays the first track in the Elapsed Time Window.

The functions of each CDT Remote button are shown on the next page.

Note:

- If you are using System 6.0.x, CDT Remote Panel will not appear automatically by double-clicking on track. To activate the CDT Remote, double-click CDT Remote icon in the CD-ROM ToolKit Extras Folder.

CDT Remote Panel

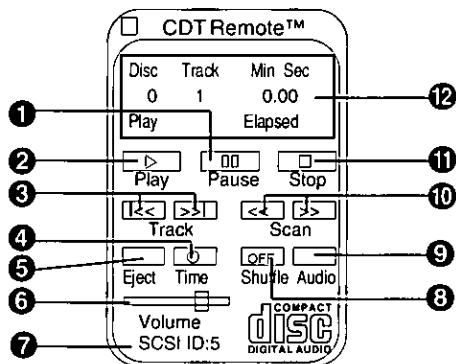

Using the Player with Computer

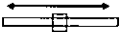
No.	Button	Function
①	Pause	Pauses/starts playing by clicking it.
②	Play	Starts playing the track displayed in the Elapsed Time Window by clicking it.
③	Track >>	Skips to the beginning of the next track by clicking it.
	Track <<	Skips to the beginning of the current track by clicking it. Goes to the previous track by clicking subsequently.
④	Time	Toggles between displaying the elapsed time for the current track and the time remaining for the current track by clicking it.
⑤	Eject *	Stops playing and drags the CD icon into the trash by clicking it. To play the same CD again, open and close the disc cover of the player.
⑥	Volume	Adjusts the volume from the CD-ROM drive output to your headphones or amplifier. If the volume of the player is set to 0, no sound can be heard. Lower  Higher
⑦	SCSI ID	Shows the SCSI ID number of the CD-ROM player selected.
⑧	Shuffle	Plays the tracks on the inserted CDs in random order until each is played by clicking it.
⑨	Audio	Selects different audio channels for play through your headphones or amplifier by clicking it. The factory setting is set at STEREO. <div style="border: 1px solid black; padding: 2px; display: inline-block;">STEREO</div> → <div style="border: 1px solid black; padding: 2px; display: inline-block;">STEREO from Left</div> → <div style="border: 1px solid black; padding: 2px; display: inline-block;">STEREO from Right</div> → <div style="border: 1px solid black; padding: 2px; display: inline-block;">MONAURAL form Left</div> → <div style="border: 1px solid black; padding: 2px; display: inline-block;">MONAURAL from Right</div> → <div style="border: 1px solid black; padding: 2px; display: inline-block;">MONAURAL</div>
⑩	Scan >>	Skips forward repeatedly in the audio portion played through the headphones or amplifier by holding it down while playing an audio track.
	Scan <<	Skips backward repeatedly in the audio portion played through the headphones or amplifier by holding it down while playing an audio track.
⑪	Stop	Stops playing and returns to the beginning of the current track by clicking it.
⑫	Elapsed Time Window	Displays the status information about the current track.

* CD will not be ejected automatically because this CD-ROM player is not a tray type.

Using the Player with Computer

If you move the cursor to the Menu bar item "Player" while the CDT Remote Panel is displayed, the following commands will appear. The functions of each command are shown in the table below.

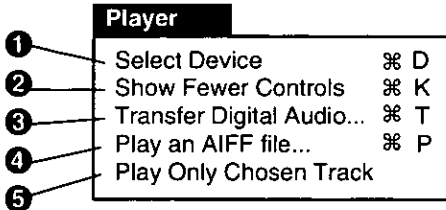

No.	Function
1	If you have more than one CD-ROM drive, CDT Remote automatically picks the drive with the lowest SCSI ID number. You can select another drive by choosing Select Device from the CDT Remote menu.
2	If you prefer to have CDT Remote take up less room on your screen, you can choose Show Fewer Controls and the CDT Remote window will shrink to less than half the size while still keeping the most important control buttons. Your selection will be saved, so the next time you run CDT Remote it will display the preferred size.
3	This command is not supported.
4	Playback of AIFF files at 16 bit quality, when possible, is also supported. The playback will function in the background, while you work, and will give much better performance than tools such as Apple's MoviePlayer 2.0. This menu item will not be displayed if QuickTime or Sound Manager 3.0 is not present.
5	This command will restrict CDT Remote to playing only the track that is currently displayed in the Elapsed Time Window.



Using the Player Independently

Playing an audio CD

If you are using batteries, you can enjoy listening to music under stable conditions. It is recommended not to play an audio CD while walking or jogging. It is recommended that you turn off the player's terminator so as to reduce the power consumption.

Caution:

- It is not safe to listen to headphones while driving a car.

Be sure the VOLUME control is set to 2-4 to avoid hearing very loud sound.

1 Insert an audio CD (P. 23).

2 Press POWER switch to turn on the player.

3 Plug your headphones (not supplied) into the PHONES jack.

4 Press .

While operating audio CDs, the following display appears.

Elapsed time

Audio CD's track number

Note:

- You can also listen to the music by connecting amplified speakers (not supplied).

Button	Function
	Starts/pauses playing an audio CD.
	Skips to the next track by pressing once.
	Continues skipping tracks if you hold down.
	Returns to the beginning of the track being played by pressing once.
	Skips to the previous track by pressing once when the elapsed time is 00:00.
	Continues reversing tracks if you hold down.
	Stops playing an audio CD.

Details of CD-ROM ToolKit

Setup disk includes a convenient Control Panel that allows users to automatically accelerate and configure all discs for optimum performance.

To open the Control Panel, follow the steps below.

1 Select Control Panel from Apple () Menu.

2 Double click the CD-ROM ToolKit icon.

After opening the Control Panel, CD-ROM ToolKit will automatically scan the SCSI bus and identify the device at each SCSI address in the right column.

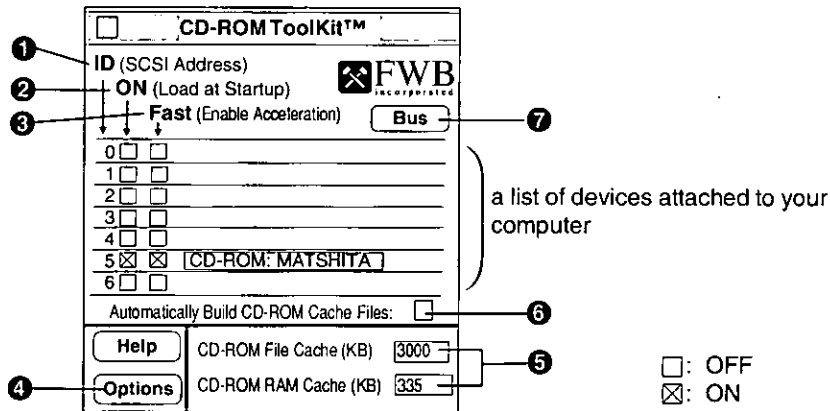

No.	Feature
1	SCSI ID No.
2	Allows you to designate whether you want CD-ROM ToolKit's device driver to be loaded at Startup. This feature provides users with an easy way to turn off CD-ROM ToolKit's driver should you wish to run a third party driver, such as Apple's.
3	Allows you to turn acceleration on or off for individual SCSI IDs.
4	Provides access to specific caching features.
5	Allows you to edit the amount of memory allocated to the cache. This number can be changed by clicking in the box and typing a new number.
6	By checking this, CD-ROM ToolKit starts caching file and directory information to the hard disk automatically when you insert a CD-ROM disc.
7	Allows you to view devices on any active SCSI Manager 4.3 compatible bus on your Macintosh by clicking it. The Bus will not appear unless more than one SCSI bus is present.





Click **Help** for further information.











Troubleshooting

When trouble occurs, check the following points before returning the player for service.



Player Issues

Trouble	Possible Cause	Solution
Turn on the POWER switch, but nothing appears on the display.	AC adaptor is not plugged into the outlet or DC IN jack correctly.	Plug in the AC adaptor correctly (P. 12).
	The alkaline batteries or rechargeable battery are/is not installed correctly, or dead.	Install the alkaline batteries/rechargeable battery properly, charge the rechargeable battery or replace with new batteries (P. 12, 13, 15).
You cannot listen to sound.	Headphones are not connected.	Connect the headphones to the PHONES jack firmly (P. 28).
	VOLUME control is set to "0".	Set the VOLUME control to a higher level (P. 10).
	The Volume of CDT Remote Panel is set to left most.	Adjust the volume by setting it to right side (P. 26).
Transmission speed of data slows down.	Using the alkaline batteries/rechargeable battery with computer.	Use the AC adaptor.
Disc cover can not be opened.	The Lock switch is slid toward the rear of the player.	Slide the Lock switch to opposite direction.
AC adaptor is connected/rechargeable battery or alkaline batteries is/are installed, but buttons/POWER switch of player do not function.	While playing an audio CD with your computer, the buttons ( ,  ,  and ) on the player cannot be used.	Use the CDT Remote Panel to play an audio CD using the computer (P. 25).
		Disconnect the AC adaptor/remove the batteries or rechargeable battery and then connect the AC adaptor/install the batteries or rechargeable battery.

(continued)

Trouble	Possible Cause	Solution
"no dISC" message appears even after inserting a CD, Sound skips, or data can not be read.	CD is placed with the label side facing down.	Place the CD with the label side facing up ( P. 23).
	CD without  or  mark is used.	Use the CD marked with  or  .
	CD may have become dirty.	Clean the CD ( P. 36).
	CD is damaged.	Replace with another CD.
	The player or/and CD are damp or moist, because the player or/and CD may be moved from a cold place to a warm place.	Remove the CD from the player and do not use the player and CD for 1 hour.
The optional rechargeable battery runs down too soon.	The rechargeable battery capacity has been reduced and the battery life has been shortened by being charged too often after using for short periods.	Refresh the rechargeable battery ( P. 14). If the battery runs down quickly even after refreshing, replace with new one.
The optional rechargeable battery can not be charged.	AC adaptor is not connected, the rechargeable battery is not installed or POWER switch of the player is not on.	Connect the AC adaptor, install the rechargeable battery or turn on the POWER switch of the player ( P. 13).









CD-ROM Hardware Setup and Configuration Issues

Trouble	Possible Cause	Solution
CD-ROM ToolKit icon does not appear when starting computer. 	CD-ROM ToolKit has not been loaded properly.	Reinstall the software ( P. 19).
When starting computer, following icon appears.  [CD-ROM ToolKit is not loaded properly.]	Extension is causing the confliction.	Disable other System Extensions by removing them or using an Extension management program, and restart your computer and then rename the CD-ROM Toolkit Control Panel or put a space before it's name.

(continued)



Troubleshooting



Trouble	Possible Cause	Solution
<p>When starting computer, following icon appears.</p>  <p>[Drive is not recognized.]</p>	<p>The player is not ON or the cable is not connected properly.</p>	<p>Turn on the player before turning on your computer, or connect the cable properly.</p>
	<p>The SCSI cable is not connected to the player or to the computer properly.</p>	<p>Connect the SCSI cable properly ( P. 16, 17).</p>
	<p>The SCSI cable pin is bent or broken.</p>	<p>Contact an Authorized Panasonic Service Center.</p>
	<p>Using a computer with the terminator switch of the player OFF.</p>	<p>Turn the terminator switch ON ( P. 35).</p>
	<p>There are duplicate SCSI ID numbers in computer system.</p>	<p>Set the different SCSI ID number for each device. Normally "0" is set for hard disk and "3" is set for built-in CD-ROM drive ( P. 35).</p>
	<p>Check box next to the player's SCSI ID No. on CD-ROM ToolKit Control Panel is not ON.</p>	<p>Open the CD-ROM ToolKit Control Panel and check the box next to the SCSI ID No. of the player ( P. 29).</p>
	<p>There is not enough memory to load CD-ROM ToolKit.</p>	<p>Increase the memory.</p>
<p>The player does not appear on the list in the CD-ROM ToolKit Control Panel.</p>	<p>The player is not ON or the cable is not connected properly.</p>	<p>Turn on the player or connect the cable properly.</p>
	<p>The player is conflicting with another device.</p>	<p>Set the different SCSI ID number for each device ( P. 35).</p>
<p>Transmission speed of data slows down.</p>	<p>QuickTime is being used.</p>	<p>Please refer to "QuickTime playback" of the "CD-ROM ToolKit" in "Read Me for Panasonic" file ( P. 20).</p>
<p>Malfunction of the computer.</p>	<p>Turning off the player before ending the current job.</p>	<p>Turn on the player or reset the computer ( P. 18).</p>

CD Mounting/Ejecting Issues

Trouble	Possible Cause	Solution
CD can not be mounted.	The player is not ON, or the cable is not connected properly.	Turn on the player, or connect the cable properly.
	Check box next to the player's SCSI ID No. on the CD-ROM ToolKit Control Panel is not ON.	Open the CD-ROM ToolKit Control Panel and check the box next to the SCSI ID No. of the player (P. 29).
	Unsupported CD-ROM format is loaded.	Load the CD-ROM such as Photo CD, HSF, High sierra, ISO 9660, Apple ProDOS.
	Mounted icon is not dragged to trash.	Drag the mounted CD to trash and then change the disc.
	File accessible to different format is installed in the System Extensions Folder.	Install Foreign File Access, Audio CD Access, High Sierra File Access and ISO 9660 File Access into System Extensions Folder.
Mounted CD can not be ejected.	Part of the file is currently in use.	Close the file which is currently in use in Finder and drag the icon.
	File is used in common.	Cancel the common use of the file.
After changing disc, previously installed icon still exists in Finder.	The mounted icon is not dragged to the trash.	Drag the mounted CD to the trash and open the disc cover of the player and then insert the disc.
Photo CD can not be read.	For use of Photo CD, QuickTime 1.5 or later and Apple Photo Access are required.	Install QuickTime 1.5 or later and Apple Photo Access into System Folder. These are available through resellers, on several on-line services and on AppleLink (P. 24).



Error Messages on Computer

Error Message	Possible Cause	Solution
This is not a Macintosh Disk.	Foreign File Access, Audio CD Access, High Sierra File Access, ISO 9660 File Access has not been loaded into the Extensions Folder.	Load these files by using the setup disk.
	CPU accelerator is being used.	Some CPU accelerator can not use blind SCSI I/O. Select the Options from CD-ROM ToolKit Control Panel and set "Use Slower Polled Non-Blind SCSI I/O" to on ( P. 29).
CD-ROM ToolKit will not be able to support one of your CD-ROM drives because it is already handled by another CD-ROM driver.	CD-ROM driver other than CD-ROM ToolKit is being used.	Open the CD-ROM ToolKit Control Panel and click off the check box next to the other CD-ROM driver's SCSI ID No. ( P. 29) or remove the currently used CD-ROM driver from System Folder.

SCSI ID Number and Terminator

■ SCSI ID number:

Each SCSI device connected to your computer system has an individual ID number (refer to the respective manuals). Be sure that the CD-ROM SCSI ID number does not conflict with another SCSI device connected to the computer system.

The factory setting of the player's SCSI ID number is set to 5.

■ Terminator:

Set the Terminator switch ON or OFF according to the player's condition.

ON: when the player is connected to the computer system.

OFF: when using independently as an audio player (power consumption can be saved.) (P. 28).

The factory setting is **ON**.

Setting

Set the ID number switch (1~3) or Terminator switch (4) ON/OFF by using a pointed object like a pen, and referring to the table below (for ID number).

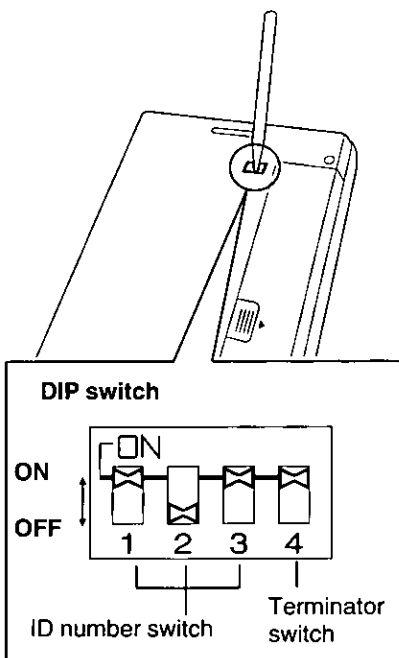

(For SCSI ID number setting)

ID number	ID number switch		
	1	2	3
0	OFF	OFF	OFF
1	ON	OFF	OFF
2	OFF	ON	OFF
3	ON	ON	OFF
4	OFF	OFF	ON
5	ON	OFF	ON
6	OFF	ON	ON
7 *	ON	ON	ON

: Factory setting.

* Do not use "7" for player's SCSI ID No. since it is used for computer.

Example: ID number=5/Terminator=ON



Maintenance

Player

Cautions:

- Do not use benzine, thinner, etc.
- Do not use commercial lens cleaner.

Clean the outside of the player with a soft, dry cloth.



Clean the lens with a dry cotton swab or a lens blower.

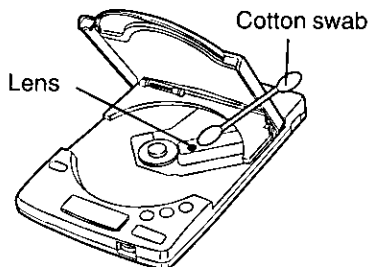

CD

Cautions:

- Do not use solvents such as benzine, record cleaners or anti-static spray for records.
- Do not touch the signal side.
- Do not attach the labels to the disc.
- Do not write on the surface of disc with a pointed object like a pen.

Wipe from the center to the edge with a dry, soft cloth.



Specifications

Power Source:	Refer to the nameplate at the bottom of the unit.	
Interface:	SCSI-1, 2	
Buffer Size:	128 KB	
Operating Environment (under no damp or moist conditions):	Temperature: 5°C {41°F} to 35°C {95°F} Humidity: 20% to 85% RH	
Storage Environment (under no damp or moist conditions):	Temperature: -20°C {-4°F} to 55°C {131°F} Humidity: 15% to 85% RH	
Dimensions:	138 (W) × 204 (D) × 35 (H) mm {5.52" × 8.16" × 1.4"}	
Mass (Weight):	0.46 kg {1.014 lb.} (without batteries)	
Battery Life [at 20°C {68°F}]:	<ul style="list-style-type: none"> • When using Panasonic alkaline "AA" size batteries Approximately 4 hours when playing audio CD Approximately 2 hours when playing CD-ROM • When using the optional rechargeable battery Approximately 2 hours when playing audio CD Approximately 1 hour when playing CD-ROM 	
Power Consumption:	<ul style="list-style-type: none"> •When playing CD-ROM 12 W [with AC adaptor] •When player is off 1.0 W [with AC adaptor] 	
Data Transfer Rate (when using AC adaptor):	150 KB/s (Normal Velocity mode) 600 KB/s (Quad Velocity mode)	
Output Connector:	PHONES jack	
Compatible CD-ROM Format:	CD-DA (CD) CD-ROM (Mode 1 and Mode 2 Form 1) Photo CD Multi-session CD-ROM XA (Mode 2 Form 2)	
Access Time* (when using AC adaptor): (The information is based on the test results measured by Panasonic internal test software.)	Quad Velocity mode 295 ms typical (1/3 stroke) 540 ms typical (Full-stroke)	
Error Rates:	Soft read errors	Less than 10 ⁻⁹
	Hard read errors	Less than 10 ⁻¹²
Audio Performance (Stereo Headphones):	Frequency response	20 Hz~20 kHz
	S/N	More than 80 dB (A Range)
	Output level	0.6 Vrms

* When using optional rechargeable battery or alkaline "AA" size batteries, the access time may increase.



Index

A

AC adaptor	8, 12
Accessories	8
Alkaline batteries	15
Apple Photo Access	24, 33
Apple Menu	21, 29
Audio CD	24, 25, 28

B

Back-up copy	19
Battery cover	10, 12, 15

C

Cache	29
Connecting Player to Computer	16
CD-ROM device driver	19
CD-ROM ToolKit	20, 21, 22
Control Panel	22, 29
CDT Remote	25, 26, 27

D

Daisy chain	17
DC IN jack	10, 12
Desktop Macintosh	17
DIP switch	10, 35
Disabling old CD-ROM device driver	19
Disc cover	10, 23
Display	10
Display Messages on Player	11

E

Error Messages on Computer	34
----------------------------	----

F

Features	7
Forward skip button	10, 28

L

Lock switch	10, 23
-------------	--------

O

OPEN button	10, 23
Option	12, 39

P

Part Names and Functions	10
PHONES jack	10, 28
Photo CD	24
PLAY/PAUSE/CHARGE button	10, 13, 28
Playing	
audio CD	24, 28
CD-ROM	24
Photo CD	24
PowerBook	16
Power On	18
Power Save Function	18
Power Supply	12
POWER switch	10, 18
Precautions	8

Q

QuickTime	24, 27, 32
-----------	------------

R

Rechargeable battery	12, 13, 14, 18
Reverse skip button	10, 28

S

SCSI cable	8, 16, 17
SCSI ID number	10, 35
SCSI interface connector	10, 16, 17
Setup disk	8, 19, 20
Software Installation	19
Specifications	37
STOP button	10, 28
System Requirement	19

T

Terminator	10, 35
Troubleshooting	30

V

VOLUME control	10, 28
----------------	--------

Option

The following option is available through your local authorized parts distributor.

KXL-D30 Rechargeable Battery



FOR USERS IN CONTINENTAL UNITED STATES ONLY

Technical Support and Service Parts Calls

If you have read this manual and tried the troubleshooting procedures, and you are still having difficulty, please contact the store from which the unit was purchased. Panasonic Communications & Systems Company will repair this product with new or refurbished parts free of charge for two (2) years from the date of purchase.

You may also call the technical support telephone number (24 hours/7 days).

**The technical support number is: 1-800-PANA-SYS
(1-800-726-2797)**

The service parts number is: 1-800-332-5348

**Panasonic Communications & Systems Company,
Computer Products Division
Division of Matsushita Electric Corporation of America
Two Panasonic Way, Secaucus, New Jersey 07094**

**Panasonic Sales Company
Division of Matsushita Electric of Puerto Rico, Inc.
San Gabriel Industrial Park, 65th Infantry Avenue KM. 9.5
Carolina, Puerto Rico 00630**

**Matsushita Electric of Canada Limited
5770 Ambler Drive, Mississauga, Ontario, L4W 2T3**

**Matsushita Electric Industrial Co., Ltd.
Central P.O. Box 288, Osaka 530-91, Japan**

Free Manuals Download Website

<http://myh66.com>

<http://usermanuals.us>

<http://www.somanuals.com>

<http://www.4manuals.cc>

<http://www.manual-lib.com>

<http://www.404manual.com>

<http://www.luxmanual.com>

<http://aubethermostatmanual.com>

Golf course search by state

<http://golfingnear.com>

Email search by domain

<http://emailbydomain.com>

Auto manuals search

<http://auto.somanuals.com>

TV manuals search

<http://tv.somanuals.com>