



Panasonic®

Operating Instructions Portable DVD/CD Player

Model No. **DVD-LS90**
DVD-LS87
DVD-LS85

Dear customer

Thank you for purchasing this product.
For optimum performance and safety, please read these instructions carefully.
Before connecting, operating or adjusting this product, please read the instructions completely.
Please keep this manual for future reference.

Region number

The player plays DVD-Video marked with labels containing the region number or "ALL".

Region	Number
For the United Kingdom and Continental Europe	2
For Asia	3
For Australia and N.Z.	4

Example: For the United Kingdom and Continental Europe



Operations in these instructions are described mainly with the main unit, but you can do the operations on the remote control if the remote controls are the same (→ Back cover)



MULTI-FORMAT PLAYBACK

DVD-RAM

recorded with DVD video recorders etc.

Video & Still pictures (JPEG)

DVD-RW (DVD-VR)

recorded and finalized with DVD video recorders etc.

DVD-Video/Video CD/CD

sold on the market

Movie, Music etc.

DVD-R/DVD-RW/+R/+RW

recorded and finalized with DVD video recorders etc.

Video (played as DVD-Video)

CD-R/CD-RW

recorded and finalized with personal computers etc.

Music (WMA/MP3) & Still pictures (JPEG)

See page 5 for details.

DVD-LS85

Car DC Adaptor is not included.

Note "EB" on the packaging indicates the United Kingdom.

EB EG GCS GN



Caution for AC Mains Lead

(For United Kingdom) ("EB" area code model only)

For your safety, please read the following text carefully. This appliance is supplied with a moulded three pin mains plug for your safety and convenience.

A 5-ampere fuse is fitted in this plug.

Should the fuse need to be replaced please ensure that the replacement fuse has a rating of 5-ampere and that it is approved by ASTA or BSI to BS1362.

Check for the ASTA mark  or the BSI mark  on the body of the fuse.

If the plug contains a removable fuse cover you must ensure that it is refitted when the fuse is replaced.

If you lose the fuse cover the plug must not be used until a replacement cover is obtained.

A replacement fuse cover can be purchased from your local dealer.

CAUTION!

IF THE FITTED MOULDED PLUG IS UNSUITABLE FOR THE SOCKET OUTLET IN YOUR HOME THEN THE FUSE SHOULD BE REMOVED AND THE PLUG CUT OFF AND DISPOSED OF SAFELY. THERE IS A DANGER OF SEVERE ELECTRICAL SHOCK IF THE CUT OFF PLUG IS INSERTED INTO ANY 13-AMPERE SOCKET.

If a new plug is to be fitted please observe the wiring code as stated below.

If in any doubt please consult a qualified electrician.

IMPORTANT

The wires in this mains lead are coloured in accordance with the following code:
Blue: Neutral, Brown: Live.

As these colours may not correspond with the coloured markings identifying the terminals in your plug, proceed as follows:

The wire which is coloured Blue must be connected to the terminal which is marked with the letter N or coloured Black or Blue.

The wire which is coloured Brown must be connected to the terminal which is marked with the letter L or coloured Brown or Red.

WARNING: DO NOT CONNECT EITHER WIRE TO THE EARTH TERMINAL WHICH IS MARKED WITH THE LETTER E, BY THE EARTH SYMBOL  OR COLOURED GREEN OR GREEN/YELLOW.

THIS PLUG IS NOT WATERPROOF—KEEP DRY.

Before use

Remove the connector cover.

How to replace the fuse

The location of the fuse differ according to the type of AC mains plug (figures A and B). Confirm the AC mains plug fitted and follow the instructions below.

Illustrations may differ from actual AC mains plug.

1. Open the fuse cover with a screwdriver.

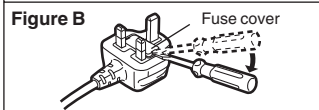
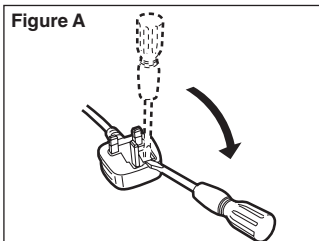

2. Replace the fuse and close or attach the fuse cover.

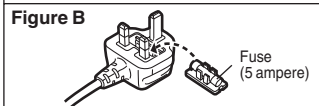
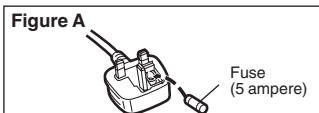

WARNING:

TO REDUCE THE RISK OF FIRE, ELECTRIC SHOCK OR PRODUCT DAMAGE, DO NOT EXPOSE THIS APPARATUS TO RAIN, MOISTURE, DRIPPING OR SPLASHING AND THAT NO OBJECTS FILLED WITH LIQUIDS, SUCH AS VASES, SHALL BE PLACED ON THE APPARATUS.

WARNING:

The driver must not operate this unit while the vehicle is moving.

Do not operate this unit where it can be viewed by the driver.

Driver operation or viewing of this unit while the vehicle is moving will cause distraction which may result in serious accident and personal injury or property damage.

CAUTION!

- DO NOT INSTALL OR PLACE THIS UNIT IN A BOOKCASE, BUILT-IN CABINET OR IN ANOTHER CONFINED SPACE. ENSURE THE UNIT IS WELL VENTILATED. TO PREVENT RISK OF ELECTRIC SHOCK OR FIRE HAZARD DUE TO OVERHEATING, ENSURE THAT CURTAINS AND ANY OTHER MATERIALS DO NOT OBSTRUCT THE VENTILATION VENTS.
- DO NOT OBSTRUCT THE UNIT'S VENTILATION OPENINGS WITH NEWSPAPERS, TABLECLOTHS, CURTAINS, AND SIMILAR ITEMS.
- DO NOT PLACE SOURCES OF NAKED FLAMES, SUCH AS LIGHTED CANDLES, ON THE UNIT.
- DISPOSE OF BATTERIES IN AN ENVIRONMENTALLY FRIENDLY MANNER.

CAUTION!

THIS PRODUCT UTILIZES A LASER. USE OF CONTROLS OR ADJUSTMENTS OR PERFORMANCE OF PROCEDURES OTHER THAN THOSE SPECIFIED HEREIN MAY RESULT IN HAZARDOUS RADIATION EXPOSURE. DO NOT OPEN COVERS AND DO NOT REPAIR YOURSELF. REFER SERVICING TO QUALIFIED PERSONNEL.

CAUTION!

DANGER OF EXPLOSION IF BATTERY IS INCORRECTLY REPLACED.

REPLACE ONLY WITH THE SAME OR EQUIVALENT TYPE RECOMMENDED BY THE MANUFACTURER. DISCARD USED BATTERIES ACCORDING TO THE MANUFACTURER'S INSTRUCTIONS.

AC adaptor

This AC adaptor operates on AC between 100 V and 240 V.

But

- Obtain a suitable plug adaptor if the plug does not fit the AC mains socket.

The socket outlet shall be installed near the equipment and easily accessible or the mains plug or an appliance coupler shall remain readily operable.

This product may receive radio interference caused by mobile telephones during use. If such interference is apparent, please increase separation between the product and the mobile telephone.

Marking sign is located on bottom of the unit.

Table of contents

Caution for AC Mains Lead	2
Precautions	4
Accessories	5
Discs that can be played	5

Preparations

① Attaching the battery	6
② Recharging the battery	6
③ The remote control	7
④ Adjusting the LCD angle	7

Play	8
------	---

Useful functions	10
------------------	----

Enjoying higher quality audio and video	12
---	----

Program/Random play	13
---------------------	----

Playing data discs	14
--------------------	----

Playing HighMAT™ discs	15
------------------------	----

Playing programs/playlists on RAM/DVD-RW (DVD-VR) discs	15
---	----

Playing CD	15
------------	----

Using On-Screen Menus	16
-----------------------	----

Changing the player settings	18
------------------------------	----

Using this unit with other equipment	20
--------------------------------------	----

When Using in a car	21
---------------------	----

Frequently asked questions	22
----------------------------	----

Tips for making WMA/MP3 and JPEG discs (For CD-R/CD-RW)	22
---	----

Specifications	23
----------------	----

Troubleshooting guide	24
-----------------------	----

Maintenance	26
-------------	----

Main feature index	Back cover
--------------------	------------

Do not rest the unit on your lap for a long time while using it. The unit can become hot and cause burns.

To prevent damage

Avoid the following:

- Spraying flammable insecticides near the unit.
- Pressing the LCD.
- Touching the lens and other parts of the laser pickup.

Do not use the unit in the following places:

- Sandy places such as beaches.
- On top of cushions, sofas, or hot equipment such as amplifiers.

Do not leave in an unventilated automobile or exposed to direct sunlight and high temperatures.

Precautions

Read these operating instructions carefully before using the unit. Follow the safety instructions on the unit and the applicable safety instructions listed below. Keep these operating instructions handy for future reference.

- 1) Read these instructions.
- 2) Keep these instructions.
- 3) Heed all warnings.
- 4) Follow all instructions.
- 5) Do not use this apparatus near water.
- 6) Clean only with dry cloth.
- 7) Do not block any ventilation openings.
Install in accordance with the manufacturer's instructions.
- 8) Do not install near any heat sources such as radiators, heat registers, stoves, or other apparatus (including amplifiers) that produce heat.
- 9) Protect the AC mains lead from being walked on or pinched particularly at plugs, convenience receptacles, and the point where they exit from the apparatus.
- 10) Only use attachments/accessories specified by the manufacturer.
- 11) Use only with the cart, stand, tripod, bracket, or table specified by the manufacturer, or sold with the apparatus. When a cart is used, use caution when moving the cart/apparatus combination to avoid injury from tip-over. 
- 12) Unplug this apparatus during lightning storms or when unused for long periods of time.
- 13) Refer all servicing to qualified service personnel. Servicing is required when the apparatus has been damaged in any way, such as AC mains lead or plug is damaged, liquid has been spilled or objects have fallen into the apparatus, the apparatus has been exposed to rain or moisture, does not operate normally, or has been dropped.

For the United Kingdom and Republic of Ireland

Sales and Support Information

Customer Care Centre

- For customers within the UK: 08705 357357
- For customers within the Republic of Ireland: 01 289 8333
- Visit our website for product information
- E-mail: customer.care@panasonic.co.uk

Direct Sales at Panasonic UK

- Order accessory and consumable items for your product with ease and confidence by phoning our Customer Care Centre Monday - Thursday 9:00am - 5:30pm, Friday 9:30am - 5:30pm (Excluding public holidays).
- Or go on line through our Internet Accessory ordering application at www.panasonic.co.uk.
- Most major credit and debit cards accepted.
- All enquiries transactions and distribution facilities are provided directly by Panasonic UK Ltd.
- It couldn't be simpler!
- Also available through our Internet is direct shopping for a wide range of finished products, take a browse on our website for further details.

Download from www.Somanuals.com. All Manuals Search And Download.

Batteries

1. Battery pack (Lithium ion battery pack)

- Use this unit to recharge the battery pack.
 - Do not use the battery pack with equipment other than the specified player.
 - Do not use the player outside if it is snowing or raining. (The battery pack is not waterproof.)
 - Do not get dirt, sand, liquids, or other foreign matter on the terminals.
 - Do not touch the plug terminals (+ and -) with metal objects.
 - Do not disassemble, remodel, heat or throw into fire.
 - Do not store the battery pack in temperature over 60 °C.
- ### 2. Button-type battery (Lithium battery)
- Insert with poles aligned.
 - Do not touch the terminals (+ and -) with metal objects.
 - Do not disassemble, remodel, heat or throw into fire.
 - Keep out of reach of children

If any electrolyte should come into contact with your hands or clothes, wash it off thoroughly with water.

If any electrolyte should come into contact with your eyes, never rub the eyes.

Rinse eyes thoroughly with water, and then consult a doctor.

3. Disposing of the batteries

Check and follow your local regulations before disposal.

For the United Kingdom, Continental Europe, Australia and N.Z.

THIS UNIT IS INTENDED FOR USE IN MODERATE CLIMATES.

For Asia

THIS UNIT IS INTENDED FOR USE IN TROPICAL CLIMATES.

Precautions for Listening with the Headphones or Earphones

- Do not play your headphones or earphones at a high volume. Hearing experts advise against continuous extended play.
- If you experience a ringing in your ears, reduce volume or discontinue use.
- Do not use while operating a motorized vehicle. It may create a traffic hazard and is illegal in many areas.
- You should use extreme caution or temporarily discontinue use in potentially hazardous situations.
- Even if your headphones or earphones are the open-air type designed to let you hear outside sounds, don't turn up the volume so high that you can't hear what's around you.

Accessories



Use numbers indicated in parentheses when asking for replacement parts.
(Product numbers correct as of March 2005. These may be subject to change.)





- 1 Remote control (N2QAHC000021)
 - 1 Button-type battery* for remote control (for replacement, see page 7.)
 - 1 Audio/video cable (K2KA6CB00003)
 - 1 AC adaptor (RFEA213W)
 - 1 AC mains lead
 - For the United Kingdom (RJA0053-3X)
 - For Australia and N.Z. (K2CJ2DA00008)
 - For others (K2CQ2CA00006)
 - 1 Car DC Adaptor (DVD-LS90) (DVD-LS87) only (RFEC201M)
 - 1 Rechargeable battery pack
 - (DVD-LS90) (CGR-H702)
 - (DVD-LS87) (DVD-LS85) (CGR-H701)

For replacement: Available from Panasonic dealers

 - (DVD-LS90) (CGR-H703)
 - (DVD-LS90) only (CGR-H702)
 - (DVD-LS87) (DVD-LS85) only (CGR-H701)
- *The included AC mains lead and AC adaptor are for use with this unit only.
Do not use them with other equipment.
*Keep out of the small children.
Accidental swallowing of batteries can result in stomach and intestinal damage.

Discs that can be played

Operations in these instructions are described mainly with reference to specific formats.
Icons such as **RAM** show the formats.

	DVD-RAM RAM JPEG <ul style="list-style-type: none"> • RAM Recorded with devices using Version 1.1 of the Video Recording Format (a unified video recording standard), such as DVD video recorders, DVD video cameras, personal computers, etc. • JPEG Recorded with Panasonic DVD-Video recorders using DCF (Design rule for Camera File system) Standard Version 1.0. To play JPEG files, select "Play as Data Disc" (→ page 17, Other Menu).
	DVD-Video DVD-V —
	DVD-R (DVD-Video)/DVD-RW (DVD-Video) DVD-V Discs recorded and finalized* on DVD video recorders or DVD video cameras DVD-RW (DVD-VR) DVD-RW (VR) Discs recorded and finalized* on DVD video recorders or DVD video cameras using Version 1.1 of the Video Recording Format (a unified video recording standard).
—	+R (Video)/+RW (Video) DVD-V Discs recorded and finalized* on DVD video recorders or DVD video cameras
	Video CD VCD Including SVCD (Conforming to IEC62107)
	CD CD WMA MP3 JPEG VCD <ul style="list-style-type: none"> • This unit can play CD-R/RW recorded with the above formats. Close the sessions or finalize* the disc after recording. • WMA MP3 JPEG This unit also plays HighMAT discs.

*A process that allows play on compatible equipment.

- It may not be possible to play the above discs in all cases due to the type of disc or condition of the recording.

Discs that cannot be played

DVD-Audio, DVD-ROM, Version 1.0 of DVD-RW, CD-ROM, CDV, CD-G, SACD, DivX Video Discs and Photo CD, DVD-RAM that cannot be removed from their cartridges, 2.6-GB and 5.2-GB DVD-RAM, and "Chaoji VCD" available on the market including CVD, DVCD and SVCD that do not conform to IEC62107. Download from www.Somanuals.com. All Manuals Search And Download.

Preparations

FOR THE UNITED KINGDOM ONLY
READ THE CAUTION FOR THE AC MAINS LEAD ON PAGE 2 BEFORE CONNECTION.

1 Attaching the battery (When the unit is off)

The illustrations show how to attach the CGR-H702. Attach CGR-H701 in the same way.

Bottom side of this unit

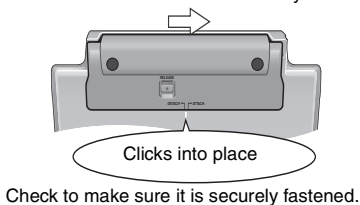
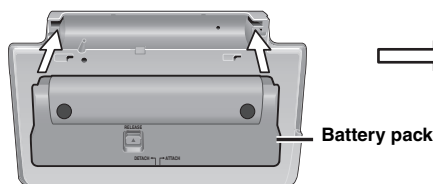

Detaching

- Turn the unit off before detaching the battery pack.
- The illustrations show how to detach the CGR-H702. Detach CGR-H701 in the same way.

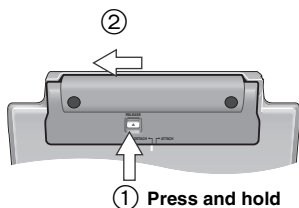

When not using for long periods of time

- Remove the battery pack (→ left).
 (Even when the unit is turned off, there is a small amount of voltage running through the unit, and this may result in a malfunction.)
- Recharge the battery for re-use.

2 Recharging the battery (When the unit is off)

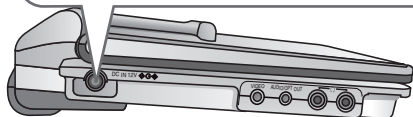
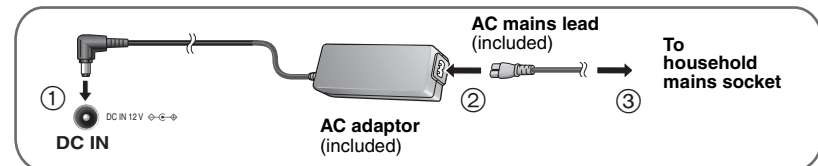

- You can also use this unit without charging while connecting the AC adaptor and the AC mains lead.

To conserve power

This unit consumes 0.5 W of power even when turned off. When the unit is not going to be used for a long time, disconnect the AC mains lead from the household mains socket.

The unit is in the standby condition (the [⏻] indicator lights) when the AC mains lead is connected. The primary circuit is always "live" as long as the AC adaptor is connected to an electrical outlet.

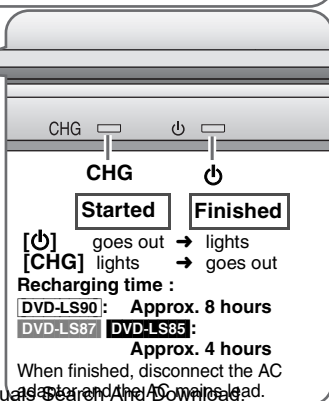

Checking the remaining battery charge

When the unit is on (→ page 8) and powered by the battery pack
Press [DISPLAY] to check on the LCD (Displays for a few seconds).

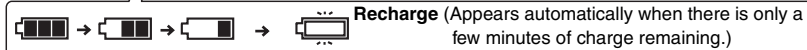
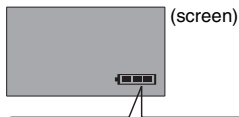

Approximate play times (Hours)

Battery pack	Play (at room temperature using headphones)			
	LCD brightness level			LCD Off
	-5	0 (factory preset)	+5	
CGR-H701 (DVD-LS87 DVD-LS85)	3	2	1.5	4
CGR-H702 (DVD-LS90)	6	4	3	8
CGR-H703 (optional)	10	8	6	16

- The times indicated above may differ depending on use.
- To change the LCD brightness (→ page 11, Adjusting the picture quality on the LCD).

3 The remote control

Insert the button-type battery (included)

Range of use

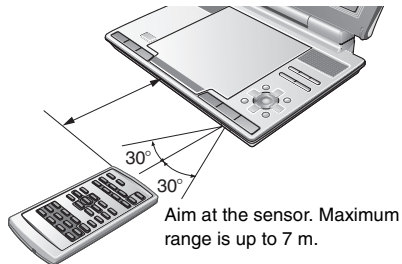
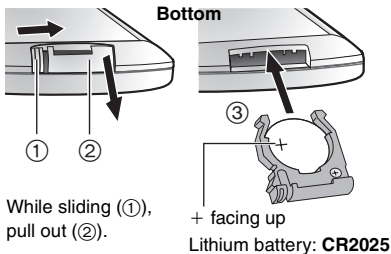

You cannot use the remote control to turn the unit on when powered by the battery pack.

4 Adjusting the LCD angle

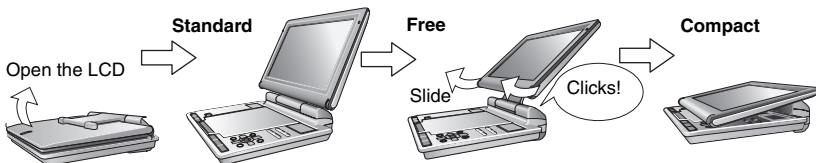

Play

1 Open the lid.

OPEN



Headphone terminals []
3.5 mm Stereo

2 Insert a disc and close the lid.

Click into place



Load double-sided discs so the label for the side you want to play is facing up.

RAM Remove discs from their cartridges before use.

3 Press and hold.

ON



The unit turns on and play begins.

4 Adjust the volume.





VOL





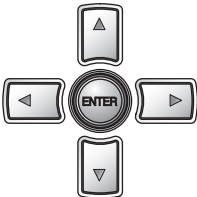

- While stopped, the unit automatically turns off once 15 minutes (after approximately 5 minutes when using the battery pack) have elapsed.
- Discs continue to rotate while menus are displayed. Press [■, -OFF] when you finish to preserve the unit's motor.
- Total title number may not be displayed properly on +R/+RW.
- If you are experiencing problems, refer to troubleshooting guide (→ page 24).

Main unit operations

	Turn unit on/play	Press and hold and the power comes on and play begins.
	Pause	Press [▶, ON] to restart play.
	Stop	The position is memorized when "▷" flashes on the screen. <ul style="list-style-type: none"> • Press [▶, ON] to resume. • DVD-V While the message is displayed, press [▶, ON] and the previous chapters are reviewed. Opening the lid, or pressing [■, -OFF] while "▷" is flashing cancels the memorized position where play stopped.
Turn unit off	Press and hold until "OFF" is displayed.	Press and hold until "OFF" is displayed.

	Skip	Press [⏮ , ⏭]. RAM DVD-RW (VR) Can also skip to the markers.
	Search	Press and hold [⏮ , ⏭] (up to 5 steps).
	Slow play	Press and hold [⏮ , ⏭] (up to 5 steps) while paused. Press [▶ , ON] to return to normal play. VCD [⏭] only
TOP MENU 	Top menu	DVD-V
	Playing programs	RAM DVD-RW (VR) (→ page 15)
MENU 	Menu	DVD-V
	Playing playlists	RAM DVD-RW (VR) (→ page 15)
	Navigation menu	WMA MP3 JPEG (→ page 14)
RETURN 	Return	Returns to the previous screen. VCD (with playback control) Returns to the menu.
	Menu operation	Press [▲ ▼ ◀ ▶] to select an item and press [ENTER] to confirm.
	Frame-by-frame	While paused, press [◀ ▶]. VCD [▶] only
	Group skip	WMA MP3 JPEG Press [▲ ▼].

Remote control operations

	Turn on/off	You cannot use the remote control to turn the unit on when powered by the battery pack.
	Skip	Press [⏮ , ⏭].
	Search	Press [◀◀ , ▶▶] (up to 5 steps).
	Slow play	Press [◀◀ , ▶▶] (up to 5 steps) while paused. Press [▶] (PLAY) to return to normal play. VCD [▶▶] only
	Enter number	RAM DVD-RW (VR) DVD-V VCD CD e.g. To select 12: [≥10] → [1] → [2] VCD with playback control While stopped, press the numbered buttons. WMA MP3 JPEG e.g. To select 123: [1] → [2] → [3] → [ENTER]

Useful functions

Repeat play (Only when the elapsed play time can be displayed.
For JPEG, you can use even if there is no elapsed time display.)



Press several times to select the content to repeat.

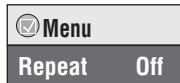

• To exit the screen : Press [RETURN].

To repeat a specified section (A-B Repeat)

Except **JPEG** and **RAM DVD-RW (VR)** (still picture part)

1 DISPLAY



Press once.

2



① Press [**▲▼**] to select Other Settings.

② Press [**▶**] to go to the next menu and [**▲▼**] to select "Play Menu".

③ Press [**▶**] to go to the next menu and [**▲▼**] to select "A-B Repeat".

④ Press [ENTER] at the starting and ending points.

- Press [ENTER] again to cancel.
- To exit the screen : Press [RETURN].



Changing play speed **RAM DVD-RW (VR) DVD-V**

1 DISPLAY



Press once.

2



① Press [**▲▼**] to select Other Settings.

② Press [**▶**] to go to the next menu and [**▲▼**] to select "Play Speed".

③ Press [ENTER] and [**▲▼**] to select "Normal" or "×0.6" to "×1.4" (in 0.1 units).

④ Press [ENTER].

- Press [**▶**] (PLAY) to return to normal play.
- After you change the speed
 - Advanced Surround (→ below) and Multi Re-master (→ page 12) do not work.
 - Digital output switches to PCM-2ch.
 - 96 kHz sampling frequency is converted to 48 kHz.
- This may not work depending on the disc's recording.
- To exit the screen : Press [RETURN].

Enjoying virtual surround (Advanced Surround)

RAM DVD-RW (VR) DVD-V VCD (2 or more channels)

ASURROUND



Press to select "SP 1 Natural" or "SP 2 Enhanced".

A surround sound effect can be made using 2 speakers (on other equipment).

- When using headphones, press to select "HP 1 Natural" or "HP 2 Enhanced".
- When using discs recorded with surround sound, sound seems to come from speakers on either side of you.
- Optimum seating position is 3 to 4 times the distance between the front left and right speakers or the width of the television if using the television's speakers.
- Do not use in combination with surround effects on other equipment.
- To exit the screen : Press [RETURN].

Selecting how to show 4:3 aspect pictures on the LCD

MONITOR
MODE

Press to select the monitor mode.

NORMAL: Normal

FULL: Stretched horizontally



ZOOM: Stretched vertically and horizontally

OFF: No picture

- If you are not using the LCD on this unit, select "OFF" to conserve power. (The [ON] indicator flashes)
- The LCD turns off automatically if you close it.

Adjusting the picture quality on the LCD

1 PICTURE MODE **2**



Press.

Press [**▲▼**] to select the item, and [**◀▶**] to change the setting.

- To exit the screen : Press [PICTURE MODE].

Changing soundtracks **DVD-V** (with multiple soundtracks) **RAM** **DVD-RW (VR)** **VCD**

AUDIO



Press to select the soundtrack.

(Remote control)



RAM **DVD-RW (VR)** **VCD**

You can use this button to select "L", "R" or "L R".

DVD-V (Karaoke discs)
Press [**◀▶**] to select "On" or "Off" for vocals.
Read the disc's instructions for details.

• To exit the screen : Press [RETURN].

Signal type/data
LPCM/**DD** Digital/DTS/MPEG: Signal type
kHz (Sampling frequency)/bit/ch (Number of channels)
Example: 3/2 1ch

- 1: Low frequency effect (not displayed if there is no signal)
- 0: No surround
- 1: Mono surround
- 2: Stereo surround (left/right)
- 1: Center
- 2: Front left+ Front right
- 3: Front left+ Front right+ Center

Changing subtitles **DVD-V** (with subtitles) **VCD** (SVCD only)

RAM **DVD-RW (VR)**
(On/Off only with discs that contain subtitle on/off information)

SUBTITLE



(Remote control)



DVD-V **VCD**

Press to select the subtitle language.

- On +R/+RW, a subtitle number may be shown for subtitles that are not displayed.

To clear/display the subtitles
Press [**◀▶**] to select "On" or "Off".

RAM **DVD-RW (VR)** Press to select "On" or "Off".

- Subtitle on/off information cannot be recorded using Panasonic DVD Recorders.

• To exit the screen : Press [RETURN].

Angle select **DVD-V** (with multiple angles) / Still picture rotation **JPEG**

ANGLE



(Remote control)

Press to select the angle or rotate the still picture.

e.g. **DVD-V**

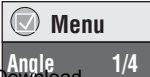

• To exit the screen : Press [RETURN].

Enjoying higher quality audio and video

Multi Re-master

RAM DVD-RW (VR) DVD-V (Discs recorded with 48 kHz only) **VCD CD**

This feature gives you a more natural sound by adding the higher frequency signals not recorded on the disc.

WMA MP3 (Disc recording is other than 8 kHz, 16 kHz or 32 kHz)

This feature reproduces the frequencies lost during recording to give you a sound closer to the original.

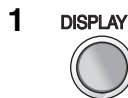

Press once.



- 1 Press [**▲▼**] to select **Other Settings**.
- 2 Press [**▶**] to go to the next menu and [**▲▼**] to select **“Audio Menu”**.
- 3 Press [**▶**] to go to the next menu and [**▲▼**] to select **“Multi Re-master”**.
- 4 Press [**ENTER**] and [**▲▼**] to select **“1”, “2” or “3”**.
- 5 Press [**ENTER**].

• To exit the screen : Press [**RETURN**].

Setting	DVD-V CD (LPCM) Type of music	Other discs Effect level
1	High tempo (e.g., pop and rock)	Light
2	Various tempos (e.g., jazz)	Medium
3	Low tempo (e.g., classical)	Strong
Off	Off	Off

• Multi Re-master may not work when connecting with a digital optical cable (→ page 20).

Picture Mode



Press once.

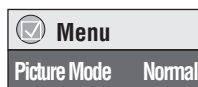

- 1 Press [**▲▼**] to select **Other Settings**.
- 2 Press [**▶**] to go to the next menu and [**▲▼**] to select **“Picture Menu”**.
- 3 Press [**▶**] to go to the next menu and select **“Picture Mode”**.
- 4 Press [**ENTER**] and [**▲▼**] to select **“Normal”, “Cinema1” or “Cinema2”**.
- 5 Press [**ENTER**].

Cinema1: Mellows images and enhances detail in dark scenes.

Cinema2: Sharpens images and enhances detail in dark scenes.

• To exit the screen : Press [**RETURN**].

Program/Random play Remote control only

DVD-V VCD CD WMA MP3 JPEG



While stopped
Press to change.

Program play \longleftrightarrow Random play
Off (Normal play) \longleftarrow

- Disable HighMAT disc play to use random and program play.
Select "Play as Data Disc" in Other Menu. (\rightarrow page 17).

Program play (up to 32 items)

e.g. **DVD-V**

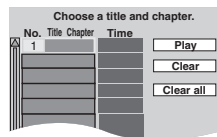

1



Press to select an item 2
(\rightarrow page 9).

Repeat this step to program
other items.

PLAY



Selecting all the items (on the disc or in the title or group)

Press [ENTER] and [\blacktriangle \blacktriangledown] to select "ALL", then press [ENTER] again to register.

Changing the program

Press [\blacktriangle \blacktriangledown] to select an item.

–To change an item, repeat step 1.

–To clear an item, press [CANCEL] (or select "Clear" and press [ENTER]).

Clearing the whole program

Select "Clear all" and press [ENTER]. The whole program is also cleared when the unit is turned off or the disc lid is opened.

Random play

e.g. **DVD-V**

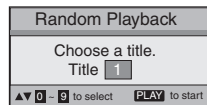

1

DVD-V WMA MP3 JPEG only



Press to select a group
or a title (\rightarrow page 9).

2

PLAY



To exit the program or random mode

Press [PLAYMODE] several times while stopped.

Playing data discs **WMA MP3 JPEG**

You can play JPEG files on DVD-RAM or play HighMAT discs without using the HighMAT function (→ page 17, "Play as Data Disc" in Other Menu).

Playing items in order (Playback Menu) (except JPEG files on DVD-RAM)



While the menu is displayed

Press [**▲▼**] to select "All", "Audio", or "Picture" and press [ENTER].

- To display/exit the screen : Press [TOP MENU].

Playing from the selected item (Navigation Menu)



Press.



Press [**▲▼◀▶**] to select the group and press [ENTER].

- To play content in the group in order:

Press [ENTER].

- To start play from the selected content:

Press [**▲▼**] to select and press [ENTER].

Group and content number currently playing

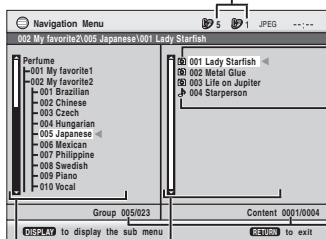

JPEG

WMA/MP3

Number currently selected

Group

Audio/picture contents

- To listen to WMA/MP3 contents while showing a JPEG image on the screen

Select a JPEG file first, and then select WMA/MP3 contents. (The opposite order is not effective.)

- To exit the screen : Press [MENU].

Using the submenu

While the navigation menu (→ see above) is displayed.

Submenu

1 Press [DISPLAY].

2 Press [**▲▼**] to select the submenu (→ see right) and press [ENTER].

Multi	Groups and content
List	Content only
Tree	Groups only
Thumbnail	Thumbnail images JPEG
Next group	To the next group WMA MP3
Previous group	To the previous group WMA MP3
All	WMA/MP3 and JPEG files
Audio	WMA/MP3 files only
Picture	JPEG files only
Help display	To switch between guide messages and the elapsed play time indicator
Find	To search by content or group title (→ see below)

Searching by a content or group title

Press [**◀▶**] to highlight a group title to search a group, or a content title to search its content.

1 Select "Find". (→ see above)

2 Press [**▲▼**] to select a character and press [ENTER].

- Repeat to enter another character.

- Lower case is also searched.

- Press and hold [**◀▶**] to skip between A, E, I, O and U.

- Press [**◀**] to erase a character.

- Erase the asterisk (*) to search for titles starting with that character.



3 Press [**▶**] to select "Find" and press [ENTER]. The search result screen appears.

4 Press [**▲▼**] to select the content or group and press [ENTER].

Playing HighMAT™ discs WMA MP3 JPEG



While the menu is displayed
Press [**▲▼◀▶**] to select items
and press [**ENTER**].



Menu:
Takes you to the next menu which shows playlists or another menu.
Playlist:
Play starts.

- To return to the menu screen, press [**TOP MENU**] then press [**RETURN**] several times.
- To change the menu background, press [**DISPLAY**]. The background changes to the one recorded on the disc.
- To display/exit the screen, press [**TOP MENU**].

Selecting from the list

1. During play, press [**MENU**].
 2. Press [**◀**] then [**▲▼**] to switch among "Playlist", "Group" and "Content" lists.
 3. Press [**▶**] then [**▲▼**] to select an item and press [**ENTER**].
- To exit the screen : Press [**MENU**].

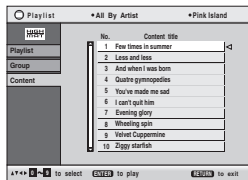

Playing programs/playlists on RAM/DVD-RW (DVD-VR) discs RAM DVD-RW (VR)

- Titles appear only if they have been entered.
- You cannot edit playlists and titles.

1 To play programs:

TOP MENU

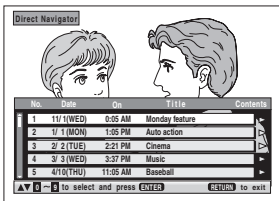

To play playlists:

MENU



2

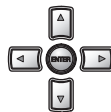

Press [**▲▼**] to select the program or playlist and press [**ENTER**].

- Only when the disc contains a playlist.

- You can also use the **numbered buttons** on the remote control (→ page 9).
- Press [**▶**] to show the contents of the program (Only when playing the program).
- To exit the screen : Press [**TOP MENU**] or [**MENU**].

Playing CD CD

Titles appear with CD text playback.

1

MENU



e.g. CD text

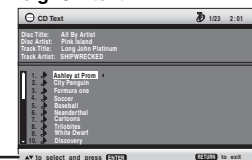

2



Press [**▲▼**] to select the tracks and press [**ENTER**].

- To exit the screen : Press [**MENU**].

Press [**DISPLAY**] to switch between guide messages and the elapsed play time indicator.

Download from www.Softmanuals.com. All Manuals Search And Download.

Using On-Screen Menus

1 **DISPLAY** Press once.



2



① Press [**▲▼**] to select the menu.
② Press [**▶**] to go to the next menu and [**▲▼**] to set.

Repeat step ② if necessary.

- Press [**◀**] to go to the previous menu.
- Items shown differ depending on the type of software.
- There are items which you can select using the **numbered buttons** and [**ENTER**] on the remote control.
- If the setting does not change, press [**ENTER**].
- To finish, press [**RETURN**].

Main menu

Program, Group, Title Chapter, Track, Playlist Content	To start from a specific item
Time	To skip incrementally or decrementally* (Time Slip for play only) 1. Press [ENTER] twice to show Time Slip indicator. 2. Press [▲▼] to select the time and press [ENTER]. • Press and hold [▲▼] to alter faster. To start from a specific time* (Time Search) To change remaining/elapsed time display
Audio	(→ page 11, Changing soundtracks) To display the current bitrate or sampling frequency
Thumbnail	To show thumbnail images
Subtitle	(→ page 11, Changing subtitles)
Marker (VR)	To recall a marker recorded on DVD-Video recorders
Angle	(→ page 11, Angle select)
Rotate Picture	(→ page 11, Still picture rotation)
Slideshow	To turn on/off slideshow To change the slideshow timing (0 to 30 sec)
Other Settings	(→ See below)

* Except +R/+RW

Other Settings

Play Speed	(→ page 10, Changing play speed)
-------------------	----------------------------------

Play Menu (Only when the elapsed play time can be displayed,
JPEG: The Repeat and Marker functions can be used.)

Repeat	(→ page 10, Repeat play)
A-B Repeat	(→ page 10, A-B Repeat)
Marker Except RAM DVD-RW (VR)	To mark up to 5 positions to play again [ENTER] (The unit is now ready to accept markers.) To mark a position: [ENTER] (at the desired point) To mark another position: [◀▶] to select "*" → [ENTER] To recall a marker: [◀▶] → [ENTER] To erase a marker: [◀▶] → [CANCEL] (Remote control) • This feature doesn't work during program and random play. • Markers you add clear when you open the disc lid or switch the unit

Picture Menu

Picture Mode	(→ page 12, Picture Mode)
--------------	---------------------------

Audio Menu

Advanced Surround	(→ page 10, Enjoying virtual surround)
Dialogue Enhancer	To make the dialogue in movies easier to hear DVD-V (Dolby Digital, DTS, 3-channel or over, with the dialogue recorded in the center channel) On ←→ Off
Multi Re-master	(→ page 12, Multi Re-master)

Display Menu

Information	On ←→ Off (JPEG : Off, Date, Details)
Subtitle Position	0 to -60 (in of 2 units)
Subtitle Brightness	Auto, 0 to -7
Just Fit Zoom	RAM DVD-RW (VR) DVD-V VCD To expand the letterbox picture to fit the screen. Press [▲ ▼] to select the preset aspect ratio or "Auto".
Manual Zoom	RAM DVD-RW (VR) DVD-V VCD Press [▲ ▼] for fine adjustments. (Press and hold to alter faster.) -from × 1.00 to × 1.60 (in 0.01 units) -from × 1.60 to × 2.00 (in 0.02 units)
Bitrate Display	RAM DVD-RW (VR) DVD-V VCD On ←→ Off
GUI See-through	On ←→ Off

Other Menu

Setup	(→ page 18, Changing the player settings)
Play as DVD-VR Play as HighMAT or Play as Data Disc	• While stopped, select "Play as Data Disc" to play JPEG files on DVD-RAM or to play a HighMAT disc without using the HighMAT function.

Checking the play status (Elapsed play time indicator)

Press [**DISPLAY**] twice.

Condition—play, pause or slow/search

Current position

Play mode
--- : Normal Play
PGM: Program Play
RND: Random Play
PBC: Playback control play **VCD**

Current playback item

Elapsed time/remaining time
Press [**▲ ▼**] to change. (WMA/MP3/SVCD can only display elapsed time.)

• To exit the screen : Press [**RETURN**].

Changing the player settings

Remote control only

- Referring to pages 18 to 19, change as required.
- Underlined items are the factory presets.

The settings remain intact even if you switch the unit to standby.

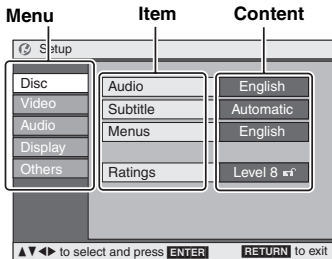

- To return to the previous screen, press [RETURN].
- To finish the SETUP menu, press [SETUP].

“Disc” tab

Audio	<ul style="list-style-type: none"> • <u>English</u> • Other*****^{#3} 	<ul style="list-style-type: none"> • Original ^{#1} 	Language Options <ul style="list-style-type: none"> • French • Italian • Portuguese • French • German • Spanish • Swedish • Spanish • Dutch For Asia
Subtitle	<ul style="list-style-type: none"> • <u>Automatic</u>^{#2} • Other*****^{#3} 	<ul style="list-style-type: none"> • English 	
Menus	<ul style="list-style-type: none"> • <u>English</u> • Other*****^{#3} 		
Ratings Set a ratings level to limit DVD-Video play. • Follow the on-screen instructions.	Setting ratings (When level 8 is selected) <ul style="list-style-type: none"> • <u>8 No Limit</u> • 0 Lock All: To prevent play of discs without ratings levels. When setting a ratings level, a password screen is shown. Follow the on-screen instructions. Do not forget your password. A message screen will be shown if a DVD-Video exceeding the ratings level is inserted in the unit. Follow the on-screen instructions.		

^{#1} The original language designed on the disc is selected.

^{#2} If the language selected for “Audio” is not available, subtitles appear in that language (If available on the disc).

^{#3} Input a code number referring to the table on page 19.

“Video” tab

TV Aspect Choose the setting to suit your television and preference.	<ul style="list-style-type: none"> • <u>4:3 Pan&Scan</u>: Regular aspect television (4:3) The sides of the widescreen picture are cut off so it fills the screen (unless prohibited by the disc). • <u>4:3 Letterbox</u>: Regular aspect television (4:3) Widescreen picture is shown in the letterbox style. • <u>16:9</u>: Widescreen television Use the television's screen modes to change the way the picture is shown. 	
Still Mode Specify the type of picture shown when paused.	<ul style="list-style-type: none"> • <u>Automatic</u> • Field: The picture is not blurred, but picture quality is lower. • Frame: Overall quality is high, but the picture may appear blurred. 	
NTSC Disc Output Choose PAL 60 or NTSC output when playing NTSC discs.	<ul style="list-style-type: none"> • <u>PAL60</u>: When connected to a PAL television • NTSC: When connected to an NTSC television 	

“Audio” tab

PCM Digital Output ^{#1}	Check the digital input limitations of the equipment you connect and select the maximum sampling frequency of PCM digital output. Off: When not connected using a digital optical cable Up to 48 kHz: When connected to equipment compatible with 44.1 or 48 kHz Up to 96 kHz: When connected to equipment compatible with 88.2 or 96 kHz Up to 192 kHz: When connected to equipment compatible with 176.4 or 192 kHz ● Signals from copy-protected discs are converted to 48 or 44.1 kHz. ● Some equipment cannot handle sampling frequencies of 88.2 kHz, even if it can handle 96 kHz. Read your equipment's operating instructions for details.	
Dolby Digital ^{#1}	Bitstream PCM	Select “Bitstream” when the equipment can decode the bitstream (digital form of multi-channel data). Otherwise, select “PCM”. (If the bitstream is output to the equipment without a decoder, high levels of noise can be output and may damage your speakers and hearing.)
DTS Digital Surround ^{#1}	PCM Bitstream	
MPEG ^{#1#2}	PCM Bitstream	
Dynamic Range Compression	● Off ● On:	Adjusts for clarity even when the volume is low through compressing the range of the lowest sound level and the highest sound level. Convenient for late night viewing. (Only works with Dolby Digital).
Audio during Search Choose whether to have sound during search	● On ● Off	

^{#1}Only when connected using a digital optical cable (→ page 20)

^{#2}For Asia MPEG is not available.

“Display” tab

Menu Language	● English ● Français ● Deutsch ● Italiano ● Español ● Português ● Svenska ● Nederlands For Asia ● English ● Français ● Español
On-Screen Messages	● On ● Off

“Others” tab

HighMAT Selects the play method for HighMAT discs	● Enable: Plays as HighMAT ● Disable: Plays as WMA/MP3/JPEG
Re-initialize Setting This returns all values in the Setup menus to the default settings.	● Yes: The password screen is shown if “Ratings” (→ page 18) is set. Please enter the same password and press [ENTER]. When “Initialized” appears on the screen, wait for about 10 seconds. Press [ENTER] and turn the unit off and on again. ● No

Language code list

Abkhazian: 6566	Chinese: 9072	Hindi: 7273	Malagasy: 7771	Samoan: 8377	Tibetan: 6679
Afar: 6565	Corsican: 6779	Hungarian: 7285	Malay: 7783	Sanskrit: 8365	Tigrinya: 8473
Afrikaans: 6570	Croatian: 7282	Icelandic: 7383	Malayalam: 7776	Scots Gaelic: 7168	Tonga: 8479
Albanian: 8381	Czech: 6783	Indonesian: 7378	Maltese: 7784	Serbian: 8382	Turkish: 8482
Ameharic: 6577	Danish: 6865	Interlingua: 7365	Maori: 7773	Serbo-Croatian: 8372	Turkmen: 8475
Arabic: 6582	Dutch: 7876	Irish: 7165	Marathi: 7782	Slovak: 8375	Twi: 8487
Armenian: 7289	English: 6978	Italian: 7384	Moldavian: 7779	Slovenian: 8376	Ukrainian: 8575
Assamese: 6583	Esperanto: 6979	Japanese: 7465	Mongolian: 7778	Shona: 8378	Urdu: 8582
Aymara: 6589	Estonian: 6984	Javanese: 7487	Nauru: 7865	Sindhi: 8368	Uzbek: 8590
Azerbaijani: 6590	Faroese: 7079	Kannada: 7578	Nepali: 7869	Singhalese: 8373	Vietnamese: 8673
Bashkir: 6665	Fiji: 7074	Kashmiri: 7583	Norwegian: 7879	Slovak: 8375	Volapük: 8679
Basque: 6985	Finnish: 7073	Kazakh: 7575	Oriya: 7982	Slovenian: 8376	Welsh: 6789
Bengali; Bangla: 6678	French: 7082	Kirghiz: 7589	Pashto, Pushto: 8083	Somali: 8379	Wolof: 8779
Bhutanian: 6890	Galician: 7176	Kurdish: 7585	Persian: 7065	Sundanese: 8385	Xhosa: 8872
Bihari: 6672	Georgian: 7565	Laotian: 7679	Polish: 8076	Swahili: 8387	Yiddish: 7473
Breton: 6682	German: 6869	Latin: 7665	Portuguese: 8084	Swedish: 8386	Yoruba: 8979
Bulgarian: 6671	Greek: 6976	Latvian, Lettish: 7686	Punjabi: 8065	Tagalog: 8476	Zulu: 9085
Burmese: 7789	Greenlandic: 7576	Lingala: 7678	Quechua: 8185	Tajik: 8471	
Byelorussian: 6669	Guarani: 7178	Lithuanian: 7684	Rhaeto-Romance: 8277	Tamil: 8465	
Cambodian: 7577	Gujarati: 7185	Macedonian: 7775	Romanian: 8279	Tatar: 8484	
Catalan: 6765	Hausa: 7265	Russian: 8285	Telugu: 8469	Thai: 8472	

Download from www.Somanuals.com. All Manuals Search And Download.

Using this unit with other equipment

Turn off all equipment before connecting and read the appropriate operating instructions.

Enjoying with 5.1ch audio

Left side of this unit



Digital optical cable (not included)

- Do not bend sharply.
- Align and insert.

Amplifier with a built-in decoder or a decoder-amplifier combination



OPTICAL IN



Connect the 6 speakers to the amplifier's 5.1ch audio output terminals.

- Change "PCM Digital Output", "Dolby Digital", "DTS Digital Surround" and "MPEG" (→ page 19).

* For Asia MPEG is not available.

Enjoying stereo audio

Left side of this unit



Audio cable (not included)

Black

Amplifier/System component

White → L

AUDIO IN

Red → R

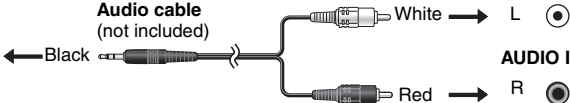

Television connections

Connect the video output from this unit directly to the television.

Television

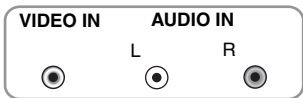

Yellow White Red

Yellow Black

Audio/video cable (included)



Left side of this unit

- The unit's speakers do not have magnetic shielding. Do not place the unit near televisions, personal computers or other devices easily influenced by magnetism. Do not keep this unit and magnetized cards (bank cards, commuter passes, etc.) close together.
- If you raise the volume on the television while playing this unit, the volume may abruptly become very loud when you switch to a television broadcast. Return the volume to its normal level before changing.

For the United Kingdom and Continental Europe

Use the RCAJ adaptor (not included) if your TV has a 21-pin SCART terminal.

RCAJ adaptor (not included)

To the television's 21-pin SCART terminal

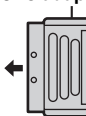

red

white

yellow

black

yellow

To [AUDIO/OPT OUT]

To [VIDEO]

Audio/video cable (included)

Download from Www.Somanuals.com. All Manuals Search And Download.

When using in a car

Do not leave the unit on a surface that may become hot such as a dashboard. The unit is not heat-resistant so may malfunction.

The driver must not operate this unit while the vehicle is moving.
Do not operate this unit where it can be viewed by the driver.
Driver operation or viewing of this unit while the vehicle is moving will cause distraction which may result in serious accident and personal injury or property damage.

DVD-LS85

Car DC Adaptor is **not included**. (Included rechargeable battery pack can be used.)

DVD-LS90 **DVD-LS87** Use included Car DC Adaptor. (→ see below)

■ Connections

Before connection, consult your car owner's manual or your dealer.

- Connect to the cigarette lighter socket of a vehicle that has a 12 V battery. It is not compatible with a vehicle that has a 24 V battery.
- This is a special negative grounded Car DC Adaptor. Using this Car DC Adaptor with a plus grounded car can cause malfunction and lead to fire.

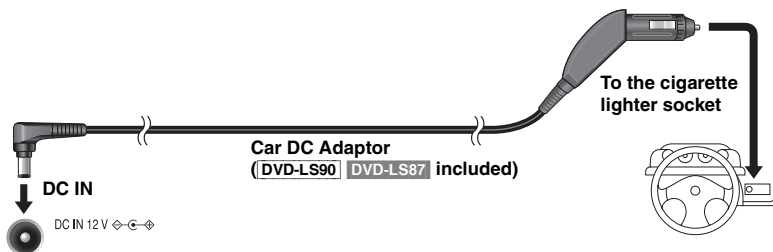

Left side of this unit (Place the unit on a stable surface.)

■ Replacing the fuse

Replace only with the specified 125 V/250 V, 2.5 A fuse. Use of any other type can cause fire.

2 Replace the fuse. (125 V/250 V, 2.5 A type)



■ Cautions

● To avoid draining your car battery

- Disconnect the Car DC Adaptor from the cigarette lighter after use. The Car DC Adaptor continues to consume some power even if it is not being used, and if a battery pack is attached to this unit, it will start recharging which uses more power.
- Do not use the Car DC Adaptor for long periods when the engine is not running.
- The Car DC Adaptor cannot be used to recharge the battery pack. Use the AC adaptor included with this unit.
- When starting an engine, pull Car DC Adaptor out of the cigarette lighter socket. Mishandling of the Car DC Adaptor can cause malfunction.
- No responsibility will be taken for damage that occurs due to faulty installation.
- Leave some slack in the cord.

DVD-LS90 **DVD-LS87** **DVD-LS85**



You can enjoy audio through your car audio system by connecting a car stereo cassette adaptor (not included: RP-CC20) to the headphone jack on the left side of this unit.

Frequently asked questions

Reference pages are shown in parentheses.

What kind of equipment is necessary to enjoy 5.1ch audio?	Connect to an AV amplifier with a built-in decoder that has 5.1ch audio output terminals. (20)
Can I play a DVD-Video bought in another country?	You can only play DVD-Video if their region number is the same or includes the same region number as the unit or if the DVD-Video is marked "ALL". Confirm the region number for the unit on the bottom panel. Check the disc jacket. (Cover)
Can I use on an airplane or in a hospital?	Electromagnetic waves that are emitted from this unit may affect equipment on an airplane or in a hospital. Please obey the rules and/or instructions indicated by the hospital or airline.
Can I use in a car?	DVD-LS90 DVD-LS87 Use included Car DC Adaptor. (21) DVD-LS85 Car DC Adaptor is not included . (Included rechargeable battery pack can be used.) Damage may occur if you do not use the specified Car DC Adaptor.
Can I connect with a computer?	You can enjoy use of the computer as a television monitor when connecting with the AV input terminal on a computer. However, you cannot operate this unit as peripheral equipment.

Tips for making WMA/MP3 and JPEG discs (For CD-R/CD-RW)

- Discs must conform to ISO9660 level 1 or 2 (except for extended formats).
- This unit is compatible with multi-session but if there are a lot of sessions it takes more time for play to start. Keep the number of sessions to a minimum to avoid this.
- If groups were created away from the root like "002 group" in the illustration below, the eighth one and onwards are displayed on the same vertical line in the menu screen.
- There may be differences in the display order on the menu screen and computer screen.
- This unit cannot play files recorded using packet write.

Naming folders and files

(Files are treated as content and folders are treated as groups on this unit.)

At the time of recording, prefix folder and file names. This should be with numbers that have an equal number of digits, and should be done in the order you want to play them (this may not work at times).

Files must have the extension:

"WMA" or ".wma"

"MP3" or ".mp3"

".JPG", ".jpg", ".JPEG" or ".jpeg"

WMA

- You cannot play WMA files that are copy protected.
- This unit is not compatible with Multiple Bit Rate (MBR: a file that contains the same content encoded at several different bit rates).

MP3

- This unit is not compatible with ID3 tags.
- Compatible sampling rate: 8, 11.02, 12, 16, 22.05, 24, 32, 44.1, and 48 kHz

JPEG

- JPEG files taken on a digital camera that conform to the DCF Standard Version 1.0 are displayed.
 - Pictures taken using digital camera functions not supported by DCF like automatic picture rotation may not be displayed.
 - Files that have been altered, edited or saved with computer picture editing software may not be displayed.
- This unit cannot display moving pictures, MOTION JPEG and other such formats, still pictures other than JPEG (e.g. TIFF) or play pictures with attached audio.

Download from Www.Somanuals.com. All Manuals Search And Download.

e.g. **MP3**

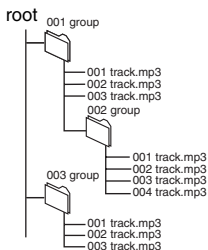

Specifications

Operating temperature range:

+5 to +35 °C

Operating humidity range:

5 to 85 % RH (no condensation)

Discs played (8 cm or 12 cm):

- (1) DVD (DVD-Video)
- (2) DVD-RAM (DVD-VR, JPEG^{#4,5})
- (3) DVD-R (DVD-Video)
- (4) DVD-RW (DVD-Video, DVD-VR)
- (5) +R/RW (Video)
- (6) CD, CD-R/RW [CD-DA, Video-CD, SVCD^{#1}, MP3^{#2,5}, WMA^{#3,5}, JPEG^{#4,5}, HighMAT Level 2 (Audio and Image)]

Signal system: PAL/PAL60 (NTSC) selectable

LCD screen: 9" α -Si, TFT wide-screen LCD

Composite-video output:

Output level: 1 Vp-p (75 Ω)
Output terminal: Mini-jack
Number of terminals: 1 system

Audio output:

Output level: 1.5 Vrms (1 kHz, 0 dB, 10 k Ω)
Output terminal: Stereo mini-jack
Number of terminals: 1 system

Audio performance:

- (1) Frequency response:
 - DVD (linear audio):
4 Hz to 22 kHz (48 kHz sampling)
4 Hz to 44 kHz (96 kHz sampling)
 - CD audio: 4 Hz to 20 kHz
- (2) S/N ratio:
 - CD audio: 115 dB
- (3) Dynamic range:
 - DVD (linear audio): 98 dB
 - CD audio: 97 dB
- (4) Total harmonic distortion:
 - CD audio: 0.008 %

Digital audio output:

Optical digital output: Mini optical terminal
Number of terminals: 1 system
(also used for audio output)

Pickup:

Wave length: 662 nm/785 nm (DVD/CD)
Laser power: CLASS 3B/CLASS 3B (DVD/CD)

Power supply: DC 12 V (DC IN terminal)/
DC 7.2 V (Exclusive battery terminal)

Power consumption (using included AC adaptor):
13 W (Unit only: 10 W)

Power consumption in Standby mode

(using included AC adaptor):

approx. 0.5 W

Power consumption in Recharge mode

(using included AC adaptor):

13 W

AC adaptor:

Power source: AC 100 to 240 V, 50/60 Hz

Power consumption: 28 W

DC output: 12 V, 1.5 A

Car DC Adaptor

(DVD-LS90 | DVD-LS87 included):

DC input: 12 V, 20 W

DC output: 12 V, 1.5 A

Battery pack (lithium ion)

CGR-H702 (DVD-LS90 included):

Voltage: 7.2 V

Capacity: 4700 mAh

CGR-H701 (DVD-LS87 | DVD-LS85 included):

Voltage: 7.2 V

Capacity: 2150 mAh

Dimensions (W×D×H)

(excluding protrusions and battery):

DVD-LS90: 235.4 mm×178.6 mm×39.0* mm

*29.9 mm at lowest point

(D=185 mm including battery)

(H=51.5 mm including battery)

DVD-LS87 | DVD-LS85:

235.4 mm×178.6 mm×39.0* mm

*29.9 mm at lowest point

(D=179.3 mm including battery)

(H=46.7 mm including battery)

Mass (including battery):

DVD-LS90: 1097 g

DVD-LS87 | DVD-LS85: 999 g

Note

Specifications are subject to change without notice. Mass and dimensions are approximate.

^{#1} Conforming to IEC62107

^{#2} Compatible compression rate: between
32 kbps and 320 kbps

^{#3} Compatible compression rate: between
48 kbps and 320 kbps

^{#4} Exif Ver 2.1 JPEG Baseline files
Picture resolution: between 320×240 and
6144×4096 pixels (Sub sampling is 4:2:2 or
4:2:0)

^{#5} The total combined maximum number of
recognizable audio and picture contents and
groups: 4000 audio and picture contents and
400 groups.

Troubleshooting guide

Before requesting service, make the following checks. If you are in doubt about some of the check points, or if the remedies indicated in the chart do not solve the problem, consult your dealer for instructions. (Reference pages are shown in parentheses.)

The following do not indicate malfunction.

- Sound from the AC adaptor during recharging.
- The battery pack warming up when recharging or during use.
- The surface and area around the unit becoming warm when used for long periods.

Power

No power.	<ul style="list-style-type: none"> ● Check connections to the AC adaptor or battery pack. (6) ● You cannot turn on the unit with the remote control if the unit is powered by the battery pack. ● The unit has protection circuitry that is activated if it becomes too hot or too cold. The unit will not work if this occurs. Use the unit between 5 °C and 35 °C .
Unit turns off automatically.	<ul style="list-style-type: none"> ● The unit turns off after it has been stopped for about 15 minutes (5 minutes when the unit is powered by the battery pack) to conserve power. Turn the unit on again.
Cannot charge or the [CHG] indicator fails to light.	<ul style="list-style-type: none"> ● The battery pack can only be recharged when the unit is off. ● The charging time increases when the temperature is too hot or too cold, and charging may not be possible under some circumstances. ● Check connections to the AC adaptor or battery pack. (6)
Play time dramatically reduced after recharging.	<ul style="list-style-type: none"> ● The battery pack has reached the end of its service life (It can be recharged about 300 times).

No operation

No response when any buttons pressed.	<ul style="list-style-type: none"> ● This unit cannot play discs other than the ones listed in these operating instructions. (5) ● The unit may not be operating properly due to lightning, static electricity or some other external factor. Turn the unit off and then back to ON. Alternatively, turn the unit off, disconnect the power source (AC or battery pack), and then reconnect it. ● Condensation has formed: Wait 1 to 2 hours for it to evaporate.
No response when remote control buttons pressed.	<ul style="list-style-type: none"> ● Check that the battery is installed correctly. (7) ● The battery is depleted: Replace it with new one. (7) ● Point the remote control at the remote control sensor and operate. (7)
You have forgotten your ratings password. Reset all the settings to Factory Preset.	<ul style="list-style-type: none"> ● While stopped, press and hold [◀◀] and [■] on the unit and then also press and hold [▶, ON] on the unit until "Initialized" disappears from the screen. Turn the unit off and on again. All settings will return to the default values.
No picture or sound.	<ul style="list-style-type: none"> ● Check that the disc has something recorded on it.

Specific operation impossible or incorrect

It takes time before play starts. [MP3]	<ul style="list-style-type: none"> ● Play may take time to begin when an MP3 track has still picture data. Even after the track starts, the correct play time will not be displayed; however, this is normal.
The program and random play functions do not work. [DVD-V]	<ul style="list-style-type: none"> ● These functions do not work with some DVD-Videos.
Menu doesn't appear. [VCD] with playback control	<ul style="list-style-type: none"> ● Press [■] twice and then press [▶] (PLAY).
Subtitle position is wrong.	<ul style="list-style-type: none"> ● Adjust the position. ("Subtitle Position" in Display Menu) (17)
No subtitles.	<ul style="list-style-type: none"> ● Display the subtitles. (11)
In A-B repeat, point B is automatically set.	<ul style="list-style-type: none"> ● The end of an item becomes point B when it is reached.
Play doesn't start. [VMA]	

Picture incorrect

No picture on the LCD.	<ul style="list-style-type: none"> Select a monitor mode other than "OFF" (no picture). (11, Selecting how to show 4:3 aspect pictures on the LCD)
The LCD is dark.	<ul style="list-style-type: none"> Adjust the brightness. (11, Adjusting the picture quality on the LCD)
LCD pixels turn black or radiate different colors.	<ul style="list-style-type: none"> The LCD is constructed with precision technology so 99.99 % of the pixels are active, but of the remaining of 0.01 %, there are pixels that may be black or emit light constantly. This phenomenon is not a malfunction.
Picture doesn't appear on the television (or the size of the picture seems wrong).	<ul style="list-style-type: none"> Check connections. (20) Check that the television is on. Check that the input mode on the television is correct. Check the settings in "Video—TV Aspect". (18) Turn off the zooming feature on your television if you are using Zoom. (17) Ensure that the unit is connected directly to the television, and is not connected through a video cassette recorder. (20)
Menu not displayed correctly.	<ul style="list-style-type: none"> Restore the zoom ratio to $\times 1.00$. (17) Set "Subtitle Position" in Display Menu to "0". (17)
Auto zoom function does not work well.	<ul style="list-style-type: none"> Use the other preset aspect ratios or manual adjustment. (17) Zoom function may not work well, especially in dark scenes and may not work depending on the type of disc.

Sound incorrect

Sound distorted.	<ul style="list-style-type: none"> Select "Off" in "Advanced Surround". (10) Move unit away from mobile phones. Noise may occur when playing WMA files.
Piercing noise comes from the speakers.	<ul style="list-style-type: none"> If you have connected a digital amplifier which does not include decoder, be sure to select "PCM" in "Dolby Digital", "DTS Digital Surround" or "MPEG*" in "Audio" tab. (19)
Effects do not work.	<ul style="list-style-type: none"> None of the audio effects work when the unit is connected through the digital optical cable and is outputting bitstream signals. (20) Some audio effects do not work or have less effect with some discs. Advanced Surround and Multi Re-master do not work if you have changed the play speed.
No sound from the unit's speaker.	<ul style="list-style-type: none"> The speaker is off if the LCD is closed or headphones are connected. Turn up the volume. (8)
No sound from other speakers.	<ul style="list-style-type: none"> Check all connections and settings. (20)
No sound when you change the play speed.	<ul style="list-style-type: none"> There may be a pause in sound.

* For Asia MPEG is not available.

Recording

Cannot record to digital recording equipment. (Incorrect sound recorded.)	<ul style="list-style-type: none"> You cannot record WMA/MP3. You cannot record DVDs that have protection preventing digital recording. You cannot record DVDs if the recording equipment cannot handle signals with a sampling frequency of 48 kHz. Make the following settings: <table border="0" style="margin-left: 20px;"> <tr> <td>– Advanced Surround:</td> <td style="text-align: right;">Off (10)</td> </tr> <tr> <td>– PCM Digital Output:</td> <td style="text-align: right;">Up to 48 kHz (19)</td> </tr> <tr> <td>– Dolby Digital/DTS Digital Surround/MPEG*:</td> <td style="text-align: right;">PCM (19)</td> </tr> </table> 	– Advanced Surround:	Off (10)	– PCM Digital Output:	Up to 48 kHz (19)	– Dolby Digital/DTS Digital Surround/MPEG*:	PCM (19)
– Advanced Surround:	Off (10)						
– PCM Digital Output:	Up to 48 kHz (19)						
– Dolby Digital/DTS Digital Surround/MPEG*:	PCM (19)						

* For Asia MPEG is not available.

Troubleshooting guide

Displays

☹	<ul style="list-style-type: none"> The operation is prohibited by the unit or disc.
No On-Screen display. "Check the disc."	<ul style="list-style-type: none"> Select "On" for "On-Screen Messages" in "Display" tab. (19) Clean the disc. (Below)
"■■■■ ERROR 01"	<ul style="list-style-type: none"> A problem has occurred with the battery pack. Consult your dealer.
"■■■■ ERROR 02"	<ul style="list-style-type: none"> The battery pack has been recharging for 12 hours but has failed to recharge for some reason. Recharge again.
"■■■■ ERROR 03"	<ul style="list-style-type: none"> You are recharging in a location that is too hot or too cold. Recharge at normal temperature (+5 to +35 °C).
"H □□" □□ stands for a number.	<ul style="list-style-type: none"> Trouble has occurred. The number appearing after "H" depends on the problem. Turn the unit off and on again. Alternatively, turn the unit off, disconnect the power source (AC or battery pack), reconnect the power and turn the unit on again. If the service numbers fail to clear, note the service numbers and consult your dealer.
"Cannot display group xx, content xx"	<ul style="list-style-type: none"> You are trying to play incompatible groups or content. (22)

[⏻] and [CHG] indicators

The [⏻] indicator flashes rapidly.	<ul style="list-style-type: none"> The unit has malfunctioned. Consult your dealer.
The [⏻] indicator flashes slowly.	<ul style="list-style-type: none"> The unit is on and the LCD is closed or the monitor mode is set to "OFF" (no picture). Turn the unit off when you have finished.
The [CHG] indicator flashes rapidly.	<ul style="list-style-type: none"> There is a problem with the battery pack. Turn the unit on and check the message on the LCD. (Above)
The [CHG] indicator flashes slowly.	<ul style="list-style-type: none"> Battery pack charge is low. The unit will turn off automatically after a few minutes.

Maintenance

To clean this unit, wipe with a soft, dry cloth.

- Use eyeglass cleaner to remove stubborn dirt from the LCD.
- Never use alcohol, paint thinner or benzine to clean this unit.

Maintenance of the lens

- Remove dust carefully with an air blower for camera lenses (optional).
- Recommended product: Lens cleaner kit (SZZP1038C) (Available from Panasonic dealers.)
- You cannot use a CD type lens cleaner.
- Be careful not to touch the lens with your fingers.

To clean discs

Wipe with a damp cloth and then wipe dry.



Disc handling precautions

- Do not attach labels or stickers to discs (This may cause disc warping, rendering it unusable).
- Do not write on the label side with a ball-point pen or other writing instrument.
- Do not use record cleaning sprays, benzine, thinner, static electricity prevention liquids or any other solvent.
- Do not use scratch-proof protectors or covers.
- Do not use the following discs:
 - Discs with exposed adhesive from removed stickers or labels (rented discs etc).
 - Discs that are badly warped or cracked.
 - Irregularly shaped discs, such as heart shapes.

Manufactured under license from Dolby Laboratories. "Dolby" and the double-D symbol are trademarks of Dolby Laboratories.

"DTS" and "DTS 2.0 + Digital Out" are trademarks of Digital Theater Systems, Inc.

This product incorporates copyright protection technology that is protected by method claims of certain U.S. patents and other intellectual property rights owned by Macrovision Corporation and other rights owners. Use of this copyright protection technology must be authorized by Macrovision Corporation, and is intended for home and other limited viewing uses only unless otherwise authorized by Macrovision Corporation. Reverse engineering or disassembly is prohibited.

MPEG Layer-3 audio decoding technology licensed from Fraunhofer IIS and Thomson multimedia.

HighMAT™ and the HighMAT logo are either trademarks or registered trademarks of Microsoft Corporation in the United States and/or other countries.



Windows Media, and the Windows logo are trademarks, or registered trademarks of Microsoft Corporation in the United States and/or other countries.



WMA is a compression format developed by Microsoft Corporation. It achieves the same sound quality as MP3 with a file size that is smaller than that of MP3.

-If you see this symbol-

Information on Disposal for Users of Waste Electrical & Electronic Equipment (private households)



This symbol on the products and/or accompanying documents means that used electrical and electronic products should not be mixed with general household waste.

For proper treatment, recovery and recycling, please take these products to designated collection points, where they will be accepted on a free of charge basis. Alternatively, in some countries you may be able to return your products to your local retailer upon the purchase of an equivalent new product. Disposing of this product correctly will help to save valuable resources and prevent any potential negative effects on human health and the environment which could otherwise arise from inappropriate waste handling. Please contact your local authority for further details of your nearest designated collection point. Penalties may be applicable for incorrect disposal of this waste, in accordance with national legislation.

For business users in the European Union

If you wish to discard electrical and electronic equipment, please contact your dealer or supplier for further information.

Information on Disposal in other Countries outside the European Union

This symbol is only valid in the European Union.

If you wish to discard this product, please contact your local authorities or dealer and ask for the correct method of disposal.

Main feature index

To select the content to **repeat** (→ page 10)

To enjoy **virtual surround** (→ page 10)

To adjust the **picture quality** (→ page 11)

To select how to **show 4:3 aspect pictures**
(→ page 11)

Shows a **disc top menu** (→ page 9)

Shows a **program list** (→ page 15)

Shows **On-Screen Menus** (→ page 16)

Shows a **disc menu** (→ pages 9, 14)

Shows a **playlist** (→ page 15)

Adjusts the **volume** (→ page 8)

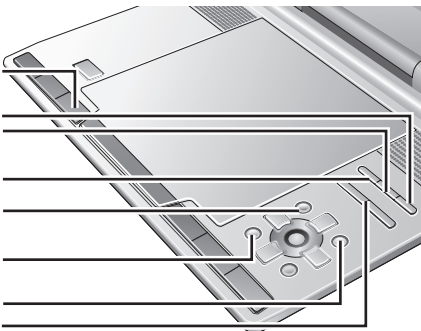

Shows a **disc top menu** (→ page 9)

Shows a **program list** (→ page 15)

Adjusts the **volume** (→ page 8)

Shows a **disc menu** (→ pages 9, 14)

Shows a **playlist** (→ page 15)

Changes **angles** (→ page 11)

Still picture rotation (→ page 11)

Changes **subtitles** (→ page 11)

Changes **soundtracks** (→ page 11)

program/random play (→ page 13)

Clears an **item** (→ page 13)

Shows **On-Screen Menus** (→ page 16)

CAUTION - VISIBLE AND INVISIBLE LASER RADIATION WHEN OPEN AND INTERLOCKS DEFEATED. AVOID EXPOSURE TO BEAM.

VARNING - SYNLLIG OCH OSYNLIG LASERSTRÅLNING NÄR DENNA DEL ÄR ÖPPNAD OCH SPÄRREN ÄR URKOPPLAD. BETRAKTA EJ STRÅLEN.

ADVARSEL - SYNLLIG OG USYNLLIG LASERSTRÅLING VED ÅBNING, NÄR SIKKERHEDSAFBRYDERE ER UDE AF FUNKTION. UNDGÅ UDSÆTTELSE FOR STRÅLING.

ADVARSEL - SYNLLIG OG USYNLLIG LASERSTRÅLING NÄR DEKSEL ÖPPNES OCH SIKKERHEDSLÄS BRYTES. UNNGÅ EKSPONERING FOR STRÅLEN.

VARO! - AVATTAESSA JA SUOJALUKITUS OHITETTAESSA OLET ALLTTIINA NÄKYYVÄÄ JA NÄKYMÄTÖN LASERSÄTEILYLLE. ÄLÄ KATSO SÄTEESEEN.

VORSICHT - SICHTBARE UND UNSICHTBARE LASERSTRAHLUNG, WENN ABDECKUNG GEÖFFNET UND SICHERHEITVERRIEGELUNG ÜBERBRÜCKT. NICHT DEM STRAHL AUSSETZEN.

ATTENTION - RAYONNEMENT LASER VISIBLE ET INVISIBLE DANGEREUX EN CAS D'OUVERTURE ET LORSQUE LA SÉCURITÉ EST NEUTRALISÉE. EXPOSITION DANGÉREUSE AU FAISCEAU.

注意 - 打开时及联锁消除时可见及不可见激光辐射。避免激光束照射。

(Bottom of product)



(Bottom of product)

Matsushita Electric Industrial Co., Ltd.

Web Site: <http://www.panasonic.co.jp/global/>

(En)

RQT8431-B

F0805UM0

Download from www.Somanuals.com. All Manuals Search And Download.

Free Manuals Download Website

<http://myh66.com>

<http://usermanuals.us>

<http://www.somanuals.com>

<http://www.4manuals.cc>

<http://www.manual-lib.com>

<http://www.404manual.com>

<http://www.luxmanual.com>

<http://aubethermostatmanual.com>

Golf course search by state

<http://golfingnear.com>

Email search by domain

<http://emailbydomain.com>

Auto manuals search

<http://auto.somanuals.com>

TV manuals search

<http://tv.somanuals.com>