

Panasonic®

松下電器

Removable Full Front CD player/
Receiver with CD Changer Control

可攜帶式面板並附有換片機控制器的CD收音／收音機

CQ-DF302W Operating Instructions

使用說明書

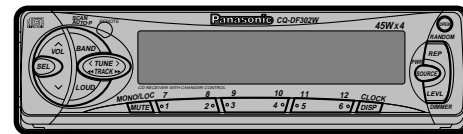

- Please read these instructions carefully before using this product and save this manual for future use.
- 使用本產品前，請務必閱讀這些說明並將本說明書保管好以備將來之用。

Panasonic welcomes you to our ever growing family of electronic product owners. We know that this product will bring you many hours of enjoyment. Our reputation is built on precise electronic and mechanical engineering, manufactured with carefully selected components and assembled by people who take pride in their work. Once you discover the quality, reliability, and value we have built into this product, you too will be proud to be a member of our family.

☐ Use this Product Safely

When Driving

Keep the volume level low enough to be aware of road and traffic conditions.

When Car Washing

Do not expose the product, including the speakers and CDs, to water or excessive moisture. This could cause electrical shorts, fire, or other damage.

When Parked

Parking in direct sunlight can produce very high temperatures inside your car. Give the interior a chance to cool down before switching the unit on.

Use the Proper Power Supply

This product is designed to operate with a 12 V DC, negative ground battery system.

Disc Mechanism

Do not insert coins or any small objects. Keep screwdrivers and other metallic objects away from the disc mechanism and disc.

Use Authorized Servicenters

Do not attempt to disassemble or adjust this precision product. Please refer to the Servicenter list including with this product for service assistance.

For Installation

This product should be installed in a horizontal position with the front end up at a convenient angle, but not more than 30°.

☐ Components

- Operating instructions 1
- Installation hardware.....1 set (⇒ page 19)
- Power connector 1
- Remote control unit 1
- Lithium battery (CR2025)..... 1

Power and Sound Controls

Power

Turn the key in the ignition until the accessory indicator lights.
 Power on: Press [SOURCE] (PWR).
 Power off: Press [SOURCE] (PWR) again and hold.

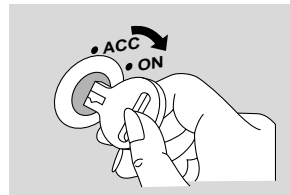

Note:

- When the power is switched on for the first time, a demonstration message appears on the display.
 To cancel this display, press [DISP].

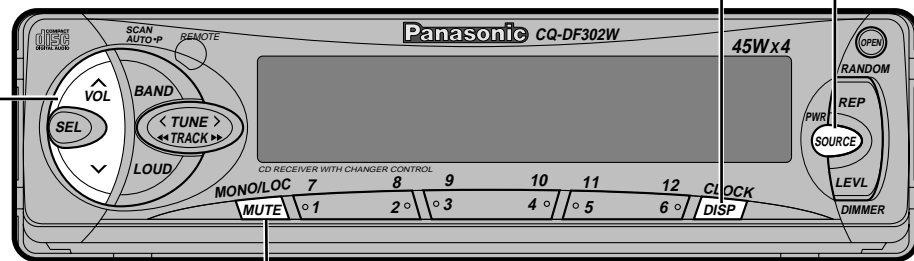

Volume

[**"** VOL]: Up
 [**#** VOL]: Down
 Press and hold for rapid adjustment.



Mute

Press [MUTE] to mute the sound completely.



Press [MUTE] again to cancel.

Anti-volume-blast circuit:

When the power is switched off and on again, the volume slowly rises to the previous level. The anti-volume-blast circuit will not work when the volume level is set lower than position 20 on the display.

Loudness

Press [LOUD] to enhance bass and treble tones at low or medium volume.



Press [LOUD] again to cancel.

Level Meter

When the power is on, the level of sound sources, such as radio and CD, is displayed. Press [LEVL] to change the level meter display.

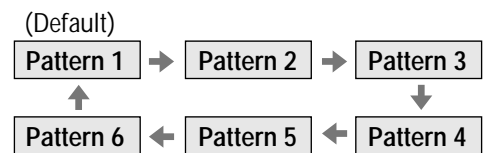

Dimmer

Press and hold [LEVL] (DIMMER) for more than 2 seconds to change the dimmer level.

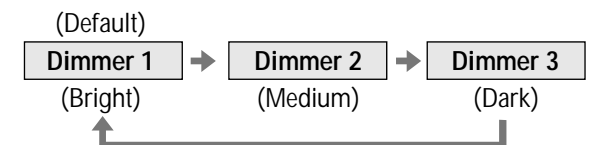

Power and Sound Controls (Continued)

Audio Mode (Bass/Treble/Balance/Fader/Subwoofer)

1 Press [SEL] to select the audio mode.

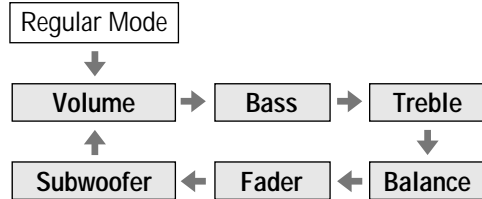

Note:
 • If no operation takes place for more than 5 seconds in audio mode (2 seconds in volume mode), the display returns to the regular mode.

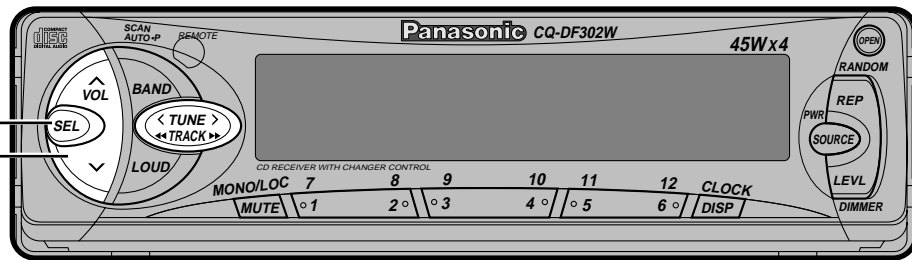

2 Press [" VOL] or [# VOL] to change each level.

Bass:



Adjustable range: -12 dB to +12 dB

Treble:



Adjustable range: -12 dB to +12 dB

Balance:

R (right speaker) or L (left speaker)



Adjustable range: 1 to 15 Balance center

Fader:

F (front speaker) or R (rear speaker)



Adjustable range: 1 to 15 Fader center

Subwoofer volume:



Subwoofer volume level: Default
 From MUTE (0) to 8

Clock Basics

The 12-hour system is used for the clock.

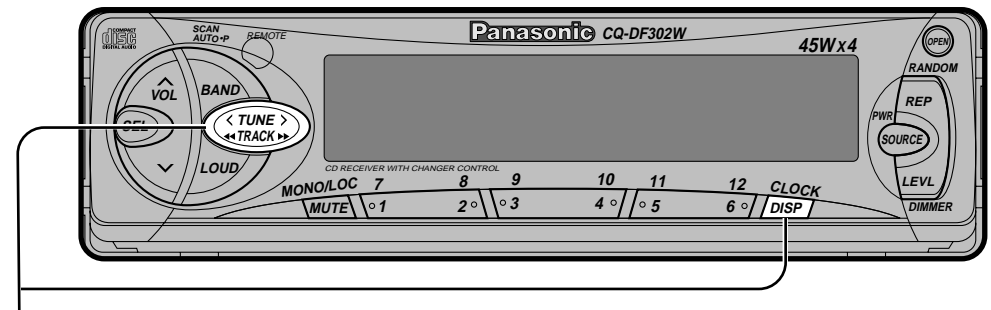

Initial Time

1 Press [DISP] (CLOCK).



Hours

2 Press and hold [DISP] (CLOCK).



3 Press [% TUNE] or [\$ TUNE].



Minutes

4 Press [DISP] (CLOCK).



5 Press [% TUNE] or [\$ TUNE].



6 Press [DISP] (CLOCK).



Note:

• Press and hold [% TUNE] or [\$ TUNE] to change numbers rapidly.

Clock Display

Press [DISP] (CLOCK) to switch to the clock display.

In tuner mode:



In CD player (changer) mode:

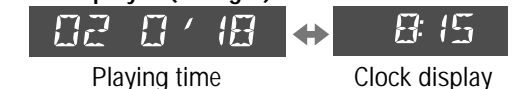

Note:

• The [DISP] (CLOCK) button will not work while the CD player or CD changer is set to the scan play mode. Cancel the scan play mode before pressing [DISP] (CLOCK).

Time Reset

Press and hold [DISP] (CLOCK) for more than 2 seconds to activate the time setting mode to reset the time.
 Then, repeat steps 3 to 6.

Radio Basics

1 Mode Selection

Press [SOURCE] to change to the radio mode.

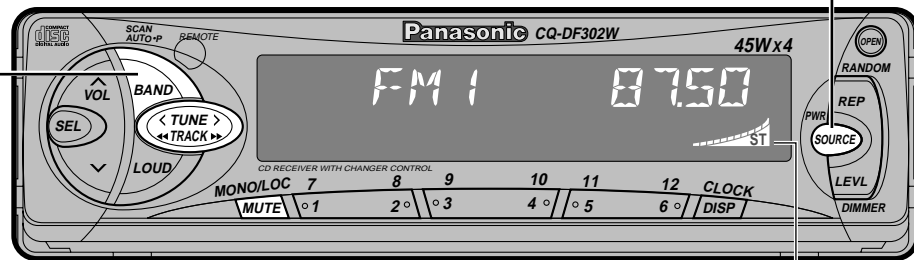
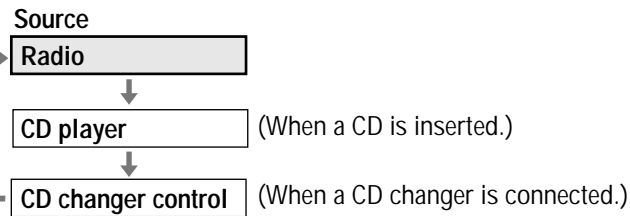

FM stereo indicator

2 Band

Press [BAND] to change the band.

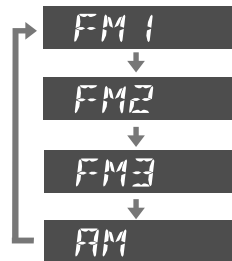

3 Manual Tuning

[\$ TUNE]: Higher frequency
[% TUNE]: Lower frequency

Seek Tuning

Press and hold ...
[\$ TUNE]: Higher frequency
[% TUNE]: Lower frequency
Tuning will automatically stop when the signals of the next broadcast station are received.

4 Mono/Local Selection

MONO: Noise is significantly decreased when weak signals are received from an FM broadcast station.

LOCAL: Only strong signals of stations are searched in seek tuning, while at the LOCAL OFF setting, relatively weak signals are also searched.

FM broadcast:
Press and hold [MUTE] (MONO/LOC) to change the mode.
Release when the desired mode.

AM broadcast:
Press and hold [MUTE] (MONO/LOC) to switch LOCAL mode on and off.

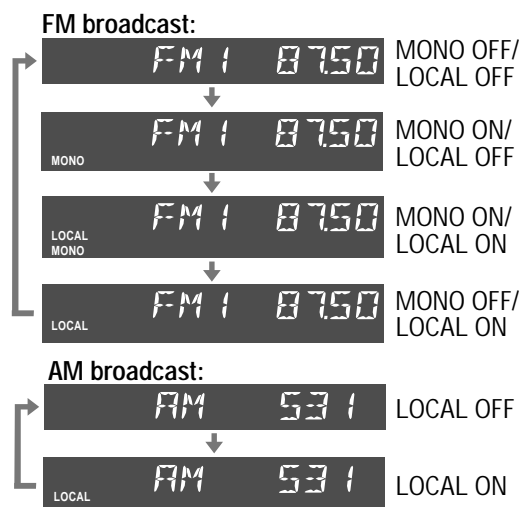

Preset Station Setting

Up to 6 stations each can be saved in the FM1, FM2, FM3 and AM preset station memories.

Caution:
• To ensure safety, never attempt to preset stations while you are driving.

1 Band

Press [BAND] to select a desired band.
(→ page 14)

Preset number

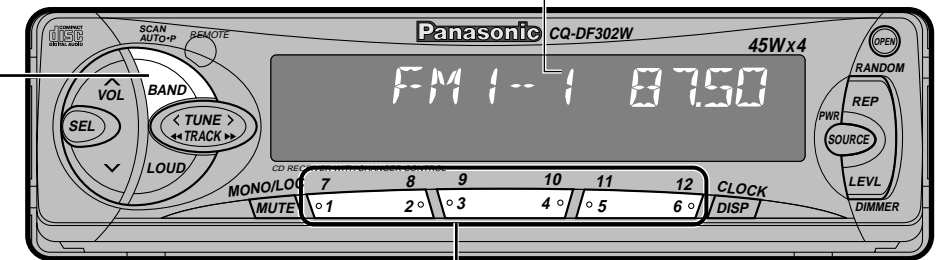

2 Auto Station Preset

Press and hold [BAND] (AUTO•P) for more than 2 seconds (auto preset memory).
• The 6 strongest available stations will be automatically saved in the memory under preset buttons from [1] to [6].
• Once set, the preset stations are sequentially scanned for 5 seconds each.

Note:
• The stations manually preset on the selected band will be deleted.

Manual Station Preset

- Use manual or seek tuning to find a station. (→ page 14)
- Press and hold one of the preset buttons [1] to [6] until the display blinks once.

3 Tuning in a Preset Station

Press the corresponding preset button [1] to [6] to tune in a preset station.

Note:
• You can change the memory presetting by repeating the above procedure.

CD Player and CD Changer

Cautions:

- Only 12 cm CD, CD-DA data recorded CD-R and CD-RW discs are available for this unit.
- This unit does not support CD text display.
- This unit does not support MP3 disc playback.
- Refer to page 30 for this unit.
- This unit is not designed for any 8 cm CD.
- If you insert an 8 cm CD and can not eject it, turn ACC of your car off once and turn it on again, then press [▲] (EJECT).

Disc Insert and Playback

1 Open the front panel.
Press [OPEN] to open the front panel.

2 Insert the disc.
Playback will start automatically after the unit recognized the loaded disc as an ordinary music CD. (When a CD-R or CD-RW which has CD-DA formatted data as the same as an ordinary CD is loaded, this unit recognizes it as an ordinary music CD.)
Close the front panel manually.

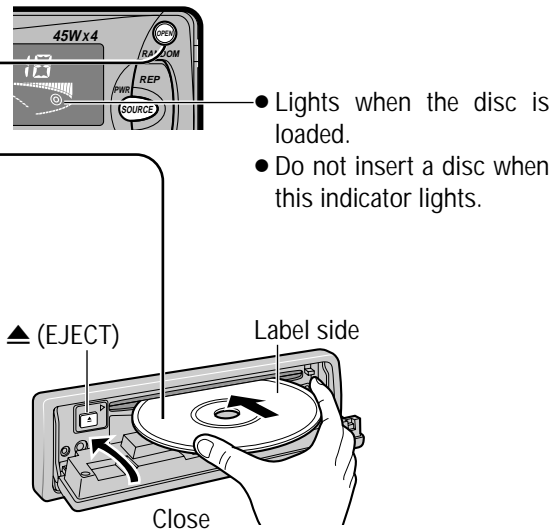

When CD is in the player
Press [SOURCE] to change to CD play mode.

Stop and Disc Eject

Press [▲] (EJECT) to stop CD play and eject the disc.

Listening to a CD

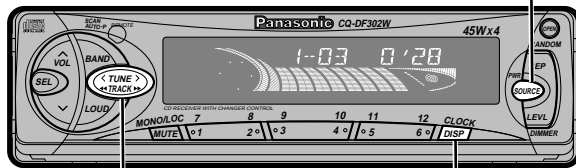

Mode Selection

Press [SOURCE] to change to the CD player or CD changer mode.

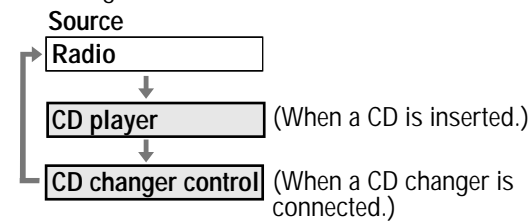

Display Change

Press [DISP] to switch to the clock display.

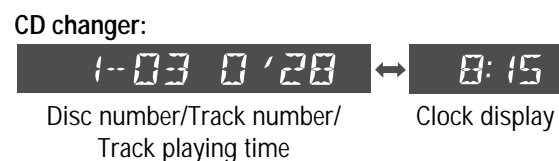
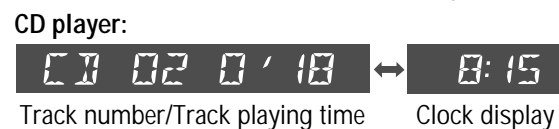

Track Selection

- [▶▶ TRACK]: Advance to the next track.
- [◀◀ TRACK]: Back to the beginning of the current track.
- [◀ TRACK]: Back to the previous track. (Press twice.)

Track Search

- Press and hold ...
- [▶▶▶ TRACK]: Fast forward
- [◀◀◀ TRACK]: Fast backward
- Release to resume the regular CD or CD changer play.

Note:

- The CD changer functions are designed for Panasonic CD changer unit (optional).
- This unit does not support CD-ROM, CD-R, or CD-RW playback through CD changer. Use the CD changer to listen to normal music CDs exclusively.

CD player

Direct Track Selection

- Press a track number button from [1] to [6]. The corresponding track starts playing.
- Press and hold a track number button from [7] to [12] ([1] to [6]) for more than 1 second. The corresponding track starts playing.

CD changer

Direct Disc Selection

- Press a disc number button from [1] to [6]. The corresponding disc starts playing.
- Press and hold a disc number button from [7] to [12] ([1] to [6]) for more than 1 second. The corresponding disc starts playing.

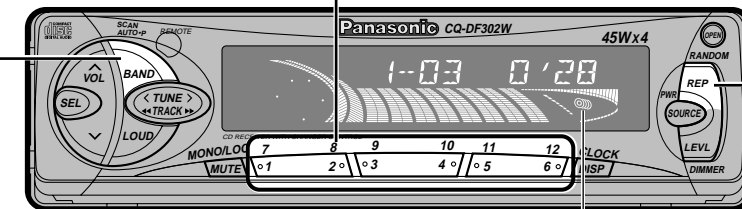

Track random play



- Press and hold [REP] (RANDOM) for more than 2 seconds. All the tracks (on all discs in the magazine*) are played in random order. (*Only for CD changer)
- Press and hold [REP] (RANDOM) again to cancel.



Track repeat play



- Press [REP]. The current track is repeated.
- Press [REP] again to cancel.



Track scan play



- Press [BAND] (SCAN). The first 10 seconds of each track on the disc are played in sequence.
- Press [BAND] (SCAN) again to cancel.



Disc scan play



- Press and hold [BAND] (SCAN) for more than 2 seconds. The first track of all the discs in the magazine is played for 10 seconds each.
- Press and hold [BAND] (SCAN) again to cancel.



Remote Control Unit Preparation

Battery Installation

- Remove the battery holder. Pull the holder by the position B while pushing position A in the direction indicated by the arrow.
- Install the battery on the battery holder. Set a new battery properly with its (+) side facing up as shown in the figure.
- Insert the battery holder. Push in the battery holder back into its original position.

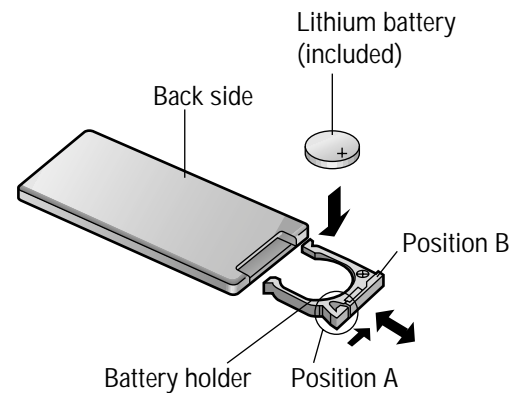

Battery Notes

Remove and dispose of an old battery immediately.

Battery Information:

- Battery type: Panasonic lithium battery (CR2025) (included)
- Battery life: Approximately 6 months with normal use (at room temperature)

Caution:

- Improper use of batteries may cause overheating, an explosion or ignition, resulting in injury or a fire. Battery leakage may damage the unit.

- Do not disassemble or short the battery. Do not throw a battery into a fire.
- Keep batteries away from children to avoid the risk of accidents.
- Be careful to the local disposal rules when you dispose of batteries.

Control Reference Guide

Buttons of the remote control function in the same way as the controls on the main unit of the reference page.

Point the remote control unit at the main unit's sensor (REMOTE).

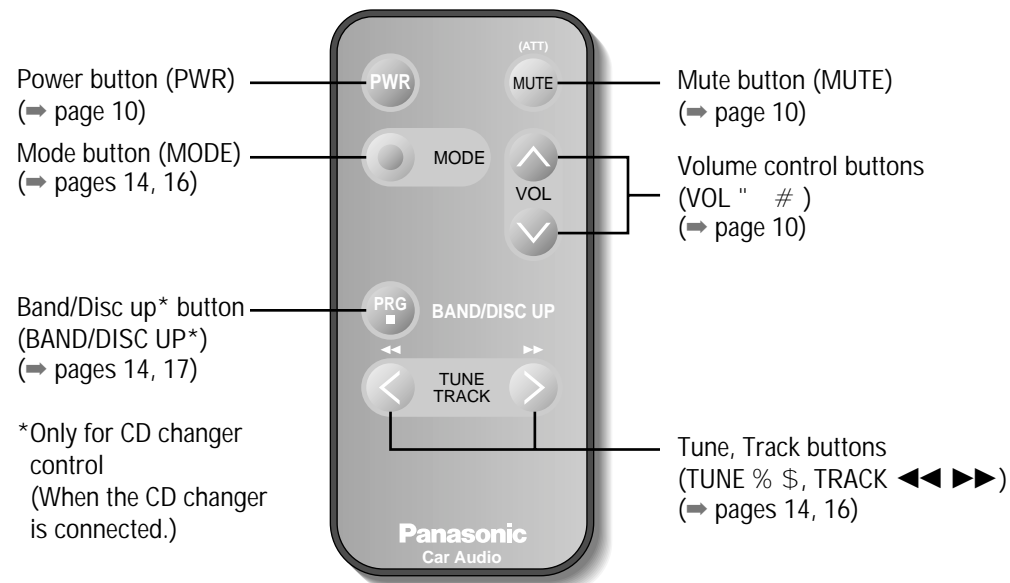

*Only for CD changer control (When the CD changer is connected.)

Installation Guide



This installation information is designed for experienced installers and is not intended for non-technical individuals. It does not contain warnings or cautions of potential dangers involved in attempting to install this product.

Any attempt to install this product in a motor car by anyone other than qualified installer could cause damage to the electrical system and could result in serious personal injury or death.

Installation Hardware

No.	Item	Diagram	Q'ty
①	Mounting collar		1
②	Hex. nut (5 mmφ)		1
③	Rear support strap		1
④	Tapping screw (5 mmφ × 16 mm)		1
⑤	Mounting bolt (5 mmφ)		1
⑥	Power connector		1
⑦	Removable face plate case		1
⑧	Trim plate		1

If you encounter problems, please consult your nearest professional installer.

Caution:

- This unit operates with a 12 V DC negative ground auto battery system only. Do not attempt to use it in any other system. Doing so could cause serious damage.

Before you begin installation, look for the items which are packed with your unit.

- Warranty Card...Fill this out promptly.
- Panasonic Servicenter for Service Directory...Keep for future reference in case the product needs servicing.
- Installation Hardware...Needed for in-dash installation.

Required Tools

You'll need a screwdriver, a 1.5 V AA battery, and the following:

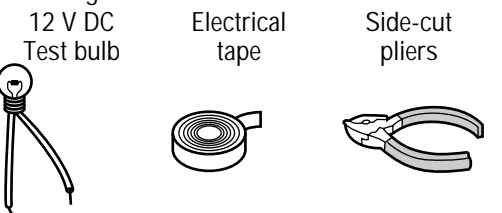

Overview

This product should be installed by a professional. However, if you plan to install this product yourself, your first step is to decide where to install it. The instructions in these pages will guide you through the remaining steps:

(Please refer to the "WARNING" statement above.)

- Identify and label the car wires.
- Connect the car wires to the wires of the power connector.
- Install the unit in the dashboard.
- Check the operation of the unit.

Dashboard Specifications

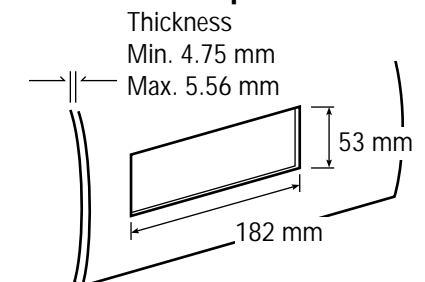

Installation Guide (Continued)

☐ Identify All Leads

The first step in installation is to identify all the car wires you'll use when hooking up your sound system.

As you identify each wire, we suggest that you label it using masking tape and a permanent marker. This will help avoid confusion when making connections later.

Note:

- Do not connect the power connector to the stereo unit until you have made all connections. If there are no plastic caps on the stereo hooking wires, insulate all exposed leads with electrical tape until you are ready to use them. Identify the leads in the following order.

Power Lead

If your car has a radio or is pre-wired for one:

Cut the connector wires one at a time from the plug (leaving the leads as long as possible) so that you can work with individual leads.

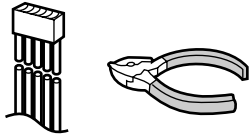

Turn the ignition on to the accessory position, and ground one lead of the test bulb to the chassis.

Touch the other lead of the test bulb to each of the exposed wires from the cut radio connector plug. Touch one wire at a time until you find the outlet that causes the test bulb to light.

Now turn the ignition off and then on. If the bulb also turns off and on, that outlet is the car power lead.

If your car is not wired for an audio unit:

Go to the fuse block and find the fuse port for radio (RADIO), accessory (ACC), or ignition (IGN).

Battery Lead

If your stereo unit has a yellow lead, you will need to locate the car's battery lead. Otherwise you may ignore this procedure. (The yellow battery lead provides continuous power to maintain a clock, memory storage, or other function.)

If your car has a radio or is pre-wired for one:

With the ignition and headlights off, identify the car battery lead by grounding one lead of the test bulb to the chassis and checking the remaining exposed wires from the cut radio connector plug.

If your car is not wired for an audio unit:

Go to the fuse block and find the fuse port for the battery, usually marked BAT.

Speakers

Identify the car speaker leads. There are two leads for each speaker which are usually color coded.

A handy way to identify the speaker leads and the speaker they are connected with is to test the leads using a 1.5 V AA battery as follows.

Hold one lead against one pole of the battery and stroke the other lead across the other pole. You will hear a scraping sound in one of the speakers if you are holding a speaker lead.

If not, keep testing different lead combinations until you have located all the speaker leads. When you label them, include the speaker location for each.

Antenna Motor

If your car is equipped with an automatic power antenna, identify the car motor antenna lead by connecting one bulb tester lead to the car battery lead and touching the remaining exposed wires from the cut radio connector plug one at a time. You will hear the antenna motor activate when you touch the correct wire.

Antenna

The antenna lead is a thick, black wire with a metal plug at the end.

☐ Connect All Leads

Now that you have identified all the wires in the car, you are ready to begin connecting them to the stereo unit wires. The wiring diagram (⇒ pages 25, 26) shows the proper connections and color coding of the leads.

We strongly recommend that you test the unit before making a final installation.

You can set the unit on the floor and make temporary connections to test the unit. Use electrical tape to cover all exposed wires.

Important:

- Connect the red power lead last, after you have made and insulated all other connections.

Ground

Connect the black ground lead of the power connector to the metal car chassis.

Speakers

Connect the speaker wires. See the wiring diagram (⇒ pages 25, 26) for the proper hookups. Follow the diagram carefully to avoid damaging the speakers and the stereo unit.

The speakers used must be able to handle more than 45 W of audio power. If using an optional audio amplifier, the speakers should be able to handle the maximum amplifier output power. Speakers with low input ratings can be damaged. Speaker impedance should measure 4–8 Ω, which is typically marked on most speakers. Lower or higher impedance speakers will affect output and can cause both speaker and stereo unit damage.

Motor Antenna

Connect the car motor antenna lead to the dark blue motor antenna relay control lead.

Battery

Connect the yellow battery lead to the correct radio wire or to the battery fuse port on the fuse block.

Antenna

Connect the antenna by plugging the antenna lead into the antenna receptacle.

Equipment

Connect any optional equipment such as an amplifier, according to the instructions furnished with the equipment. Leave about 30 cm of distance between the speaker leads/amplifier unit and the antenna/antenna extension cord. Read the operating and installation instructions of any equipment you will connect to this unit.

Power

Connect the red power lead to the correct car radio wire or to the appropriate fuse port on the fuse block.

If the stereo unit functions properly with all these connections made, disconnect the wires and proceed to the final installation.

☐ Final Installation

Lead Connections

Connect all wires, making sure that each connection is insulated and secure. Bundle all loose wires and fasten them with tape so they will not fall down later. Now insert the stereo unit into the mounting collar.

Congratulations! After making a few final checks, you're ready to enjoy your new auto stereo system.

☐ Final Checks

- Make sure that all wires are properly connected and insulated.
- Make sure that the stereo unit is securely held in the mounting collar.
- Turn on the ignition to check the unit for proper operation.

If you have difficulties, consult your nearest authorized professional installer for assistance.

☐ Preparation

- We strongly recommend that you wear gloves for installation work to protect yourself from injuries.
- When bending the mounting tabs of the mounting collar with a screwdriver, be careful not to injure your hands and fingers.

- Disconnect the cable from the negative ⊖ battery terminal (see caution below).
- Unit should be installed in a horizontal position with the front end up at a convenient angle, but not more than 30°.

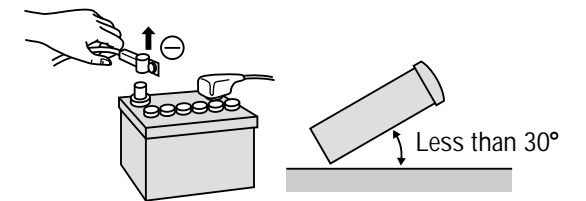

Caution:

- Do not disconnect the battery terminals of a car with a trip or navigational computer since all user settings stored in memory will be lost. Instead take extra care with installing the unit to prevent shorts.

Dashboard Installation

Installation Opening

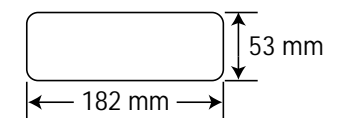

This unit can be installed in any dashboard having an opening as shown above. The dashboard should be 4.75 mm–5.56 mm thick in order to be able to support the unit.

Installation Guide (Continued)

Installation Procedures

First complete the electrical connections, and then check them for correctness. (→ pages 25, 26)

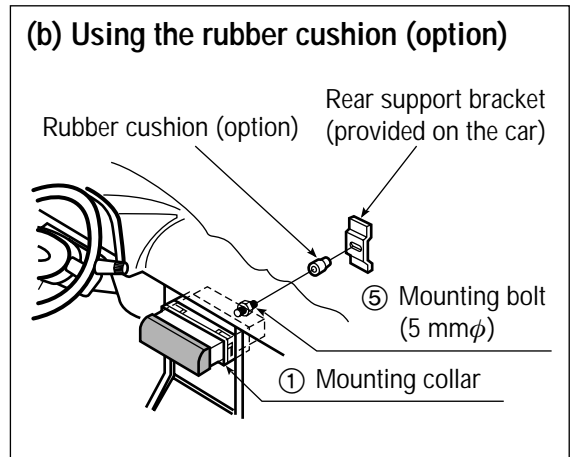
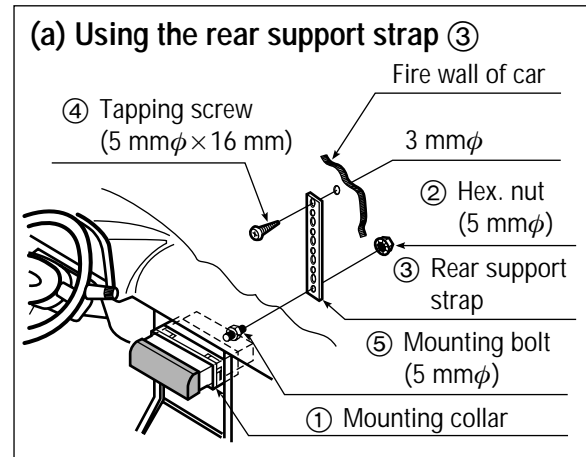
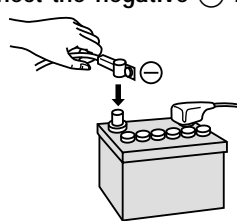
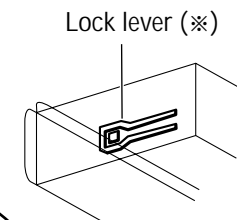
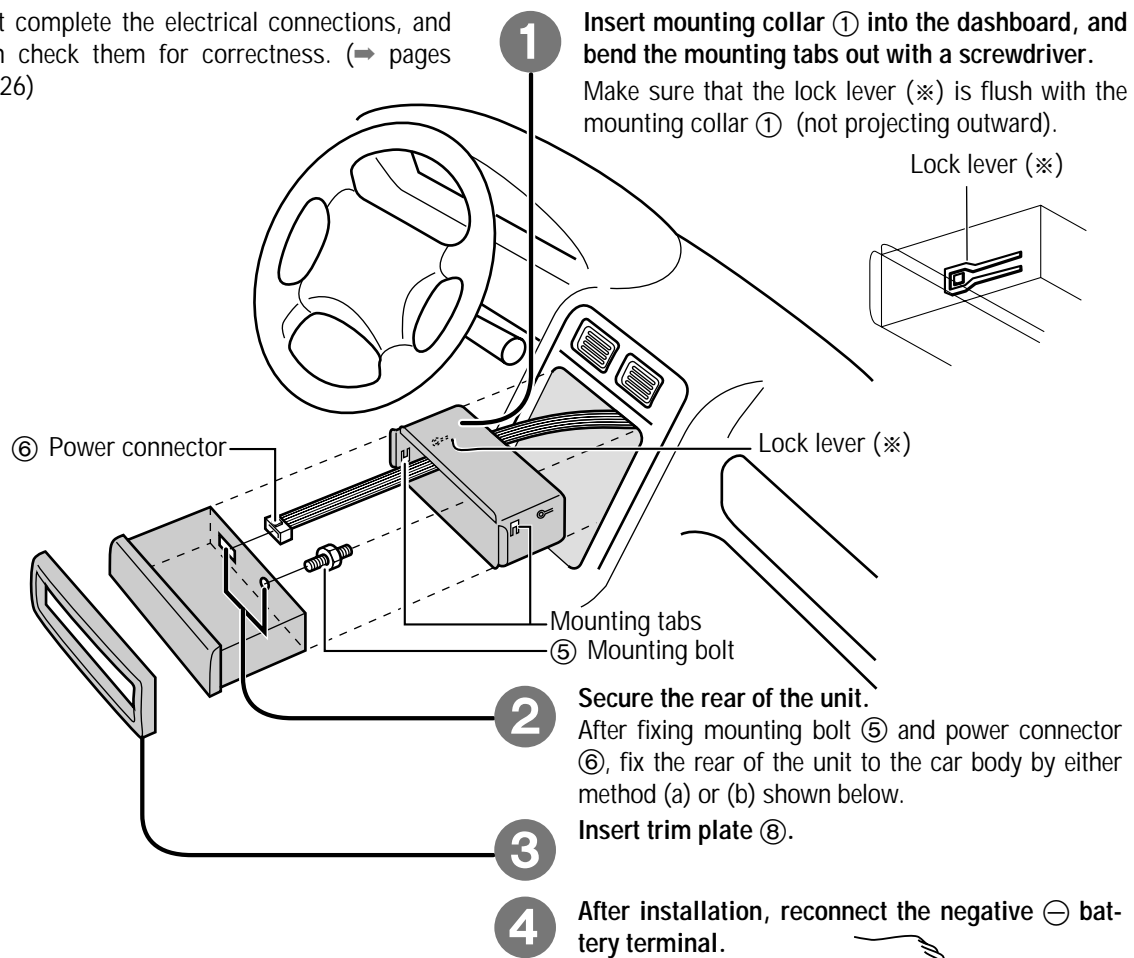

Remove the Unit

Switch off the power of the unit.

- 1** Remove the removable face plate.
- 1 Press [OPEN]. The removable face plate will be opened.
 - 2 Push the face plate to the left.
 - 3 Pull it out toward you.

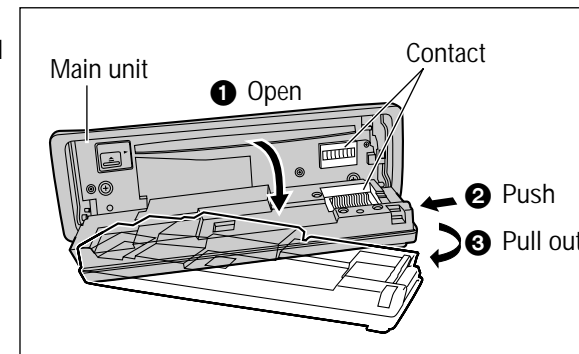
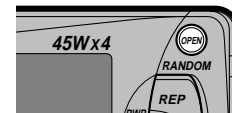

- 2** Remove the trim plate ⑧ with a screwdriver.

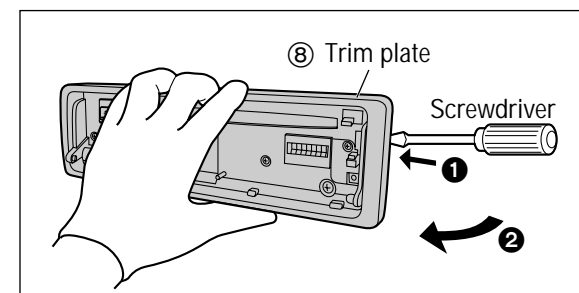

- 3** Pull out the unit while pushing down the lock lever with a screwdriver.

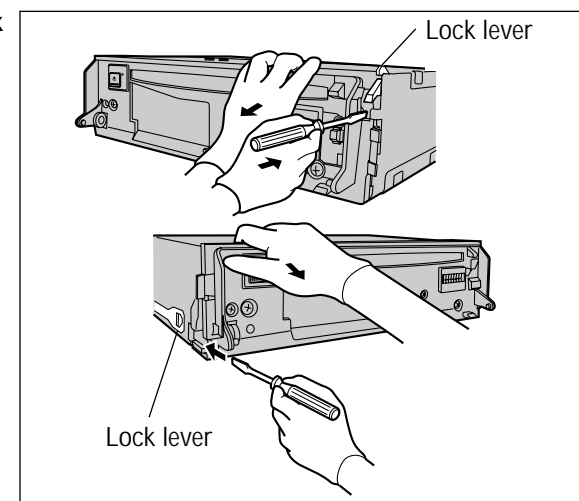

- 4** Remove the unit pulling with both hands.

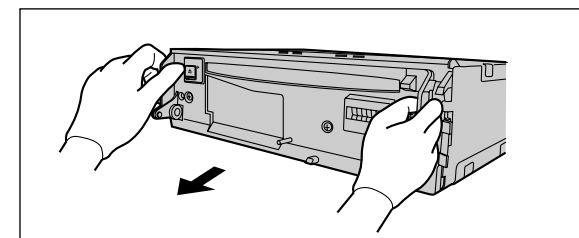

Anti-Theft System

This unit is equipped with a removable face plate. Removing this face plate makes the radio totally inoperable. The security indicator will blink.

Place the Removable Face Plate into Case

- ① Switch off the power of the unit.
- ② Remove the removable face plate. (⇒ page 23)
- ③ Gently press the button of the case and open the cover. Place the face plate into the case and take it with you when you leave the car.

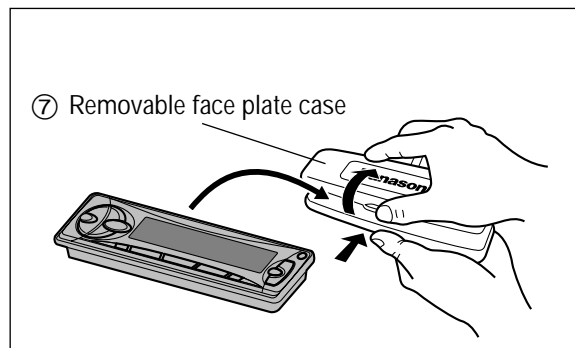

Install Removable Face Plate

- ① Fit the face plate with its left hole on one of the pins provided on the main unit.
- ② Fit the other hole on the other pin applying slight pressure.
- ③ Move the face plate up and down a few times to make sure it is secure. Then close the front panel and press down the right side of the face plate until it clicks into place.

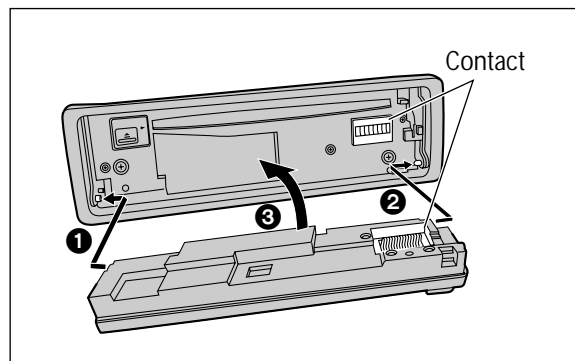

Security Indicator

The security indicator blinks when the removable face plate is removed from the unit.

Press and hold [SEL] to turn the security indicator on or off. ("LED ON" or "LED OFF").

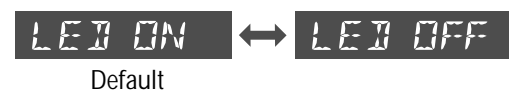

Display	Security indicator
LED ON	Blinks
LED OFF	OFF

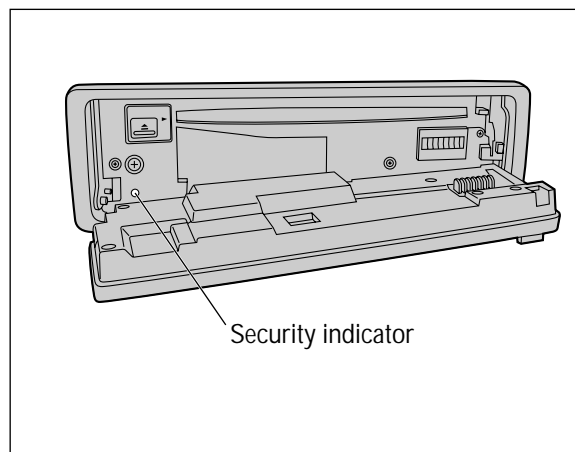

Cautions:

- This face plate is not water-proof. Do not expose it to water or excessive moisture.
- Do not remove the face plate while driving your car.
- Do not place the face plate on the dashboard or nearby areas where the temperature rises to high level.
- Do not touch the contacts on the face plate or on the main unit, since this may result in poor electrical contacts.
- If dirt or other foreign substances get on the contacts, wipe them off with a clean and dry cloth.
- Do not apply a strong downward force onto the face plate and do not put anything on it while it is open, or it might be damaged.

Electrical Connections

Cautions:

- This product is designed to operate of a 12 V DC, negative ground battery system.
- To prevent damage to the unit, be sure to follow the wiring diagram on the next page.
- Remove approx. 5 mm of protective covering from the ends of the leads before connecting.
- Do not insert the power connector into the unit until the wiring is completed.
- Be sure to insulate any exposed wires from a possible short-circuit from the car chassis. Bundle all cables and keep cable terminals free from touching any metal parts.
- Remember, if your car has a drive computer or a navigation computer, the data of its memory may be erased when the battery terminals are disconnected.

Accessory used for wiring

No.	Item	Q'ty
⑥	Power connector	1

Recommended external amplifier combination (example)

- Pre-amp out (rear/front) [CY-M9054 (4 channels system)]
- Subwoofer out [CY-M9054 (2 channels system) or CY-M7052 (1 channel system)]

(Continued to the next page.)

Electrical Connections (Continued)

Wiring Diagram

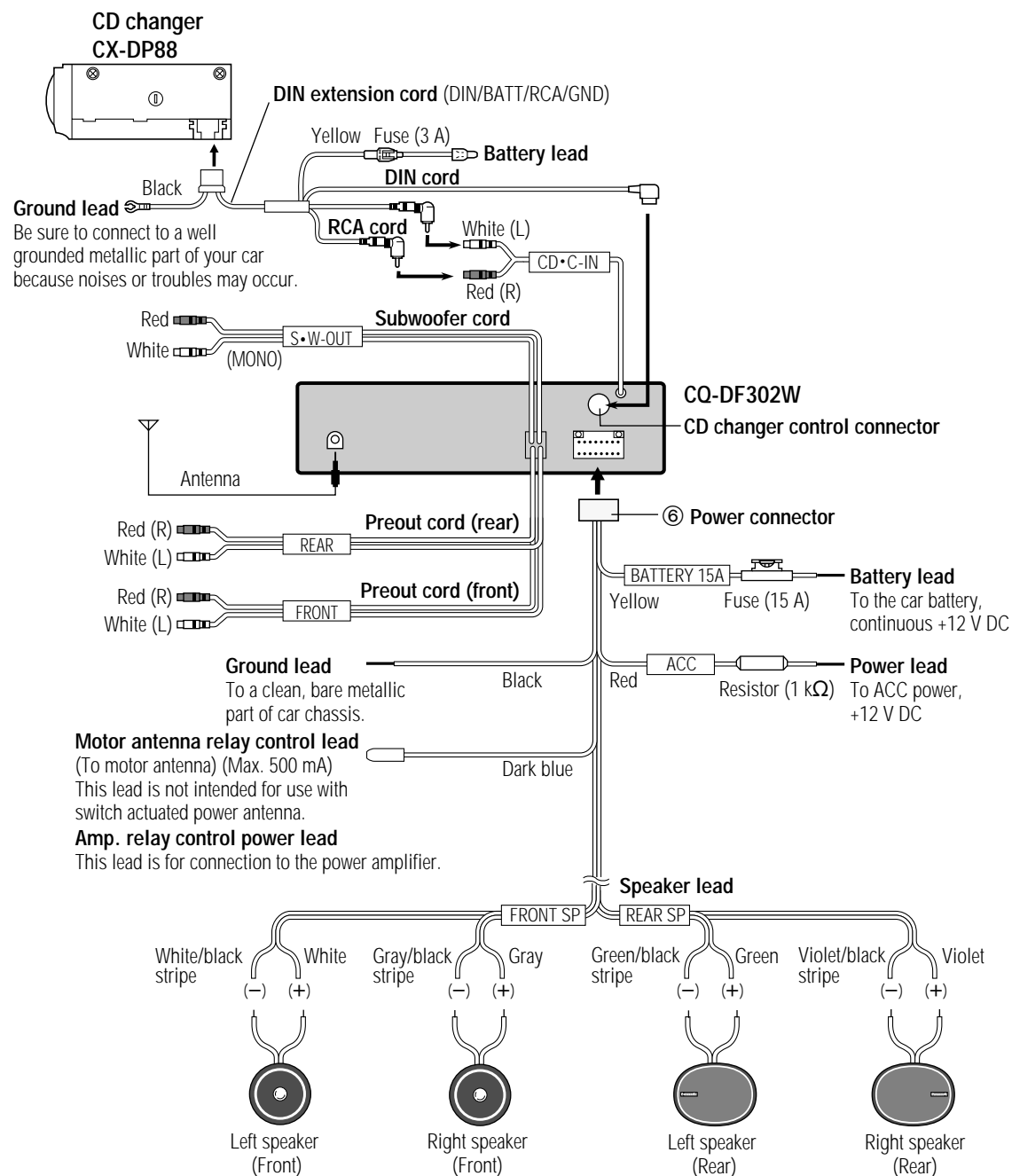

Troubleshooting

Preliminary Steps

Check and take steps as described in the tables below.

If You Suspect Something Wrong

Immediately switch power off.

Disconnect the power connector and check that there is neither smoke nor heat from the unit before asking for repairs. Never try to repair the unit by yourself because it is dangerous to do so.

Cautions:

- Do not use the unit if it malfunctions or if there is something wrong.
- Do not use the unit in abnormal condition, for example, without sound, or with smoke or foul smell, can cause ignition or electric shock. Immediately stop using it and call the store where you purchased it.

Troubleshooting Tips

Common

Trouble	Cause/Step
No power.	Car's engine switch is not on. → Turn your car's ignition switch to ACC or ON.
	Cables are not correctly connected. → Connect cables correctly.
	Battery cable is not correctly connected. → Connect the battery cable to the terminal that is always active.
	Accessory cable is not correctly connected. → Connect the accessory cable to your car's ACC source.
	Grounding wire is not correctly connected. → Connect the grounding wire to a metal part of the car.
	Fuse is burnt. → Call the store where you purchased the unit, or your nearest Servicenter and ask for fuse replacement.
No sound.	Mute is set to ON. → Set it to OFF.
	Cables are not correctly connected. → Connect cables correctly.
	Condensation (dew) → Wait for a while before use.
Radio	Much noise in FM stereo and monaural broadcasts. → Station is too far, or signals are too weak. → Select other stations of higher signal level.
	Preset station is reset. → Battery cable is not correctly connected. → Connect the battery cable to the terminal that is always live.

Troubleshooting (Continued)

CD

Trouble	Cause/Step
Disc is in the CD compartment but no sound is made, or disc is ejected automatically.	<p>Disc is upside down. →Place disc in the correct direction, and the label side up.</p> <ul style="list-style-type: none"> • Disc is dirty. • Disc has scratches. <p>→Clean disc, referring to the section on "Notes on CD/CD media (CD-R, CD-RW)".</p> <p>A disc that has data other than CD-DA type is loaded. →Discs that have CD-DA type data should be used.</p> <p>→The unit may not successfully play back a CD-R/RW that is made in combination of writing software, a CD recorder (CD-R/RW drive) and a disc which are incompatible one another. Refer to instructions for the concerned devices for details.</p>
Sound skips, bad sound quality (e.g. caused by noise)	<ul style="list-style-type: none"> • Disc is dirty. • Disc has scratches. <p>→Clean disc, referring to the section on "Notes on CD/CD media (CD-R, CD-RW)".</p> <p>→The unit may not successfully play back a CD-R/RW that is made in combination of writing software, a CD recorder (CD-R/RW drive) and a disc which are incompatible one another. Refer to instructions for the concerned devices for details.</p>
Sound skips due to vibration.	<p>Mounting angle is over 30°. →Adjust mounting angle to less than 30°.</p> <p>Instable mounting. →Mount the unit securely with the mounting parts, referring to the section on installation.</p>
Disc is not ejected.	<ul style="list-style-type: none"> • Disc is defective. • Mechanical trouble. <p>→Press [OPEN] to open the panel and press [▲] (EJECT). If normal operation is not restored yet, call the store where you purchased the unit or the nearest Servicenter to ask for repairs.</p>
Time is counted but no sound comes out.	<p>The first track of a mix mode disc was reproduced. (Mix mode is a format in which data except music is recorded on the first track and music data is recorded on other than the first track in a session.) →Play back music data recorded on other than the first track.</p>

Sound Setting

No sound from left, right, front or rear speakers.	<p>Left and right balance, or front and rear balance is off on one side. →Adjust balance/fader mode as appropriate.</p> <p>Cables are not correctly connected. →Connect the cables correctly.</p>
Left and right sounds are reversed in stereo listening.	<p>The right speaker wire is connected to the left speaker and the left speaker wire to the right speaker. →Connect the speaker wires to the correct ones.</p>

Remote Control

Trouble	Cause/Step
Buttons are invalid for operation.	Battery poles (+) (-) are reversed. →Insert the battery correctly.
	Wrong the battery. →Check the battery.
	Battery has run down. →Replace the battery.
	Remote control is in the wrong direction. →Direct the remote control at sensor (REMOTE) on the panel.

Error Display Messages

CD

Display	Cause/Step
	<ul style="list-style-type: none"> • Disc is dirty, or is upside down. • A disc that has data other than CD-DA type is loaded. <p>→Press [OPEN] to open the front panel, and then press [▲] (EJECT) to eject the disc.</p>
	<p>Disc has scars. →Press [OPEN] to open the front panel, and then press [▲] (EJECT) to eject the disc.</p>
	<p>No operation by some cause. →Turn off the car engine (ACC off) and remove the fuse from the battery lead (yellow) for 1 minute. Then reinstall the fuse.</p>

CD Changer

	<ul style="list-style-type: none"> • Disc is dirty, or is upside down. • A disc other than a music CD (CD-DA type) is loaded. <p>→Select the next available compact disc.</p>
	<p>Disc has scratches. →Select the next available compact disc.</p>
	<p>No operation by some cause. →Press [RESET] on the CD changer (optional).</p>
	<p>No disc in the changer (magazine). →Insert discs into the changer (magazine).</p>

Notes:

- There may be cases where the disc numbers affected by an error are displayed before "E1" or "E2".
- Displays and the steps to be taken for errors vary in part from changer to changer. For details, refer to the operating instructions for the changer used.

Maintenance

Care of the Unit

☐ Cleaning this Unit

Use a dry, soft cloth to wipe.

☐ Caution on Cleaning

Never use solvents such as benzene, thinner as they may mar the surface of the unit.

Notes on CD/CD Media (CD-R, CD-RW)

Do not play any ordinary music CDs with labels other than this one.



How to hold the disc

- Do not touch the underside of the disc.
- Do not scratch on the disc.
- Do not bend disc.
- When not in use, keep the disc in the case.

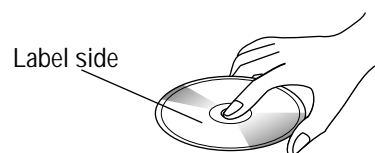

Do not use irregular shaped discs.

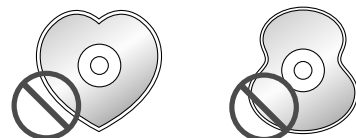

Do not use irregular shaped discs.

Do not leave discs on the following places:

- Direct sunlight
- Near car heaters
- Dirty, dusty and damp areas
- Seats and dashboards

<Right> <Wrong>

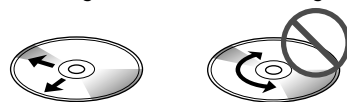

Disc cleaning

Use a dry, soft cloth to wipe from the center outward.

Rough edges

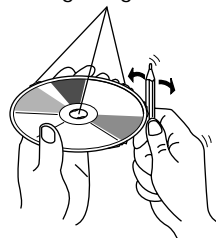

Caution on new discs

A new disc may have rough edges on its inner and outer perimeter. These may cause malfunction. Remove the rough edges using a pencil, etc.

Do not attach any seals or labels to your discs.

Do not write on the disc label in a heavy pen or ball-point pen stroke.

Notes on CD-Rs/RWs

- You may have trouble playing back some CD-R/RW discs recorded on CD recorders (CD-R/RW drives), either due to their recording characteristics or dirt, fingerprints, scratches, etc. on the disc surface.
- CD-R/RW discs are less resistant to high temperatures and high humidity than ordinary music CDs. Leaving them inside a car for extended periods may damage them and make playback impossible.
- The unit may not successfully play back a CD-R/RW that was made by the combination of writing software, a CD recorder (CD-R/RW drive) and a disc if they are incompatible one another.
- This player cannot play the CD-R/RW discs if the session is not closed.
- This player cannot play the CD-R/RW discs which contains other than CD-DA data.
- Be sure to observe the instructions of CD-R/RW disc for handling it.

Maintenance

Your product is designed and manufactured to ensure a minimum of maintenance. Use a soft cloth for routine exterior cleaning. Never use benzene, thinner or other solvents.

Product Servicing

If the suggestions in the charts do not solve the problem, we recommend that you take it to your nearest authorized Panasonic Servicenter. The product should be serviced only by a qualified technician.

Replacing the Fuse

Use fuses of the same specified rating (15 A). Using different substitutes or fuses with higher ratings, or connecting the unit directly without a fuse, could cause fire or damage to the stereo unit.

If the replacement fuse fails, contact your nearest Panasonic Servicenter for service.

Specifications

☐ General

Power supply:	12 V DC (11 V–16 V), test voltage 14.4 V, negative ground
Current consumption:	Less than 2.2 A (CD play mode; 0.5 W×4 channels)
Maximum power output:	45 W×4 channels at 400 Hz, Volume control maximum
Power output:	22 W×4 channels at 400 Hz (DIN 45 324, at 4 Ω)
Tone adjustment range:	Bass: ±12 dB at 100 Hz Treble: ±12 dB at 10 kHz
Suitable speaker impedance:	4–8 Ω
Pre-Amp output voltage:	2.0 V (CD play mode; 1 kHz, 0 dB)
Subwoofer output voltage:	2.0 V
Output impedance:	200 Ω
Dimensions (W×H×D):	178×50×150 mm
Weight:	1.5 kg

☐ FM Stereo Radio

Frequency range:	87.5 MHz–108.0 MHz
Usable sensitivity:	11.0 dBf. (1.25 μV, 75 Ω)
50 dB quieting sensitivity:	15.2 dBf. (1.6 μV, 75 Ω)
Frequency response:	30 Hz–15 kHz (±3 dB)
Alternate channel selectivity:	75 dB
Stereo separation:	42 dB (1 kHz)
Image response ratio:	75 dB
IF response ratio:	100 dB
Signal/noise ratio:	70 dB

☐ AM Radio

Frequency range:	531 kHz–1 602 kHz
Usable sensitivity:	28 dB/μV (25 μV, S/N 20 dB)

☐ CD Player

Sampling frequency:	32 times oversampling
DA converter:	MASH • 1 bit/4 DACsystem
Error correction system:	Panasonic super decoding algorithm
Pick-up type:	Astigma 3-beam
Light source:	Semiconductor laser
Wave length:	780 nm
Frequency response:	20 Hz–20 kHz (±1 dB)
Signal/noise ratio:	96 dB
Total harmonic distortion:	0.01 % (1 kHz)
Wow and flutter:	Below measurable limits
Channel separation:	75 dB

Note:

- Specifications and the design are subject to modification without notice due to improvements in technology.

Free Manuals Download Website

<http://myh66.com>

<http://usermanuals.us>

<http://www.somanuals.com>

<http://www.4manuals.cc>

<http://www.manual-lib.com>

<http://www.404manual.com>

<http://www.luxmanual.com>

<http://aubethermostatmanual.com>

Golf course search by state

<http://golfingnear.com>

Email search by domain

<http://emailbydomain.com>

Auto manuals search

<http://auto.somanuals.com>

TV manuals search

<http://tv.somanuals.com>