

Operating Instructions

操作说明书

High-Power Cassette Player/Receiver with Changer Control

带有换片器控制功能的大功率磁带放音收音组合机/

带镭射唱片变换器控制的放音机

CQ-RG131W



Panasonic®

松下电器

- Please read these instructions carefully before using this product and save this manual for future use.
- 使用本产品之前，请仔细阅读这些说明书，并妥善保管本操作说明书以备将来使用。

Contents

	Page		Page
Precautions	2	Anti-Theft System	16
Power and Sound Controls	4	Electrical Connections	18
Radio Basics	6	Speaker Connections	19
Cassette Tape Player Basics	8	Troubleshooting	20
CD Changer Basics	10	Fuse	21
Clock Basics	12	Maintenance	21
Installation Guide	13	Specifications	21

Panasonic welcomes you to their constantly growing family of electronic products owners. We endeavor to give you the advantages of precise electronic and mechanical engineering, manufactured with carefully selected components, and assembled by people who are proud of the reputation their work has built for our company. We know this product will bring you many hours of enjoyment, and after you discover the quality, value, and reliability we have built into it, you too will be proud to be a member of our family.

Precautions

Volume Level

For your driving safety, keep the volume level low enough to be aware of road and traffic conditions.

Car Washing

To avoid electrical shorts which may cause fire or other damage, do not expose this equipment (including the speakers and tape) to water or excessive moisture.

Car Ventilation

If your car is parked for several hours in direct sunlight, the temperature inside the car may become very high. It is advisable to drive the car and give the interior a chance to cool down before switching the unit on.

Power Supply

This equipment is designed to be used in a car having 12-Volt negative ground battery system.

Tape Mechanism

Keep magnets, screwdrivers and other metallic objects away from the tape mechanism and tape head.

Service

This unit is made of precision parts. Do not attempt to disassemble or adjust any parts. For repair, please consult your nearest authorized Panasonic Service Center.

About Preset Memory

The preset memory is cleared to return to the original factory setting when the power connector or battery is disconnected.

目录

	页		页
预防措施	3	防盗系统	34
电源与音量控制	22	电气连接	36
收音机基本操作	24	扬声器连接	37
卡式磁带放音机基本操作	26	故障排除	38
镭射唱片变换器的基本操作	28	保险丝	39
时钟的基本操作	30	维修	39
安装	31	规格	39

Panasonic 欢迎您来到不断增加的电子产品拥有者的家族之中。我们力图为您提供精密的电子与机械工程的方便性，使用经过认真选择的零件进行生产，并由对他们的工作已为我公司树立信誉而感到自豪的人们进行组装。我们知道这个产品将为您带来更多享受的时光，当您发现我们的产品所拥有的质量、价值和可靠性之后，您会为自己成为我们家族的一员而感到自豪。

预防措施

音量

为了安全驾驶，请尽量保持低音量，以便注意交通和路面状况。

洗车时

为了避免电气短路而引起火灾或其它危害，请勿使本设备(包括扬声器与磁带)沾水或受潮。

汽车通风

如果您的汽车在直射阳光下停车几个小时之后，汽车内的温度会升很高。

在打开本机之前，最好开动汽车，降低车内温度。

供电

本设备的设计是用于备有 12 伏负极接地电池系统的汽车中。

磁带机构

切勿将磁铁，螺丝刀和其它金属物靠近磁带机构和磁头。

维修

本机由精密部件组成。请勿自行尝试拆卸或调节任何部件。如要维修，请到您附近的公认的 Panasonic 维修中心进行询问。

关于预置记忆

当断开电源连接器或电瓶时，预置记忆会被消除并回复到出厂时的设定。

Power and Sound Controls

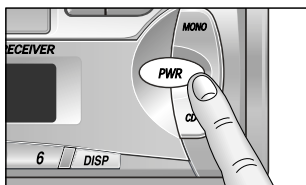
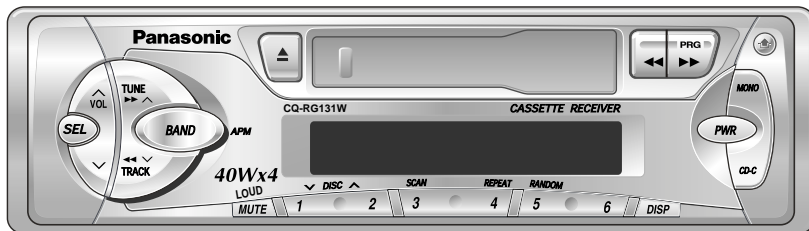

Power

Turn the key in the ignition until the accessory indicator lights. Press **[PWR]** to switch on the power.

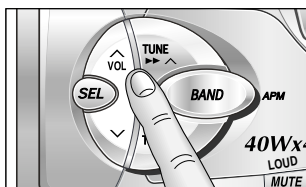

Volume

- Press **[VOL▲]** or **[VOL▼]** to increase or decrease volume.

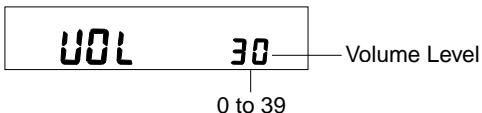

- Press **[VOL▲]** or **[VOL▼]** for more than 0.5 second to change numeric levels on the display rapidly.

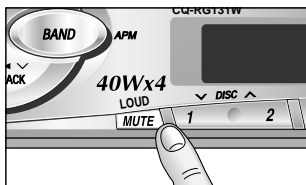

Mute

- Press **[MUTE]** mute the sound completely.
- "MUTE" blinks while this operation.



- Press **[MUTE]** again to cancel.

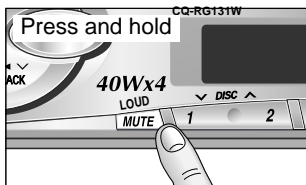

Tone Enhancement

- Press and hold **[MUTE]** (LOUD) for more than 2 seconds to enhance bass and treble tones when listening at low or medium volume.



- Press and hold **[MUTE]** (LOUD) for more than 2 seconds again to deactivate when listening at higher volumes.

Note: This unit is equipped with an anti-volume-blast circuit which serves as an automatic volume level adjuster so that you will not be deafened with sudden loud volume. This system operates as follows. When **[PWR]** is switched on, the volume level is low. After that, the volume level gradually returns to the level as the same as the one before turning off. Anti-volume-blast circuit is not effective when volume level is lower than position 20 at the display.

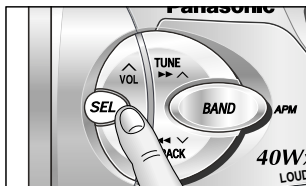

Changing Audio Modes

Press [SEL] to switch the audio modes as follows.

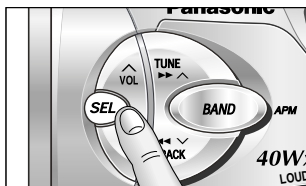
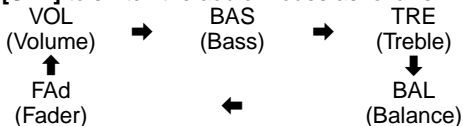

Bass and Treble

Press [SEL] to select the BASS/TREBLE mode. Press [VOL/▲] or [VOL/▼] to increase or decrease the bass/treble response.

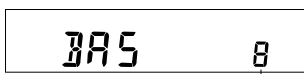

-12 to 0 (Center) to 12

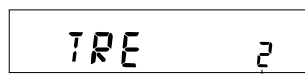

-12 to 0 (Center) to 12

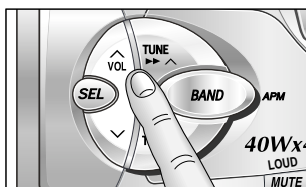

Balance

Press [SEL] to select the BALANCE mode. Press [VOL/▲] or [VOL/▼] to shift the sound volume to the right or left speakers.



R or L 1 to 15

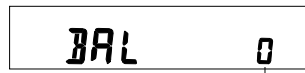

Balance Center

(R: Right, L: Left)

Fader

Press [SEL] to select the FADER mode. Press [VOL/▲] or [VOL/▼] to shift the sound volume to the front or rear speakers.



F or R 1 to 15



Fader Center

(F: Front, R: Rear)

Note: When a control mode (BAS/TRE/BAL/FAd) is selected but no operation is made within 5 seconds (2 seconds at volume mode), the display will return to the normal operation (Radio, Cassette, etc.) mode. In such a case, press [SEL] again to select the next control mode.

Radio Basics

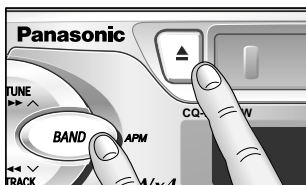
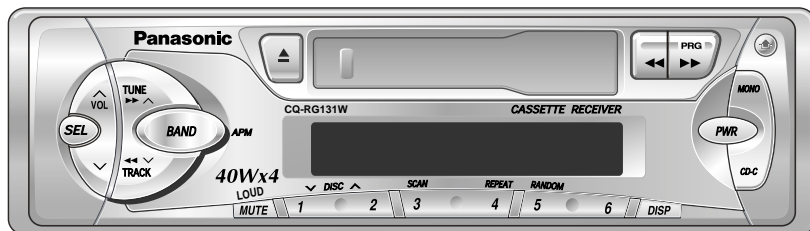

Change to the tuner mode

- ① In case of Tape modeEject a tape.
- ② In case of CD Changer modePress [BAND].

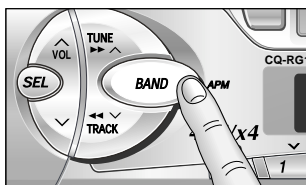

Selecting a Band

Press [BAND] to select the band as follows.



"ST" indicator lights if the station is broadcasting in stereo.

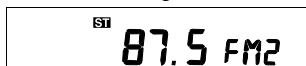

Manual Tuning

Press [TUNE ^] or [TUNE v] to move to a higher or lower frequency.

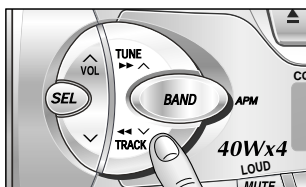

Seek Tuning

Press and hold [TUNE ^] or [TUNE v] for more than 0.5 second, then release. The radio automatically stops on the next station.

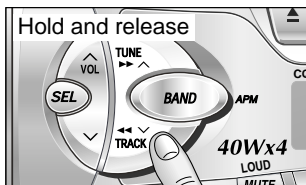

To reduce interference during FM broadcasts (MONO)

Press [MONO] for monaural reception in case a lot of interference is present in an FM stereo signal or to improve the listening quality of weak FM broadcasts. To turn it off, press [MONO] again.

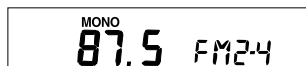
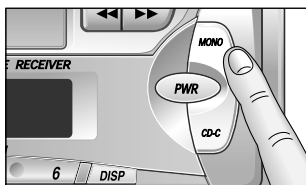

Preset Station Setting

Up to 24 stations can be preset in the station memory as follows;

FM1	FM2	FM3	AM
6 stations	6 stations	6 stations	6 stations

Caution: For safety reasons, do not attempt to program while driving.

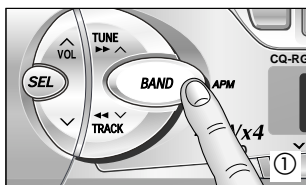

Manual Station Preset

- ① Press **[BAND]** to select a desired band.
- ② Use manual or seek tuning to find a station that you want to program into memory.
- ③ Press and hold one of the station selector buttons **[1]** through **[6]** until the display blinks. The memory is now set for that button on the band you have selected. Repeat the process to set other stations for the FM1 to AM bands.

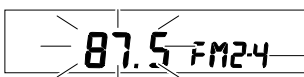
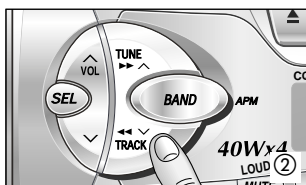

Preset Number

Note: You can change the memory setting by repeating the above procedure.

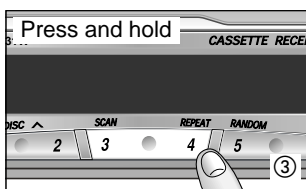

Tuning in a Preset Station

Press any of the buttons **[1]** through **[6]** to tune in the station preset by the above steps ① to ③.

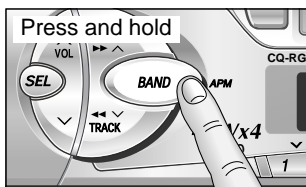

Auto Preset Memory

Select a band, and press and hold **[BAND]** (APM) for more than 2 seconds.

- The 6 strongest available stations will be automatically set in memory on preset buttons **[1]** through **[6]**.
- Once set, the preset stations are sequentially scanned for 5 seconds.
- Press the appropriate preset button for the station you want to hear.

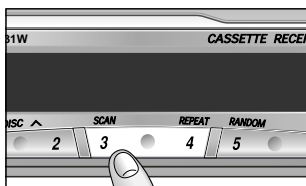

Note: The stations manually preset on the selected band will be deleted.

Cassette Tape Player Basics

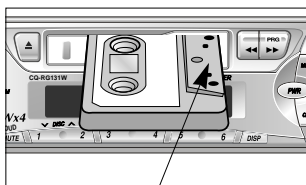
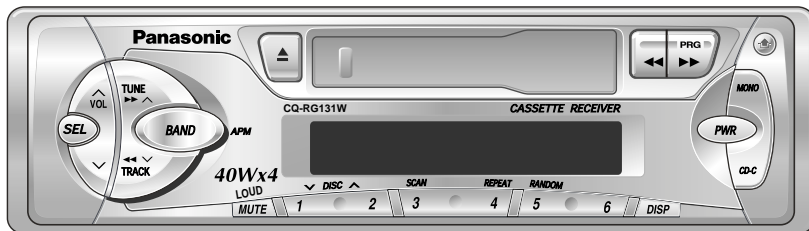

Exposed Tape

Loading a Cassette

Gently insert a cassette with the exposed tape side facing to the right until the mechanism captures it, and playback starts.



Program Indicator
(This indication "▲" rotates.)

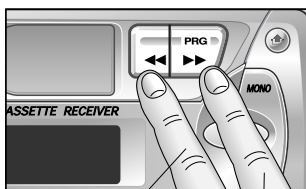

"▲" lights : Rewind

"▼" lights : Fast Forward

"▲" lights : Fast Forward

"▼" lights : Rewind

Rewind and Fast Forward

When the program indicator "▲" lights, press [◀◀] to rewind or press [▶▶] to fast forward the tape.

When the program indicator "▼" lights, press [◀◀] to fast forward or press [▶▶] to rewind the tape.



To stop rewind or fast forward, gently press the button that is not in use.

The tape will resume playing from that position.

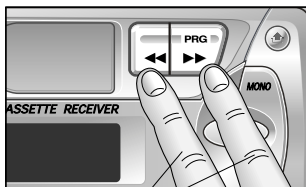

Press Both at the same time

Changing Sides

Press [◀◀] and [▶▶] at the same time to switch to the program on the other side of the tape.

The display changes to indicate which program is playing.



Top Side Playing

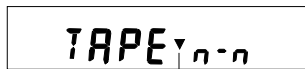

Bottom Side Playing

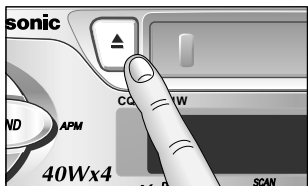

Stopping and Ejecting the Tape

Once inserted into the unit, your tape will play continuously until you eject it.

If you press [▲] (EJECT), the unit ejects the tape and returns to radio operation.

When you stop the car engine, the tape will stop but not be ejected.

Notes:

- You can not change to CD Changer mode or Radio mode while tape is playing. If you want to change to CD Changer mode or Radio mode, eject the tape.
- Always remove the cassette when you stop using the cassette player. This will prolong the life of your tape.

Notes on Cassette Tapes

Tape Slack:

Use a pencil or similar object to take up the slack as shown. If a loose tape is used, this may result in the tape becoming tangled in the rotating parts of the unit.

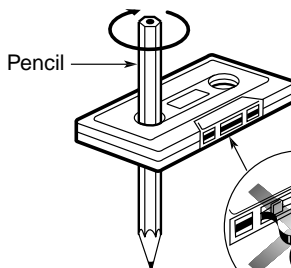

Do not touch or pull out the tape.

Cautions:

- To maintain your cassette player in top condition, avoid using tapes that are longer than 90 minutes (C-90).
- If you insert into the unit a cassette with a loose tape caused by forcing it into cassette with a finger or the like, the cassette may not be properly reproduced. In such a case, eject the cassette, make the tape tight, then insert it back into the deck.

CD Changer Basics

Note:

CD changer functions are applicable to units with optional CD changer unit. (sold separately)

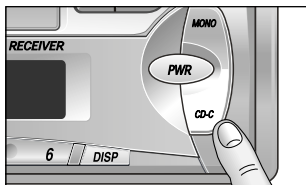
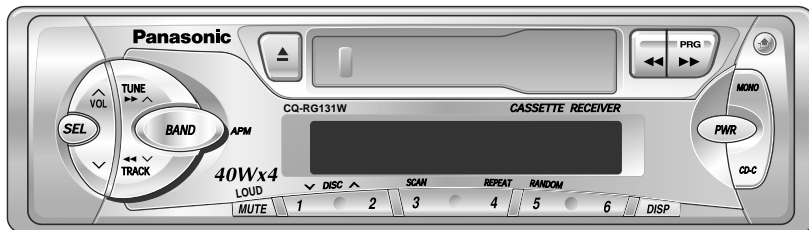

To Changer mode

While a disc magazine is inserted in the CD changer, press [CD-C].

Play starts from the first track.

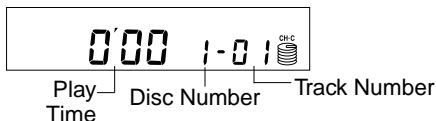

Note: The cassette, if loaded, should be removed. Otherwise, the CD play will not start.

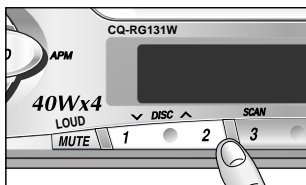

Selecting a Disc

Press [1] (∨DISC) or [2] (DISC∧) to select discs in ascending or descending order.

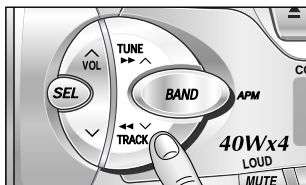
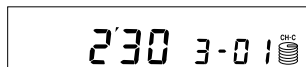

Selecting a Track

Press [TRACK▶▶] once to go to the next track. Press repeatedly to step forward through all the tracks.

Press [TRACK◀◀] once to play from the beginning of the current track. Press twice to play the previous track. Press repeatedly to step backward through all the tracks.

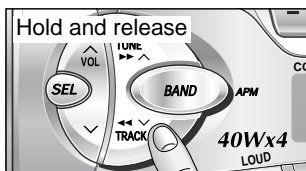

Searching a Track

Press and hold [TRACK▶▶] or [TRACK◀◀] for more than 0.5 second to activate fast forward or reverse through a track. Release [TRACK▶▶] or [TRACK◀◀] to resume the normal CD play from that position.

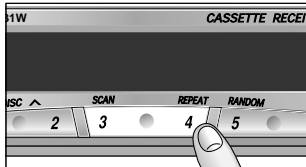

Repeating a Track

- Press [4] (REPEAT) to repeat the current selection. "REPEAT" indicator lights.
- The current selection continues to repeat until you press [4] (REPEAT) again.

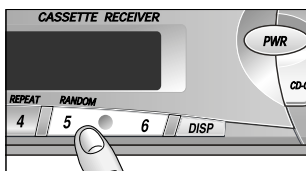

Random Selection

- Press [5] (RANDOM) to random selection of music is played from all available CDs. "RANDOM" indicator lights.
- To turn it off, press [5] (RANDOM) again.

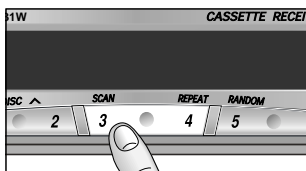

Scanning Tracks

- Press [3] (SCAN). The track number blinks and the first 10 seconds of each track on the discs play in sequence.
- To stop scanning and continue with the current track, press [3] (SCAN) again.

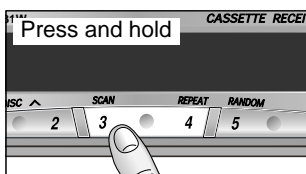
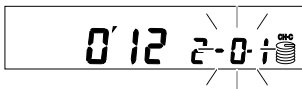

Scanning Discs

Press and hold [3] (SCAN) for more than 2 seconds. The 1st track of all the discs in the magazine is played for 10 seconds each. Also, Disc Number blinks at the same time. To stop the current play of the disc scanning, press and hold [3] (SCAN) for more than 2 seconds again.

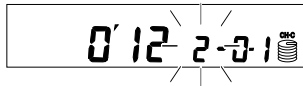

❑ Error Display Messages

E1	Displays when the compact disc is dirty or upside down. Selects the next available compact disc.	E3	Displays when the compact disc stops operating for some reason. Please contact your nearest authorized Panasonic Service center.
E2	Displays when compact disc is scratched. Selects next available compact disc.	0000	Displays when there is no disc in the magazine.

Clock Basics

(The clock system is 12-hours.)

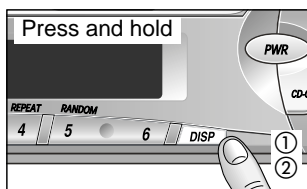
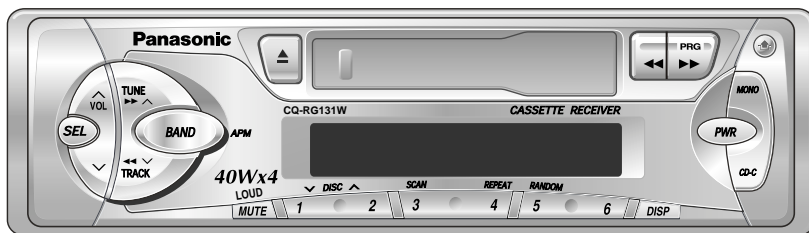

Initial Time Setting

- ① Press **[DISP]**. "AdJ" is displayed.
- ② Press and hold **[DISP]** again for more than 2 seconds. "12" blinks indicating the time setting mode is activated.
- ③ To set hours, press **[^]** or **[v]**.
- ④ Press **[DISP]** again for minute setting.
- ⑤ To set minutes, press **[^]** or **[v]**. Hold **[^]** or **[v]** to change numbers rapidly.
- ⑥ When you have set the time, press **[DISP]**.

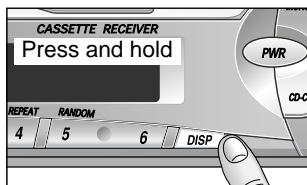
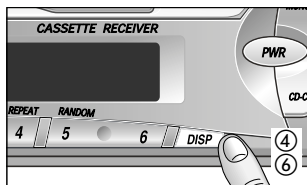
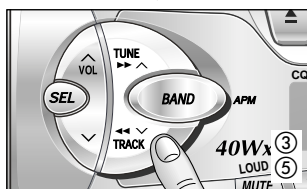
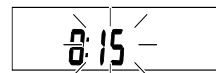

Resetting the Time

When you want to reset the time, press and hold **[DISP]** for more than 2 seconds to activate the time setting mode. Then, repeat step ③ to ⑥ above.

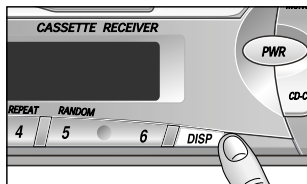

Selecting the Clock Display

Press **[DISP]** for clock display.
Press **[DISP]** once again, the current audio display mode resumes.

Installation Guide

Preparation

- Before installation, check the radio operation with antenna and speakers.
- Disconnect the cable from the negative (-) battery terminal (see caution below).
- Unit should be installed in a horizontal position with the front end up at a convenient angle, but not more than 30°.

Caution:

For installation to cars with trip or navigational computers, all electronic memory settings previously registered in the computer will be lost when the battery terminal is disconnected. For this type of car, battery could not be disconnected. Therefore, extra care should be taken to prevent short circuiting.

In-dash Installation

Installation Opening

In-dash installation can be done if the car's dashboard has an opening for this unit as shown in Fig. 1. The car's dashboard should have a thickness of 4.5 mm - 6 mm in order to make the installation of the unit.

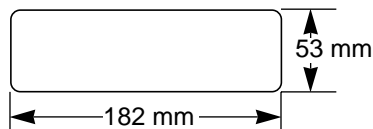

Fig. 1

Installation Precautions

This equipment, if possible, should be installed by a professional installer.

In case of difficulty, please consult your nearest authorized Panasonic Service Center.

1. This system is to be used only in a 12-volt, DC battery system (car) with negative ground.
2. Follow the electrical connection on page 18 carefully. Failure to do so may result in damage to the unit.
3. Connect the power lead after other connections are made.
4. Be sure to connect the YELLOW lead to the positive (+) of the battery or fuse block (BAT) terminal.
5. Insulate all exposed wires to prevent short circuiting.
6. Secure all loose wires after installing the unit.
7. Please carefully read the operating and installation instructions of the respective equipment before connecting it to this unit.

Supplied Hardwares

No.	Item	Diagram	Qty
①	Mounting Collar		1
②	Hex. Nut (5 mm φ)		1
③	Rear Support Strap		1
④	Tapping Screw (5 mm φ x 16 mm)		1

No.	Item	Diagram	Qty
⑤	Mounting Bolt (5 mm φ)		1
⑥	Power Connector		1
⑦	Dismounting Plate		1
⑧	Removable Face Plate Case		1

Installation Guide (continued)

Installation Procedures

Note: Disconnect the cable from the negative (-) battery terminal.

1. Secure the Mounting Collar ①.

Insert Mounting Collar ① into the car's dashboard, and bend mounting tabs out with a screwdriver.

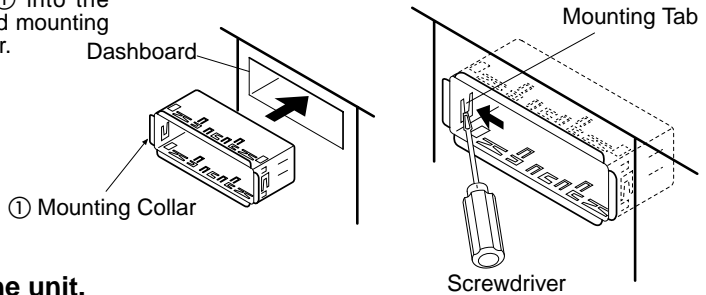

2. Secure the rear of the unit.

- Check the electrical connection by referring to this operating instructions.
- Connect the Mounting Bolt ⑤ using a suitable wrench.
- Insert the Power Connector ⑥ to the unit.

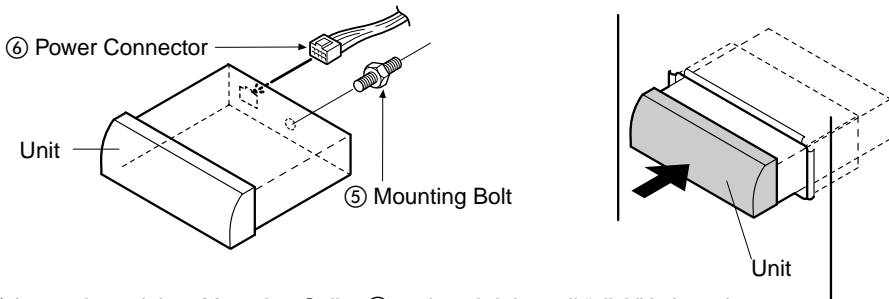

- Insert the unit into Mounting Collar ① and push it in until "click" is heard.
- Secure the rear of the unit to the car by either of the two recommended methods as follows.

■ Using the Rear Support Strap ③

Affix one end of the Rear Support Strap ③ to the rear of the unit, and the other end to the Fire Wall of Car, or some other metallic area.

■ Using the Rubber Cushion (Option)

(If there is an existing Rear Support Bracket on the Fire Wall of Car.)

Cover Mounting Bolt on the rear of the unit with Rubber Cushion (Option), and mount it into the existing Rear Support Bracket.

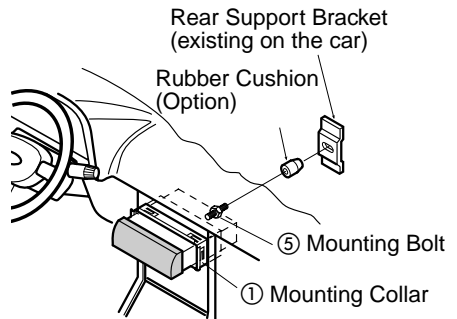
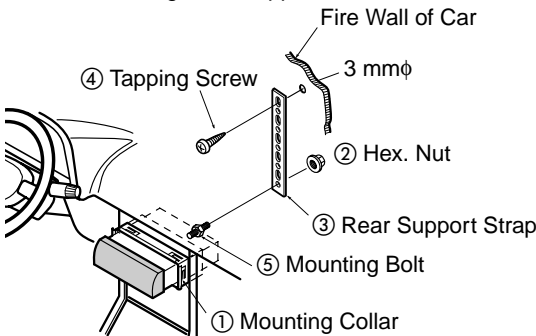

3. After installation reconnect the negative (-) battery terminal.

To Remove the Unit

a) Remove the trim plate with a screwdriver as shown in the figure (Fig. 1).

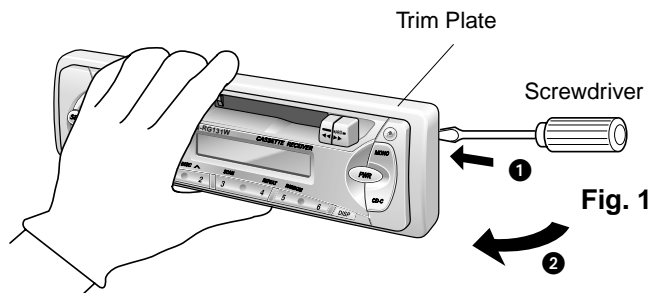

b) Pull out the unit while pushing the two lock levers using Dismounting Plate ⑦ as follows. (Fig 2, 3)

c) Remove the unit pulling with both hands. (Fig 4).

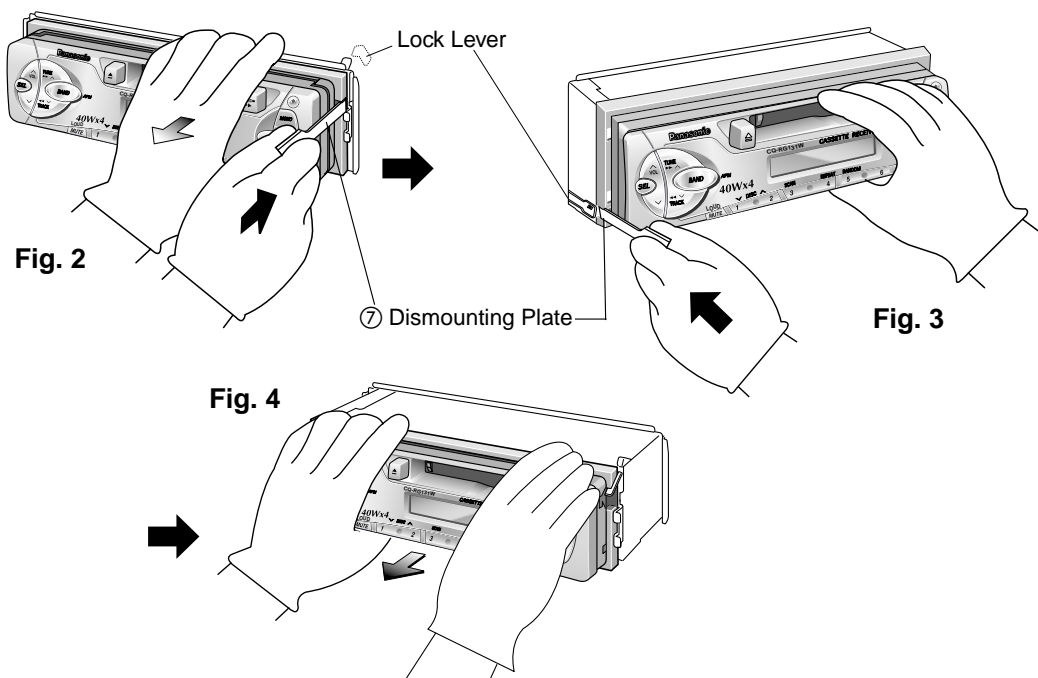

Note: Do not lose the Dismounting Plate. It will be needed to remove the unit from the car's dashboard.

Anti-Theft System

This unit is equipped with a removable face plate. By removing this face plate, the radio becomes totally inoperable. The security indicator will blink.

To Remove the Removable Face Plate

- a) Switch off the power.
- b) Press the release button () (Fig. 5).
The removable face plate will be released.

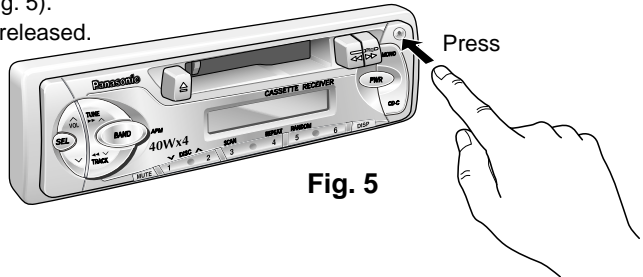

Fig. 5

- c) Remove the removable face plate by pulling on the right side of the unit. Place the removable face plate in a supplied case.

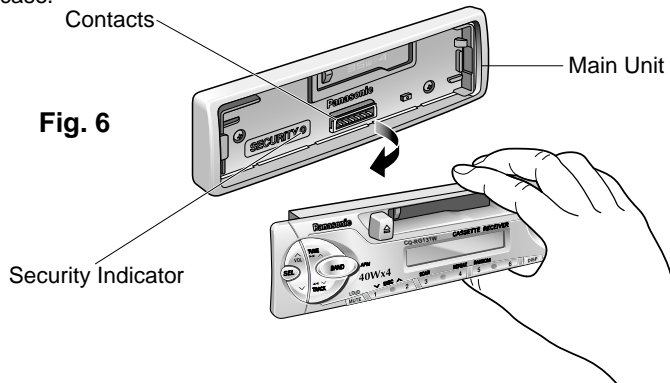

Fig. 6

- d) As shown in Fig.7, insert the removable face plate with the arrow pointing toward the removable face plate case until you hear a "click". Keep the removable face plate in the case. Then, you can bring the plate safely.

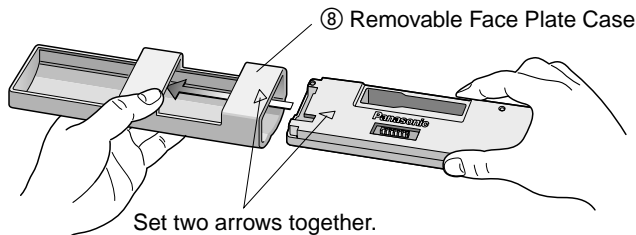
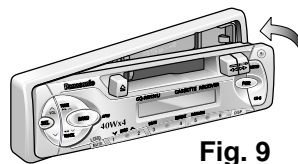
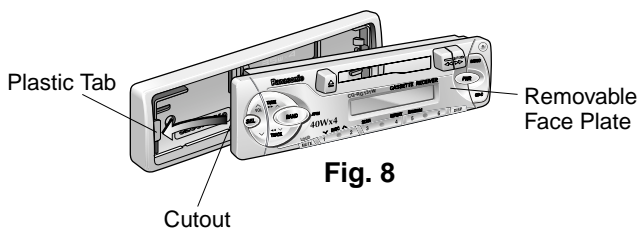

Fig. 7

To install the Removable Face Plate

- Slide the left side of the removable face plate in place.
- Press the right end of removable face plate until "click" is heard.



Cautions:

- Before removing the removable face plate, make sure the power is off.
- This removable face plate is not water-proof. Do not expose it to water or excessive moisture.
- Do not remove the removable face plate while driving your car.
- Do not place the removable face plate on the dashboard or nearby areas where the temperature rises to high levels.
- Do not touch the contacts on the removable face plate or on the main unit, since this may result in poor electrical contacts.
- If dirt or other foreign substances get on the contacts, wipe them with a clean, dry cloth.

Electrical Connection

- This unit can be connected to an optional CD changer (CX-DP88N). For details consult your nearest Panasonic Service center.
- For connection to a CD changer, refer to the operating instructions of the CD Changer (CX-DP88N).

Cautions:

- To prevent damage to the unit, be sure to follow the connection diagram below.
- Remove the covering of the leads about 5 mm long from their end before connecting.
- Do not insert the power connector into the unit until the wiring is completed.
- Be sure to insulate any exposed wires from a possible short-circuit from the car chassis. Bundle all cables and keep cable terminals free from touching any metal parts.

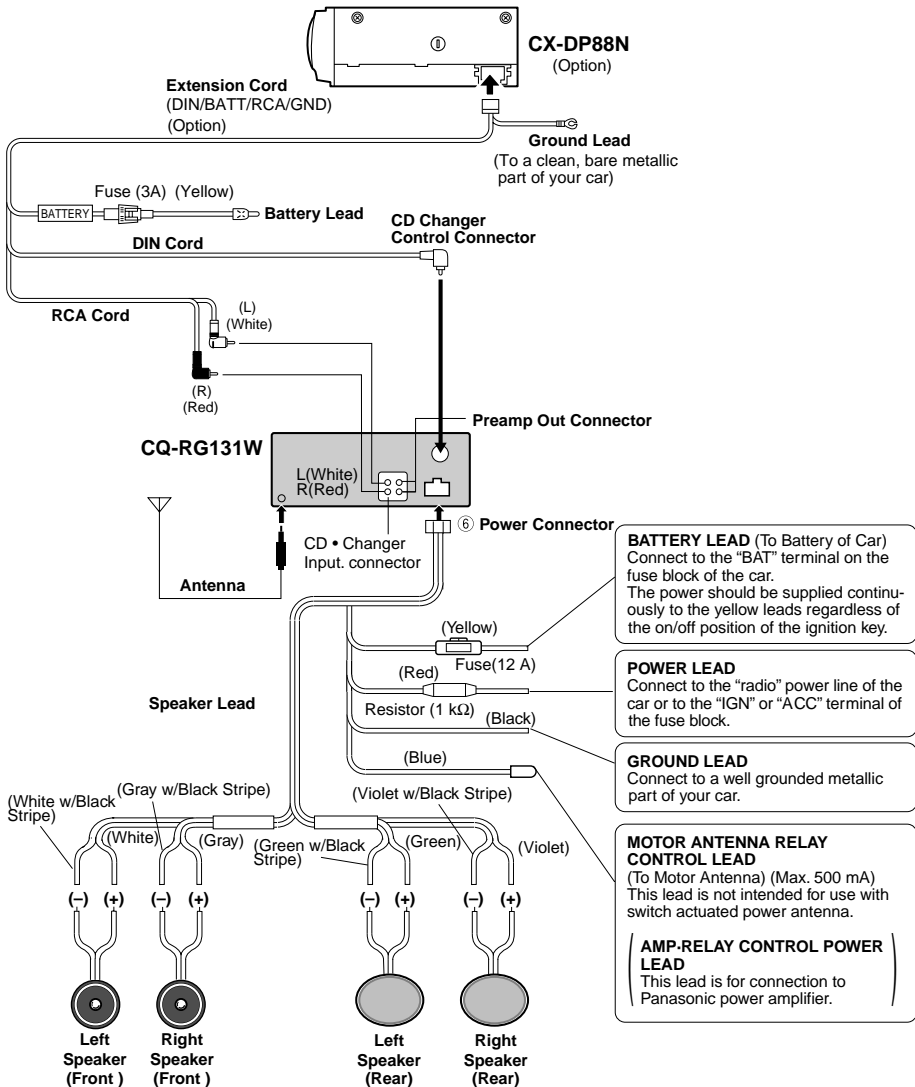

Speaker Connections

Cautions:

1. Use ungrounded speakers only.
2. The speakers to be used with this unit should be able to handle more than 40 W of audio power. If an optional amplifier is used, the speakers should be able to handle the maximum output power of the amplifier. Use of speakers with small input ratings can cause damage to the speakers.
3. The speaker impedance should be 4 - 8 ohms. If the impedance is too large or too small, it affects the output and may cause damage to the speakers or this unit.
4. Do not use 3-wire type speaker system having a common earth lead. Never connect the speaker cord to the body of the car. This unit uses the BTCL circuit, so each speaker should be connected separately using parallel vinyl insulated cords.
5. The speaker cords and the power amplifier unit should be kept away (about 30 cm apart) from the antenna and antenna extension cord.
6. Follow the connection diagram below carefully. Failure to do so may cause damage to both unit and speakers.

• Unit will be damaged if speakers (Front, Rear) are not connected properly.

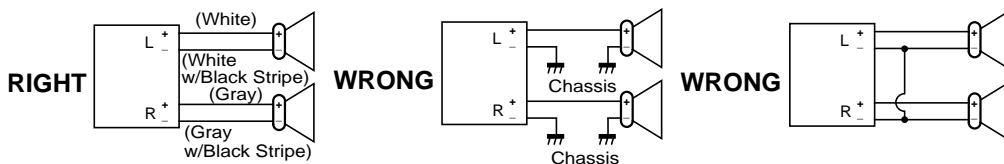

• Do not connect more than one speaker to one set of speaker leads.



Troubleshooting

❑ Troubleshooting Tips

PROBLEM	POSSIBLE CAUSE	PROBABLE SOLUTION
Unit will not turn on.	Dead vehicle battery. Ignition not on. Bad power line connection. Fuse burned out.	Charge vehicle battery. Turn ignition to On or Accessory. Check connections. Replace fuse.
Radio has static.	Antenna not hooked up. Close to high power lines.	Hook up antenna. Move away from high power lines.
Radio memory buttons do not work.	Not holding buttons down long enough.	Press and hold buttons for more than 2 seconds.
Tape sound quality is poor.	Heads are dirty. Poor quality tape.	Clean heads. (Ask a service representative for advice.) Use better quality tape.
Tape will not change programs.	Not pressing [▶▶] and [◀◀] buttons at the same time.	Press [▶▶] and [◀◀] buttons at the same time.
CD Changer will not operate.	Unit not properly connected. Unit not switched into CD Changer mode. No CDs in the magazine.	Check connections. Press [CD•C] . Check disc magazine.
CD Changer will not play a specific disc.	Disc loaded upside down. Disc damaged. Disc not loaded in magazine.	Reload disc properly. Check disc for scratches, chips. Check disc magazine.

Fuse

Be sure to use a fuse of the specified rating (12 A) when replacing a blown fuse. Fuses with higher capacity ratings, use of any substitute, or connection without a fuse may result in a fire hazard or damage to the unit. If the replacement fuse fails, consult your nearest authorized Panasonic Service Center.

Maintenance

To clean the exterior of this unit, use a soft cloth to wipe the surface. Do not use benzene, thinner or any other type of solvents.

Specifications

General

Power Supply	: DC 12 V (11 V - 16 V), Test Voltage 14.4 V, Negative Ground
Tone Controls	: Bass; ± 12 dB at 100 Hz Treble; ± 12 dB at 10 kHz
Current Consumption	: Less than 2.5 A (Tape mode, 0.5 W 4-Speaker)
Maximum Power Output	: 40 W x 4 (at 4 Ω)
Power Output	: 20 W x 4 (DIN45 324, at 4 Ω)
Speaker Impedance	: 4 Ω (4 - 8 Ω acceptable)
Dimensions (Main unit)	: 178(W) x 50(H) x 150(D) mm
Weight (Main unit)	: 1.6 kg

FM Stereo Radio

Frequency Range	: 87.5 - 108 MHz
Usable Sensitivity	: 6 dB/ μ V (S/N 30 dB)
Stereo Separation	: 35 dB (at 1 kHz)

AM Radio

Frequency Range	: 531 - 1602 kHz
Usable Sensitivity	: 28 dB/ μ V (S/N 20 dB)

Cassette Player

Reproduction System	: 4-track, 2-program stereo
Tape Speed	: 4.76 cm/sec.
FF/REW Time	: Less than 200 sec. (C-60)
Frequency Response	: 35 - 14000 Hz
Wow and Flutter	: 0.12 % (WRMS)
Signal to Noise Ratio	: 52 dB

Note: Specifications and the design are subject to possible modification without notice due to improvements.

电源与音量控制

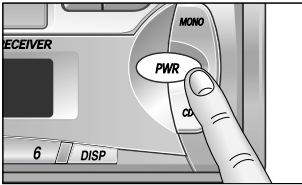
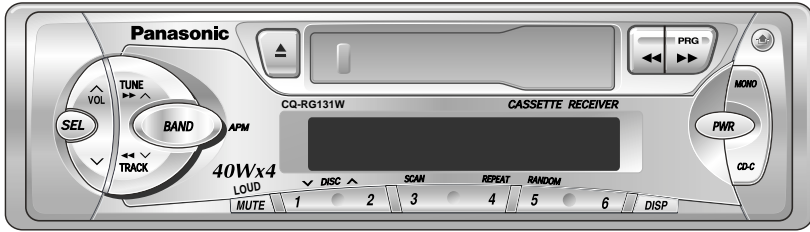

电源

如果汽车发动机不在运转，转动点火钥匙，直至附属的指示器点亮。按下[PWR]按钮，接通电源。

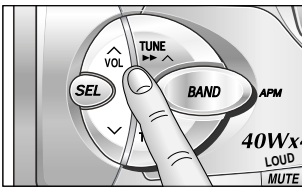

音量

- 按下[VOL^]或[VOLv]，增大或降低音量。

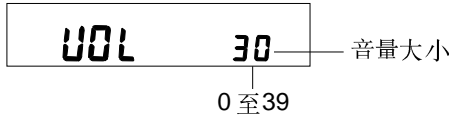

- 按下[VOL^]或[VOLv]按钮半秒以上，显示器上会连续变换数字。

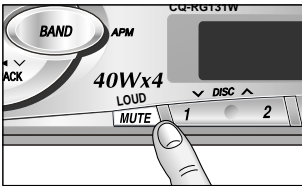

静音

- 按下[MUTE]，以减低音量。
- 完成此操作后，“MUTE”字样闪烁。



- 再次按下[MUTE]，以取消静音功能。

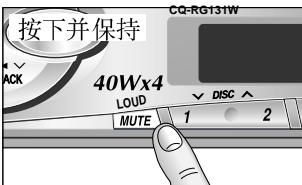

音质提高

- 当收听小或中音量时，按下并保持[MUTE](LOUD)钮2秒钟以上，提高低音和高音音质。而在收听大音量时。



- 在收听大音量时，再次按下并保持[MUTE](LOUD)按钮2秒钟以上，以取消此功能。

注：本装置配备了防止音量过载失真电路，其启动自动音量调节器，使其作用，因此您不会由于突然的大音量而感到惊愕。接通电源时，音量较小，然后音量会渐渐地变大恢复至关断电源以前的音量。音量电平低于显示的20以下位置时，防止音量过载失真电路是不起作用的。

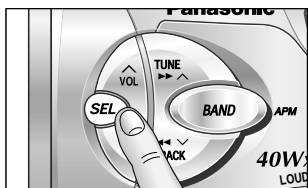

改变音频方式

按下[SEL]按钮，如下顺序选择音频方式。

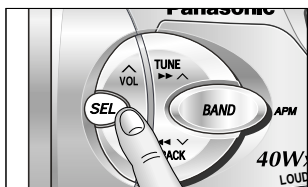
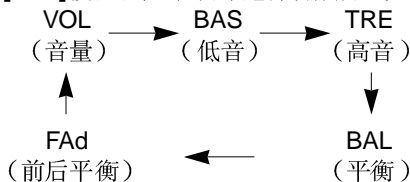

低音与高音

按下[SEL]按钮，选择低音（高音）方式。按下[VOL^]或[VOL∨]，增大或降低低音高音响应。

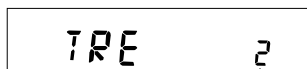
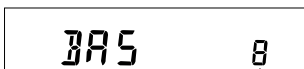

-12 至 0 (中心) 至 12

-12 至 0 (中心) 至 12

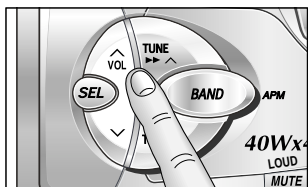

左右平衡

按下[SEL]按钮，选择左右平衡（BALANCE）方式。按下[VOL^]或[VOL∨]，可以使音量转换成右边或左边扬声器。



R 或 L 1 至 15

左右平衡中心

(R: 右边, L: 左边)

前后平衡

• 按下[SEL]按钮，选择音量前后平衡（FADER）方式。按下[VOL^]或[VOL∨]，能将音量转换成前部或后部扬声器。



F 或 R 1 至 15

音量前后平衡中心

(F: 前部, R: 后部)

注：当在音频控制方式[低音BAS/高音TRE/平衡BAL/前后平衡FAd]时，可进行选择。但如果5秒钟没有操作（音量VOL方式为2秒钟）时，显示将回复到普通操作（收音机、卡式磁带放音机、等）方式。在此情况下，再次按下SEL按钮，选择控制方式。

收音机基本操作

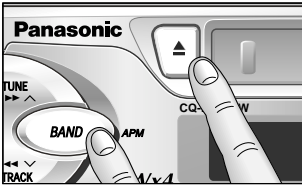
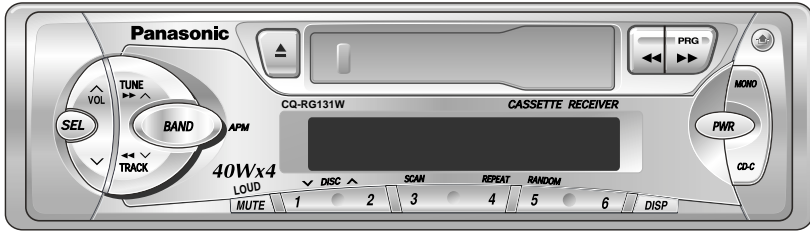

改变为收音方式

- ① 处于磁带方式时 取出磁带
- ② 处于CD换片器方式时 按下BAND按钮

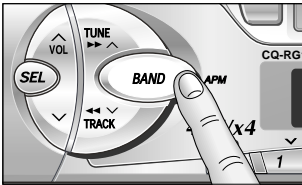

选择频道

按下频道[BAND]按钮，按下述顺序选择频道。

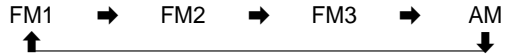

如果电台广播为立体声，“ST”显示器会点亮。

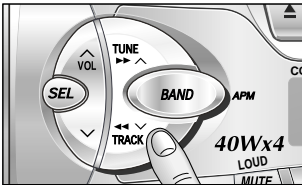
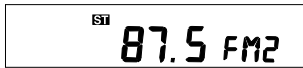

手动调谐

按下[TUNE ^]或[TUNE v]，可调谐至较低的或较高的频率。

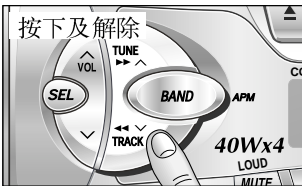

寻找调谐

按下并保持[TUNE ^]或[TUNE v]半秒钟以上，然后松开。收音机会自动停在下一个电台上。

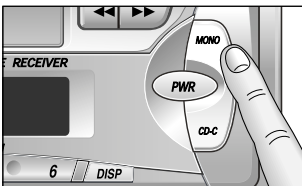

减少干扰 (MONO)

按下[MONO]频道可改善立体讯号中的杂讯、弱讯品质，再按[MONO]一次，取消之。

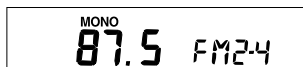

预调电台设定

在电台记存中，能如下所示预调24个电台。

FM1	FM2	FM3	AM
6个台	6个台	6个台	6个台

注意：为了安全，请勿在驾驶之中编制程序。

手控电台预调

- ① 按下[BAND] (频道)，选择所希望的频道。
- ② 使用手控或寻找调谐，寻找您想编入寄存器中的电台。
- ③ 按下并保持电台选择按钮[1]至[6]，直至表示闪烁。
反复此过程设定FM1至AM频道的其他电台。

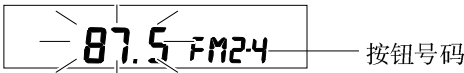
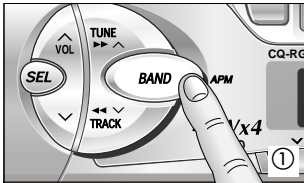

注：反复上述程序，您能改变寄存器设定。

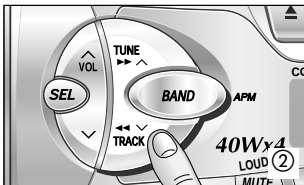

调谐到预调电台

按下[1]至[6]的任何一个按钮，调谐到由上述①至③步骤所预调的电台。

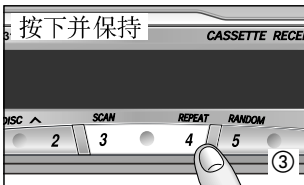

自动预调记存

选择一个频道，按下并保持[BAND] (APM) 频道（自动预调）按钮2秒钟以上。

- 能由[1]至[6]的预调按钮，将6个最强信号的电台自动地设定在寄存器内。
- 一旦设定好，预调电台会连续扫描5秒钟。
- 为您想收听的电台按下合适的预调按钮。

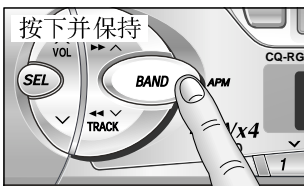

注：使用此功能设定电台会被消除

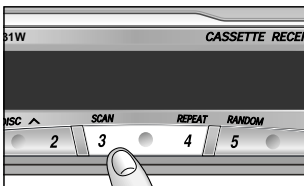

卡式磁带放音机基本操作

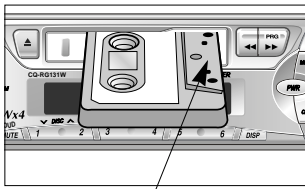
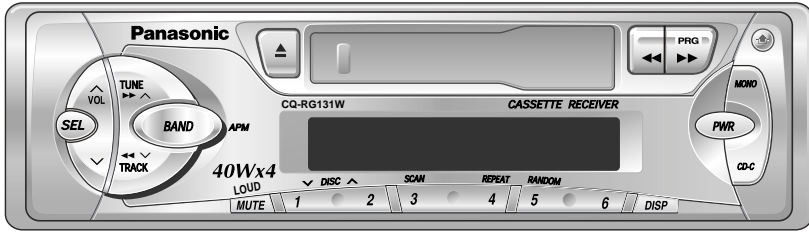

露出的磁带

装入卡式磁带

将露出磁带的一面朝右，轻轻地插入磁带仓，直至机构将其装入为止，并自动地开始放音。



磁带面指示
(此表示“U”为转动方向)

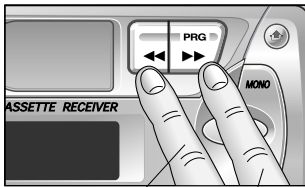

“▲” 点亮：倒带

“▼” 点亮：快进

“▼” 点亮：快进

“▲” 点亮：倒带

倒带与快进

在磁带面指示灯“▲”点亮时，按下[◀◀]进行倒带或按下[▶▶]进行该面磁带的快进。

在磁带面指示灯“▼”点亮时，按下[◀◀]进行快进磁带或按下[▶▶]进行该面磁带的倒带。



如停止倒带或快进，则轻轻地按下另一个未使用着的按钮。磁带将从该位置开始放音。

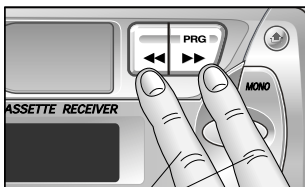

同时按下二个按钮

换磁带面

同时按下[◀◀]和[▶▶]按钮，则转换到磁带的另一面。在曲目开始放音时，显示的代表亦会改变。



上部侧放音



底部侧放音

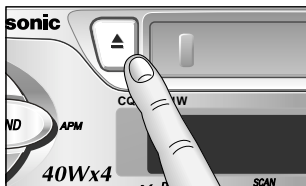

停止并取出磁带

一旦把磁带插入装置，则持续地放音该磁带，直至取出磁带为止。

如果按下[▲] (EJECT) 按钮，则装置会退出磁带并返回至收音机操作方式。

当停止了汽车的引擎时，磁带将停止，但不会退出。

注：

- 在磁带放音过程中，您无法改变为CD换片器方式或收音机方式。如果您打算改变为CD换片器方式或收音机方式，应先退出磁带。
- 如果不使用磁带放音机时，应取出磁带，这样会延长磁带的使用寿命。

关于盒式磁带的注意事项

磁带松弛：

用铅笔或类似的物品如图所示卷紧松弛部分。如果使用松弛的磁带，有可能会使磁带缠结在机构的转动部件上。

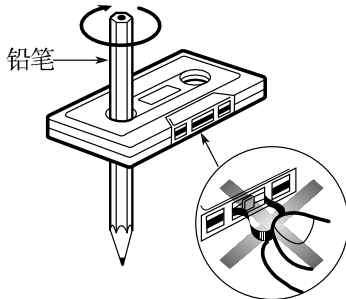

请勿触摸或拉出磁带。

注意：

- 为维持卡式磁带放音机的最佳操作状态，避免使用长于90分钟的磁带 (C-90)。
- 在此状况退出磁带，并将磁带系紧，然后再将磁带放入磁带放音机。

镭射唱片变换器的基本操作

注:

此镭射唱片变换功能是适用于代有配套镭射唱片变换器的装置的。
(分别售出)

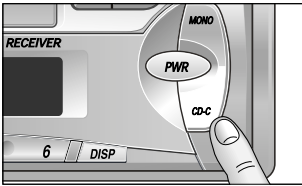
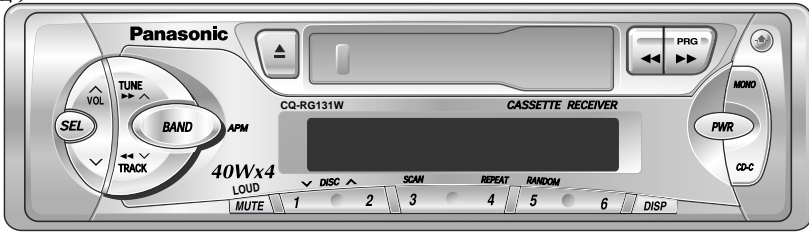

变换器模式

在唱片库被插入到镭射唱片变换器内时, 请按**[CD-C]**。放音将从第一音迹开始播放。



时间显示 镭射唱片编号 曲目编号

注: 如果里面装有卡式磁带, 应把它取出。否则镭射唱片不会开始播放。

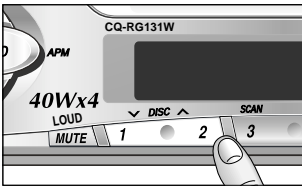

选择唱片

按下**[1]** (∨DISC)或**[2]** (DISC∧)按钮, 变换器将按上升或下降顺序选择唱片。

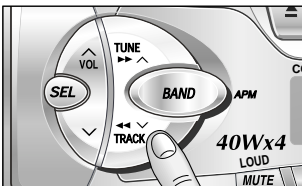
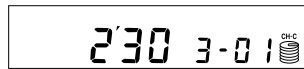

选择音迹

一按下**[TRACK▶▶]**, 就会到下一个音迹。反复按钮, 就会一个个地前进, 通过所有的音迹。

一按下**[TRACK◀◀]**, 就会从现在的音迹开始进行播放。按两次就会从以前的音迹开始进行播放。反复按钮, 就会一个个地退回, 通过所有的音迹。

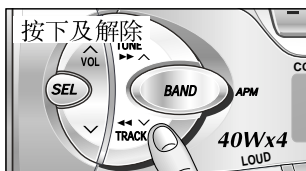

寻找音迹

按下并保持[TRACK▶▶]或[TRACK◀◀]0.5秒钟以上，就会快速向前或后退，并通过所有的音迹。解除[TRACK▶▶]或[TRACK◀◀]就会从其位置开始进行正常的镭射唱片播放。

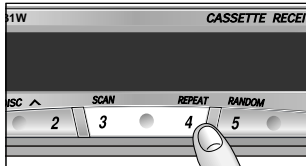

反复音迹

- 按下[4] (REPEAT) 可反复当前选择的音迹。“REPEAT”指示灯亮。
- 当前选择的音迹会持续反复直至您再次按[4] (REPEAT) 为止。

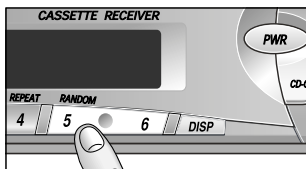
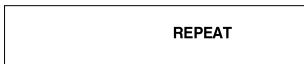

随机选择

- 按下[5] (RANDOM), 则在此张CD 唱片上全部曲目中随机地选择曲目放音。
- 再次按下[5] (RANDOM) 钮, 停止此功能。

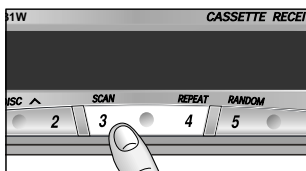
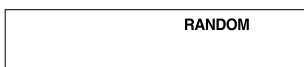

扫描音迹

- 按下[3] (SCAN) 按钮。显示器闪烁，唱片上每个音迹的头部10秒就会依次播放。
- 再次按下[3] (SCAN) 按钮，即可停止此音迹扫描并恢复到正在播放的音迹。

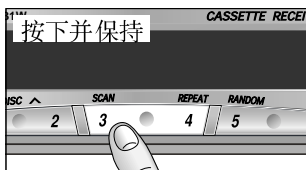
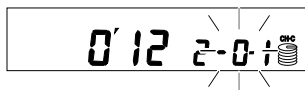

扫描唱片

按住[3] (SCAN) 不放达2秒钟以上。在唱片库中，所有镭射唱片的第一音迹会被逐次播放10秒钟。此外，唱片号码亦会同时闪动。如欲停止当前的唱片扫描播放，请再次按住[3] (SCAN) 不放达2秒钟以上。

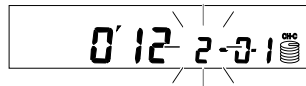

❑ 错误显示的启示

E1	CD 唱片有污垢或反装入时出现此显示。应选择下一个有效的唱片。	E3	在镭射唱片因某种原因而停止操作时显示。请关掉汽车发动机。请联络附近的 Panasonic 服务中心。
E2	CD 唱片有划痕时出现此显示。应选择下一个有效的唱片。	0000	在唱片库中没有唱片时将会显示。

时钟的基本操作

(时钟为12小时制)

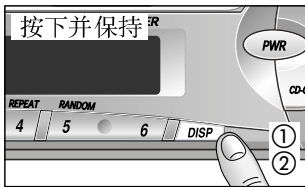
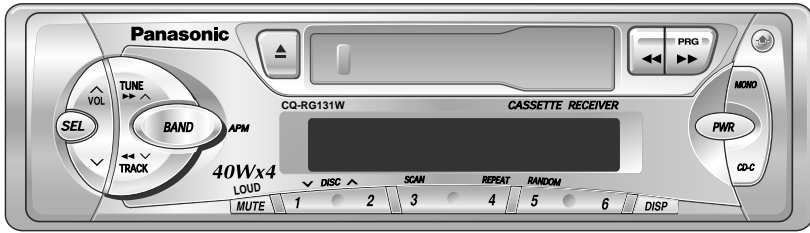

最初时间设定

- ① 按时钟，显示出“AdJ”。
- ② 再按住时钟不放达2秒钟以上。“12”闪动，表示时间设定模式被启动。
- ③ 如欲设定小时，请按[∧]或[∨]。
- ④ 再按时钟一次进行分钟设定。
- ⑤ 如欲设定分钟，请按[∧]或[∨]。按住[∧]或[∨]。不放，可让数字快速改变。
- ⑥ 当时间设定完毕之后，请按[DISP]。

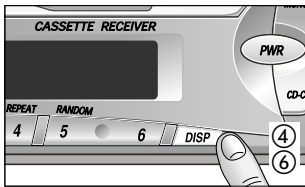
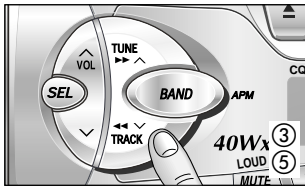
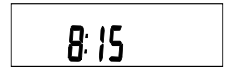
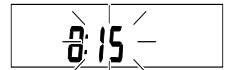
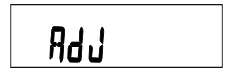

再次设定时间

当您想要重新设定时间时，请按住[DISP]不放达2秒钟以上便可启动时间设定模式。然后，请重复操作上述③到⑥的步骤。

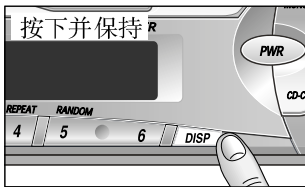

选择时间的表示

按[DISP]显示出时间表示。
再按[DISP]一次，可返回至当前音响表示的模式状态。

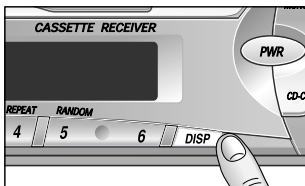

安装

准备

- 安装之前，通过天线与扬声器检查收音操作情况。
- 从负极 (-) 电池接线端子上卸除电缆线（参看下述注意事项）。
- 本装置的前后必须保持适当角度以水平位置安装，与水平的夹角不得超过30度。

注意：

如果断开此装置或安装卫星导航器于汽车上，在卸除电池接线端子时，预先记录在计算机中的所有电子记存器设定都会失去。因此这种形式的汽车，不能卸除电池。为此，务必特别注意防止短路。

仪表内安装

安装开口

如果汽车仪表板具有如图1所示供本装置使用的开口。为了进行装置的安装，汽车仪表板开口应有4.5 mm - 6 mm的厚度。



图 1

安装注意事项

本设备在可能的情况下应由专业安装者进行安装。

在有困难的情况下，应向您附近公认的Panasonic维修中心进行咨询。

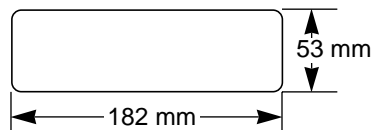
1. 本系统只能用于具有负极接地的12伏直流电池系统的车辆上。
2. 仔细遵照36页的电气连接法。如果接错，会损伤装置。
3. 应在其他部分连接之后，再连接电源线。
4. 务必将黄色导线接在电池的正极接线端 (+) 或熔断器 (BAT) 接线端子上。
5. 应绝缘暴露的电线，避免短路。
6. 安装装置之后，应固定所有松动的电线。
7. 连接到装置上之前，应仔细阅读各个设备的操作与安装说明书。

备有附件

编号	项目	简图	数量
①	安装环		1
②	六角螺母(5 mm φ)		1
③	后部固定板		1
④	自切螺 (5 mm φ x 16 mm)		1

编号	项目	简图	数量
⑤	安装螺栓 (5 mm φ)		1
⑥	电源连接器		1
⑦	卸除片		1
⑧	可移动面板盒		1

安装 (續前)

安装步骤

注意：把导线从负极(-)电池端子上分离下来。

1. 固定安装环 ①

将安装环①插入汽车仪表板中，使用螺丝刀将安装薄片向外弯曲。

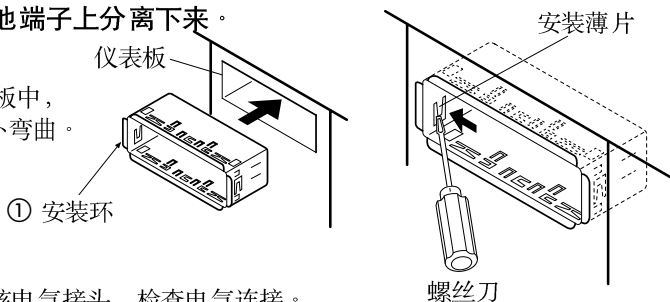

2. 固定装置后部

- 参照本操作说明书检查该电气接头，检查电气连接。
- 使用合适的扳手连接安装螺栓⑤。
- 把电源连接器⑥插入装置上。

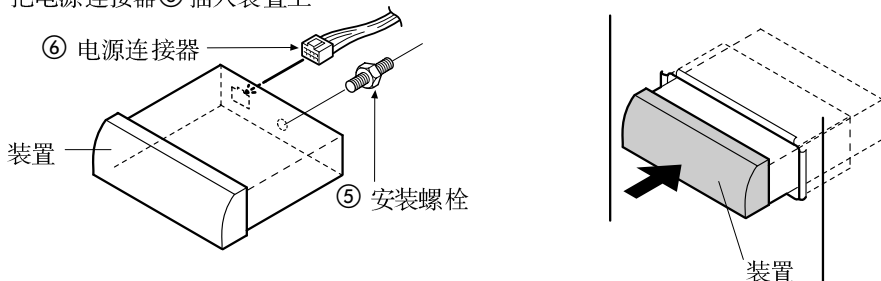

- 将装置插入安装环①之内，将其推入安装环中，直至听到“卡嗒”声为止。
- 采用二种推荐方法的任何一种，将装置后部固定于车上。

■ 使用后部固定板 ③

将后部固定板③尾部一端固定于装置的后部，将另一端尾部固定在汽车的隔板上或其他金属部位上。

■ 使用橡皮衬垫 (选购件)

(如果这是汽车隔板上原有的后部固定座架)

使用橡皮衬垫 (选购件)，在装置的后部盖上安装螺栓⑤，并将其安装在现有的后部固定座架上。

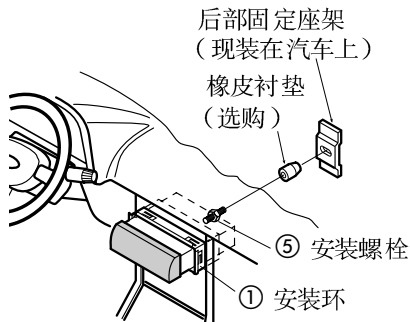
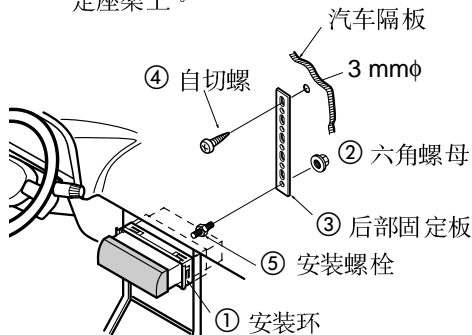

3. 安装之后，重新连接负极(-) 电池接线端子。

卸除装置

a) 按照下图用螺丝刀卸下装饰面板 (图1)。



b) 如下图所示 (图2, 3), 用附带的卸除片⑦推入两处锁卡, 然后向外拉出装置。
c) 用双手拉出, 卸除装置。(图4)

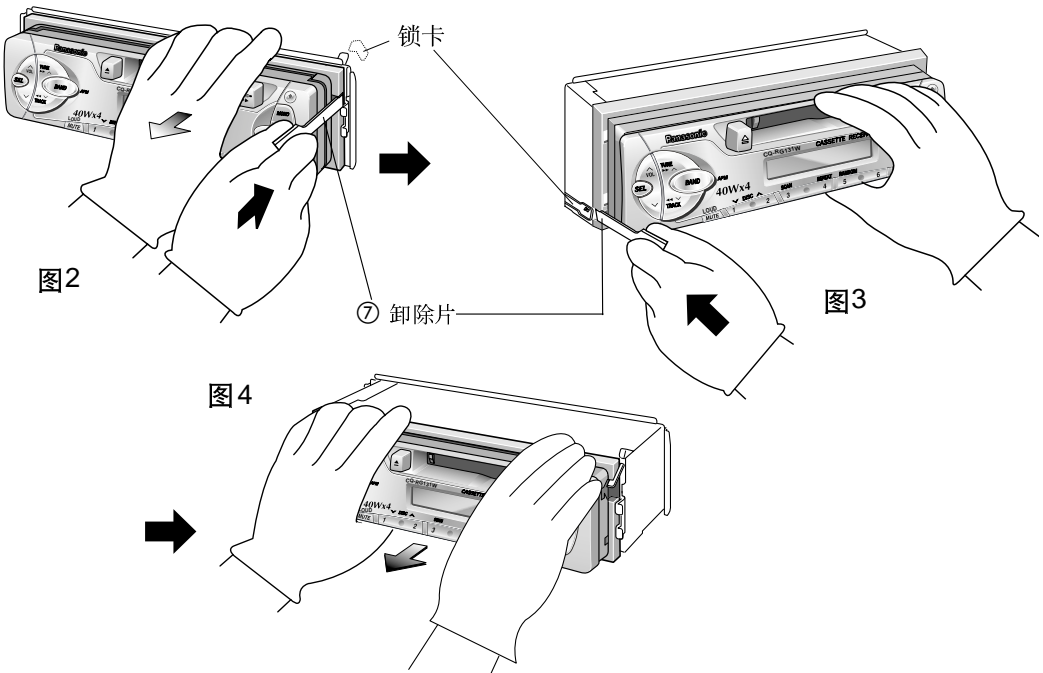

注: 不要丢失卸除片, 在从汽车仪表板上装卸本装置时, 此卸除片是有用的。

防盗系统

本装置配备有可拆卸面板。卸下此面板时，收音机将完全无效。安全指示器将闪烁表示。

拆卸可移动面板

- 关闭电源
- 按下释放按钮 (⬆️) (图5)，可拆卸面板即可卸下。

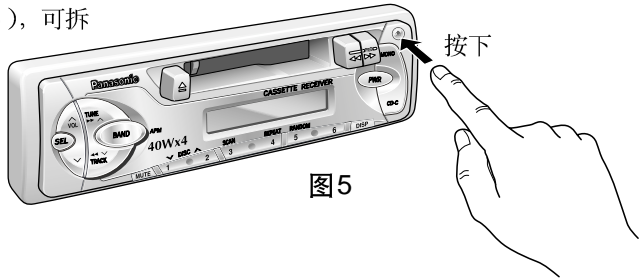

- 先扳除装置的右侧，拆卸可移动面板。将可移动面板放入存放盒中。

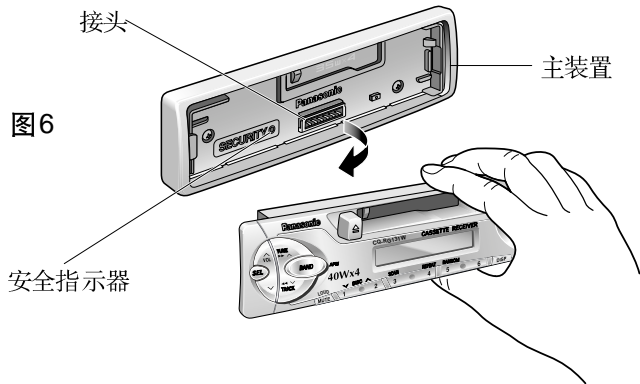

- 如图7所示，按照箭头方向将移动面板插入移动面板存放盒中，直至听到“卡嗒”声，然后您就可以安全地携带盒子。



图7

安装可移动面板

- a) 将可移动面板滑入位置。
- b) 推下可移动面板右侧，直至听到“卡嗒”声为止。

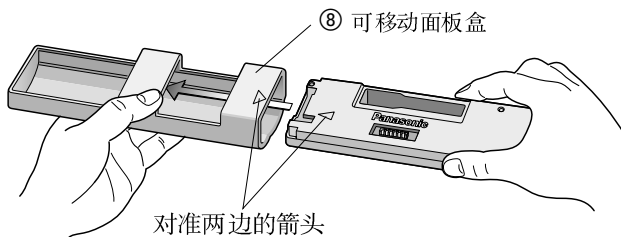
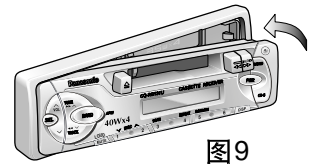
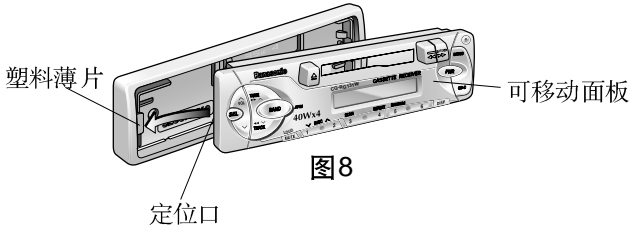

注意：

1. 卸除可移动面板之前，应确认电源是否切断。
2. 本可移动面板不防水，故不能使其沾水或水气过多。
3. 驾驶汽车时，请勿卸除可移动面板。
4. 请勿将可移动面板放在仪器板上或接近高温的地方。
5. 请勿触碰可移动面板或主装置上的接点，因为这会引起电气接触不良。
6. 如果接点弄脏或沾有其它杂质之时，应使用干净的布擦净。

电气连接

- 本装置可以连接选购件的镭射唱片换片器 (CX-DP88N)。详情请向您附近的Panasonic 销售店询问。
- 连接镭射唱片换片器，请参阅该镭射唱片换片器 (CX-DP88N) 的安装使用说明书。

注意:

- 为了防止装置损伤，应按下述图框进行连接。
- 连接之前，应去除导线5 mm 左右的绝缘外皮。
- 在连接其他导线至汽车上特定的电线之前，请务必首先将接地导线（黑色）连接至汽车底盘。
- 务必绝缘任何暴露的电线，防止可能与汽车架发生的短路。捆扎好所有电缆线，避免电缆线接线端子与任何金属部分触及。

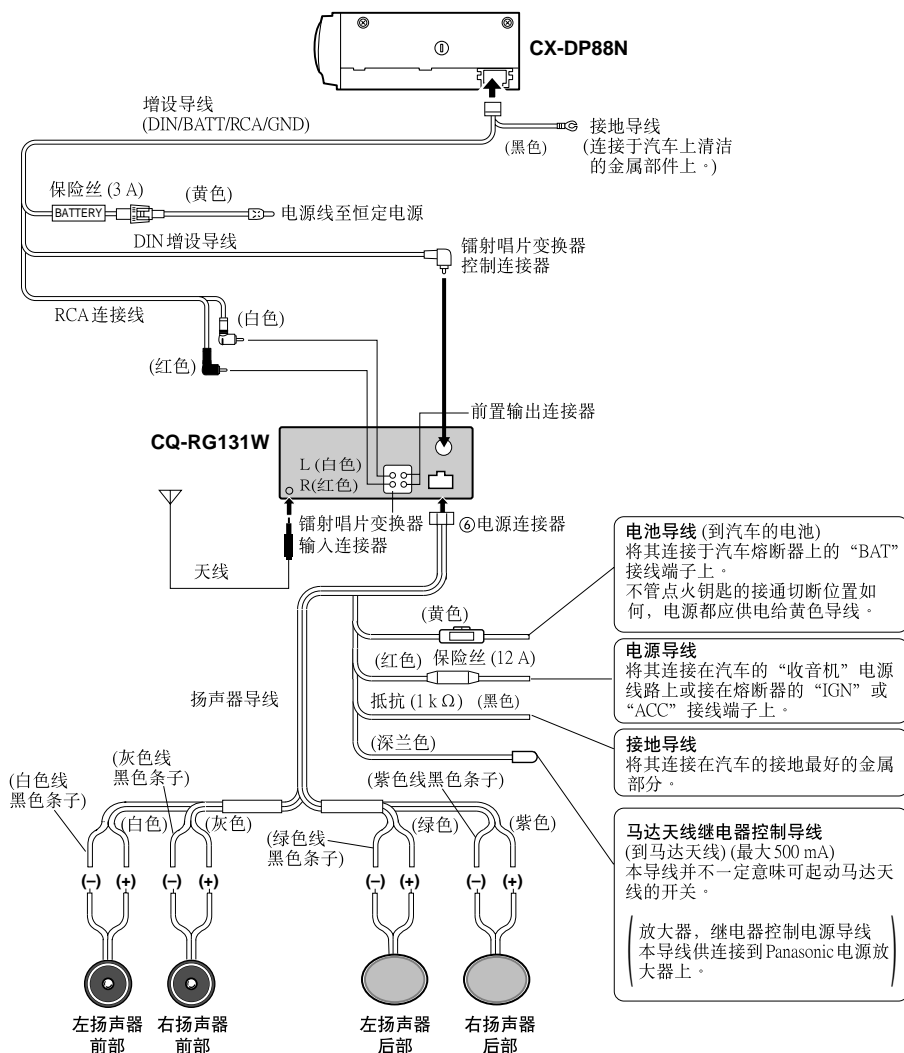

扬声器连接

注意:

1. 只使用非接地扬声器。
2. 本装置使用的扬声器可承受音频功率务必在40 W 以上。如果使用选购件的放大器，扬声器务必能承受放大器的最大输出功率，使用小的输入功率的扬声器，会损伤扬声器。
3. 扬声器阻抗应为4 ~ 8 欧姆。如果阻抗过于大或过于小，就会影响输出功率，并可能损伤扬声器或本装置。
4. BTCL 电路，因此每个扬声器务必使用并联聚氯乙烯绝缘线分别连接。
5. 扬声器线与电源放大器装置应离开天线与天线延长线(约离开 30 cm)。
6. 请仔细按照下述连接图进行连接。连接错误会损伤装置。

- 如果扬声器（前部，后部）连接不正确，就会损伤装置。

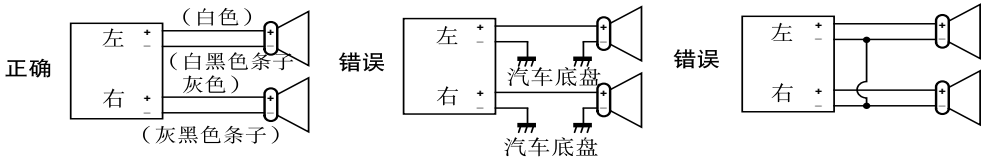

- 请勿在一组扬声器导线上多接扬声器。



故障排除

□ 故障排除的提示

故障	可能的原因	可能的解决方法
不能接通装置的电源	电瓶失效。 未接通点火钥匙。 电源导线接线不良。保险丝断路。	换用有效的电瓶。 转动点火钥匙至 ON 或 ACC 处。 检查接线。更换保险丝。
收音机无声	未拉出天线。 在高压线附近。	拉出天线。 远离高压线附近。
收音机记忆按钮不起作用	按下按钮的保持时间不够长。	按下并保持按钮2秒钟以上。
磁带放音音质差	磁头有污垢。 磁带质量不好。	清洁磁头（应通知有资格的维修人员来完成）。 使用高质量磁带。
磁带曲目不能改变	没有同时按下[▶▶]和[◀◀]按钮。	同时按下[▶▶]和[◀◀]按钮。
CD 唱片换片器不能动作	装置没有正确地连接。 装置没有转换到CD 唱片换片器方式上。 唱片库中没有CD 唱片。	检查接线。 按下[CD·C]按钮，转换为CD 唱片换片器方式。 检查CD 唱片库。
CD 唱片换片器不能放音指定的唱片	CD 唱片的装入方向相反。 有损伤的CD 唱片。 唱片库中未装入该CD 唱片。	正确地装入CD 唱片。检查CD 唱片是否有划痕、破损。 检查CD 唱片库。

保险丝

更换烧断的保险丝之时，务必使用规定额定 (12 A) 的保险丝。以高容量额定的保险丝代替使用，或者不使用保险丝而直接连接，易引起燃烧或损坏装置。如果更换保险丝后有故障，请与附近公认的Panasonic维修中心取得联系。

维修

清洗本装置外部，务必使用软布擦洗表面。请勿使用汽油，稀释剂或其他形式的溶剂。

规格

一般标准

电源：	DC 12 V (11 V - 16 V)，测试电压14.4 V，负极接地
音量控制：	低音; 100 Hz 时 ± 12 dB 高音; 10 kHz 时 ± 12 dB
电流消耗：	小于2.5 A (镭射唱片方式，0.5 W 4 只扬声器)
最大功率输出：	40 W × 4 (4 欧姆时)
功率输出：	20 W × 4 (4 欧姆时DIN45 324 4 欧姆时)
扬声器阻抗：	4 Ω (4 - 8 Ω可被接受)
尺寸：	178 (宽) × 50 (高) × 150 (深) mm
重量：	1.6 公斤

FM立体收音机

频率范围：	87.5 - 108 MHz
有效灵明度：	6 dB/ μ V (S/N 30 dB)
立体声区分：	35 dB (1 kHz 时)

AW收音机

频率范围：	531 - 1602 kHz
有效灵敏度：	28 dB/ μ V (S/N 20 dB)

磁带放音机

重放系统：	4 声道，2 面立体声
磁带速度：	4.76 cm/sec
快进/倒带时间：	小于200 秒 (C-60)
频率响应：	35 - 14000 Hz (标准)
异抖度：	0.12 % (WRMS)
信噪比：	52 dB

注：因产品改良，规定与设计会不预告而进行改变，请见谅。

Matsushita Electric Industrial Co., Ltd.

Central P.O. Box 288, Osaka 542-8588, Japan

松下電器産業株式会社
松下通信工業株式会社

汽车音响系统事业部

日本

大阪

YFM284C346CC TAMACO0102-0 Printed in Taiwan

Free Manuals Download Website

<http://myh66.com>

<http://usermanuals.us>

<http://www.somanuals.com>

<http://www.4manuals.cc>

<http://www.manual-lib.com>

<http://www.404manual.com>

<http://www.luxmanual.com>

<http://aubethermostatmanual.com>

Golf course search by state

<http://golfingnear.com>

Email search by domain

<http://emailbydomain.com>

Auto manuals search

<http://auto.somanuals.com>

TV manuals search

<http://tv.somanuals.com>