



### Overview

As electronic products have come to feature more sophisticated functions, more compact sizes and lighter weights, the sources of power that operate these products have been required to deliver increasingly higher levels of energy. To meet this requirement, nickel-metal hydride batteries have been developed and manufactured with nickel hydroxide for the positive electrode and hydrogen-absorbing alloys, capable of absorbing and releasing hydrogen at high-density levels, for the negative electrode. Because Ni-MH batteries have about twice the energy density of Ni-Cd batteries and a similar operating voltage as that of Ni-Cd batteries, they are expected to become a mainstay in the next generation of rechargeable batteries.

### Construction

Nickel-metal hydride batteries consist of a positive plate containing nickel hydroxide as its principal active material, a negative plate mainly composed of hydrogen-absorbing alloys, a separator made of fine fibers, an alkaline electrolyte, a metal case and a sealing plate provided with a self-resealing safety vent. Their basic structure is identical to that of Ni-Cd batteries. With cylindrical nickel-metal hydride batteries, the positive and negative plates are separated by the separator, wound into a coil, inserted into the case, and sealed by the sealing plate through an electrically insulated gasket.

With prismatic nickel-metal hydride batteries, the positive and negative plates are sandwiched together in layers with separators between them, inserted into the case, and sealed by the sealing plate.

# NICKEL METAL HYDRIDE BATTERIES - CONTINUED

## Structure of Nickel Metal Hydride Batteries

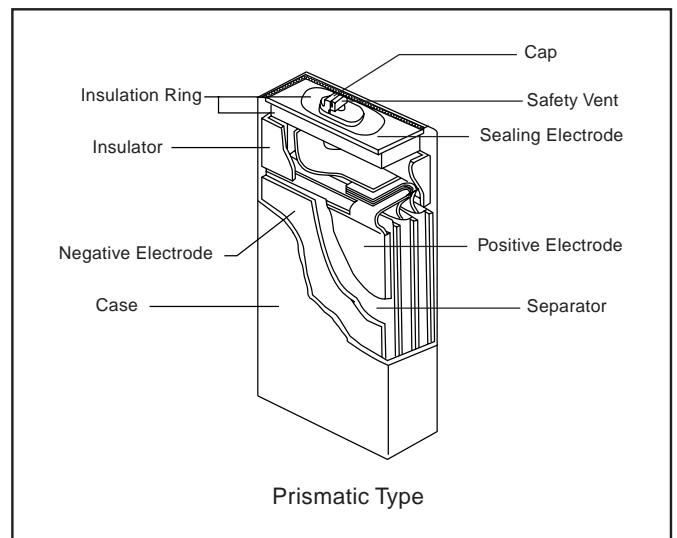
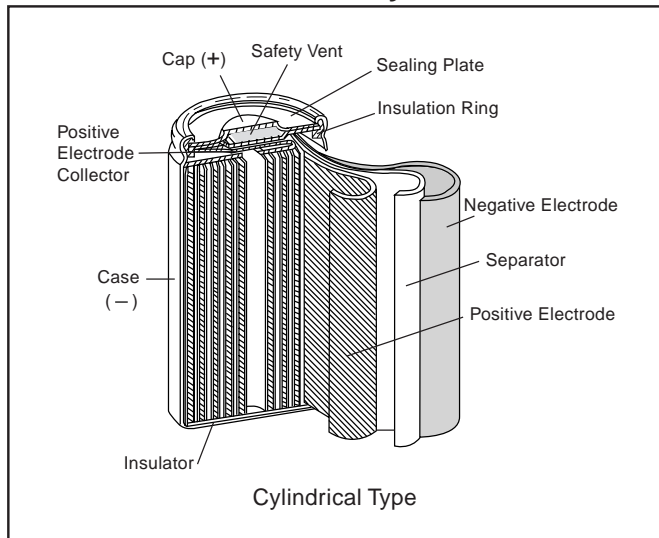

## Principle of Electrochemical Reaction Involved in Batteries

### Hydrogen-absorbing Alloys

Hydrogen-absorbing alloys have a comparatively short history which dates back about 20 years to the discovery of NiFe, MgNi and LaNi<sub>5</sub> alloys. They are capable of absorbing hydrogen equivalent to about a thousand times of their own volume, generating metal hydrides and also of releasing the hydrogen that they absorbed. These hydrogen-absorbing alloys combine metal (A) whose hydrides generate heat exothermically with metal (B) whose hydrides generate heat endothermically to produce the suitable binding energy so that hydrogen can be absorbed and released at or around normal temperature and pressure levels. Depending on how metals A and B are combined, the alloys are classified into the following types: AB (TiFe, etc.), AB<sub>2</sub> (ZnMn<sub>2</sub>, etc.), AB<sub>5</sub> (LaNi<sub>5</sub>, etc.) and A<sub>2</sub>B (Mg<sub>2</sub>Ni, etc.). From the perspective of charge and discharge efficiency and durability, the field of candidate metals suited for use as electrodes in storage batteries is now being narrowed down to AB<sub>5</sub> type alloys in which rare-earth metals, especially metals in the lanthanum group, and nickel serve as the host metals; and to AB<sub>2</sub> type alloys in which the titanium and nickel serve as the host metals. Panasonic is now focusing its attention on AB<sub>5</sub> type alloys which feature high capacity, excellent charge and discharge efficiency, and excellent cycle life. It has developed, and is now employing its own MmNi<sub>5</sub> alloy which uses Mm (misch metal = an alloy consisting of a mixture of rare-earth elements) for metal A.

### Principle of Electrochemical Reaction Involved in Batteries

Nickel-metal hydride batteries employ nickel hydroxide for the positive electrode similar to Ni-Cd batteries. The hydrogen is stored in a hydrogen-absorbing alloy for the negative electrode, and an aqueous solution consisting mainly of potassium hydroxide for the electrolyte. Their charge and discharge reactions are shown below.

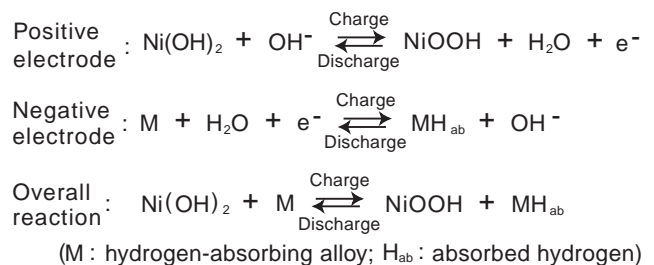

As can be seen by the overall reaction given above, the chief characteristics of the principle behind a nickel-metal hydride battery is that hydrogen moves from the positive to negative electrode during charge and reverse during discharge, with the electrolyte taking no part in the reaction; which means that there is no accompanying increase or decrease in the electrolyte. A model of this battery's charge and discharge mechanism is shown in the figure on the following page. These are the useful reactions taking place at the respective boundary faces of the positive and negative electrodes, and to assist one in understanding the principle, the figure shows how the reactions proceed by the transfer of protons (H<sup>+</sup>).

# NICKEL METAL HYDRIDE BATTERIES - CONTINUED

The hydrogen-absorbing alloy negative electrode successfully reduces the gaseous oxygen given off from the positive electrode during overcharge by sufficiently increasing the capacity of the negative electrode which is the same method employed by Ni-Cd batteries. By keeping the battery's internal pressure constant in this manner, it is possible to seal the battery.

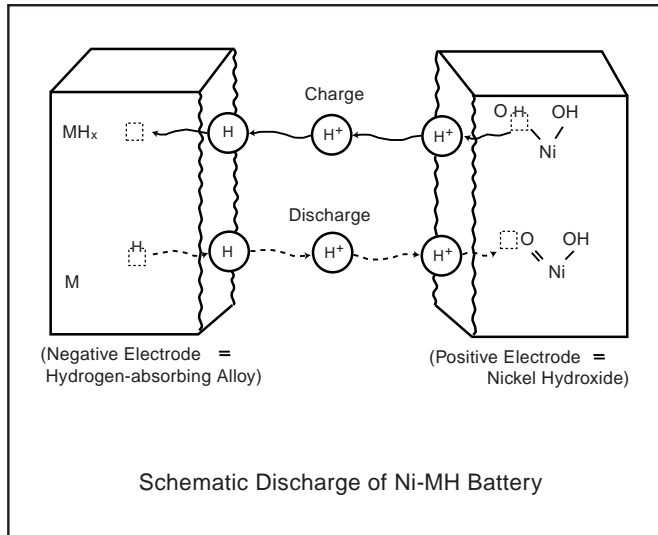

## Features

- **Similarity with Ni-Cd batteries**  
These batteries have similar discharge characteristics to those of Ni-Cd batteries.
- **Double the energy density of conventional batteries**

Nickel-metal hydride batteries have approximately double the capacity compared with Panasonic's standard Ni-Cd batteries.

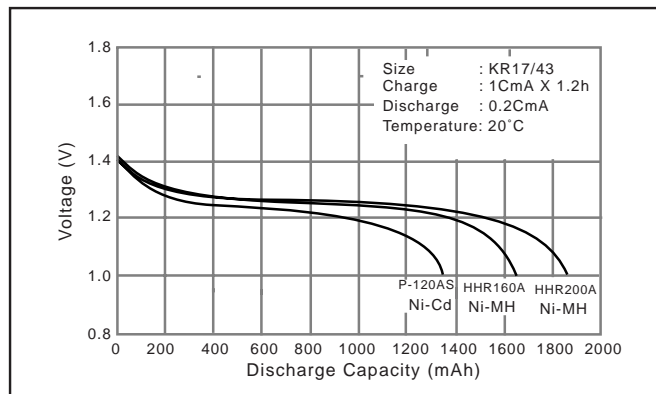

- **Cycle life equivalent to 500 charge and discharge cycles**

Like Ni-Cd batteries, nickel-metal hydride batteries can be repeatedly charged and discharged for about 500 cycles. (example: IEC charge and discharge conditions)

- **Rapid charge in approx. 1 hour**

Nickel-metal hydride batteries can be rapidly charged in about an hour using a specially designed charger.

- **Excellent discharge characteristics**

Since the internal resistance of nickel-metal hydride batteries is low, continuous high-rate discharge up to 3CmA is possible, similar to Ni-Cd batteries.

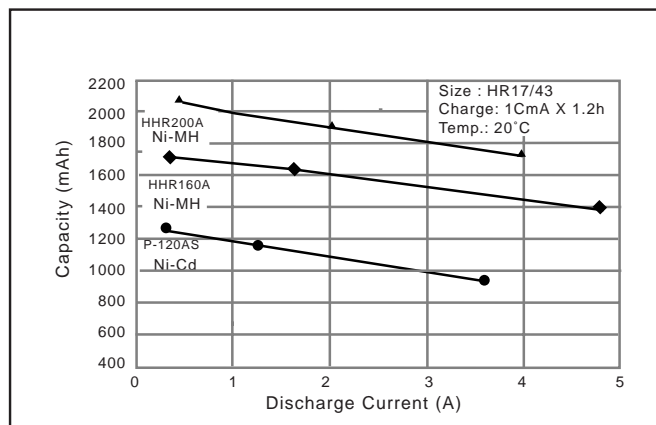

# NICKEL METAL HYDRIDE BATTERIES - CONTINUED

## Five Main Characteristics

As with Ni-Cd batteries, nickel-metal hydride batteries have five main characteristics: charge, discharge, storage life, cycle life and safety.

- **Charge characteristics**

Like Ni-Cd batteries, the charge characteristics of nickel-metal hydride batteries are affected by current, time and temperature. The battery voltage rises when the charge current is increased or when the temperature is low. The charge efficiency differs depending on the current, time, temperature and other factors.

Nickel-metal hydride batteries should be charged at a temperature ranging from 0°C to 40°C using a constant current of 1C or less. The charge efficiency is particularly good at a temperature of 10°C to 30°C. Repeated charge at high or low temperatures causes the battery performance to deteriorate. Furthermore, repeated overcharge should be avoided since it will downgrade the battery performance.

Refer to the section on recommended charge methods for details on how to charge the batteries.

- Charge characteristics

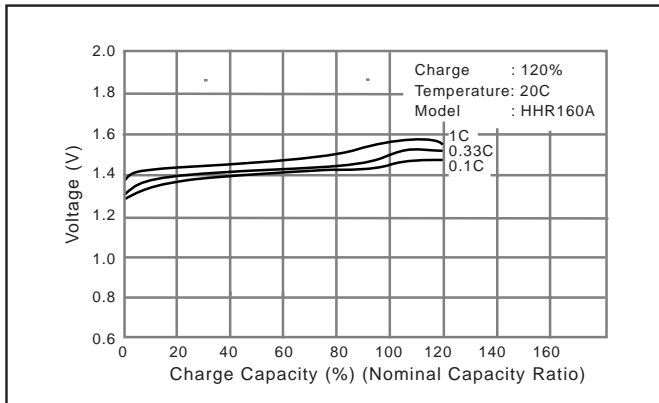

- Charge temperature characteristics at 1C charge

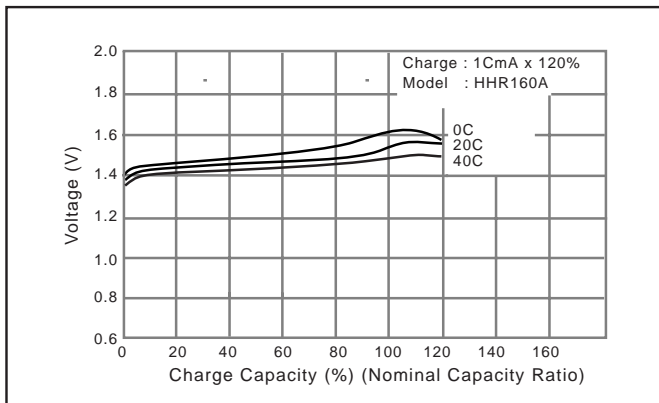

- Charge temperature characteristics at various charge rates

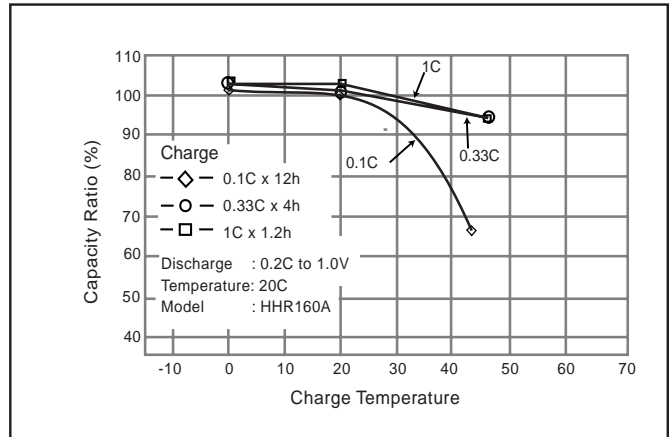

- **Discharge characteristics**

The discharge characteristics of nickel-metal hydride batteries are affected by current, temperature, etc., and the discharge voltage characteristics are flat at 1.2V, which is almost the same as for Ni-Cd batteries. The discharge voltage and discharge efficiency decrease in proportion as the current rises or the temperature drops. As with Ni-Cd batteries, repeated charge and discharge of these batteries under high discharge cut-off voltage conditions (more than 1.1V per cell) causes a drop in the discharge voltage (which is sometimes accompanied by a simultaneous drop in capacity). The discharge characteristics can be restored by charge and discharge to a discharge end voltage of down to 1.0V per cell.

- Discharge characteristics

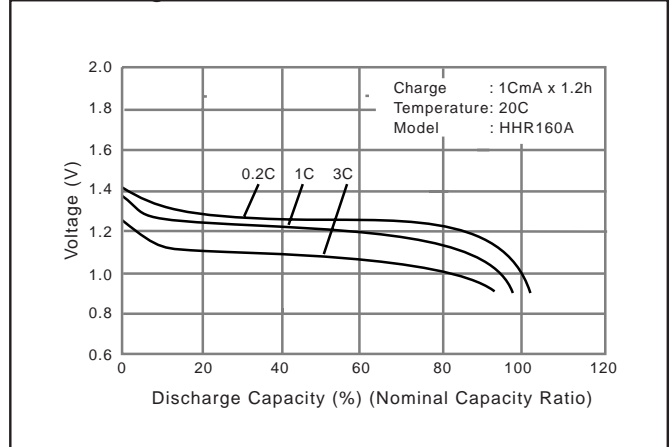

# NICKEL METAL HYDRIDE BATTERIES - CONTINUED

- Discharge temperature characteristics at 1C discharge

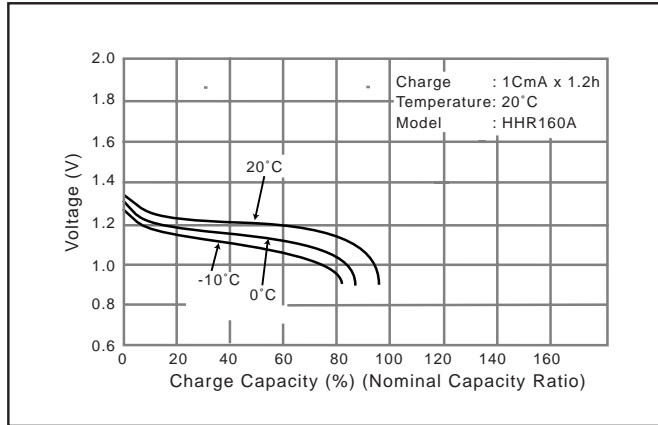

- Discharge temperature characteristics

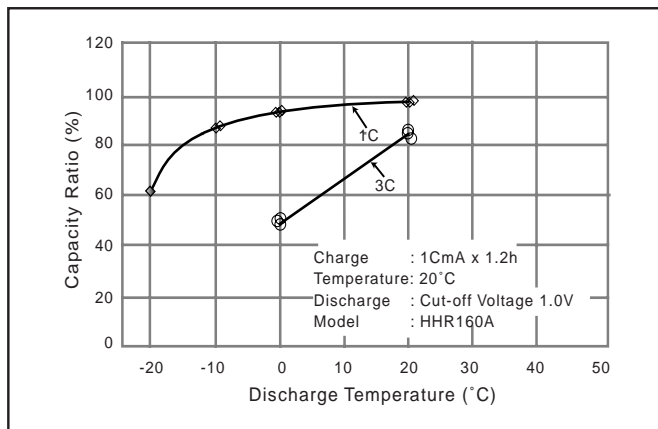

## Storage characteristics

These characteristics include self-discharge characteristics and restoration characteristics after long-term storage. When batteries are left standing, their capacity generally drops due to self-discharge, but this is restored by charge.

- Self discharge characteristics

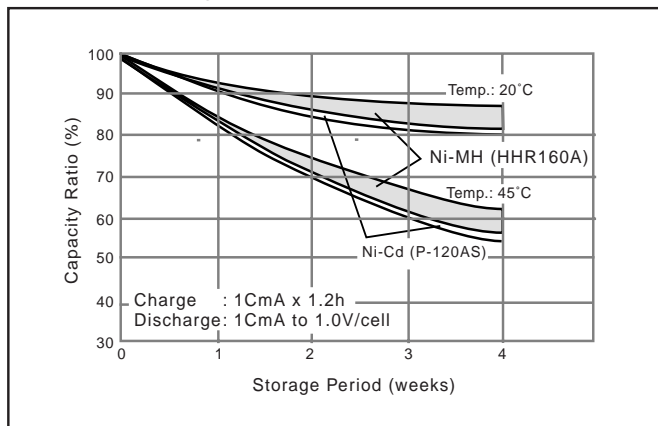

Self-discharge is affected by the temperature at which the batteries are left standing and the length of time during which they are left standing. It increases in proportion as the temperature or the shelf-standing time increases. Panasonic's nickel-metal hydride batteries have excellent self-discharge characteristics that are comparable to those of Ni-Cd batteries.

## Cycle Life Characteristics

The cycle life of these batteries is governed by the conditions under which they are charged and discharged, temperature and other conditions of use. Under proper conditions of use (example: IEC charge and discharge conditions), these batteries can be charged and discharged for more than 500 cycles.

- Cycle life characteristics

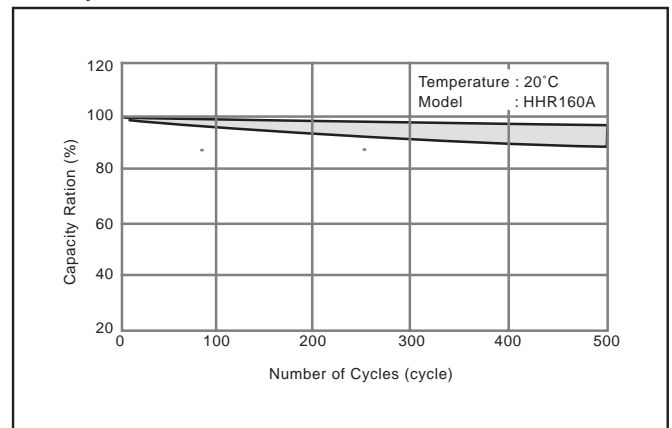

## Safety

When the internal pressure of these batteries rises due to overcharge, short-circuiting, reverse charge or other abuse or misuse, the self-sealing safety vent is activated to prevent battery damage. Panasonic's nickel-metal hydride batteries have similar safety characteristics as Panasonic Ni-Cd batteries.

## Free Manuals Download Website

<http://myh66.com>

<http://usermanuals.us>

<http://www.somanuals.com>

<http://www.4manuals.cc>

<http://www.manual-lib.com>

<http://www.404manual.com>

<http://www.luxmanual.com>

<http://aubethermostatmanual.com>

Golf course search by state

<http://golfingnear.com>

Email search by domain

<http://emailbydomain.com>

Auto manuals search

<http://auto.somanuals.com>

TV manuals search

<http://tv.somanuals.com>