

Panasonic
ideas for life

Matrix System 650EX

MATRIX SYSTEM 650EX



Matrix System 650EX. Enhancing Large-System Surveillance.

Up to 512 cameras and 64 monitors, plus up to 64-domain Satellite capability

The new Panasonic *Matrix System 650EX* redefines "advanced" in large-system surveillance.

This new EXpanded edition of the world-renowned System650 adds the new WJ-MPU955A Main CPU, for flexible, fully integrated control of up to 512 cameras and 64 monitors.

Plus, our new WJ-ASC960 software upgrade makes the configuration of systems with up to 64 Satellite domains possible. For anyone needing to construct large scale systems to suit a wider range of applications such as casinos, airports, transport terminals, banks, shopping complexes, prisons, or other government facilities, the smarter answer is clear. *Matrix System 650EX*

Key Features of The Expanded System

Basic Features

- Up to 512 inputs and 64 outputs.
- All inputs support multiplexed video, control data and VD2 sync over the coaxial cable, and cable compensation up to 900 m (3,000 feet).
- Up to 512 RS-485 remote controlled cameras.
- Supports simultaneous use of 64 controllers including the WV-CU950 System Controllers and Personal Computers using ActiveX control interface.

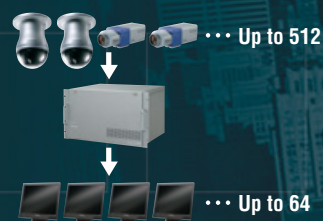

Alarm Functions

- Up to 1,024 alarm programs and various alarm interfaces including 1,024 terminal inputs, 256 terminal outputs, 512 camera alarms, 512 Video loss alarms and 1,024 serial alarm inputs (Total of terminal inputs and outputs is 1,024).
- Up to ten actions including Camera spot, Tour Sequence, Group Sequence and Text for each alarm event. Each action can be assigned to one of the 16 targets, which includes up to 64 monitors.
- Alarms can be scheduled by programming the timer event function.
- Alarm priority control enables effective management for alarms, timer events and operators.

General Functions

- Three sequencing features: Tour Sequence; 128 patterns, 64 steps, Group Preset; 128 patterns, 64 monitors, Group Sequence; 128 patterns, 64 steps.
- Up to 1,024 Timer events including Camera Spot, Tour Sequence, Group Preset, Group Sequence, Alarm and Mode change.
- Full camera control including 255 preset position call, Menu setup, Color/Black & White Change, Wiper, Defroster and 256 function codes (depending on the camera model). Preset positions can easily be programmed by the system controller.
- Up to 512 operators with individual level and priority settings, and flexible system partitioning.
- Up to 32 recorders (WJ-HD316/309A, WJ-RT416) can be connected.
- * Connection with WJ-RT416 is a plan for future.
- Cameras, matrix and recorders can be controlled seamlessly from the system controller.
- It will support a redundant CPU system without need of WJ-MPS850 CPU management switch unit, enabling lower cost.
- Front access for Main Board and Power Supply maintenance.

OSD Service

- Alarm Status, Alarm History (100 events), Video Loss Status, Video Loss History (100 events) and System Status can be viewed on a monitor.
- Time & Date Displays can be switched on and off from the system controller.

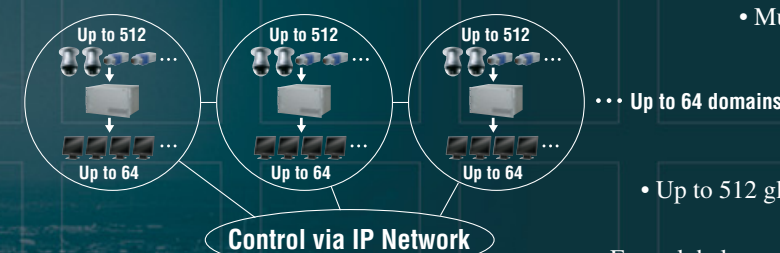

Key Features of The Satellite System

- Multiple System650EX systems with WJ-MPU955A central processing unit upgraded by WJ-ASC960, can be linked by video link and Network.
 - Up to of 64 domains.
 - Up to 1,024 video links across the domains.
- Up to 512 global operators (total of global and local operators) and 1,024 global alarms.
- Four global operator classes by combination of Global camera lock and Global camera lock override privileges.
- System650EX, System850 and GX matrix system can be incorporated to make a hybrid satellite system.
- Integrated Global and Local administration software makes setup easy.

Matrix System650EX Administration Software

The standard software for basic (up to 512 x 64) system.

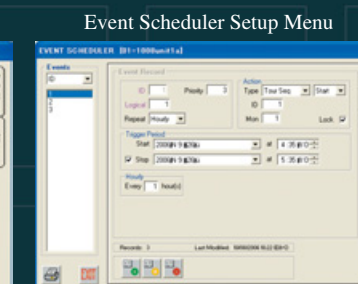
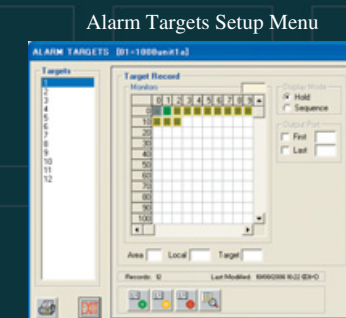
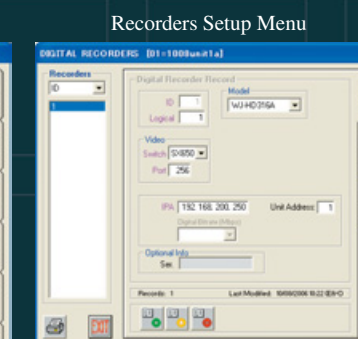

WJ-ASC960 Upgrade Software for Satellite Configuration

This optional software upgrade allows configuration of systems with up to 64 Satellite domains.



MATRIX SYSTEM 650EX

A Rich Array of Features for More Reliable and Efficient Surveillance

Three Sequencing Features for More Efficient Monitoring

These features allow you to determine the sequence in which you see images from multiple cameras. System Controller buttons make monitoring more efficient by enabling instant selection of the pattern of your choice.

Tour Sequence

Automatically switches camera images sequentially on the selected monitor. Up to 128 patterns can be programmed with as many as 64 steps per pattern. Camera preset position (1 ~ 255) and AUX output (1, 2) can also be controlled and up to 86,339 seconds dwell time is available in each step.

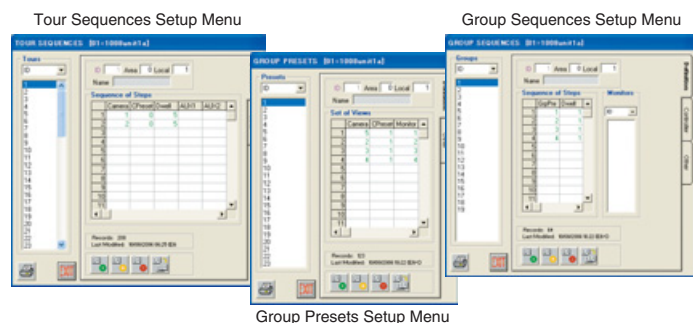
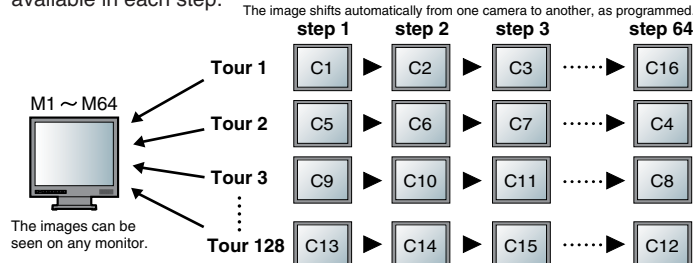

Group Preset

Allows instant spot display of selected camera with preset position (1 ~ 255) on up to 64 pre-selected monitors at once. Up to 128 patterns can be programmed.

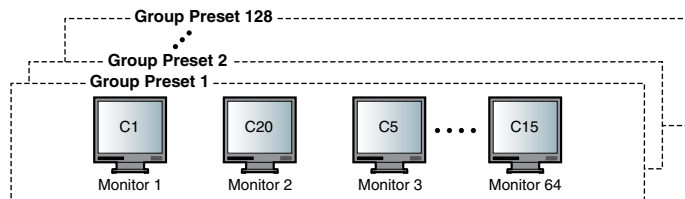

Group Sequence

Automatically switches Group preset patterns sequentially. Up to 128 patterns can be programmed with as many as 64 steps per pattern. Up to 86,339 seconds dwell time is available in each step.

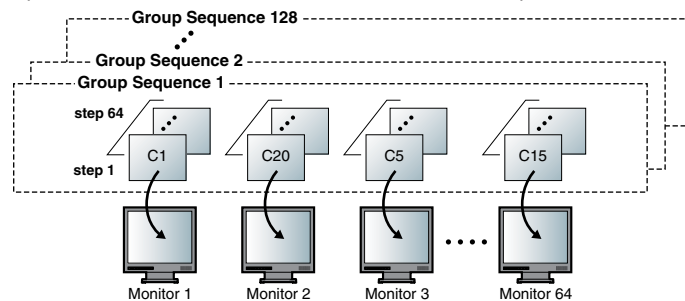

Up to 1,024 Alarm Events Ensure That You Capture Vital Scenes

The Matrix System650EX supports flexible alarm handling, up to 1,024 alarm programs and various alarm interfaces including 1,024 terminal inputs, 256 terminal outputs, 512 camera alarms, 512 Video loss alarms and 1,024 serial alarm inputs (Total of terminal inputs and outputs is 1,024). An alarm program can activate up to 10 actions including camera spot, Tour Sequence, Group Sequence and Text. Each action can be assigned to one of the 16 targets, which includes up to 64 monitors, so that the multiple actions can effectively be displayed across the alarm target monitors.

An alarm terminal output can be triggered when an alarm is activated, acknowledged or reset.

Example: Terminal Alarm Event No.256

Alarm ID	Priority	Alarm Source	Alarm Output	Action							
				No.	Type	ID	Preset	AUX	Dwell Time	Text	Target
256	1	Terminal	513	0	Camera spot	1	1	1	3sec	Entrance 1 Zoom	1 (M1, M2)
				1	Camera spot	2	OFF	5sec	Entrance 1 Wide	1 (M1, M2)	
				2	Tour SEQ	1	---	3sec	Entrance Area	2 (M11, M12)	
				
				8	Group SEQ	1	---	4 sec	Group level 1	3 (M31, M32, M33, M34)	
				9	Text only	1	---	---	Entrance 1 Level 1	16 (M63, M64)	

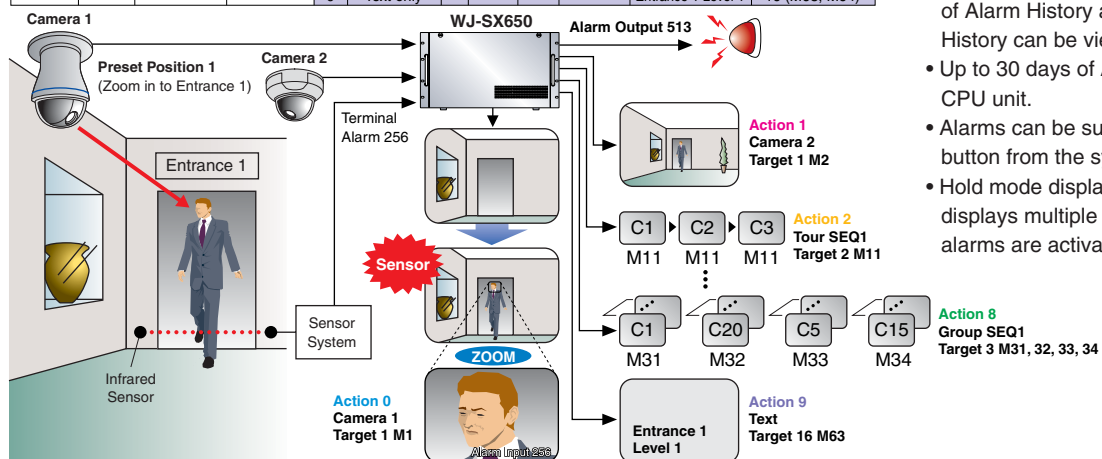

- Alarms can be scheduled by programming the timer event function.
- Alarm priority control enables effective management for alarms, timer events and operators.
- Up to 1,024 Alarm Program status, up to 100 events of Alarm History and up to 100 events of Video-loss History can be viewed on a monitor.
- Up to 30 days of Alarm logs can be stored in the main CPU unit.
- Alarms can be suspended individually by Arm/Disarm button from the system controller.
- Hold mode displays first alarm while sequence mode displays multiple alarms sequentially when multiple alarms are activated.

Flexible System Partitioning and Priority

The System650EX has flexible system partitioning and priority features allowing for advanced operation management. Partitioning includes Controller to Area, Monitor, Camera view, Camera control, Group Sequence, Alarm, Alarm I/O, Recorder, Operator-to-Controller and Monitor-to-Camera. Priority control includes Operator, Controller, Alarm and Timer-event so that the flexible priority control is available. For example, a higher operator will not be bothered by the lower priority alarms or timer events and higher priority alarms will not be disturbed by the lower priority operators or timer events. In addition, the System650EX can create the Areas including Monitors, Controllers, Tour Sequences, Group Presets and Group Sequences. All these items, except controllers, can have a local number enabling the operators to select them by using a simpler reference number.

Partitioning and Priority Overview

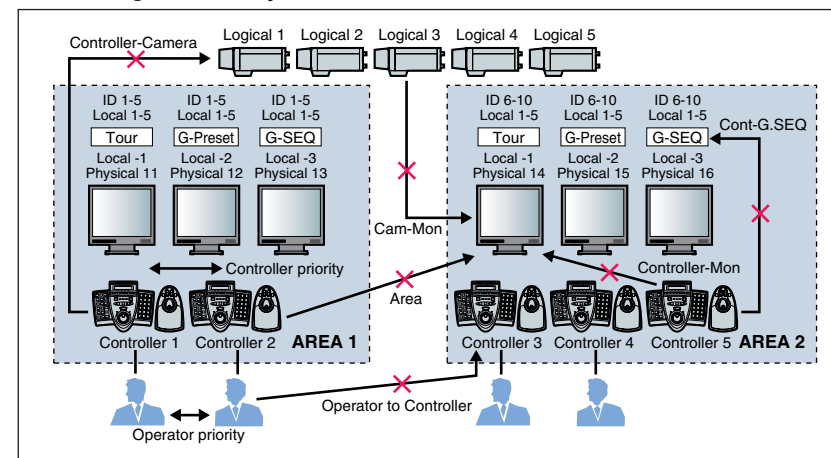

Controller-Camera Partition Setup Menu

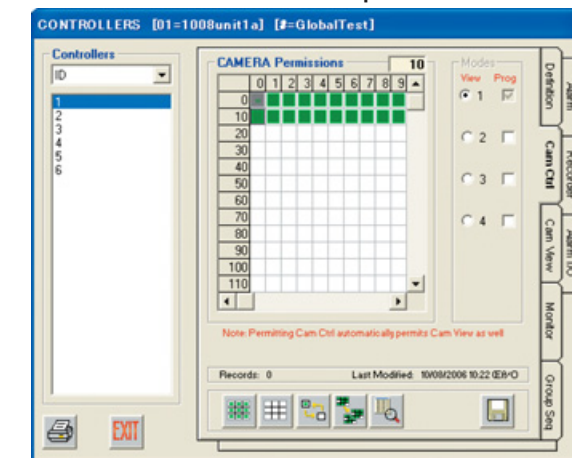

User Management for Preventing Unauthorized Access

Up to 512 operators can be registered with individual operator IDs, passwords and priority (0 to 65,534). 16 operator levels are fully configurable with numerous parameters such as camera select, alarm select and DVR select. Administrators for the system setup are registered separately, allowing secure user management.

Operator Registration Example

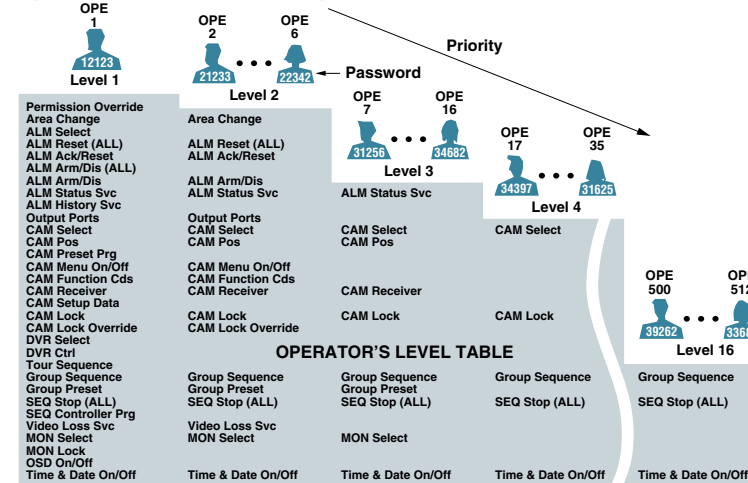

Operator Classes Setup Menu

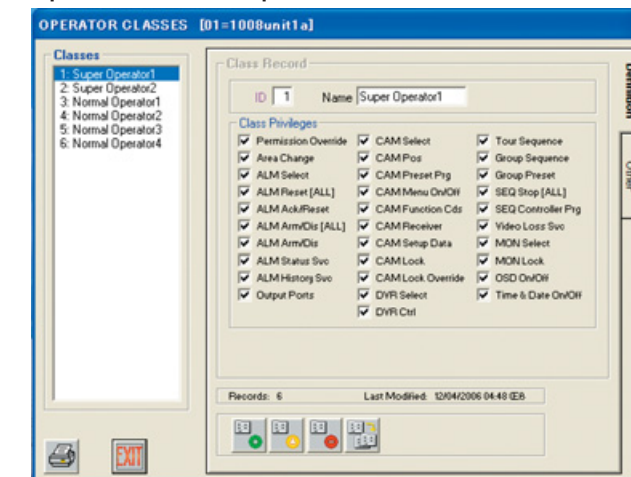

Timer Events for Simple, Certain Operation

Camera spot, Tour Sequence, Group Preset, Group Sequence, Alarm arm/disarm and Mode change features can automatically be activated, following programmed schedules. Up to 1,024 timer events can be registered.

Setup Example

Event ID	Priority	Action	ID	Monitor	Start Date	Start Time	End Date	End Time	Repeat
1	5	Alarm Disarm	-	-	11 Nov. 2006	08:00	-	-	Daily
2	5	Alarm Arm	-	-	11 Nov. 2006	17:00	-	-	Daily
3	10	Camera spot	1	1	11 Nov. 2006	08:00	31 Jan. 2007	17:00	Weekly
...
1,024	20	Tour SEQ	3	4	1 Dec. 2006	09:00	1 Dec. 2006	18:00	Once

Matrix Switcher: WJ-SX650

SPECIFICATIONS

Power Source	120 V AC, 60 Hz
Power Consumption	60 W
Ambient Operating Temperature	-10 °C ~ +50 °C (14 °F ~ 122 °F)
Ambient Operating Humidity	Less than 90 %
Video Input Board	x 1
Video Output Board	x 1
Expansion Slot	x 1
RS-485 (Camera) Port	6-conductor modular jack x 4 (2-wire or 4-wire communication, With termination switches (MODE 1 ~ 4))
Dimensions (W x H x D)	420 mm x 265 mm x 372 mm (16-9/16" x 10-7/16" x 14-3/5") (excluding rubber feet and projections)
Weight	19.0 kg (42 lbs.)

Card Cage: WJ-SX650U

SPECIFICATIONS

Expansion Slot	x 3
RS-485 (Camera) Port	6-conductor modular jack x 12 (2-wire or 4-wire communication, With termination switches (MODE 1 ~ 4))
Extension Port (EXTENSION 1 IN, OUT)	6-conductor modular jack x 2 (With a termination switch (TERM: ON, OFF))
Extension Port (EXTENSION IN 2, 3)	37pin D-sub connector x 2
Extension Port (EXTENSION OUT 2, 3)	37pin D-sub connector x 2
Dimensions (W x H x D)	420 mm x 265 mm x 372 mm (16-9/16" x 10-7/16" x 14-3/5") (excluding rubber feet and projections)
Weight	18.0 kg (40 lbs.)

Video Input Board: WJ-PB65C32

SPECIFICATIONS

Camera Input (CAMERA IN 1 ~ 32)	1 V [p-p] / 75 Ω (BNC x 32), composite video signal 0.5 V [p-p] / 75 Ω data signal and 2.5 V [p-p] / 75 Ω vertical timing pulse multiplexed
Video Output (VIDEO OUT 1 ~ 4)	1 V [p-p] / 75 Ω (25pin D-sub connector x 4), active loop-thru output
Alarm Input (ALARM IN)	N.O. (Normally Open contact) or N.C. (Normally Close contact) selectable x 32 (37pin D-sub connector)
Dimensions (W x H x D)	
Main Board	346 mm x 42 mm x 225 mm (13-3/5" x 1-3/5" x 8-4/5")
IN X-2 Board	355 mm x 21 mm x 115 mm (14" x 4/5" x 4-1/2")
IN X-1 Board	355 mm x 38 mm x 115 mm (14" x 1-1/2" x 4-1/2")

Video Output Board: WJ-PB65M16

SPECIFICATIONS

Monitor Output (MONITOR OUT 1 ~ 16)	1 V [p-p] / 75 Ω (BNC x 16)
Data Port (DATA 1 ~ 4)	
DATA 1	Terminal Mode (TMNL)/PS•Data (PS•DATA) selectable
DATA 2	Terminal Mode (TMNL)
DATA 3, 4	Terminal Mode (TMNL)/Digital Disk Recorder (HDR) selectable
Alarm Output (ALARM OUT 1, 2)	
Alarm Output	Open collector output x 32, Max. 24 V DC, 100 mA
Alarm Recover Input	Non-voltage make contact input x 16
Time Adjust Input	Non-voltage make contact input x 1
Time Adjust Output	Open collector output x 32, Max. 24 V DC, 100 mA
Extension Port (EXTENSION 1 IN, OUT)	6-conductor modular jack x 2 (With a termination switch (TERM: ON, OFF))
VS Input	1 V [p-p] / 75 Ω (VS IN)
VS Output	(VS OUT (THRU)): VS loop-thru output, (VS OUT): 1 V [p-p] / 75 Ω (VS)
Serial Port	9pin D-sub connector x 2
Dimensions (W x H x D)	
Main Board	346 mm x 42 mm x 225 mm (13-3/5" x 1-3/5" x 8-4/5")
OUT X-3 Board	355 mm x 21 mm x 115 mm (14" x 4/5" x 4-1/2")
OUT X-2 Board	355 mm x 21 mm x 115 mm (14" x 4/5" x 4-1/2")
OUT X-1 Board	355 mm x 38 mm x 115 mm (14" x 1-1/2" x 4-1/2")

Central Processing Unit: WJ-MPU955A

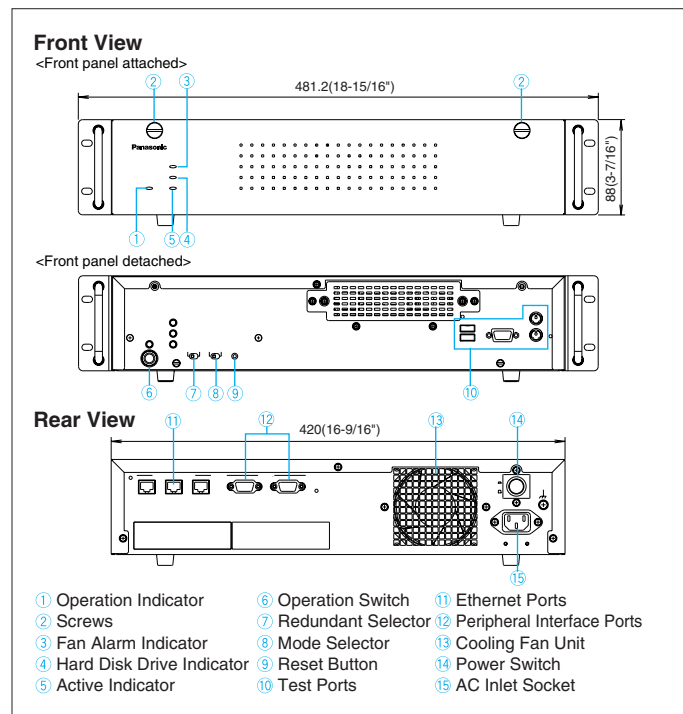

SPECIFICATIONS

Power Supply	NTSC model: 120 V AC, 60 Hz
Power Consumption	60 W
Ethernet Ports	10Base-T/100Base-TX, RJ-45 x 3 System controller* (1 port), System device (1 port), other (1 port) * Maximum 64 controllers
RS-232C Port	9pin D-sub connector x 2
Ambient Operating Temperature	+5 °C ~ +45 °C (41 °F ~ 113 °F)
Ambient Operating Humidity	Less than 90 %
Dimensions (W x H x D)	420 mm x 88 mm x 350 mm (16-9/16" x 3-7/16" x 13-3/4") (excluding rubber feet and projections)
Weight	9 kg (19.8 lbs.)

Network Board: WJ-PB65E01

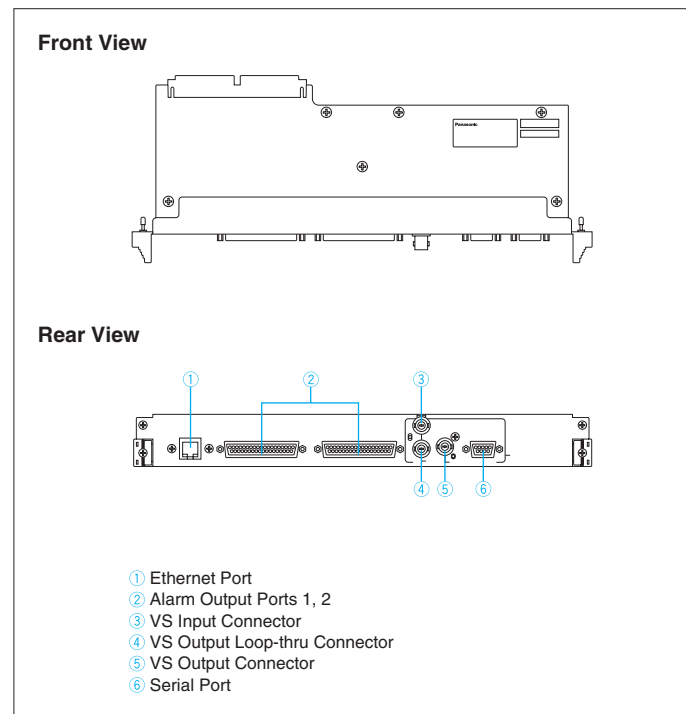

SPECIFICATIONS

Ethernet Port	10Base-T/100Base-TX, RJ-45 x 1
Alarm Output Port 1, 2	Open collector output x 32, Max. 24 V DC, 100 mA
VS Input	1 V [p-p] / 75 Ω (VS IN)
VS Output	(VS OUT (THRU)): VS loop-thru output (VS OUT): 1 V [p-p] / 75 Ω (VS)
Serial Port	9pin D-sub connector x 1
Dimensions (W x H x D)	355 mm x 38 mm x 134 mm (14" x 1-1/2" x 5-3/10")

An expanded full matrix configuration for a maximum 512-camera x 64-output system.

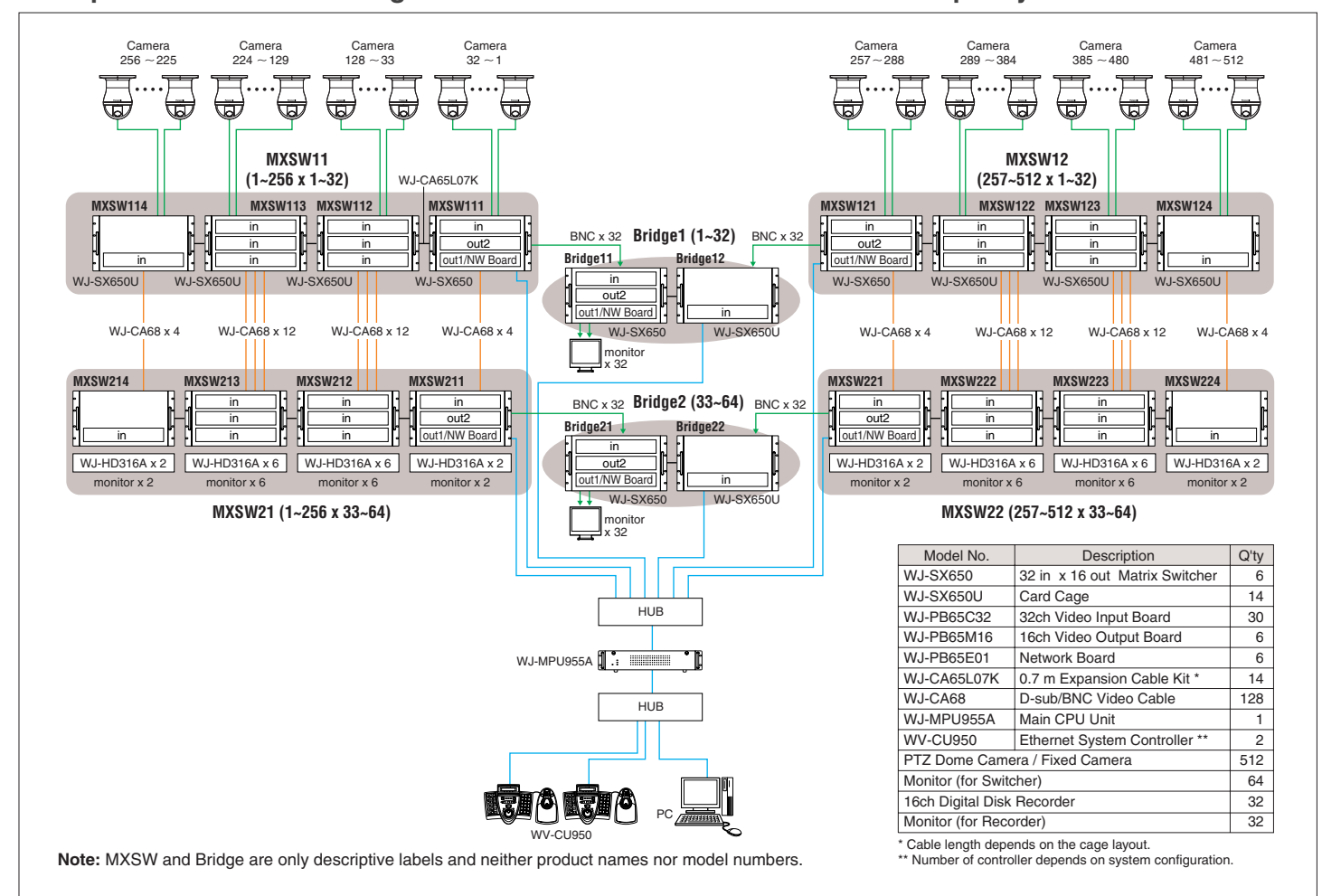

Up to 64 domains can be connected in a satellite configuration.

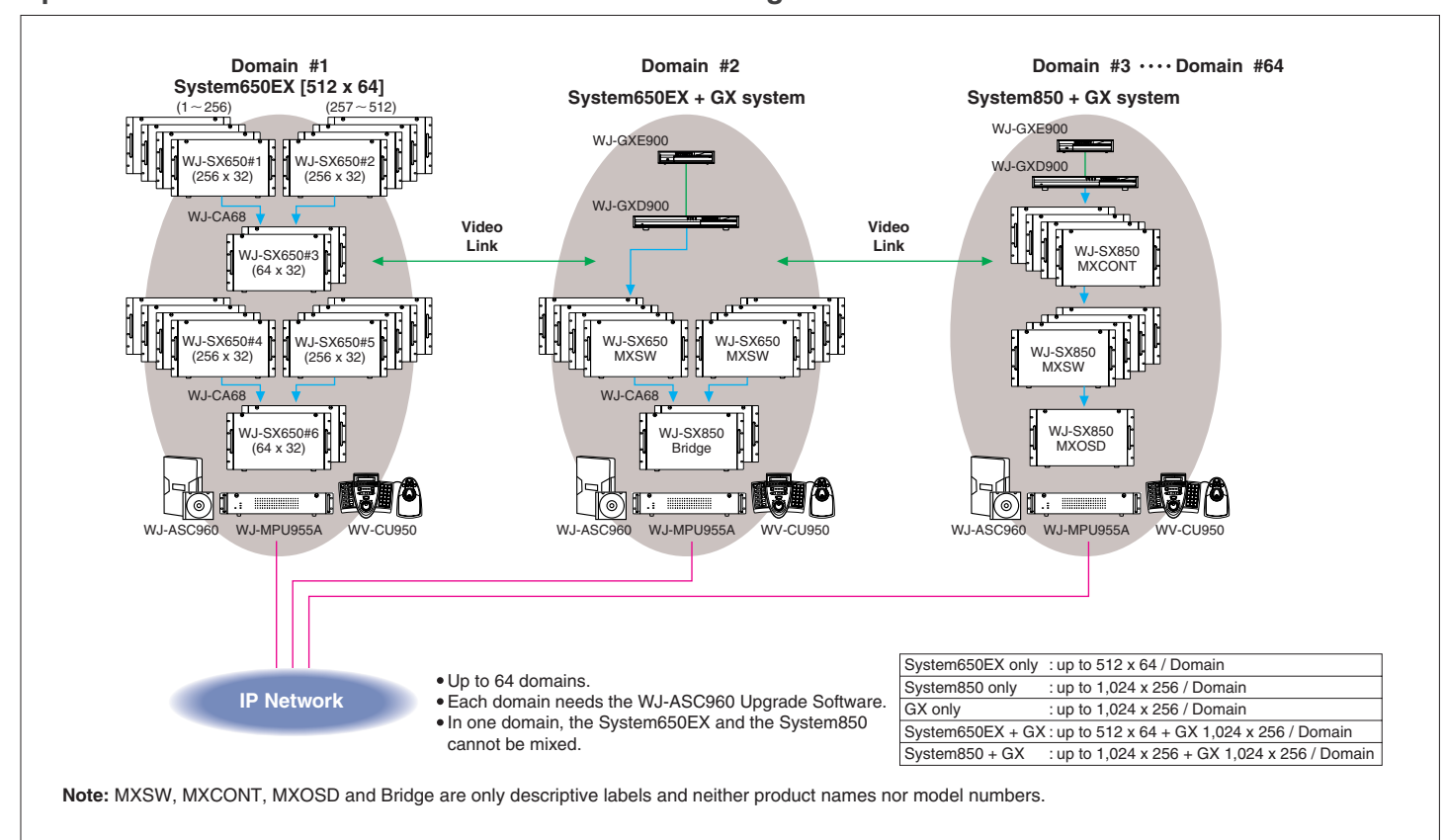

SPECIFICATIONS (Expanded System)

Video Interface	Number of Inputs	1.0 V [p-p] / NTSC composite 75 Ω / BNC Connector x Up to 512 With Multiplexed Vertical sync (VD2) and control data.
	Logical Camera No. Range	1 ~ 99,999
	Number of Loop Through Outputs	1.0 V [p-p] / NTSC composite 75 Ω / 25pin D-sub connectors. Active loop through.
	Number of Outputs	1.0 V [p-p] / NTSC composite 75 Ω / BNC Connector x Up to 64
	Logical Monitor No. Range	1 ~ 9,999
Controller	Number of Controllers	64 (WV-CU950 and ActiveX controller)
Recorder	Number of Recorders	Up to 32 (WJ-HD300A Series, WJ-RT416) *Connection with the WJ-RT416 is a plan for future.
Alarm	Alarm Source	Total up to 1,024 consists of followings Terminal inputs x 1,024 Camera alarm x 512 Video loss alarm x 512 Serial alarm x 1,024 (Total of terminal input and output is 1,024) Supports one state input mode.
	Number of Alarm Programs	1,024
	Alarm Outputs	Up to 256 (Terminals), Trigger: Active/ACK/RESET
	Alarm Control	Ack (Auto/Manual), Reset (Auto/Manual), All reset, Arm, Disarm
	Alarm Action	Up to 10 actions including Camera spot, Tour SEQ, Group SEQ and Text
	Alarm Target	Up to 64 targets, Up to 64 monitors in a target.
	Multi-Alarm Mode	SEQ/HOLD
	Alarm Log	Up to 30 days and 500KB x 99 files per day.
	Alarm Schedule	Possible by Timer Event
	Functions	Partitioning
Priority		0 ~ 65,534 for Operator, Controller, Alarm and Timer event
Sequence		Tour Sequence; 128 patterns, 64 steps, Logical No. 1 ~ 9,999 Group Preset; 128 patterns with 64 monitors, Logical No. 1 ~ 9,999 Group Sequence; 128 patterns, 64 steps, Logical No. 1 ~ 9,999 Dwell Time; Up to 86,339 seconds
Timer Events		1,024 (Camera Spot, Tour SEQ, Group Preset, Group SEQ, Alarm, Mode change)
Area		64
Redundant CPU		Supported
Operator	Setup Method	Admin software (English)
	No. of Registration	512
	Level	Class setup 1 ~ 16
	Priority	0 ~ 65,534
Administrator	Operator Login/System	64
	No. of Registration	128
Camera Control (depending on the camera model)	Level	1 ~ 4
	PTZ	Up to 64 steps
	Iris	OPEN/CLOSE/RESET
	Focus	FAR/NEAR/AUTO
	Wiper	ON (Keep pressing)
	Defroster	ON/OFF
	Preset Positions	Up to 255 Preset Positions
	Setup Menu	ON/OFF
	Auto Mode	Auto Pan, SEQ, Sort, Patrol
	B/W	Color/BW/AUTO1/AUTO2
OSD Service	AUX 1/2 ON/OFF	AUX 1/2 ON/OFF
	Function Number	1 ~ 256
	Time Date	Time: 12/24H, Date: 10 formats
	Camera Title	28 alpha-numeric characters
	Alarm Title	18 alpha-numeric characters
Log	Status	System, Video loss, Alarm
	Customizable Characters	32
	Log	Alarm (100), Video loss (100)
Log	Log by Admin Software	Switching, Operator, Alarm, Video loss, Admin setup

MATRIX SYSTEM650EX PRODUCT COMPONENTS

Matrix Switcher
WJ-SX650



Card Cage
WJ-SX650U



Video Input Board
WJ-PB65C32

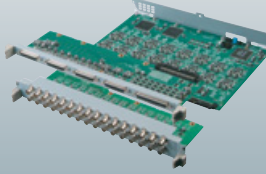

Video Output Board
WJ-PB65M16

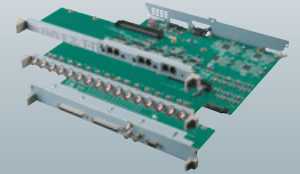

Network Board
WJ-PB65E01

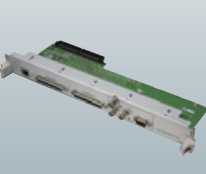

D-sub/BNC Video Cable
WJ-CA68
(0.5 m : 1.65 ft)

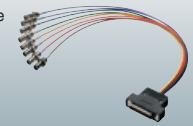

Expansion Cable Kit
WJ-CA65L20K
(2 m : 6.6 ft)
WJ-CA65L07K
(0.7 m : 2.3 ft)



Digital Disk Recorders
WJ-HD316A (16ch)
WJ-HD309A (9ch)



Central Processing Unit
WJ-MPU955A



Ethernet System Controller
with 3D-Joystick & Jog/Shuttle
WV-CU950



Upgrade Software
WJ-ASC960



Trademarks and registered trademarks

– Microsoft, and Windows are registered trademarks of Microsoft Corporation in the U.S. and other countries.

Important

– Safety Precaution: carefully read the operating instructions and installation manual before using this product.

– Panasonic can not be responsible for network performance and/or other manufacturer products that reside on the network.

- All TV pictures are simulated.
- Weights and dimensions are approximate.
- Specifications are subject to change without notice.
- These products may be subject to export control regulations.

DISTRIBUTED BY:

Panasonic[®]

<http://panasonic.net/security/>

Printed in Japan (2P-554A)

Free Manuals Download Website

<http://myh66.com>

<http://usermanuals.us>

<http://www.somanuals.com>

<http://www.4manuals.cc>

<http://www.manual-lib.com>

<http://www.404manual.com>

<http://www.luxmanual.com>

<http://aubethermostatmanual.com>

Golf course search by state

<http://golfingnear.com>

Email search by domain

<http://emailbydomain.com>

Auto manuals search

<http://auto.somanuals.com>

TV manuals search

<http://tv.somanuals.com>