

# Panasonic<sup>®</sup>

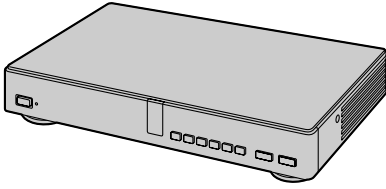

## Operating Manual HD Visual Communication Unit

---

Model No. **KX-VC500**



Thank you for purchasing a Panasonic HD Visual Communication Unit.  
Please read this manual carefully before using this product and save this manual for future use.  
In this manual, the suffix of each model number (e.g., KX-VC500NA) is omitted unless necessary.

Document Version: 2010-10

# Introduction

## Feature Highlights

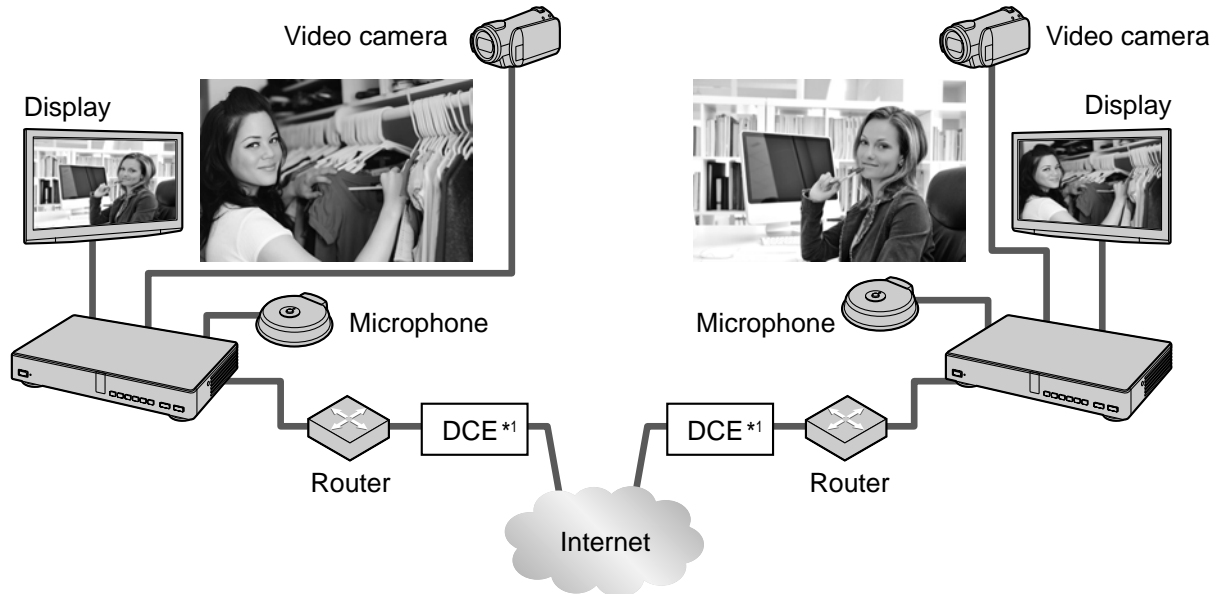

\*1 DCE: Data Circuit-terminating Equipment

### Lifelike Visual Communication

You can experience lifelike visual communication with smooth, high-quality video and clear stereo\*<sup>2</sup> sound.

\*<sup>2</sup> If using 2 or more microphones, stereo output can be enabled through system settings (only when Boundary Microphones are connected). (Page 66)

### Simply Operated Visual Communication

You can easily begin a video conference call by pressing the KX-VC500's One-Touch Connection button followed by the Start button. (Page 28)

### Home Electronics-style Remote Control Operation and Simple, Easy to Understand Graphical User Interface

You can make settings and perform operations using familiar remote control operations and a simple, easy to understand interface.

### Stabilized Communication Quality

In periods of network congestion, automatic packet transmission rate quality control prevents packet loss to maintain a video conference call's image and sound quality. This allows visual communication with stabilized communication quality even over an internet connection.

## Selectable Video Source

By connecting your computer or video camera to the KX-VC500, you can show your computer's screen or video camera image to video conference call participants. (Page 49, Page 52)

## Encrypted Communication

Packets sent for video conference calls can be encrypted to prevent packet leaks, tampering, or eavesdropping.

## Trademarks

- HDMI is a trademark or registered trademark of HDMI Licensing LLC in the United States and other countries.
- This product is licensed under the AVC Patent Portfolio License. This license permits the end user to perform, for personal and non-commercial use, only the following actions:
  - Encode video in compliance with the AVC Standard (below, "AVC Video").
  - Decode AVC Video that was encoded by a consumer engaged in both personal and non-commercial activity.
  - Decode AVC Video obtained from a video provider licensed to provide AVC Video.Additional information may be obtained from MPEG LA, LLC. See <http://www.mpegla.com>.
- All other trademarks identified herein are the property of their respective owners.

## Open Source Software

Parts of this product use Open Source Software supplied based on the conditions of the Free Software Foundation's GPLs and/or LGPLs and other conditions. Relevant conditions apply to this software. Therefore, please read license information about GPLs and LGPLs, and information about other Open Source Software in the included CD-ROM before using this product. Also, some software parts of this product are licensed under the MOZILLA PUBLIC LICENSE (MPL). At least three (3) years from delivery of products, Panasonic will give to any third party who contacts us at the contact information provided below, for a charge of no more than the cost of physically distributing source code, a complete machine-readable copy of the corresponding source code and the copyright notices covered under GPL, LGPL, and MPL. Please note that software licensed under GPL, LGPL, and MPL is not under warranty.

Contact Information  
<http://www.panasonic.net/>

## Precaution

### **Notice for users in California**

This product contains a CR coin cell lithium battery that contains perchlorate material—special handling may apply.

See [www.dtsc.ca.gov/hazardouswaste/perchlorate](http://www.dtsc.ca.gov/hazardouswaste/perchlorate)

# Table of Contents

<b>For Your Safety</b> .....	<b>7</b>
For Your Safety .....	7
<b>Before Operation</b> .....	<b>11</b>
Notes about Operation .....	11
Data Security .....	12
Privacy and Right of Publicity .....	12
Federal Communications Commission Requirements .....	13
<b>Preparation</b> .....	<b>14</b>
<b>Part Names and Usage</b> .....	<b>14</b>
Main Unit (Front) .....	14
Main Unit (Back) .....	15
Remote Control .....	16
Boundary Microphone (Optional Accessory) .....	17
LED Patterns .....	18
Screen Standby .....	18
<b>Connecting the KX-VC500</b> .....	<b>20</b>
<b>Turning the Power On/Off</b> .....	<b>24</b>
<b>Screen Display</b> .....	<b>25</b>
Home Screen (Idle Screen) .....	25
Menu Screen (Idle Screen) .....	26
Video Conference Call Screen .....	27
<b>Starting a Video Conference</b> .....	<b>28</b>
<b>Making a Video Conference Call</b> .....	<b>28</b>
Calling Using Speed Dial (2-party Conference/3-party Conference/4-party Conference) .....	28
Calling from the Contact List (2-party Conference/3-party Conference/4-party Conference) .....	31
Calling by Entering an IP Address .....	33
Calling from the Call History .....	35
<b>Answering a Video Conference Call</b> .....	<b>37</b>
<b>Changing the Screen Layout</b> .....	<b>39</b>
Changing the Screen Layout during a 2-party Video Conference Call .....	39
Changing the Screen Layout during a 3-party Video Conference Call .....	40
Changing the Screen Layout during a 4-party Video Conference Call .....	42
<b>Adjusting the Volume and Tone</b> .....	<b>45</b>
Adjusting the Volume .....	45
Muting the Microphone .....	46
Reducing Microphone Noise .....	47
Adjusting the Tone .....	48
<b>Displaying Other Video Sources</b> .....	<b>49</b>
Displaying a Computer's Screen .....	49
Displaying the Sub Video Camera's Image .....	52
<b>Displaying the Connection Status</b> .....	<b>56</b>
Displaying the Connection Status .....	56
Displaying Unit Information .....	57

<b>Contacts and Settings .....</b>	<b>58</b>
<b>Adding Contacts to the Contact List .....</b>	<b>58</b>
Registering a New Contact .....	58
Editing Contact Information .....	59
Deleting a Contact .....	59
Registering a Contact from the Call History .....	60
<b>Changing System Settings .....</b>	<b>61</b>
Setting the Unit Name .....	61
Setting the Date and Time .....	62
Making Network Settings .....	62
Making Sound Settings .....	62
Making Connection Settings .....	63
Display Unit Information .....	65
Setting the Mic Position .....	65
Making Remote Control Settings .....	68
Performing a Network Test .....	69
Performing Self Diagnosis .....	69
Performing Remote Maintenance .....	70
<b>Making Administrator Menu Settings .....</b>	<b>71</b>
Logging in to the Administrator Menu .....	71
Making Language Settings .....	71
Making Encryption Settings .....	72
Making Software Update Settings .....	72
Updating Software .....	73
Making Screen Standby Settings .....	74
Making Administrator Password Settings .....	75
Performing System Initialization .....	75
<b>Making Local Site Settings .....</b>	<b>76</b>
Registering a Local Site .....	76
Selecting a Local Site .....	77
Editing Local Site Information .....	77
Deleting Local Site Information .....	78
<b>Input .....</b>	<b>79</b>
<b>Inputting Letters and Numbers .....</b>	<b>79</b>
<b>Miscellaneous .....</b>	<b>84</b>
<b>Changing the Remote Control Batteries .....</b>	<b>84</b>
<b>Cleaning the Unit .....</b>	<b>85</b>
<b>Additional Information .....</b>	<b>86</b>
<b>Troubleshooting .....</b>	<b>86</b>
Basic Operation .....	86
Audio .....	89
System Settings .....	90
If These Messages Appear .....	91
Miscellaneous .....	95
<b>Specifications .....</b>	<b>96</b>
<b>System Specifications .....</b>	<b>96</b>
<b>Index.....</b>	<b>97</b>

## For Your Safety

To prevent personal injury and/or damage to property, be sure to observe the following safety precautions.

The following symbols classify and describe the level of hazard and injury caused when this unit is operated or handled improperly.



Denotes a potential hazard that could result in serious injury or death.



Denotes a hazard that could result in minor injury or damage to the unit or other equipment.

The following types of symbols are used to classify and describe the type of instructions to be observed. (The following symbols are examples.)



This symbol is used to alert users to a specific operating procedure that must not be performed.



This symbol is used to alert users to a specific operating procedure that must be followed in order to operate the unit safely.



## WARNING

### General



Follow all warnings and instructions marked on the unit.

### Power and Ground Connection



The power source voltage of this unit is listed on the nameplate. Only plug the unit into an AC outlet with the proper voltage. If you use a cord with an unspecified current rating, the unit or plug may emit smoke or become hot to the touch.



Do not connect the unit to the AC outlet, AC extension cords, etc., in a way that exceeds the power rating of, or does not comply with the instructions provided with, the AC outlet, AC extension cords, etc.



To ensure safe operation the power cord supplied must be inserted into a standard three-prong AC outlet which is effectively grounded through the normal wiring.



The fact that the equipment operates satisfactorily does not imply that the power point is grounded and that the installation is completely safe. For your safety, if in any doubt about the effective grounding of the power point, consult a qualified electrician.



Plug the power cord firmly into an AC outlet. Otherwise, it can cause fire or electric shock.



Do not pull, bend, rest objects on, or chafe the power cord and plug. Damage to the power cord or plug can cause fire or electric shock.



To prevent fires, electric shock, injury, or damage to the unit, be sure to follow these guidelines when performing any wiring or cabling:

- a. Before performing any wiring or cabling, unplug the unit's power cord from the outlet. After completing all wiring and cabling, plug the power cord back into the outlet.
- b. Do not place any objects on top of the cables connected to the unit.
- c. When running cables along the floor, use protectors to prevent the cables from being stepped on.
- d. Do not run any cables under carpeting.



Do not attempt to repair the power cord, or plug. If the power cord or plug is damaged or frayed, contact an authorized service representative for a replacement.



Ensure that the plug connection is free of dust. In a damp environment, a contaminated connector can draw a significant amount of current that can generate heat, and eventually cause fire if left unattended over an extended period of time.



Stop operation immediately if the unit emits smoke, excessive heat, abnormal smell or unusual noise. These conditions can cause fire or electric shock. Immediately turn the unit off, and unplug the power cord, and contact your dealer for service.



Do not connect or disconnect the AC plug with wet hands. Danger of electric shock exists.



When disconnecting the unit, grasp the plug instead of the cord. Pulling on a cord forcibly can damage it, and cause fire or electric shock.



During thunderstorms, do not touch the unit and plug. It may cause an electric shock.

## Operating Safeguards



Do not disassemble this unit. Only qualified personnel should service this unit. Disassembling the unit may expose you to dangerous voltages or other risks. Incorrect reassembly can cause electric shock.



Do not alter the unit or modify any parts. Alteration or modification can cause fire or electric shock.



If metal fragments or water gets into the unit, turn the unit off and unplug the unit immediately. Contact your dealer for service. Operating the contaminated unit can cause fire or electric shock.



Do not insert objects of any kind into this unit, as they may touch dangerous voltage points or short out parts that could result in a fire or electric shock.



Do not use a unit in the vicinity of a gas leak to report the leak.



Do not place the remote control in microwave ovens or on induction cookware.



Clean the AC plug periodically with a soft, dry cloth to remove dust and other debris.



Do not use the supplied power cord with any other device. It may cause fire or electric shock.



Never open or remove unit covers that are screwed with screws. A high-voltage component can cause electric shock.





Unplug the unit from the AC outlet and have it serviced by qualified service personnel in the following cases:

- a. If the unit does not operate according to the operating instructions. Adjust only the controls that are explained in the operating instructions. Improper adjustment of other controls may result in damage and may require service by a qualified technician to restore the unit to normal operation.
- b. If the unit has been dropped or the cabinet has been damaged.
- c. If unit performance deteriorates.



If damage to the unit exposes any internal parts, disconnect the power cord immediately and return the unit to your dealer.

### Installation



Do not install the unit in any other way than described in relevant manuals.



Do not touch the unit, AC adaptor, AC adaptor cord, or AC cord during a lightning storm.



The AC adaptor should be connected to a vertically oriented or floor-mounted AC outlet. Do not connect the AC adaptor to a ceiling-mounted AC outlet, as the weight of the adaptor may cause it to become disconnected.



Only connect the unit to the type of electric power specified on the label affixed to the unit. Confirm the type of electric power supplied to the installation site if necessary.

### Battery



The battery contains diluted sulfuric acid, a very toxic substance. If the battery leaks and the liquid inside spills on the skin or clothing, immediately wash it off with plenty of clean water. If the liquid splashes into eyes, immediately flush the eyes with plenty of clean water and consult a doctor. Sulfuric acid in the eyes may cause loss of eyesight and acid on the skin will cause burns.



Do not charge, short, heat, break or throw in a fire, as it may result in the battery leaking, generating heat, or bursting.



Do not connect the positive terminal and the negative terminal of the battery to each other with any metal object (such as wire).



Do not carry or store the batteries together with necklaces, hairpins, or other metal objects.



Do not mix old and new batteries or different types of batteries.



Batteries that seem worn down or damaged should not be used. Using worn down or damaged batteries may result in leaking.



Do not use rechargeable batteries.



Take the depleted batteries out of the remote control. Otherwise, the batteries may leak.



## CAUTION

### Power



When the unit is not used over an extended period of time, take the batteries out of the remote control. Otherwise, the batteries may leak. Do not use the leaked batteries.



When the unit is not used over an extended period of time, switch it off and unplug it. If an unused unit is left connected to a power source for a long period, degraded insulation may cause electric shock, current leakage, or fire.



The unit should be used only with the power cord enclosed with the unit.

### Installation



The unit should be kept free of dust, moisture, high temperature (more than 40 °C [104 °F]) and vibration, and should not be exposed to direct sunlight.



Place this unit on a flat surface. Serious damage and/or injury may result if the unit falls.



Allow 10 cm (4 in) clearance around the unit for proper ventilation.



Do not place the unit in an area close to fire. Doing so may cause fire.

### Battery



Be sure to use the specified type of batteries only.



Ensure that batteries are installed with correct polarity. Incorrectly installed batteries can burst or leak, resulting in spillage or injuries.



This product contains batteries. Replace only with the same or equivalent type. Improper use or replacement may cause overheating, rupture or explosion resulting in injury or fire. Dispose of used batteries according to the instructions of your local solid waste officials and local regulations.



When replace the batteries for the remote control, use AA/R6 type dry cell.



Do not install the battery backwards so that the polarity is reversed.

## Notes about Operation

Please pay attention to the following points when using this device:

1. **Please contact your dealer for installing, upgrading, or repairing this device.**
2. **Do not forcefully hit or shake this device.**  
Dropping or bumping this device can damage or break this device.
3. **Do not place this device in a freezer or other location where it is exposed to cold temperatures.**  
Doing so may result in damage or malfunctions.
4. **Place this device at least 2 m (6 ft) away from radios, office equipment, microwave ovens, air conditioning units, etc.**  
Noise from electronic devices can cause static and interference in other devices.
5. **Do not place this device in a location where it is exposed to hydrogen sulfide, phosphorous, ammonia, sulfur, carbon, acid, dirt, toxic gas, etc.**  
Doing so may result in damage, and the usable life-span of the device may decrease.
6. **Do not apply insecticides or other volatile liquids to the device, nor leave rubber bands or vinyl objects on the device for extended periods of time.**  
Doing so may result in alterations to the material or paint peeling off the device.
7. **Do not bring cards with magnetic strips, such as credit cards and telephone cards, near the microphone.**  
Cards might become unusable.
8. **Do not bring the device near items that emit electromagnetic waves or that are magnetized (high-frequency sewing machines, electric welders, magnets, etc.).**  
Doing so may result in static noise or damage.
9. **Keep the device at least 10 cm (4 in) away from all walls.**  
If placed against a wall, the device may not be able to ventilate properly, which may lead to a system malfunction due to overheating.

10. **Avoid placing the device in areas with high humidity, and exposing it to rain.**  
Neither the main unit nor the power plug is water resistant.

11. **The power outlet should be near the product and easily accessible.**

## About the Operating Environment

This device includes a feature that automatically adjusts voice transmissions to improve clarity. After beginning a video conference call, adjustments to the call environment may not complete immediately, and as a result voices may cut out or echo. In such cases, at the beginning of the video conference call, be sure to speak in turn with other parties.

## About Moving the Device

Do not move this device while cords are still connected. Doing so may result in damage to the cords.

## Other

- This device is a class A information technology device. Using this device in a residential setting can cause radio wave interference. In these cases, the user may be responsible for taking appropriate measures to prevent the interference.
- The unit may not operate in the event of a power failure.
- The illustrations and screenshots in this manual are for reference only and may vary from the actual product.

## Data Security

We recommend observing the security precautions described in this section, in order to prevent the disclosure of sensitive information.

**Panasonic is not responsible for any damages caused by improper use of this device.**

### Preventing Data Loss

Keep a separate record of all information stored in the contact list.

### Preventing Data Disclosure

- Do not place this device in a location that can be accessed or removed without authorization.
- If important information is saved on this device, store it in an appropriate location.
- Do not store sensitive personal information in the unit.
- In the following situations, make a record of information stored in the contact list and return the unit to the state it was in when purchased. Contact your dealer for details.
  - Before lending or disposing of the unit
  - Before handing the unit over to a third party
  - Before having the unit serviced
- Make sure the unit is serviced by only a certified technician.

This device can register and store personal data (the contact list, connection history, etc.). In order to prevent the disclosure of data stored on this device, make sure to delete all data that is registered and stored on this device prior to disposing of, lending, or returning this device.

### Preventing Data Disclosure over the Network

- To ensure the security of private conversations, only connect the unit to a secure network.
- To prevent unauthorized access, only connect the unit to a network that is properly managed.
- Make sure all computers connected to the unit employ up-to-date security measures.
- To prevent illegal access from the Internet, activate a Firewall.

## Privacy and Right of Publicity

By installing and using this device, you are responsible for maintaining the privacy and usage rights of images and other data (including sound picked up by the microphone). Use this device accordingly.

- Privacy is generally said to be, "A legal guarantee and right not to have the details of one's personal life unreasonably publicized, and the right to be able to control information about oneself. In addition, right of publicity is a right not to have a likeness of one's face or figure photographed and publicized without consent".
- When the Automatic Answer feature is enabled, transmission begins as soon as a video conference call is received. The receiver of the video conference call will begin transmitting as soon as the video conference call is received at any time, from any caller. Please be aware when the Automatic Answer feature is enabled, there is a risk that due to an unexpected, automatically answered video conference call, privacy rights may be violated or sensitive information may be transmitted to unauthorized parties.

---

# Federal Communications Commission Requirements

## Federal Communications Commission Interference Statement

This equipment has been tested and found to comply with the limits for a Class A digital device, pursuant to Part 15 of the FCC Rules. These limits are designed to provide reasonable protection against harmful interference when the equipment is operated in a commercial environment. This equipment generates, uses and can radiate radio frequency energy and, if not installed and used in accordance with the instructions manual, may cause harmful interference to radio communications. Operation of this equipment in a residential area is likely to cause harmful interference in which case the user will be required to correct the interference at his own expense.

### **FCC Caution**

To assure continued compliance, (example - use only shielded interface cables when connecting to other devices). Any changes or modifications not expressly approved by the party responsible for compliance could void the user's authority to operate this equipment.

# Part Names and Usage

## Main Unit (Front)

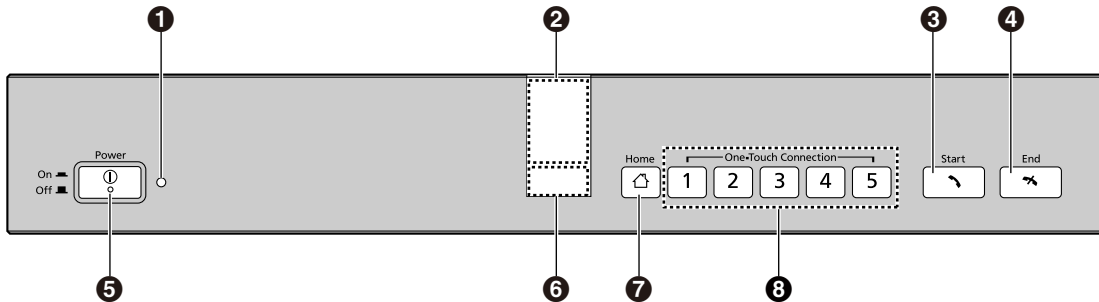

### 1 Power LED

Shows the power status. The LED is red when the power is on and off when the power is off.

### 2 Remote Control Signal Receiver

Receives Remote Control signals. The maximum range of reception is approximately 8 m (26.2 ft) from front of the KX-VC500, and approximately 3 m (9.8 ft) from 20° on each side, total 40°.

### 3 Start button

Press to make or manually answer video conference calls. (Page 28, Page 37)

### 4 End button

Press to end a video conference call.

### 5 Power button

Turns the power on and off. (Page 24)

### 6 Status LED

Shows the operational status of the KX-VC500. (Page 18)

### 7 Home button

Press to display the Home screen. (Page 25)

### 8 One-Touch Connection buttons (LED lit)

Press to select a dial destination from up to 5 destinations displayed on the Home screen. (Page 28)

### Note

- During a video conference call, buttons other than **[Power]** and **[End]** cannot be used.

## Main Unit (Back)

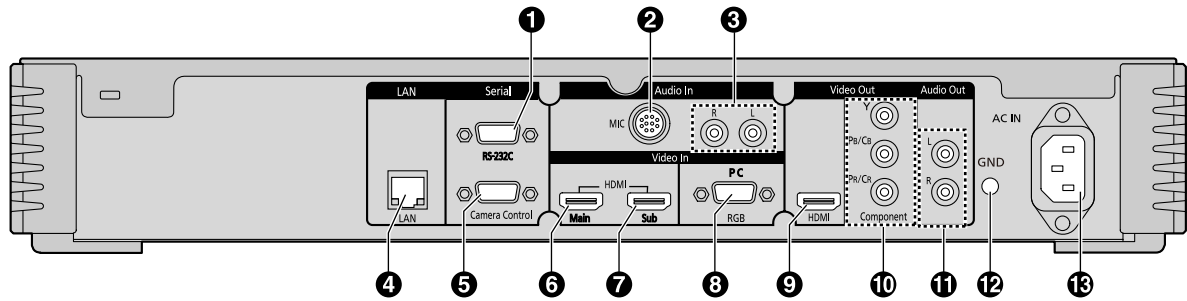

- ❶ **RS-232C terminal**  
This terminal is not available for use.
- ❷ **MIC jack (Page 20)**  
Used to connect the Boundary Microphone (optional). (Page 17)
- ❸ **Audio In L/R jack (Page 20)**  
Used to connect general-purpose microphones (not for the Boundary Microphone).
- ❹ **LAN jack (Page 20)**  
Connect a LAN cable.
- ❺ **Camera Control terminal**  
This terminal is not available for use.
- ❻ **Main Camera terminal (Page 20)**  
Connect the main video camera with an HDMI cable.
- ❼ **Sub Camera terminal**  
Used to connect a second, sub video camera with an HDMI cable for sharing video contents apart from the main video camera. (Page 52)
- ❽ **RGB terminal**  
Used to connect a computer for sending screens to participants. (Page 49)
- ❾ **HDMI terminal (Page 20)**  
Used to connect to the display with an HDMI cable.
- ❿ **Component terminal (Page 23)**  
Used to connect to the display with a component video cable.
- ⓫ **Audio Out L/R jack (Page 23)**  
Used to connect an amplifier or active speaker.
- ⓬ **GND terminal**  
Used to connect a grounding wire when the power cord's ground terminal connection is not available.
- ⓭ **AC IN (Page 21)**  
Connect the power cord.

## Remote Control

Press to show the sub video camera's images on your and the other party's display during a video conference call. When not on a video conference call, the sub video camera's images are shown on your display only. (Page 53)

Press to show your computer's screen on your and the other party's display during a video conference call. When not on a video conference call, the computer screen is shown on your display only. (Page 50)

Press to enter screen standby mode. (Page 18)

Press to make or manually answer video conference calls. (Page 28, 37)

Press to move the cursor and select items.

Press to display the Home screen. (Page 25)

Press to select the feature assigned to each color. Available features are displayed in the guide area. (Page 25)

This button is not available for use.

Press to display the connection status of the network and peripheral devices. (Page 56)

Press to display/hide information about the other party, guide area and duration, during a call. (Page 27)

Press to change the layout of the screen during a call. (Page 39)

Press to return to the main video camera after showing images from a computer or sub video camera. (Page 51, 53)

Press to display the Menu screen. (Page 26)

Press to end a call.

Press to confirm the selected item or entered information.

Press to return to the previous screen.

Press to adjust the volume during a call. Press [+] to increase and [-] to decrease the volume. (Page 45)

Press to select a tone (equalizer) setting during a call. (Page 48)

Press to mute the microphone during a call, so that the other party cannot hear your voice. (Page 46)

Press to display your contact list. This can only be pressed from the Home screen.

Press to dial or perform settings where inputting digits/characters is required. (Page 79)

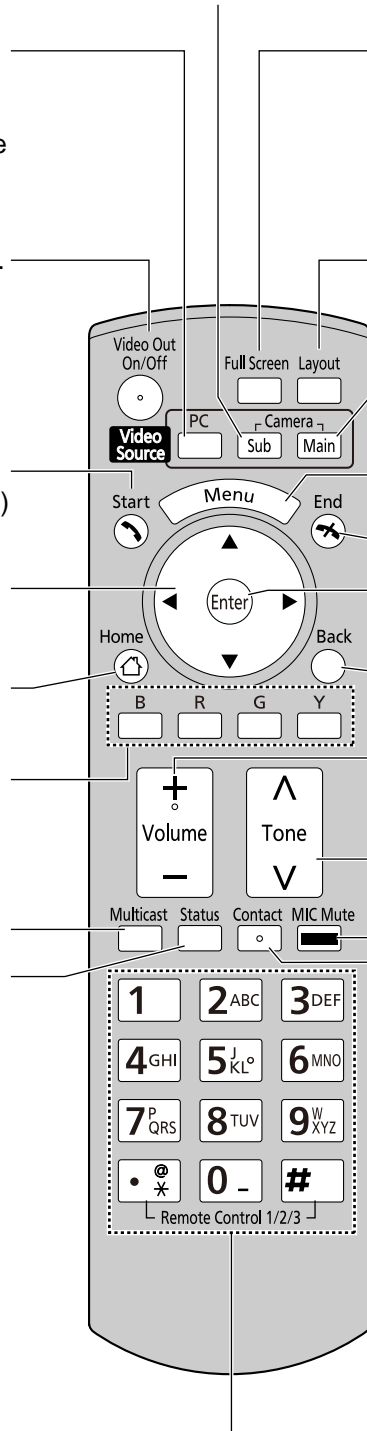



## Boundary Microphone (Optional Accessory)

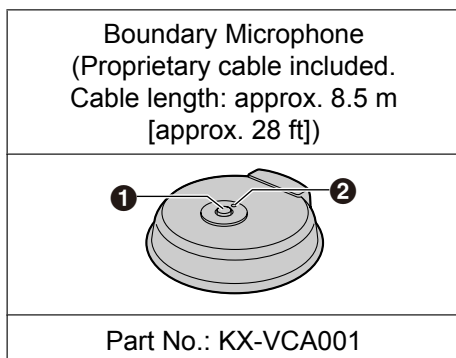

### ❶ MIC Mute button

Press to mute your own voice so that other video conference call participants cannot hear you. (Page 46)

### ❷ LED

Indicate the operational status of the Boundary Microphone.

Red (on): Microphone is muted.

Green (on): Transmitting

Orange (blinking in 1 second intervals): Starting up

Off: No transmission in progress

### Note

- Up to 4 Boundary Microphones can be connected in cascade.
- Contact your dealer for purchase information.

## Federal Communications Commission Requirements

### Federal Communications Commission Interference Statement

This equipment has been tested and found to comply with the limits for a Class A digital device, pursuant to Part 15 of the FCC Rules. These limits are designed to provide reasonable protection against harmful interference when the equipment is operated in a commercial environment. This equipment generates, uses and can radiate radio frequency energy and, if not installed and used in accordance with the instructions manual, may cause harmful interference to radio communications. Operation of this equipment in a residential area is likely to cause harmful interference in which case the user will be required to correct the interference at his own expense.

#### FCC Caution

To assure continued compliance, (example - use only shielded interface cables when connecting to other devices). Any changes or modifications not expressly approved by the party responsible for compliance could void the user's authority to operate this equipment.

This device complies with Part 15 of the FCC Rules. Operation is subject to the following two conditions: (1) This device may not cause harmful interference, and (2) this device must accept any interference received, including interference that may cause undesired operation.

## For Canada Users

This Class A digital apparatus complies with Canadian ICES-003.

Cet appareil numérique de la classe A est conforme à la norme NMB-003 du Canada.

## LED Patterns

LEDs indicate the operational status of the KX-VC500, as follows:

LED pattern	Status
Slow blue flashing	<ul style="list-style-type: none"> <li>Starting up</li> <li>Idle state</li> </ul>
Blue on	<ul style="list-style-type: none"> <li>In a video conference call (including when dialing, receiving a video conference call, and being disconnected)</li> </ul>
Orange on	<ul style="list-style-type: none"> <li>Self diagnosis is being performed.</li> </ul>
Orange flashing	<ul style="list-style-type: none"> <li>Mismatch of field frequency<sup>*1</sup> between the KX-VC500 and display. (After 30 seconds the flashing will stop and the KX-VC500 will restart in safe mode.)</li> </ul>
Red on	<ul style="list-style-type: none"> <li>An error has occurred.</li> <li>Maintenance is being performed.</li> </ul>
Red flashing	<ul style="list-style-type: none"> <li>A serious error has occurred.</li> </ul>
Off	<ul style="list-style-type: none"> <li>Power is off.</li> <li>In screen standby mode</li> </ul>

<sup>\*1</sup> Devices such as the display or video camera operate with a particular field frequency, depending on their video format. For details on the field frequency, contact your dealer.

## Screen Standby

When there is no video conference call transmission, and the KX-VC500 or remote control is not operated for more than 10 minutes (default), or when the remote control's **[Video Out On/Off]** button is pressed, the KX-VC500 enters screen standby mode. Video out to the display is suspended and the status LED turns off. Screen standby mode ends when the KX-VC500 or remote control is operated, or when a video conference call is received.

### Notice

- If screen standby mode ends and no image is visible, check to see if the display or video camera's power saving settings are enabled. Check each device's manual for more information about its power saving settings.

### Note

- You can change the length of time until the KX-VC500 enters screen standby mode. (Page 74)
- The KX-VC500 will not enter screen standby mode while displaying a computer's screen or a sub video camera's image, even if the KX-VC500 or remote control is not operated for a period of time.
- When the KX-VC500 or remote control is operated and screen standby mode ends, the Home screen will be displayed.
- If a button is pressed on the KX-VC500 or remote control to end screen standby mode, that button's operation is not performed in that case.
- If screen standby mode begins while editing information in the contact list or other screen, any unsaved changes will be lost.

- It takes about 7 seconds to return from screen standby mode. (The length of time may vary depending on the type of display you are using.)

# Connecting the KX-VC500

This section describes how to connect the main video camera, display, microphone, LAN cable and power cord.

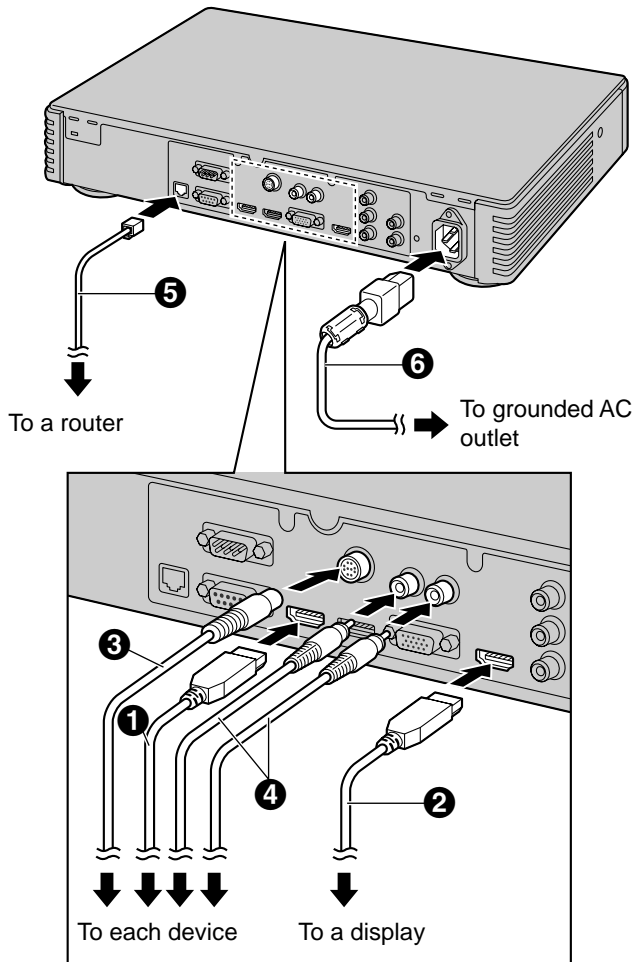

## Notice

- Use only the included power cord.

## Note

- Make sure to read the instruction manuals for all devices being connected.

### 1. Connect the main video camera.

- Connect the main video camera to the Main Camera terminal on the back of the KX-VC500 using an HDMI cable (1).

### 2. Connect the display.

- Connect the display to the HDMI terminal on the back of the KX-VC500 using an HDMI cable (2).

## Note

- If your display is not compatible with HDMI, use a component cable (Page 23). Since sound signals are not transmitted when using a component cable, connect an amplifier/active speaker. (Page 23)

### 3. Connect a microphone.

#### Boundary Microphone (optional)

Connect the Boundary Microphone to the MIC jack on the back of the KX-VC500 using the proprietary cable (3).

- Use only the included cable.
- Push and turn the connector of the proprietary cable until it clicks. If the connector does not click, try reconnecting the cable with the top and bottom of the connector reversed.

#### General-purpose microphone

Connect the microphone to the Audio In L/R jack on the back of the KX-VC500 using the stereo pin plug cable (4) after amplifying the signal to line level using a device such as a microphone amplifier.

- Connect the microphone correctly, as follows:
  - Left channel → L
  - Right channel → R

## Note

- When connecting both the Boundary Microphone and a general-purpose microphone, both microphones can be used simultaneously.

### 4. Connect to the network.

- Connect a router to the LAN jack on the back of the KX-VC500 using a category 5 or greater LAN cable (5).

## Note

- Set the hub/router to Auto Negotiation mode.
- If the system is set to 100M Full Duplex, it is necessary to change the system setting. For details, contact your dealer.
- Do not connect to a hub/router set to Half Duplex.
- For more details about routers and DCEs, refer to the documentation for each device.

5. Insert the included power cord (6) into the AC IN terminal on the back of the KX-VC500.
  - Use only the included power cord.
6. Plug in the power cord into the power outlet.
  - Choose an outlet that is convenient for plugging/unplugging.

## System Layout Examples

### Display and Main Video Camera

Place the display and main video camera at the same side of the room.

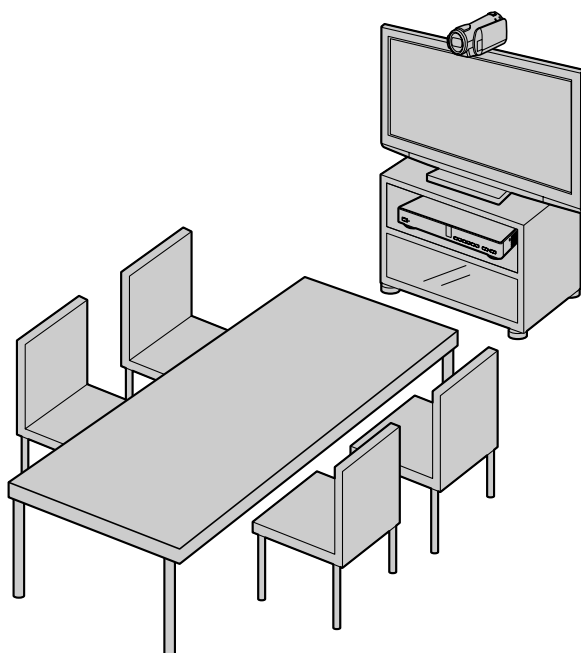

### Note

- If you use speakers, refer to "Amplifier/Active Speaker Connection" (Page 23).

### Microphones

Up to 4 Boundary Microphones can be connected in cascade. There are no separate terminals for input and output on the Boundary Microphones.

Also, Boundary Microphones and general-purpose microphones can be used simultaneously.

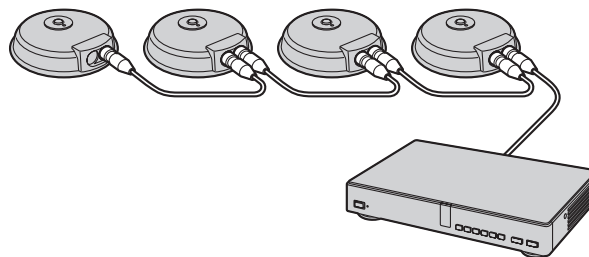

### Note

- Make sure that the microphones are placed at least 1 m (3.3 ft) away from the display and speakers.
- Do not connect more than 4 Boundary Microphones. Doing so will cause all Boundary Microphones to stop working.
- Monaural or stereo can be selected for the output of microphones through system settings.

Layout examples (the grey circle indicates the microphone's range):

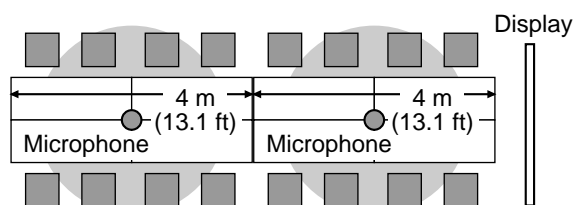
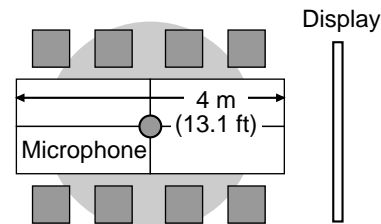

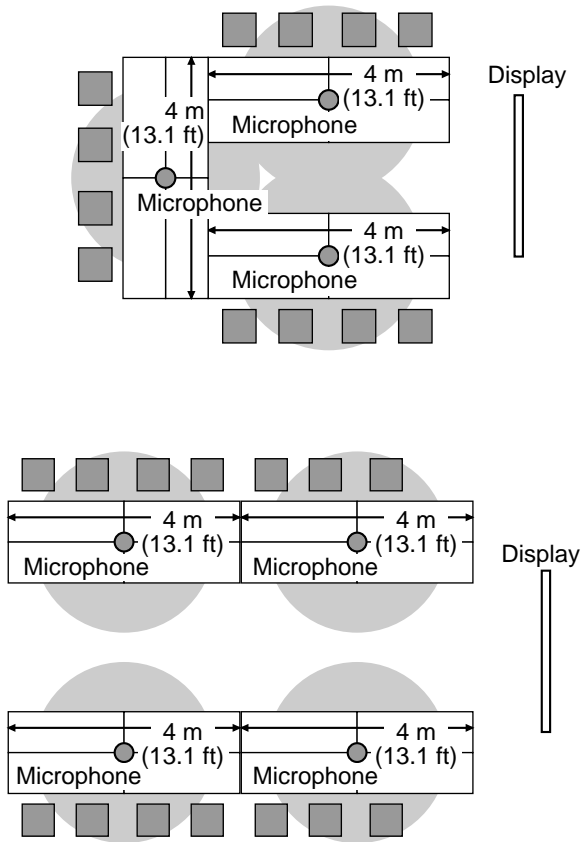

The range of each microphone (the radius of the circle with a microphone at the centre) varies according to the level of surrounding and the number of microphones being used. Place microphones accordingly, referring to the following table.

Noise level/ Microphone	40 dBsplA (a quiet room)	45 dBsplA (a regular room)	50 dBsplA (a noisy room)
1	approx. 3 m (approx. 9.8 ft)	approx. 2.2 m (approx. 7.2 ft)	approx. 1.2 m (approx. 3.9 ft)
2	approx. 2.8 m (approx. 9.2 ft)	approx. 1.5 m (approx. 4.9 ft)	approx. 1 m (approx. 3.3 ft)
3	approx. 2.3 m (approx. 7.5 ft)	approx. 1.3 m (approx. 4.3 ft)	—
4	approx. 2 m (approx. 6.6 ft)	approx. 1.1 m (approx. 3.6 ft)	—

## Amplifier/Active Speaker Connection

This section describes how to connect an amplifier/active speaker.

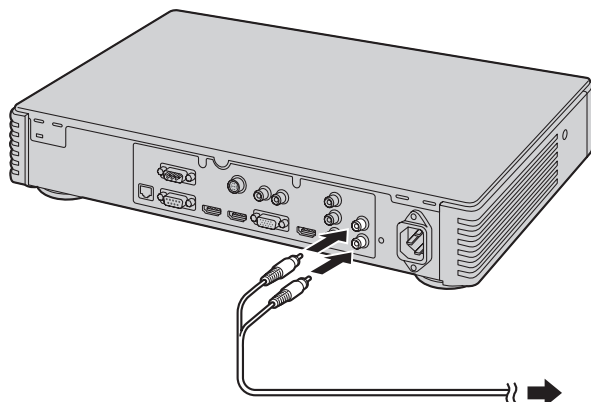

1. Connect the amplifier/active speaker to the Audio Out L/R jack on the back of the KX-VC500 using a stereo pin plug cable.

### Note

- Connect the amplifier/active speaker correctly, as follows:
  - Left channel → L
  - Right channel → R
- For more details about the amplifier or active speaker, refer to the documentation for the corresponding device.

Layout example:

Place the speakers either side of the display, as follows:

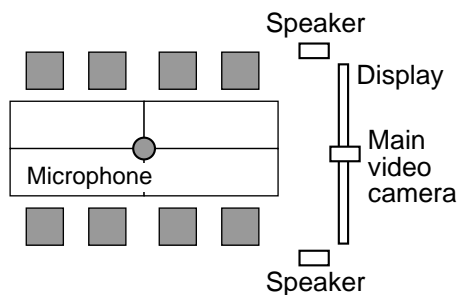

### Notice

- Place the speakers either side of the display. If you place the display at the front of the room and the speakers at the back, the microphone's left/right spatial direction may be reversed, and the orientation of the image and sound will not match on the other party's side.

## Connecting the Display with a Component Cable

If your display does not have an HDMI terminal, use a component cable for connection.

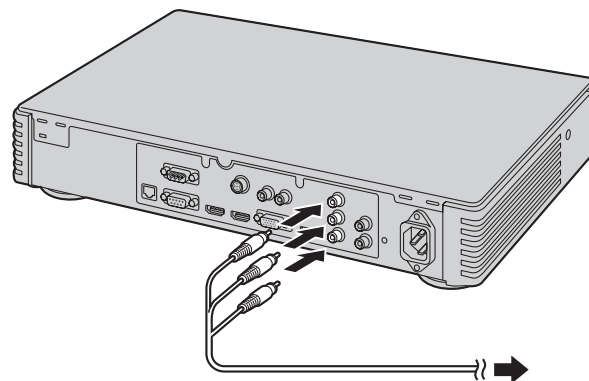

1. Connect the display to the Component terminal on the back of the KX-VC500 using a component cable.

# Turning the Power On/Off

## Note

- Make sure that peripheral devices (e.g., display, main video camera) are turned on.
- 1 Press the **[Power]** button on the front of the KX-VC500.
    - The Power LED and all of the One-Touch Connection button LEDs turn on. Then, the One-Touch Connection button LEDs turn off, the Status LED starts flashing blue slowly, and the Home screen is displayed.

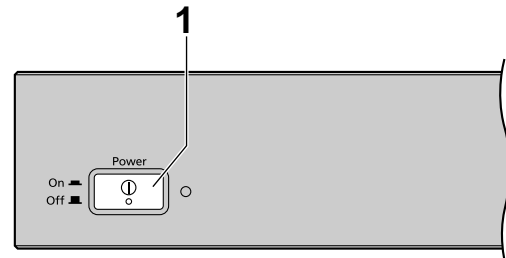
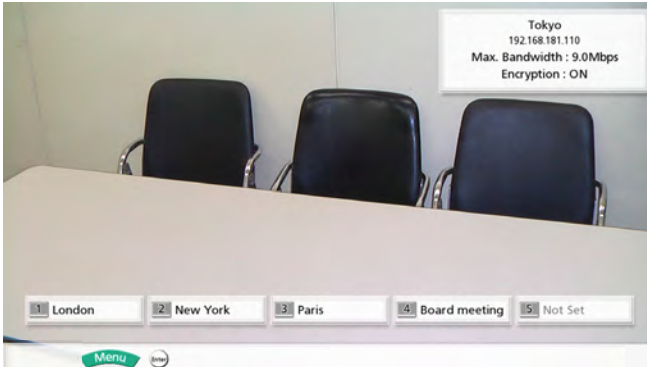

- When the power is turned off, the Power LED turns off.



# Screen Display

## Home Screen (Idle Screen)

Displayed when the power is turned on. Also displayed when the **[Home]** button is pressed on the KX-VC500 or on the remote control.

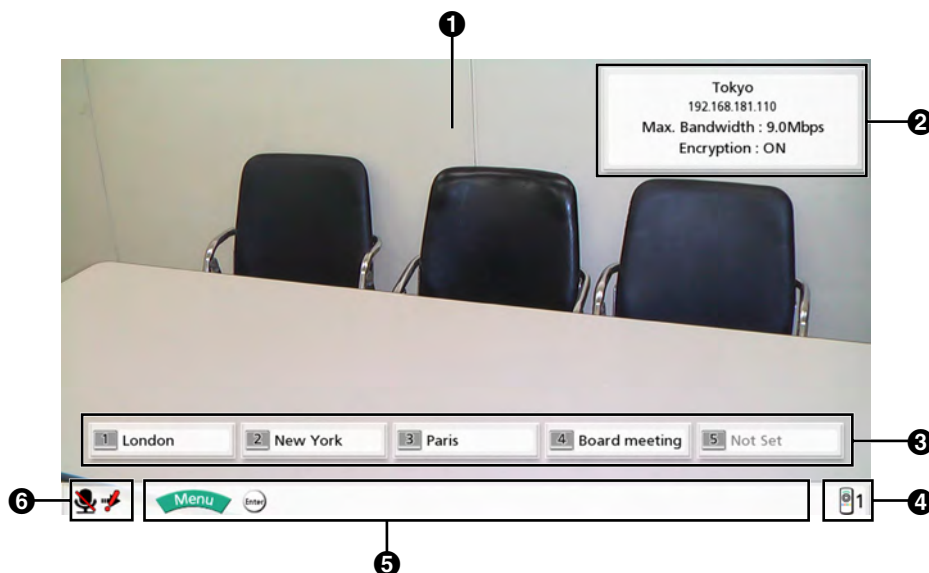

- 1 Main Video Camera Image**  
Displays the video from the main video camera.
- 2 Unit Information**  
Displays the KX-VC500's name, IP address, maximum bandwidth and encryption status.
- 3 Group/Site**  
Displays the name/group name assigned to One-Touch Connection number 1 through 5. If the name is too long to display, it will be shortened and ended with "...".
- 4 Remote Control ID**  
Displays the remote control ID of the KX-VC500 when it is set. (Page 68)
- 5 Guide**  
Displays operations you can perform with the remote control.
- 6 Status Indication**  
The status of the KX-VC500 is displayed with an icon.

Icon	Status
	Microphone is muted.
	<p>LAN cable or peripheral connection error (no connection, device error, etc.).</p> <p><b>Note</b></p> <ul style="list-style-type: none"> <li>If the MIC detection setting has been disabled through system settings (Page 64), the icon will not be displayed even if the Boundary Microphone is disconnected. However, if there are no connections, or there is a device error in other devices such as the LAN cable, the icon will be displayed.</li> </ul>

## Menu Screen (Idle Screen)

Displayed when [Menu] is pressed on the remote control. Displays operations you can perform and settings you can change.

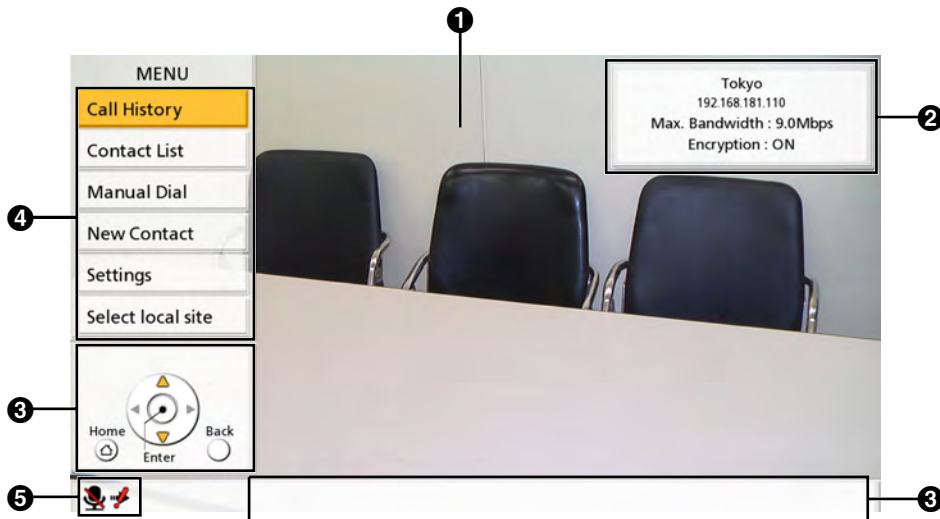

### 1 Main Video Camera Image

Displays the video from the main video camera.

### 2 Unit Information

Displays the KX-VC500's name, IP address, maximum bandwidth and encryption status.

### 3 Guide

Displays operations you can perform with the remote control when performing features or changing settings.

### 4 Menu List

Displays the various functions you can use and settings available to change.

### 5 Status Indication

The status of the KX-VC500 is displayed with an icon. (Page 25)

## Video Conference Call Screen



### 1 Other party's information

When registered in the contact list: The other party's name/group name is displayed.  
When not registered in the contact list: The other party's IP address is displayed.

### 2 Network Status Indication

This icon is displayed when the network is busy. The icon can be used as a measure for indicating network congestion.

The main color of the icon is as follows:

Red (network is very congested)

Yellow (network is congested)

Blue (normal status)

When the network returns to normal, the icon disappears after turning blue.

### Note

- If the red icon is displayed continuously, contact your network administrator.
- During multiple party video conference calls, the icon is displayed on each site screen, but not on your own image. Also, the icon is not displayed when the video conference call screen is not visible due to a layout change.

### 3 Video Image

Displays the other party's video, your own video, or video from the secondary video input such as a computer display or a sub video camera. (Page 49, Page 52)

### 4 Subscreen

Depending on the screen layout, your own video or the other party's video is displayed here. (Page 39, Page 40, Page 42)

### 5 Duration

Displays the duration of the current video conference call.

### 6 Guide

Displays operations you can perform with the remote control.

### 7 Status Indication

The status of the KX-VC500 is displayed with an icon. (Page 25)

### Note

- Pressing **[Full Screen]** on the remote control will hide or unhide the other party's information, duration, and guide displays. However, the network status indication will not be hidden.

## Making a Video Conference Call

You can make a video conference call using one of the following methods.

### Note

- During a video conference call, you cannot perform the following operations:
  - Pressing **[Menu]** to display the Menu screen.
  - Pressing **[Contact]** to display the contact list screen.
- Make sure that peripheral devices (e.g., display, main video camera) are turned on.
- If a called party does not answer a video conference call within approximately 60 seconds, the call will be terminated automatically.
- 2-party/3-party/4-party video conference calls can be made using the outgoing call history.
- Only 2-party video conference calls can be made using the incoming call history.
- You cannot add parties to an existing video conference call.
- During a 3-party/4-party video conference call, even if only one party ends the video conference call, the rest of the parties will also be disconnected.
- A video conference call will start with only the parties that answered the call. For example, if only one party answers a 4-party video conference call, the video conference call will start as a 2-party video conference call.

## Calling Using Speed Dial (2-party Conference/3-party Conference/4-party Conference)

### Note

- To call using speed dial, you need to have a speed dial number programmed in "**Speed Dial**" in the contact list. (Page 58)

## Calling from the Home Screen (Operation with the Main Unit)

- 1 Press **[Home]**.
  - The Home screen is displayed.
- 2 Press **[One-Touch Connection] (1 to 5)**.
  - The LED for the One-Touch Connection number you pressed lights up.
  - The information registered to the selected One-Touch Connection number is displayed.

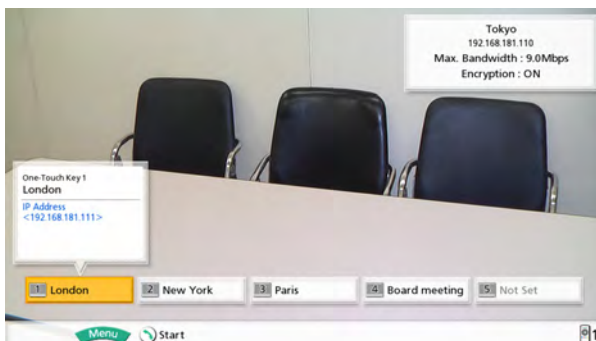

- 3 Press **[Start]** to start the call.

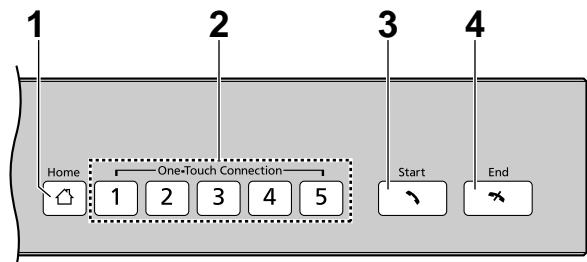

- 4 When you want to end the call, press **[End]**.
  - The Home screen is displayed.

## Calling from the Home Screen (Operation with the Remote Control)

- 1 Press **[Home]**.
  - The Home screen is displayed.
- 2 With the dial keys, enter a One-Touch Connection number (1 to 5).
  - The information registered in the selected One-Touch Connection number is displayed.

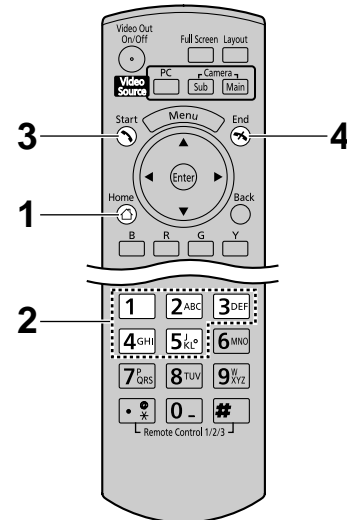
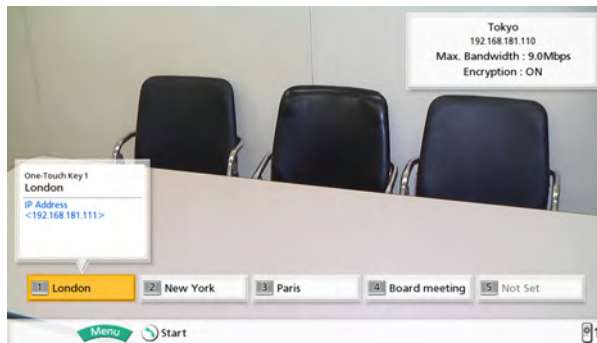

- 3 Press **[Start]** to start the call.
  - You can also start the call pressing **[Enter]**.
- 4 When you want to end the call, press **[End]**.
  - The Home screen is displayed.

## Calling from the Menu Screen (Operation with the Remote Control)

### Note

- From the Menu screen, you can make a video conference call using up to 99 speed dial numbers (1 to 99). (From the Home screen, you can make a video conference call using up to 5 One-Touch Connection numbers [1 to 5].)

- Press **[Menu]**.
  - The Menu screen is displayed.
- Select **"Contact List"** using **[▲]**/**[▼]** and press **[Enter]**.
  - The contact list screen is displayed.

### Note

- If you press **[G]**, the contact list modification screen will be displayed and the entry can be modified. (Page 59)

- Press **[Y]**.
  - The speed dial screen is displayed. Entries are displayed in speed dial number order.

No.	Group./Site	IP Address	One-Touch Key
1	London	192.168.181.111	One-Touch 1
2	New York	192.168.181.112	One-Touch 2
3	Paris	192.168.181.113	One-Touch 3
4	Board meeting London New York Paris	192.168.181.111 192.168.181.112 192.168.181.113	One-Touch 4
5	*Not Registered*		
6	Board meeting 2 London New York	192.168.181.111 192.168.181.112	
7	*Not Registered*		

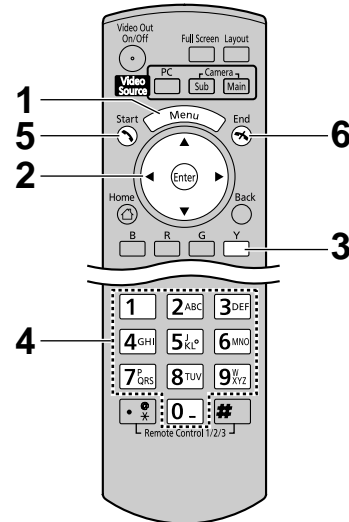

- With the dial keys, enter a speed dial number (1 to 99).
- Press **[Start]** to start the call.
- When you want to end the call, press **[End]**.
  - The Home screen is displayed.

## Calling from the Contact List (2-party Conference/3-party Conference/4-party Conference)

- 1 Press **[Menu]**.
  - The Menu screen is displayed.
- 2 Select **"Contact List"** using **[▲][▼]** and press **[Enter]**.
  - The contact list screen is displayed. The entries are grouped in the index tabs and displayed in alphabetical order of **"Group/Site"**.

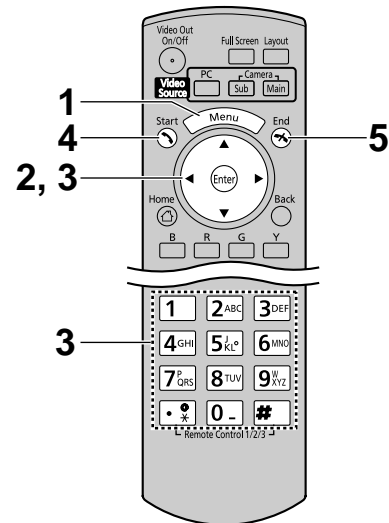
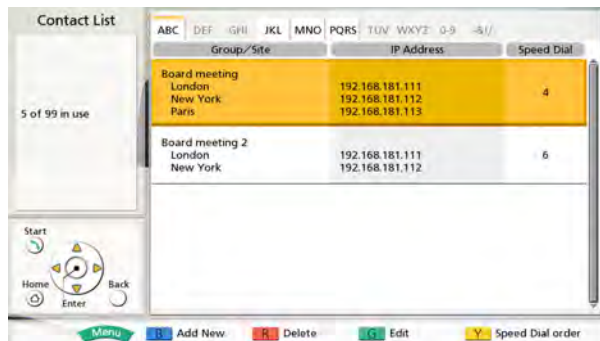

### Note

- You can also open the contact list screen pressing **[Contact]** from the Home screen.
- 3 Select the entry you want to call using **[▲][▼]**.
    - You can switch the index tab back and forth using **[◀][▶]**. (Index tabs in which no entries exist will be skipped.)
    - Press a numeric button on the remote control to switch to the index tab assigned to that button, as shown below.

Numeric button	Index Tab
1	—
2	ABC
3	DEF
4	GHI
5	JKL
6	MNO
7	PQRS
8	TUV
9	WXYZ
0	0-9
*	-&;/
#	—

## Starting a Video Conference

---

- 4 Press **[Start]** to start the call.
- 5 When you want to end the call, press **[End]**.
  - The Home screen is displayed.



## Calling by Entering an IP Address

You can make a video conference call by entering the IP address of the party you want to call.

- 1 Press **[Menu]**.
  - The Menu screen is displayed.
- 2 Select **"Manual Dial"** using **[▲]****[▼]** and press **[Enter]**.
  - The input screen is displayed.

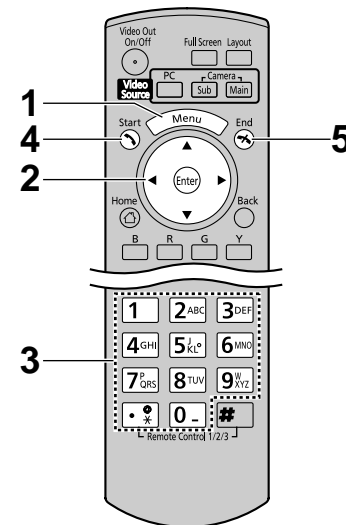
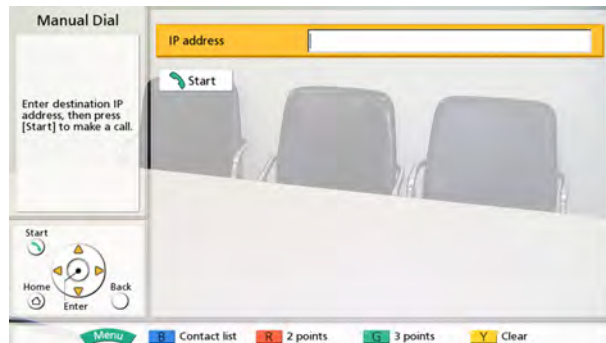

### Note

- You can press **[R]** or **[G]** to switch the screen to that button's pre-assigned screen to enter the IP addresses of multiple parties. The screen displayed by each button depends on the screen currently in use.

Display	Input Screen
1 point	Input screen 1 (2-party Conference)
2 points	Input screen 2 (3-party Conference)
3 points	Input screen 3 (4-party Conference)

### Example: When using Input screen 1

**[R]**: The screen will be switched to Input screen 2.

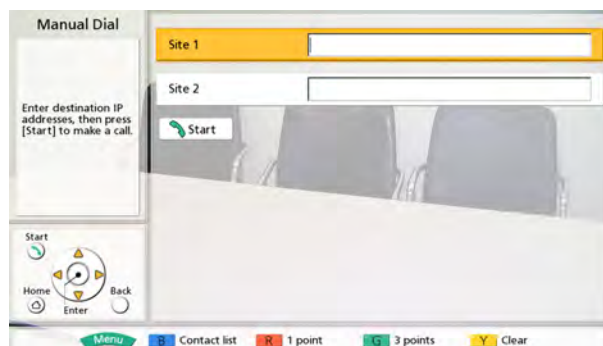

**[G]**: The screen will be switched to Input screen 3.

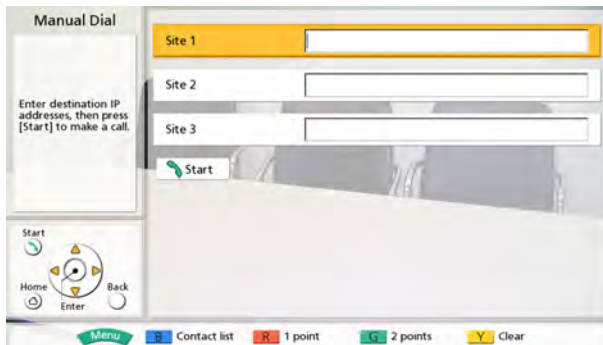

- IP addresses will be cleared if you move to another input screen without pressing **[Start]**.

### 3 Enter the IP address.

- If the IP address contains 1 or 2 digit numbers, enter these numbers as they are. Do not enter like [.001]. Example: The IP address is [192.168.0.1].
  - Correct entry: [192.168.0.1]
  - Wrong entry: [192.168.000.001]

### Note

- You can refer to the contact list when entering the IP address, by following the procedure below:
    1. Press **[B]**.
      - The contact list screen is displayed.
    2. Use **[▲]****[▼]** to select the contact you want to refer to.
      - You can use **[◀]****[▶]** to select the displayed tab. (Page 31)
      - You can use the numeric buttons of the remote control to select the displayed tab. (Page 31)
    3. Press **[Enter]**.
      - The display returns to the input screen.
  - You cannot enter the IP address using the call history.
- 4 Press **[Start]** to start the call.
- You can also start the call by pressing **[Enter]**.
- 5 When you want to end the call, press **[End]**.
- The Home screen is displayed.

## Calling from the Call History

You can make a video conference call from the call history. The call history is divided into outgoing and incoming calls. The last 30 video conference calls made and received are stored in the outgoing and incoming call history. Information such as the contact name or IP address, the date and time, the duration of the call, and the result of the call is displayed for each call on the outgoing call history screen and incoming call history screen. If the IP address of an entry in the call history is deleted from or edited in the contact list, the contact name in the call history entry will be replaced by the IP address.

### **Outgoing Call History:**

- 2-party/3-party/4-party video conference calls can be made using the outgoing call history.
- If consecutive video conference calls are made to the same destination, only the latest call will appear in the outgoing call history.
- For video conference calls made using the contact list, the contact name is displayed. For video conference calls made by entering the IP address directly, the IP address is displayed. (The IP address is also displayed even if a matching entry exists in the contact list.)

### **Incoming Call History:**

- Only 2-party video conference calls can be made using the incoming call history.
- If consecutive unanswered video conference calls are received from the same party, only the latest call will appear in the incoming call history.
- If the calling party's IP address is registered in the contact list, the contact name is displayed. Otherwise, the IP address is displayed.

- 1 Press **[Menu]**.
  - The Menu screen is displayed.
- 2 Select **"Call History"** using **[▲]****[▼]** and press **[Enter]**.
  - The outgoing call history screen is displayed.

Site	Date and Time	Duration	Call result
London	JUL/12/2010 02:21 PM	00:00:58	○
London	JUL/09/2010 07:33 PM	00:02:00	○
New York London	JUL/09/2010 07:32 PM	00:40:00	○
Paris	JUL/09/2010 12:23 PM	01:23:20	○
Paris New York London	JUL/01/2010 08:42 PM	00:52:58	○
Paris	JUL/01/2010 08:32 PM	00:00:30	○
New York	JUL/01/2010 08:32 PM	00:06:40	○

30 most recent outgoing calls are recorded. Please select an entry and press [Start] to make a call.

Start Home Enter Back

Menu Add as new Delete Incoming Call Delete All

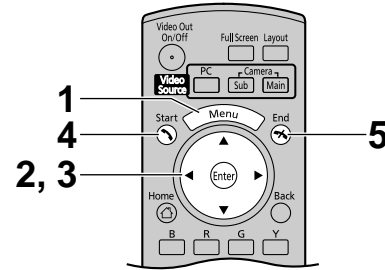

### Note

- The result of the video conference call is displayed in the **"Call result"** column as follows:
    - ○: The video conference call was established.
    - ✗: The video conference call was not established.
  - To move to the incoming call history screen, press **[G]**. You can switch between the outgoing call history screen and the incoming call history screen by pressing **[G]**.
  - In the incoming call history, if a party is not registered in your contact list, their IP address will be displayed.
  - In the outgoing call history, if a party is registered in your contact list, the contact name is displayed. However, when calling by entering an IP address, even if the party is registered in your contact list, their IP address is displayed.
  - When a contact in the incoming call history is newly added to your contact list, the incoming call history will be updated to display the contact's information from the contact list.
  - When a party that is not registered in your contact list is selected, if you press **[B]**, the contact list registration screen will be displayed and a new contact can be registered. (page 60)
- 3 Select the party you want to call using **[▲]****[▼]**.
  - 4 Press **[Start]** to start the call.
  - 5 When you want to end the call, press **[End]**.
    - The Home screen is displayed.

# Answering a Video Conference Call

Depending on your setting, you can either respond to a request to participate in a video conference call manually (manual answer) or automatically (automatic answer). (Page 63)

## Note

- Make sure that peripheral devices (e.g., display, main video camera) are turned on.

## When Manual Answer is Set

When a video conference call is incoming there will be an incoming call ring, and a dialog box is displayed.



When the caller is registered in the contact list, the caller's group/site is displayed.  
When the caller is not registered, the caller's IP address is displayed.

## Operation with the Main Unit

- 1 Press **[Start]**.
  - The video conference begins.

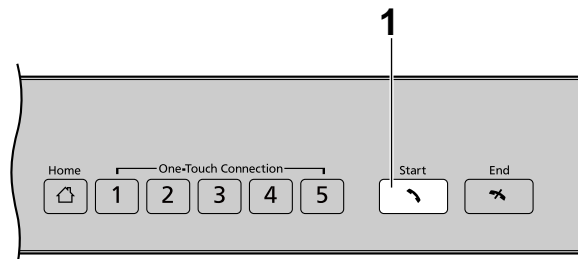

## Operation with the Remote Control

- 1 Press **[Start]**.
  - You can also answer the video conference call by pressing **[Enter]**.
  - The video conference begins.

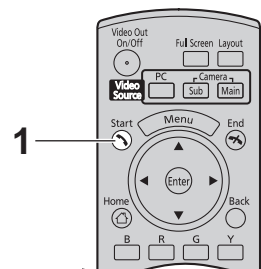

## Note

- If you do not answer a video conference call within approximately 60 seconds, the call will be terminated automatically.

## When Automatic Answer is Set

When a video conference call is incoming the call will be automatically answered after one ring, and transmission then begins.

# Changing the Screen Layout during a 2-party Video Conference Call

You can choose from 3 different screen layouts when taking part in a 2-party video conference call.

**1 Press [Layout].**

- The screen will cycle through the available layouts each time you press **[Layout]**.
  - **Layout 1:** The other party's image is displayed full screen.
  - **Layout 2:** The other party's image is displayed full screen, and your own image is displayed in the upper right subscreen.
  - **Layout 3:** Your own image is displayed full screen.

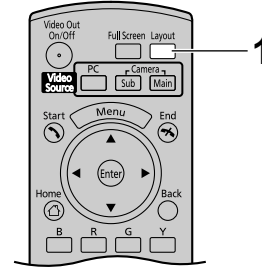

Layout 1

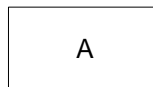

Layout 2



Layout 3

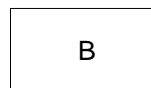

A: Other Site  
B: This Site

**Note**

- You can press **[B]**, **[R]**, or **[G]** to switch the screen layout to that button's pre-assigned layout.
  - **[B] "Other Site": Layout 1**
  - **[R] "Both Sites": Layout 2**
  - **[G] "This Site": Layout 3**
- When using a secondary video source (Page 49, Page 52), the screen layout cannot be changed.

# Changing the Screen Layout during a 3-party Video Conference Call

You can choose from 4 different screen layouts when taking part in a 3-party (This Site, Site 1, Site 2) video conference call.

1 Press **[Layout]**.

- The screen will cycle through the available layouts each time you press **[Layout]**.
  - Layout 1:** Image of Site 1 on the left and image of Site 2 on the right.
  - Layout 2:** Image of Site 1 is displayed full screen and image of Site 2 is displayed in the upper right subscreen.
  - Layout 3:** Image of Site 2 is displayed full screen and image of Site 1 is displayed in the upper left subscreen.
  - Layout 4:** Your own image is displayed full screen.

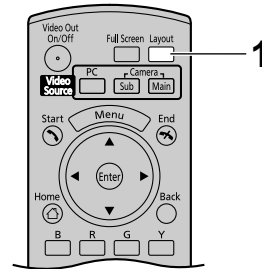

Layout 1

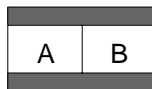

Layout 4

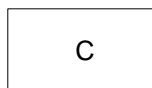

Layout 2

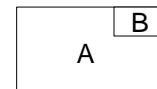

Layout 3

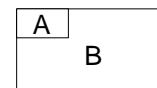

A: Site 1  
B: Site 2  
C: This Site



**Note**

- You can press **[B]**, **[R]**, or **[G]** to switch the screen layout to that button's pre-assigned layout. The layout displayed by each button depends on the screen layout currently in use.

Display	Screen Layout
Side by Side	Layout 1
Site 1(2)	Layout 2
(Site 1) 2	Layout 3
This Site	Layout 4

**Example: When using Layout 2**

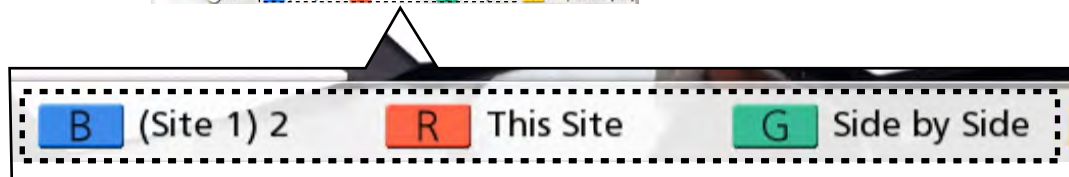

- [B]**: The screen layout will be switched to Layout 3.
- [R]**: The screen layout will be switched to Layout 4.
- [G]**: The screen layout will be switched to Layout 1.
- When using a secondary video source (Page 49, Page 52), the screen layout cannot be changed.

# Changing the Screen Layout during a 4-party Video Conference Call

You can choose from 6 different screen layouts when taking part in a 4-party (This Site, Site 1, Site 2, Site 3) video conference call.

**1** Press **[Layout]**.

- The screen will cycle through the available layouts each time you press **[Layout]**.
  - **Layout 1:** The images are displayed as follows:  
Site 1: upper left  
Site 2: bottom middle  
Site 3: upper right
  - **Layout 2:** The images are displayed as follows:  
Site 1: upper left  
Site 2: lower left  
Site 3: upper right  
This Site: lower right
  - **Layout 3:** The image of Site 1 is displayed full screen.
  - **Layout 4:** The image of Site 2 is displayed full screen.
  - **Layout 5:** The image of Site 3 is displayed full screen.
  - **Layout 6:** Your own image is displayed full screen.

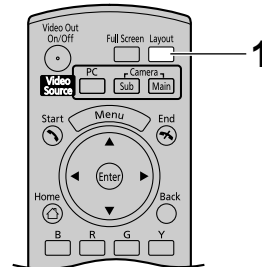

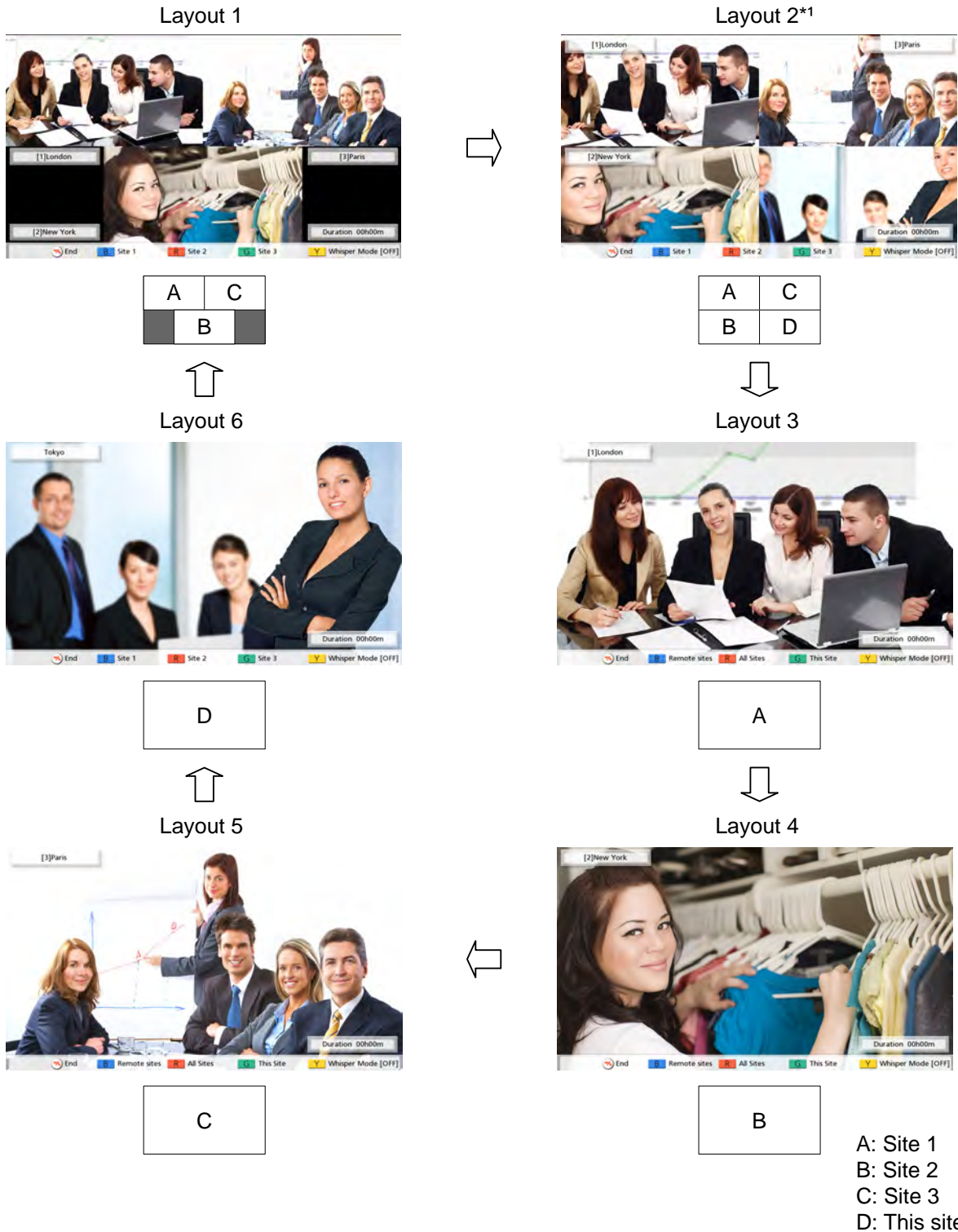

\*1 Image edges are trimmed and the image is centered.

**Note**

- You can press **[B]**, **[R]**, or **[G]** to switch the screen layout to that button's pre-assigned layout. The layout displayed by each button depends on the screen layout currently in use.

Display	Screen Layout
Remote sites	Layout 1
All Sites	Layout 2
Site 1	Layout 3
Site 2	Layout 4
Site 3	Layout 5
This Site	Layout 6

**Example: When using Layout 3**

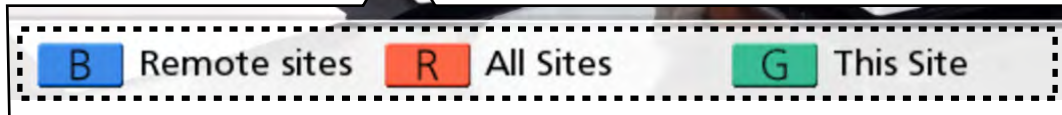

- [B]: The screen layout will be switched to Layout 1.
- [R]: The screen layout will be switched to Layout 2.
- [G]: The screen layout will be switched to Layout 6.
- When using a secondary video source (Page 49, Page 52), the screen layout cannot be changed.

# Adjusting the Volume

You can adjust the volume during a video conference call.

- 1 Press **[Volume (+/-)]**.
  - The volume level bar is displayed at the bottom of the screen.
- 2 Adjust the volume using **[Volume (+/-)]**.
  - Pressing **[+]** will increase the volume of the other party's voice.
  - Pressing **[-]** will decrease the volume of the other party's voice.
- 3 After about 3 seconds, the volume level bar disappears.

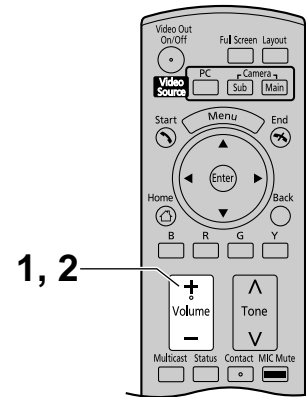

## Note

- You can set the volume level of a video conference call before starting the call. (Page 62)
- After ending a video conference call, the volume level returns to the volume level set before starting the call.
- You cannot adjust the display's volume.

## Muting the Microphone

During a video conference call, you can mute the microphone so that your voice cannot be heard by the other party. You will be able to hear the other party's voice, but they will not be able to hear you.

### Note

- You can set the microphone(s) to be mute at the start of a received video conference call. (Page 63)

### Muting the Microphone (Operation with the Remote Control)

- Press **[MIC Mute]**.
  - An icon appears in the status display area of the screen (Page 25), and the LED light on the Boundary Microphone (Page 17) becomes red. Make sure the color of the LED changes.
  - Pressing **[MIC Mute]** again will unmute the microphone.

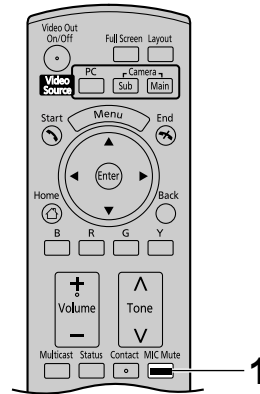

### Muting the Microphone (Operation with the Boundary Microphone)

- Press the MIC Mute button.
  - An icon appears in the status display area of the screen (Page 25), and the LED light on the Boundary Microphone (Page 17) becomes red. Make sure the color of the LED changes.
  - Pressing the MIC Mute button again will unmute the microphone.

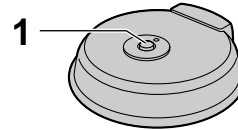

### Note

- When multiple Boundary Microphones are connected, pressing the MIC Mute button of one Boundary Microphone will mute all Boundary Microphones.

## Reducing Microphone Noise

You can reduce the amount of ambient noise picked up by the microphone (shuffling of papers, etc.) during a video conference call. When noise reduction is in effect, the volume level of voices may also be reduced.

### 1 Press [Y].

- **"Whisper Mode [ON]"** is displayed, and noise reduction is enabled.

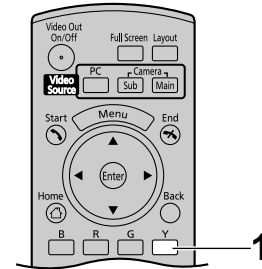
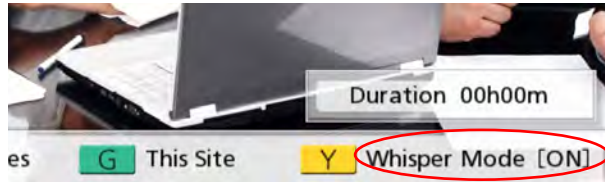

- Pressing [Y] again will display **"Whisper Mode [OFF]"**, and noise reduction is disabled.

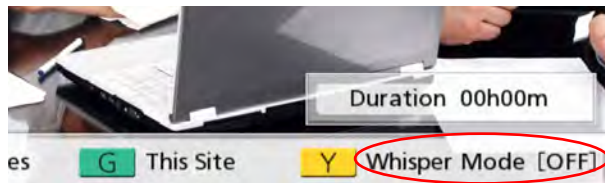

### Note

- You can set whether to enable noise reduction for a video conference call before starting the call. (Page 64)
- After a video conference call is finished, the noise reduction setting returns to the value set before starting the call.

# Adjusting the Tone

You can adjust the tone during a video conference call.

- 1 Press **[Tone (^V)]**.
  - The tone control dialog box appears, and the current tone setting is displayed.

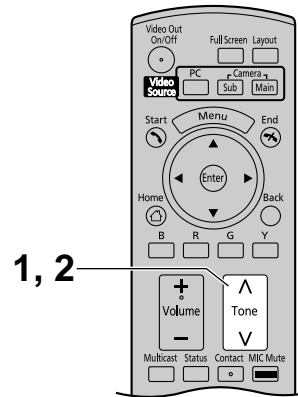
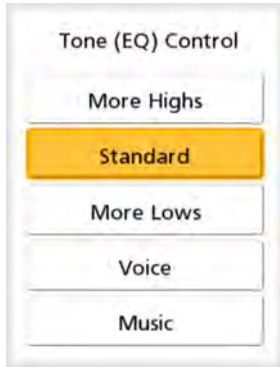

- 2 Press **[Tone (^V)]** to select a tone setting.
  - **"More Highs"**: high-pitched sounds are amplified.
  - **"Standard"**: default sound.
  - **"More Lows"**: low-pitched sounds are amplified.
  - **"Voice"**: makes voices easier to hear when there is a high level of ambient noise.
  - **"Music"**: makes sounds with a broad frequency, such as music, easier to hear.
- 3 After about 3 seconds, the tone control dialog box disappears.

**Note**

- You can set the tone of a video conference call before starting the call. (Page 62)
- After a video conference call is finished, the tone setting returns to the value set before starting the call.



## Displaying a Computer's Screen

You can display a computer's screen on your display and to other parties by connecting the computer to the KX-VC500.

This is convenient when explaining something on the computer's screen while showing it to others, for example.

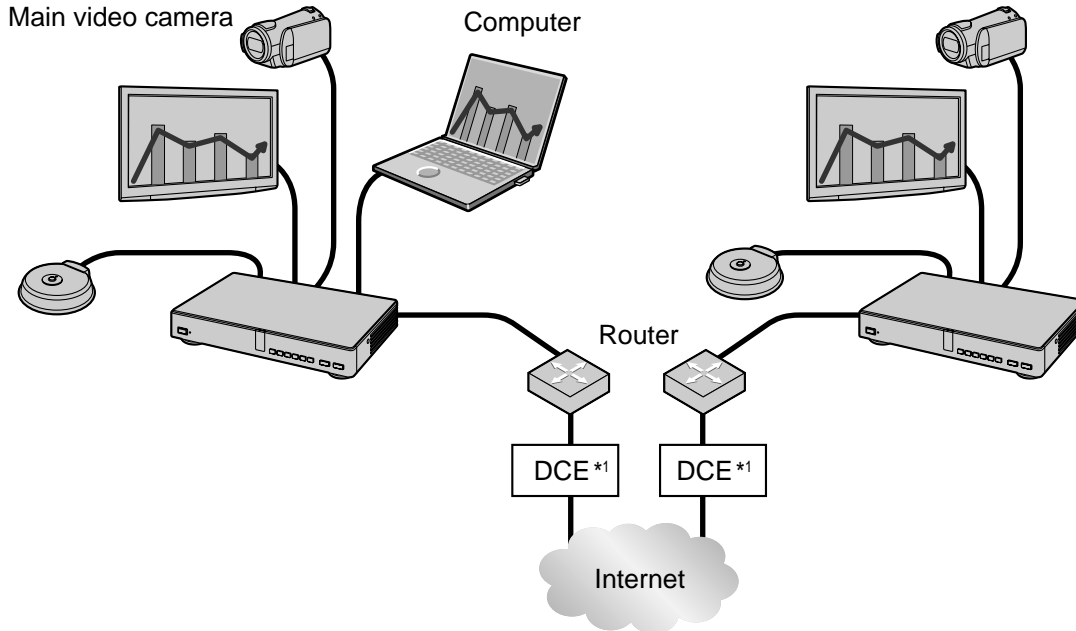

\*1 DCE: Data Circuit-terminating Equipment

## Connecting the Computer

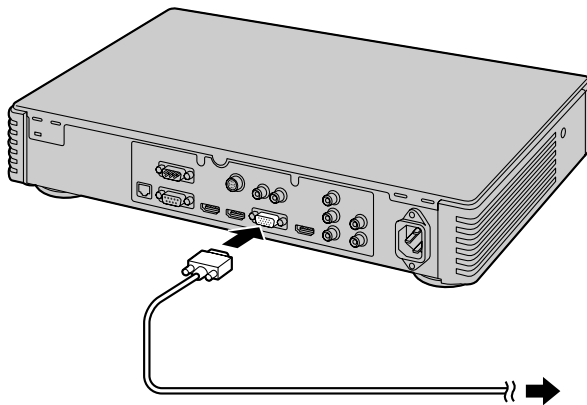

- Connect your computer's monitor output to the back of the KX-VC500 using a VGA cable. (Page 15)
- Make sure the cable used has the correct connector shapes to connect to both your computer and to the KX-VC500.
- You can connect or disconnect the computer during a video conference call.
- You can only display one computer's screen at a time.

- The computer screen resolutions supported by the KX-VC500 are VGA (640 × 480), SVGA (800 × 600), and XGA (1024 × 768). SXGA (1280 × 1024) is not supported. For each resolution, the following settings are supported:

Resolution	Refresh Rate (Hz)
VGA	60/72/75/85
SVGA	60/72/75/85
XGA	60/70/75/85

## Displaying the Computer's Screen

You can switch the display from the main video camera to the computer screen during a video conference call.

### 1 Press **[PC]**.

- The computer's screen is displayed. The computer screen is also shown on the other party's display.

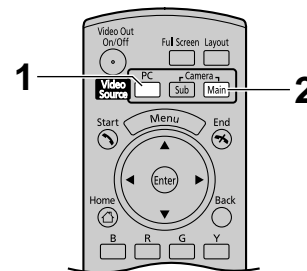
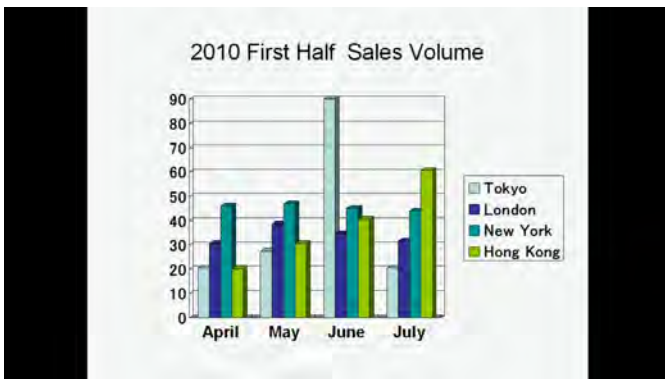

**Note**

- Pressing **[Full Screen]** on the remote control will hide or unhide the other party's information, duration, and guide displays.
  - While displaying your computer's screen, the other party cannot press **[PC]** to display their own computer's screen.
  - If a sub video camera is connected, you can also switch to the sub video camera image by pressing **[Camera Sub]** (Page 52). Only the party that pressed **[PC]** can perform this operation. To return to displaying your computer's screen, press **[PC]**.
  - While displaying your computer's screen, you can switch to displaying the other party's image in **Layout 1** by pressing **[B]** (Page 39, Page 40, Page 42). However, the other party cannot perform this operation, and the other party cannot confirm if you are viewing your computer's screen or the other party's image. When viewing the other party's image, the screen layout is fixed to **Layout 1**. To return to displaying your computer's screen, press **[B]**.
- 2 Press **[Camera Main]** to return to showing the main video camera's image.

**Note**

- Only the party that pressed the **[PC]** button can perform this operation.

**Note**

- On the Home screen, you can also display the computer's screen on your display by pressing **[PC]**. While the computer's screen is displayed, the KX-VC500 will not enter screen standby mode. To return to the Home screen, press **[Camera Main]**.

## Displaying the Sub Video Camera's Image

When a sub video camera is connected to the KX-VC500, you can display the sub video camera's image on your display and to other parties.

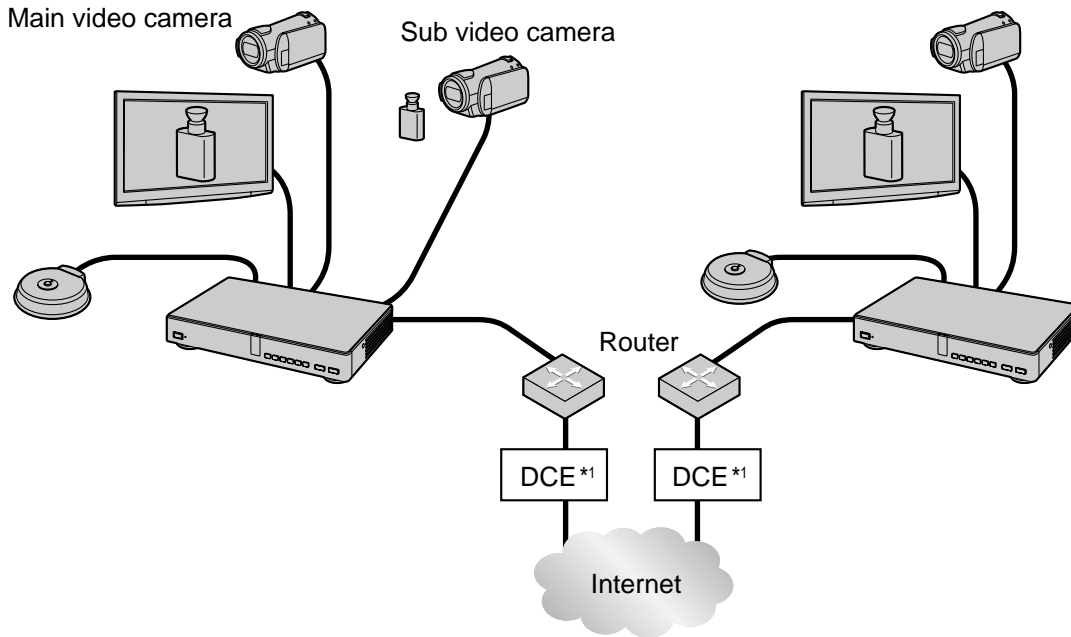

\*1 DCE: Data Circuit-terminating Equipment

## Connecting the Sub Video Camera

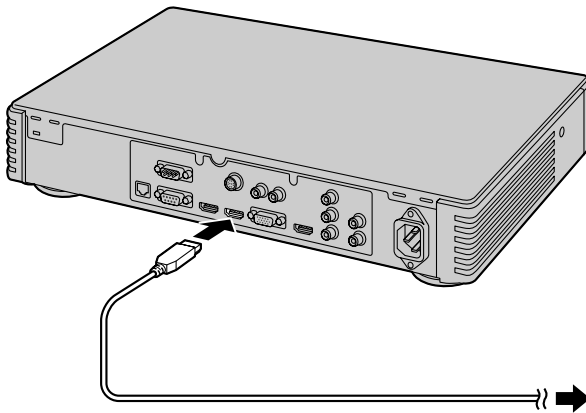

- Connect a video camera to the back of the KX-VC500 using an HDMI cable. (Page 15)
- You can connect or disconnect the sub video camera during a video conference call.
- You can only display the image of one sub video camera at a time.
- Only video cameras that can output 1080i resolution using HDMI can be used.

## Displaying the Sub Video Camera's Image

You can switch the display from the main video camera to a sub video camera during a video conference call.

**1** Press **[Camera Sub]**.

- The sub video camera's image is displayed. The image is also visible on the other party's display.

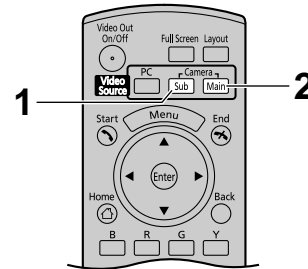

**Note**

- Pressing **[Full Screen]** on the remote control will hide or unhide the other party's information, duration, and guide displays.
- While displaying your sub video camera's image, the other party cannot press **[Camera Sub]** to display their own sub video camera's image.
- If a computer is connected you can also switch to the computer screen's image by pressing **[PC]**. (Page 49) Only the party that pressed **[Camera Sub]** can perform this operation. To return to displaying your sub video camera's image, press **[Camera Sub]**.
- While displaying your sub video camera's image, you can switch to displaying the other party's image in **Layout 1** by pressing **[B]** (Page 39, Page 40, Page 42). However, the other party cannot perform this operation, and the other party cannot confirm if you are viewing your sub video camera's image or the other party's image. When viewing the other party's image, the screen layout is fixed to **Layout 1**. To return to displaying your sub video camera's image, press **[B]**.

**2** Press **[Camera Main]** to return to showing the main video camera's image.

**Note**

- Only the party that pressed **[Camera Sub]** can perform this operation.

### **Note**

- On the Home screen, you can also display the sub video camera's image on your display by pressing **[Camera Sub]**. While the sub video camera's image is displayed, the KX-VC500 will not enter screen standby mode. To return to the Home screen, press **[Camera Main]**.

## Displaying a Still Image from the Sub Video Camera

You can display a still image from the sub video camera during a video conference call.

### Note

- Fix your sub video camera and the object so that the image is not blurred.

- 1 Press **[Camera Sub]**.
  - The sub video camera's image is displayed.
- 2 Press **[R]**.
  - The still image from your sub video camera is displayed on your display and the other party's display.

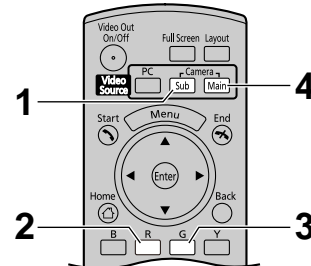

### Note

- The image becomes gradually clear after a black screen is displayed for about 1 second.
- If you press **[R]** while the still image is being sent, the image taken when you pressed **[R]** the second time is sent to other party's display again.
- If the network has low bandwidth and a high rate of packet loss, either it will take a long time to display a clear image, or a blurred image will be displayed.

- 3 Press **[G]**.
  - The display switches from the still image back to the normal sub video camera image.

### Note

- A black screen is displayed for about 1 second after you press **[G]**.

- 4 Press **[Camera Main]**.
  - The screen returns to the main video camera's image.

# Displaying the Connection Status

You can confirm the connection status of the network and peripheral devices.

- 1 Press **[Status]**.
  - The connections status screen is displayed. An "X" mark is displayed next to any network or peripheral devices connection that is not in normal operation or not connected.

**Example: The Boundary Microphone connection is not normally operating.**

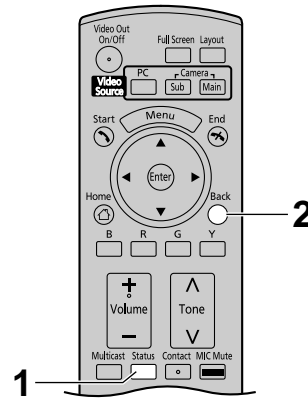
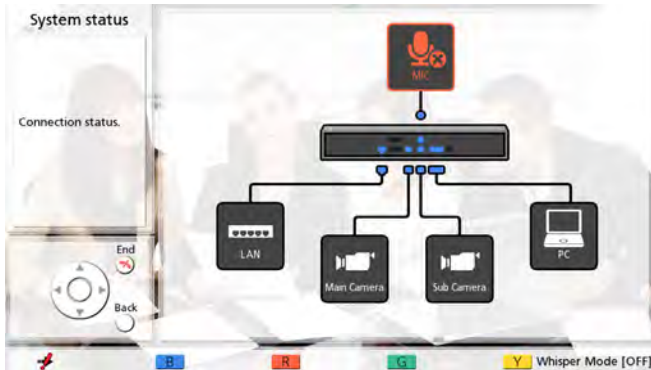

- **"MIC"** displays the connection status of the Boundary Microphone only. The connection status of general-purpose microphones is not displayed.
- If the MIC detection setting has been disabled through system settings, the connection status of the Boundary Microphone will not be displayed. (Page 64)

- 2 Press **[Back]**.
  - The display returns to the screen in use before the connections status screen was viewed.



# Displaying Unit Information

- 1 Press **[Status]** twice.
  - The unit information screen is displayed.

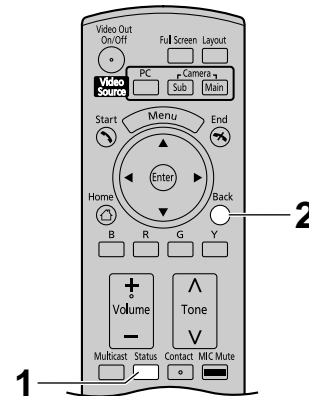
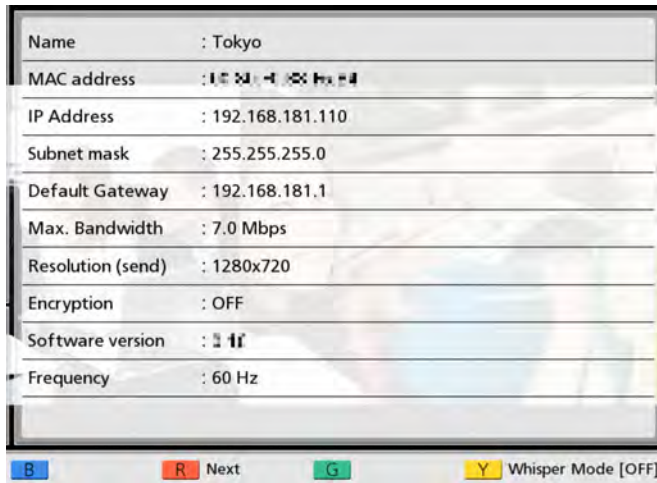

- The status of communication encryption is displayed under "**Encryption**" and the resolution for sending images is displayed under "**Resolution (send)**". This information is not displayed when communication is not occurring.
- If **[Status]** is pressed twice during a video conference call, you can press **[R]** to switch to the next screen. That screen displays the IP address, packet loss rate, connection bandwidth, resolution, frame rate and field frequency for the 3 parties displayed under "**Site 1**", "**Site 2**" and "**Site 3**".



- 2 Press **[Back]**.
  - The display returns to the screen in use before the step 1 was performed.

# Adding Contacts to the Contact List

You can register the information of up to 99 contacts in the contact list.

## Note

- If a video conference call is received while data is being entered, a dialog box to confirm if you answer a video conference call is displayed. Use [◀][▶] to select "Yes" or "No" and press [Enter].
- When "Yes" is selected, you can answer a video conference call while any unsaved data is lost.
- When "No" is selected, you can continue entering the data.

## Registering a New Contact

### Registering a Single-party Contact

1. Press [Menu].
  - The Menu screen is displayed.
2. Use [▲][▼] to select "New Contact" and press [Enter].
  - The contact list registration screen is displayed.

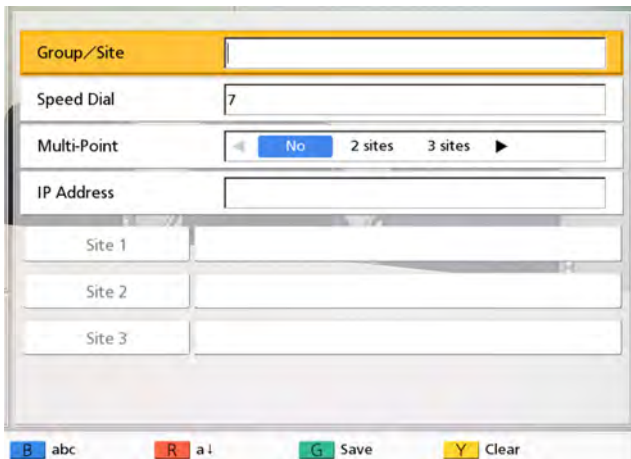

3. Use [▲][▼] to select the following items for input:
  - "Group/Site": Enter a name for the contact (up to 24 characters). (Page 79)
  - "Speed Dial": Enter a speed dial number (1–99).
  - "Multi-Point": Use [◀][▶] to select "No".
  - "IP Address": Enter an IP address.
    - If the IP address contains 1 or 2 digit numbers, enter these numbers as they are. Do not enter like [.001].  
Example: The IP address is [192.168.0.1].
      - Correct entry: [192.168.0.1]
      - Wrong entry: [192.168.000.001]
4. Press [G].
  - A dialog box to confirm the saving of settings is displayed.
5. Use [◀][▶] to select "Yes" and press [Enter].
  - The contact list screen is displayed.

## Note

- To continue entering another contact, press [B] and repeat steps 3–5.

6. Press [Home].
  - The Home screen is displayed.

### Registering a Multiple-party Contact

1. Press [Menu].
  - The Menu screen is displayed.
2. Use [▲][▼] to select "New Contact" and press [Enter].
  - The contact list registration screen is displayed.

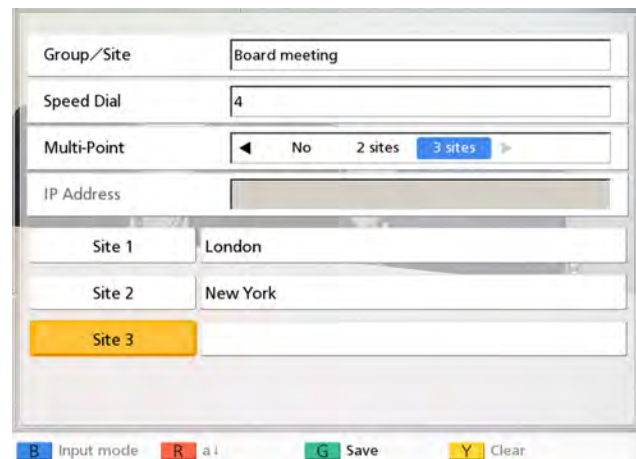

- Use [▲][▼] to select the following items for input:  
**"Group/Site"**: Enter a name for the video conference call (up to 24 characters). (Page 79)  
**"Speed Dial"**: Enter a speed dial number (1–99).  
**"Multi-Point"**: Use [◀][▶] to select **"2 sites"** or **"3 sites"**.  
 For **"Site 1"/"Site 2"/"Site 3"**: Use the following procedure to select these from the contact list screen.

- Use [▲][▼] to select **"Site 1"**, **"Site 2"** or **"Site 3"**.
- Press [Enter].
  - The contact list screen is displayed.
- Select a contact using [▲][▼].
  - You can use [◀][▶] to select the displayed tab. (Page 31)
  - You can use the numeric buttons of the remote control to select the displayed tab. (Page 31)
- Press [Enter].
  - The contact list registration screen is displayed.

- Press [G].
  - A dialog box to confirm the saving of settings is displayed.
- Use [◀][▶] to select **"Yes"** and press [Enter].
  - The contact list screen is displayed.

**Note**

- To continue entering another contact, press [B] and repeat steps 3–5.

- Press [Home].
  - The Home screen is displayed.

## Editing Contact Information

- Press [Menu].
  - The Menu screen is displayed.
- Use [▲][▼] to select **"Contact List"** and press [Enter].
  - The contact list screen is displayed.
- Use [▲][▼] to select the contact you want to edit.
  - You can use [◀][▶] to select the displayed tab. (Page 31)
  - You can use the numeric buttons of the remote control to select the displayed tab. (Page 31)

- Press [Enter].
  - The contact list details screen is displayed.
- Press [G].
  - The contact list edit screen is displayed.

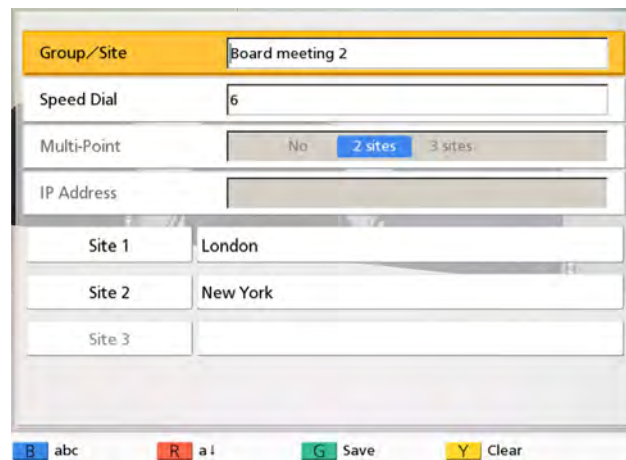

- Use [▲][▼] to select the item you want to edit and make any changes. (Page 79)
- Press [G].
  - A dialog box to confirm the saving of settings is displayed.
- Use [◀][▶] to select **"Yes"** and press [Enter].
  - The contact list screen is displayed.
- Press [Home].
  - The Home screen is displayed.

## Deleting a Contact

- Press [Menu].
  - The Menu screen is displayed.

- Use [▲][▼] to select "Contact List" and press [Enter].
  - The contact list screen is displayed.

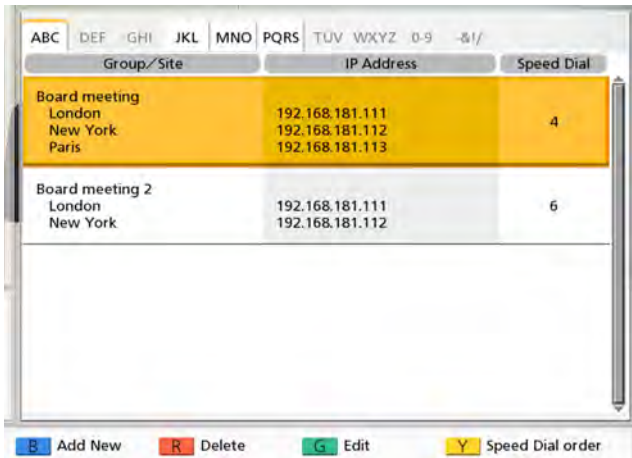

- Use [▲][▼] to select the contact you want to delete.
  - You can use [◀][▶] to select the displayed tab. (Page 31)
  - You can use the numeric buttons of the remote control to select the displayed tab. (Page 31)
- Press [R].
  - A dialog box to confirm the deletion is displayed.
- Use [◀][▶] to select "Yes" and press [Enter].
  - The contact list screen is displayed.
- Press [Home].
  - The Home screen is displayed.

## Registering a Contact from the Call History

### Registering a Single-party Contact

You can register a contact to the contact list from the call history.

- Press [Menu].
  - The Menu screen is displayed.
- Use [▲][▼] to select "Call History" and press [Enter].
  - The outgoing call history screen is displayed.

### Note

- To refer to the incoming call history, press [G].

- Use [▲][▼] to select the single-party entry you want to add as a contact, and press [B].
  - The contact list registration screen is displayed.

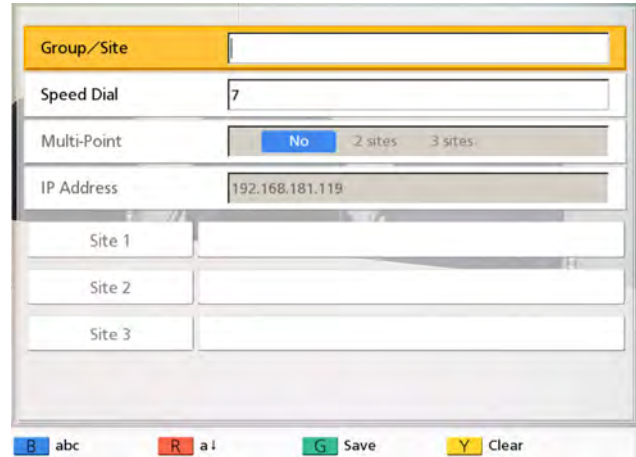

- Use [▲][▼] to select the necessary items and input information. (Page 79)
- Press [G].
  - A dialog box to confirm the saving of settings is displayed.
- Use [◀][▶] to select "Yes" and press [Enter].
  - The outgoing or incoming call history screen is displayed, depending on which of the screens you displayed in step 2.
- Press [Home].
  - The Home screen is displayed.

### Registering a Multiple-party Contact

You can register a multiple-party contact to the contact list from the outgoing call history.

### Note

- When you register a multiple-party contact to the contact list from the call history, each party is also registered automatically as a single-party contact and each IP address is registered in "Group/Site".

- Press [Menu].
  - The Menu screen is displayed.

2. Use [▲][▼] to select **"Call History"** and press [Enter].
  - The outgoing call history screen is displayed.
3. Use [▲][▼] to select the multiple-party entry you want to add as a multiple-party contact, and press [B].
  - The contact list registration screen is displayed.

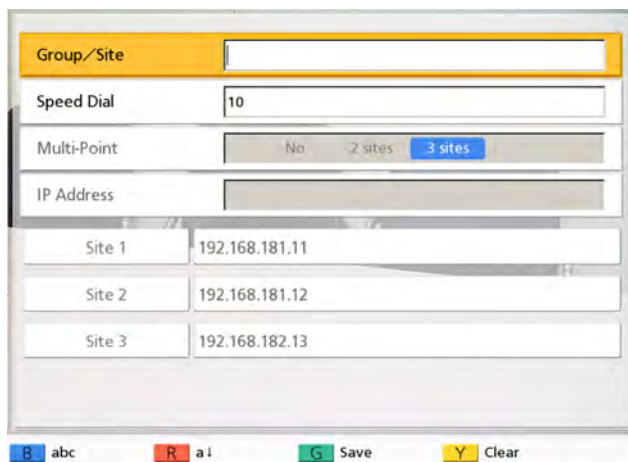

4. Use [▲][▼] to select the necessary items and input information. (Page 79)
5. Press [G].
  - A dialog box to confirm the saving of settings is displayed.
6. Use [◀][▶] to select **"Yes"** and press [Enter].
  - The call history screen is displayed.
7. Press [Home].
  - The Home screen is displayed.

## Changing System Settings

### Note

- If a video conference call is received while data is being entered, the data entry is interrupted and any unsaved data is lost.

## Setting the Unit Name

1. Press [Menu].
  - The Menu screen is displayed.
2. Use [▲][▼] to select **"Settings"** and press [Enter].
  - The system settings screen is displayed.
3. Use [▲][▼] to select **"System Settings"** and press [Enter].
  - The unit name setting screen is displayed.

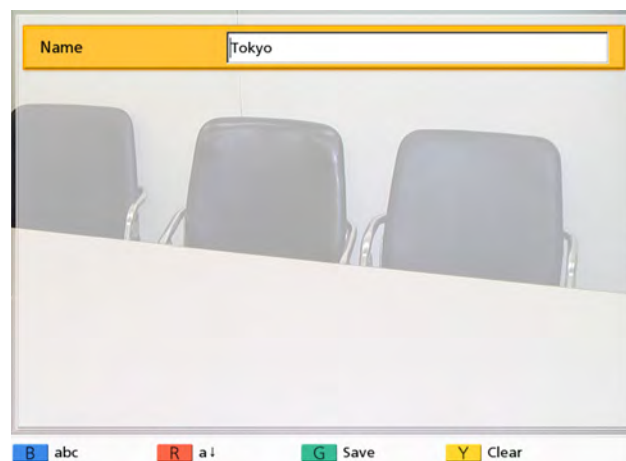

4. Enter a unit name (up to 24 characters). (Page 79)
5. Press [G].
  - A dialog box to confirm the saving of settings is displayed.
6. Use [◀][▶] to select **"Yes"** and press [Enter].
  - The system settings screen is displayed.
7. Press [Home].
  - The Home screen is displayed.

## Setting the Date and Time

1. Press **[Menu]**.
  - The Menu screen is displayed.
2. Use **[▲][▼]** to select **"Settings"** and press **[Enter]**.
  - The system settings screen is displayed.
3. Use **[▲][▼]** to select **"Set Date/Time"** and press **[Enter]**.
  - The date/time settings screen is displayed.



4. Use **[▲][▼]** to select the item and input information.
  - Enter the year (4 digits), month (1–2 digits), day (1–2 digits), time (24 hour display), and select hour display format (12h/24h).
5. Press **[G]**.
  - A dialog box to confirm the saving of settings and system restart after saving is displayed.
6. Use **[◀][▶]** to select **"Yes"** and press **[Enter]**.
  - The system will automatically restart to reflect changes to system settings.

## Making Network Settings

1. Press **[Menu]**.
  - The Menu screen is displayed.
2. Use **[▲][▼]** to select **"Settings"** and press **[Enter]**.
  - The system settings screen is displayed.

3. Use **[▲][▼]** to select **"Network Settings"** and press **[Enter]**.
  - The network settings screen is displayed.

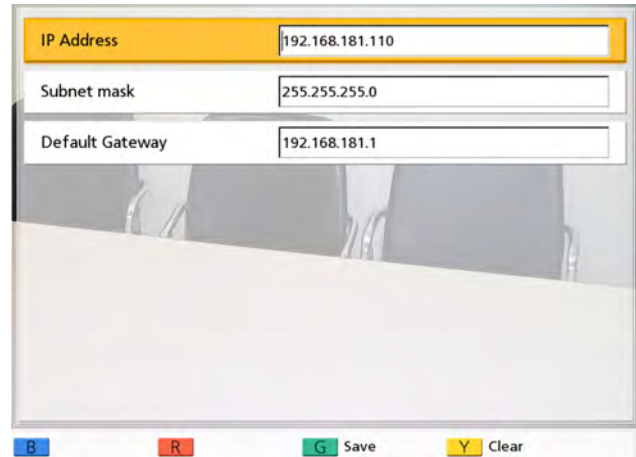

4. Use **[▲][▼]** to select the items you want to set, and input the relevant data.
  - If the IP address contains 1 or 2 digit numbers, enter these numbers as they are. Do not enter like [.001].  
Example: The IP address is [192.168.0.1].
    - Correct entry: [192.168.0.1]
    - Wrong entry: [192.168.000.001]
5. Press **[G]**.
  - A dialog box to confirm the saving of settings is displayed.
6. Use **[◀][▶]** to select **"Yes"** and press **[Enter]**.
  - The system settings screen is displayed.
7. Press **[Home]**.
  - The Home screen is displayed.

## Making Sound Settings

1. Press **[Menu]**.
  - The Menu screen is displayed.
2. Use **[▲][▼]** to select **"Settings"** and press **[Enter]**.
  - The system settings screen is displayed.

- Use [▲][▼] to select "Sound Settings" and press [Enter].
  - The sound settings screen is displayed.

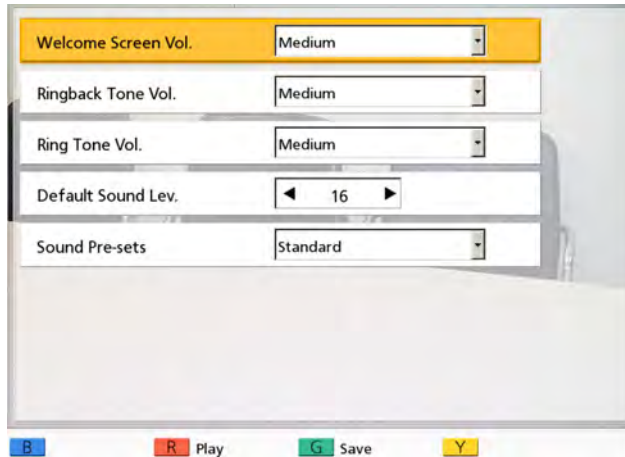

- Use [▲][▼] to select the following items for input:
  - "Welcome Screen Vol.": Press [Enter] and use [▲][▼] to select the volume level ("Low", "Medium" [default] or "High") played at the start-up.
  - "Ringback Tone Vol.": Press [Enter] and use [▲][▼] to select the volume level ("Low", "Medium" [default] or "High") of an outgoing call ring.

**Note**

- The volume level of the busy tone will be the same level as the ring back tone.

"Ring Tone Vol.": Press [Enter] and use [▲][▼] to select the volume level ("Low", "Medium" [default] or "High") of an incoming call ring.

"Default Sound Lev.": Use [◀][▶] to select the volume level (0–20) at the start of a video conference call (default: 16).

"Sound Pre-sets": Press [Enter] and use [▲][▼] to select the tone ("More Highs", "Standard" [default], "More Lows", "Voice" or "Music") at the start of a video conference call. (Page 48)

**Note**

- You can listen to a sample of the following items by pressing [R].
  - "Welcome Screen Vol."
  - "Ringback Tone Vol."
  - "Ring Tone Vol."

- Press [G].
  - A dialog box to confirm the saving of settings is displayed.
- Use [◀][▶] to select "Yes" and press [Enter].
  - The system settings screen is displayed.
- Press [Home].
  - The Home screen is displayed.

## Making Connection Settings

- Press [Menu].
  - The Menu screen is displayed.
- Use [▲][▼] to select "Settings" and press [Enter].
  - The system settings screen is displayed.
- Use [▲][▼] to select "Call set up" and press [Enter].
  - The connection settings screen is displayed.

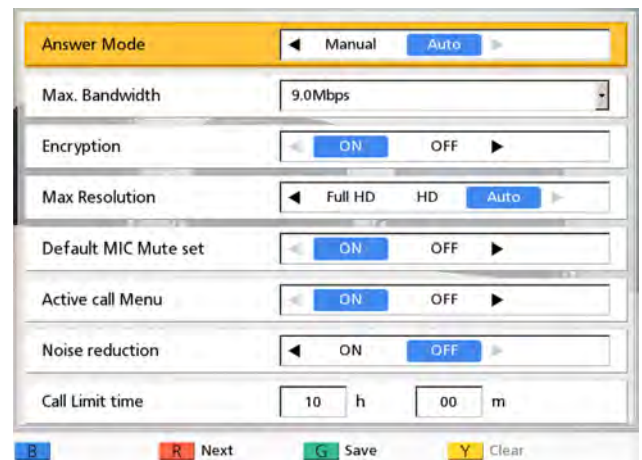

- Use [▲][▼] to select the following items for input:
  - The following items are displayed over 2 pages. To view all the items, press [R] to move to the next page, and press [B] to move to the previous page.
  - You must save the settings separately for each screen on which you changed the settings.
  - "Answer Mode": Use [◀][▶] to select how to answer video conference calls ("Manual" [default] or "Auto"). (Page 37)
  - "Max. Bandwidth": Press [Enter] and use [▲][▼] to select the maximum allowed bandwidth to be used (1.0Mbps, 1.2Mbps, 2.0Mbps, 3.0Mbps,

**4.0Mbps, 5.0Mbps, 6.0Mbps, 7.0Mbps, 8.0Mbps, 9.0Mbps [default], 10.0Mbps).**

**Note**

- The maximum bandwidth during a video conference call adjusts to that of the party that has set the lowest bandwidth for the maximum bandwidth setting among all participating parties.
- You cannot select a value that is higher than the maximum bandwidth set by the dealer. For details, contact your dealer.
- When you make a 4-party video conference call, select a value of **"2.0Mbps"** or higher. Otherwise, the image quality and the sound quality cannot be guaranteed.

**"Encryption"**: Use [◀][▶] to select whether to enable encryption.

- **"ON"**: Encryption is enabled.
- **"OFF"** (default): Encryption is disabled.

**Note**

- Take care when changing encryption settings because doing so may cause you to become unable to communicate with other parties.
- Be aware that if encryption is disabled, eavesdropping might be possible on networks that are not secured against such actions.
- If you cannot specify a value for **"Encryption"** because the setting is unavailable, contact your network administrator.

**"Max Resolution"**: Use [◀][▶] to select the maximum display resolution used during a video conference call.

- **"Full HD"**: This mode switches the display resolution according to the state of the network. (Maximum resolution: 1920 × 1080i)
- **"HD"**: This mode switches the display resolution according to the state of the network. (Maximum resolution: 1280 × 720p)
- **"Auto"** (default): This mode selects either **"Full HD"** or **"HD"** according to the available bandwidth.

**Note**

- Selecting **"Auto"** or **"HD"** is recommended.
- When **"Full HD"** is selected, if the other party has a low bandwidth, the display resolution may be lower than when **"HD"** or **"Auto"** is selected.

- If the field frequency is different between parties in a video conference call, the maximum resolution will be **"HD"**, even if you have specified **"Full HD"**.
- When making a 3-party video conference call, the main video camera will be automatically set to **"HD"**, even if you have specified **"Full HD"**.
- When making a 4-party video conference call, the main video camera and sub video camera will be automatically set to **"HD"**, even if you have specified **"Full HD"**.

**"Default MIC Mute set"**: Use [◀][▶] to select whether to mute the microphone(s) at the start of a received video conference call.

- **"ON"**: Mutes the microphone(s).
- **"OFF"** (default): Does not mute the microphone(s).

**"Active call Menu"**: Use [◀][▶] to select whether to display the guide when a video conference call begins.

- **"ON"** (default): Displays the guide.
- **"OFF"**: Hides the guide.

**"Noise reduction"**: Use [◀][▶] to select whether to enable noise reduction when a video conference call begins.

- **"ON"**: Enables noise reduction.
- **"OFF"** (default): Disables noise reduction.

**"Call Limit time"**: Enter the maximum length of time for the duration of a video conference call (in hours and minutes).

**Note**

- If you set 0 hours 0 minutes (default), the call time is unlimited.
- If the duration of a video conference call exceeds the specified length of time, the call will be automatically disconnected.

**"MIC detection"**: Use [◀][▶] to select whether to enable the detection of the connection status of the Boundary Microphones.

- **"ON"** (default): Enables the detection of Boundary Microphones.
- **"OFF"**: Disables the detection of Boundary Microphones.

**Note**

- When not using Boundary Microphones, set this to **"OFF"**.

**"Still image quality"**: Use [◀][▶] to select the display resolution to use when you send still images to other parties.



- **"Full HD"** (default): The resolution of still images is Full HD.
- **"HD"**: The resolution of still images is HD.

**Note**

- If the network has low bandwidth and a high rate of packet loss, selecting **"HD"** is recommended. For details, contact your dealer.
- If the field frequency is different between parties in a video conference call, the display resolution will be **"HD"**, even if you have specified **"Full HD"**.
- During a 4-party video conference call, the display resolution will be **"HD"**, even if you have specified **"Full HD"**.

5. Press **[G]**.
  - A dialog box to confirm the saving of settings is displayed.
6. Use **[◀][▶]** to select **"Yes"** and press **[Enter]**.
  - The system settings screen is displayed.
7. Press **[Home]**.
  - The Home screen is displayed.

## Display Unit Information

You can view the setting information for the KX-VC500.

1. Press **[Menu]**.
  - The Menu screen is displayed.
2. Use **[▲][▼]** to select **"Settings"** and press **[Enter]**.
  - The system settings screen is displayed.
3. Press **[▶]**.
  - The next page is displayed.

4. Use **[▲][▼]** to select **"System Info."** and press **[Enter]**.
  - The unit information screen is displayed. (Page 57)

Name	: Tokyo
MAC address	: 9E F1 B3 C2 7F 7F
IP Address	: 192.168.181.110
Subnet mask	: 255.255.255.0
Default Gateway	: 192.168.181.1
Max. Bandwidth	: 9.0 Mbps
Resolution (send)	:
Encryption	:
Software version	: 1.1E
Frequency	: 60 Hz

5. Press **[Home]**.
  - The Home screen is displayed.

## Setting the Mic Position

You can specify where a Boundary Microphone is conceptually positioned relative to the display. When sounds are transmitted to another party, they are played in accordance with the specified positions, which creates a stereo environment.

### Setting the Mic Position automatically

1. Press **[Menu]**.
  - The Menu screen is displayed.
2. Use **[▲][▼]** to select **"Settings"** and press **[Enter]**.
  - The system settings screen is displayed.
3. Press **[▶]**.
  - The next page is displayed.
4. Use **[▲][▼]** to select **"MIC Setting"** and press **[Enter]**.
  - The auto settings screen is displayed.

**Note**

- If the manual settings screen is displayed, press **[B]** to return to the auto settings screen.



**5. Press [G].**

- A dialog box to confirm the saving of settings is displayed.

**6. Use [◀][▶] to select "Yes" and press [Enter].**

- The system settings screen is displayed.

**Note**

- Depending on how many Boundary Microphones are connected, the output settings differ as follows:
  - 2 or more Boundary Microphones: Monaural output
  - 1 Boundary Microphone: Stereo output

**7. Press [Home].**

- The Home screen is displayed.

## Setting the Mic Position manually

**1. Press [Menu].**

- The Menu screen is displayed.

**2. Use [▲][▼] to select "Settings" and press [Enter].**

- The system settings screen is displayed.

**3. Press [▶].**

- The next page is displayed.

**4. Use [▲][▼] to select "MIC Setting" and press [Enter].**

- The auto settings screen is displayed.

**Note**

- If the manual settings screen is displayed, proceed to step 6.

**5. Press [B].**

- The manual settings screen is displayed.

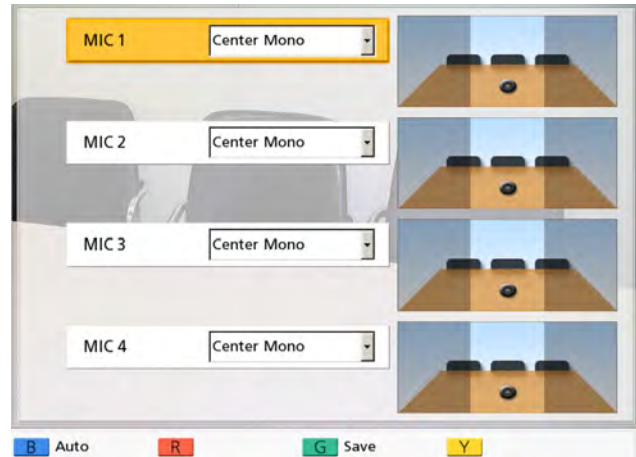

**6. Use [▲][▼] to select the Boundary Microphone you want to configure and press [Enter].**

**7. Use [▲][▼] to select the Boundary Microphone's relative position.**

**"Left side"**: Sounds on left side are played.

**"Right side"**: Sounds on right side are played.

**"Center Mono"**: All sounds are played through both the left and right speakers at the same volume.

**"Center stereo"**: Sounds centered on the microphone are played through both the left and right speakers at the same volume.

**Note**

- When a Boundary Microphone is set to **"Center stereo"**, make sure that it is placed with its connector facing the display.
- For the settings shown in the following diagrams, the left/right channels are displayed as viewed from the side of the main video camera.

Here are examples of the relative position of Boundary Microphones.

**When setting Boundary Microphones in a row perpendicular to the display:**

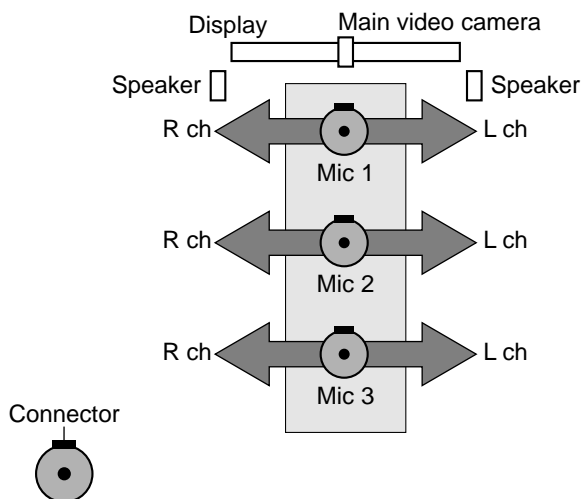

Mic 1: "Center stereo"  
 Mic 2: "Center stereo"  
 Mic 3: "Center stereo"

**When setting Boundary Microphones parallel with the display:**

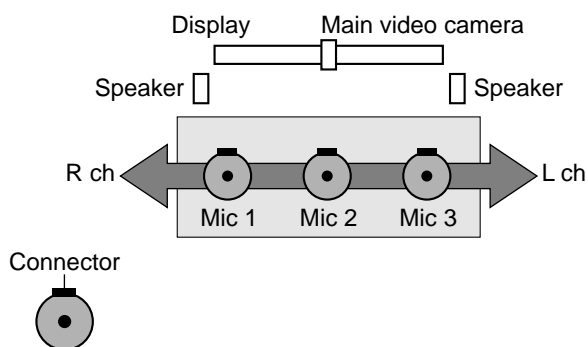

Mic 1: "Right side"  
 Mic 2: "Center Mono"  
 Mic 3: "Left side"

**When setting Boundary Microphones as follows:**

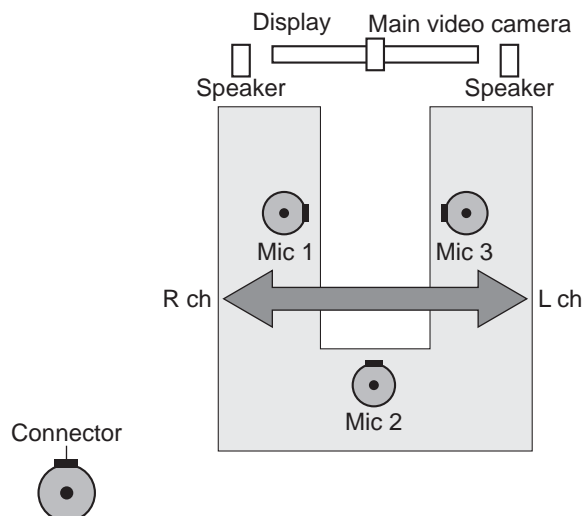

Mic 1: "Right side"  
 Mic 2: "Center Mono"  
 Mic 3: "Left side"

**Note**

- Make some noise near the Boundary Microphone. "▶" is displayed to indicate which Boundary Microphone picks up the noise.
- "▶" is not displayed when the Boundary Microphone is mute.
- "▶" is not displayed when multiple Boundary Microphones pick up the sound at the same time.
- "▶" might be displayed by pressing the Mic Mute button when the Boundary Microphone is mute.

8. Press **[G]**.
  - A dialog box to confirm the saving of settings is displayed.
9. Use **[◀][▶]** to select "Yes" and press **[Enter]**.
  - The system settings screen is displayed.
10. Press **[Home]**.
  - The Home screen is displayed.

**Note**

- Do not move Boundary Microphones after completing settings. Otherwise the settings will not match the location of the Boundary Microphone.

## Making Remote Control Settings

You can specify a remote control ID from 1, 2, or 3 for both the remote control and the KX-VC500. The KX-VC500 responds to signals from any remote control with the same remote control ID as itself. If you do not specify an ID, the KX-VC500 responds to signals from all remote controls. You can confirm the remote control ID for the KX-VC500 on the Home screen. (Page 25)

1. Press **[Menu]**.
  - The Menu screen is displayed.
2. Use **[▲][▼]** to select **"Settings"** and press **[Enter]**.
  - The system settings screen is displayed.
3. Press **[▶]**.
  - The next page is displayed.
4. Use **[▲][▼]** to select **"Remote Ctrl ID"** and press **[Enter]**.
  - The remote control settings screen is displayed.

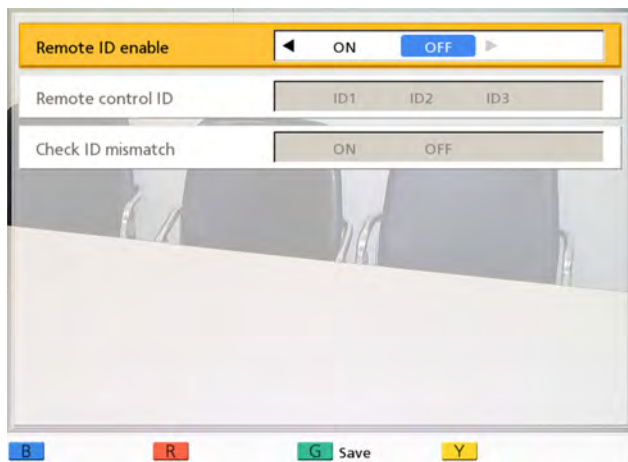

5. Use **[▲][▼]** to select the following items for input:
  - "Remote ID enable"**: Use **[◀][▶]** to select **"ON"** or **"OFF"** (default).
  - When **"ON"** is selected, you can set a specific remote control ID for the KX-VC500.
  - When **"OFF"** is selected, the KX-VC500 will respond to all remote controls.
  - "Remote control ID"**: Use **[◀][▶]** to select a remote control ID (**"ID1"** [default]/**"ID2"**/**"ID3"**) for the KX-VC500.
  - "Check ID mismatch"**: Use **[◀][▶]** to select **"ON"** (default) or **"OFF"**.

- When **"ON"** is selected, if the KX-VC500 receives a signal from a remote control that has an ID different from the one specified on the Home screen, a warning is displayed. Follow the procedures on the screen to change the remote control ID.
- When **"OFF"** is selected, even if the KX-VC500 receives a signal from a remote control that has an ID different from the one specified, no warning is displayed on the Home screen.

### Note

- If multiple remote controls with assigned IDs are being used close together, it is recommended that you select **"OFF"** for **"Check ID mismatch"**.

6. Press **[G]**.
  - A dialog box to confirm the saving of settings is displayed.
7. Use **[◀][▶]** to select **"Yes"** and press **[Enter]**.
8. When **"Remote ID enable" is set to "ON" (Page 68)**:  
The dialog box for changing the ID of the remote control is displayed. Proceed to step 9.

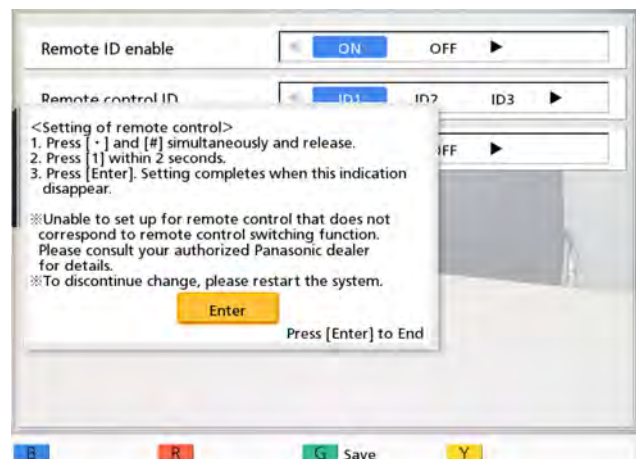

### Note

- While the dialog box is displayed, video conference calls cannot be received.

### When "Remote ID enable" is set to "OFF" (Page 68):

The system settings screen is displayed. Press **[Home]** to return to the Home screen.

9. Use the following procedure to change the ID of the remote control.

1. Press and hold [·] and [#] at the same time.
2. Within 2 seconds after you release the buttons, press the number (1 to 3) corresponding to the ID that you specified for "Remote control ID" in step 4.
  - 1: ID1
  - 2: ID2
  - 3: ID3

10. Press [Enter].

- The dialog box disappears and the remote control ID of the KX-VC500 will be saved.

**Note**

- If the dialog box does not disappear, repeat the procedure above, several times if necessary. If the dialog box still does not disappear, turn the power off and then back on to cancel the settings. For details, contact your dealer.

11. Press [Home].

- The Home screen is displayed.

## Performing a Network Test

You can confirm whether a network connection can be established with a particular IP address.

**Note**

- You cannot perform a network test from the contact list screen or the call history screen.
- You cannot refer to the contact list or the call history while you are entering an IP address.

1. Press [Menu].

- The Menu screen is displayed.

2. Use [▲][▼] to select "Settings" and press [Enter].

- The system settings screen is displayed.

3. Press [▶].

- The next page is displayed.

4. Use [▲][▼] to select "Network Test" and press [Enter].

- The network test screen is displayed.

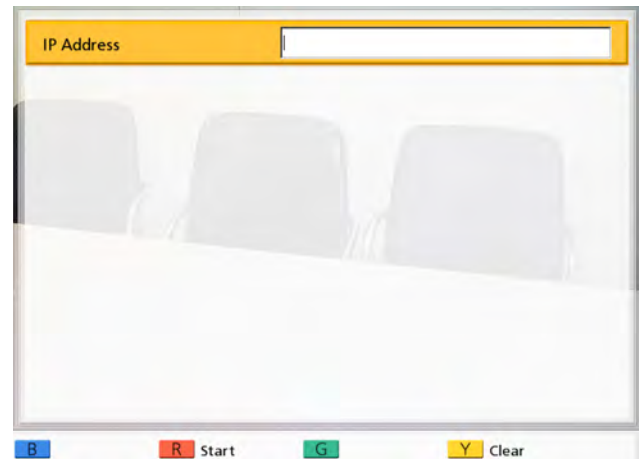

5. Enter an IP address.

- If the IP address contains 1 or 2 digit numbers, enter these numbers as they are. Do not enter like [.001].  
Example: The IP address is [192.168.0.1].
  - Correct entry: [192.168.0.1]
  - Incorrect entry: [192.168.000.001]

6. Press [R].

- The network test starts. After the network test is finished, if the network test was successful or timed out, the details of the results are displayed. If the network test failed, a message indicating the failure is displayed.

7. Press [Home].

- The Home screen is displayed.

## Performing Self Diagnosis

You can check how your image will be displayed and how your voice will be heard to the other party before starting a video conference call, using your own display and speakers.

1. Press [Menu].

- The Menu screen is displayed.

2. Use [▲][▼] to select "Settings" and press [Enter].

- The system settings screen is displayed.

3. Press [**▶**].
  - The next page is displayed.
4. Use [**▲**][**▼**] to select "**Self Diag.**" and press [**Enter**].
  - The self diagnosis screen is displayed with the dialog box.

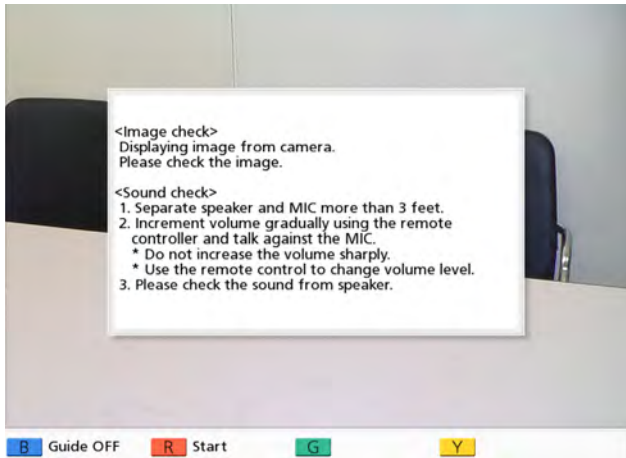

**Note**

- You can hide or display the dialog box by pressing [**B**].
- Set the microphone at least 1 m (3.3 ft) away from the speakers.

5. Press [**R**].
  - The self diagnosis starts.

**Note**

- Check the image that is displayed from the main video camera.
- To avoid feedback, slowly raise the volume using the remote control's [**+**] button.
- When someone speaks into the microphone, confirm whether the sound plays back through the speakers.
- During self diagnosis, all Boundary Microphones will be set to "**Center stereo**".
- During self diagnosis, the tone will be set to "**Standard**".

6. Press [**R**].
  - The self diagnosis ends.

**Note**

- If you do not press [**R**], the self diagnosis will automatically end after about 10 minutes.

7. Press [**Home**].
  - The Home screen is displayed.

## Performing Remote Maintenance

The following operation is for performing remote maintenance by your dealer. After performing the operation, you cannot use the KX-VC500 until remote maintenance is finished. However, turning the power off and then back on cancels remote maintenance, and you can use the KX-VC500. For details, contact your dealer.

1. Press [**Menu**].
  - The Menu screen is displayed.
2. Use [**▲**][**▼**] to select "**Settings**" and press [**Enter**].
  - The system settings screen is displayed.
3. Press [**▶**] twice.
  - The third page is displayed.
4. Use [**▲**][**▼**] to select "**Remote access**" and press [**Enter**].
  - The dialog box to confirm the start of remote maintenance is displayed.
5. Use [**◀**][**▶**] to select "**Yes**" and press [**Enter**].
  - The remote maintenance screen is displayed.

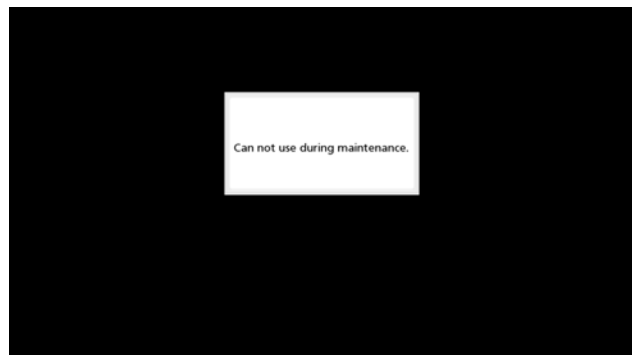

# Making Administrator Menu Settings

## Note

- If a video conference call is received while data is being entered, data entry is interrupted and any unsaved data is lost.

## Logging in to the Administrator Menu

1. Press **[Menu]**.
  - The Menu screen is displayed.
2. Use **[▲][▼]** to select **"Settings"** and press **[Enter]**.
  - The system settings screen is displayed.
3. Press **[▶]** twice.
  - The third page is displayed.
4. Use **[▲][▼]** to select **"Admin login"** and press **[Enter]**.
  - The login screen is displayed.

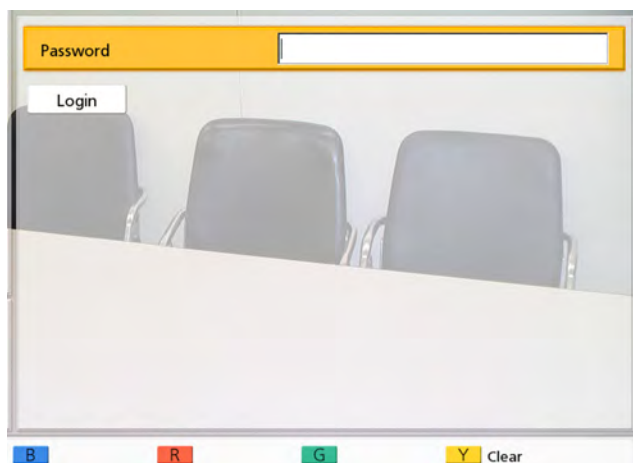

5. Use **[▲][▼]** to select **"Password"**, then enter the administrator password (4–10 digits).

## Note

- Please enter the administrator password that was set during installation.
- If you forget the administrator password, please contact your dealer.

6. Use **[▲][▼]** to select **"Login"** and press **[Enter]**.
  - The admin menu screen is displayed.

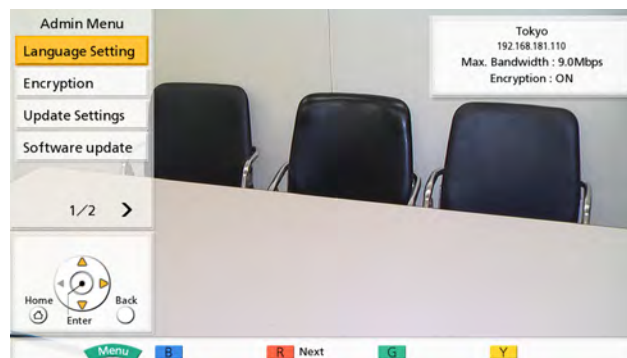

## Making Language Settings

1. Login to the administrator menu. (Page 71)
  - The admin menu screen is displayed.
2. Use **[▲][▼]** to select **"Language Setting"** and press **[Enter]**.
  - The language settings screen is displayed.

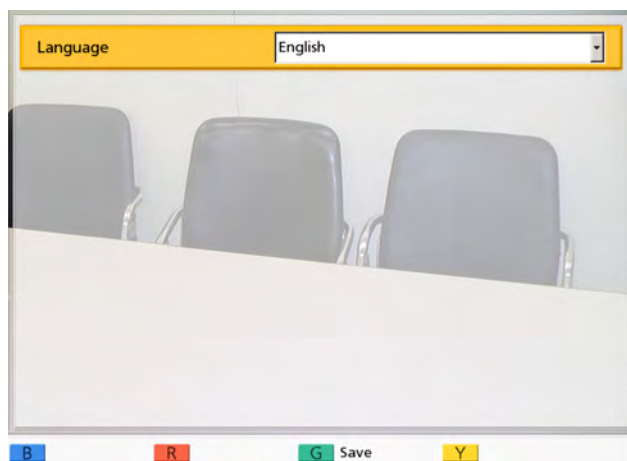

3. Press **[Enter]** and use **[▲][▼]** to select the desired language (**English** [default], **Français**, **Español**).
4. Press **[Enter]**.
5. Press **[G]**.
  - A dialog box to confirm the saving of settings is displayed.

6. Use [**◀**][**▶**] to select **"Yes"** and press [**Enter**].
  - The admin menu screen is displayed in the selected language.
7. Press [**Home**].
  - The Home screen is displayed.

## Making Encryption Settings

### Note

- Take care when changing encryption settings because doing so may cause you to become unable to communicate with other parties.
  - There is a danger that encryption settings will be changed by a third party. Therefore, be careful when managing the administrator password and giving users the authority to change encryption settings.
  - If an encryption password is not set, you cannot make encryption settings. For details, contact your dealer.
  - Be aware that if encryption is disabled, eavesdropping might be possible on networks that are not secured against such actions.
1. Login to the administrator menu. (Page 71)
    - The admin menu screen is displayed.
  2. Use [**▲**][**▼**] to select **"Encryption"** and press [**Enter**].
    - The encryption settings screen is displayed.

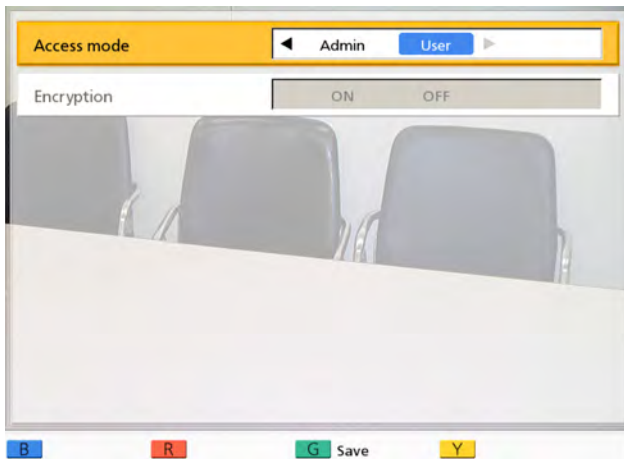

3. Use [**▲**][**▼**] to select the following items for input:
  - "Access mode"**: Use [**◀**][**▶**] to select **"Admin"** (default) or **"User"**.

- When **"Admin"** is selected, only the network administrator can change the encryption setting.
- When **"User"** is selected, any users can change the encryption setting. (Page 64)

**"Encryption"**: Use [**◀**][**▶**] to select whether to enable encryption.

- **"ON"**: Encryption is enabled.
- **"OFF"** (default): Encryption is disabled.

### Note

- If the **"Encryption"** setting does not match that of the other party in a video conference call, the video conference call will not start.
- This setting is available only when **"Admin"** is selected for **"Access mode"**.

4. Press [**G**].
  - A dialog box to confirm the saving of settings is displayed.
5. Use [**◀**][**▶**] to select **"Yes"** and press [**Enter**].
  - The admin menu screen is displayed.
6. Press [**Home**].
  - The Home screen is displayed.

## Making Software Update Settings

1. Login to the administrator menu. (Page 71)
  - The admin menu screen is displayed.



- Use [▲][▼] to select **"Update Settings"** and press [Enter].
  - The update settings screen is displayed.

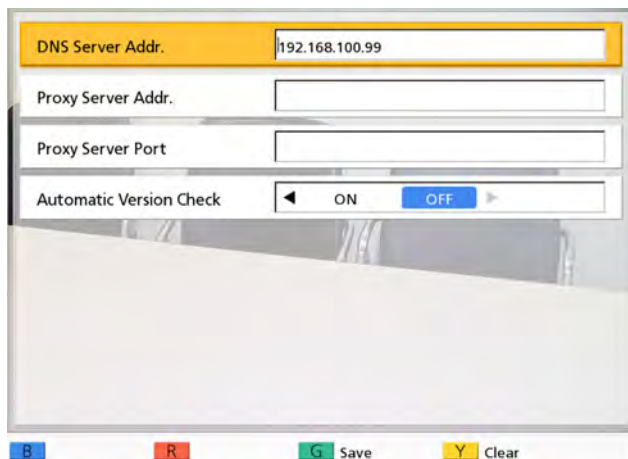

- Use [▲][▼] to select the following items for input: **"DNS Server Addr."**: Enter the IP address of the DNS server.

- If the IP address contains 1 or 2 digit numbers, enter these numbers as they are. Do not enter like [.001].

Example: The IP address is [192.168.0.1].

- Correct entry: [192.168.0.1]
- Wrong entry: [192.168.000.001]

**"Proxy Server Addr."**: Enter the IP address of the proxy server.

- If the IP address contains 1 or 2 digit numbers, enter these numbers as they are. Do not enter like [.001].

Example: The IP address is [192.168.0.1].

- Correct entry: [192.168.0.1]
- Wrong entry: [192.168.000.001]

**"Proxy Server Port"**: Enter the proxy server port number (1–65535).

**"Automatic Version Check"**: Use [◀][▶] to select **"ON"** or **"OFF"** (default).

- When **"ON"** is selected, the KX-VC500 will automatically look up the DNS server or proxy server to see if there are updates for your software on start-up. If updates are available, a dialog box is displayed on the Home screen.
- When **"OFF"** is selected, the KX-VC500 will not automatically look up the DNS server or proxy server to see if there are updates for your software on start-up.

- Press [G].
  - A dialog box to confirm the saving of settings is displayed.
- Use [◀][▶] to select **"Yes"** and press [Enter].
  - The admin menu screen is displayed.
- Press [Home].
  - The Home screen is displayed.

## Updating Software

- Login to the administrator menu. (Page 71)
  - The admin menu screen is displayed.
- Use [▲][▼] to select **"Software update"** and press [Enter].
  - The software update screen is displayed.

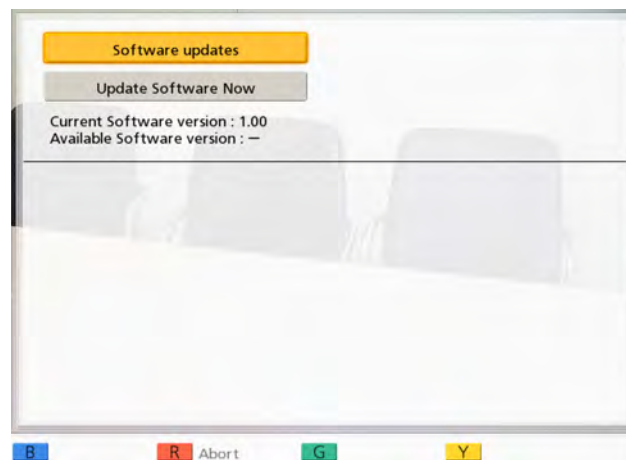

- When **"Automatic Version Check"** is set to **"ON"** (Page 73):
 

The latest software version is displayed next to **"Available Software version :"**. Proceed to step 4 if there is an update available.

**When "Automatic Version Check" is set to "OFF" (Page 73):**

Use [▲][▼] to select **"Software updates"** and press [Enter].

  - The system checks for version updates. The latest software version will be displayed next to **"Available Software version :"**. Proceed to step 4 if there is an update available.

4. Use [▲][▼] to select "Update Software Now" and press [Enter].
  - A dialog box to confirm the updating of your software is displayed.

**Note**

- Please carefully read and confirm the cautions in the dialog box before proceeding to the next step.

5. Use [◀][▶] to select "Yes" and press [Enter].
  - The update is automatically downloaded and installed.
  - To complete the update, the system will automatically restart twice. Before each restart, a message will be displayed as detailed below.

**The message displayed before the first restart**



**The message displayed before the second restart**

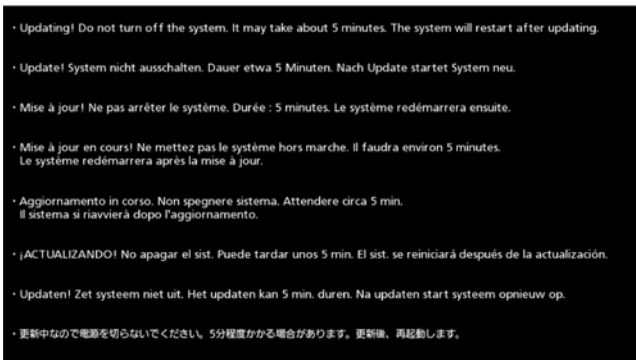

After the second restart, the system will start up with the latest software.

**Note**

- Contact your dealer for more information on obtaining the latest firmware and Operating Manual.
- If the checking, downloading, or installing of a software update fails, an error message is displayed. Press [Enter] to restart the system.  
Please try the following:
  - a. Check that the DNS server's IP address or the proxy server's IP address and proxy port are correct, and then try updating the software again.
  - b. If the above step is unsuccessful, try updating the software again later. The network may be currently very busy.
 If the retry fails several times, there might be a problem with your communication lines. Please contact your dealer.

## Making Screen Standby Settings

When the KX-VC500 or remote control are not operated or a video conference call is not received for a specified length of time, the KX-VC500 enters standby mode. You can set the length of time here.

1. Login to the administrator menu. (Page 71)
  - The admin menu screen is displayed.
2. Press [▶].
  - The next page is displayed.

- Use [▲][▼] to select "Standby Setting" and press [Enter].
  - The screen standby settings screen is displayed.

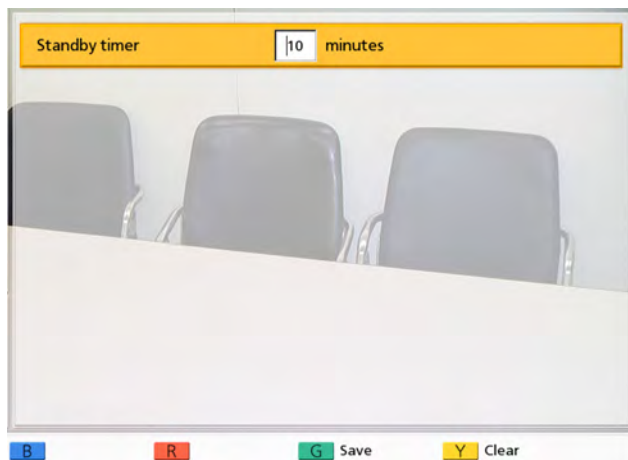

- Enter the length of time (0–99) in minutes until the KX-VC500 enters screen standby mode (default: 10).

**Note**

- If you set "0", the KX-VC500 does not enter screen standby mode. However, if you press the remote control's [Video Out On/Off] button, the KX-VC500 enters screen standby mode even if "0" is set.

- Press [G].
  - A dialog box to confirm the saving of settings is displayed.
- Use [◀][▶] to select "Yes" and press [Enter].
  - The admin menu screen is displayed.
- Press [Home].
  - The Home screen is displayed.

## Making Administrator Password Settings

- Login to the administrator menu. (Page 71)
  - The admin menu screen is displayed.
- Press [▶].
  - The next page is displayed.

- Use [▲][▼] to select "Password Settings" and press [Enter].
  - The password settings screen is displayed.

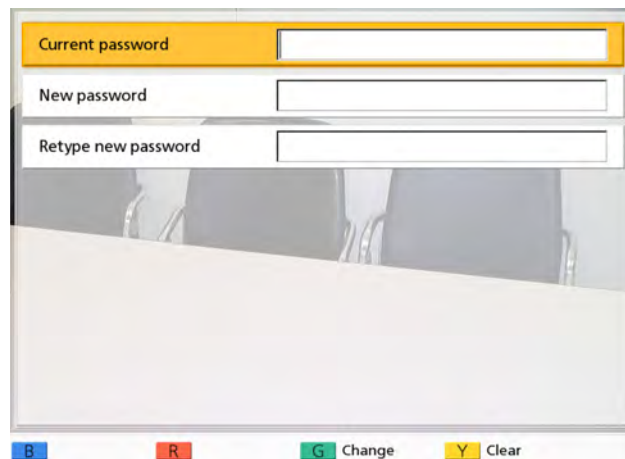

- Use [▲][▼] to select the following items and enter a password (4–10 digits):
  - "Current password": Enter the current password (default: 00000000).
  - "New password": Enter the new password.
  - "Retype new password": Enter the new password again.

**Note**

- Please change the default login password the first time the KX-VC500 is installed.
- Be sure to keep the password safe.

- Press [G].
  - A dialog box to confirm the changing of settings is displayed.
- Use [◀][▶] to select "Yes" and press [Enter].
  - The admin menu screen is displayed.
- Press [Home].
  - The Home screen is displayed.

## Performing System Initialization

- Login to the administrator menu. (Page 71)
  - The admin menu screen is displayed.
- Press [▶].
  - The next page is displayed.

3. Use [▲][▼] to select "System Initialize" and press [Enter].
  - A dialog box to confirm the start of system initialization is displayed.

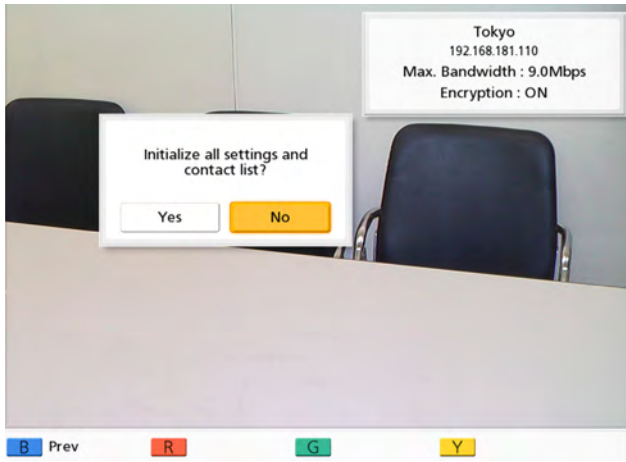

4. Use [◀][▶] to select "Yes" and press [Enter].
  - The system will automatically restart to complete the system initialization.

**Note**

- After initialization, all system settings previously made and information stored in the contact list and call history are cleared.

## Making Local Site Settings

You can register up to 5 temporary local sites. One KX-VC500 can be used in multiple meeting rooms without the need to change certain basic network settings.

### Registering a Local Site

1. Press [Menu].
  - The Menu screen is displayed.
2. Use [▲][▼] to select "Select local site" and press [Enter].
  - The select local site screen is displayed.
3. Use [▲][▼] to select "Not Registered" and press [B].
  - The local site settings screen is displayed.

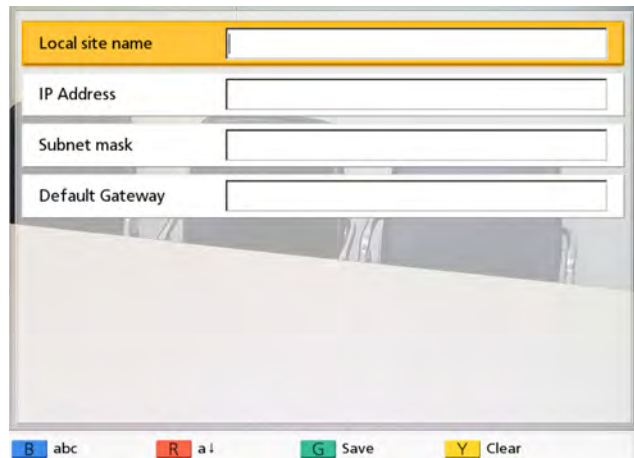

4. Use [▲][▼] to select the following items for input:
  - "Local site name": Enter a name for the local site.
  - "IP Address": Enter an IP address.
    - If the IP address contains 1 or 2 digit numbers, enter these numbers as they are. Do not enter like [.001].
    - Example: The IP address is [192.168.0.1].
      - Correct entry: [192.168.0.1]
      - Wrong entry: [192.168.000.001]
  - "Subnet mask": Enter the subnet mask.
  - "Default Gateway": Enter the IP address of the default gateway.

5. Press **[G]**.
  - A dialog box to confirm the saving of settings is displayed.
6. Use **[◀][▶]** to select **"Yes"** and press **[Enter]**.
  - The select local site screen is displayed.
7. Press **[Home]**.
  - The Home screen is displayed.

## Selecting a Local Site

1. Press **[Menu]**.
  - The Menu screen is displayed.
2. Use **[▲][▼]** to select **"Select local site"** and press **[Enter]**.
  - The select local site screen is displayed.



3. Use **[▲][▼]** to select the local site you want to use.

### Note

- For the currently selected local site, **"→"** is displayed in **"Selected"**.
- **"Not Registered"** is displayed for sites that have not been registered.

4. Press **[G]**.
  - A dialog box to confirm the saving of settings is displayed.
5. Use **[◀][▶]** to select **"Yes"** and press **[Enter]**.
  - The Home screen is displayed.

### Note

- When you select a local site, the name entered in **"Local site name"** is displayed instead of the unit name in the unit information.
- If you turn the power off and then back on, the local site is returned to the default site.
- To return to the default site, turn off the power and then turn it back on, or use the following procedure:
  1. Repeat steps 1–2.
  2. Use **[◀][▶]** to select the currently selected local site.
  3. Press **[Y]**.
    - A dialog box to confirm whether you want to return to the default site is displayed.
  4. Use **[◀][▶]** to select **"Yes"** and press **[Enter]**.
    - The Home screen is displayed.

## Editing Local Site Information

1. Press **[Menu]**.
  - The Menu screen is displayed.
2. Use **[▲][▼]** to select **"Select local site"** and press **[Enter]**.
  - The select local site screen is displayed.
3. Use **[▲][▼]** to select the local site you want to edit.
4. Press **[B]**.
  - The local site edit screen is displayed.

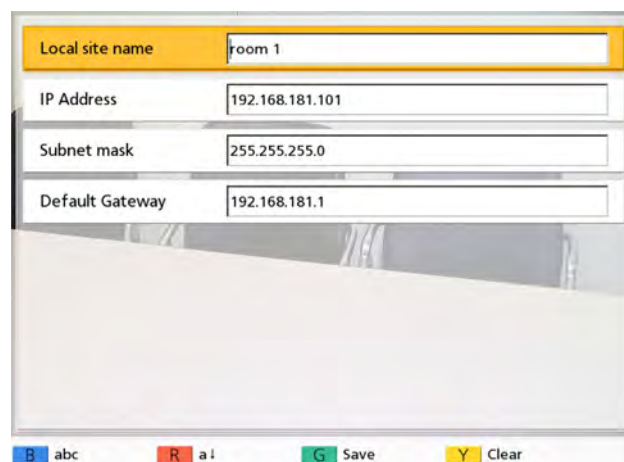

5. Use [**▲**][**▼**] to select the item you want to edit, and then make any changes.
6. Press [**G**].
  - A dialog box to confirm the saving of settings is displayed.
7. Use [**◀**][**▶**] to select "Yes" and press [**Enter**].
  - The select local site screen is displayed.
8. Press [**Home**].
  - The Home screen is displayed.

## Deleting Local Site Information

1. Press [**Menu**].
  - The Menu screen is displayed.
2. Use [**▲**][**▼**] to select "Select local site" and press [**Enter**].
  - The select local site screen is displayed.



Selected	Local site name	IP Address
	room 1	192.168.181.101
	room 2	192.168.181.102
	room 3	192.168.181.103
	*Not Registered*	
	*Not Registered*	

Buttons: Edit, Delete, Set, Release

3. Use [**▲**][**▼**] to select the local site you want to delete.
4. Press [**R**].
  - A dialog box to confirm deletion is displayed.
5. Use [**◀**][**▶**] to select "Yes" and press [**Enter**].
  - The select local site screen is displayed.
6. Press [**Home**].
  - The Home screen is displayed.

---

## Inputting Letters and Numbers

You can use the remote control to input letters and numbers.

The following tables detail the characters and numbers that can be input. The language that can be input depends on which language is selected through system settings.

Press the indicated button repeatedly to cycle through the characters and numbers assigned to that button until the character you want to input is displayed. If you want to input another character using the same button, press [▶] to move the input cursor to the right.

Table 1 English

Button	Letter Mode		Number Mode	Extended Character 1 (Western Europe) Mode		Extended Character 2 (Eastern Europe) Mode	
	Uppercase -preferred Mode	Lowercase -preferred Mode		Uppercase -preferred Mode	Lowercase -preferred Mode	Uppercase -preferred Mode	Lowercase -preferred Mode
<b>1</b>	1	1	1	1	1	1	1
<b>2</b> <sub>ABC</sub>	ABCabc2	abcABC2	2	AÀÁÂÃÄÅ ÆBCÇaàá âãäåæbcç 2	aàáâãäåæ bcçAÀÁÂ ÃÄÅÆBC Ç2	AÁÂABCĆ Čaáâabcć č2	aáâabcćč AÁÂABCĆ Č2
<b>3</b> <sub>DEF</sub>	DEFdef 3	defDEF3	3	DEÉÊËËF deèéêëf3	deèéêëfD EÉÊËËF3	DĎEĚĚĚF dďeěěěf3	dďeěěěfD ĎĚĚĚĚF3
<b>4</b> <sub>GHI</sub>	GHIghi4	ghiGHI4	4	GĜHIİİİİİ ĩgĝhiııııı 4	gĝhiııııı ĨĜHIİİİİİ 4	GHIÍghií4	ghiíGHIÍ4
<b>5</b> <sub>JKL</sub>	JKLjkl5	klIJKL5	5	JKLjkl5	jkIJKL5	JKLÍĹĹjkl ÍĹ5	klÍĹJKLÍ ĹĹ5
<b>6</b> <sub>MNO</sub>	MNOmno6	mnoMNO6	6	MNÑOOÓ ÔÕÖØŒ mnñooóô õöøœ6	mnñooóôõ öøœMNÑ OÓÓÕÕÖ ØŒ6	MNÑŃOO ÓŎmnńño óóó6	mnńñoóóõ MNÑŃOO ÓŎ6
<b>7</b> <sub>PQRS</sub>	PQRSpqr s7	pqrsPQR S7	7	PQRSSŞp qrssş7	pqrsşşP QRSŞŞ7	PQRŘŘŚŚ Špqrřřśś 7	pqrřřśśšP QRRŘRSŠŠ 7
<b>8</b> <sub>TUV</sub>	TUVtuv8	tuvTUV8	8	TUÚÚŮŮŮ VtuúúúŮ v8	tuúúúúŮ TUÚÚŮŮŮ V8	TŤUÚÚŮŮ ŤtuúúúŮŮ 8	ttúúúúŮŮ TŤUÚŮŮŮŮV 8
<b>9</b> <sub>WXYZ</sub>	WXYZwxyz z9	wxyzWXY Z9	9	WŴXIJYŶ Zwŵxijyŷ z9	wŵxijyŷ WŴXIJYŶ Z9	WXŸŸŸZŽ ŽŽwxyŷŷ zžž9	wxyŷŷžžž WXŸŸŸZŽ ŽŽ9
<b>0</b> _	0 Space	0 Space	0	0 Space	0 Space	0 Space	0 Space
<b>.</b> @ * &	. @ ; ; " = + < >	. @ ; ; " = + < >	. @ ; ; " = + < >	. @ ; ; " = + < >	. @ ; ; " = + < >	. @ ; ; " = + < >	. @ ; ; " = + < >
<b>#</b>	# _ - & \$ \% ~ ^ ! ? / ` ( ) , [ ] {   } ' &	# _ - & \$ \% ~ ^ ! ? / ` ( ) , [ ] {   } ' &	# _ - & \$ \% ~ ^ ! ? / ` ( ) , [ ] {   } ' &	# _ - & \$ \% ~ ^ ! ? / ` ( ) , [ ] {   } ' &	# _ - & \$ \% ~ ^ ! ? / ` ( ) , [ ] {   } ' &	# _ - & \$ \% ~ ^ ! ? / ` ( ) , [ ] {   } ' &	# _ - & \$ \% ~ ^ ! ? / ` ( ) , [ ] {   } ' &





Table 3 Spanish

Button	Letter Mode		Number Mode	Extended Character 1 (Western Europe) Mode		Extended Character 2 (Eastern Europe) Mode	
	Uppercase -preferred Mode	Lowercase -preferred Mode		Uppercase -preferred Mode	Lowercase -preferred Mode	Uppercase -preferred Mode	Lowercase -preferred Mode
<b>1</b>	1	1	1	1	1	1	1
<b>2<sup>ABC</sup></b>	AÁBCaáb c2	aábcAÁB C2	2	AÀÁÂÃÄÅ ÆBCÇaàá âãäåæbcç 2	aàáâãäåæ bcçAÀÁÂ ÃÄÅÆBC Ç2	AÁÄABCĆ Čaáäabcć č2	aáäabcć AÁÄABCĆ Č2
<b>3<sup>DEF</sup></b>	DEÉFdeé f3	deéfDEÉ F3	3	DEÉÊËËF deèéêëf3	deèéêëfD EÉÊËËF3	DĎEÉĚËF dďeéěěf3	dďeéěěfD ĎEÉĚËF3
<b>4<sup>GHI</sup></b>	GHIíghií4	ghiíGHIÍ4	4	GĜHIİİİİİ İğğhiııııı 4	gĝhiıııııı GĜHIİİİİİ 4	GHIíghií4	ghiíGHIÍ4
<b>5<sup>J<sub>KL</sub>°</sup></b>	JKLjkl5	jkIJKL5	5	JKLjkl5	jkIJKL5	JKLŁŁłjkl Íł5	jkIłłJKLŁ Łł5
<b>6<sup>MNO</sup></b>	MNÑOÓm nñoó6	mnñoóMN ÑOÓ6	6	MNÑOÓ ÔÕÖØŒ mnñoóòô õöøœ6	mnñoóòôõ öøœMNÑ OÕÖŒ ØŒ6	MNÑŃOÓ ŎŎmnňňo óóó6	mnňňoóóõ MNÑŃOÓ ŎŎ6
<b>7<sup>P<sub>QRS</sub></sup></b>	PQRSpqr s7	pqrsPQR S7	7	PQRSŞşp qrsşşP QRSŞş7	pqrsşşP QRSŞş7	PQRŔŖŖŞŞ Şpqrŕŕşşş 7	pqrŕŕşşşP QRŔŖŖŞŞŞ 7
<b>8<sup>TUV</sup></b>	TUÚÜVtu úüv8	tuúüvTUÚ ÜV8	8	TUÚÚÚÚÚ Vtuúúúúú v8	tuúúúúúv TUÚÚÚÚÚ V8	TŤUÚÚÚÚ Vtťuúúúúv 8	ttúúúúúvT ŤUÚÚÚÚV 8
<b>9<sup>W<sub>XYZ</sub></sup></b>	WXYZwxy z9	wxyzWXY Z9	9	WŴXIJYŶ Zwŵxijyŷz 9	wŵxijyŷz WŴXIJYŶ Z9	WXYŶŶZZ ŽŽwxyŷz žžž9	wxyŷzžžž WXYŶŶZZ ŽŽ9
<b>0 _</b>	0 Space	0 Space	0	0 Space	0 Space	0 Space	0 Space
<b>•<sup>@*</sup></b>	.@:;"+*+ <>	.@:;"+*+ <>	.@:;"+*+ <>	.@:;"+*+ <>	.@:;"+*+ <>	.@:;"+*+ <>	.@:;"+*+ <>
<b>#</b>	#_&\$\% ~^!?/\`(), []{}'`	#_&\$\% ~^!?/\`(), []{}'`	#_&\$\% ~^!?/\`(), []{}'`	#_&\$\% ~^!?/\`(), []{}'`	#_&\$\% ~^!?/\`(), []{}'`	#_&\$\% ~^!?/\`(), []{}'`	#_&\$\% ~^!?/\`(), []{}'`

## Switching the Input Mode

Each time **[B]** or **[R]** is pressed, the input mode will be switched in the following cycle:

- **[B]**: letter mode → number mode → extended character 1 mode → extended character 2 mode
- **[R]**: lowercase-preferred mode → uppercase-preferred mode

The current input mode is displayed in the guide area.

**Example: letter mode and lowercase-preferred mode currently selected**

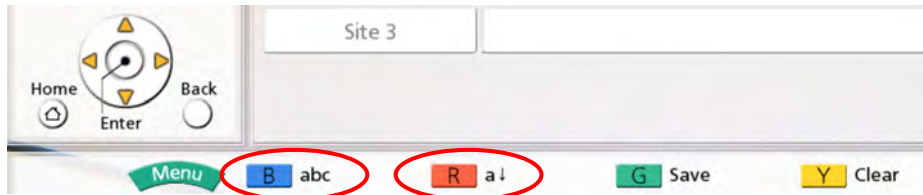

## Deleting an Input Character

Press **[Y]** to delete an input character. The character deleted depends on the position of the cursor:

- If the cursor is to the right of the last character in the line, the last character will be deleted.
- If the cursor is within a line of characters, the character to the right of the cursor will be deleted.

## Inserting Characters

Use **[◀]****[▶]** to move the cursor to the position where you want to insert characters, and then begin input. The characters will be inserted at the location of the cursor.

## Changing the Remote Control Batteries

1. Open the cover.

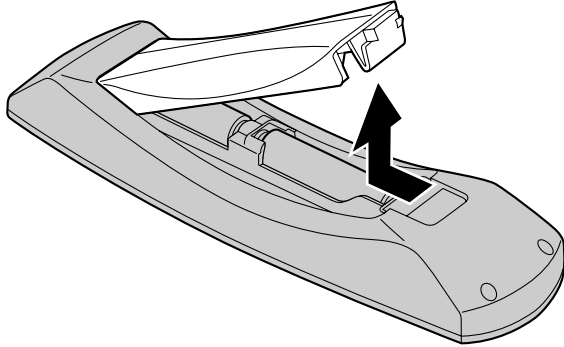

2. Take out the AA batteries.
3. Insert new batteries (AA dry cell), minus side first, then close the cover.

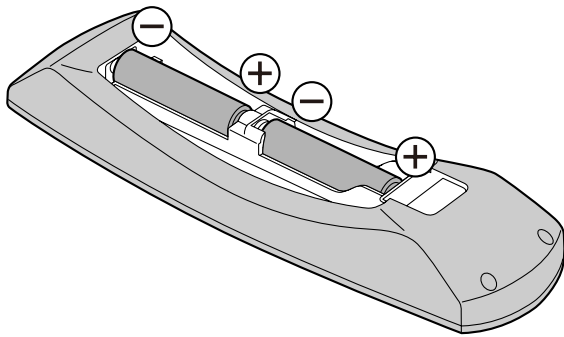

## Cleaning the Unit

When cleaning the unit, make sure the power is off and all cables are unplugged. Cleaning the unit while the power is on may cause a malfunction.

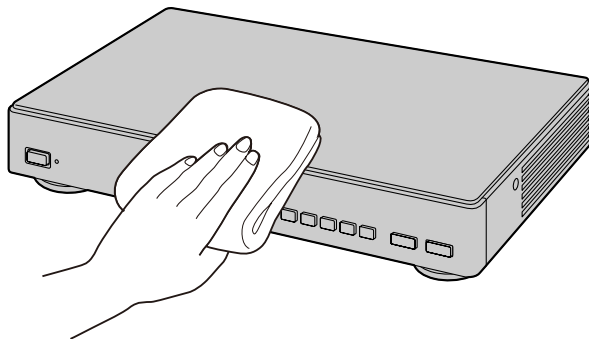

- Wipe the unit with a dry, soft cloth.  
When the unit is very dirty, first clean it with a neutral, household cleaning agent using a well-wrung, damp cloth. Then, wipe down the unit with a dry, soft cloth.
- Do not use the following when cleaning the unit. They may cause unit discoloration or damage.
  - Petroleum
  - Scouring powder
  - Alcohol
  - Thinner
  - Benzene
  - Wax
  - Hot water
  - Powder soap
- If using a chemically treated cleaning cloth, be sure to follow all accompanying directions and warnings.

# Troubleshooting

If a problem is occurring with the operation of the device, check here for possible solutions. Before proceeding check all connections to make sure they are secure, and that power is flowing from the outlet that the KX-VC500 is plugged into.

## Basic Operation

Problem	Cause and Solution
The power does not turn on.	<ul style="list-style-type: none"> <li>• The power cord is not plugged into the outlet.</li> <li>→ Plug the power cord into the outlet.</li> </ul>
There is no display.	<ul style="list-style-type: none"> <li>• A cable or cord is not properly connected.</li> <li>→ Check that all cables to the KX-VC500 are connected properly. (Page 15) Perform self diagnosis, and check the performance of the video camera and the display that are connected to the KX-VC500. (Page 69)</li> <li>• The main video camera is not turned on.</li> <li>→ Turn on the main video camera.</li> <li>• The display is not turned on, or the input that the KX-VC500 is connected to is not selected.</li> <li>→ Turn on the display, and select the input that the KX-VC500 is connected to.</li> <li>• The KX-VC500 is in screen standby mode.</li> <li>→ Pushing a button on the KX-VC500 or the remote control, or receiving a video conference call will end standby mode and the display will return.</li> </ul> <p><b>Note</b></p> <ul style="list-style-type: none"> <li>• The network administrator can set the length of time until the KX-VC500 enters screen standby mode. (Page 74)</li> <li>• When connecting a device equipped with HDCP (High-bandwidth Digital Content Protection) using an HDMI cable, only a blue or blue/black screen may be displayed.</li> </ul> <li>→ Do not connect a device using HDCP with an HDMI cable.</li>
The area at the edges of the screen is not displaying properly.	<ul style="list-style-type: none"> <li>• In <b>Layout 1</b> during a 3-party video conference call, the left and right edges of the image are trimmed. (Page 40)</li> <li>• In <b>Layout 2</b> during a 4-party video conference call, the edges of the image are trimmed and only the center of the image is displayed. (Page 42)</li> <li>• The display is not set to show the full image.</li> <li>→ Set the display to show images at full screen.</li> </ul>
Operation is unresponsive or incorrect.	<ul style="list-style-type: none"> <li>• Cables or cords may not be connected properly.</li> <li>→ Check that all cables to the KX-VC500 are connected properly. (Page 15)</li> <li>• An error has occurred.</li> <li>→ Turn off the KX-VC500 and restart it.</li> <li>• There may be a problem with your communication lines.</li> <li>→ Contact your dealer.</li> </ul>

Problem	Cause and Solution
<p>The remote control is unresponsive.</p>	<ul style="list-style-type: none"> <li>• The batteries are depleted. → Replace with new batteries.</li> <li>• The remote control is being used out of the signal reception range. → Make sure to use the remote control within the signal reception range. (Page 14)</li> <li>• The remote control ID differs between the KX-VC500 and the remote control. → Change the settings so that the remote control ID of the KX-VC500 and the remote control match. Perform the following procedure:               <ol style="list-style-type: none"> <li><b>1.</b> Press <b>[Home]</b> on the KX-VC500.                   <ul style="list-style-type: none"> <li>• The Home screen is displayed. Check the remote control ID of the KX-VC500. (Page 25)</li> </ul> </li> </ol> <p><b>Note</b></p> <ul style="list-style-type: none"> <li>• If the remote control ID is not displayed on the Home screen, contact your dealer.</li> </ul> </li> <li><b>2.</b> Press and hold <b>[.]</b> and <b>[#]</b> at the same time.</li> <li><b>3.</b> Within 2 seconds after you release the buttons, press the number <b>(1 to 3)</b> corresponding to the ID displayed on the Home screen.</li> <p><b>Note</b></p> <ul style="list-style-type: none"> <li>• If the remote control is still unresponsive after performing the procedure above, contact your dealer.</li> </ul> </ul>
<p>Cannot connect with another party.</p>	<ul style="list-style-type: none"> <li>• The LAN cable is not connected properly. → Check that it is connected to the KX-VC500 properly. (Page 15) Perform a network test by entering the IP address of the other party, and then confirm the connection to the other party. (Page 69)</li> <li>• The local site settings are incorrect. → Confirm the local site settings. Specify the settings that are appropriate for your usage environment. (Page 76)</li> <li>• The IP address is not entered correctly. → Confirm that the other party's IP address is correctly entered.</li> <li>• The internet connection is not established. → Some hubs, routers, etc. can take 10 seconds or more to establish an internet connection.</li> <li>• Your software version does not match that of the other party in a video conference call. → Contact your dealer.</li> <li>• There may be a problem with your communication lines. → Contact your dealer.</li> </ul>

Problem	Cause and Solution
<p>The image is distorted.</p>	<ul style="list-style-type: none"> <li>• Your hub or router may have different settings than those of the KX-VC500.</li> <li>→ Contact your dealer.</li> <li>• Packet loss is occurring. (The network is congested.)</li> <li>→ Check the display of the network status indication. (Page 27) If it is displayed frequently, press <b>[Status]</b> twice and check the fields <b>"Loss"</b> and <b>"Bandwidth"</b>, then contact your network administrator or dealer. (Page 57)</li> <li>• There is not enough bandwidth.</li> <li>→ During a 4-party video conference call, at least 1.5 Mbps of bandwidth is required. Change the <b>"Max. Bandwidth"</b> setting to a value of <b>"2.0Mbps"</b> or higher. (Page 63)</li> <li>• There may be a problem with your communication lines.</li> <li>→ Contact your dealer.</li> </ul>
<p>The maximum bandwidth changes during a video conference call.</p>	<ul style="list-style-type: none"> <li>• The maximum bandwidth during a video conference call adjusts to that of the party that has set the lowest bandwidth for the maximum bandwidth setting among all participating parties.</li> <li>→ If there is a problem with your communication lines, contact your dealer.</li> </ul>
<p>The computer or sub video camera's video is not displayed.</p>	<ul style="list-style-type: none"> <li>• Cables or cords may not be connected properly.</li> <li>→ Make sure all connections to the KX-VC500 are correct. (Page 49, Page 52) On the Home screen, press <b>[PC]</b> or <b>[Camera Sub]</b> and then check the computer's screen or sub video camera's image. (Page 50, Page 53)</li> <li>• The computer's display resolution or refresh rate is incompatible with the KX-VC500.</li> <li>→ Set your computer's resolution and refresh rate to a setting compatible with the KX-VC500. (Page 50)</li> </ul>
<p>It takes a long time to display a clear image when displaying a still image from the sub video camera.</p>	<ul style="list-style-type: none"> <li>• Sending a still image requires time. Packet loss is occurring.</li> <li>→ Change the <b>"Still image quality"</b> setting to <b>"HD"</b>. (Page 64)</li> </ul>



## Audio

Problem	Cause and Solution
The other party cannot hear your voice.	<ul style="list-style-type: none"> <li>• The microphone cable is not properly connected. → Check that the microphone is properly connected to the KX-VC500. (Page 15) Perform self diagnosis, and check the performance of the microphones that are connected to the KX-VC500. (Page 69)</li> <li>• The microphone is muted. → Press <b>[MIC Mute]</b> on the remote control, or press the MIC Mute button on the Boundary Microphone to unmute the microphone. (Page 46)</li> <li>• <b>"Default MIC Mute set"</b> is set to <b>"ON"</b>. → The microphones are muted at the start of a received video conference call. Confirm the settings. (Page 64)</li> <li>• The microphone is being obstructed. → During the video conference call, do not block the microphone with your hand or other object.</li> <li>• You are too far from a microphone. → Speak close to a microphone.</li> <li>• More than 5 Boundary Microphones are connected in cascade. → Connect no more than 4 Boundary Microphones at a time.</li> <li>• There may be a problem with your communication lines. → Contact your dealer.</li> </ul>
The sound cuts out.	<ul style="list-style-type: none"> <li>• You are too far from a microphone. → Speak close to a microphone.</li> <li>• The microphone or KX-VC500 is being moved during a video conference call. → Do not move the KX-VC500 or the microphone during a video conference call.</li> <li>• The microphone is being obstructed. → During the video conference call, do not block the microphone with your hand or other object.</li> <li>• There may be a problem with your communication lines. → Contact your dealer.</li> </ul>
The sound volume is low or cannot be heard at all.	<ul style="list-style-type: none"> <li>• The KX-VC500's volume settings are too low. → Increase the volume level. (Page 45)</li> </ul> <p><b>Note</b></p> <ul style="list-style-type: none"> <li>• You can set the volume level of a video conference call before starting the call. Confirm the settings. (Page 62)</li> </ul> <ul style="list-style-type: none"> <li>• The other party's microphone has been muted. → Have the other party unmute their microphone.</li> <li>• The display's volume settings are too low. → Increase the volume level of the display.</li> </ul>
You hear audio feedback.	<ul style="list-style-type: none"> <li>• The microphone is too close to the display or to speakers. → Keep microphones at least 1 m (3.3 ft) away from any display or speaker.</li> <li>• The display's volume settings are too high. → Decrease the volume level of the display.</li> </ul>

Problem	Cause and Solution
Sound cuts out or echoes.	<ul style="list-style-type: none"> <li>• Adjustments to the environment immediately after a video conference call has begun may not yet have completed.</li> <li>→ Immediately after a video conference call has begun, be sure to speak in turn with other parties. The KX-VC500 will automatically adjust audio levels so that all parties can easily be heard.</li> </ul>
The other party hears noise.	<ul style="list-style-type: none"> <li>• The Boundary Microphone cable is not properly connected.</li> <li>→ Make sure that the cable connecting the Boundary Microphone with the KX-VC500 is fully and securely inserted on either end.</li> </ul>
The orientation of the image and sound do not match (the voice of a person on a side of the screen comes from the opposite side's speaker, etc.).	<ul style="list-style-type: none"> <li>• The speakers are not properly positioned.</li> <li>→ Position speakers on either side of the display and check that the left/right wiring is correct. If you place the display at the front of the room and the speakers at the back, the microphone's left/right spatial direction may be reversed, and the orientation of the image and sound will not match.</li> <li>• The speakers of the other party are not properly positioned.</li> <li>→ Ask the other party to position speakers on either side of the display. When the MIC position is set automatically, if the other party places the display at the front of the room and the speakers at the back, the microphone's left/right spatial direction may be reversed, and the orientation of the image and sound will not match.</li> <li>• The MIC positions set manually by the other party are incorrect.</li> <li>→ Ask the other party to confirm the manual settings of their MIC positions. When setting the MIC position manually, the left/right orientation should match the left/right channels as viewed from the side of the main video camera. When the MIC position is set to "<b>Center stereo</b>", make sure that it is placed with its connector facing the display. (Page 66)</li> </ul>

## System Settings

Problem	Cause and Solution
The settings of the KX-VC500 cannot be changed.	<ul style="list-style-type: none"> <li>• A video conference call is in progress.</li> <li>→ Make settings after ending the current video conference call.</li> <li>• A video conference call is incoming.</li> <li>→ If a video conference call is received when editing contact list settings, a dialog box will be displayed asking whether to answer the call without saving the settings. Settings other than contact list settings will be lost when a video conference call is received. In that case, change the settings again after the video conference call has finished.</li> </ul>

## If These Messages Appear

Message	Cause and Solution
Call FAILED. Encryption settings (On/Off) must match. Please change the encryption setting on one side and try again.	<ul style="list-style-type: none"> <li>The encryption settings do not match those of the other party in a video conference call.</li> </ul> → Change the encryption settings to match those of the other party. (Page 64, Page 72)
Call Failed due to wrong encryption password. Please contact your installer.	<ul style="list-style-type: none"> <li>The encryption password settings do not match those of the other party in a video conference call.</li> </ul> → Contact your dealer.
Check the Main Camera connection.	<ul style="list-style-type: none"> <li>A cable or cord is not properly connected.</li> </ul> → Check that all cables to the KX-VC500 are connected properly. (Page 15) <ul style="list-style-type: none"> <li>The signal input from the main video camera is invalid.</li> </ul> → A valid signal cannot be received from the connected main video camera. Contact your dealer.
Unable to register, the contact list is full.	<ul style="list-style-type: none"> <li>The contact list has reached its maximum capacity.</li> </ul> → Delete unneeded contacts. (Page 59)
Invalid IP Address.	<ul style="list-style-type: none"> <li>The format of the entered IP address is invalid.</li> </ul> → Enter the IP address correctly, in the format XXX.XXX.XXX.XXX (decimal values separated by periods). For values of only 1 or 2 digits, enter these numbers as they are. Do not enter like [.001]. Example: The IP address is [192.168.0.1]. <ul style="list-style-type: none"> <li>Correct entry: [192.168.0.1]</li> <li>Wrong entry: [192.168.000.001]</li> </ul> Multicast or broadcast addresses cannot be used.
Invalid Subnet mask.	<ul style="list-style-type: none"> <li>The input subnet mask is invalid.</li> </ul> → Enter a valid subnet mask.
Invalid Default Gateway.	<ul style="list-style-type: none"> <li>The input default gateway is invalid.</li> </ul> → Enter a valid default gateway.
Invalid Date/Time.	<ul style="list-style-type: none"> <li>Enter a date within the valid parameters.</li> </ul> → Enter a date between January 1, 2009, and December 31, 2035.
PC is not connected. Check connection.	<ul style="list-style-type: none"> <li>A cable or cord is not properly connected.</li> </ul> → Check that all cables to the KX-VC500 are connected properly. (Page 49) <ul style="list-style-type: none"> <li>The computer is not turned on.</li> </ul> → Turn on the computer. <ul style="list-style-type: none"> <li>The computer is not set to output from its external monitor video out port.</li> </ul> → Change the computer's settings so that video is output from the external monitor port.

Message	Cause and Solution
<p>Sub-Camera is not connected. Check the connection.</p>	<ul style="list-style-type: none"> <li>• A cable or cord is not properly connected. → Check that all cables to the KX-VC500 are connected properly. (Page 52)</li> <li>• The sub video camera is not turned on. → Turn on the sub video camera.</li> </ul>
<p>Sub-Camera source is not compatible.</p>	<ul style="list-style-type: none"> <li>• A cable or cord is not properly connected. → Check that all cables to the KX-VC500 are connected properly. (Page 15)</li> <li>• The signal input from the sub video camera is invalid. → A valid signal cannot be received from the connected sub video camera. Contact your dealer.</li> </ul>
<p>Check the display resolution.</p>	<ul style="list-style-type: none"> <li>• The computer's display resolution or refresh rate is incompatible with the KX-VC500. → Set your computer's resolution and refresh rate to a setting compatible with the KX-VC500. (Page 50)</li> </ul>
<p>This IP Address is already in use.</p>	<ul style="list-style-type: none"> <li>• On the network you are using, another device is already using the IP address you have input for the KX-VC500. → Make sure that all devices on the network have unique IP addresses assigned.</li> </ul>
<p>Cooling Fan Malfunction. Please turn off the system and call for service.</p>	<ul style="list-style-type: none"> <li>• The CPU cooling fan within the device has stopped. → Quickly turn off the power. Contact your dealer.</li> </ul>
<p>Check main camera setting &lt;Check camera&gt; Set the main camera HDMI output to 1080i. &lt;Safe mode&gt; If [#] is pressed, the system enters safe mode after restart.</p>	<ul style="list-style-type: none"> <li>• A standard definition (640 × 480p, 720 × 480p) video camera signal has been detected. → Change the video camera's resolution to HD (1920 × 1080i).</li> </ul> <p><b>Note</b></p> <ul style="list-style-type: none"> <li>• If you enter Safe Mode during a video conference call, the call will be disconnected.</li> </ul>
<p>Check main camera setting &lt;Check camera&gt; Set camera operating frequency to nHz. &lt;Safe mode&gt; If [#] is pressed, the system enters safe mode after restart.</p> <p><b>Note</b></p> <ul style="list-style-type: none"> <li>• The field frequency setting of the KX-VC500 (<b>50</b> or <b>60</b>) is represented by <b>n</b>.</li> </ul>	<ul style="list-style-type: none"> <li>• A video camera with a different field frequency to the KX-VC500 has been detected. → Use a video camera with the same field frequency as the KX-VC500.</li> </ul> <p><b>Note</b></p> <ul style="list-style-type: none"> <li>• If you enter Safe Mode during a video conference call, the call will be disconnected.</li> </ul>

Message	Cause and Solution
<p>Check sub camera setting &lt;Check camera&gt; Set the sub camera HDMI output to 1080i. &lt;Safe mode&gt; If [#] is pressed, the system enters safe mode after restart.</p>	<ul style="list-style-type: none"> <li>• A standard definition (640 × 480p, 720 × 480p) video camera signal has been detected. → Change the video camera's resolution to HD (1920 × 1080i).</li> </ul> <p><b>Note</b></p> <ul style="list-style-type: none"> <li>• If you enter Safe Mode during a video conference call, the call will be disconnected.</li> </ul>
<p>Check sub camera setting &lt;Check camera&gt; Set sub camera operating frequency to nHz. &lt;Safe mode&gt; If [#] is pressed, the system enters safe mode after restart.</p> <p><b>Note</b></p> <ul style="list-style-type: none"> <li>• The field frequency setting of the KX-VC500 (<b>50</b> or <b>60</b>) is represented by <b>n</b>.</li> </ul>	<ul style="list-style-type: none"> <li>• A video camera with a different field frequency to the KX-VC500 has been detected. → Use a video camera with the same field frequency as the KX-VC500.</li> </ul> <p><b>Note</b></p> <ul style="list-style-type: none"> <li>• If you enter Safe Mode during a video conference call, the call will be disconnected.</li> </ul>
<p>Call failed due to software version mismatch.</p>	<ul style="list-style-type: none"> <li>• A video conference call to an incompatible device was attempted. → Check the other party's device. Video conference calls cannot be made to devices other than a Panasonic KX-VC500.</li> <li>• A video conference call to a KX-VC500 with an incompatible software version was attempted. → Check the software version of all parties. Update the KX-VC500 with the older software version so that the versions match.</li> </ul>
<p>Call Failed due to combination mismatch.</p>	<ul style="list-style-type: none"> <li>• In a multiple-party video conference call, one or more of the parties is incompatible. → Check the software version of all parties. Update the KX-VC500 with the older software version so that the versions match.</li> </ul>
<p>Call Failed due to unsupported product or other error.</p>	<ul style="list-style-type: none"> <li>• An unsupported feature was used. → Check the software version of all parties. Update the KX-VC500 with the older software version so that the versions match. For details about supported versions and features, contact your dealer.</li> </ul>

Message	Cause and Solution
<p>Received remote control ID (n1). VC500 current setting is (n2). Press [Home] button using the correct remote control, or setup remote control as follows.</p> <ol style="list-style-type: none"> <li>1. Press [.] and [#] at the same time</li> <li>2. Within 2 seconds, press [n2]</li> <li>3. Press [Home] to finish, this message will disappear.</li> </ol> <p>If this message will not disappear, please check the batteries in your remote control and try again.</p> <p><b>Note</b></p> <ul style="list-style-type: none"> <li>• The remote control ID of the remote control (1/2/3) is represented by n1.</li> <li>• The remote control ID of the KX-VC500 (1/2/3) is represented by n2.</li> </ul>	<ul style="list-style-type: none"> <li>• The remote control IDs of the KX-VC500 and remote control do not match.</li> </ul> <p>→ Follow the on-screen instructions to change the remote control ID of the remote control to match that of the KX-VC500.</p> <p>→ If you cannot change the remote control ID of the remote control, contact your dealer.</p> <p>→ If multiple remote controls with assigned IDs will be used close together or if you do not want this message to be displayed, select <b>"OFF"</b> for <b>"Check ID mismatch"</b>. (Page 68)</p>
<p>The IP Address is invalid. Please enter a valid IP Address.</p>	<ul style="list-style-type: none"> <li>• The IP address contains an invalid value.</li> </ul> <p>→ Enter the IP address correctly. The correct format is XXX.XXX.XXX.XXX (dotted format decimal notation). If the IP address contains 1 or 2 digit numbers, enter these numbers as they are. Do not enter like [.001]. Example: The IP address is [192.168.0.1].</p> <ul style="list-style-type: none"> <li>– Correct entry: [192.168.0.1]</li> <li>– Wrong entry: [192.168.000.001]</li> </ul> <p>Multicast or broadcast addresses cannot be used.</p>
<p>Check the IP Address.</p>	<ul style="list-style-type: none"> <li>• The IP address of the other party is the same as your own IP address.</li> <li>• The same IP address is used for several parties in a multiple-party video conference call.</li> </ul> <p>→ Register the correct IP address.</p> <p>→ Check the IP address registered in the contact list.</p>

Message	Cause and Solution
Invalid DNS Server Address.	<ul style="list-style-type: none"> <li>The IP address contains an invalid value.</li> </ul> <p>→ Enter the IP address correctly. The correct format is XXX.XXX.XXX.XXX (dotted format decimal notation). If the IP address contains 1 or 2 digit numbers, enter these numbers as they are. Do not enter like [.001]. Example: The IP address is [192.168.0.1].</p> <ul style="list-style-type: none"> <li>Correct entry: [192.168.0.1]</li> <li>Wrong entry: [192.168.000.001]</li> </ul> <p>Multicast or broadcast addresses cannot be used.</p>
<p>Connection will be closed in <b>n</b> seconds. Press "YES" to continue.</p> <p><b>Note</b></p> <ul style="list-style-type: none"> <li>The message first appears when one minute remains and "<b>60</b>" is displayed for <b>n</b>. Then, the remaining time starts to decrease.</li> </ul>	<ul style="list-style-type: none"> <li>The time set for "<b>Call Limit time</b>" has one minute remaining. (Page 64)</li> </ul> <p>→ If you select "<b>Yes</b>", you can extend the call limit time for the amount set for "<b>Call Limit time</b>". If you select "<b>No</b>", the call is disconnected.</p>

## Miscellaneous

Problem	Cause and Solution
"Safe Mode" is displayed on the screen.	<ul style="list-style-type: none"> <li>A standard definition (640 × 480p, 720 × 480p) video camera signal has been detected.</li> </ul> <p>→ Disconnect the video camera from the KX-VC500, and reset the KX-VC500 by turning off its power, then turning it back on. Check to make sure the video camera's resolution is set to HD (1920 × 1080i), and then connect the video camera to the KX-VC500 again.</p> <ul style="list-style-type: none"> <li>A standard definition (640 × 480p, 720 × 480p) display signal has been detected.</li> </ul> <p>→ Disconnect the display from the KX-VC500, and reset the KX-VC500 by turning off its power, then turning it back on. Make sure to connect a HD (1920 × 1080i) display to the KX-VC500.</p> <ul style="list-style-type: none"> <li>The field frequency of the video camera or display you are using is different from the field frequency setting of the KX-VC500.</li> </ul> <p>→ Use a video camera or display that has the same field frequency as the KX-VC500. For details, contact your dealer.</p>

# System Specifications

Video	Compression Method		H.264
		Compatible Resolutions	<ul style="list-style-type: none"> <li>• 1920 × 1080i</li> <li>• 1280 × 720p</li> <li>• 704 × 480p</li> </ul>
	Camera Input Resolution		1920 × 1080i
	PC Input Resolutions		XGA, SVGA, VGA
Audio	Compression Method		MPEG-4 AAC LD
		Frequency Range	20 kHz
		No. of Channels	2
		Bitrate	64 kbit/s, 96 kbit/s (per channel)
	Sound Processing Function		Stereo Echo Canceller
	Microphone		Boundary Microphone KX-VCA001 (Option)
		Pickup Range	2 m radius, 360° coverage
		Cascade Connections	Up to 4 Boundary Microphones
		Sound Pickup Method	Stereo/Monaural <sup>*1</sup>
Transmission	Call Control		SIP
	Other		AV QoS Call Control, Encrypted Transmission (AES)
External Interface	Video Inputs		HDMI (Camera) × 2, RGB (PC) × 1 (Switchable 3 inputs)
	Video Output		HDMI × 1, RCA (Component) × 1
	Audio Input		Boundary Microphone port × 1, RCA (Stereo) × 1
	Audio Output		RCA (Stereo) × 1 (Audio output to display is via HDMI)
	Network		RJ45 port × 1
	Other		<ul style="list-style-type: none"> <li>• Camera Control RS-232C Serial Port × 1</li> <li>• Maintenance RS-232C Serial Port × 1</li> </ul>
Misc.	Dimensions (width × depth × height)		Approx. 430 mm × approx. 280 mm × approx. 80 mm (approx. 17 in × approx. 11 in × approx. 3.2 in)
	Weight		Approx. 4 kg (approx. 8.8 lb)
	Power Consumption		Standby: approx. 30 W Maximum: approx. 32 W

<sup>\*1</sup> Either output can be set through system settings. (Page 66)



# Index

## A

Administrator Password, setting 75  
 Amplifier/Speaker 23  
 Answering a Video Conference Call 37  
 Answering, Automatic 38  
 Answering, Manual 37

## B

Batteries, changing (remote control) 84  
 Boundary Microphone 17  
 Buttons, Main Unit 14  
 Buttons, Remote Control 16

## C

Calling by Entering an IP Address 33  
 Calling from the Call History 35  
 Calling from the Contact List 31  
 Calling using Speed Dial 28  
 Cleaning the unit 85  
 Computer Screen, viewing 49  
 Connection  
   Amplifier/Active Speaker 23  
 Connection Status, viewing 56  
 Connection, setting 63  
 Contacts, adding 58  
 Contacts, deleting 59  
 Contacts, editing 59

## D

Date and Time, setting 62

## E

Encryption, setting 72

## F

For Your Safety 7

## I

Inputting Letters and Numbers 79

## L

Language, setting 71  
 LED Patterns 18  
 Local Site, setting 76

## M

Making a Video Conference Call 28  
 Mic Position, setting 65  
 Microphones 21  
 Muting the Microphone 46

## N

Network Test, performing 69  
 Network, setting 62  
 Noise reduction 47

## O

Optional Accessory 17

## P

Part Names and Usage 14  
 Ports, Main Unit 15  
 Privacy 12  
 Protecting Information 12

## R

Remote Control, setting 68  
 Remote Maintenance, performing 70  
 Right of Publicity 12

## S

Screen Display 25  
 Screen Layout, changing (2-party call) 39  
 Screen Layout, changing (3-party call) 40  
 Screen Layout, changing (4-party call) 42  
 Screen Standby Mode 18  
 Screen Standby, setting 74  
 Security 12  
 Self Diagnosis, performing 69  
 Software Update, setting 72  
 Sound, setting 62  
 Specifications, system 96  
 Sub Video Camera, viewing 52  
 System Initialization, performing 75

## T

Tone, Adjusting 48  
 Troubleshooting 86

## U

Unit Information, viewing 57, 65  
 Unit Name, setting 61

## V

Volume, adjusting 45

**When you ship the product**

Carefully pack and send it prepaid, adequately insured and preferably in the original carton. Attach a postage-paid letter, detailing the symptom to the outside of the carton. DO NOT send the product to the Executive or Regional Sales offices. They are NOT equipped to make repairs.

**Product service**

For product service, ship the product to the address listed in the Limited Warranty. Consult your authorized Panasonic dealer for detailed instructions.

**Panasonic Canada Inc.**

5770 Ambler Drive, Mississauga, Ontario, L4W 2T3

**Panasonic Corporation of North America**

One Panasonic Way, Secaucus, New Jersey 07094

<http://www.panasonic.com/csd>

**Copyright:**

This material is copyrighted by Panasonic System Networks Co., Ltd., and may be reproduced for internal use only. All other reproduction, in whole or in part, is prohibited without the written consent of Panasonic System Networks Co., Ltd.

© Panasonic System Networks Co., Ltd. 2010

**PNQX2744YA** KK0310KE1100

## Free Manuals Download Website

<http://myh66.com>

<http://usermanuals.us>

<http://www.somanuals.com>

<http://www.4manuals.cc>

<http://www.manual-lib.com>

<http://www.404manual.com>

<http://www.luxmanual.com>

<http://aubethermostatmanual.com>

Golf course search by state

<http://golfingnear.com>

Email search by domain

<http://emailbydomain.com>

Auto manuals search

<http://auto.somanuals.com>

TV manuals search

<http://tv.somanuals.com>