

Panasonic

LD Auto Reverse
Multi Laser Disc Player

LX-H680 ^U_{CA}

Operating Instructions



Multi Laser Disc Player

Before attempting to connect, operate or adjust this product,
please read these instructions completely.

VQT6436

Information for Your Safety

Note

This unit can be used only where the power supply is AC 120 V, 50–60 Hz. It cannot be used elsewhere.

The model number and serial number of this product can be found on either the back or the bottom of the unit.

Please note them in the space provided below and retain this booklet as a permanent record of your purchase to aid identification in the event of theft.

MODEL NUMBER _____

SERIAL NUMBER _____

CAUTION:

THIS PRODUCT UTILIZES A LASER. USE OF CONTROLS OR ADJUSTMENTS OR PERFORMANCE OF PROCEDURES OTHER THAN THOSE SPECIFIED HEREIN MAY RESULT IN HAZARDOUS RADIATION EXPOSURE. DO NOT OPEN COVERS AND DO NOT REPAIR YOURSELF. REFER SERVICING TO QUALIFIED PERSONNEL.

**CAUTION**

RISK OF ELECTRIC SHOCK
DO NOT OPEN



CAUTION TO REDUCE THE RISK OF ELECTRIC SHOCK, DO NOT REMOVE COVER (OR BACK). NO USER-SERVICEABLE PARTS INSIDE. REFER SERVICING TO QUALIFIED SERVICE PERSONNEL.



This symbol warns the user that uninsulated voltage within the unit may have sufficient magnitude to cause electric shock. Therefore, it is dangerous to make any kind of contact with any inside part of this unit.



This symbol alerts the user that important literature concerning the operation and maintenance of this unit has been included. Therefore, it should be read carefully in order to avoid any problems.

CAUTION MULTI LASER DISC PLAYERS USE AN INVISIBLE LASER BEAM WHICH COULD CAUSE HAZARDOUS RADIATION EXPOSURE IF DIRECTED. BE SURE TO OPERATE THE PLAYER CORRECTLY AS INSTRUCTED.

WARNING:

TO REDUCE THE RISK OF FIRE OR SHOCK HAZARD, DO NOT EXPOSE THIS EQUIPMENT TO RAIN OR MOISTURE.

TO REDUCE THE RISK OF FIRE OR SHOCK HAZARD AND ANNOYING INTERFERENCE, USE THE RECOMMENDED ACCESSORIES ONLY.

FOR YOUR SAFETY**■ DO NOT REMOVE OUTER COVER.**

To prevent electric shock, do not remove cover. No user serviceable parts inside. Refer servicing to qualified service personnel.

FCC NOTE: (U S Only)

This device complies with Part 15 of the FCC Rules. To assure continued compliance follow the attached installation instructions and do not make any unauthorized modifications.

This equipment has been tested and found to comply with the limits for a Class B digital device, pursuant to Part 15 of the FCC Rules. These limits are designed to provide reasonable protection against harmful interference in a residential installation. This equipment generates, uses, and can radiate radio frequency energy and, if not installed and used in accordance with the instructions, may cause harmful interference to radio communications. However, there is no guarantee that interference will not occur in a particular installation. If this equipment does cause harmful interference to radio or television reception, which can be determined by turning the equipment off and on, the user is encouraged to try to correct the interference by one or more of the following measures:

- Reorient or relocate the receiving antenna.
- Increase the separation between the equipment and receiver.
- Connect the equipment into an outlet on a circuit different from that to which the receiver is connected.
- Consult the dealer or an experienced radio/TV technician for help.

CAUTION: (Canada Only)

TO PREVENT ELECTRIC SHOCK DO NOT USE THIS (POLARIZED) PLUG WITH AN EXTENSION CORD, RECEPTACLE OR OTHER OUTLET UNLESS THE BLADES CAN BE FULLY INSERTED TO PREVENT BLADE EXPOSURE.

Contents

Accessories



Before setting up the unit, make sure that you have the following accessories.

- Infrared Remote Control

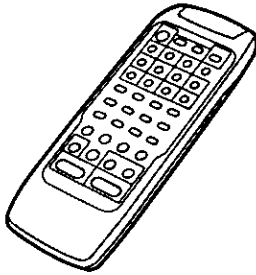

- 2 ANSI "AAA" Batteries for the Remote Control

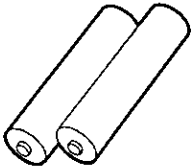

- AC Power Cord



- Video/Audio Cord

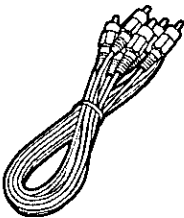

Overview

Controls and indicators	4
Connections	6
The disc	8

Basic Operations

Playback from beginning of disc	10
◦Playing side B of a disc	11
◦Last Memory	11
◦Listening with Headphones	11
Playing desired chapter (or track)	12
◦Direct selection of chapter (or track) number	12
Skipping forward or backward	13
◦Skipping to the following or previous chapters (or tracks)	13
Programming playback of desired chapter (or track)	14
◦Playback in programmed order	14
◦To verify programmed chapters (or tracks)	15
◦To add programmed chapters (or tracks)	15
◦To delete the programmed chapters (or tracks)	15
Search functions	16
◦Forward (Reverse) playback using the Shuttle Dial	16
◦Forward (Reverse) playback using SCAN on the Remote Control	16
◦Search playback using the Frame Number	17
◦Search playback using the Time Number	17
◦Intro scan playback	18
◦Intro scan playback in the programmed order	18

Advanced Operations

Various playback	19
◦Playback in random order	19
◦Still Playback and Frame Forward/Reverse Playback	19
◦Repeat Playback	20
◦Programmed Repeat Playback	21
◦Return to the segment you want to view or listen again	21
◦Repeat Playback in a random order	21
◦Repeat Playback between two designated points	21

Editing

Recording from a disc to a tape	22
◦Editing in the prerecorded order of the disc	22
◦Checking of the remaining tape time of side B	23
◦Checking the recorded chapters (or tracks)	23
◦Recording in a programmed order	23

Helpful Hints

Audio channel selection	24
Multi-function display	25
On screen display	26
Precautions for use	28
Before requesting service	30
Specifications	Back Cover

Controls and indicators

Front Panel

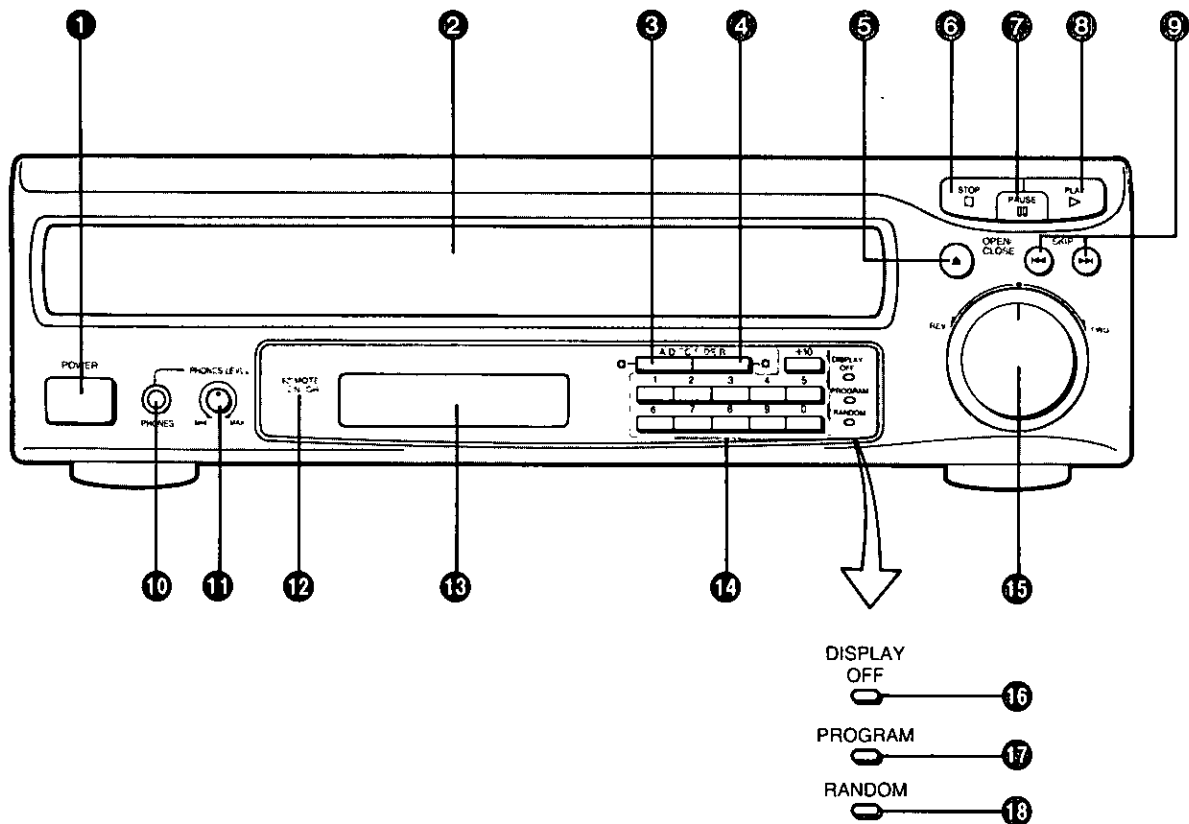

	Page
❶ POWER	10
❷ Disc Tray	8
❸ DISC SIDE A	11
❹ DISC SIDE B	11
❺ OPEN/CLOSE	10
❻ STOP	10
❼ PAUSE	10
❽ PLAY	10
❾ SKIP (Forward/Reverse)	13
❿ PHONES Connector	11
⓫ PHONES LEVEL Control	11

	Page
❿ REMOTE SENSOR (Remote control signal receiver)	11
⓬ Multi-Function Display	25
⓭ Numeric Buttons	12
⓮ Shuttle Dial	16
⓯ DISPLAY OFF Indicator •Lit when the Multi-Function Display is turned off using the FL DISP Button on the Remote Control. (See page 25.)	
⓰ PROGRAM Indicator •Lit during Program Playback.	
⓱ RANDOM Indicator •Lit during Random Playback.	

Remote Control

The buttons marked with a black circle by "Ⓢ" have the same function as the buttons on the front panel of the unit.

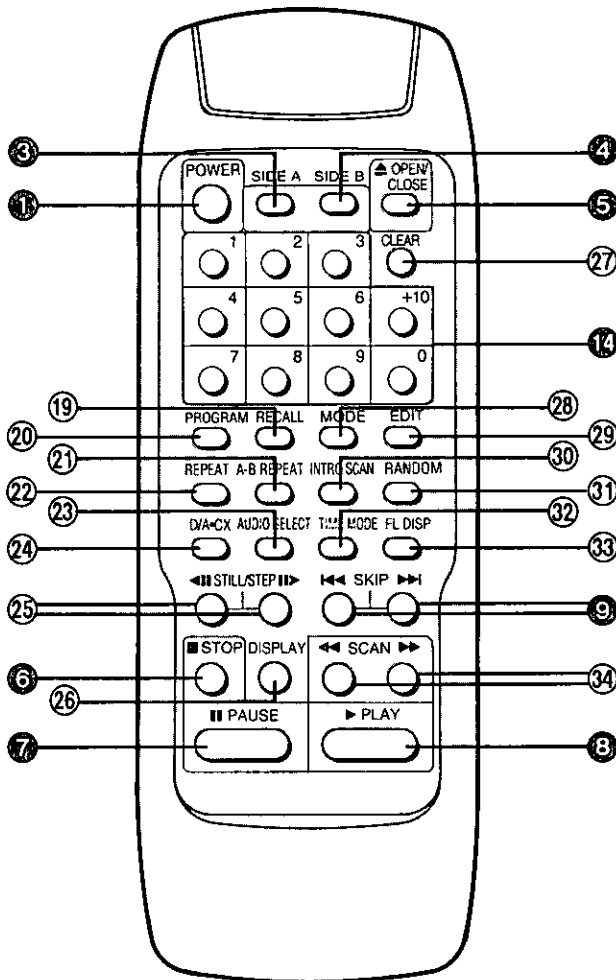

	Page
① POWER	10
③ SIDE A	11
④ SIDE B	11
⑤ OPEN/CLOSE	10
⑥ STOP	10
⑦ PAUSE	10
⑧ PLAY	10
⑨ SKIP (Forward/Reverse)	13
⑭ Numeric Buttons	12
⑰ RECALL	15
⑳ PROGRAM	14
㉑ A-B REPEAT	21
㉒ REPEAT	20
㉓ AUDIO SELECT	24
㉔ D/A • CX	24
㉕ STILL/STEP (Forward/Reverse)	19
㉖ DISPLAY	27
㉗ CLEAR	15
㉘ MODE	17
㉙ EDIT	22
㉚ INTRO SCAN	18
㉛ RANDOM	19
㉜ TIME MODE	27
㉝ FL DISP	25
㉞ SCAN (Forward/Reverse)	16

Battery Loading

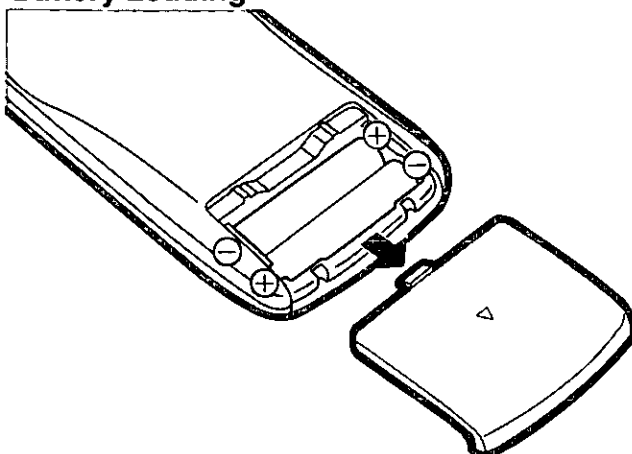

Load batteries with their polarities (+ and -) aligned correctly.

Notes

- Do not use rechargeable batteries (i.e. NiCad batteries).
- Do not mix new and old batteries, nor different brands of batteries.
- Do not try to recharge or short-circuit the batteries.
- Do not break batteries open, heat them or incinerate them.
- Remove batteries when the Remote Control is not in use for long periods of time.
- Should the battery leak, clean and wipe the Battery Case and load in new batteries.

Battery Life (When to exchange batteries)

- Replace the batteries with new ones about every 6 months, however, battery life depends on the frequency of use or the selected mode of operation.
- Replace the batteries when the Remote Control cannot operate the unit at a close range.
- Use ANSI "AAA" size batteries.

Connections

Before connecting other components to this unit, please read their corresponding manuals.

TV with Video/Audio Input Connectors

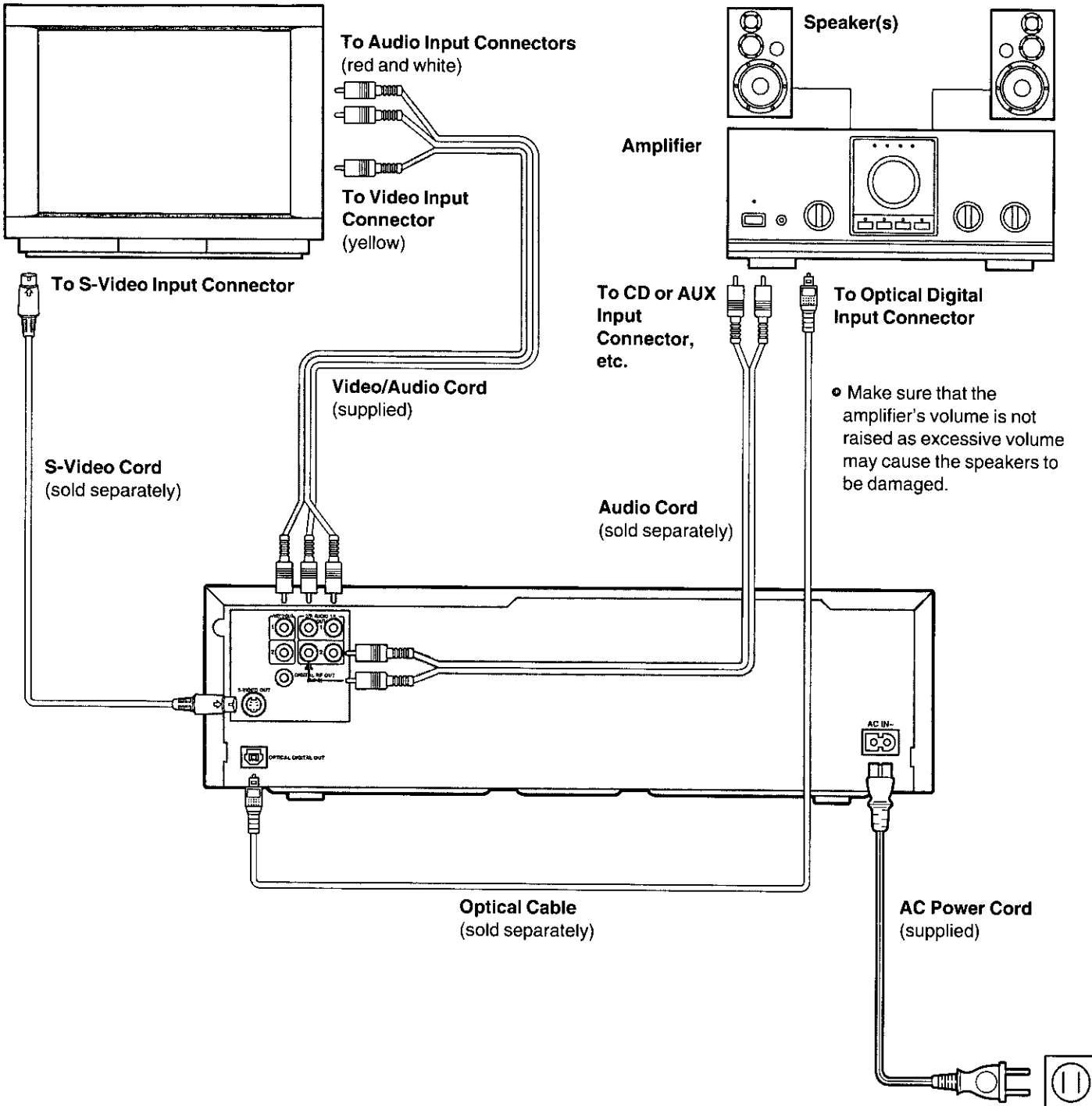

The plugs for the video and audio cords are color coded in the following way:

- Yellow plug To Video Connector
 - White plug To Audio Connector (left)
 - Red plug To Audio Connector (right)
- Connect the plugs to their corresponding connectors.

To AC outlet
(AC 120 V, 50–60 Hz)

DIGITAL • RF OUT (AC-3) Connector

If you use the AC-3 Decoder with RF input connector (sold separately) and Amplifier with the AC-3 RF input connector (sold separately) to play discs bearing the "Dolby Surround" and "AC-3" marks, instead of connecting the AUDIO OUT connector on the previous page, make connections as shown below.

These connections give you powerful sound with all the presence of a movie theater or concert hall.

Note

Do not make connection between this connector and the audio input connector of the ordinary stereo system's amplifier, which may cause damage to the speaker. Be sure to attach the supplied rubber cap to this connector when it is not used.

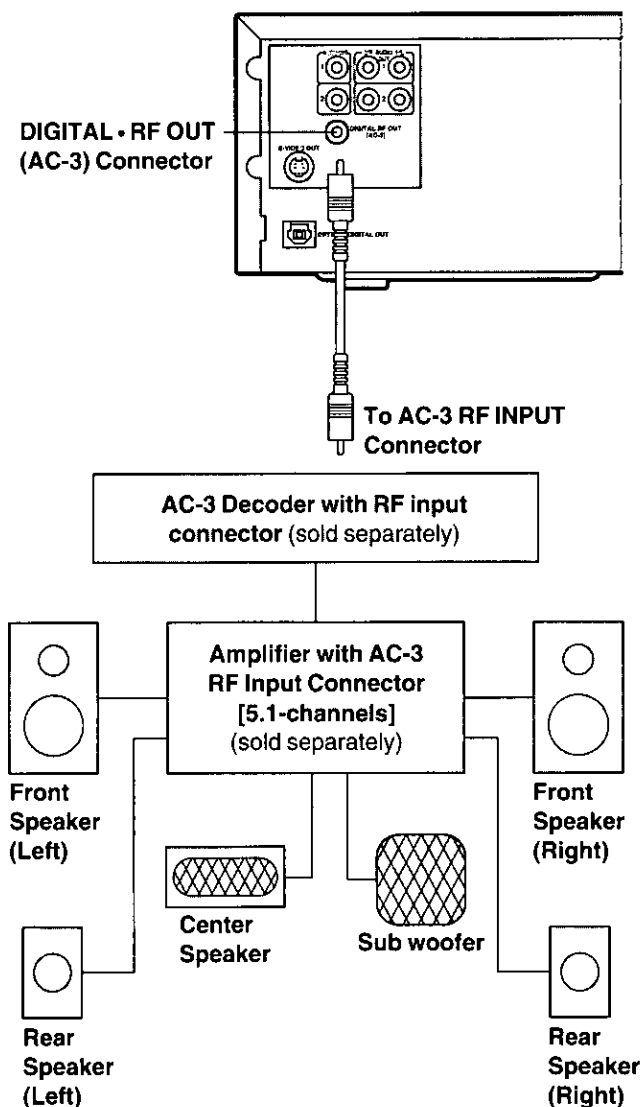

S-Video Output Connector

A conventional video output signal consists of a color signal (C) and a luminance signal (Y). The new S (Separate)-Video Connector allows a separate transmission of each signal to the TV, thus obtaining a clearer picture.

- Use an S-Video Cord (sold separately) when using a TV with an S-Video Input Connector.

Optical Digital Output Connector

The optical digital output connector transmits a signal which is converted to an optical format from the digital audio signal and transmits the signal to an amplifier. Optical transmissions keep the audio signal free from external electrical influences such as noise, which could affect external appliances.

- Use an Optical Cord (sold separately) when using an amplifier with the Optical Digital Connector.

How to connect an optical cable

1. Remove the Dust Protection Cap from the connector.
2. Connect the optical cable.

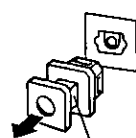

Dust Protection Cap

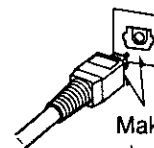

Make sure the plug properly fits into the connector.

- Fully insert the plug into the connector. Make sure the plug properly fits into the connector.
- Save the dust protection cap, and be sure to reattach it to the Optical Digital Connector to keep it dust-free when the optical cable is removed.

Notes

- This digital audio connector does not output an analog audio signal.
- The AUDIO SELECT Button does not function when this connection is used.

Optical Cable (Sold Separately)

- Use an optical cable with a length of 3 m or less.
- Be careful not to scratch the plugs of the optical cable or leave it dusty.
- If the plugs become dusty, wipe them with a soft cloth before connecting.
- Be especially careful not to bend the optical cable.

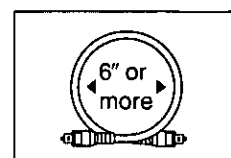
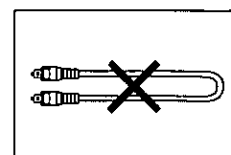

- If you roll the optical cable for storage, make sure that the inner diameter of the loops is 6" or more.

AC-3 (digital multi-track audio format) is the format used when recording 5.1-channel audio onto the digital track of film for the movie theater surround system. "Dolby", "AC-3" and the double-D symbol  are trademarks of Dolby Laboratories Licensing Corporation.

The disc

Type of discs that can be played back

The unit can play back laser discs bearing the following symbols.



LD (12")
Double-sided or single-sided disc
[CAV (standard play) max. 30 min.
per side]



[CLV (long-play) max. 60 min.
per side]

LD (8")
Double-sided disc
[CAV (standard play) max. 14 min.
per side]
[CLV (long-play) max. 20 min.
per side]



LD SINGLE (8")
Single-sided disc
[CAV (standard play) max. 14 min.]
[CLV (long-play) max. 20 min.]



CDV (5")
Single-sided disc
[Audio part (audio recording only)
max. 20 min.]
[Video part (video and audio
recordings) max. 5 min.]



CD (5")
Single-sided disc
[Max. 74 min.]

CD SINGLE (3")
Single-sided disc
[Max. 20 min.]

Handling the Disc

Hold the disc so that the disc's surface is not touched.

LD, LD Single Discs

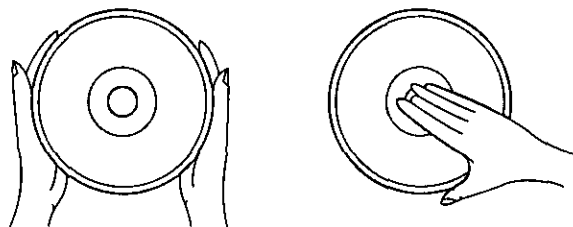

CDV, CD or CD Single Discs

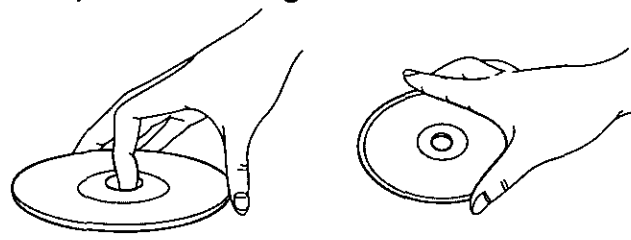

Placing the Disc on the Disc Tray

1. Make sure which disc side is to be played.

•LD

When playing a double-sided disc, place the disc with side "A" facing up.

When playing a single-sided, place the disc with the side bearing the album or chapter titles facing up.

•LD single, CDV or CD

Place the disc with the side bearing the album or chapter (or track) titles facing up.

2. Place the disc in the proper recession according to its size.

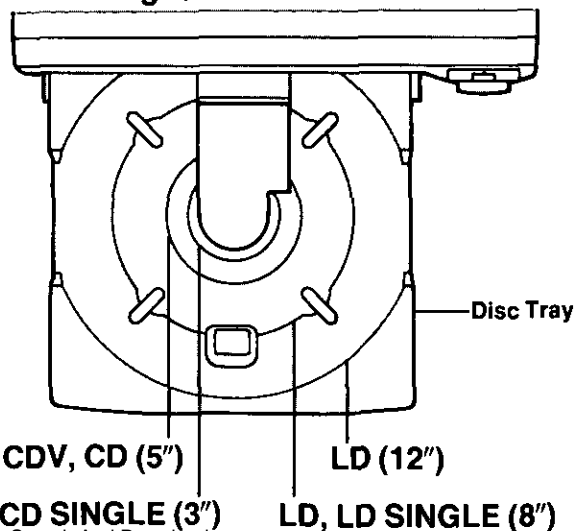

Glossary on LD

LD

Abbreviation for **Laser Disc**. Various kinds of LD on which movies, music or accompaniment for Karaoke (singing with recorded accompaniment) are available. There are two sizes of LD: 12" and 8" diameter discs (or thinner 8" single-sided LD). CAV (standard play) and CLV (long-play) are two basic kinds of laser discs.

CAV Disc (standard play)

Abbreviation for **Constant Angular Velocity**. A CAV disc rotates constantly at 1,800 rpm. The laser beam moves from the center (innermost band) to the outer edge (outermost band) and reads the recorded signal of one track with each revolution. Each track holds one video frame. A maximum of 54,000 frames is recorded on one side.

- Still playback and Frame forward/reverse playback can be performed only when a CAV disc is used.

CLV Disc (long-play)

Abbreviation for **Constant Linear Velocity**. A CLV disc gradually decreases its rotational speed from 1,800 rpm near the center to 600 rpm near the outer edge in order to keep a constant linear velocity. The elapsed playing time (time No.) is recorded on the disc.

Chapter Number

Number assigned to divided sections or songs on a disc. This enables quick access to the desired part.

Frame Number

Number assigned to a picture (one video frame) on each track of a CAV disc. This enables quick access to the desired frame by designating a frame number.

Time Number

The total elapsed time from the beginning of the first chapter of a CLV disc. It is used for easy access to the desired frame.

Disc with digital audio

A disc onto which the digital audio signals are recorded in addition to regular analog audio signals. This unit can play both types of audio signals. This type of disc bears the following symbols.

or

AC-3 Disc

AC-3 (digital multi-track audio format) is the format used when recording 5.1-channel audio onto the digital track of film for the movie theater surround system.

"Dolby", "AC-3" and the double-D symbol  are trademarks of Dolby Laboratories Licensing Corporation. This type of disc bears the following symbols.

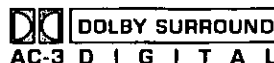

Glossary on CDV

CDV

Abbreviation for **Compact Disc Video**. A video signal is added to the digital audio signal of a CD. It is composed of an audio part (digital audio recording), with a maximum length of 20 minutes, and a video part (video and digital audio recordings) with a maximum length of 5 minutes.

Glossary on CD

CD

Abbreviation for **Compact Disc**. It has a longer playing time than that of an LP record with hi-fi digital sound quality. There are two CD sizes: 5" CD and 3" CD single.

Track Number

Number assigned to songs recorded on a disc. This is equivalent to a song number. This enables quick access to the desired song.

Index Number

Song number assigned to small divided sections of a track. When a disc on which no index number has been recorded is used, the index indication "1" always appears on the Multi-Function Display of the unit.

- This unit cannot perform Intro Scan Play and Skip Play using the index numbers.

What is TOC?







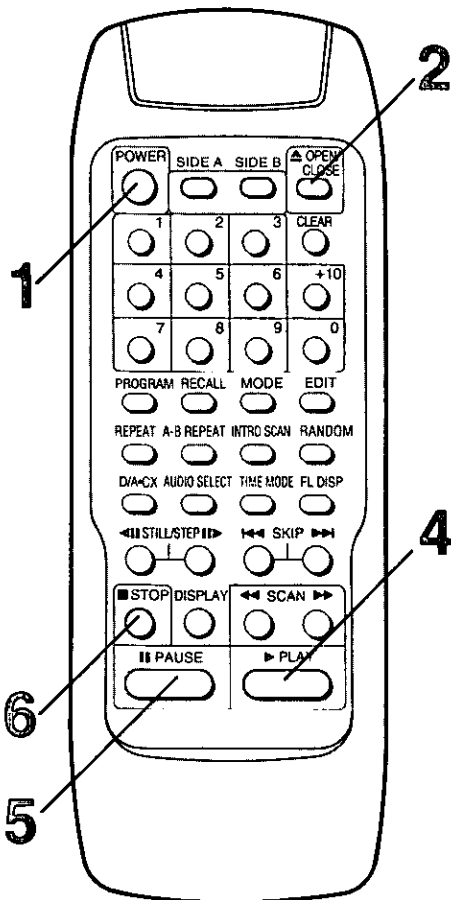
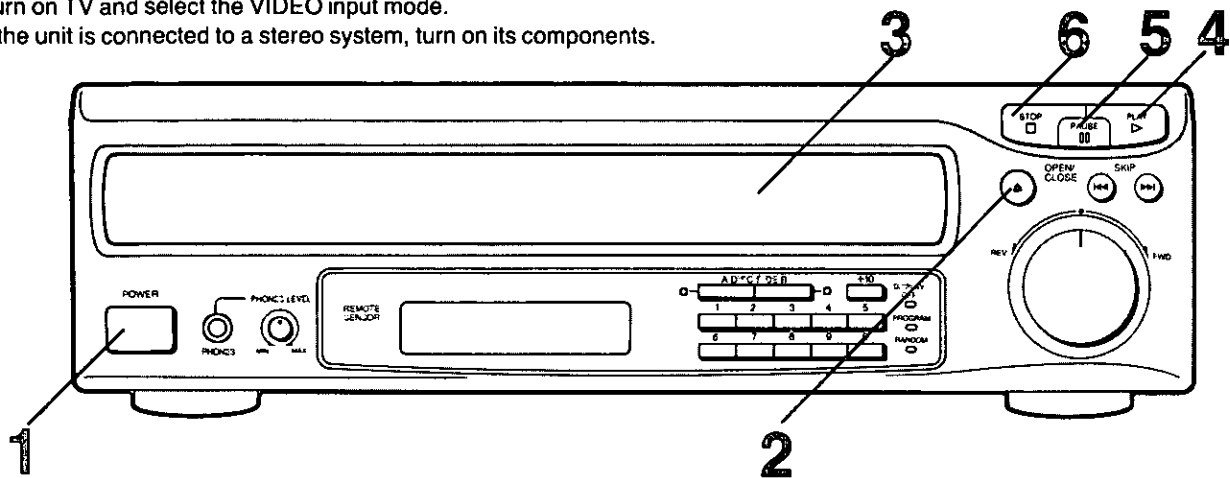

Abbreviation for **Table Of Contents**. TOC signals are recorded onto the beginning of all CD, CDV discs, and some LDs. This signal is similar to a table of contents of a book and includes disc information (the number of songs and their playing times).

Playback from beginning of disc

Preparation:

- Turn on TV and select the VIDEO input mode.
- If the unit is connected to a stereo system, turn on its components.



Procedure	TV screen
1  Turn on the unit.	
2  Open the Disc Tray.	
3  Insert the disc.	
4  Start playback. • When playback of side A of a double-sided disc is finished, side B is automatically played.	
5  Interrupt playback temporarily. • Press PAUSE Button again to resume playback.	
6  Stop playback.	

Playing side B of a disc

Double-sided
LD only

TV screen

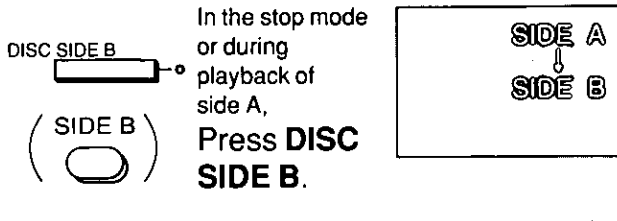

When playback of side B is finished, the unit automatically returns to side A and stops.

To play side A again while side B is being played,

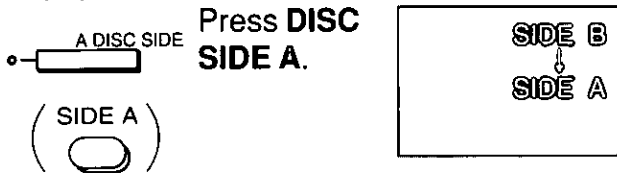

To start side B playback with the Disc Tray being opened,

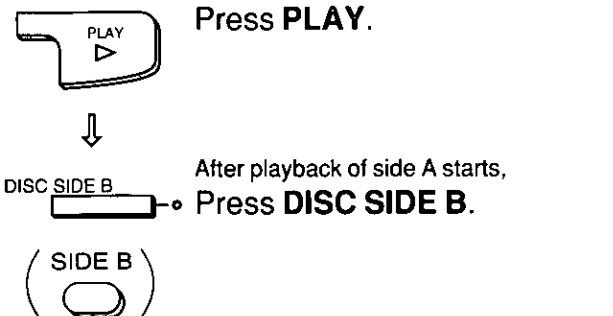

Last Memory

LD only

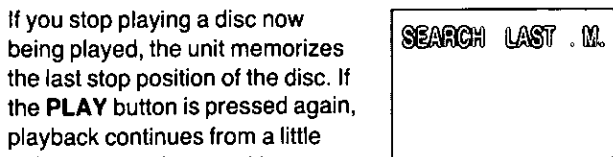

- The Last Memory function is canceled if any operation other than playback is performed.
- This function does not work during Program, Random and Repeat playbacks.

Remote Control Operation

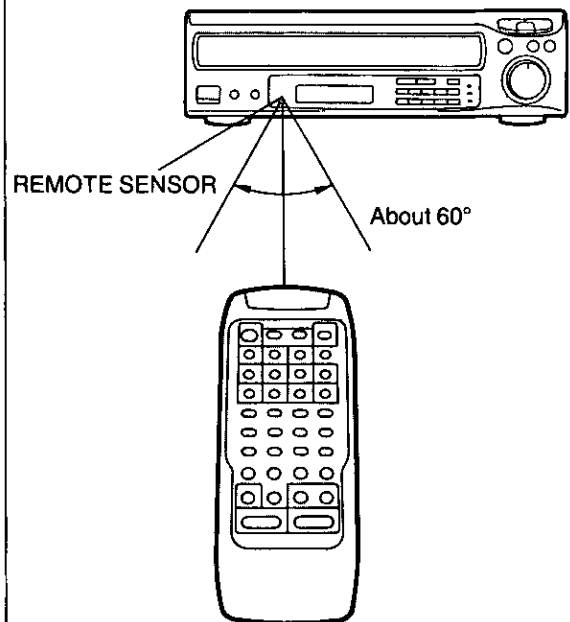

Point the Remote Control no more than about 7 m from the **REMOTE SENSOR** and within about 60° of the front of the unit.

The operable distance varies with the brightness of the room.

Notes for Operation

- Do not expose the **REMOTE SENSOR** to strong light.
- Do not place any obstacles between the Remote Control and the **REMOTE SENSOR**.
- Do not use the Remote Control simultaneously with another component's infrared remote control.

Listening with Headphones

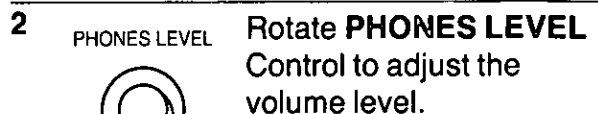
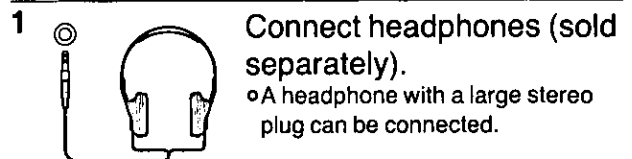

Note

Avoid listening with headphones at high volumes for an extended period of time as it may affect your hearing.

Playing desired chapter (or track)

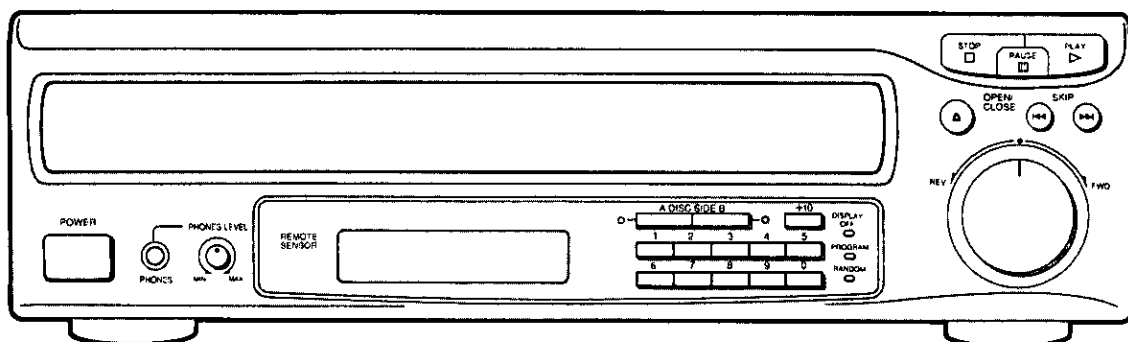

Direct selection of chapter (or track) number (Direct Selection)

Example) To play chapter (or track) 3

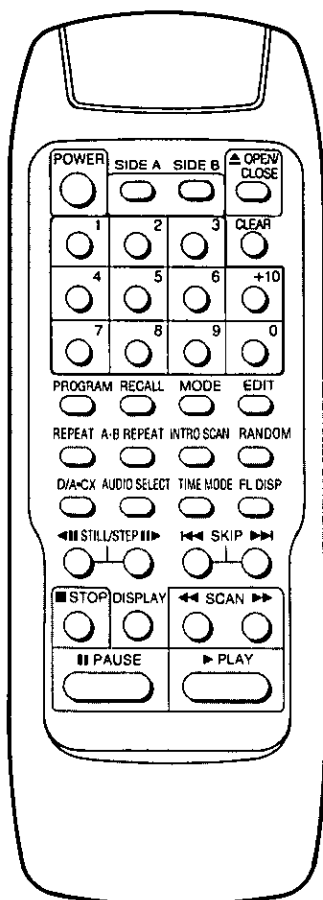

TV screen



Press ③.

•The display on the right is what will be seen on the TV screen when an LD is used.

SEARCH
CHAPTER 3

Select a two-digit number

Example) 10th chapter (or track)

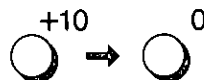

Example) 25th chapter (or track)

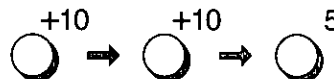

Select chapter number on side B [on a double-sided LD]

Example) To select the 3rd chapter on side B



■ Notes on LD

- This function is non-operational when an LD recorded without chapter numbers recorded is used.
- The indication "CHAPTER" on the TV screen remains displayed until a number is designated. When you want to erase the indication from the screen, press the CLEAR button or enter a number.

■ Note

If an unrecorded chapter (or track) number is designated, the indication shown at the right is displayed. Depending on the disc type, sometimes a segment before the end of the disc is played.

TRACK 17

ERROR

Example of CD

Skipping forward or backward

Playing desired chapter (or track)
Skipping forward or backward

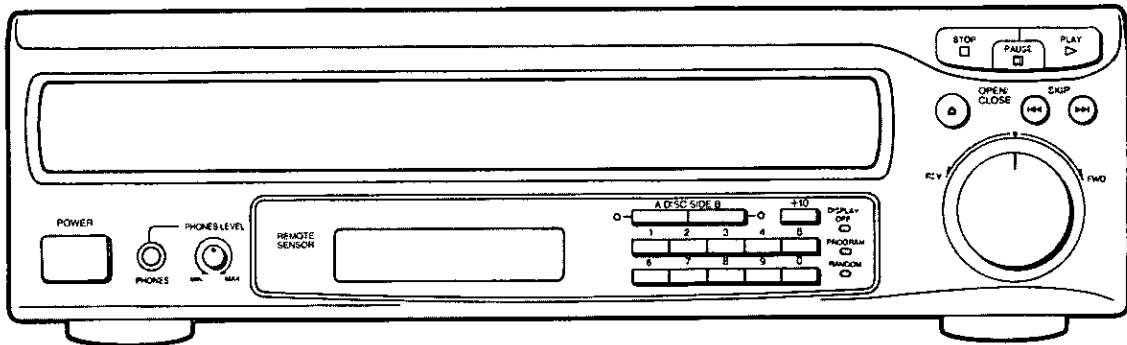

Skipping to the following or previous chapters (or tracks) (Skip Play)

To skip to the following (forward) chapters (or tracks)



During playback,
Press **SKIP** (▶▶).

- The number of chapters (or tracks) skipped equals the number of times that the button was pressed.

Example) Press 3 times to skip to the beginning of chapter (or track) 5 from chapter (or track) 2 now being played.

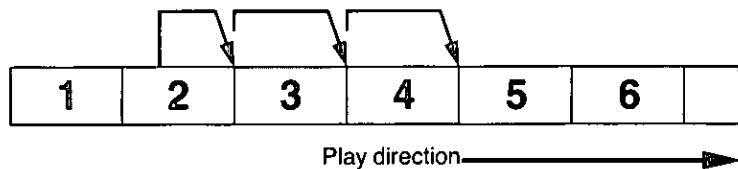

To skip to the previous (backward) chapters (or tracks)



During playback,
Press **SKIP** (◀◀).

- Pressing the button once skips to the beginning of the chapter (or track) now being played back. If the button is pressed repeatedly, the number of chapters (or tracks) skipped equals the number of times that the button was pressed.

Example) Press 4 times to skip to the beginning of chapter (or track) 2 from chapter (or track) 5 now being played.

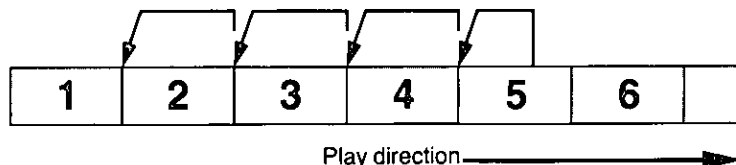

Note on LD

This function is non-operational when an LD recorded without chapter numbers recorded is used.

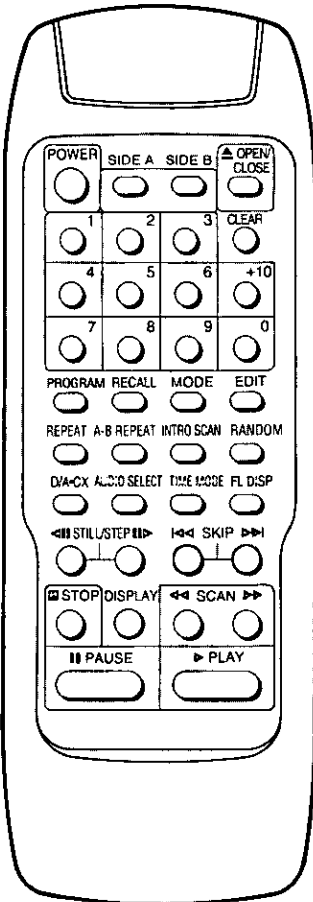







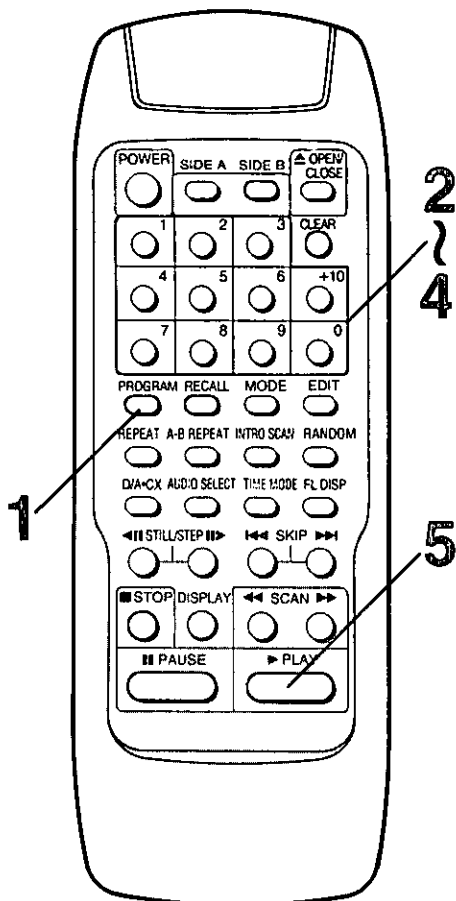

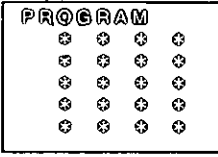
Programming playback of desired chapter (or track)

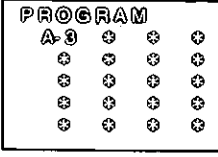
Playback in programmed order (Programmed Playback)

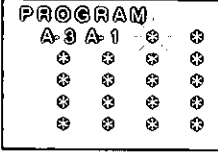
Example) To play chapters (or tracks) of a disc in the order of ③ ⇒ ① ⇒ ④

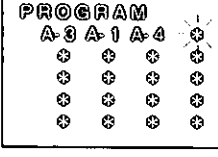

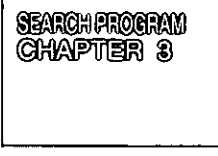
Procedure	TV screen
1 PROGRAM  During playback or in the stop mode, Press PROGRAM .	
2  ³ Press ③. • If you press a wrong numeric button, press the CLEAR Button and then the correct numeric button again.	
3  ¹ Press ①.	
4  ⁴ Press ④.	
5  ^{▶ PLAY} Start playback. • After all programmed chapters (or tracks) are played back, the unit is put into the stop mode and the programming display appears on the TV screen.	

To designate a two-digit chapter (or track) number
See page 12.

How to program chapters on side B
[on a double-sided LD]

Example) To select the 2nd chapter on side B

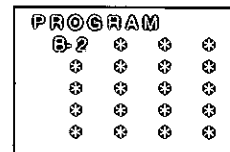
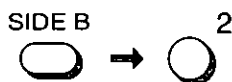

■ Notes

- If a chapter (or track) number unrecorded on a disc is selected, the message "ERROR" flashes on and off on the TV screen (and the indication "E" on the unit's display). Select the chapter (or track) number recorded on a disc.
- If the number of programmed chapters (or tracks) is beyond 20, the indication "FULL" flashes on and off on the TV screen (and the indication "-F" on the Multi-Function Display of the unit). At this time, no further programming is possible.

■ Notes on LD

- This function is non-operational when an LD recorded without chapter numbers is used.
- When a single-sided disc is used, the programmed chapter numbers of side B are skipped during playback.

To perform Programmed Playback again



To pause Programmed Playback at its beginning

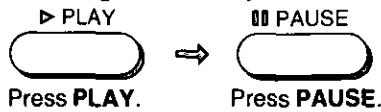

To resume the normal playback
During Programmed Playback,



To verify programmed chapters (or tracks)

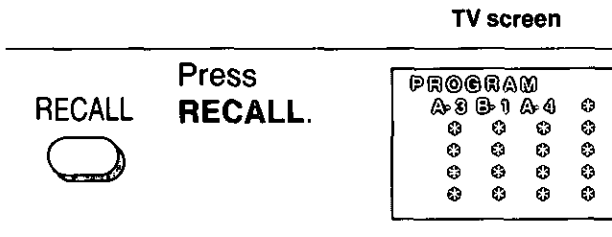

◦ Programmed chapter (or track) numbers display disappears about 20 seconds later.

To add programmed chapters (or tracks)

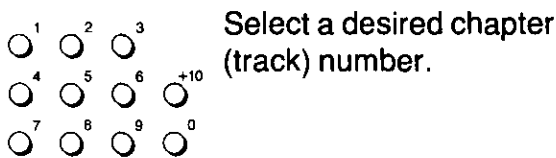

◦ New programmed chapters (or tracks) are added to the last one.

To delete the programmed chapters (or tracks)

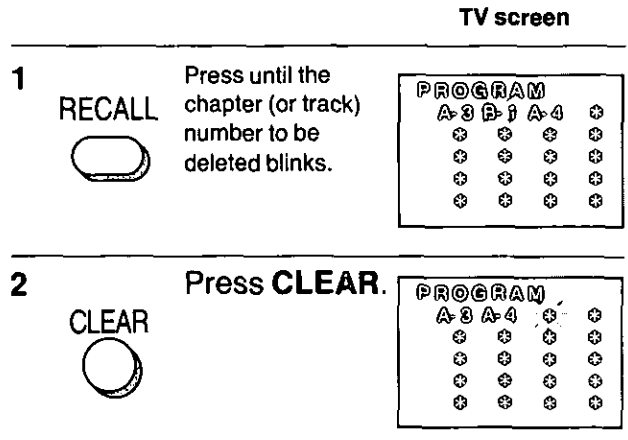

◦ The programmed chapter (or track) is deleted.

Note
The programmed chapter (or track) now being played cannot be deleted.

To delete all programmed chapters (or tracks)
In the stop mode,

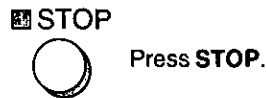

All programmed chapters (or tracks) are deleted when the unit is turned off or the disc is removed.

Search functions

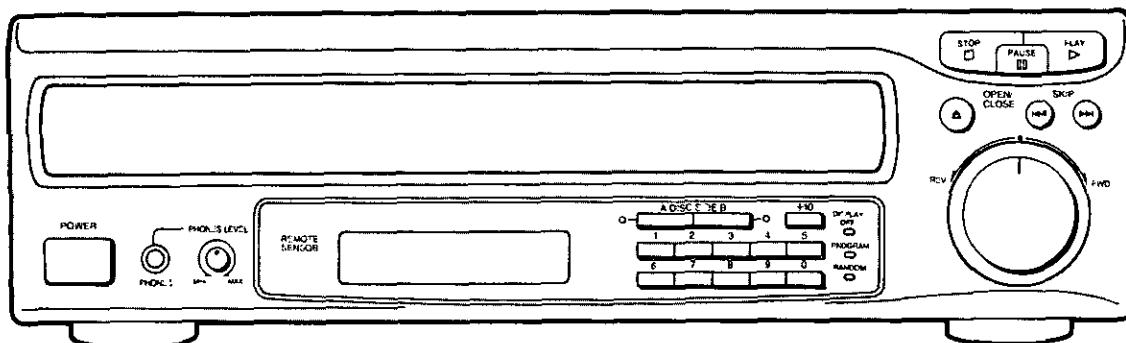

Forward (Reverse) playback using the Shuttle Dial

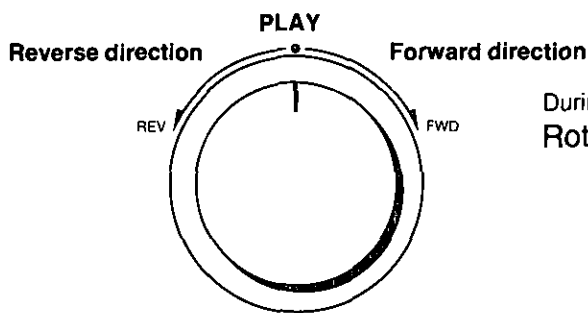
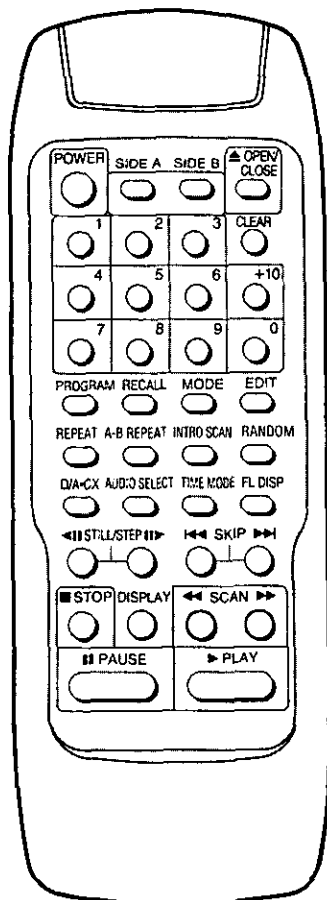

During playback,
Rotate **Shuttle Dial**.

- For about 2 seconds after the Shuttle Dial is rotated clockwise or counterclockwise, the picture will play at a lower speed. After this initial time, the picture will play at a higher speed.
- If you release the Shuttle Dial, it returns to its center position and normal playback resumes.

Forward (Reverse) playback using SCAN on the Remote Control

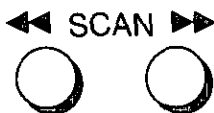

Reverse **Forward**

During playback,
Hold pressed **SCAN**.

- For about 2 seconds after the button is pressed, the picture will play at a lower speed. After this initial time, the picture will play at a higher speed.
- If you release the button, normal playback resumes.







■ Note on CDV

Playback cannot be performed across different parts on a CDV (i.e. video and audio).

Search playback using the Frame Number (Frame Search)

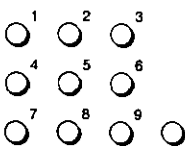
LD (CAV) only

Example) To start playback from frame No. 15000

Procedure	TV screen
1 MODE  During playback, Press MODE .	
2  Enter 1 5 0 0 0 . ◦ If you press a wrong numeric button, press the CLEAR button and then press the correct numeric button again.	
3  Press PLAY . ◦ Playback starts from the designated frame number (15000).	







Note

If an unrecorded frame number is designated, the segment a little before the end of the disc is played.

Search playback using the Time Number (Time Search)

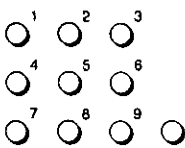
LD (CLV) only

Example) Starting playback at the position "15 minutes" from the beginning of a disc

Procedure	TV screen
1 MODE  During playback, Press MODE .	
2  Enter 1 5 0 0 . ◦ If you press a wrong numeric button, press the CLEAR button and then press the correct numeric button again.	
3  Press PLAY . ◦ Playback starts from the designated time number (15:00).	

Notes

◦ If you use a disc having time numbers recorded only in minutes, playback only starts from the beginning of the designated minute, though seconds was also designated.

◦ If an unrecorded time number is designated, the segment a little before the end of the disc is played.

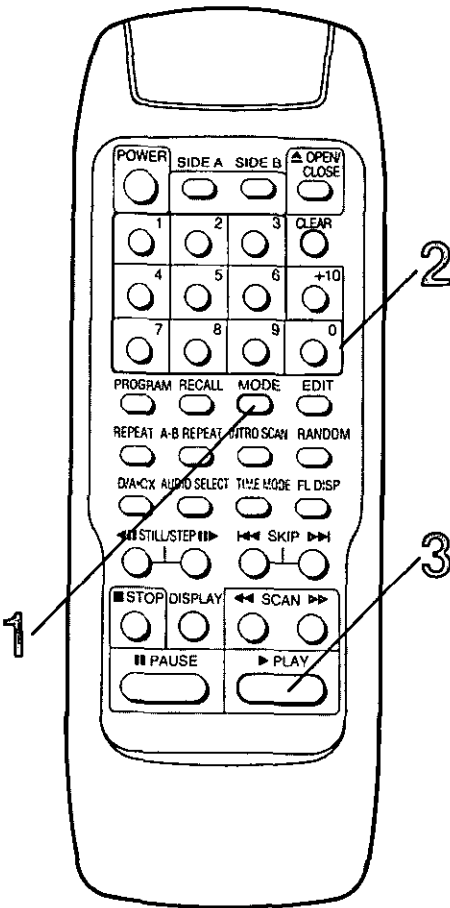

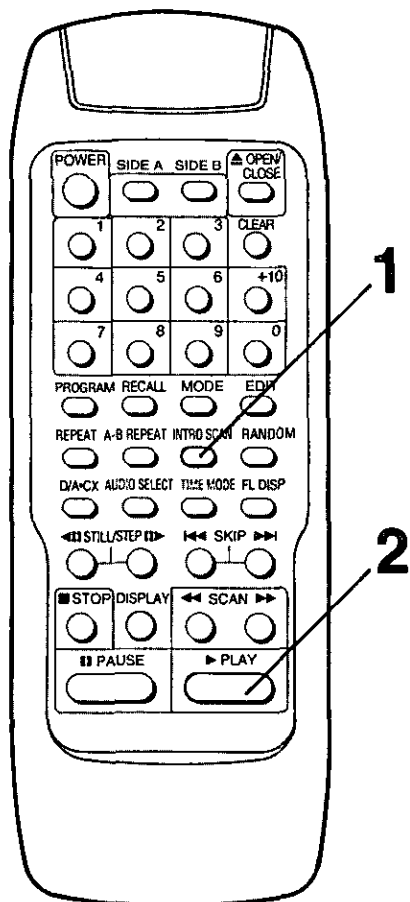

Search functions (continued)

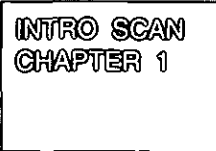

Intro scan playback

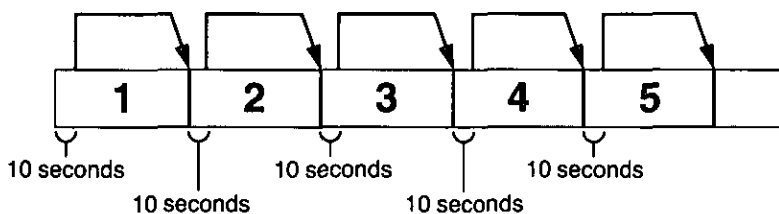
Procedure	TV screen
1 INTRO SCAN  In the stop mode, Press INTRO SCAN . •Beginnings of chapters (or tracks) are played in sequence for about 10 seconds.	



2  At the desired position, Press PLAY . •Normal playback resumes.

•When all chapters (or tracks) are scanned, normal playback continues automatically.

■ Note

The Intro Scan Function is canceled when the SCAN (Forward/Reverse), RANDOM, REPEAT, A-B REPEAT or EDIT buttons are pressed.

■ Note on LD

When an LD onto which no chapter has been recorded is used, the beginning of the disc is played for about 10 seconds and the deck starts normal playback from the beginning of the disc.

Intro scan playback in the programmed order

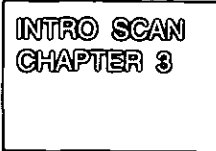
Procedure	TV screen
1 INTRO SCAN  After operating procedures 1–4 on page 14, Press INTRO SCAN . •Beginnings of chapters (or tracks) are played in sequence for about 10 seconds.	

2  At the desired position, Press PLAY . •Normal Programmed Playback resumes.
--

•When all chapters (or tracks) are scanned, normal Programmed Playback continues automatically.

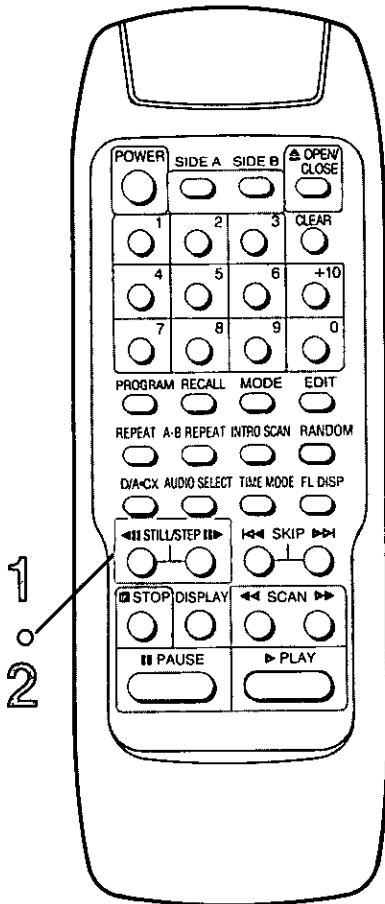

Playback in random order (Random Playback)

TV screen



During playback or in the stop mode,
Press **RANDOM**.
◦The unit plays chapters (or tracks) in random order.

SEARCH RANDOM
CHAPTER 2

Example)

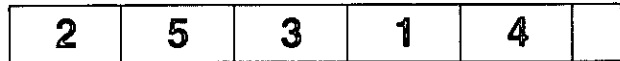

◦After all the chapters (or tracks) are played back, the unit stops.

To resume the normal playback

RANDOM



Press **RANDOM**.

□ **Note on LD**

This function is non-operational when an LD recorded without a TOC is used.

Still Playback and Frame Forward/Reverse Playback

LD (CAV) only

1

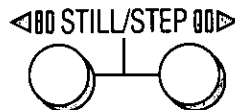

During playback,
Press **STILL/STEP**.
◦Pressing either button performs Still Playback.

2

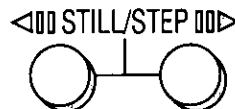

Press **STILL/STEP**.
◦Each time it is pressed, the video frame will either forward or reverse.

Reverse direction Forward direction

To resume the normal playback

▷ **PLAY**



Press **PLAY**.

About discs recorded with an automatic picture stop function

If a disc on which a signal "picture stop code" has been recorded is played using this unit, the Still playback is automatically performed at the frame specified by the picture stop code. If a series of still pictures (video frames) has been recorded on a disc after the point marked with the picture stop code, you can forward or reverse these still pictures (video frames) frame by frame, with the **STILL/STEP** (Forward/Reverse) button. Press the **PLAY** button to resume normal playback.

Various playback (continued)

Repeat Playback

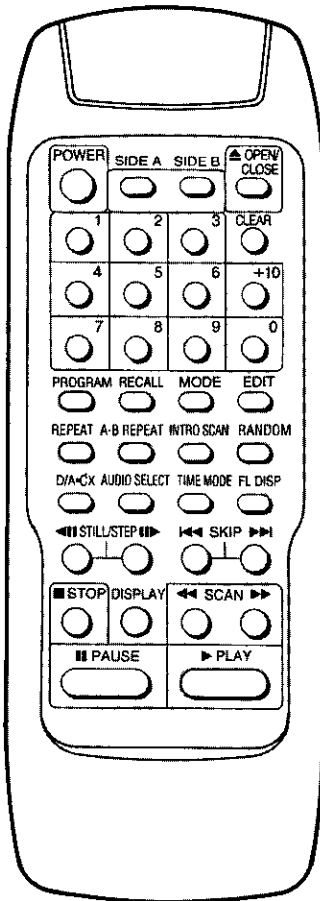

REPEAT



During playback,
Press **REPEAT**.

- Each time this button is pressed, the display on the TV screen changes in the order shown by the arrows in the diagram below.

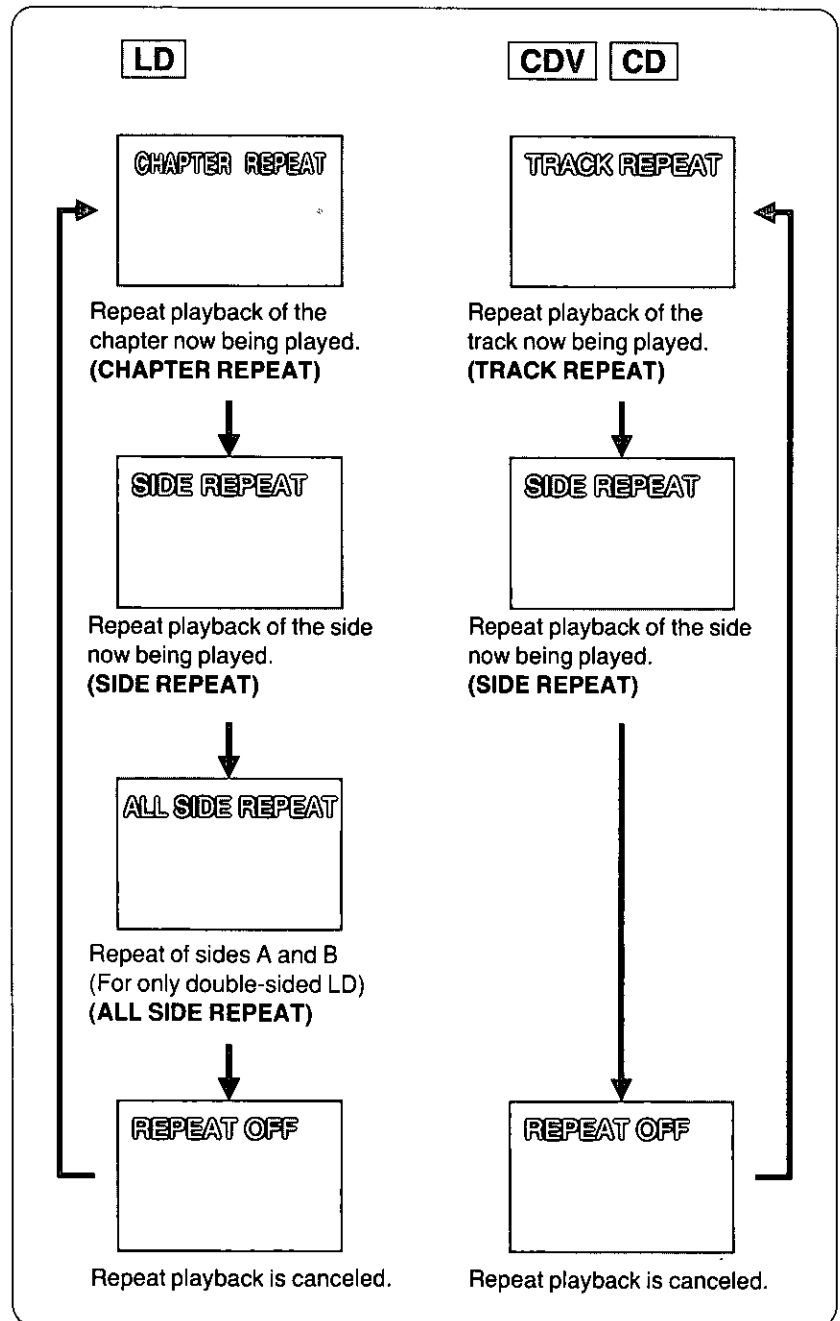

Note on LD

When a disc recorded without chapter number is used, the Side Repeat Playback function is performed by pressing **REPEAT** button.

Programmed Repeat Playback

TV screen

REPEAT 

During Programmed Playback, Press **REPEAT**.

PROGRAM REPEAT

◦ See page 14 on how to program.

To resume the normal playback

PROGRAM  Press **PROGRAM**.

Repeat Playback in a random order (Random Repeat Playback)

TV screen

1 RANDOM  Press **RANDOM**.

SEARCH RANDOM CHAPTER 2

2 REPEAT  Press **REPEAT**.

RANDOM REPEAT

To resume normal playback

Press **RANDOM**.

Note on LD

This function is non-operational when an LD recorded without a TOC is used.

Return to the segment you want to view or listen again (Custom Index Playback)

TV screen

1 A-B REPEAT  During playback, at the position where you want to return, Press **A-B REPEAT**.

A =

2  Press **PLAY**.

SEARCH A = POINT

◦ Playback restarts from the position where you pressed the A-B REPEAT button in step 1.

To resume normal playback

A-B REPEAT  Press twice **A-B REPEAT**.

Notes

- The Custom Index Playback is canceled when any operations other than Play, Pause and SCAN (Forward/Reverse) are performed.
- This function is non-operational during Program playback or Random playback.

Repeat Playback between two designated points (A-B Repeat)

TV screen

A A-B REPEAT  During playback, at the position where you want to start Repeat playback, Press **A-B REPEAT**.

A =

B A-B REPEAT  At the position where you want to stop Repeat playback, Press **A-B REPEAT**.

A = B REPEAT

◦ Repeat playback between points A and B starts.

To resume normal playback

Press **A-B REPEAT**.

The message "A-B OFF" appears on the TV screen.

Notes on LD

- It is not possible to perform the Repeat playback between two designated points of sides A and B. [Double-sided LD only]
- When a CLV (long-play) disc is used, the A and B points are memorized according to the time number recorded on the disc. Therefore, if a CLV disc with the time numbers recorded in minutes is used, the actual start and end points of A-B Repeat playback may not match exactly as selected.

Note on CDV

A-B Repeat playback cannot be performed across different parts on a CDV (i.e. video and audio).

Recording from a disc to a tape

Preparation:

1. Make connections and adjustments of audio components. See page 6 for further information about connecting other components.
2. Insert a cassette tape with the erasure protection tab intact.
3. Load a disc in the unit and press the **STOP** button to set the unit to the stop mode.

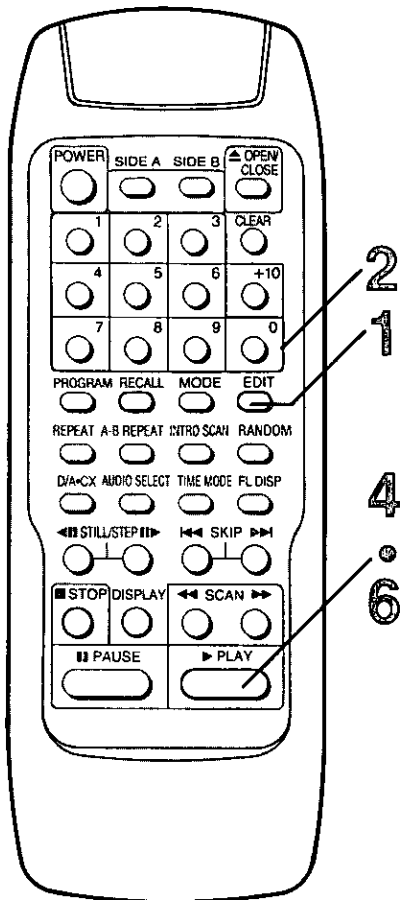

Editing in the prerecorded order of the disc



Example) To record from a disc onto a 46-minute tape.

Procedure

TV screen

1 Press **EDIT**.

EDIT



AUDIO 7 46:40
 EDIT
 TAPE TIME C-0

2 Press **④** and **⑥**.

- It is possible to select a recording time of up to 99 minutes.
- If you press a wrong numeric button, press the **STOP** button and then repeat steps 1 and 2.

④ **⑥**

This unit automatically assigns chapters (or tracks) to be recorded onto each side (side A and side B) of the cassette tape by calculating the playing time of each chapter (or track).
 It is possible to edit up to 20 chapters (or tracks).

Tape Time Indication

C-46
 EDIT 1 2 3 4 5 6 7 8

AUDIO 7 46:40
 EDIT
 TAPE TIME C-46

Number of chapters (or tracks) to be recorded onto side A Remaining tape time on side A

Tape Side Indication

4 No. 4 1:02
 EDIT 1 2 3 4 5 6 7 8

EDIT [C-46]
 A1 A2 A3 A4
 B5 B6 B7 B8
 * * * *
 * * * *

Chapter (or track) numbers to be recorded on side A Chapter (or track) numbers to be recorded on side B

3 Set your tape deck to the record mode.

4 Press **PLAY**.

- Recording starts on side A of the cassette tape.
- When side A recording is finished, the unit temporarily will be in the pause mode at the beginning of the first chapter (or track) to be recorded on side B.

▶ PLAY



SEARCH EDIT
 TRACK 1

5 Prepare side B for recording on a cassette deck.

6 Press **PLAY**.

- Recording starts on side B of the cassette tape.
- When side B recording is finished, the unit stops.

▶ PLAY

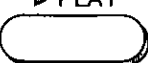

Notes

- If you do not use a cassette tape having enough recording time, all chapters (or tracks) cannot be recorded.
- During tape recording, all operation buttons other than the DISPLAY, TIME MODE, RECALL and FL DISP buttons are non-operational.
- If the playing time of the first chapter (or track) on a disc is longer than one half the time of the specified recording time (e.g. if the first chapter (or track) is longer than 23 minutes of side A when a 46-minute recording tape is used), nothing can be recorded since the chapter (or track) time is longer than the tape recording time. To avoid this, use a cassette tape having enough recording time for editing.

Notes on LD

- This function is non-operational when an LD recorded without a TOC is used.
- Chapter "0" on a disc cannot be recorded.

To interrupt tape recording

STOP



Press **STOP**.

- Pressing it again cancels the EDIT function. The EDIT function is also canceled if the unit is turned off or the disc is removed from the unit.

Checking of the remaining tape time of side B



In the stop mode, Press **EDIT**.

- Each time this button is pressed, the remaining tape time on side A and B is alternately displayed.

Number of chapters (or tracks) which can be recorded on side B Remaining tape time of side B

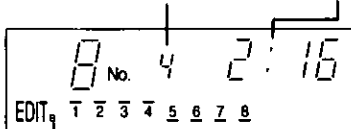

Tape Side Indication

Checking the recorded chapters (or tracks)

TV screen

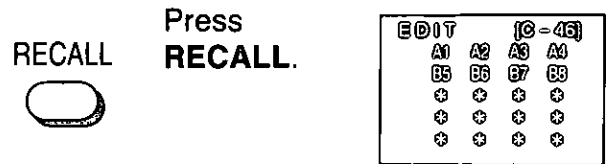

- A list of the recorded chapters (or tracks) is displayed. It disappears after about 20 seconds.

Recording in a programmed order (Programmed Editing)



- 1 After steps 1–4 on page 14, Press **EDIT**.



- 2 Follow operation procedures from steps 2–6 on the previous page.

Note

If you do not use a cassette tape having enough recording time, some programmed tracks will be cut.

Audio channel selection

Discs with stereo sound or bilingual audio

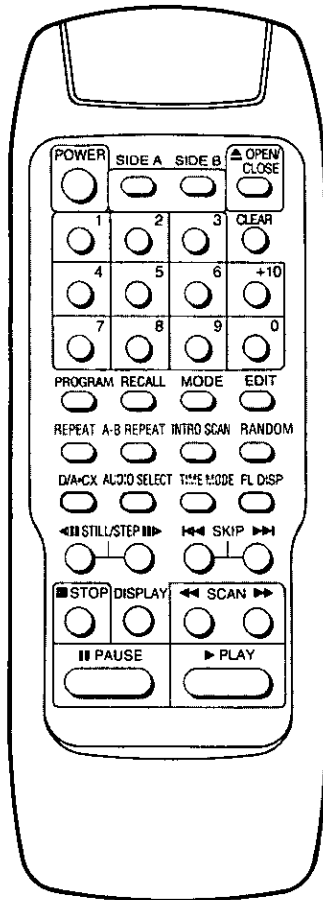

AUDIO SELECT



Press **AUDIO SELECT**.

- Each time this button is pressed, the audio channel output from the speakers changes as shown in the table.

TV screen	Stereo disc	Bilingual disc
STEREO	Stereo sound	Hello Bonjour Main audio Sub audio
AUDIO 1 / L	Left channel audio	Hello Hello Main audio
AUDIO 2 / R	Right channel audio	Bonjour Bonjour Sub audio

Discs with digital audio

LD only

D/A•CX



Press **D/A•CX**.

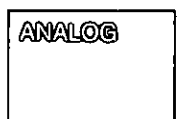
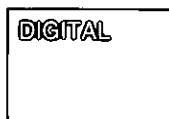

- Each time this button is pressed, the audio output through the audio output terminal (on the rear of the unit) alternately changes from digital to analog.
- Some discs change in the following order each time this button is pressed:

DIGITAL → ANALOG → CX OFF

"ANALOG" indicates that the CX noise reduction system of the analog audio functions, and "CX OFF" indicates that this system does not function.

Note

When a disc is recorded with different levels of digital and audio signals, the volume level changes when the D/A•CX button is pressed to select digital or analog audio.

is a trademark of CBS Corporation.

The CX noise reduction system reproduces powerful sound with minimum noise. This unit conforms with the extended specifications for the CX noise reduction system.

Note

If a disc not bearing the CX symbol is played with the "CX ON" display on the TV screen, the sound quality will be inferior.

Discs bearing CX mark



LD only

D/A•CX



Press **D/A•CX**.

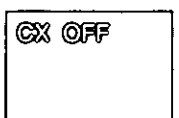
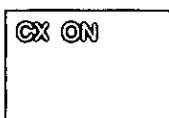

- Since almost all discs bearing the CX symbol automatically operate the CX noise reduction system, it is not necessary for you to operate this button. However, if the CX noise reduction system does not function automatically, press this button to display the indication "CX ON" on the TV screen.

Multi-function display

Audio channel selection
Multi-function display

The indicators on the Multi-Function Display light up or blink depending on the operational mode. The illustration below shows all possible indicators.

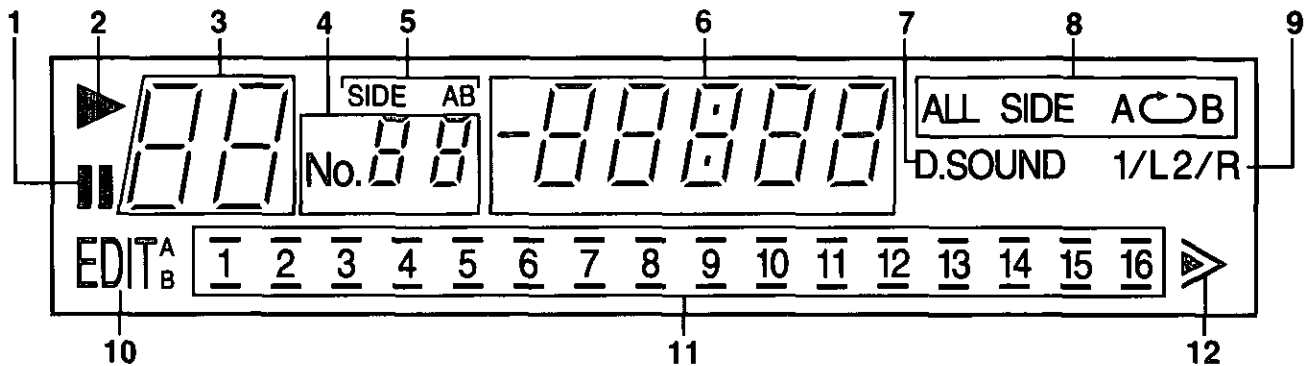

Description of indicators



- 1 **Temporary interruption** (pause operation)
- 2 **All playback operation**
- 3 **Chapter (or track) number**
- 4 **Index number**
Program number (during Programmed Playback)
- 5 **Side being played** (For LD only)
- 6 **Frame number** [LD (CAV)]
Time number [LD (CLV), CDV, or CD]
Message (See "Messages" at right on this page.)
- 7 **Digital sound output**
- 8 **Various playback operation** (See "Various playback indications" at right on this page.)
- 9 **Audio channel**
- 10 **Editing** (Tape recording)
- 11 **Chapter (or track) numbers**
 - Chapter (or track) numbers recorded on a disc are displayed.
 - Bars above and below the chapter (or track) number are lit and the bar goes out by one as the corresponding playback is finished.
 - When an LD recorded without a TOC is used, the corresponding bar of a chapter now being played lights up.
 - During Program playback of the double-sided LD, the bar above the chapter number is lit to indicate the corresponding number being played on side A, and the bar below indicates the corresponding number being played on side B.
 - Chapter number "0" is not displayed.
- 12 **Over Mark**
 - When a disc on which 17 chapters (or tracks) or more have been recorded is used, the indication ">" is lit. If the 17th or the subsequent chapter (or track) is played, the ">" is lit.

Messages

 The following messages are displayed in the shaded area.

- OPEN** The Disc Tray is open.
- CLOSE** The Disc Tray is now being closed.
- PLAY** Playback starts. (Only for LD)
- A—B** Side to be played is being changed from side A to side B.
- B—A** Side to be played is being changed from side B to side A.
- OFF** Power is turned off.

Various playback indications

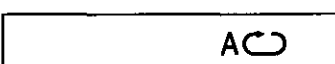
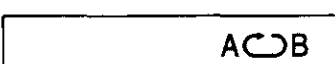
-  Chapter (or track) repeat
-  Side repeat
-  All side repeat
-  Custom index
-  A-B repeat

Turning off the Multi-Function Display

- Press FL DISP.**
- The DISPLAY OFF indicator on the front panel of the unit lights up when the Multi-Function Display is turned off.
 - The TV screen becomes black from blue when the unit is in the stop or pause mode.

To turn on the Multi-Function Display

- FL DISP.**
-  Press **FL DISP.**

On screen display

When the TV is turned on (even if a CDV or a CD is played), information about the track being played, (i.e. elapsed playing time, or the operation mode of the unit) is displayed on the TV screen.

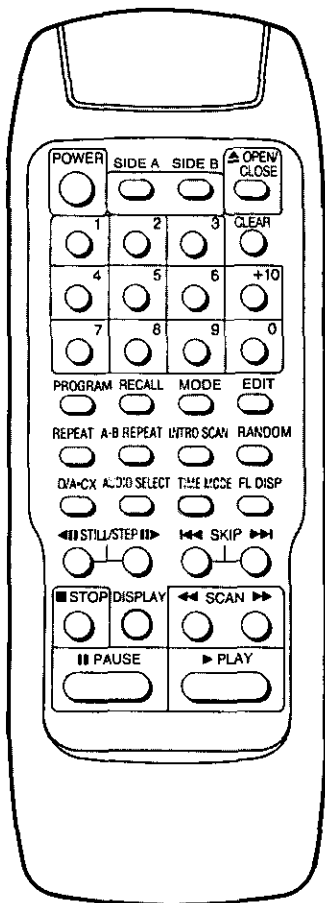

Displaying a list of recordings on a disc

A disc is loaded.

- The TOC signals are being read.
(except an LD recorded without a TOC)

TV screen



The unit is set to the stop mode.

LD with a TOC signal

Total number of recorded chapters and their total playing time

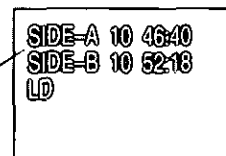

- Chapter number "0" is not displayed.
- When an LD recorded without a TOC is used, no display appears.
- To get information on the contents of side B, press **SIDE B Button**. After the message "TOC READ" is displayed on the screen, press **STOP Button**.

CDV

Total number of tracks of audio part and their total playing time

Total number of tracks of video part and their total playing time

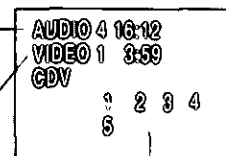

Recorded track Nos.

CD

Total number of tracks and their total playing time

Recorded track Nos.

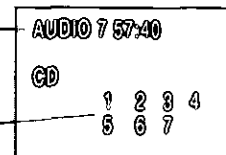

Displaying information of a chapter (or track) now being played

Press **DISPLAY**.

DISPLAY



The following information [a chapter (or track) No. being played, a frame (or time) No., an index No. and playing elapsed time of a track] is displayed on the TV screen according to the type of disc being used.

LD (CAV)

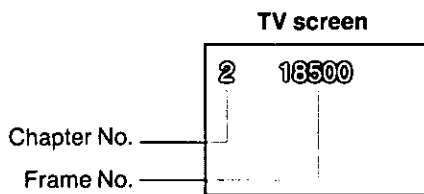

- When a disc on which no chapter has been recorded is used, the unit cannot display the chapter number.
- Pressing it again turns off the display.

LD (CLV)

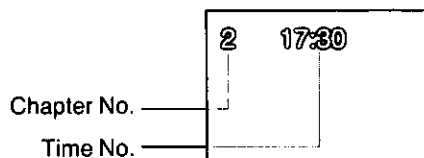

- When a disc whose playing elapsed time has been recorded only in minutes is used, the unit cannot display the elapsed time in seconds.
- Pressing it again turns off the display.

CDV, CD

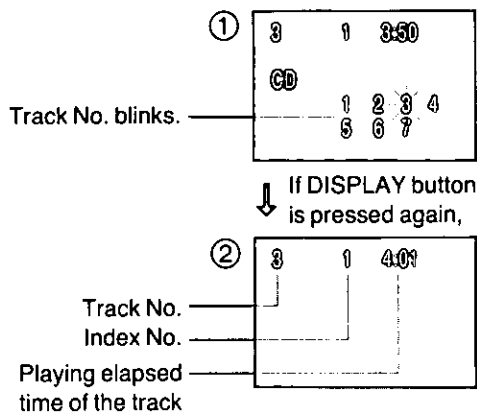

- Pressing once more turns off the display.
- Display ① is not shown during playback of a CDV's video part.

Changing the time information display

Press **TIME MODE**.

TIME MODE



- Each time the button is pressed, the time displayed changes in the following order.

Multi-Function Display

TV screen

- ① Total remaining time of a disc

-38:51

- 38 : 51
TOTAL REMAIN

- ② Remaining track time now being played

3 - 2:31

3 - 2 : 31
TRACK REMAIN

- ③ Total elapsed playing time of a disc

12:32

12 : 32
TOTAL TIME

- ④ List of recordings of a disc [number of chapters (or tracks) and total recorded time]

7 52:42

AUDIO 7 52:42

- ⑤ Elapsed playing time of a track now being played

3 1 2:32

3 1 2 : 32
TRACK TIME

To turn off the display
Press **DISPLAY**.

Note on LD

- When an LD recorded with a TOC is used, on screen displays ④ and ⑤ are shown alternately.
- The total elapsed playing time from the beginning of the disc is displayed on display ⑤.
- This function is non-operational when an LD recorded without a TOC is used.

Notes on CDV and CD

- The on screen display changes in the following order during Random Playback: ②→④→⑤→②
- The time information displayed may differ from that which is supplied with the disc.

Helpful Hints

Precautions for use

Cautions for safety

To avoid any malfunctions of the unit, and to protect against electric shock, fire or personal injury, please observe the following.

Hold the plug firmly when connecting or disconnecting the AC power cord.

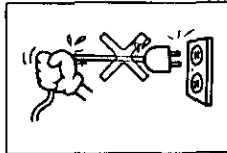

Keep the AC power cord away from heating appliances.

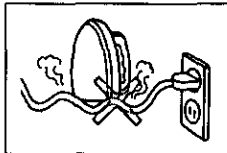

Never put any heavy object on the AC power cord.

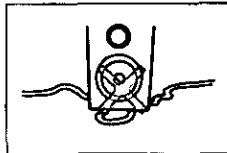

Do not attempt to repair or reconstruct the AC power cord in any way.

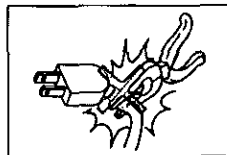

Keep the unit away from any liquids.

If water is spilled on/into the unit, malfunctions, electric shock or fire may possibly occur.

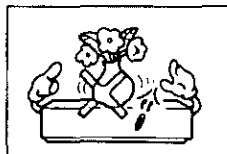

Do not remove the outer panel.

- Touching any internal parts of the unit is dangerous.
- Do not insert any foreign object into the unit.

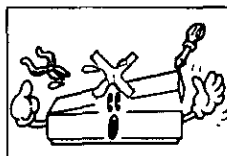

Do not put any foreign object on the Disc Tray.

Never permit children to place anything in the Disc Tray.

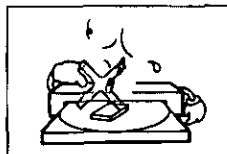

Do not use the unit when there is lightning.

- If this occurs, immediately unplug the AC power cord from the AC outlet.
- Exterior electric influences such as lightning and static electricity can affect normal operation of the unit. If this occurs, turn the power off and on using the POWER button, or unplug the AC power cord and reconnect it to an AC outlet. The unit will operate normally.

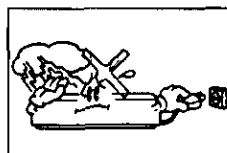

Handling cautions

Do not place anything heavy on the unit.

Do not place a TV on the unit.

Keep the unit away from insecticides or volatile substances.

Do not let the unit's cabinet touch rubber or vinyl material for long periods of time.

These materials may cause discoloration and surface damage to the unit.

When moving the unit,

- Make sure that the unit is disconnected from all connection cords.
- Do not subject it to strong impact.
- When moving this unit long distances, wrap it up carefully in a blanket or rug to prevent it from being scratched.

After using the unit,

Be sure to remove the disc from the unit and turn it off.

When the unit is not in use for long periods of time,

- Be sure to disconnect the AC power cord from the AC outlet. If the unit is left connected to the AC outlet, power of about 6 W is consumed.
- Turn on the unit occasionally to keep the unit's mechanical parts in optimal condition.

Notes for installation

Place the unit on an even and stable place that is well ventilated.

The rear panel becomes hot during operation, but this is not a malfunction.

Do not place the unit in the following places:

- In a room exposed to direct sunlight for long periods of time.
- Where there is steam or soot.
- Where there is dust or high humidity.
- Near a strong light source or heating appliance.
- Where there is a strongly magnetized object.

If the unit is placed near the TV:

The picture and audio may be adversely affected during playback of the unit. If this occurs, place the unit farther away from the TV.

Maintenance of cabinet

Wipe the cabinet and operation panel of the unit with a soft cloth.

- For persistent stains, use a soft cloth moistened with mild detergent and water, and then wipe with a dry cloth.
- If you use a chemically treated cloth for cleaning, read the directions carefully.

If there is noise interference on the TV while a broadcast is being received

Depending on the reception condition of the TV, interference may appear on the TV screen while you watch a TV broadcast and the unit is left on. This is not a malfunction of the unit or the TV. To watch a TV broadcast, turn off the unit.

Formation of condensation in the unit

- Condensation (dew, so-called "sweating") may form if warm air comes in contact with any cold parts inside the unit, due to sharp changes in temperature and humidity (for example on a window in a heated room in the winter).
- When condensation forms inside the unit, the unit may not operate correctly. However, when the condensation is dissolved, the unit will operate normally.
- If condensation forms inside the unit and the unit cannot operate correctly, leave the unit at room temperature until the unit becomes operational. Depending on the surrounding condition, this may take 1 or 2 hours.
- Since there is the possibility that condensation forms on the disc inside the unit, wipe the disc with a soft and dry cloth by moving the cloth from the center hole toward the outer edge.

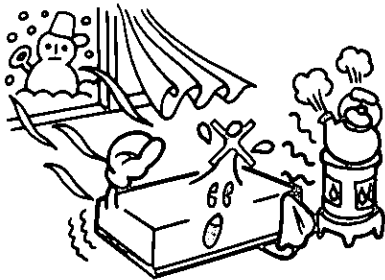

Notes for Disc

- Never use cracked or deformed (warped) discs.**
- Since the disc rotates at high speed, the use of cracked or deformed (warped) discs is dangerous. Never attempt to repair a broken disc with adhesive tape or glue and then use it. This will damage the unit.
 - Should a strange noise or vibration be heard or occur after playback is started, i.e. the disc does not rotate smoothly, immediately press STOP Button.

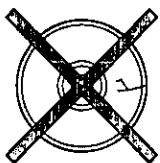

Cracked

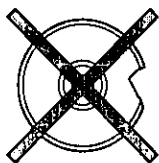

Chipped

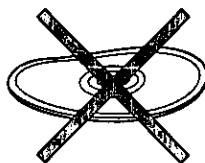

Deformed (warped)

Place one disc in the Disc Tray according to the proper recession guide.

- Never place two discs in the Disc Tray and never attempt playback with a disc that has slipped out of the recession.
- Be careful not to drop a small-sized CD into the unit.

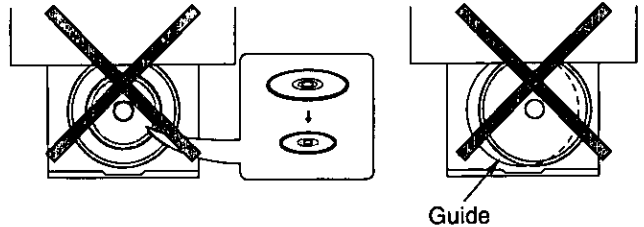

Two discs

Slipped out of place

Notes for Storage

- After use, remove the disc from the unit and put the disc into its case and store it in a vertical position. Storing discs in a slanted or stacked position may cause them to become warped.
- Do not store the discs in places exposed to direct sunlight, high temperature or high humidity.
- Never attempt to stick a label on a disc.
- Be careful not to scratch the disc surface.

Maintenance

- To clean a disc soiled with fingerprints or smudges, use a soft and dry cloth.
- If the surface is extremely dirty, dip a soft cloth into water and wring the cloth well before wiping the disc. Then wipe again with a soft and dry cloth.
- When wiping discs, always move the cloth from the center hole toward the outer edge. (If you wipe the discs using a circular motion, circular scratches are likely to occur. This will cause noise on the disc.)

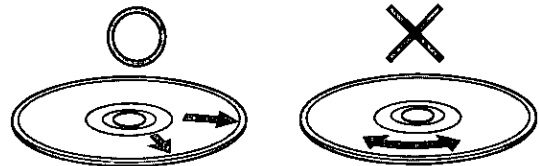

- Do not use benzene, thinner, a record cleaner, nor an antistatic agent.

Other Notes

- Since this unit conforms with the NTSC color TV system, discs with other color TV systems (PAL or SECAM) cannot be used.
- This unit does not correspond to CD Graphics and CD-ROM specifications.
- CED and VHD system video discs cannot be used.
- Do not use a CD stabilizer and a disc backed by aluminum.
- Your attention is drawn to the fact that recording, broadcasting, showing, playing to the public, and rental of prerecorded discs and tapes or other published or broadcast material may infringe on copyright laws.

Before requesting service

Problem	Suggested Remedy or Remark
Power	
The unit is not turned on.	<ul style="list-style-type: none"> • Connect the AC power cord plug to an AC outlet correctly.
The Disc Tray does not open.	<ul style="list-style-type: none"> • Turn on the unit.
Playback	
Playback does not start when PLAY button is pressed. Playback stops immediately after PLAY button is pressed.	<ul style="list-style-type: none"> • Load the disc correctly with the side to be played facing up. • The disc is dirty. Wipe it with a soft and clean cloth. • If the disc is deformed (warped, cracked or chipped), the unit cannot play the disc. • Condensation has formed inside the unit. Leave the unit at room temperature for 1 or 2 hours.
Playback of side B does not start.	<ul style="list-style-type: none"> • When the LD single-sided disc, CDV or CD is used, it is not possible to play the reverse side.
Frame Search cannot be performed.	<ul style="list-style-type: none"> • This function does not work on CLV (long-play LD) disc, CDV or CD.
Time Search cannot be performed.	<ul style="list-style-type: none"> • This function does not work on CAV (standard LD) disc, CDV or CD.
Video	
No picture. Picture is obscure or unstable.	<ul style="list-style-type: none"> • Make connections correctly. • Turn on the TV. • Make the correct input selection on the TV. • Keep the speakers away from the TV if the speakers are close to the TV. • The disc is dirty. Wipe it with a soft and clean cloth.
Picture is distorted/unstable during SCAN Forward/Reverse.	<ul style="list-style-type: none"> • SCAN (Forward/Reverse) playback generates a slight distortion, but this is not a malfunction.
Still playback or frame forward/reverse cannot be performed.	<ul style="list-style-type: none"> • These functions do not work on CLV (long-play LD) disc or CDV.
Audio	
No sound is reproduced. The sound can hardly be heard.	<ul style="list-style-type: none"> • Make connections correctly. • Make the correct audio input selection and volume adjustment on the TV or components of the stereo system (amplifier or AV selector). • No sound is reproduced during Pause, Still playback or Frame forward/Reverse playback. • The disc is dirty. Wipe it with a soft and clean cloth. • When a disc without the CX symbol is used, press the D/A • CX button to set it to "CX OFF".

Problem	Suggested Remedy or Remark
Editing	
Tape editing cannot be performed.	<ul style="list-style-type: none"> ◦Editing of LD recorded without a TOC cannot be performed. ◦This function does not work on CDV. ◦Programmed editing (editing of tracks in a programmed order) can be performed only when a CD is used. ◦If the playing time of the first chapter (or track) on a disc is longer than one half the time of the specified recording time [e.g. if the first chapter (or track) is longer than 23 minutes of side A when a 46-minute recording tape is used], nothing can be recorded. Use a cassette tape having enough recording time for editing.
Editing of all tracks cannot be made.	<ul style="list-style-type: none"> ◦Use a cassette tape having enough recording time for editing of all chapters (or tracks). ◦It is impossible to edit more than 20 chapters (or tracks).
Remote Control	
Operation is not possible.	<ul style="list-style-type: none"> ◦Load batteries with their polarities (+ and -) aligned correctly. ◦Batteries are low. Replace with new ones. ◦Point the Remote Control at the Remote Sensor of the unit. ◦Operate the Remote Control within 7 m from the Remote Sensor of the unit. ◦Remove an obstacle between the Remote Control and the Remote Sensor of the unit.

Self-Diagnosable Function for Error Message Display

This unit has a self-diagnosable function which detects a problem or malfunction within the unit and displays its corresponding error message on the display of the unit. Please refer to the table shown below when an error message occurs.

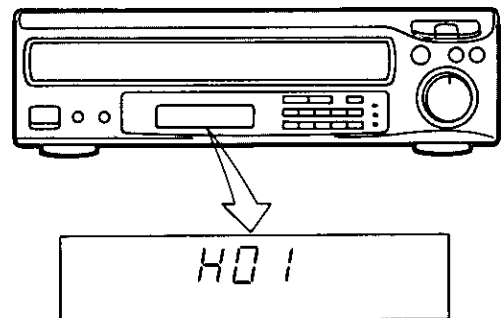

Error Message	Problem	Remedy
<p>U 1 0</p> <p>F 1 0</p>	<ul style="list-style-type: none"> ◦The disc is loaded with the wrong side down. ◦The disc is dirty. 	<ul style="list-style-type: none"> ◦Load the disc correctly with the side to be played facing up. ◦Wipe it with a soft and clean cloth.
<p>U 1 1</p>	<ul style="list-style-type: none"> ◦The disc is dirty. 	<ul style="list-style-type: none"> ◦Wipe it with a soft and clean cloth.
<p>H □ □</p>	<ul style="list-style-type: none"> ◦It is considered that the unit is not functioning properly. The numeric characters displayed after "H" or "F" varies depending on the malfunctioning condition. 	<ul style="list-style-type: none"> ◦Turn the unit off and on again by pressing the POWER Button twice, or disconnect and then reconnect the AC Power Cord of the unit to the AC outlet. (These operations will make the unit operate normally if external electrical influences such as lightning or static electricity have affected the operation of the unit.)
<p>F □ □</p>		



Specifications

Power Source: AC 120 V 50–60 Hz
Power Consumption: 36 W (Power off, approx. 6 W)

Television System: NTSC
Format: Laser Vision Video Disc System
Weight: 18.04 lbs. (8.2 kg)
Outer Dimensions: 16⁵/₁₆" (W)×5" (H)×16" (D) [430 (W)×127 (H)×405 (D) mm]
(Protruding parts are not included.)

Allowable Operating Temperature: +5–+35°C (+41–+95°F)
Allowable Operating Humidity: 5–90% (provided that no condensation forms)

Disc Format:

- (1) Laser Vision Disc
 - 12" (30 cm) Long Play Disc (CLV) 1800–600 rpm, 2-hour playing time (max.) on double sides
 - 12" (30 cm) Standard Play Disc (CAV) 1800 rpm, 1-hour playing time (max.) on double sides
 - 8" (20 cm) Long Play Disc (CLV) 40-minute playing time (max.) on double sides
20-minute playing time (max.) on single side
 - 8" (20 cm) Standard Play Disc (CAV) 28-minute playing time (max.) on double sides
14-minute playing time (max.) on single side
- (2) Compact Disc
 - 5" (12 cm) Disc 500–200 rpm, 74-minute playing time (max.) on single side
 - 3" (8 cm) Disc 500–300 rpm, 20-minute playing time (max.) on single side
- (3) Compact Disc with Video
 - Video part 2700–1800 rpm, 5-minute playing time (max.) on single side
 - Audio part 500–300 rpm, 20-minute playing time (max.) on single side

S-Video Output (Y/C Separate Terminal): Y Output; 1 Vp-p (with 75Ω, negative polarity sync.)
C Output; 0.286 Vp-p

Video Signal Output: 1 Vp-p (with 75Ω, negative polarity sync.)

Audio Signal Output: (1) Digital audio output; 200 mVrms (1 kHz, –20 dB)
(2) Analog audio output; 200 mVrms (1 kHz, 40% modulated)

Digital Audio Signal Output Characteristic:

- (1) Frequency response; 4 Hz–20 kHz (EIAJ)
- (2) S/N ratio; 115 dB (EIAJ)
- (3) Dynamic range; 96 dB (EIAJ)
- (4) Wow and flutter; Below measurable limit
- (5) Total harmonic distortion; 0.003% (EIAJ) 1 kHz

Headphone Connector: 32Ω (30 mW), impedance; 8Ω or more

Digital RF Output Connector: 1 system

Matsushita Consumer Electronics Company, Division of Matsushita Electric Corporation of America
One Panasonic Way Secaucus, New Jersey 07094

Panasonic Sales Company, Division of Matsushita Electric of Puerto Rico, Inc. ("PSC")
Ave. 65 de Infanteria, Km. 9.5 San Gabriel Industrial Park, Carolina, Puerto Rico 00985

Matsushita Electric of Canada Limited
5770 Ambler Drive, Mississauga, Ontario L4W 2T3

Printed in Japan



VQT6436
F1295Y0-1000 Ⓐ

Free Manuals Download Website

<http://myh66.com>

<http://usermanuals.us>

<http://www.somanuals.com>

<http://www.4manuals.cc>

<http://www.manual-lib.com>

<http://www.404manual.com>

<http://www.luxmanual.com>

<http://aubethermostatmanual.com>

Golf course search by state

<http://golfingnear.com>

Email search by domain

<http://emailbydomain.com>

Auto manuals search

<http://auto.somanuals.com>

TV manuals search

<http://tv.somanuals.com>