

Panasonic®



Operating Instructions

IP Conferencing Phone

Model No. **KX-NT700**



Thank you for purchasing this Panasonic product.
Please read this document carefully before using this product and save for future use.



KX-NT700: Version 1.1 or later

Document Version 2008/10

Download from Www.Somanuals.com. All Manuals Search And Download.

Introduction

Connection to a Panasonic Pure IP-PBX (IP-PBX Mode)

The unit can be connected to a Panasonic KX-TDE or KX-NCP series PBX and used as a SIP extension. This allows you to make and receive calls using the outside lines and IP network connected to the PBX, call other extensions of the PBX by dialing their extension numbers, participate in conference calls with 4 or more other participants, etc.

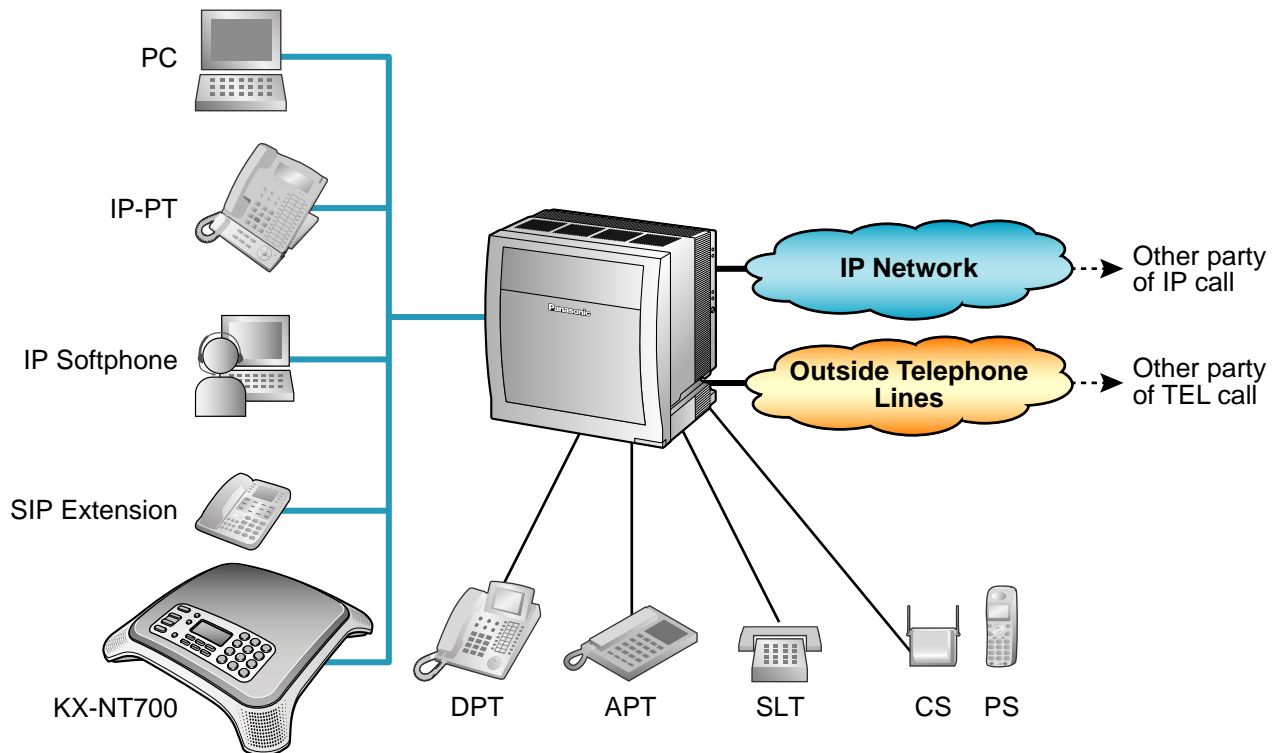

The following features are available when the unit is used as a SIP extension. Refer to the PBX documentation for details.

- Account Code Entry
- Automatic Route Selection (ARS)
- Conference (as a member only)
- DND Override
- Doorphone Call
- Extension Block
- Operator Call
- Personal Speed Dialing
- Redial
- S-CO Line Access
- System Speed Dialing
- TIE Line Call
- Trunk Group Access

Standard Connection Methods

Allow you to make and receive peer to peer IP calls, TEL calls, and PS or PC calls.

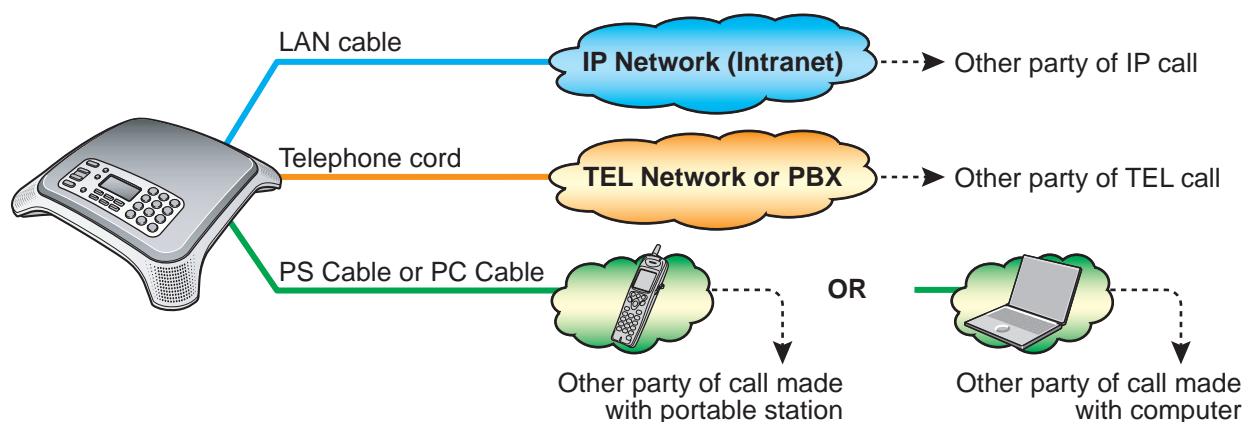

Connection to an IP Network (Intranet) and/or Panasonic Pure IP-PBX

Allows you to make and receive calls over an IP network.

In this document, this connection method is referred to as the "IP line", and calls made using the IP line are referred to as "IP calls". There are 2 modes for making and receiving IP calls. When using IP-PBX mode (see page 2), the unit can make and receive IP calls as a SIP extension of a Panasonic KX-TDE or KX-NCP series PBX. When using peer to peer mode, the unit communicates directly with the other party's device.

Connection to an Analog Telephone Network or PBX

Allows you to make and receive traditional phone calls.

In this document, this connection method is referred to as the "TEL line", and calls made using the TEL line are referred to as "TEL calls".

Connection to a Compatible Panasonic Portable Station

By connecting the unit to a compatible Panasonic Portable Station (PS) using the included PS Cable, you can use the microphones and speaker of the unit for calls made or received with the PS.

In this document, this connection method is referred to as the "PS line", and calls made using the PS line are referred to as "PS calls".

Connection to a Computer

By connecting the unit to a computer using the included PC Cable, you can use the microphones and speaker of the unit for calls made or received with the computer using your preferred IP phone software.

In this document, this connection method is referred to as the "PC line", and calls made using the PC line are referred to as "PC calls".

Other Features

Conference Calls

While on a call, you can make or receive an additional call, creating a 3-party conference call (see page 33 or page 34). Conference calls can be made using the following connection methods.

2 IP calls (Peer to peer mode only)

While **1** and **2** are talking, **1** calls or is called by **3**.

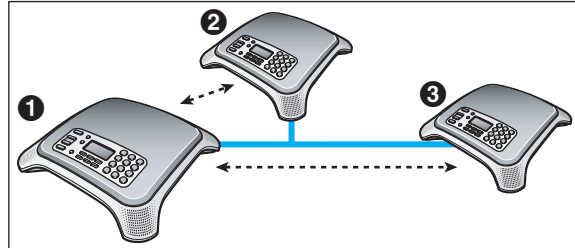

1 IP call and 1 TEL call

While **1** and **2** are talking, **1** calls or is called by **3**.

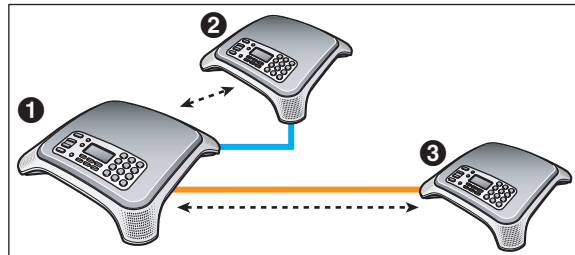

1 IP call and 1 PS call or 1 PC call

While **1** and **2** are talking, **1** uses a PS or computer to call **3**.

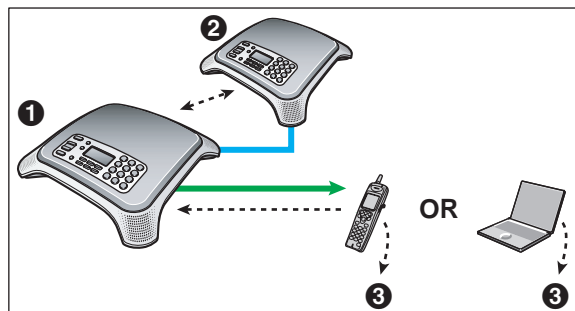

High-quality Audio

The unit provides unparalleled audio quality and features, including:

- G.722 speech codec support (Peer to peer mode only)
- full-duplex communication
- speech speed conversion (see page 35)
- mic noise reduction (see page 35)
- External Wired MIC connection (see page 28)

SD Memory Card Recording

Phone calls and voice memos can be recorded to, and played back from, a compatible SD memory card (see page 39).

PoE (Power over Ethernet) Ready

The unit is compliant with PoE (IEEE 802.3af) standards, and contains a power receiving device that enables it to receive power from the same Ethernet cable used for IP network connection. This allows you to use the unit in locations where there is no AC outlet nearby, saving you the cost of installing a new AC outlet. PoE connection requires a PoE-compliant hub or similar device. The included AC adaptor can be used instead of a PoE connection if you want to connect the unit to a standard AC outlet.

Conferencing Phone Manager Software Features

The unit can be used in conjunction with Conferencing Phone Manager. This software can be found on the included CD-ROM, and allows you to operate and program the unit using a computer (see page 57).

Other Information

Included Documentation

Quick Reference Guide

Briefly describes how to connect the unit and introduces commonly used features.

Operating Instructions (this document)

Describes how to connect, use, program, and maintain the unit.

Note

- Certain products and features described in this document may not be available in your area. Consult a certified Panasonic dealer for more information.

PBX Connection

- If the unit is connected to a PBX, refer to the PBX documentation for information about making calls, receiving calls, and other features.
- Do not connect the unit to an analog telephone line to which other telephones are connected.

Computer Screen Shots

- Microsoft product screen shot(s) reprinted with permission from Microsoft Corporation.
- Screen shots in this document were captured using Microsoft Windows XP, and are provided for reference only.

Trademarks

- SD logo is a trademark.
- Microsoft®, Windows®, Windows Vista®, and Windows Media® are either registered trademarks or trademarks of Microsoft Corporation in the United States and/or other countries.
- Windows XP refers to the Microsoft Windows XP operating system.
- QuickTime® is a trademark of Apple Inc., registered in the U.S. and other countries.
- Intel®, Pentium®, and Celeron® are trademarks or registered trademarks of Intel Corporation in the United States and other countries.
- All other trademarks identified herein are the property of their respective owners.

MD5 Copyright Notice

This software uses the Source Code of RSA Data Security, Inc. described in the RFC1321 (MD5 Message-Digest Algorithm).

Copyright (C) 1991-2, RSA Data Security, Inc. Created 1991. All rights reserved.

License to copy and use this software is granted provided that it is identified as the "RSA Data Security, Inc. MD5 Message-Digest Algorithm" in all material mentioning or referencing this software or this function.

License is also granted to make and use derivative works provided that such works are identified as "derived from the RSA Data Security, Inc. MD5 Message-Digest Algorithm" in all material mentioning or referencing the derived work.

RSA Data Security, Inc. makes no representations concerning either the merchantability of this software or the suitability of this software for any particular purpose. It is provided "as is" without express or implied warranty of any kind.

These notices must be retained in any copies of any part of this documentation and/or software.

Firmware Notice

- The unit's firmware is protected by copyright laws and international treaty provisions, and all other applicable laws. It cannot be reverse engineered, decompiled or disassembled.

For Future Reference

Record the information in the space below for future reference.

Note

- The serial number of this product may be found on the label affixed to the bottom of the unit. You should note the serial number of this unit in the space provided and retain this manual as a permanent record of your purchase to aid in identification in the event of theft.

MODEL NO.	_____
SERIAL NO.	_____
DATE OF PURCHASE	_____
NAME OF DEALER	_____
DEALER'S ADDRESS	_____ _____ _____ _____
DEALER'S TEL. NO.	_____

For Your Safety

To reduce the risk of injury, loss of life, electric shock, fire, malfunction, and damage to equipment or property, always observe the following safety precautions.

Explanation of symbols

The following symbols are used to classify and describe the level of hazard and injury caused when the denotation is disregarded and improper use is performed.



Denotes a potential hazard that could result in serious injury or death.



Denotes a hazard that could result in minor injury or damage to the unit or other equipment.

The following symbols are used to classify and describe the type of instructions to be observed.



This symbol is used to alert users to a specific operating procedure that must not be performed.









This symbol is used to alert users to a specific operating procedure that must be followed in order to operate the unit safely.











WARNING

General Safety





-  Do not disassemble this unit. Only qualified personnel should service this unit. Disassembling the unit may expose you to dangerous voltages or other risks. Incorrect reassembly can cause electric shock.
-  Do not insert foreign objects into the unit.
-  Do not connect or disconnect the AC plug with wet hands.
-  Disconnect the unit from the AC outlet, disconnect the LAN cable, and contact the dealer if:
 - The AC adaptor cord or AC plug becomes damaged or frayed.
 - The unit is exposed to rain, water, or any other liquid.
 - The unit is dropped or damaged.
 - Internal components are exposed due to damage.
 - The unit does not operate properly.
 - Performance deteriorates.
-  Disconnect the unit from the AC outlet and disconnect the LAN cable if the unit emits smoke, an abnormal smell, or makes unusual noise. These conditions can cause fire or electric shock. Confirm that smoke has stopped and contact an authorized service center.
-  Clean the AC plug periodically with a soft, dry cloth to remove dust and other debris.

Installation

-  Do not connect the unit to the AC outlet, AC extension cords, etc., in a way that exceeds the power rating of, or does not comply with the instructions provided with, the AC outlet, AC extension cords, etc.
-  Do not touch the unit, AC adaptor, AC adaptor cord, or telephone cord during a lightning storm.
-  Do not install telephone jacks in wet locations unless the jack is specifically designed for wet locations.



-  Do not touch uninsulated telephone wires or terminals unless the telephone line has been disconnected at the network interface.
-  If using an AC adaptor, use only the included AC adaptor (PQLV206).
-  The AC adaptor should be connected to a vertically oriented or floor-mounted AC outlet. Do not connect the AC adaptor to a ceiling-mounted AC outlet, as the weight of the adaptor may cause it to become disconnected.
-  Only connect the unit to the type of electric power specified on the label affixed to the unit. Confirm the type of electric power supplied to the installation site if necessary.
-  Use caution when installing or modifying telephone lines.



Placement

-  Do not expose the unit to contact with liquids (rain, water, moisture, oil, etc.) or excessive smoke or dust. Do not subject the unit to excessive shock.
-  Do not allow anything to rest on the AC adaptor cord or LAN cable. Do not locate this unit where the AC adaptor cord or LAN cable may be stepped on or tripped on.
-  Place this unit on a flat surface. Serious damage and/or injury may result if the unit falls.
-  Allow 10 cm (3 15/16 in) clearance around the unit for proper ventilation.



CAUTION

-  Do not place heavy objects on top of this unit.
-  When the unit receives power from the AC adaptor, the AC adaptor is the main disconnect device. Ensure that the AC outlet is installed near the unit and is easily accessible, so that the unit can be disconnected from the AC outlet if necessary.
-  Disconnect the AC adaptor cord and all cables from the unit before cleaning. Clean the unit with a soft, dry cloth. Do not use liquid, aerosol cleaners, abrasive powders, or chemical agents to clean the unit.

-  The SD memory card poses a choking hazard. Keep the SD memory card out of reach of children.
-  When left unused for a long period of time, disconnect the unit from the AC outlet. When the unit receives power from a PoE power supply, disconnect the LAN cable.

Notice

- Read and follow all instructions, warnings, cautions, etc. including those marked on the unit.
- Before connecting the unit, confirm that the unit supports the intended operating environment.
- If the unit does not operate properly, disconnect the AC adaptor cord and LAN cable, then connect again.
- The unit may not operate in the event of a power failure. Ensure that a separate telephone, not dependent on local power, is available for use in case of emergency.
- Do not move the unit while it is in use.
- To prevent malfunction, deformity, overheating, rust, and discoloration, do not install or place equipment in the following types of locations:
 - Locations exposed to direct sunlight.
 - Locations where the temperature is less than 0 °C (32 °F) or greater than 40 °C (104 °F).
 - Locations where there is high humidity.
 - Locations where air ventilation is poor.
 - Locations that may be exposed to sulphurous gas, such as near hot springs.
 - Near devices that emit heat, such as heaters.
 - Near devices that emit electromagnetic noise, such as radios or televisions.
 - Near devices that emit high-frequency noise, such as sewing machines or welders.
- Do not place credit cards, ATM cards, or other magnetic cards near the unit. The magnets in the unit's speaker and microphones may damage magnetic cards.
- If an error message is shown on the unit's display, consult the network administrator.
- Satisfactory operation, interoperability, and compatibility cannot be guaranteed with all equipment connected to the unit, nor with all services provided by telecommunications providers over networks connected to the unit.

For Best Performance

- Use the unit in a quiet room. Ambient noise of less than 50 dBA is recommended.
- Use the unit in a room with minimal echoing. Do not place the unit near walls, windows, partitions, etc.
- During the first 30 seconds of a TEL call, the unit adjusts itself for optimal sound quality. Speak in turns with the other party at the beginning of a conversation. (The time required varies depending on the condition of the telephone line and the audio characteristics of the room.) During this time, sound may cut out or fade in and out. This is normal.
- Do not obstruct the unit during calls. Keep your hands, as well as common objects such as folders, cups, and coffee pots away from the unit during calls.

Data Security

We recommend observing the security precautions described in this section, in order to prevent the following:

- loss, disclosure, falsification, or theft of user information
- unauthorized use of the unit
- interference or suspension of use caused by an unauthorized party

We cannot be responsible for damages resulting from the misuse of this product.

Note

- This product can be used to store and log user information. User information is defined as the following:
 - phonebook entry names, phone numbers, and IP addresses
 - call history (redial list)
 - recordings stored on the SD memory card

Preventing Data Loss

- Use a computer to make periodic backups of recordings stored on the SD memory card.
- Keep a separate record of all information stored in the phonebook.

Preventing Data Disclosure

- Do not leave the unit or SD memory card in a location where it can be accessed or removed without authorization.
- Store backups in a secure location.
- Do not store sensitive personal information in the unit.
- In the following situations, make a record of information stored in the phonebook, initialize the unit (see page 56), and remove the SD memory card from the unit.
 - Before disposing of the unit
 - Before handing the unit over to a third party
 - Before having the unit serviced
- Make sure the unit is serviced by only a certified technician.

Preventing Data Disclosure Over the Network

- To ensure the security of private conversations, only connect the unit to a secure network.
- To prevent unauthorized access, only connect the unit to a network that is properly managed.
- Make sure all computers connected to the unit employ up-to-date security measures.

Additional Information

FCC Requirements

1. Notification to the Telephone Company

This equipment complies with Part 68 of the FCC rules and the requirements adopted by the ACTA. On the bottom of this equipment is a label that contains, among other information, a product identifier in the format US: ACJTE04BKX-NT700. If requested, this number must be provided to the telephone company.

If required, provide the telephone company with the following technical information:

- Telephone numbers to which the system will be connected
- Make: Panasonic
- Model: KX-NT700
- Certification No.: found on the bottom of the unit
- Ringer Equivalence No.: 0.4B
- Facility Interface Code: 02LS2
- Service Order Code: 9.0F
- Required Network Interface Jack: RJ11

2. Ringer Equivalence Number (REN)

The REN is used to determine the number of devices that may be connected to a telephone line. Excessive RENs on a telephone line may result in the devices not ringing in response to an incoming call. In most but not all areas, the sum of RENs should not exceed five (5.0). To be certain of the number of devices that may be connected to a line, as determined by the total RENs, contact the local telephone company. The REN for this product is part of the product identifier that has the format US: ACJTE04BKX-NT700. The digits represented by 04 are the REN without a decimal point (e.g., 04 is a REN of 0.4). For earlier products, the REN is separately shown on the label.

3. Incidence of Harm to the Telephone Lines

If this equipment causes harm to the telephone network, the telephone company will notify you in advance that temporary discontinuance of service may be required. But if advance notice isn't practical, the telephone company will notify the customer as soon as possible. Also, you will be advised of your right to file a complaint with the FCC if you believe it is necessary.

4. Changes in Telephone Company Communications Facilities, Equipment, Operations and Procedures

The telephone company may make changes in its facilities, equipment, operations or procedures that could affect the operation of the equipment. If this

happens the telephone company will provide advance notice in order for you to make necessary modifications to maintain uninterrupted service.

5. Trouble with this Equipment

If trouble is experienced with this equipment, for repair or warranty information, please see the attached warranty, which includes the shipping address of the Panasonic Service and Technology Company BTS Center. If the equipment is causing harm to the telephone network, the telephone company may request that you disconnect the equipment until the problem is resolved.

6. Connection to Party Line

Connection to party line service is subject to state tariffs. Contact the state public utility commission, public service commission or corporation commission for information.

7. Combined Use with Alarm Equipment

If your home has specially wired alarm equipment connected to the telephone line, ensure the installation of this equipment does not disable your alarm equipment. If you have questions about what will disable alarm equipment, consult your telephone company or a qualified installer.

8. Automatic Dialing Features

When programming emergency numbers and/or making test calls to emergency numbers:

- i. Remain on the line and briefly explain to the dispatcher the reason for the call before hanging up.
- ii. Perform such activities in the off-peak hours, such as early morning hours or late evenings.

Important Safety Instructions

When using this unit, basic safety precautions, including those below, should always be followed to reduce the risk of fire, electric shock and injury to persons.

1. Do not use the unit near water, for example, near a bathtub, wash bowl, kitchen sink, or laundry tub, in a wet basement, or near a swimming pool.
2. Avoid using a wired telephone during an electrical storm. There is a remote risk of electric shock from lightning.
3. Do not use the telephone in the vicinity of a gas leak to report the leak.

SAVE THESE INSTRUCTIONS

Required Telephone Cord

CAUTION

- To reduce the risk of fire, use only No. 26 AWG or larger telephone line cord.

Perchlorate Information

Notice

- This product contains a CR Coin Cell Lithium Battery which contains Perchlorate Material—special handling may apply.
See
www.dtsc.ca.gov/hazardouswaste/perchlorate

Interference

This equipment has been tested and found to comply with the limits for a Class B digital device, pursuant to Part 15 of the FCC Rules. These limits are designed to provide reasonable protection against harmful interference in a residential installation. This equipment generates, uses, and can radiate radio frequency energy and, if not installed and used in accordance with the instructions, may cause harmful interference to radio communications. However, there is no guarantee that interference will not occur in a particular installation. If this equipment does cause harmful interference to radio or television reception, which can be determined by turning the equipment off and on, the user is encouraged to try to correct the interference by one or more of the following measures:

- Reorient or relocate the receiving antenna.
- Increase the separation between the equipment and receiver.

- Connect the equipment into an outlet on a circuit different from that to which the receiver is connected.
- Consult the dealer or an experienced radio/TV technician for help.

Table of Contents



Before Use	16
Accessory Information	16
Unit Overview	17
Main View	17
Front Panel	18
Understanding the Display	19
Function Buttons and Function Button Icons	19
Preparation	22
Basic Connections	22
Setting the Date & Time	23
TEL Line Settings	23
IP Network Settings	24
SIP Settings	25
IP Line Operation Mode	25
Using SD Memory Cards	26
Formatting SD Memory Cards	27
Using the Microphones	28
Installing and Uninstalling Conferencing Phone Manager	29
Making and Answering Calls	30
Line Selection	30
Making Calls	31
Making Conference Calls	33
Answering Calls	34
Useful Features Available During a Call	35
Phonebook	36
Adding Entries to the Phonebook	36
Editing Entries	36
Erasing Entries	37
Character Tables	38
Recording	39
Recording Features	39
Recording Conversations	39
Recording Voice Memos	39
Playing Back Recordings	39
Erasing Recordings	40
Using a Portable Station (PS) or Computer	41
Using a Portable Station (PS)	41
Using a Computer	42
Programming the Unit	43
Changing and Confirming Settings	43
Changing Settings	43
Restarting the Unit	43
Parameter List	44
Parameters	46
Show IP Address	46
Operation Mode	46

Basic Settings	46
Line Selection	48
TEL Settings	48
IP Network Settings	49
Protocol Settings	50
VoIP Settings	52
QoS Settings	53
System Status Confirmation	54
System Options	54
Initialization Features	56
Erasing Data	56
Erasing the Redial List	56
Erasing the Phonebook	56
Resetting System Data	56
Resetting All Data	56
Conferencing Phone Manager	57
Using Conferencing Phone Manager	57
Operating the Unit Using Conferencing Phone Manager	57
Programming the Unit Using Conferencing Phone Manager	58
Restarting the Unit Using Conferencing Phone Manager	58
Troubleshooting	59
Troubleshooting	59
General Use	59
Making and Receiving Calls	59
Sound Quality	61
SD Memory Cards	63
Phonebook	63
Programming	64
Display Messages	64
Other Information	67
Cleaning the Unit	67
Specifications	68
Specifications	68
Index.....	69

Accessory Information

Included Accessories

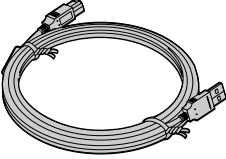
To order replacement accessories, call 1-800-332-5368.

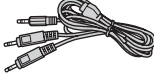
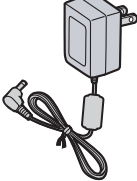
USB Cable (1) About 1.8 m (6 ft.)	PS Cable (1) About 1 m (3 ft. 3 in.)	PC Cable (1) About 1.8 m (6 ft.)	AC Adaptor (1) About 1.8 m (6 ft.)
			
Order no. PSWE2NT700N	Order no. PSJA1123Z	Order no. PSJA1122Z	Order no. PSWE1NT700M

Optional Accessories

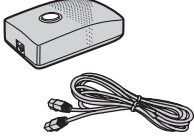
External Wired MIC Cord: About 3 m (10 ft.)

KX-NT701

Unit Overview

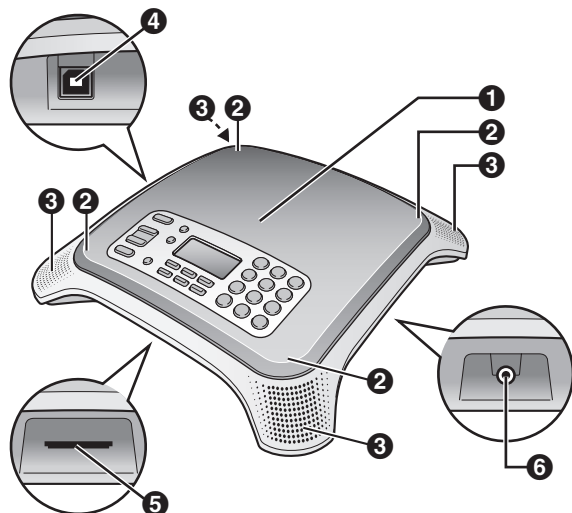
Main View

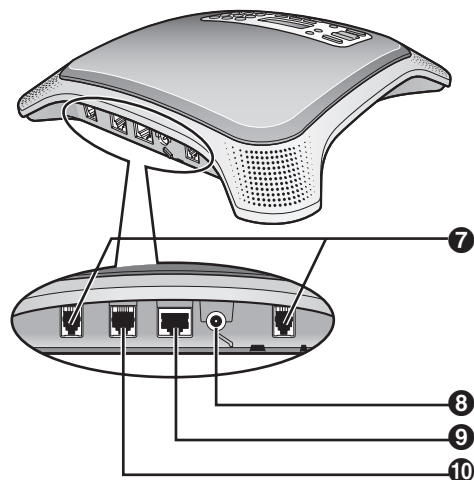

- 1 Speaker**
- 2 Indicators (4 locations)**
Indicate the status of the unit.
Off: The unit is in standby mode (i.e., not in use).
Blue, flashing: A call is being received.
Blue, lit: The unit is on a call.
Red, lit: The microphones are muted, or an error has occurred.
- 3 Built-in Microphones (4 locations)**
See page 28.
- 4 USB Port (USB)**
Used to connect the unit to a computer and use the included Conferencing Phone Manager software (see page 57).
- 5 SD Memory Card Slot**
Allows you to insert a compatible SD memory card and record conversations. See page 26 for more information about SD memory cards.
- 6 AUDIO IN/OUT Jack**
Allows you to connect a compatible Panasonic Portable Station (PS; see page 41) or a computer (see page 42).



- 7 External Wired MIC Jacks (EXT MIC1, EXT MIC2)**
Allow you to connect an External Wired MIC to the unit (see page 28). 2 mics can be connected.
- 8 DC Input (DC IN)**
Used to connect the unit to an AC outlet using the included AC adaptor.
- 9 LAN Port (LAN)**
Used to connect the unit to an IP network. May also be used to supply power to the unit using PoE (Power over Ethernet) when the unit is connected to a PoE-compatible switching hub or power supply (see page 22).
- 10 Telephone Jack (LINE)**
Used to connect the unit to a telephone network or PBX.

Front Panel

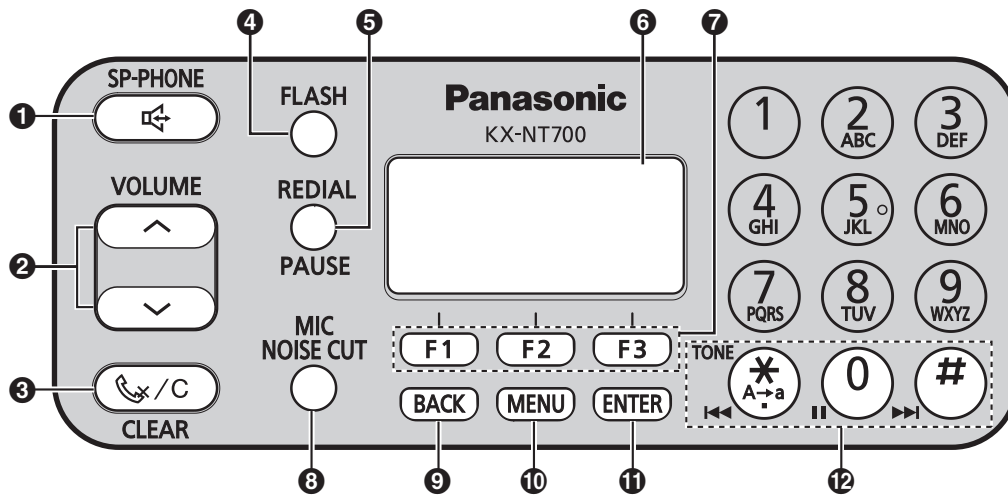

- 1** **SP-PHONE Button (Speakerphone Button)**
Used to make, answer, and end calls.
- 2** **Navigator/Volume Buttons ([^] and [v])**
Used to scroll through the items displayed on the display, such as phonebook entries, programmable settings, etc. Also used to adjust the speaker volume during calls (see page 31) and the ringer volume (see page 34).
- 3** **SP-PHONE / C Button (Mute/Clear Button)**
Used to erase characters or numbers while storing a phonebook entry or making a call. Also used to mute the unit's microphones during a call (see page 35).
- 4** **FLASH Button**
Used to operate optional telephone company services, such as call waiting, or PBX features, such as extension transfers (see page 35).
- 5** **REDIAL/PAUSE Button**
Used to call a previously called party again (see page 32) or to enter a dialing pause (see page 32).
- 6** **Display**
See page 19.
- 7** **Function Buttons ([F1], [F2], and [F3])**
Used to select the functions that correspond to the icons shown on the bottom of the display (see page 19).
- 8** **MIC NOISE CUT Button**
Used to reduce noise in the audio signal sent to the other party during a call (see page 35).
- 9** **BACK Button**
Used to return to the previous screen.
- 10** **MENU Button**
Used to enter the programming menu or to return the unit to standby mode.
- 11** **ENTER Button**
Used to save or confirm information shown on the display.
- 12** **Playback Control Buttons**
Used to control playback when playing back recordings (see page 39).

Understanding the Display

The display helps you operate and program the unit by displaying a variety of messages and icons.

Standby Mode

Phonebook

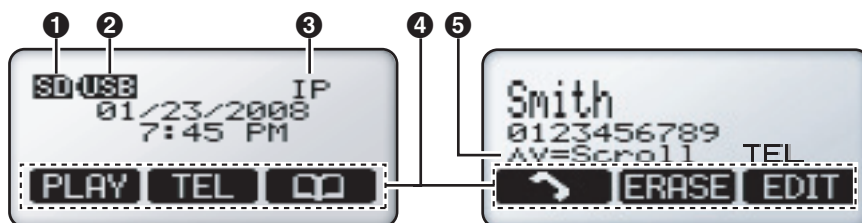

1 SD Icon

Indicates that a compatible SD memory card has been inserted in the unit (see page 26).

2 USB Icon

Indicates that a computer is connected to the USB port (see page 57).

3 Line Icon (IP, TEL, PS, PC)

Indicates which line will be used when a call is made.

4 Function Button Icons

Indicates the functions currently available when the function buttons are pressed. The icons displayed vary on the current state of the unit (e.g., the icons displayed when on a call are different from the icons displayed when storing an entry in the phonebook).

5 Scroll Indicator

Indicates that [^] or [v] can be pressed to display the previous or next item.

Recording Icons

: Indicates a recorded conversation.

: Indicates a recorded voice memo.

Function Buttons and Function Button Icons

By pressing a function button ([F1], [F2], and [F3]) you can select the function displayed directly above it. The functions that correspond to each function button are indicated by each function button icon.

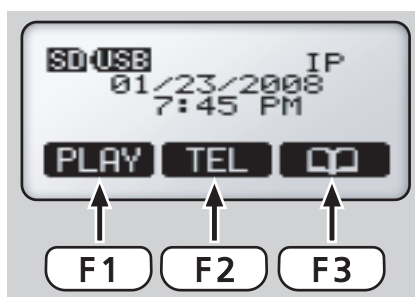

In this document, function buttons are referred to by their corresponding icons.

In the example shown here,

























"Press ",







"Press ", or

"Press "

would indicate pressing [F1], [F2], and [F3], respectively.

Function Button Icons

Operation	Icon	Description
Line Selection		Used to select the TEL line. Only displayed when the "Line Selection" setting is set to "IP + TEL" (see page 23).
		Used to select the IP line.
		Used to select the PS line. Only displayed when the "Line Selection" setting is set to "IP + PS" (see page 41).
		Used to select the PC line. Only displayed when the "Line Selection" setting is set to "IP + PC" (see page 42).
		Used to change the "Line Selection" setting (see page 30).
Starting and Ending Calls		Used to answer an incoming call (see page 34).
		Used to reject an incoming call (see page 34).
		Used to make a call (see page 31).
		Used to end the current call.
		Used to establish a conference call (see page 33 and page 34).
		Used to slow down the other party's speech while on a call (see page 35).
Phonebook		Used to open the phonebook (see page 36).
		Used to add an entry to the phonebook (see page 36).
		Used to edit a phonebook entry (see page 36).
		Used to switch between alphabet entry mode and extended entry mode (see page 38).
		Used to move the cursor to the left.
		Used to move the cursor to the right.
		Used to erase an entry in the phonebook (see page 37).
Recording and Playback		Used to start recording to the SD memory card (see page 39).
		Used to play the selected recording (see page 39).
		Used to stop recording (see page 39).
		Used to rewind the current recording (see page 40).
		Used to fast forward the current recording (see page 40).
		Used to erase a recording (see page 40).

Operation	Icon	Description
Other		Used to return to the previous screen.
		Used to select the displayed item.
		Used to save any changes made while programming the unit.
		Used to accept the displayed item or proceed with the current operation.
		Used to decline the displayed item or cancel the current operation.
		Used to format an SD memory card (see page 27).

Basic Connections

This section explains all connections needed to make and receive IP line and TEL line calls.

To connect a Portable Station (PS) or computer to the unit, see page 41 or page 42, respectively.

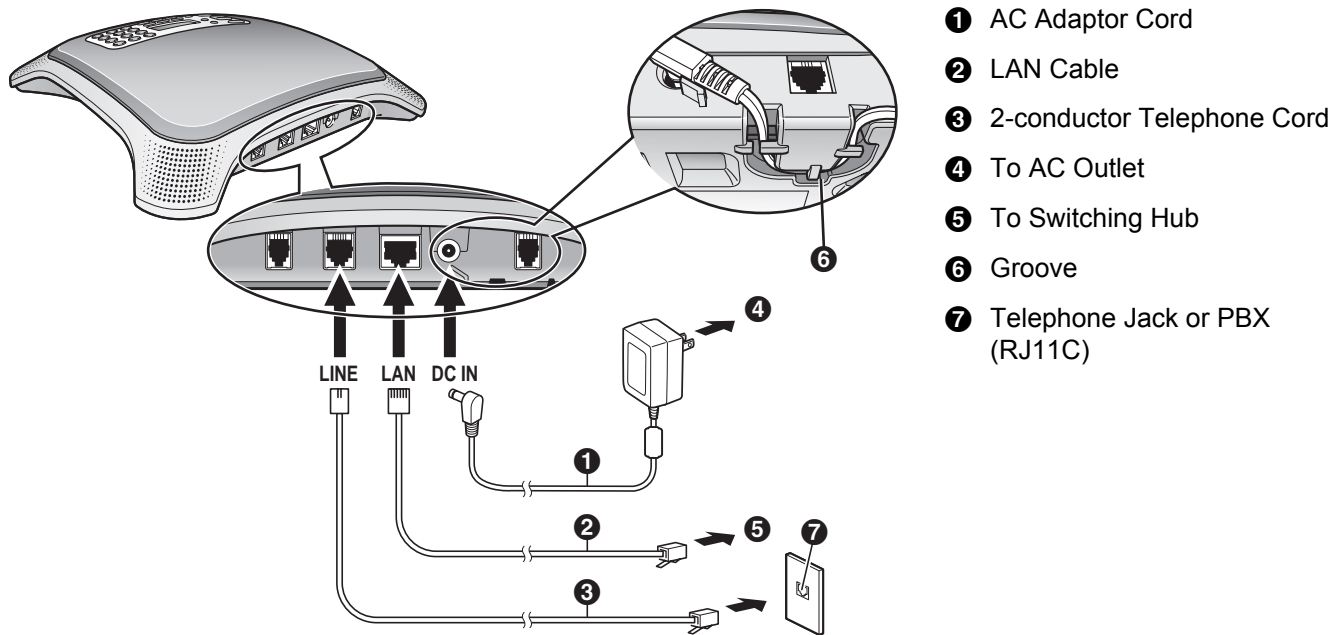

1. Connect the unit to the desired IP network and/or telephone line.
 - To connect to an IP network, connect a category 5 LAN cable to the **LAN** port and to a switching hub.
 - To connect to a telephone line, connect a telephone cord to the **LINE** jack and to a modular telephone jack.
2. Connect the AC adaptor cord of the included AC adaptor to the unit's DC input.
 - To use PoE (Power over Ethernet), connect the LAN cable to a PoE-compatible (IEEE802.3af) switching hub or power supply. The included AC adaptor does not need to be connected when using PoE.
 - If using an AC adaptor, use only the included AC adaptor (PQLV206).
 - Pass the AC adaptor cord through the groove on the bottom of the unit.
3. Connect the AC adaptor to the AC outlet.

Note

- The AC adaptor must remain connected at all times (unless the unit is powered by PoE). It is normal for the adaptor to feel warm during use.

Setting the Date & Time

Set the unit's date and time setting before using the unit. The date and time are shown on the display in standby mode, and are displayed when playing conversations that were recorded to an SD memory card.

1. Press **[MENU]**.
2. Select "Basic Settings", then press **SELECT**.
3. Select "Date & Time", then press **SELECT**.
4. Using the keypad, enter 2 digits each for the year, month, day of the month, hour (24-hour format), and minute.
Example: To enter "Jan. 23, 2008, 7:45 PM", press **[0801231945]**.
 - If you make a mistake, press **<** to move the cursor as needed, then enter the correct number.
5. Press **SAVE**.
6. Press **[MENU]**.

Note

- You can select 12-hour or 24-hour time display (see page 47).
- The date format varies by the selection made for the "Language" setting. See page 46 for details.

TEL Line Settings

Selecting the Available Lines

To use the TEL line, the "Line Selection" setting must be set to "IP + TEL". (This is the default setting.)

1. Press **[MENU]**.
2. Press **LINE**.
3. Select "IP + TEL".
 - When "Line Selection" is set to "IP + PC" or "IP + PS", TEL calls cannot be made or received.
4. Press **SAVE**.
5. Press **[MENU]**.

Setting the Dial Mode

Set the dial mode to "Pulse" if the TEL line does not support tone dialing.

1. Press **[MENU]**.
2. Select "TEL Settings", then press **SELECT**.
3. Select "Dial Mode", then press **SELECT**.
4. Select "Pulse" or "Tone".
5. Press **SAVE**.
6. Press **[MENU]**.

IP Network Settings

To properly connect the unit to an IP network, the following settings must be set to match the settings of the IP network. Consult your system administrator for the appropriate settings.

- IP address mode: Automatic (DHCP) or manual (static) IP address assignment (default: static)
- IP address (when static connection mode is selected; default: 192.168.0.2)
- Subnet mask (when static connection mode is selected; default: 255.255.255.0)
- Default gateway (when static connection mode is selected; default: 0.0.0.0)

Note

- IP addresses can be entered using the keypad. [0]–[9] are used to enter numbers and [*] is used to enter a period. For example, to enter "192.168.0.1", press [192*168*0*1].

Automatic Assignment (DHCP)

1. Press [MENU].
2. Select "IP Network Settings", then press **SELECT**.
3. Select "IP Address Mode", then press **SELECT**.
4. Select "DHCP", then press **SAVE**.
5. Press [MENU].

Note

- If this setting is changed, the unit must be restarted before the new setting becomes effective (see page 43).
- To confirm the IP address, press [MENU]→"Show IP Address"→ **SELECT**.

Manual Assignment (Static)

1. Press [MENU].
2. Select "IP Network Settings", then press **SELECT**.
3. Select "IP Address Mode", then press **SELECT**.
4. Select "Static", then press **SAVE**.
5. Select "IP Address", then press **SELECT**.
6. Enter the IP address to be assigned to the unit, then press **SAVE**.
7. Select "Subnet Mask", then press **SELECT**.
8. Enter the subnet mask, then press **SAVE**.
9. Select "Default Gateway", then press **SELECT**.
10. Enter the IP address of the default gateway, then press **SAVE**.
11. Press [MENU].

Note

- If this setting is changed, the unit must be restarted before the new setting becomes effective (see page 43).
- To confirm the IP address, press [MENU]→[Show IP Address]→ **SELECT**.

SIP Settings

To use the unit as a SIP extension of the PBX, the unit must be registered as a SIP extension through PBX programming, the "Operation Mode" setting must be set to "IP-PBX" (see page 25), and the following settings must be set to match the settings of the PBX. Consult your system administrator for the appropriate settings. Refer to the PBX documentation to register the unit as a SIP extension.

1. Press **[MENU]**.
2. Select "Protocol Settings", then press **SELECT**.
3. Select "SIP Ext. No.", then press **SELECT**.
4. Enter the unit's extension number (max. 32 digits), then press **SAVE**.
5. Select "SIP Password", then press **SELECT**.
6. Enter the password (max. 32 characters), then press **[ENTER]**.
 - Press **CHAR** to switch between numeric and alphabet entry modes.
 - Press **[*]** to change between uppercase and lowercase character entry.
 - See page 36 and page 38 for information on entering characters.
7. Select "SIP User Domain Name", then press **SELECT**.
8. Enter the IP address of the PBX, then press **SAVE**.
9. Select "SIP Proxy Server IP Address", then press **SELECT**.
10. Enter the IP address of the PBX, then press **SAVE**.
11. Select "SIP Registrar IP Address", then press **SELECT**.
12. Enter the IP address of the PBX, then press **SAVE**.
13. Press **[MENU]**.

Note

- If this setting is changed, the unit must be restarted before the new setting becomes effective (see page 43).

IP Line Operation Mode

Whether IP calls are made and received using IP-PBX mode or peer to peer mode is determined by the "Operation Mode" setting.

1. Press **[MENU]**.
2. Select "Operation Mode", then press **SELECT**.
3. Select the desired setting.
 - "IP-PBX": The unit can make and receive IP calls as a SIP extension of the PBX. (This is the default setting.)
 - "Peer to Peer": Peer to peer IP calls are possible. To make a call, the other party's IP address is specified.
4. Press **SAVE**.
5. Press **[MENU]**.

Note

- If this setting is changed, the unit must be restarted before the new setting becomes effective (see page 43).

Using SD Memory Cards

Conversations can be recorded to the SD memory card. For information on recording conversations, see page 39.

Inserting and Removing Cards

Insert the SD memory card as shown, with the label side facing up. To remove the card, gently push the card to release it, then remove the card.

- When an SD memory card is inserted, **SD** is shown in the upper-left corner of the display.

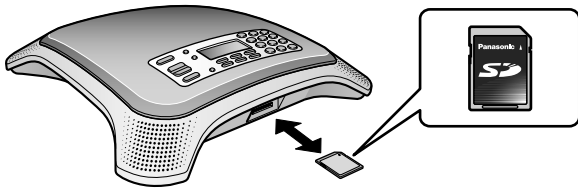

Important Information

To prevent data corruption or damage to the SD memory card, which may also affect the performance of the unit, keep the following in mind.

- Do not remove the SD memory card, LAN cable, or disconnect the unit from the AC outlet during playback, recording, formatting, or while erasing data on the card.
- Do not move or bump the unit during playback, recording, formatting, or while erasing data on the card.
- Do not touch the contacts on the bottom of the SD memory card.
- To prevent damage to the unit, do not insert any memory card other than a compatible SD memory card.

Compatible Cards

The unit supports the following SD memory cards.

- SD, miniSD, and microSD memory cards.
 - Use a miniSD or microSD adaptor when using miniSD or microSD memory cards, respectively, and always insert the miniSD or microSD memory card into the adaptor before inserting the adaptor into the unit.
- Cards with a capacity of 32 MB to 2 GB.
- Class 2, Class 4, and Class 6 cards.

Note

- The unit does not support SDHC, miniSDHC, and microSDHC memory cards.

Approximate Recording Time

Capacity	Approx. Recording Time
2 GB	67 hours
1 GB	33 hours
512 MB	17 hours
256 MB	8 hours
128 MB	4 hours
64 MB	2 hours
32 MB	1 hour

Write-protection (LOCK)

SD memory cards can be locked to prevent formatting, erasing, and recording. To lock an SD memory card, slide the switch on the side of the card to the "LOCK" position.

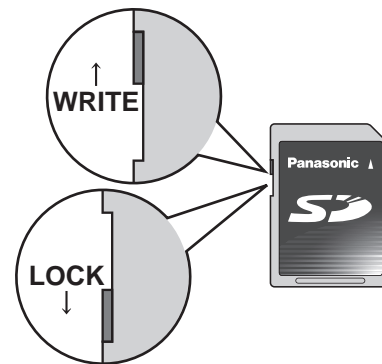

Backing Up Data

Data stored on SD memory cards can become corrupted if the card is exposed to electromagnetic fields, static electricity, etc. We recommend using a computer to back up important data stored on SD memory cards.

Formatting SD Memory Cards

If **FORMAT** is displayed, the SD memory card must be formatted; press **FORMAT** to format the card.

Notice

- When an SD memory card is formatted, all information on the card is erased.
- Do not remove the SD memory card, LAN cable, or disconnect the unit from the AC outlet while formatting an SD memory card.
- Do not move or bump the unit while formatting an SD memory card.

Note

- The unit cannot format cards that are not already in FAT format. Use a computer to format non-FAT formatted cards.

Formatting With a Computer

When formatting cards with a computer, select the FAT (FAT16) format.

Notice

- When an SD memory card is formatted, all information on the card is erased.

Using the Microphones

Built-in Microphones

For best performance when using the built-in microphones, speak within about 3 m (about 10 ft.) of the unit.

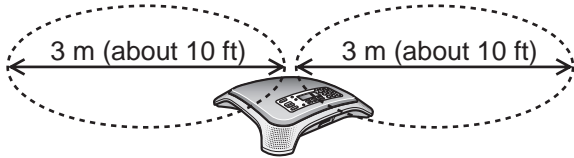

Note

- The sensitivity of the built-in microphones may vary depending on room characteristics.

External Wired MIC

An optional KX-NT701 External Wired MIC can be connected to the unit using the **EXT MIC1** (1) or **EXT MIC2** (2) jacks. 2 mics can be connected.

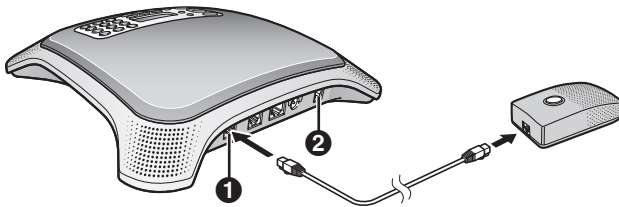

For best performance when using an External Wired MIC:

- Do not move an External Wired MIC while on a call. (Feedback may occur.)
- Place each External Wired MIC at least 1 m (about 3 ft.) away from the unit.
- Speak within about 2 m (about 6.5 ft.) of the External Wired MIC.

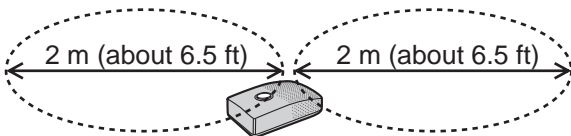

Note

- The sensitivity of an External Wired MIC may vary depending on room characteristics.
- The built-in microphones continue to function when an External Wired MIC is connected.
- The indicator of an External Wired MIC indicates unit status the same as the built-in indicators (see page 17).

Installing and Uninstalling Conferencing Phone Manager

The unit can be used in conjunction with Conferencing Phone Manager. This software can be found on the included CD-ROM, and allows you to operate and program the unit using a computer (see page 57).

System Requirements

Supported operating systems

- Microsoft Windows XP (all editions)
- Windows Vista (all editions)

Hardware requirements (when using Windows XP)

- **CPU:** 1 GHz Intel Pentium or Celeron microprocessor (or a CPU of similar performance)
- **Hard disk:** at least 1 GB of available space
- **RAM:** at least 256 MB

Hardware requirements (when using Windows Vista)

- **CPU:** 1 GHz Intel Pentium or Celeron microprocessor (or a CPU of similar performance)
- **Hard disk:** at least 1 GB of available space
- **RAM:** at least 512 MB

Installing Conferencing Phone Manager

To install the software using the following procedure, do not connect the unit to the computer using the USB cable until step 8.

1. Insert the included CD-ROM into the computer's CD drive.
 - The CD-ROM's menu is displayed.
2. Click **[Conferencing Phone Manager]**.
3. Click **[OK]**.
 - The folder containing **[Setup.exe]** is displayed.
4. Double-click **[Setup.exe]**.
5. Select the desired language, then click **[OK]**.
 - The software install wizard is displayed.

6. Follow the on-screen instructions and install the software.
 - A dialog may be displayed that indicates the software has not passed Windows logo testing. This is normal. The software will not cause any difficulties with your operating system. Click **[Continue Anyway]** to proceed with installation.
7. Click **[Finish]**.
 - If **[Launch Conferencing Phone Manager]** is checked, Conferencing Phone Manager will start.
8. Connect the included USB cable to the USB port of the unit (1) and of the computer.

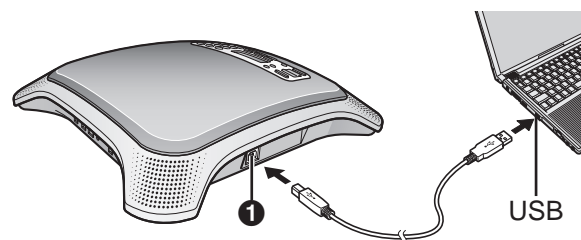

- The new hardware wizard is displayed.
9. Select **[Install the software automatically (Recommended)]**, then click **[Next]**.
 - A dialog may be displayed that indicates the software has not passed Windows logo testing. This is normal. The software will not cause any difficulties with your operating system. Click **[Continue Anyway]** to proceed with installation.
 10. Click **[Finish]**.

Note

- After installation is complete, a shortcut icon appears on the desktop.

You can click this icon to start Conferencing Phone Manager.



Uninstalling Conferencing Phone Manager

1. Click **[Start]→[All Programs]→[Panasonic]→[Conferencing Phone Manager]**, and click **[Uninstall]**.
2. Click **[Yes]**.
3. Click **[Finish]**.

Line Selection

The unit can make calls using the following lines.

- IP line (see page 31)
- TEL line (see page 31)
- PS line (see page 41)
- PC line (see page 42)

When you make a call, the line icon in the upper-right corner of the display indicates the line that will be used, therefore, you should confirm the line icon each time you make a call.

You can change the selected line by pressing the center function button (**[F2]**). The line that will be selected is indicated by the function button icon.

Example:

1. The IP line is selected.



2. **[TEL]** is pressed. The TEL line is now selected.



Note

- If the unit is not connected to an IP network, **[IP]** is not displayed and the IP line cannot be selected.

Selecting the Available Lines

The IP line is always available when the unit is connected to an IP network; if it is not selected (i.e., if it is not shown in the upper-right corner of the display), you can select it by pressing **[IP]**.

Whether the TEL line, PS line, or PC line is available is determined by the "Line Selection" setting. For example, when it is set to "IP + PS", the IP and PS lines are available.

You can change the "Line Selection" setting using the following procedure.

1. Press **[MENU]**.
2. Press **[LINE]**.
3. Select the desired setting.
 - "IP + TEL": The IP and TEL lines are available.
 - "IP + PS": The IP and PS lines are available.
 - "IP + PC": The IP and PC lines are available.
4. Press **[SAVE]**.
5. Press **[MENU]**.

Making Calls

1. Confirm that the desired line ("IP" or "TEL") is selected.
 - You can change the selected line by pressing the center function button ([F2]).

The IP line is selected. The TEL line is selected.

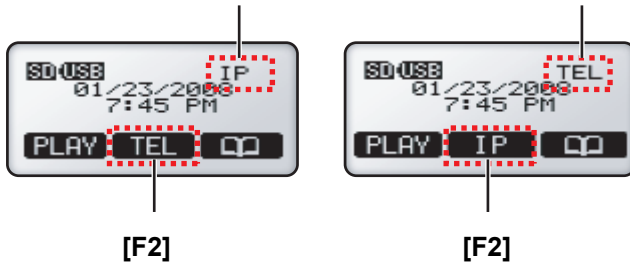

- If you cannot select the desired line, change the "Line Selection" setting (see page 30).
2. Press [↵].
 3. **For TEL calls:** Enter the phone number.
For IP calls with IP-PBX connection: Enter the phone number.
For IP calls with peer to peer connection: Enter the IP address, then press [#] or [ENTER].
 - IP addresses can be entered using the keypad. [0]–[9] are used to enter numbers and [*] is used to enter a period. For example, to enter "192.168.0.1", press [192*168*0*1].
 - To temporarily use tone dialing when the line mode is set to pulse mode, press [*].
 - After a call starts, the approximate length of the call is shown on the display.
 4. To end the call, press [↵].

Note

- To make a call using the phonebook, see page 32.
- To make a call with a Portable Station (PS) or computer connected to the unit, see page 41 or page 42.
- During the first 30 seconds of a TEL call, the unit adjusts itself for optimal sound quality. Speak in turns with the other party at the beginning of a conversation. (The time required varies depending on the condition of the telephone line and the audio characteristics of the room.) During this time, sound may cut out or fade in and out. This is normal.
- If the unit is not connected to an IP network, **IP** is not displayed and the IP line cannot be selected.

- The call length shown on the display is an approximation and may differ from the actual length of the call. Call charges accumulate after the called party answers.

Adjusting the Speaker Volume

While on a call, press [^] or [v] repeatedly to adjust the speaker volume. There are 8 levels of volume.



Quieter

Louder

- If the other party has difficulty hearing you, press [v] to decrease the speaker volume. Your voice heard by the other party will become louder.

Making a Call After Entering the Phone Number or IP Address

1. Confirm that the desired line ("IP" or "TEL") is selected.
 - You can change the selected line by pressing the center function button ([F2]).

The IP line is selected. The TEL line is selected.

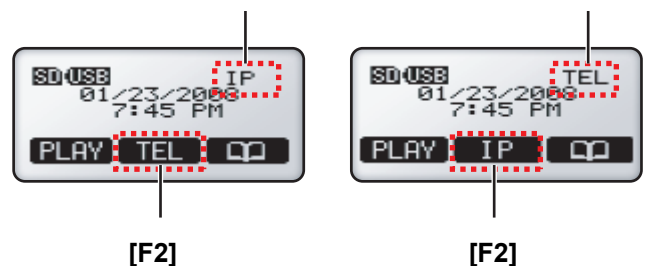

- If you cannot select the desired line, change the "Line Selection" setting (see page 30).
2. **For TEL calls:** Enter the phone number.
For IP calls with IP-PBX connection: Enter the phone number.
For IP calls with peer to peer connection: Enter the IP address.
 - If you make a mistake, press [ⓧ/C], then enter the correct phone number or IP address. To erase all numbers, press and hold [ⓧ/C].
 - If a pause is required when making a call on the TEL line, press [REDIAL/PAUSE] between digits as necessary.
 3. Press [↵] or [ⓧ/C].
 4. To end the call, press [↵].

Redialing

The last 10 calls made are stored in the redial list, in order of newest to oldest call.

1. Press **[REDIAL/PAUSE]**.
 - The last call made is displayed.
2. Press **[^]** or **[v]** repeatedly to scroll through the list.
 - To erase the displayed item, press **ERASE**.
 - To exit the redial list, press **[MENU]**.
3. When the desired entry is displayed, press **[↩]** or **[↶]**.

Note

- The line that was used to make each call in the redial list ("IP" or "TEL") is shown in the lower-right corner of the display. This line will be used when the call is redialed.

Example:

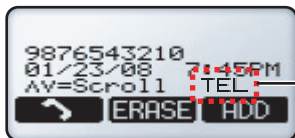

The TEL line will be used when you redial this number.

- If the "Line Selection" setting is not set to "IP + TEL" (see page 30), TEL line calls cannot be redialed.
- If the dialed number contains too many digits (more than 32 digits for IP calls with IP-PBX connection, more than 128 digits for TEL calls), it cannot be redialed correctly.

Entering Dialing Pauses

A pause is sometimes required when making calls on the TEL line using a PBX or a long distance service. For example, if you must dial "9" before dialing an outside phone number, you probably wait (pause) after dialing "9" until you hear a dial tone.

By pressing the **[REDIAL/PAUSE]** button when dialing, the unit will store the dialing pause along with the phone number in the redial list. If you make a call from the redial list later, the unit will dial the number wait for the pre-programmed number of seconds (default: 3 s; see page 49) for each dialing pause you entered.

Example:

1. Press **[9]** (to access an outside line of a PBX).
2. Press **[REDIAL/PAUSE]**.
 - Press **[REDIAL/PAUSE]** repeatedly to create longer pauses. An additional pause is inserted each time **[REDIAL/PAUSE]** is pressed.

3. Dial the phone number.
4. Press **[↩]** or **[↶]**.

Making a Call from the Phonebook

See page 36 to add entries to the phonebook.

1. Press **[☰]**.
2. Press **[^]** or **[v]** repeatedly to scroll through the phonebook entries.
 - Entries are displayed in the following order when **[v]** is pressed.
Symbols→Numbers→Letters
 - Press the dial key corresponding to the desired character, then press **[^]** or **[v]** to scroll if necessary.
 - To exit the phonebook, press **[MENU]**.
3. When the desired entry is displayed, press **[↩]** or **[↶]**.

Note

- The line that was selected when the entry was stored in the phonebook ("IP" or "TEL") is shown in the lower-right corner of the display. This line will be used when the entry is called.

Example:



The TEL line will be used when you call this number.

- If the "Line Selection" setting is not set to "IP + TEL" (see page 30), TEL line numbers cannot be called.

Making Conference Calls

While on a call, you can make another call and establish a conference call (i.e., a 3-party call) including yourself and 2 other parties. You can establish a conference call using the following types of calls.

- 2 IP calls (Peer to peer mode only; see page 25)
- 1 IP call and 1 TEL call
- 1 IP call and 1 PS call
- 1 IP call and 1 PC call

To establish a conference call when you receive a call, see page 34.

Conference calls using the IP and TEL lines

1. Press **CONF** to put the current call on hold.
2. Confirm that the desired line ("IP" or "TEL") is selected.
 - If the unit is in IP-PBX mode, the available line is automatically selected. Continue from step 3.
 - If the unit is in peer to peer mode and the current call is an IP call, you can change the selected line by pressing the left function button (**[F1]**).

The IP line is selected. The TEL line is selected.

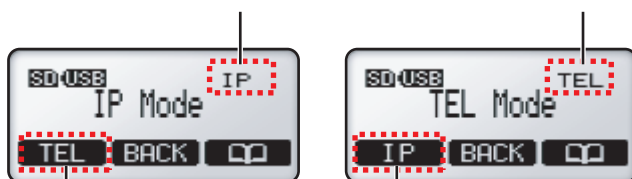

[F1]

[F1]

- If you cannot select the desired line, press **BACK**, then change the "Line Selection" setting (see page 30). After you have changed the setting, repeat this procedure from step 1.
3. Call the party you want to add to the conversation.
 - You can end the second call and return to the original call by pressing **BACK**.
 - To call a party stored in the phonebook, see page 32.
 4. After the called party answers, press **CONF** to begin the conference call.
 - Before beginning the conference call, press **END** to end the second call and return to the original call.

Note

- We recommend setting the "TEL Line Level Reduction" setting to "On" when establishing conference calls that use the TEL line (see page 49).

Adding a PS or PC line call to an IP call

1. Confirm that the "Line Selection" setting is set to "IP + PS" or "IP + PC" as necessary (see page 30).
2. Press **CONF** to put the current call on hold.
 - If the unit is in IP-PBX mode, the PS or PC line is automatically selected. Continue from step 4.
3. **Peer to peer mode only:** Press the left function button (**[F1]**) to select the PS or PC line.

Example: Pressing **PS** to select the PS line.

The IP line is selected.

The PS line is selected.

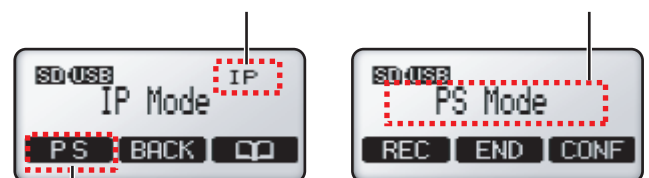

[F1]

4. Make a call using the PS or computer.
5. After the called party answers, press **CONF** to begin the conference call.
 - Before beginning the conference call, press **END** to end the second call and return to the original call.

Ending a Conference Call

Press **[END]** to disconnect both parties.

or

1. Press **END**.
 - Press **BACK** to continue the call.
2. Press **[^]** or **[v]** to select the party you would like to remove from the conference, then press **SELECT**.
 - The selected party is disconnected and you can continue to speak with the remaining party.
 - To disconnect both parties, select "All", then press **SELECT**.

Answering Calls

When a call is being received, the type of call being received is shown on the display.

Example: "Incoming Call on IP Line"

Notice

- When "Line Selection" (see page 30) is set to "IP + PC" or "IP + PS", TEL calls cannot be made or received.

- Press [📞] or **ANSWER**.
 - The unit does not support Caller ID; caller phone numbers are not displayed when calls are received.
 - You can refuse an incoming call by pressing **REJECT**.
 - After a call begins, the approximate length of the call is shown on the display.
- To end the call, press [📞].

Note

- The other party must know the IP address of the unit in order to call you on the IP line when the unit is in peer to peer mode (see page 25). To confirm the IP address, press **[MENU]**→"Show IP Address"→**SELECT**.
- During the first 30 seconds of a TEL call, the unit adjusts itself for optimal sound quality. Speak in turns with the other party at the beginning of a conversation. (The time required varies depending on the condition of the telephone line and the audio characteristics of the room.) During this time, sound may cut out or fade in and out. This is normal.

Adjusting the Ringer Volume

When the unit is in standby mode or is receiving a call, press [^] or [v] repeatedly to adjust the ringer volume. There are 4 levels of volume, including "Off".



Receiving a Second Call (Call Waiting)

While on a call, you can receive a second call, and then join the 2 calls and establish a conference call.

While on an IP call:

You can receive a TEL call. When in peer to peer mode (see page 25), you can receive an additional IP call.

While on a TEL, PS, or PC call:

You can receive an IP call.

Note

- In order to use this feature, the "Call Waiting" setting (see page 48) must be set to "Enable" (this is the default setting).
- When a second call is received, a call waiting tone will be heard. See page 48 to adjust the call waiting tone volume.

Refusing a second call

Press **REJECT**. The second caller is disconnected and the current call continues.

Confirming the caller then creating a conference call

- Press **ANSWER**.
 - The first call is put on hold, and you can talk to the second caller.
 - To end the second call, press **END**, then continue the first call.
- Press **CONF** to establish a conference call.

Creating a conference call immediately

Press **CONF**.

Ending a conference call

Press [📞] to disconnect both parties.

or

- Press **END**.
 - Press **BACK** to continue the call.
- Press [^] or [v] repeatedly to select the party you would like to remove from the conference, then press **SELECT**.
 - The selected party is disconnected and you can continue to speak with the remaining party.
 - To disconnect both parties, select "All", then press **SELECT**.

Useful Features Available During a Call

Mute

You can mute your voice during a conversation. While the mute is turned on, you will be able to hear the other party, but the other party will not be able to hear you. To mute your voice, press [**Mute**]. To return to the conversation, press [**Mute**] again.

Note

- While the mute is turned on, "Mute" is displayed and the indicators light in red.
- All built-in microphones and each External Wired MIC are muted when the mute is turned on.

Flash

Pressing [**FLASH**] allows you to use optional telephone company services, such as call waiting, or PBX features, such as extension transfers.

Note

- To change the flash time, see page 49.
- This feature is not available for IP calls.

Speech Speed Conversion

You can adjust the speed of the other party's speech down during a call by pressing [**SPEED**].

The following speech speed modes are available.

- **Talking Mode** (slight speed reduction)
Recommended for calls in which you and the other party are equally participating in the conversation.
- **Listening Mode** (greater speed reduction)
Recommended for calls in which the other party is speaking more, and you are listening.

You can select the desired mode by pressing [**SPEED**] during a call. Each time the button is pressed, the setting changes and is shown briefly on the display.

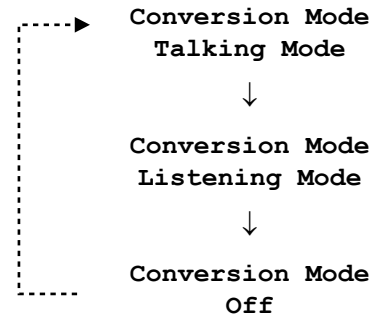

Note

- "Slow" is shown on the display while this feature is active.
- If the other party speaks for more than 5 seconds without stopping, this feature will stop functioning. Once the other party stops talking for about 1 second, this feature will function again.
- When this feature is turned off, the other party's speech may cut out briefly.

Mic Noise Reduction

You can press the [**MIC NOISE CUT**] button during a call to reduce the ambient noise that is picked up by the microphones and sent to the other party. Each time the button is pressed, the setting changes and is shown briefly on the display.

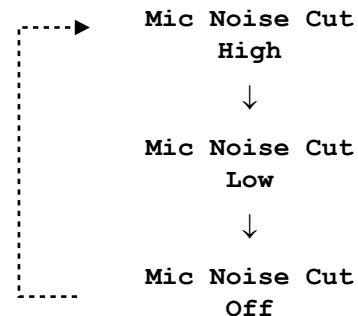







Note

- "Noise Cut ON" is shown on the display while this feature is active.
- The quality of the sound heard by the other party decreases slightly while this feature is active.

Adding Entries to the Phonebook

You can add 100 names and phone numbers or IP addresses to the phonebook.

To make a call from the phonebook, see page 32.

1. Press  .
 - The display shows the number of entries in the phonebook.
 - Entries cannot be added to the phonebook when the PS line or PC line is selected.
2. Press  .
3. Enter the name (max. 16 characters), then press **[ENTER]**.
 - See page 38 for information on entering characters.
 - To insert a space when there is no character under the cursor, press  .
 - To insert a space after the last character entered, press  two times.
 - You can also enter a space by pressing **[0]** when in alphabet entry mode or extended entry mode.
4. Press **[^]** or **[v]** to select the line ("IP" or "TEL") that will be used when you call the entry, then press  .
5. Enter the phone number (max. 32 digits) or IP address, then press **[ENTER]** or  .
 - Whether an IP line phonebook entry is assigned a phone number or an IP address is determined by the "Operation Mode" setting (see page 25). When the unit is in IP-PBX mode, each new IP line entry is assigned a phone number. When the unit is in peer to peer mode, each new IP line entry is assigned an IP address.
 - IP addresses can be entered using the keypad. **[0]–[9]** are used to enter numbers and **[*]** is used to enter a period. For example, to enter "192.168.0.1", press **[192*168*0*1]**.
 - To temporarily use tone dialing when the line mode is set to pulse mode, press **[*]**.
 - If a pause is required when making a call on the TEL line (see page 32), press **[REDIAL/PAUSE]** between digits as necessary.
 - To add an another entry, press  , then continue from step 3.
6. Press **[MENU]**.

Note

- If you do not press any buttons for 1 minute, the unit will return to standby mode.
- An entry cannot have both a phone number and an IP address.

Entering Characters

The dial keys are used to enter characters and numbers. Each dial key has multiple characters assigned to it. To enter a character, press the appropriate dial key, repeatedly if necessary. To enter another character that is assigned to the same dial key, first press  to move the cursor to the right.

Character Entry Modes

When adding entries to the phonebook, the following character entry modes are available. The current entry mode is shown in the upper-right corner of the display.

[ABC2]: Displayed when alphabet entry mode is selected.



[1234]: Displayed when numeric entry mode is selected.

[AAA2]: Displayed when extended entry mode is selected.

Press  to switch the character entry mode. Press **[*]** to change between uppercase and lowercase character entry.

See page 38 for a list of all available characters.

Correcting a Mistake

To correct a mistake, press  or  to move the cursor to the desired position, then follow one of the procedures below.

- To add a character or number, press the appropriate dial key.
- To erase the selected character or number, press .

To erase all characters and numbers, press and hold .

Editing Entries

1. Search for the desired phonebook entry (see page 32).
2. Press  .
3. Edit the name if necessary, then press **[ENTER]**.

4. Press [**^**] or [**v**] to select the line ("IP" or "TEL") that will be used when you call the entry, then press **SELECT** .
5. Edit the phone number or IP address if necessary, then press **ENTER** or **SAVE** .
6. Press **MENU**.

Note

- If you do not press any buttons for 1 minute, the unit will return to standby mode.

Erasing Entries

Erasing 1 Entry

1. Search for the desired phonebook entry (see page 32).
2. Press **ERASE** .
3. Press **YES** .
 - To cancel, press **NO** .
4. Press **MENU**.

Erasing All Entries

1. Press **☰** .
2. Press **ERASE** .
3. Press **YES** .
4. Press **MENU**.

Note

- You can also erase entries using the "**Erase All Phonebook Data**" feature (see page 56).

Character Tables

Character Tables

Dial Key	Alphabet Entry Mode	Extended Character Entry Mode
0	Space () < > [] { } 0	Space () < > [] { } 0
1	! " % ' * - . \ ^ _ ` ~ 1	! " % ' * - . \ ^ _ ` ~ 1
2	A B C 2	A B C À Á Â Ã Ä Å Æ Ç 2
	a b c 2	a b c à á â ã ä å æ ç 2
3	D E F 3	D E F È É Ê Ë Ì 3
	d e f 3	d e f è é ê ë ì 3
4	G H I 4	G H I Ğ Ì Í Î Ï Ĵ Ķ 4
	g h i 4	g h i ğ ì í î ï ĵ ķ 4
5	J K L 5	J K L 5
	j k l 5	j k l 5
6	M N O 6	M N O Ñ Ò Ó Ô Õ Ö Ø 6
	m n o 6	m n o ñ ò ó ô õ ö ø 6
7	P Q R S 7	P Q R S Ş ß 7
	p q r s 7	p q r s ş ß 7
8	T U V 8	T U V Ù Ú Û Ü Û 8
	t u v 8	t u v ù ú û ü Û 8
9	W X Y Z 9	W X Y Z Ŵ Ŷ 9
	w x y z 9	w x y z ŵ ŷ 9
*	Changes between uppercase and lowercase character entry.	Changes between uppercase and lowercase character entry.
#	\$ & + , / : ; = ? @ #	\$ & + , / : ; = ? @ #

Note

- A space counts as one character.

Recording Features

Conversations and voice memos can be recorded to an SD memory card.

SD Memory Card Information

Confirm the following before recording to an SD memory card.

- A compatible card is inserted (see page 26)
 - When an SD memory card is inserted, **SD** is shown in the upper-left corner of the display.
- The card has been formatted using the correct format (see page 27).
- The card is not locked (see page 26).
 - If you insert a locked card, "**Write Protected**" is displayed.

Note

- No more than 100 recordings can be made, regardless of the SD memory card capacity.
- When "**Memory Full**" is displayed, recording is not possible until other recordings are erased. If the card becomes full while recording, recording will stop. See page 26 for information on approximate recording time.
- While recording, if the amount of recording time available is less than 6 minutes, "**Remaining Time Less Than 6 Min.**" is displayed briefly, and the display's backlight flashes until recording stops. When less than 1 minute is available, "**Remaining Time Less Than 1 Min.**" is briefly displayed.
- When recording telephone conversations, we recommend informing the other party that the conversation is being recorded.
- Be sure to comply with applicable local regulations (laws, ordinances, guidelines, etc.) regarding telephone conversation recording.

Recording Conversations



1. Press **REC** during a conversation.
 - "**Remaining Time**" and the approximate recording time available are displayed briefly, then "**Conf Recording**" and the approximate length of the call are displayed.
2. To stop recording, press **STOP**.
 - Recording stops automatically when **[END]** is pressed.

Recording Voice Memos

Voice memos (i.e., recordings made when you are not on a call) can also be recorded.

1. Press **[MENU]** while you are not on a call.
2. Select "**Voice Memo**", then press **REC**.
 - "**Remaining Time**" and the approximate recording time available are displayed briefly, then "**Memo Recording**" and the approximate length of the call are displayed.
3. To stop recording, press **STOP**.
 - Recording stops automatically when a call is received.

Playing Back Recordings

1. Press **PLAY**.
2. Press **[^]** or **[v]** repeatedly to scroll through the list of recordings, then press **SELECT**.
 - Recorded conversations are displayed as  plus the date and time of the recording. Voice memos are displayed as  plus the date and time of the recording.
3. Press **PLAY**.
 - Press **[BACK]** to stop playback.
 - If the selected recording is less than 1 second long, "**Unable To Use**" is displayed and the recording cannot be played back.
4. Press **[MENU]** to exit.

Note

- Recordings are saved in PCM format and can be played back on a computer using Windows Media® Player or QuickTime®. Recordings are

stored on the SD memory card in the following folder: "\\PRIVATE\\MEIGROUP\\PCC\\IPSP".

- When accessed by a computer, recordings are displayed as "REC" plus a 3 digit number (000–100; the lowest available number is used when a file is saved on the SD memory card). The file extension is ".WAV".

Example: "REC001.WAV"

- If the names of files or folders are changed using a computer, the recordings cannot be played back using the unit.

Features Available During Playback

The following features are available during playback.

Feature	Operation
Volume control	Press [^] or [v]
Play next recording	Press [#] ([▶▶]) then PLAY
Play current recording again	Press [*] ([◀◀]) then PLAY
Play previous recording	Press [*] ([◀◀]) 2 times, then PLAY
Fast forward	Press ▶▶ for 4× speed Press ▶▶ again for 60× speed Press PLAY for playback
Rewind	Press ◀◀ for 4× speed Press ◀◀ again for 60× speed Press PLAY for playback
Pause	Press [0] ([]) Press PLAY to resume playback
Erase current recording	Press ERASE , then YES .

Erasing Recordings

Erasing 1 Recording

- Press **PLAY**.
- Press [^] or [v] repeatedly to scroll through the list of recordings, then press **ERASE**.
- Press **YES**.
 - "Erased" is displayed.
- Press **[MENU]**.

Note

- To erase a recording while listening to it, press **ERASE**, then press **YES**.

Erasing All Recordings

- Press **PLAY**.
- Press **ERASE**.
- Press **YES**.
 - "All Erased" is displayed.

Using a Portable Station (PS)

By connecting the unit to a PS, you can use the unit's microphones and speaker for calls made or received with the PS.

Compatible Portable Stations (as of July, 2008)

- KX-TD7680
- KX-TD7685
- KX-TD7690
- KX-TD7695
- KX-TD7684
- KX-TD7696
- KX-TD7694

Line Selection (IP + PS)

1. Press **[MENU]**.
2. Press **[LINE]**.
3. Select "IP + PS".
 - When "Line Selection" is set to "IP + PS", TEL calls cannot be made or received.
4. Press **[SAVE]**.
5. Press **[MENU]**.

Using a PS

1. Confirm that "PS" is shown in the upper-right corner of the display.
 - You can change the selected line by pressing the center function button (**[F2]**).

The IP line is selected.

The PS line is selected.



[F2]



[F2]

- If you cannot select "PS", change the "Line Selection" setting to "IP + PS" (explained on this page).

2. Make or answer a call using the PS.

3. Connect the included PS Cable to the **[AUDIO IN/OUT]** jack of the unit (1), and to the headset jack of the PS.

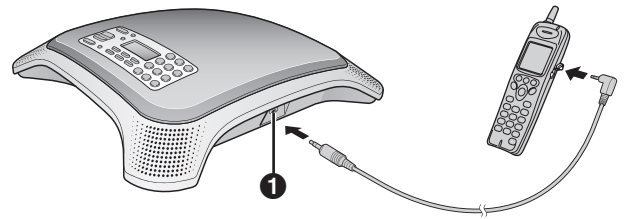

- Make sure the plug of the PS Cable is inserted fully into the unit and PS, otherwise sound may not be heard, or echoing and feedback may occur.
 - Place the PS as far away from the unit as possible.
4. Press **[MUTE]** to begin using the unit's microphones and speaker.
 - Press **[MUTE]** again to turn off the microphones and speaker.
 5. Use the PS to end the call.
 6. Turn off the unit's microphones and speaker by pressing **[MUTE]**.

Note

- For best performance, we recommend setting the receiver volume of the PS as follows:
 - 4-volume level models: level 3
 - 6-volume level models: level 4
- For best performance, do not change the speaker (receiver) volume of the PS frequently during a call. Echoing or feedback may occur.
- The microphone and receiver of the PS cannot be used while the PS is connected to the unit.
- This feature will not function when a mobile phone or incompatible PS is connected to the unit.

Using a Computer

By connecting the unit to a computer, you can use the unit's microphones and speaker for calls made or received with the computer using your preferred IP phone software.

Connecting a Computer

Connect the included PC Cable to the **[AUDIO IN/OUT]** jack of the unit (1), and to the microphone jack (red plug; 2) and headphone jack (green plug; 3) of the computer.

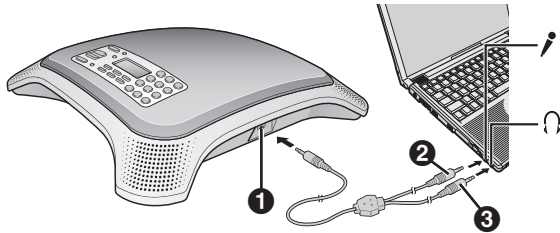

Note

- The microphone and speaker of the computer cannot be used while the computer is connected to the unit.

Line Selection (IP + PC)

- Press **[MENU]**.
- Press **LINE**.
- Select "IP + PC".
 - When "Line Selection" is set to "IP + PC", TEL calls cannot be made or received.
- Press **SAVE**.
- Press **[MENU]**.

Using a Computer

- Confirm that "PC" is shown in the upper-right corner of the display.
 - You can change the selected line by pressing the center function button (**[F2]**).

The IP line is selected.

The PC line is selected.

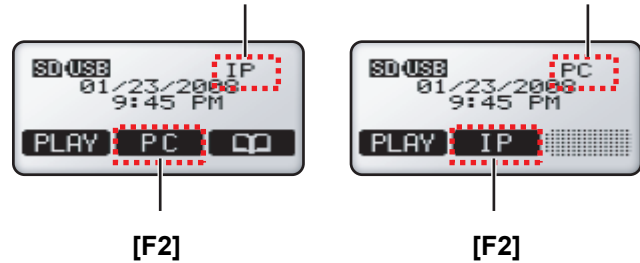

- If you cannot select "PC", change the "Line Selection" setting to "IP + PC" (explained on this page).
- Press **[MUTE]** to begin using the unit's microphones and speaker.
 - Press **[MUTE]** again to turn off the microphones and speaker.
 - Use the desired computer software to make or answer a call.
 - Use the computer to end the call.
 - Turn off the unit's microphones and speaker by pressing **[MUTE]**.

Note

- Leave at least 50 cm (about 20 in.) of space between the unit and the computer.

Changing and Confirming Settings

Settings can be programmed and confirmed from the front panel. To use Conferencing Phone Manager (found on the included CD-ROM) to program the unit from a computer, see page 58.

Changing Settings

Using the Front Panel

1. Press **[MENU]**.
2. Press **[^]** or **[v]** to select the desired programming category, then press **SELECT**.
3. Press **[^]** or **[v]** to select the desired parameter, then press **SELECT**.
4. Adjust the settings as desired.
 - To cancel without changing any settings, press **[MENU]**.
5. Press **SAVE**.
6. Press **[MENU]**.

Note

- When programming the unit from the front panel, the current setting is indicated on the display by "✓".
 - To return to the previous screen, press **[BACK]**.
 - If you do not press any buttons for 1 minute, the unit will return to standby mode.
 - The following parameters cannot be programmed, and are therefore not displayed, when the unit is in use.
 - Operation Mode
 - Language
 - Date & Time
 - Time Format
 - Ringer Volume
 - Ringtone
 - IP Network Settings (all parameters)
 - Protocol Settings (all parameters)
 - VoIP Settings (all parameters)
 - QoS Settings (all parameters)
- Additionally, the following parameters cannot be programmed, and are therefore not displayed, when the TEL, PS, or PC line is in use.
- Line Selection

- TEL Settings (all parameters)

Using Conferencing Phone Manager

To use Conferencing Phone Manager (found on the included CD-ROM) to program the unit from a computer, see page 58.

Restarting the Unit

After changing the following parameters, the unit must be restarted in order for the new settings to take effect. (Data is not erased when the unit is restarted.)

- Operation Mode (page 46)
- IP Address Mode (page 49)
- IP Address (page 50)
- Subnet Mask (page 50)
- Default Gateway (page 50)
- SIP Ext. No. (page 50)
- SIP Password (page 51)
- SIP User Domain Name (page 51)
- SIP Proxy Server IP Address (page 51)
- SIP Registrar IP Address (page 51)
- Hold Method (page 51)
- SIP Signaling Port Number (page 52)
- VLAN ID (page 53)
- VLAN Priority (page 53)
- SIP ToS Field (page 53)
- RTP ToS Field (page 53)

1. Press **[MENU]**.
2. Select "System Options", then press **SELECT**.
3. Select "Reboot", then press **SELECT**.
4. Select "Yes", then press **SELECT**.

Note

- To use Conferencing Phone Manager to restart the unit, see page 58.
- You can also restart the unit by turning it off and on again:
 - **When using the AC adaptor:** Disconnect the AC adaptor from the AC outlet, then connect it again.
 - **When using PoE:** Disconnect the LAN cable from the unit, then connect it again.

Parameter List

The following is a list of all programmable parameters. See the references listed here for information about each parameter.

Programming Category	Parameter	Reference
└ Show IP Address		page 46
└ Operation Mode		page 46
└ Basic Settings	└ Language	page 46
	└ Date & Time	page 47
	└ Time Format	page 47
	└ Ringer Volume	page 47
	└ Ringtone	page 47
	└ LCD Contrast	page 47
	└ Key Tones	page 48
	└ Call Waiting Tone Volume	page 48
	└ Call Waiting	page 48
└ Line Selection		page 48
└ TEL Settings	└ Dial Mode	page 48
	└ Flash Time	page 49
	└ Pause Time	page 49
	└ TEL Line Level Reduction	page 49
└ IP Network Settings	└ IP Address Mode	page 49
	└ IP Address	page 50
	└ Subnet Mask	page 50
	└ Default Gateway	page 50
└ Protocol Settings	└ SIP Ext. No.	page 50
	└ SIP Password	page 51
	└ SIP User Domain Name	page 51
	└ SIP Proxy Server IP Address	page 51
	└ SIP Registrar IP Address	page 51
	└ Hold Method	page 51
↓		

Programming Category	Parameter	Reference
↑		
└─ VoIP Settings	└─ Preferred CODEC	page 52
	└─ RTP Packet Size	page 52
	└─ SIP Signaling Port Number	page 52
	└─ RTP Port Number (Minimum)	page 52
	└─ RTP Port Number (Maximum)	page 52
└─ QoS Settings	└─ VLAN ID	page 53
	└─ VLAN Priority	page 53
	└─ SIP ToS Field	page 53
	└─ RTP ToS Field	page 53
└─ System Status Confirmation	└─ Software Version	page 54
	└─ IP Address	page 54
	└─ Subnet Mask	page 54
	└─ Default Gateway	page 54
	└─ DHCP Server	page 54
	└─ MAC Address	page 54
└─ System Options	└─ Erase All Call Log Data	page 54
	└─ Erase All Phonebook Data	page 54
	└─ Reset System Data	page 54
	└─ Reset All Data	page 55
	└─ Reboot	page 55

Parameters

When programming the unit from the front panel, the current setting is indicated on the display by "✓".

Show IP Address

Description	Available Settings	Default Setting
Allows you to confirm the unit's IP address. To change the IP address, see page 24.	—	192.168.0.2

Operation Mode

Description	Available Settings	Default Setting
Determines the mode used to make and receive IP calls. <ul style="list-style-type: none"> If this setting is changed, the unit must be restarted before the new setting becomes effective (see page 43). 	<input type="checkbox"/> IP-PBX <input type="checkbox"/> Peer to Peer	IP-PBX

Basic Settings

Language

Description	Available Settings	Default Setting
Determines the display language. Use the following procedure to change the language. <ol style="list-style-type: none"> Press [MENU]. Press [^] 10 times. Press [ENTER] two times. Press [^] or [v] repeatedly to select the desired language. Press [ENTER]. Press [MENU]. 	<input type="checkbox"/> English (US) <input type="checkbox"/> Español <input type="checkbox"/> Français <input type="checkbox"/> Français (C) <input type="checkbox"/> Italiano <input type="checkbox"/> Nederlands <input type="checkbox"/> Português <input type="checkbox"/> Deutsch <input type="checkbox"/> English (UK)	English (US)

Date & Time

Description	Available Settings	Default Setting
<p>The date and time are shown on the display in standby mode, and are displayed when playing conversations that were recorded to an SD memory card.</p> <ul style="list-style-type: none"> Using the keypad, enter 2 digits each for the year, month, day of the month, hour (24-hour format), and minute. Example: To enter "Jan. 23, 2008, 7:45 PM", press [0801231945]. To correct a mistake, press < to move the cursor as needed, then enter the correct number. 	Year, month, day of the month, hour (24-hour format), minute	<p>Jan. 1, 2008, 12:00 AM</p> <p>Date format is determined by the display language (see page 46). English (US): MM/DD/YYYY Español: DD/MM/YYYY Français: DD/MM/YYYY Français (C): YYYY-MM-DD Italiano: DD/MM/YYYY Nederlands: DD-MM-YYYY Português: DD-MM-YYYY Deutsch: DD.MM.YYYY English (UK): DD/MM/YYYY</p>

Time Format

Description	Available Settings	Default Setting
Determines the time format.	<input type="checkbox"/> 12-hour <input type="checkbox"/> 24-hour	12-hour

Ringer Volume

Description	Available Settings	Default Setting
Determines the ringer volume.	4 levels including "OFF"	High

Ringtone

Description	Available Settings	Default Setting
Determines the ringtone.	<input type="checkbox"/> Tone Pattern 1 <input type="checkbox"/> Tone Pattern 2 <input type="checkbox"/> Tone Pattern 3	Tone Pattern 1

LCD Contrast

Description	Available Settings	Default Setting
Determines the LCD contrast.	6 levels	Level 3

Key Tones

Description	Available Settings	Default Setting
Determines whether tones are heard when the unit's buttons are pressed.	<input type="checkbox"/> On <input type="checkbox"/> Off	On

Call Waiting Tone Volume

Description	Available Settings	Default Setting
Determines the volume of the call waiting tone heard when a second call is received.	<input type="checkbox"/> High <input type="checkbox"/> Low	High

Call Waiting

Description	Available Settings	Default Setting
Determines whether a call can be received when you are already on another call.	<input type="checkbox"/> Enable <input type="checkbox"/> Disable	Enable

Line Selection

Description	Available Settings	Default Setting
Determines which lines can be used to make and receive calls.	<input type="checkbox"/> IP + TEL <input type="checkbox"/> IP + PC <input type="checkbox"/> IP + PS	IP + TEL

TEL Settings

Dial Mode

Description	Available Settings	Default Setting
Determines the dial mode used for the TEL line. <ul style="list-style-type: none"> Set this parameter to match the specification of the TEL line. 	<input type="checkbox"/> Pulse <input type="checkbox"/> Tone	Tone

Flash Time

Description	Available Settings	Default Setting
<p>Determines the flash time.</p> <ul style="list-style-type: none"> Set this parameter to match the specification of the TEL line. 	<input type="checkbox"/> 900 ms <input type="checkbox"/> 700 ms <input type="checkbox"/> 600 ms <input type="checkbox"/> 400 ms <input type="checkbox"/> 300 ms <input type="checkbox"/> 250 ms <input type="checkbox"/> 200 ms <input type="checkbox"/> 160 ms <input type="checkbox"/> 110 ms <input type="checkbox"/> 100 ms <input type="checkbox"/> 90 ms <input type="checkbox"/> 80 ms	700 ms

Pause Time

Description	Available Settings	Default Setting
<p>Determines the length of the dialing pause inserted when [REDIAL/PAUSE] is pressed.</p>	<input type="checkbox"/> 3 s <input type="checkbox"/> 5 s	3 s

TEL Line Level Reduction

Description	Available Settings	Default Setting
<p>Determines whether the incoming TEL line signal level is reduced. Set this feature to "On" if the volume of your voice heard from the speaker is too loud.</p> <ul style="list-style-type: none"> When set to "On", the other party's voice will be slightly quieter. We recommend setting this feature to "On" when establishing conference calls that use the TEL line. 	<input type="checkbox"/> On <input type="checkbox"/> Off	Off

IP Network Settings

Consult your system administrator for the appropriate settings.

IP Address Mode

Description	Available Settings	Default Setting
<p>Determines whether the unit's IP address is assigned automatically (DHCP) or manually (static).</p> <ul style="list-style-type: none"> If this setting is changed, the unit must be restarted before the new setting becomes effective (see page 43). 	<input type="checkbox"/> DHCP <input type="checkbox"/> Static	Static

IP Address

Description	Available Settings	Default Setting
<p>Determines the unit's IP address.</p> <ul style="list-style-type: none"> This parameter is only available when "IP Address Mode" is set to "Static". If this setting is changed, the unit must be restarted before the new setting becomes effective (see page 43). 	—	192.168.0.2

Subnet Mask

Description	Available Settings	Default Setting
<p>Set this parameter to match the IP address of the IP network's subnet mask.</p> <ul style="list-style-type: none"> This parameter is only available when "IP Address Mode" is set to "Static". If this setting is changed, the unit must be restarted before the new setting becomes effective (see page 43). 	—	255.255.255.0

Default Gateway

Description	Available Settings	Default Setting
<p>Set this parameter to match the IP address of the IP network's default gateway.</p> <ul style="list-style-type: none"> This parameter is only available when "IP Address Mode" is set to "Static". If this setting is changed, the unit must be restarted before the new setting becomes effective (see page 43). 	—	0.0.0.0

Protocol Settings

Consult your system administrator for the appropriate settings.

SIP Ext. No.

Description	Available Settings	Default Setting
<p>Set this parameter to match the extension number assigned to the unit through PBX programming.</p> <ul style="list-style-type: none"> If this setting is changed, the unit must be restarted before the new setting becomes effective (see page 43). 	Max. 32 digits	—

SIP Password

Description	Available Settings	Default Setting
Set this parameter to match the password assigned to the unit through PBX programming. <ul style="list-style-type: none"> If this setting is changed, the unit must be restarted before the new setting becomes effective (see page 43). 	Max. 32 characters	—

SIP User Domain Name

Description	Available Settings	Default Setting
Set this parameter to match the IP address of the IP-PBX. <ul style="list-style-type: none"> If this setting is changed, the unit must be restarted before the new setting becomes effective (see page 43). 	—	—

SIP Proxy Server IP Address

Description	Available Settings	Default Setting
Set this parameter to match the IP address of the IP-PBX. <ul style="list-style-type: none"> If this setting is changed, the unit must be restarted before the new setting becomes effective (see page 43). 	—	0.0.0.0

SIP Registrar IP Address

Description	Available Settings	Default Setting
Set this parameter to match the IP address of the IP-PBX. <ul style="list-style-type: none"> If this setting is changed, the unit must be restarted before the new setting becomes effective (see page 43). 	—	0.0.0.0

Hold Method

Description	Available Settings	Default Setting
Determines the hold protocol used for the IP line. <ul style="list-style-type: none"> If this setting is changed, the unit must be restarted before the new setting becomes effective (see page 43). 	<input type="checkbox"/> RFC2543 <input type="checkbox"/> RFC3264	RFC3264

VoIP Settings

Preferred CODEC

Description	Available Settings	Default Setting
Determines the preferred codec for IP calls.	<input type="checkbox"/> G.722 <input type="checkbox"/> G.711 μ -law <input type="checkbox"/> G.711A-law <input type="checkbox"/> G.729a	G.722

RTP Packet Size

Description	Available Settings	Default Setting
Determines the size of outgoing RTP packets.	<input type="checkbox"/> 20 ms <input type="checkbox"/> 30 ms <input type="checkbox"/> 40 ms <input type="checkbox"/> 50 ms <input type="checkbox"/> 60 ms	20 ms

SIP Signaling Port Number

Description	Available Settings	Default Setting
Determines the port number used for SIP signaling. <ul style="list-style-type: none"> If this setting is changed, the unit must be restarted before the new setting becomes effective (see page 43). 	5060–5070	5060

RTP Port Number (Minimum)

Description	Available Settings	Default Setting
Determines the lowest port number used for RTP. <ul style="list-style-type: none"> Set this parameter to a value lesser than the setting for "RTP Port Number (Maximum)". 	51000–51998 (even values only)	51000

RTP Port Number (Maximum)

Description	Available Settings	Default Setting
Determines the highest port number used for RTP. <ul style="list-style-type: none"> Set this parameter to a value greater than the setting for "RTP Port Number (Minimum)". 	51002–52000 (even values only)	52000

QoS Settings

VLAN ID

Description	Available Settings	Default Setting
Determines the VLAN ID. <ul style="list-style-type: none"> If this setting is changed, the unit must be restarted before the new setting becomes effective (see page 43). 	0001–4095	4095

VLAN Priority

Description	Available Settings	Default Setting
Determines the VLAN priority. <ul style="list-style-type: none"> If this setting is changed, the unit must be restarted before the new setting becomes effective (see page 43). 	0–7	0

SIP ToS Field

Description	Available Settings	Default Setting
Determines the value of the SIP ToS Field. <ul style="list-style-type: none"> If this setting is changed, the unit must be restarted before the new setting becomes effective (see page 43). 	8-bit binary code	00000000

RTP ToS Field

Description	Available Settings	Default Setting
Determines the value of the RTP ToS Field. <ul style="list-style-type: none"> If this setting is changed, the unit must be restarted before the new setting becomes effective (see page 43). 	8-bit binary code	00000000

System Status Confirmation

Description
<p>The settings for the following parameters can be displayed for confirmation.</p> <ul style="list-style-type: none"> – Software Version – IP Address – Subnet Mask – Default Gateway – DHCP Server – MAC Address

System Options

Erase All Call Log Data

Description
<p>Allows you to erases all entries in the redial list.</p>

Erase All Phonebook Data

Description
<p>Allows you to erase all entries in the phonebook.</p>

Reset System Data

Description
<p>Allows you to reset all system data (i.e., the parameters described in this section) to the factory default settings.</p> <ul style="list-style-type: none"> • After executing this feature, the unit will restart automatically. • The following data and settings <i>are not erased</i> when this feature is executed. <ul style="list-style-type: none"> – "Date & Time" setting (note that the "Time Format" setting is reset) – Phonebook entries – Redial list – SD memory card recordings

Reset All Data

Description
<p>Allows you to reset all system data (i.e., the parameters described in this section), user data, and all settings. The unit is returned to its factory default state when this feature is executed.</p> <ul style="list-style-type: none">• After executing this feature, the unit will restart automatically.• The following data and settings <i>are not erased</i> when this feature is executed.<ul style="list-style-type: none">– SD memory card recordings• The following data and settings are erased when this feature is executed.<ul style="list-style-type: none">– "Date & Time" setting– Phonebook entries– Redial list

Reboot

Description
<p>Allows you to restart the unit.</p> <ul style="list-style-type: none">• No data is erased when this feature is executed.

Erasing Data

The following features allow you to erase system data and user data stored in the unit.

Erase All Call Log Data

Allows you to erase all entries in the redial list.

Erase All Phonebook Data

Allows you to erase all entries in the phonebook.

Reset System Data

Allows you to reset all system data to the factory default settings.

- The following data and settings *are not erased* when this feature is executed.
 - "Date & Time" setting (note that the "Time Format" setting is reset)
 - Phonebook entries
 - Redial list
 - SD memory card recordings

Reset All Data

Allows you to reset all system data, user data, and all settings. The unit is returned to its factory default state when this feature is executed.

- The following data and settings *are not erased* when this feature is executed.
 - SD memory card recordings
- The following data and settings **are erased** when this feature is executed.
 - "Date & Time" setting
 - Phonebook entries
 - Redial list

Note

- These features do not erase the contents of the SD memory card. To erase the SD memory card, see page 40.

Erasing the Redial List

1. Press [MENU].
2. Select "System Options", then press [SELECT].
3. Select "Erase All Call Log Data", then press [SELECT].
4. Select "Yes", then press [SELECT].
5. Press [MENU].

Erasing the Phonebook

1. Press [MENU].

2. Select "System Options", then press [SELECT].
3. Select "Erase All Phonebook Data", then press [SELECT].
4. Select "Yes", then press [SELECT].
5. Press [MENU].

Resetting System Data

1. Press [MENU].
2. Select "System Options", then press [SELECT].
3. Select "Reset System Data", then press [SELECT].
4. Select "Yes", then press [SELECT].
 - The unit will restart automatically.

Resetting All Data

Notice

- The unit is returned to its factory default state when this feature is executed. All user data (except for the contents of the SD memory card) will be erased.

1. Press [MENU].
2. Select "System Options", then press [SELECT].
3. Select "Reset All Data", then press [SELECT].
4. Select "Yes", then press [SELECT].
 - The unit will restart automatically.

Using Conferencing Phone Manager

The unit can be used in conjunction with Conferencing Phone Manager. This software can be found on the included CD-ROM, and allows you to operate and program the unit using a computer. For software installation instructions, see page 29.

Connecting a Computer

Connect the included USB cable to the USB port of the unit (1) and of the computer.

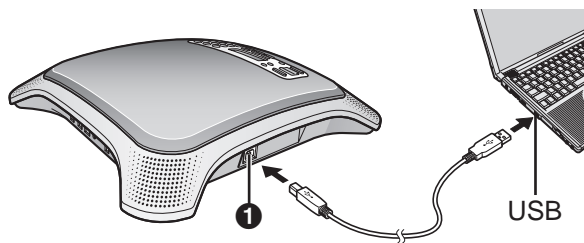

Note

- We recommend using only the included USB cable when connecting the unit to a computer via USB.

Starting Conferencing Phone Manager

You can start Conferencing Phone Manager using any of the following methods.

- **Using the shortcut icon**
Double-click the Conferencing Phone Manager shortcut icon on the desktop (created during software installation).



- **From the [Start] menu**
Click [Start]→[All Programs]→[Panasonic]→[Conferencing Phone Manager]→[Conferencing Phone Manager].

After Conferencing Phone Manager starts, the front panel screen is displayed.

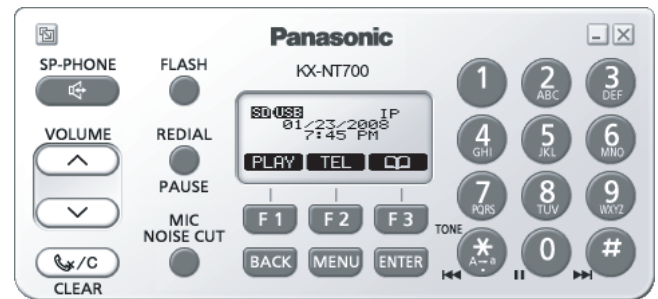

Exiting Conferencing Phone Manager

To exit, click the icon (X) in the upper-right corner of the front panel screen.

Operating the Unit Using Conferencing Phone Manager

From the front panel screen, you can operate the unit just as if you were using the front panel of the unit itself. For information about using the following commonly used features, refer to pages listed below.

- Making calls (page 31)
- Answering calls (page 34)
- Adding entries to the phonebook (page 36)

For information about other features, refer to the relevant sections in this document.

Programming the Unit Using Conferencing Phone Manager

1. Start Conferencing Phone Manager (see page 57).
2. Click the icon () in the upper-left corner of the front panel screen.
 - The programming screen is displayed.

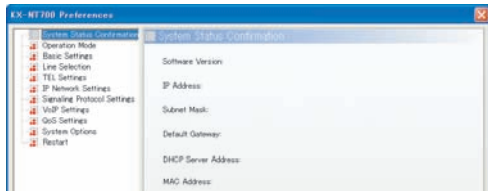

3. Click the desired programming category name on the left side of the screen.
 - The corresponding parameters are displayed on the right side of the screen.

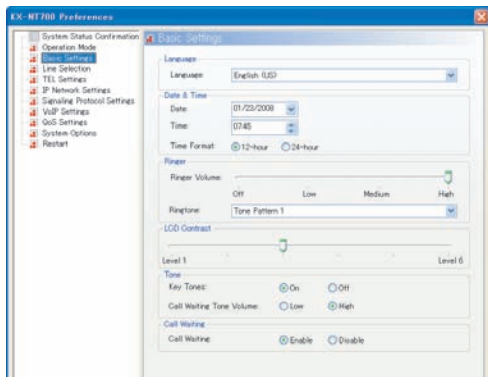

4. Change the parameters as desired.
5. Click **[OK]**.
 - The front panel screen is displayed again.
 - To cancel without changing any settings, click **[Cancel]**.

Note

- If the unit must be restarted before the new settings become effective, a dialog will prompt you to restart the unit. Click **[Yes]** to restart the unit.

Restarting the Unit Using Conferencing Phone Manager

1. Click the icon () in the upper-left corner of the front panel screen.
 - The programming screen is displayed.
2. Click **[Restart]**.
3. Click **[Restart]**, then click **[Yes]**.
 - The front panel screen is displayed again.

Troubleshooting

If you are experiencing trouble, refer to the information in this section. Before troubleshooting, confirm all connections (see page 22) and confirm that the AC outlet or PoE device to which the unit is connected to is receiving power.

General Use

Issue	Possible Cause & Solution	Reference
The display is blank.	<ul style="list-style-type: none"> The unit is not receiving power. <ul style="list-style-type: none"> → The unit is not designed to function when there is a power failure. Make sure that the unit is connected to the AC outlet and receiving power. If using PoE, confirm that the device supplying PoE is receiving power and that the LAN cable is properly connected. 	page 22
The unit is not performing properly.	<ul style="list-style-type: none"> Cables or cords are not connected properly. <ul style="list-style-type: none"> → Check all connections. 	page 22
	<ul style="list-style-type: none"> An error has occurred. <ul style="list-style-type: none"> → Reset the unit. Disconnect the unit from the AC outlet, wait 10 seconds, then connect the AC adaptor again. If using PoE, disconnect the LAN cable, wait 10 seconds, then connect the LAN cable again. 	page 22

Making and Receiving Calls

Issue	Possible Cause & Solution	Reference
I cannot make IP calls.	<ul style="list-style-type: none"> The IP line is not selected. <ul style="list-style-type: none"> → Before dialing, confirm that "IP" is shown in the upper-right corner of the display. Press the center function button ([F2]) to change the line if necessary. 	page 30
	<ul style="list-style-type: none"> The IP address was entered incorrectly. <ul style="list-style-type: none"> → Confirm that you have entered the IP address of the other party correctly. 	page 31
	<ul style="list-style-type: none"> The "Operation Mode" setting is not correct. <ul style="list-style-type: none"> → Change the setting to "Peer to Peer" if you want to make or receive peer to peer IP calls (i.e., calls made by specifying the called party's IP address). → Change the setting to "IP-PBX" if you want to make or receive intercom and outside calls as a SIP extension of the connected PBX. 	page 25
	<ul style="list-style-type: none"> Consult your system administrator. 	—

Issue	Possible Cause & Solution	Reference
I cannot make TEL calls.	<ul style="list-style-type: none"> The TEL line is not selected. → Before dialing, confirm that "TEL" is shown in the upper-right corner of the display. Press the center function button ([F2]) to change the line if necessary. 	page 30
	<ul style="list-style-type: none"> The unit is not set to make TEL calls. → Make sure the "Line Selection" setting is set to "IP + TEL". 	page 23
	<ul style="list-style-type: none"> The dial mode setting is incorrect. → Make sure that the dial mode matches the type of telephone service you have (i.e., tone or pulse). 	page 23
I cannot receive IP calls.	<ul style="list-style-type: none"> The "Operation Mode" setting is not correct. → Change the setting to "Peer to Peer" if you want to make or receive peer to peer IP calls (i.e., calls made by specifying the called party's IP address). → Change the setting to "IP-PBX" if you want to make or receive intercom and outside calls as a SIP extension of the connected PBX. 	page 25
I cannot receive TEL calls.	<ul style="list-style-type: none"> The unit is not set to receive TEL calls. → Make sure the "Line Selection" setting is set to "IP + TEL". 	page 23
I cannot use the unit for PS or PC calls.	<ul style="list-style-type: none"> The Portable Station (PS) or computer is not connected correctly. → Confirm you are using the correct cable to connect to the device, and that the cable is connected properly. 	page 41 page 42
	<ul style="list-style-type: none"> The PS or PC line is not selected. → Confirm that "PS" or "PC" is shown in the upper-right corner of the display. Press the center function button ([F2]) to change the line if necessary. → Make sure the "Line Selection" setting is set to "IP + PS" (for PS calls) or "IP + PC" (for PC calls). 	page 41 page 42
	<ul style="list-style-type: none"> The PS or computer is not able to make or receive calls. → Disconnect the audio cable from the device and confirm that the device is able to make or receive calls. If the device cannot make calls, you cannot use the unit for PS or PC calls. Refer to the operating instructions for the device. 	—

Issue	Possible Cause & Solution	Reference
I cannot redial by pressing [REDIAL/PAUSE] .	<ul style="list-style-type: none"> The number you are trying to redial is too long. <ul style="list-style-type: none"> → If the dialed number contains too many digits (more than 32 digits for IP calls with IP-PBX connection, more than 128 digits for TEL calls), it cannot be redialed correctly. 	—
	<ul style="list-style-type: none"> You pressed [REDIAL/PAUSE] after you began dialing. <ul style="list-style-type: none"> → If you press [REDIAL/PAUSE] after you begin dialing a phone number, the button functions as the pause button. To redial the last number dialed, press [↶] then [REDIAL/PAUSE]. To redial one of the last 10 phone numbers dialed, press [REDIAL/PAUSE], press [^] or [v] to select the desired phone number, then press [↶]. 	page 32
	<ul style="list-style-type: none"> You are trying to redial a TEL line call, but the unit is not set to make TEL calls. <ul style="list-style-type: none"> → Make sure the "Line Selection" setting is set to "IP + TEL". 	page 23
	<ul style="list-style-type: none"> The "Operation Mode" setting is not the same as when the original call was made. (For example, you are trying to redial an IP call made in IP-PBX mode, but the unit is now in peer to peer mode.) <ul style="list-style-type: none"> → Change the setting. 	page 25
I cannot make long distance calls.	<ul style="list-style-type: none"> Your telephone service does not allow you to make long distance calls. <ul style="list-style-type: none"> → Make sure that you have subscribed to your telephone company's long distance service. 	—
	<ul style="list-style-type: none"> If the unit is connected to a PBX, your extension may not be configured to make long distance phone calls. <ul style="list-style-type: none"> → Contact the PBX administrator. 	—
The unit does not ring when a call is received.	<ul style="list-style-type: none"> The ringer is turned off. <ul style="list-style-type: none"> → Press [^] while a call is being received, or change the ringer volume setting. 	page 34

Sound Quality

Issue	Possible Cause & Solution	Reference
The other party cannot hear my voice.	<ul style="list-style-type: none"> The unit is muted. <ul style="list-style-type: none"> → If "Mute" is displayed, press [📞/C] to turn off the mute feature. 	page 35
	<ul style="list-style-type: none"> Objects are obstructing the microphone. <ul style="list-style-type: none"> → Do not obstruct the unit or an External Wired MIC during calls. Keep your hands, as well as common objects such as folders, cups, and coffee pots away from the unit and the External Wired MIC during calls. 	—

Issue	Possible Cause & Solution	Reference
Sound cuts out; I can hear myself through the speaker.	<ul style="list-style-type: none"> The unit has not yet adapted to the environment for the current call. <ul style="list-style-type: none"> → Speak in turns with the other party at the beginning of a conversation. This allows the unit to adapt to its environment so that both parties can speak effectively. 	—
	<ul style="list-style-type: none"> If using a PS, you are pressing [↵] before the PS call has started. <ul style="list-style-type: none"> → Start the call using the PS, then press [↵]. 	page 41
	<ul style="list-style-type: none"> If using a PS, the PS Cable is not firmly connected to the PS. <ul style="list-style-type: none"> → Make sure the plug of the PS Cable is inserted fully into the PS, otherwise echoing and feedback may occur. 	page 41
	<ul style="list-style-type: none"> If using DSL service, a device connected between the unit and the telephone jack is causing interference. <ul style="list-style-type: none"> → Connect the unit directly to the telephone jack if possible, and/or consult your DSL service provider. 	—
	<ul style="list-style-type: none"> You are too far away from the microphone. <ul style="list-style-type: none"> → Try speaking closer to the microphone. 	page 28
	<ul style="list-style-type: none"> The environment is not suited to speakerphone calls. <ul style="list-style-type: none"> → Do not use the unit within 2 m (about 6.5 ft.) of projectors, air conditioning devices, fans, or other audible or electrical noise emitting devices. → If using the unit in a room with windows, close the curtains or blinds to prevent echoes. → Use the unit in a quiet environment. 	—
	<ul style="list-style-type: none"> The unit or an External Wired MIC was moved during a call. <ul style="list-style-type: none"> → Do not move the unit or an External Wired MIC while on a call. 	—
	<ul style="list-style-type: none"> Objects are obstructing the microphone. <ul style="list-style-type: none"> → Do not obstruct the unit or an External Wired MIC during calls. Keep your hands, as well as common objects such as folders, cups, and coffee pots away from the unit and the External Wired MIC during calls. 	—
<ul style="list-style-type: none"> The other party is using a half-duplex speakerphone. <ul style="list-style-type: none"> → If the other party is using a half-duplex speakerphone, sound may cut out occasionally during calls. For best performance, the other party should use a full-duplex speakerphone. 	—	

SD Memory Cards

Issue	Possible Cause & Solution	Reference
I cannot record to the SD memory card.	<ul style="list-style-type: none"> The SD memory card is not compatible with the unit. → Make sure that you are using a compatible SD memory card. (SDHC, miniSDHC, and microSDHC memory cards are not compatible with the unit.) 	page 26
	<ul style="list-style-type: none"> The SD memory card is not formatted or was not formatted properly. → Format SD memory cards for use with this unit in FAT format (FAT16) using a computer. 	page 27
	<ul style="list-style-type: none"> The SD memory card was not inserted properly. → Make sure that the SD memory card is inserted properly by gently pushing it securely but gently toward the back of the SD memory card slot. 	page 26

Phonebook

Issue	Possible Cause & Solution	Reference
I cannot add or edit entries to the phonebook.	<ul style="list-style-type: none"> You are on a call or playing back recordings. → You cannot add or edit phonebook entries while on a call or while playing back recordings. 	—
	<ul style="list-style-type: none"> The "Operation Mode" setting is not correct. → Change the setting to "Peer to Peer" if you want to add or edit peer to peer IP call entries (i.e., entries stored by specifying the called party's IP address). → Change the setting to "IP-PBX" if you want to add or edit IP call entries that will be called when using the unit as a SIP extension of the connected PBX. 	page 25
	<ul style="list-style-type: none"> A call is being received. → The unit exits the phonebook automatically when a call is received. Add or edit the phonebook entry again once you have finished the call. 	—
	<ul style="list-style-type: none"> There are 100 entries in the phonebook. → The phonebook is full. Erase any unnecessary entries. 	page 37

Issue	Possible Cause & Solution	Reference
I cannot call entries in the phonebook.	<ul style="list-style-type: none"> You are trying to make a TEL line call, but the unit is not set to make TEL calls. → Make sure the "Line Selection" setting is set to "IP + TEL". 	page 23
	<ul style="list-style-type: none"> You are trying to make an IP line call, but the "Operation Mode" setting is not correct. → Change the setting to "Peer to Peer" if you want to make or receive peer to peer IP calls (i.e., calls made by specifying the called party's IP address). → Change the setting to "IP-PBX" if you want to make or receive intercom and outside calls as a SIP extension of the connected PBX. 	page 25
The unit returns to standby mode while adding or editing phonebook entries.	<ul style="list-style-type: none"> 1 minute has passed since you pressed a button. → If you pause for over 1 minute while adding or editing phonebook entries, the unit returns to standby mode. 	—

Programming

Issue	Possible Cause & Solution	Reference
The unit returns to standby mode while programming the unit.	<ul style="list-style-type: none"> 1 minute has passed since you pressed a button. → If you pause for over 1 minute while programming the unit, the unit returns to standby mode. 	—
I cannot program the unit.	<ul style="list-style-type: none"> You are on a call. → Program the unit once you have finished the call. 	—
	<ul style="list-style-type: none"> A call is being received. → The unit exits programming mode automatically when a call is received. Program the unit again once you have finished the call. 	—
After I changed the settings, the changes do not take effect.	<ul style="list-style-type: none"> The unit must be restarted before the new setting becomes effective. → Restart the unit. 	page 43

Display Messages

Message	Possible Cause & Solution	Reference
Busy	<ul style="list-style-type: none"> The called party is busy (displayed for IP calls only). → Try again later. 	—
Reject Call	<ul style="list-style-type: none"> The called party rejected your call (displayed for IP calls only). → Try again later. 	—

Message	Possible Cause & Solution	Reference
Not Found	<ul style="list-style-type: none"> The called party cannot be connected (displayed for IP calls only). <ul style="list-style-type: none"> → Confirm that you have entered the IP address of the other party correctly. → Try again later. 	—
Phonebook No Items Stored	<ul style="list-style-type: none"> The phonebook contains no entries. <ul style="list-style-type: none"> → You must store entries in the phonebook before you can make a call from the phonebook. 	page 36
Phonebook Error	<ul style="list-style-type: none"> An error has occurred. <ul style="list-style-type: none"> → Press [BACK], then erase all phonebook entries using the "Erase All Phonebook Data" feature. 	page 56
Call Log Error	<ul style="list-style-type: none"> An error has occurred. <ul style="list-style-type: none"> → Press [BACK], then erase the redial list using the "Erase All Call Log Data" feature. 	page 56
Please Wait	<ul style="list-style-type: none"> An SD memory card was inserted. <ul style="list-style-type: none"> → Wait while the unit checks the card. 	—
Format Error	<ul style="list-style-type: none"> An error occurred while formatting the SD memory card. <ul style="list-style-type: none"> → Remove the SD memory card and use a different card. 	—
Unable To Use	<ul style="list-style-type: none"> The SD memory card is not compatible with the unit. <ul style="list-style-type: none"> → Make sure that you are using a compatible SD memory card. → SDHC, miniSDHC, and microSDHC memory cards are not compatible with the unit. 	page 26
	<ul style="list-style-type: none"> The SD memory card is not formatted in FAT format. <ul style="list-style-type: none"> → Use a FAT format SD memory card. 	page 27
	<ul style="list-style-type: none"> The selected recording is less than 1 second long. <ul style="list-style-type: none"> → Recordings less than 1 second long cannot be played back. 	—
Memory Full	<ul style="list-style-type: none"> The SD memory card cannot be used for recording because it is full. <ul style="list-style-type: none"> → Erase unneeded recordings. 	page 40
Write Protected	<ul style="list-style-type: none"> The switch on the side of the SD memory card is in the "LOCK" position. <ul style="list-style-type: none"> → Remove the card, slide the switch to unlock the card, then insert the card again. 	page 26
System Data Err Clear Data?	<ul style="list-style-type: none"> An error has occurred. <ul style="list-style-type: none"> → Press YES to reset all system data and restart the unit. → Press NO to restart the unit without resetting any data. 	—
No Connection To Analog Line	<ul style="list-style-type: none"> You tried to make a call immediately after refusing a call. <ul style="list-style-type: none"> → Wait until "TEL" is shown on the display, then make the call. 	—
No Connection To SIP Server	<ul style="list-style-type: none"> The unit's network settings and/or SIP settings are incorrect. <ul style="list-style-type: none"> → Consult your system administrator. 	—

Message	Possible Cause & Solution	Reference
No Connection To IP Network	<ul style="list-style-type: none">The LAN cable is not connected. → Check all connections.	page 22
	<ul style="list-style-type: none">The unit cannot receive IP settings from the DHCP server. → Consult your system administrator.	—

Cleaning the Unit

Clean the unit periodically with a soft, dry cloth.



Keep the following in mind when cleaning the unit.

- To avoid damaging the unit, disconnect the AC adaptor cord and all cables from the unit before cleaning.
- If the unit becomes particularly dirty, apply a light kitchen cleanser to a soft cloth, wring the cloth thoroughly, and wipe the unit. When finished, dry the unit with a soft, dry cloth.
- To avoid damage or discoloration, do not clean the unit with the following materials, or with cleaners containing the following materials.
 - Petroleum
 - Scouring powder
 - Alcohol
 - Paint thinner
 - Benzine
 - Wax
 - Hot water
 - Powdered soap
- When using chemical cleansers, follow the instructions on the label carefully.

Specifications

Item	Specification
Communication Lines	4 (IP, TEL, PS, PC) IP: Communication via IP network, available in peer to peer mode and IP-PBX mode TEL: Communication via telephone line PS: Communication via audio connection to a compatible Portable Station PC: Communication via audio connection to a computer
Maximum No. of Parties	3 – Main unit user + 2 IP calls (Peer to peer mode only) – Main unit user + 1 IP call + 1 TEL call – Main unit user + 1 IP call + 1 PS call – Main unit user + 1 IP call + 1 PC call
VoIP Connection Method	SIP
VoIP Audio Codec	G.722 (Peer to peer mode only), G.711 (μ -law/A-law), G.729a
LAN Interface	IEEE802.3/IEEE802.3u (10/100Base-TX) Straight/cross automatic crossover (Auto MDI/MDX)
IP Address Mode	Automatic (DHCP), manual (static)
Dial Mode	Tone, pulse
Speaker	1 (Output: 85 dB; Frequency range: 300 Hz–7000 Hz)
Built-in Microphone	4 locations, 8 total (Sensitivity area: about 3 m [about 10 ft.])
IP Network Interface Jack (LAN)	1 (RJ45)
Telephone Interface Jack (LINE)	1 (RJ11)
USB Port	1 (USB 2.0, Full speed)
SD Memory Card Slot	1 (32 MB–2 GB)
Audio Interface Jack (AUDIO IN/OUT)	1 (\varnothing 3.5 mm, monaural)
External Wired MIC Jack (EXT MIC1, EXT MIC2)	2 (Modular jack)
Main Unit Dimensions	About 55 mm (H) \times 275 mm (W) \times 275 mm (D) About 2 3/16 in. (H) \times 10 1/16 in. (W) \times 10 1/16 in. (D)
Main Unit Mass	About 1300 g (2.87 lb.)
AC Adaptor	Input: AC 120 V, 60 Hz Output: DC 9 V 750 mA
PoE Interface	Compliant with IEEE802.3af
Power Consumption	Standby mode: about 4.8 W Talk mode: about 6.5 W
Operating Environment	Temperature: 0 °C–40 °C (32 °F–104 °F) Humidity: Less than 90% (with no condensation) Ambient noise: Less than 50 dBA (recommended)

Index

A

AC Adaptor 16, 22
 Accessories 16
 Answering Calls 34
 AUDIO IN/OUT Jack 17

B

BACK Button 18
 Built-in Microphones 17, 28
 Buttons 18

C

Call Waiting 18, 34, 48
 Call Waiting Tone Volume 48
 Characters 38
 Cleaning 67
 Computer 42
 Conference Calls 33, 34
 Conferencing Phone Manager
 Connecting a Computer 57
 Install 29
 Operating the Unit 57
 Programming the Unit 58
 Restart 58
 Starting 57
 Uninstall 29
 Connections 22

D

Date & Time 23, 47
 Default Gateway 50
 Dial Mode 48
 Dialing Pause 32
 Display 18, 19
 Display Messages 64

E

ENTER Button 18
 Erase All Call Log Data 54
 Erase All Phonebook Data 54
 Erasing Data 56
 Error Messages 64
 External Wired MIC 16, 28
 External Wired MIC Jacks (EXT MIC1, EXT MIC2) 17

F

Feature List 44
 FLASH Button 18, 35
 Flash Time 49
 Format 27
 Function Buttons ([F1], [F2], [F3]) 19

H

Hold Method 51

I

Indicators 17
 Initialize 56
 IP Address 50
 IP Address Mode 49
 IP Network Settings 24
 IP-PBX Mode 25

K

Key Tones 48

L

LAN Cable 22
 LAN Port 17
 Language 46
 LCD Contrast 47
 Line Icon (IP, TEL, PS, PC) 19
 Line Selection 30, 48

M

Making Calls 31
 MENU Button 18
 MIC NOISE CUT Button 18
 Microphones 28
 Mute 35
 Mute/Clear Button 18

N

Navigator/Volume Buttons 18
 Noise Reduction 35

O

Operation Mode 25, 46

P

Parameter List 44
 Pause Time 49
 PC Cable 16
 Peer to Peer Mode 25
 Phonebook 32, 36
 Playback 39
 Playback Control Buttons 18
 Portable Station (PS) 41
 Preferred CODEC 52
 Programming 43, 58
 PS Cable 16

R

Reboot 55
 Recording 39
 Recording Time 26
 Redial 32
 REDIAL/PAUSE Button 18
 Reset 56
 Reset All Data 55
 Reset System Data 54
 Restart 43, 58

Index

Ringer Volume 34, 47
Ringtone 47
RTP Packet Size 52
RTP Port Number (Maximum) 52
RTP Port Number (Minimum) 52
RTP ToS Field 53

S

SD Icon 19
SD Memory Card 26
SD Memory Card Slot 17
Security 10
Settings 43
Show IP Address 46
SIP Ext. No. 50
SIP Password 51
SIP Proxy Server IP Address 51
SIP Registrar IP Address 51
SIP Settings 25
SIP Signaling Port Number 52
SIP ToS Field 53
SIP User Domain Name 51
Speaker 17
Speaker Volume 31, 34
Speakerphone Button 18
Specifications 68
Speech Speed 35
Subnet Mask 50
System Status Confirmation 54

T

TEL Cord 22
TEL Line Level Reduction 49
Telephone Line Jack (LINE) 17
Time Format 47
Troubleshooting 59

U

USB Cable 16
USB Icon 19
USB Port 17

V

VLAN ID 53
VLAN Priority 53
Voice Memo 39

When you ship the product

Carefully pack and send it prepaid, adequately insured and preferably in the original carton. Attach a postage-paid letter, detailing the symptom to the outside of the carton. DO NOT send the product to the Executive or Regional Sales offices. They are NOT equipped to make repairs.

Product service

For product service, ship the product to the address listed in the Limited Warranty. Consult your authorized Panasonic dealer for detailed instructions.

Panasonic Consumer Electronics Company
Division of Panasonic Corporation of North America
One Panasonic Way Secaucus, New Jersey 07094

Copyright:

This material is copyrighted by Panasonic Communications Co., Ltd., and may be reproduced for internal use only. All other reproduction, in whole or in part, is prohibited without the written consent of Panasonic Communications Co., Ltd.

© Panasonic Communications Co., Ltd. 2008

PSQX4655ZA KK1008HF0

Free Manuals Download Website

<http://myh66.com>

<http://usermanuals.us>

<http://www.somanuals.com>

<http://www.4manuals.cc>

<http://www.manual-lib.com>

<http://www.404manual.com>

<http://www.luxmanual.com>

<http://aubethermostatmanual.com>

Golf course search by state

<http://golfingnear.com>

Email search by domain

<http://emailbydomain.com>

Auto manuals search

<http://auto.somanuals.com>

TV manuals search

<http://tv.somanuals.com>