

# Panasonic

Cordless Answering System

Model No. KX-T4316NZ-W

## Operating Instructions

Getting Started

Cordless Telephone

Answering System

Useful Information



**DSP** DYNAMIC SOUND FOCUS PLUS

PLEASE READ BEFORE USE AND SAVE.

**Charge the battery for about 3 hours before initial use.**

Download from [www.Somanuals.com](http://www.Somanuals.com). All Manuals Search And Download.

# Before Initial Use

---

***Thank you for purchasing the Panasonic cordless answering system.***

## For Your Future Reference

Serial No. \_\_\_\_\_ Date of purchase \_\_\_\_\_  
(found on the bottom of the unit)

Name and address of dealer \_\_\_\_\_

## Check the Accessories

AC Adaptor (p. 10)

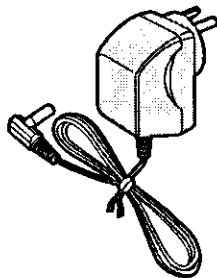

one

Telephone Line Cord (p. 10)

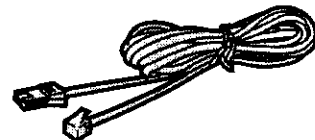

one

Wall Mounting Adaptor (p. 45)

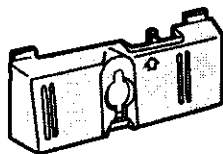

one

Incoming Message Tape (MC-30) (p. 9)

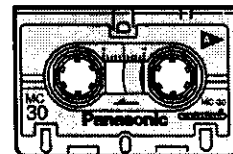

one

# For Best Performance

## Battery Charge

To power the handset, charge the battery for about **3 hours** before initial use (p. 11).

The battery is beneath this cover.

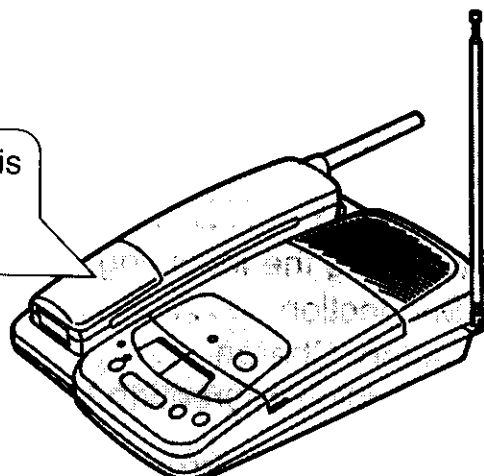

## Operating Distance/Noise

Calls are transmitted between the base unit and the handset using wireless radio waves. **For maximum distance and noise free operation**, the recommended base unit placement is:

Away from electrical appliances such as a TV, radio, or personal computer.

In a **HIGH** and **CENTRAL** location with no obstructions such as walls.

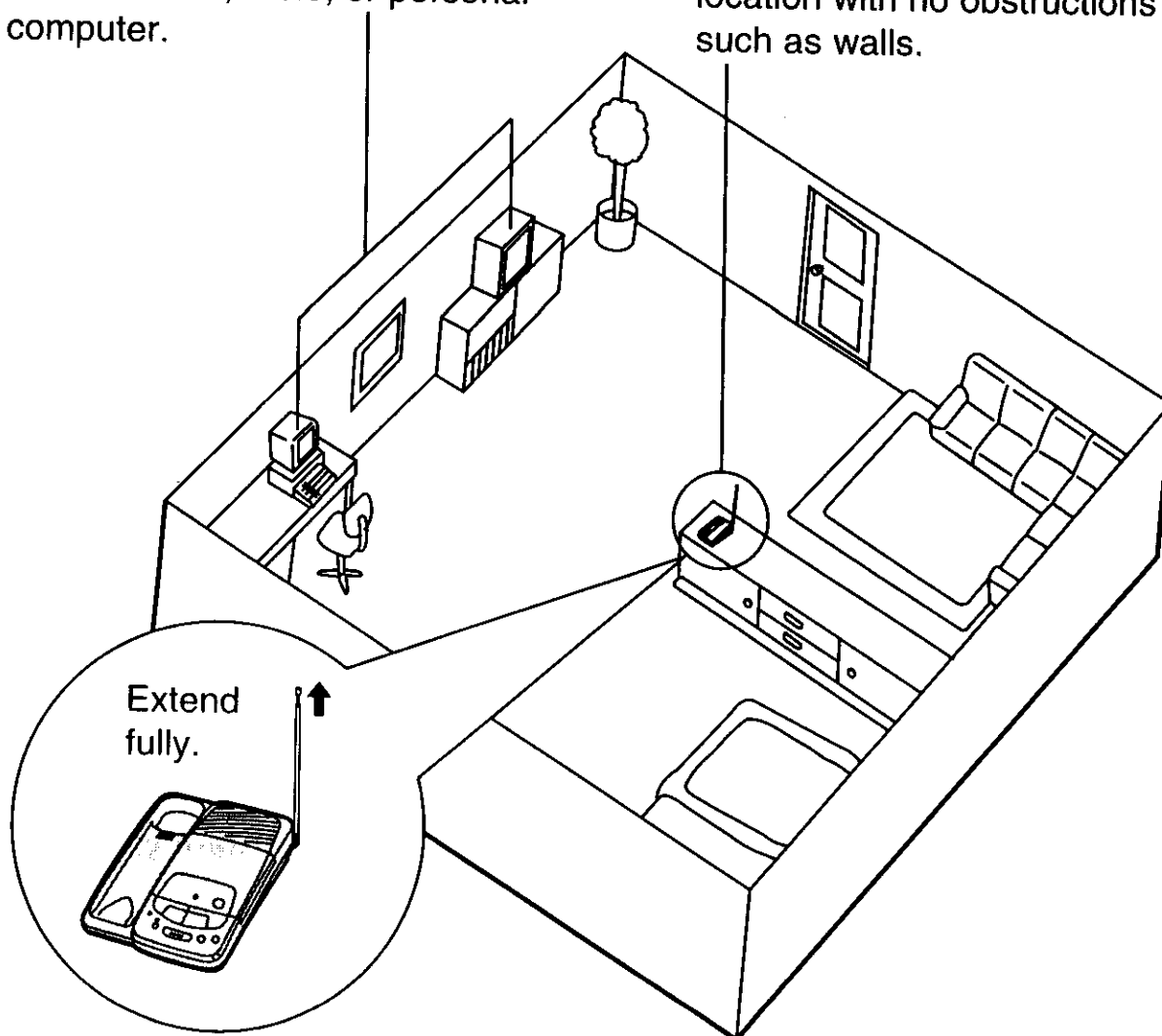

# Contents

---

## ***Getting Started***

<b>Location of Controls</b> .....	6
<b>Setting Up</b> .....	9
Inserting the Incoming Message Tape .....	9
Connection .....	10
Battery Charge .....	11
Recording a Greeting Message .....	12
<b>Programmable Preparations</b> .....	14
Selecting the Number of Rings .....	15
Selecting the Caller's Recording Time .....	16
Setting the CPC (Calling Party Control) Function .....	17
Setting the Greeting Monitor Function .....	18
Setting the VOX SENS Function .....	19

## ***Cordless Telephone***

<b>Making Calls</b> .....	20
<b>Answering Calls</b> .....	21
<b>Automatic Dialing</b> .....	22
Storing Phone Numbers in Memory .....	22
Dialing a Stored Number .....	23
<b>Intercom</b> .....	24
<b>Special Features</b> .....	25
Automatic Security Code Setting .....	25
For Call Waiting Service Users .....	25
If Your Unit is Connected to a PBX .....	25
RECALL Button .....	26

## ***Answering System***

<b>Automatic Answering Operation</b> .....	27
Setting the Unit to Answer Calls .....	27
<b>Listening to the Recorded Messages</b> .....	28
Listening to New Messages .....	29
Listening to All of the (saved) Messages .....	29
Resetting the Tape .....	30
Erasing All of the Incoming Messages .....	30
Saving Specific Messages .....	30
<b>Recording a Memo Message</b> .....	31
<b>Pager Call</b> .....	32
Storing the Pager Number .....	32
Setting the Unit to Call the Pager .....	33
<b>Remote Operation from a Touch Tone Phone</b> .....	34
Setting the Remote Code Number .....	34
Remote Operation Sequence .....	36
<b>Operation from the Handset</b> .....	40
Operation Sequence .....	40

## ***Useful Information***

<b>Wall Mounting</b> .....	45
<b>Battery Replacement</b> .....	46
<b>Maintenance of Cassette Tape and Deck</b> .....	47
<b>Adding Another Phone</b> .....	49
<b>Before Requesting Help</b> .....	50
Cordless Telephone .....	50
Answering System .....	51
General .....	52
<b>Safety Instructions</b> .....	54

# Location of Controls

---

## Base unit

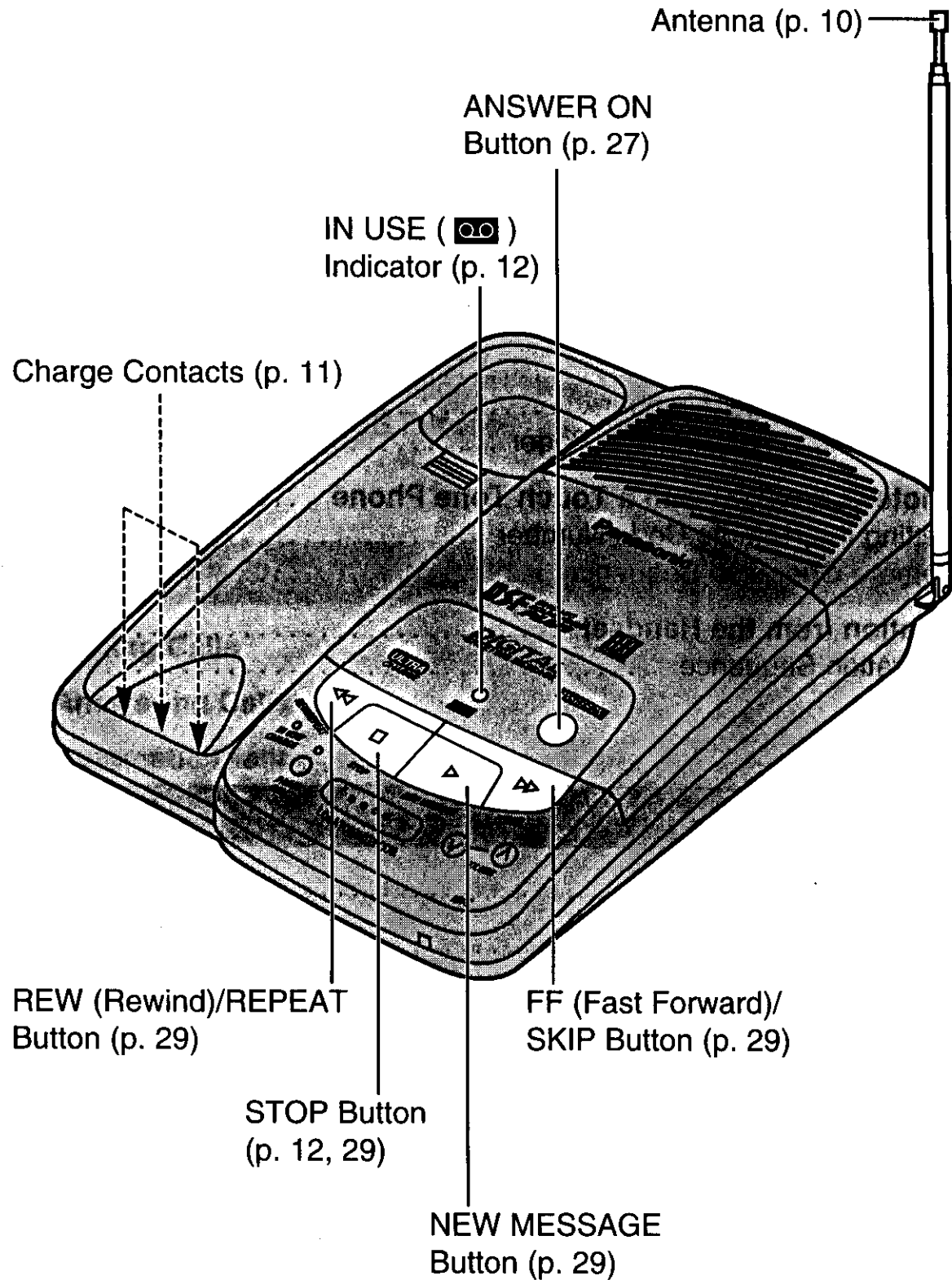

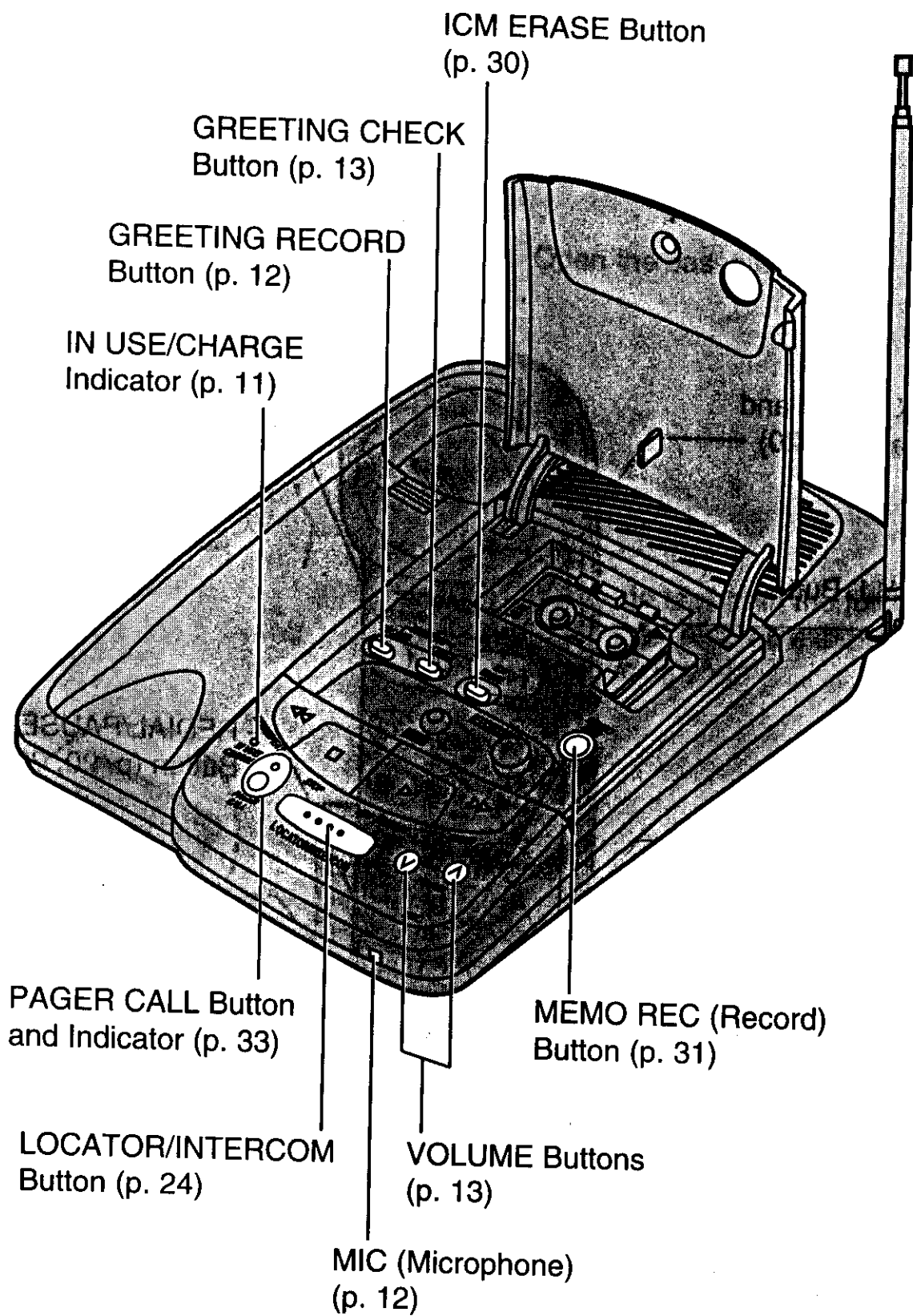

## ► Location of Controls

### Handset

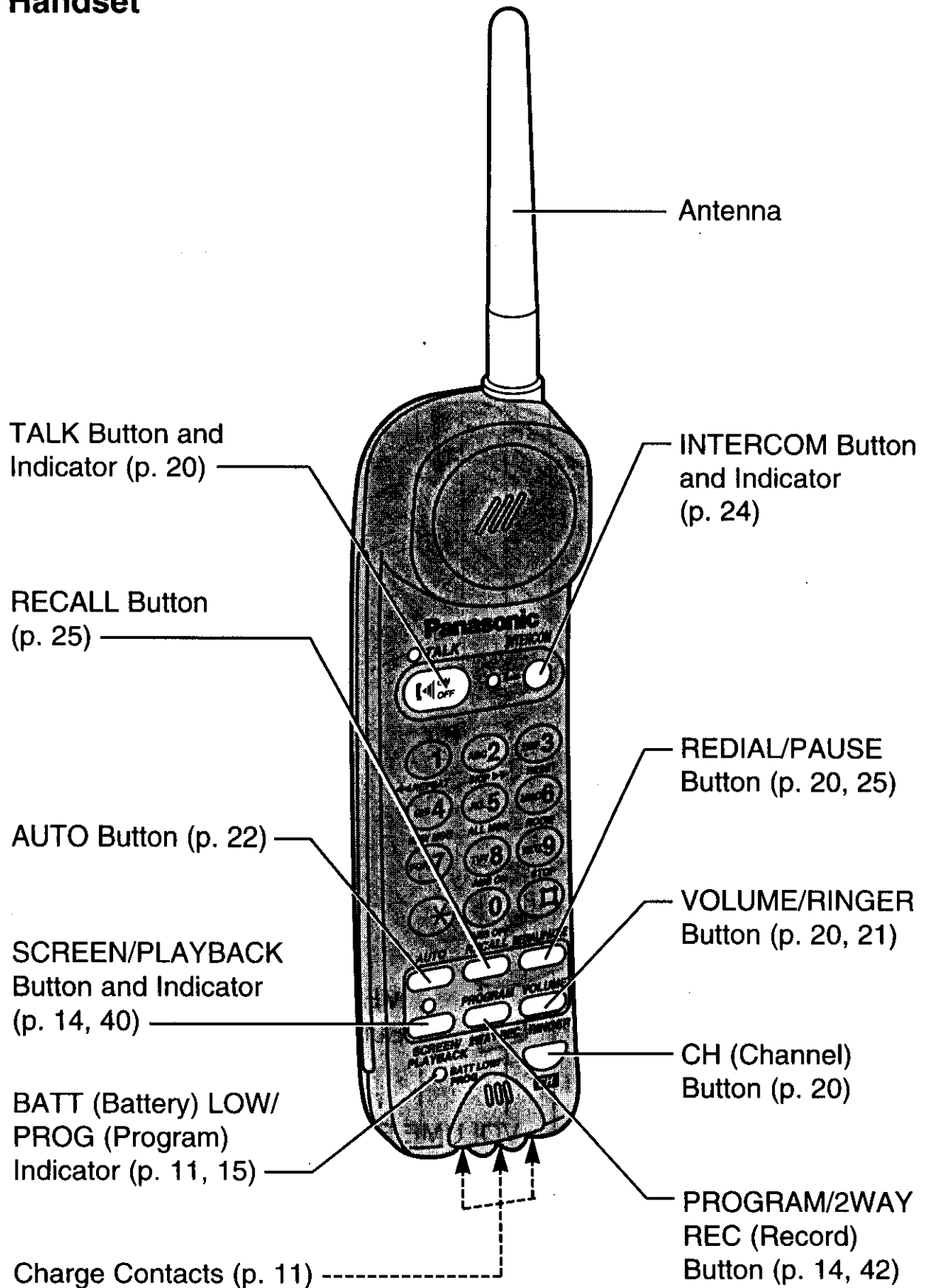



# Setting Up



## Inserting the Incoming Message Tape

- 1 Remove the stopper.

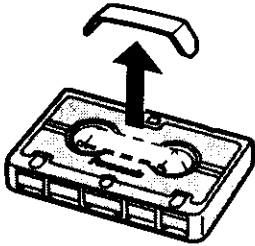

- 2 Open the cassette cover.

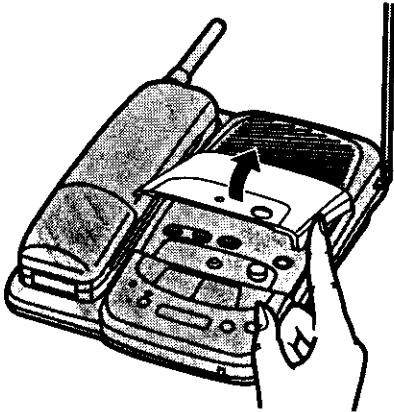

- 3 Insert the tape with the full reel to the right and the exposed tape facing you.

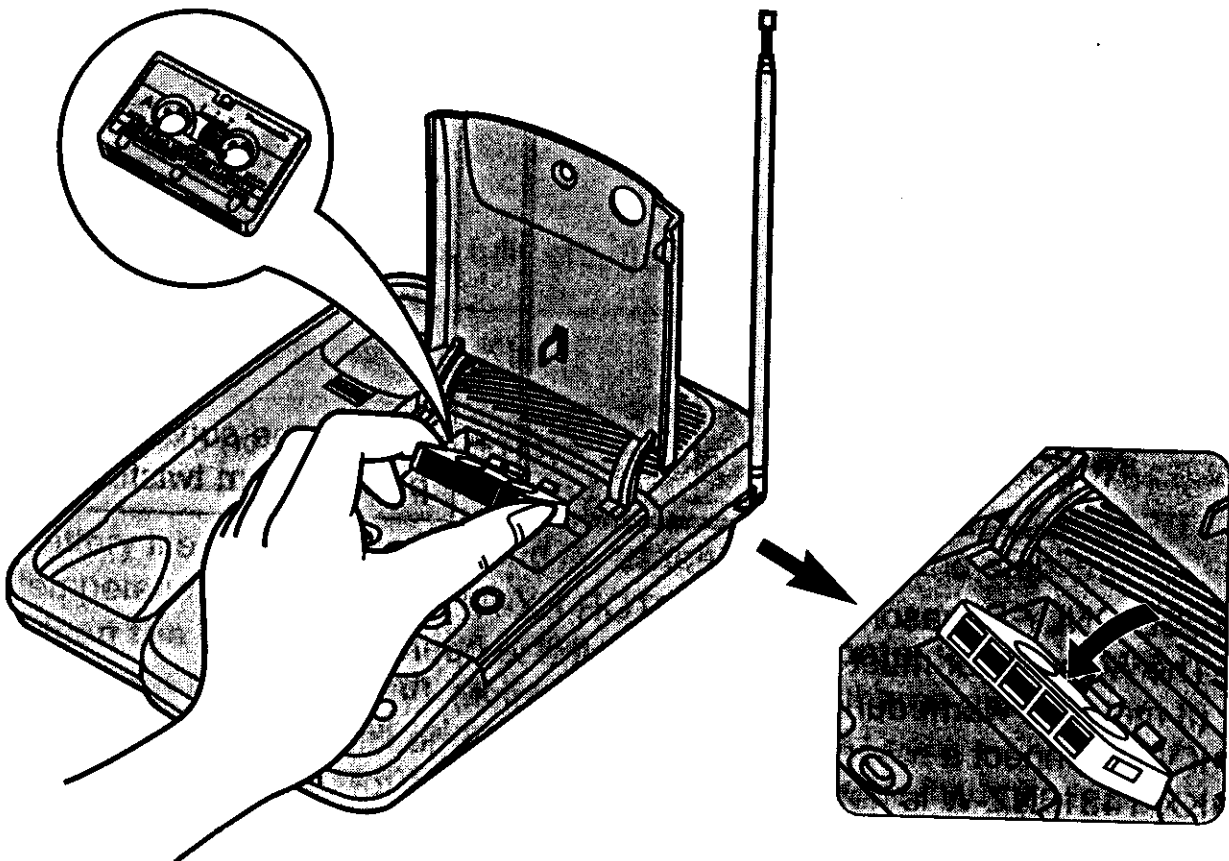

## ► Setting Up

### Connection

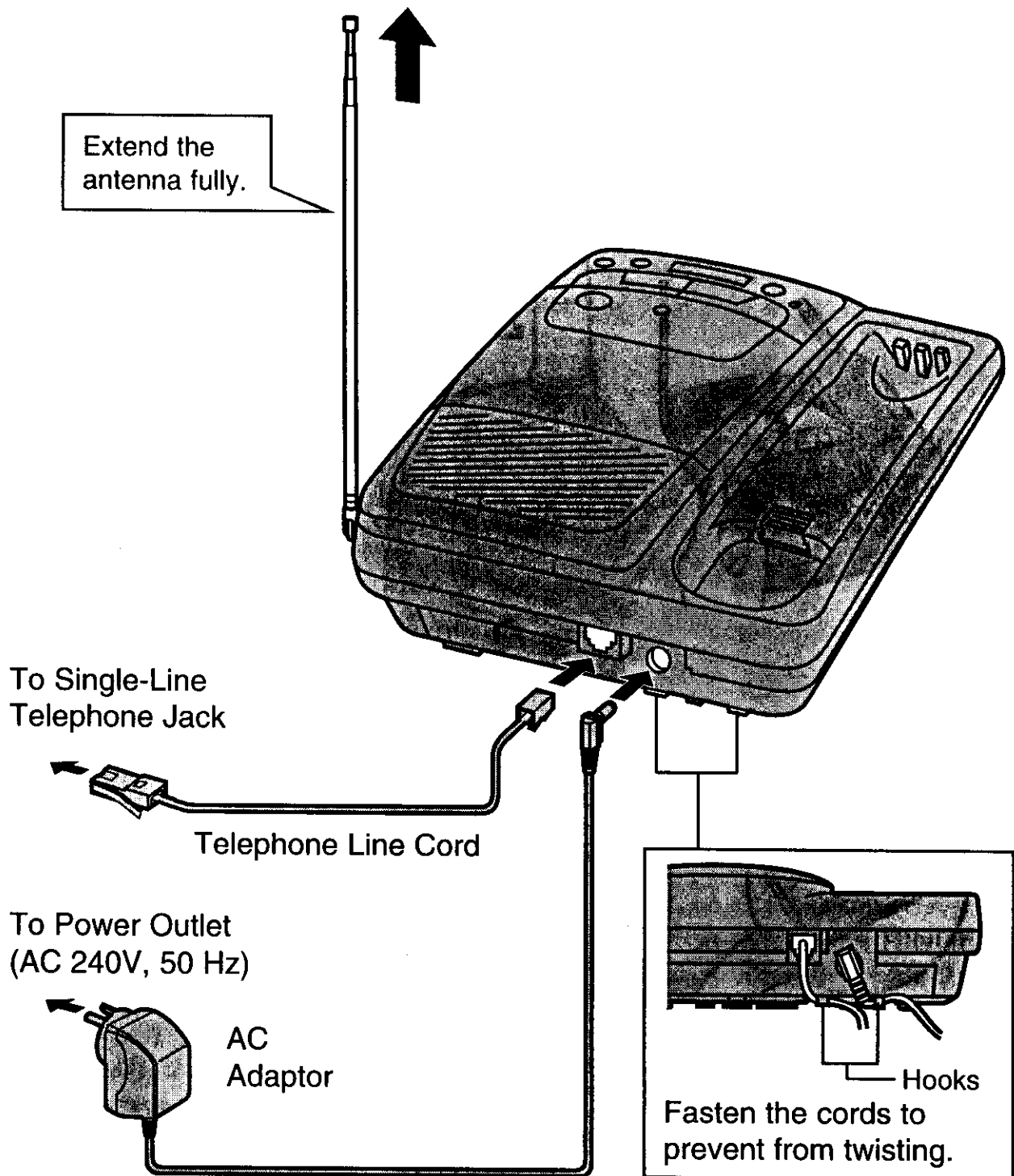

- USE ONLY Panasonic AC ADAPTOR KX-A11BA.
- The AC adaptor must remain connected to operate the unit.  
(It may feel warm during use. This is normal.)
- If you connect a reserve telephone on the same line, see page 49.
- KX-T4316NZ-W is not designed to be used with rotary (pulse dialing) services.
- KX-T4316NZ-W will not answer incoming calls on your FaxAbility number.

## Battery Charge

Place the handset on the base unit for about **3 hours**.

- The IN USE/CHARGE indicator lights.

IN USE/CHARGE Indicator

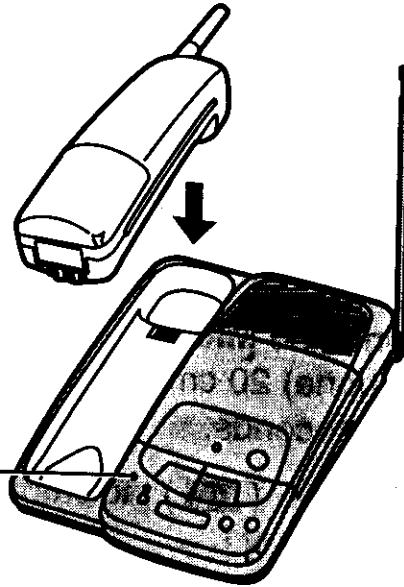

## Recharge

When the BATT LOW/PROG indicator flashes or the unit beeps intermittently, recharge the battery by placing the handset on the base unit.

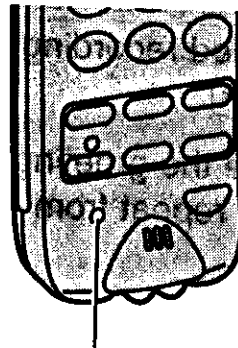

BATT LOW/PROG Indicator

## Standard battery life

If your Panasonic battery is fully charged;

While in use (TALK)	Up to about 8 hours
While not in use (Stand-By)	Up to about 30 days

- Battery life may vary depending on usage conditions and ambient temperature.
- **Clean the handset and the base unit charge contacts with a soft dry cloth once a month**, or the battery may not charge properly.
- Once the battery is fully charged, you do not have to place the handset on the base unit until the BATT LOW/PROG indicator flashes.
- The battery cannot be overcharged.

## ▶ Setting Up

# Recording a Greeting Message

- 1 Press **GREETING RECORD**, then release it.
  - A long beep sounds.
- 2 Immediately after the long beep speak into the **MIC** (microphone) 20 cm (8") away, up to 16 seconds.
  - The **IN USE** (  ) indicator flashes slowly. After 13 seconds, it flashes quickly.
- 3 When finished recording, press **STOP**.
  - To change the greeting message, repeat from step 1.

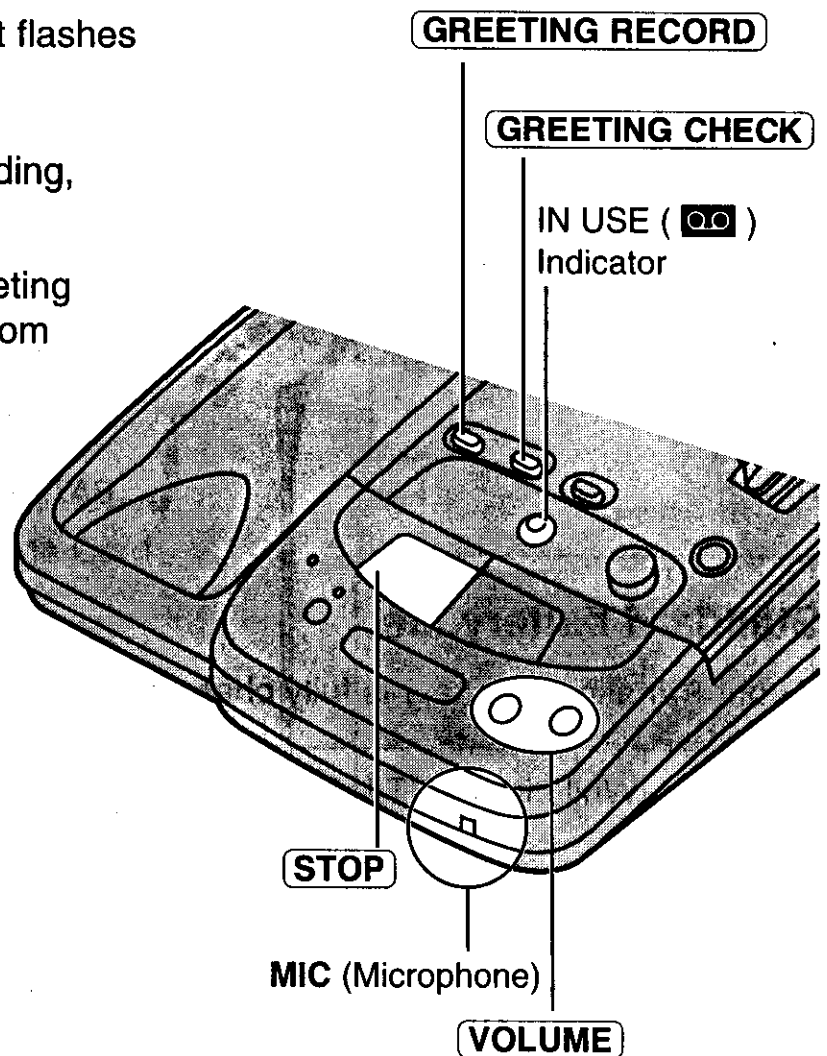

- The greeting message will not be lost even if a power failure occurs.

## To check the greeting message

Press **GREETING CHECK**.

- The recorded greeting is played.
- Adjust the speaker volume using **VOLUME**.  
To increase, press  $\wedge$ .  
To decrease, press  $\vee$ .

### Sample of a greeting message

"Hello, this is (your name and/or number). Sorry, I cannot answer your call. Please leave your name, number and a short message after the long beep. Thank you."

# Programmable Preparations

## Summary of programming procedures

See the pages indicated with brackets for detailed procedures.

**Make sure that the TALK indicator light is off before programming.**

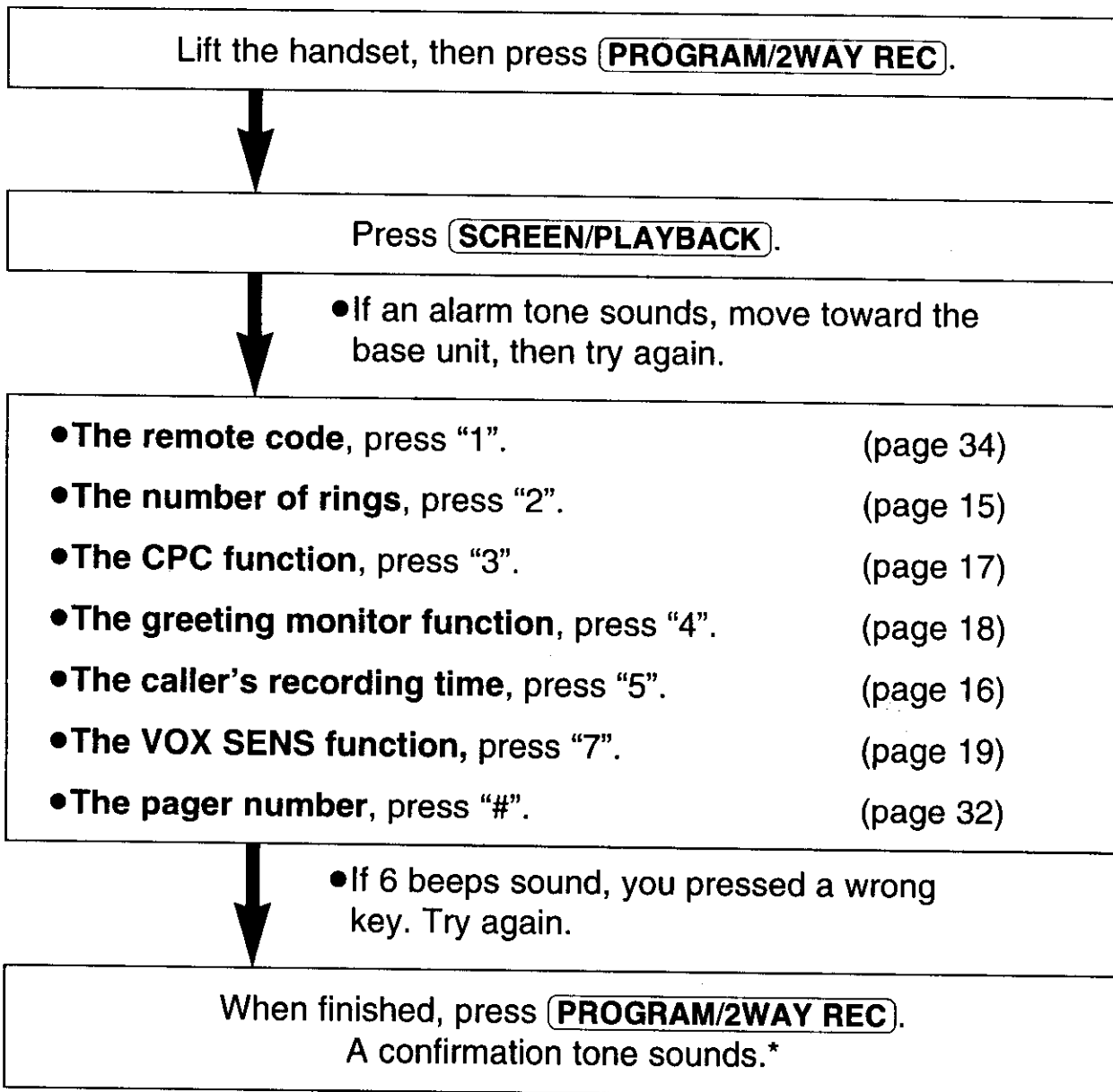

- To cancel the programming halfway, press **PROGRAM/2WAY REC**, then start from the beginning.

### \*Confirmation tone meaning

1 beep: The new number is stored.

2 beeps: The number is the same as a previously stored one.

To confirm the current setting, repeat the same steps above and listen for the confirmation tone(s).

# Selecting the Number of Rings

You can select the number of rings "2" to "8" or "AUTO (preset)" before your answering system answers a call (see below).

**1** Press **PROGRAM/2WAY REC**.

- The BATT LOW/PROG indicator lights.

**2** Press **SCREEN/PLAYBACK**.

- The SCREEN/PLAYBACK indicator lights.

**3** Press "2".

**4** Press a number "0" or "2" to "8" to set the number of rings.

**0:** "AUTO" is selected.  
(Toll Saver)

**2-8:** The unit will answer on the selected number of rings.

**5** When finished, press **PROGRAM/2WAY REC**.

- The indicator lights go out.

**SCREEN/PLAYBACK**  
and Indicator

BATT LOW/PROG  
Indicator

**PROGRAM/2WAY REC**

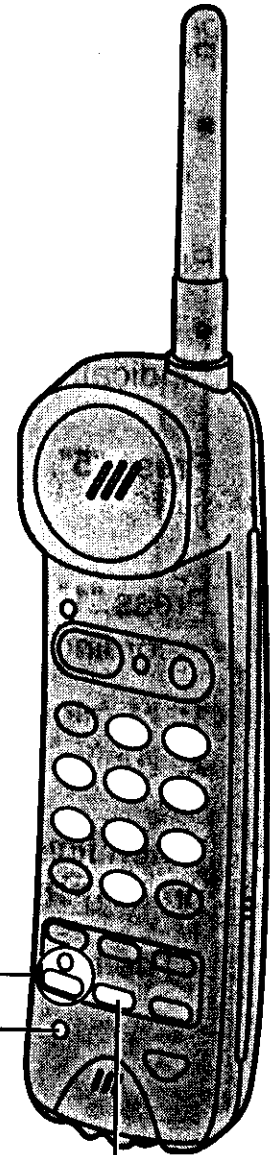

## Toll Saver (When set to "AUTO"):

When you call the unit from a touch tone telephone,

- If the unit answers on the 2nd ring: There is at least one new message.
- If the unit answers on the 4th ring: There are no new messages.

If you hang up immediately after the 3rd ring, then you can save the toll charge.

## ► Programmable Preparations

### Selecting the Caller's Recording Time

You may select the recording time of incoming calls to "unlimited (up to the tape end)" or "1 minute". The factory preset is "unlimited".

- 1 Press **PROGRAM/2WAY REC**.
  - The BATT LOW/PROG indicator lights.
- 2 Press **SCREEN/PLAYBACK**.
  - The SCREEN/PLAYBACK indicator lights.
- 3 Press "5".
- 4 Press "1" or "2" to select the recording time.
  - 1: "1 minute" is selected.
  - 2: "unlimited" is selected.
- 5 When finished, press **PROGRAM/2WAY REC**.
  - The indicator lights go out.

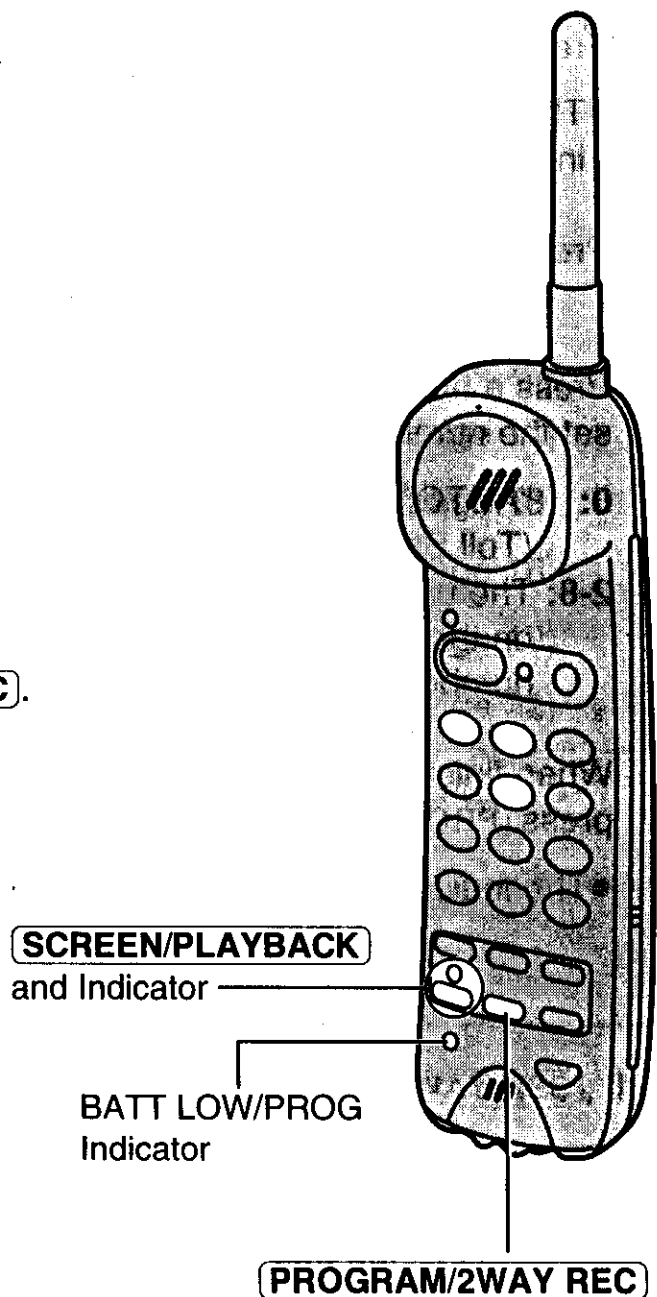



## Setting the CPC (Calling Party Control) Function

The CPC function is preset to "A". If you use a call waiting service, set to "B". If set to "A", the call waiting tone will disconnect someone leaving a message.

- 1 Press **PROGRAM/2WAY REC**.
  - The BATT LOW/PROG indicator lights.
- 2 Press **SCREEN/PLAYBACK**.
  - The SCREEN/PLAYBACK indicator lights.
- 3 Press "3".
- 4 To select "B", press "2".  
OR  
To select "A", press "1".
- 5 When finished, press **PROGRAM/2WAY REC**.
  - The indicator lights go out.



## ► Programmable Preparations

### Setting the Greeting Monitor Function

When the greeting message is played back to the caller, you may also hear it through the speaker. If you want to hear the message, set to "2 (ON)". The factory preset is "1 (OFF)".

- 1 Press **PROGRAM/2WAY REC**.
  - The BATT LOW/PROG indicator lights.
- 2 Press **SCREEN/PLAYBACK**.
  - The SCREEN/PLAYBACK indicator lights.
- 3 Press "4".
- 4 To set to "ON", press "2".  
OR  
To set to "OFF", press "1".
- 5 When finished, press **PROGRAM/2WAY REC**.
  - The indicator lights go out.

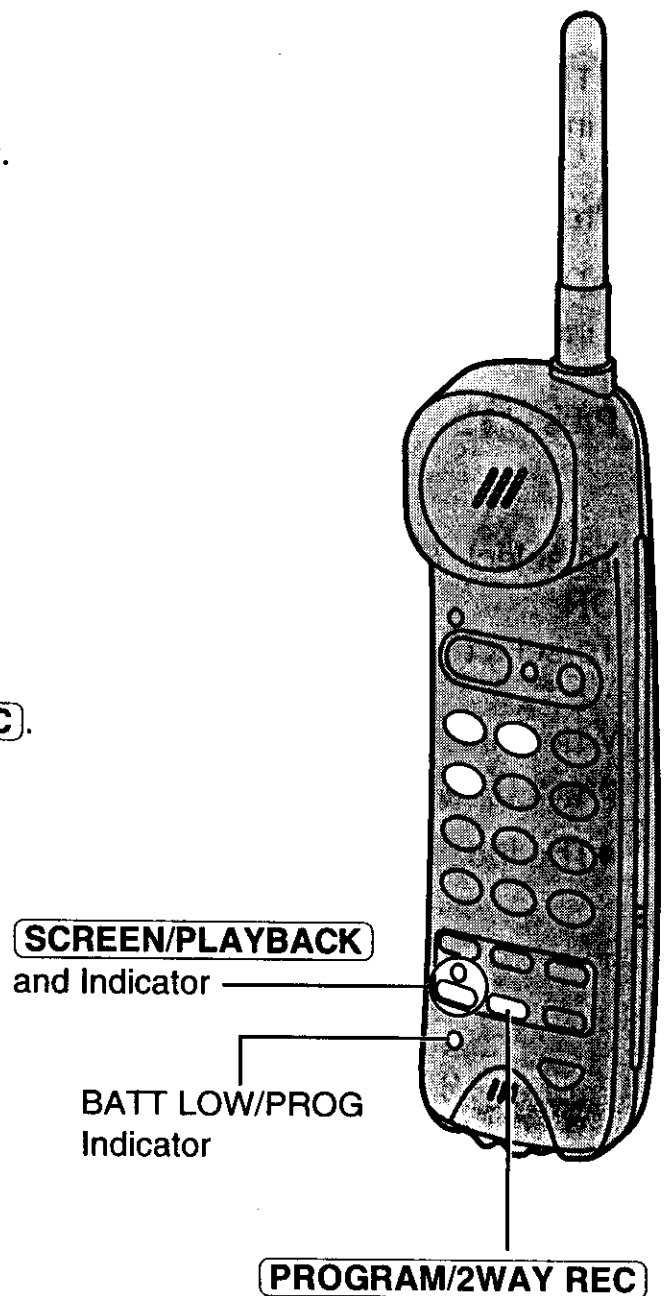

# Setting the VOX SENS Function

The VOX SENS function is preset to "HIGH". If the unit continues to operate after a caller hangs up or there are long pauses between or after messages, set to "LOW".

- 1 Press **PROGRAM/2WAY REC**.
  - The BATT LOW/PROG indicator lights.
- 2 Press **SCREEN/PLAYBACK**.
  - The SCREEN/PLAYBACK indicator lights.
- 3 Press "7".
- 4 To set to "LOW", press "1".  
OR  
To set to "HIGH", press "2".
- 5 When finished, press **PROGRAM/2WAY REC**.
  - The indicator lights go out.



# Making Calls

- 1 Press **TALK**.
  - The indicator lights.
- 2 Dial a telephone number.
- 3 To hang up, press **TALK** or place the handset on the base unit.
  - The indicator light goes out.

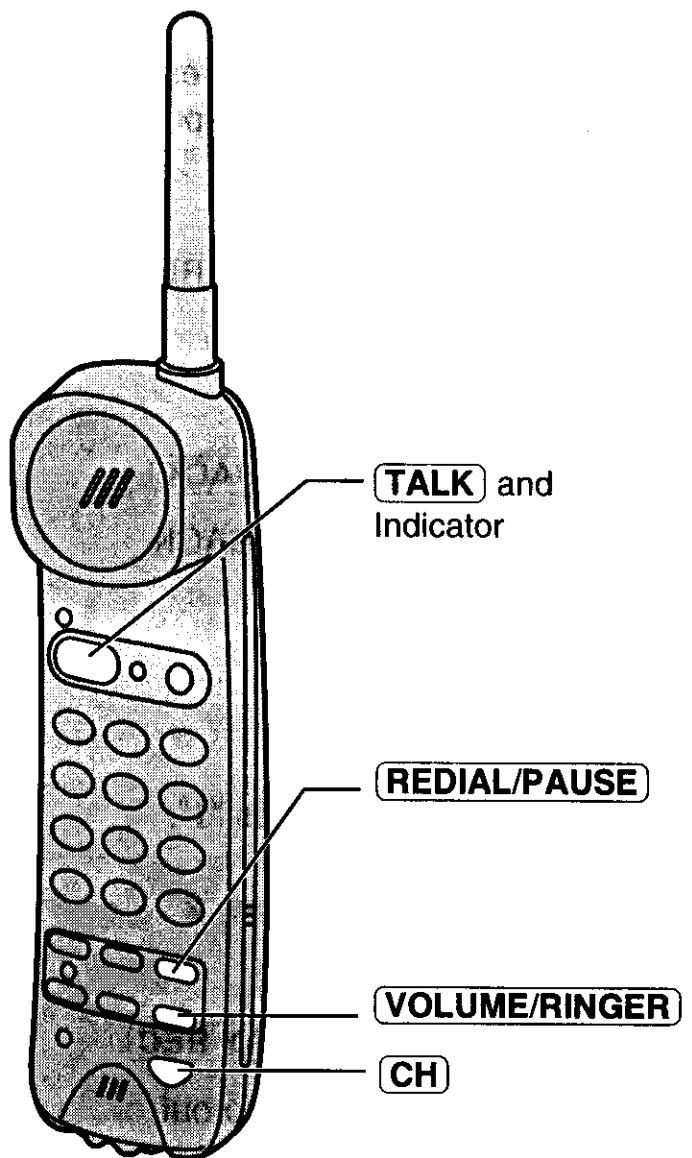

- If an alarm tone sounds in step 1, move toward the base unit or place the handset on the base unit and try again.

## To redial the last number

Press **TALK** ➔ **REDIAL/PAUSE**.

## To select the receiver volume HIGH or NORMAL (preset)

Press **VOLUME/RINGER** while talking.

- Each time you press, the volume level will change.

## If noise interferes with the conversation

Press **CH** to select a clear one of 10 channels or move closer to the base unit

# Answering Calls

---

If the handset is off the base unit, press **TALK**.

- You can also answer a call by pressing any dialing button 0 to 9, \*, or # (—Any Key Talk).

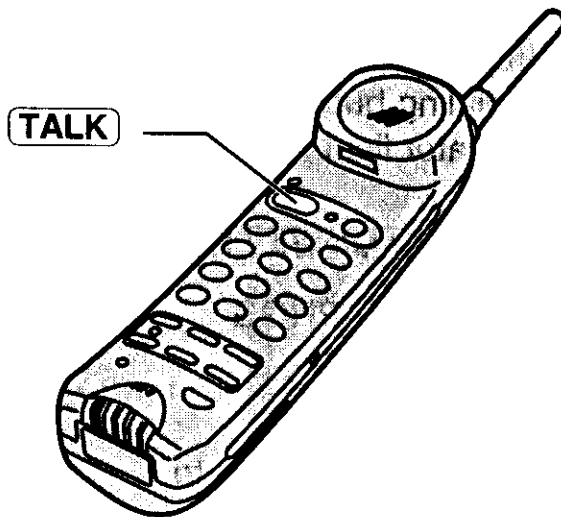

**OR**

If on the base unit, just lift up.

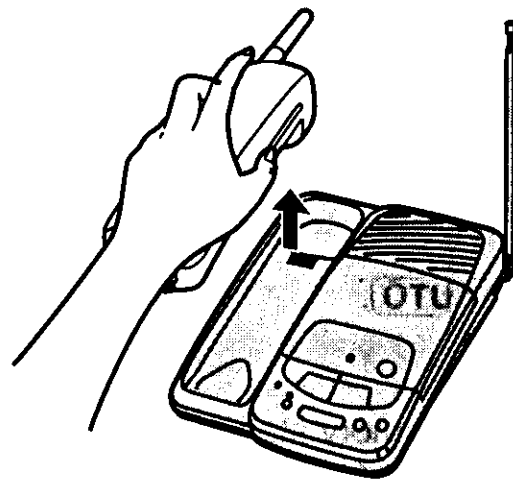

## Adjust the ringer volume

Be sure the TALK and INTERCOM indicator lights are off.

- To select **HIGH (preset) or LOW**, press **VOLUME/RINGER**. (Each time you press, the ringer volume will change.)
- To turn the ringer **OFF**, while pressing **VOLUME/RINGER**, press **0** until 2 beeps sound.
- To turn the ringer **ON**, press **VOLUME/RINGER**. The ringer sounds at the HIGH level.

## Lighted Keypad

The dialing buttons will light while dialing and flash when a call is received. The lights will go out about 10 seconds after dialing or answering a call.

# Automatic Dialing

## Storing Phone Numbers in Memory

You can store up to 10 phone numbers in the handset.  
The handset dialing buttons (0 to 9) function as memory stations.  
The TALK indicator light must be off.

**1** Press **PROGRAM/2WAY REC**.

- The BATT LOW/PROG indicator lights.

**2** Enter a phone number up to 16 digits.

- If you misdial, press **PROGRAM/2WAY REC** to end storing, then restart from step 1.

**3** Press **AUTO**.

**4** Press a memory station number (0 to 9).

- A confirmation tone sounds.  
(See below.)
- To store other numbers, repeat steps 1 through 4.

**PROGRAM/2WAY REC**

**AUTO**

BATT LOW/  
PROG Indicator

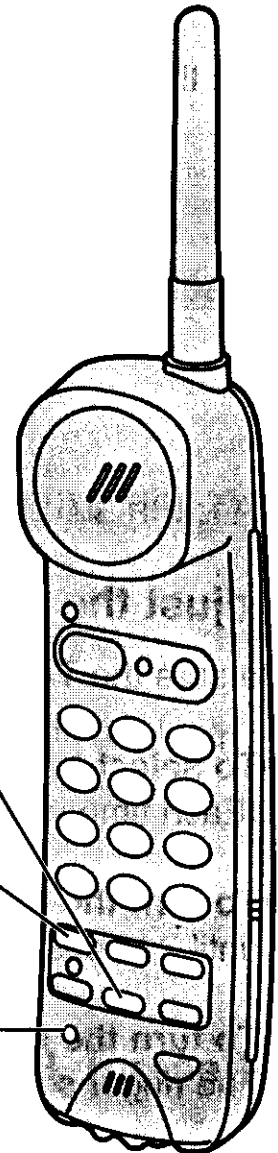

### Confirmation tone meaning

1 beep: The new number is stored.

2 beeps: The number is the same as a previously stored one.

## To erase a stored number

Press **PROGRAM/2WAY REC** ► **AUTO** ► the memory station number (for the phone number to be erased).

## Memory sticker

Use the included memory sticker as a name or phone number index for automatic dialing. Attach the sticker to the unit or in a convenient place.

10-STATION AUTOMATIC DIALER	
1	6
2	7
3	8
4	9
5	0
TEL NO.	

## Dialing a Stored Number

- 1 Press **TALK**.
- 2 Press **AUTO**.
- 3 Press the memory station number (0 to 9).
  - The stored number is dialed.

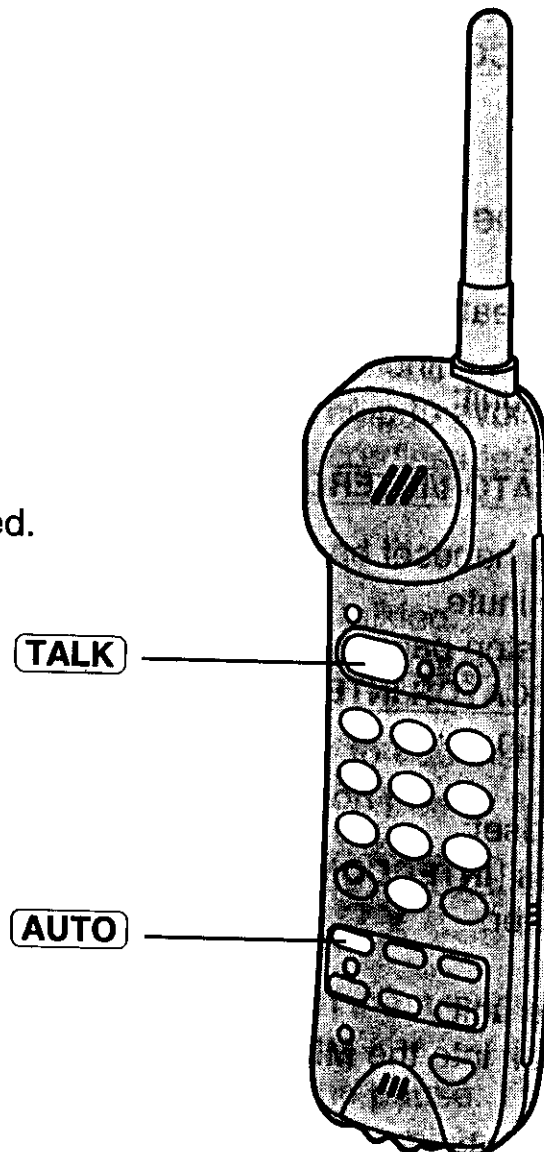

# Intercom

---

A 2-way intercom is available between the handset and the base unit.

## Paging the base unit from the handset

- 1** Handset:  
Press **INTERCOM**,  
then speak.
- 2** Base unit:  
When the other party's voice  
is heard, answer through the  
**MIC**.
- 3** Handset:  
To end the intercom, press  
**INTERCOM**.

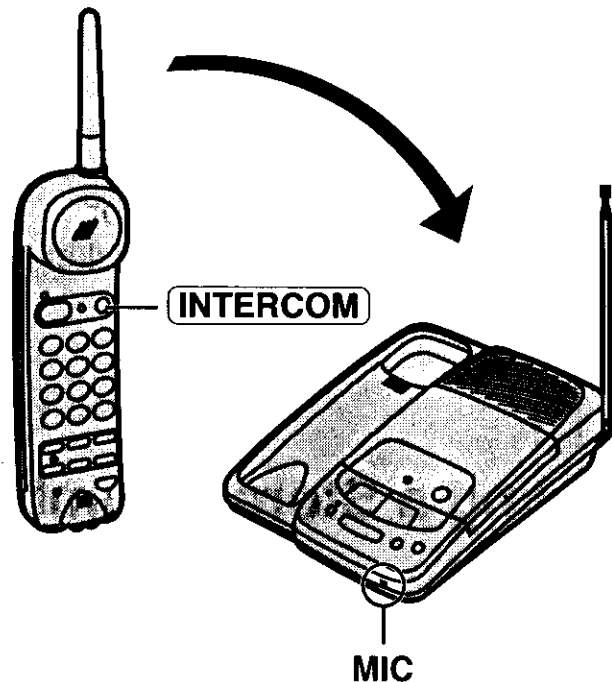

## Paging the handset from the base unit (Handset locator)

Using this feature, you can locate the handset if misplaced.

- 1** Base unit:  
Press  
**LOCATOR/INTERCOM**.
  - The handset beeps for  
1 minute.
  - To stop paging, press  
**LOCATOR/INTERCOM**  
again.
- 2** Handset:  
Press **INTERCOM** to  
answer.
- 3** Base unit:  
Speak into the **MIC**.
- 4** Handset:  
To end the intercom, press  
**INTERCOM**.

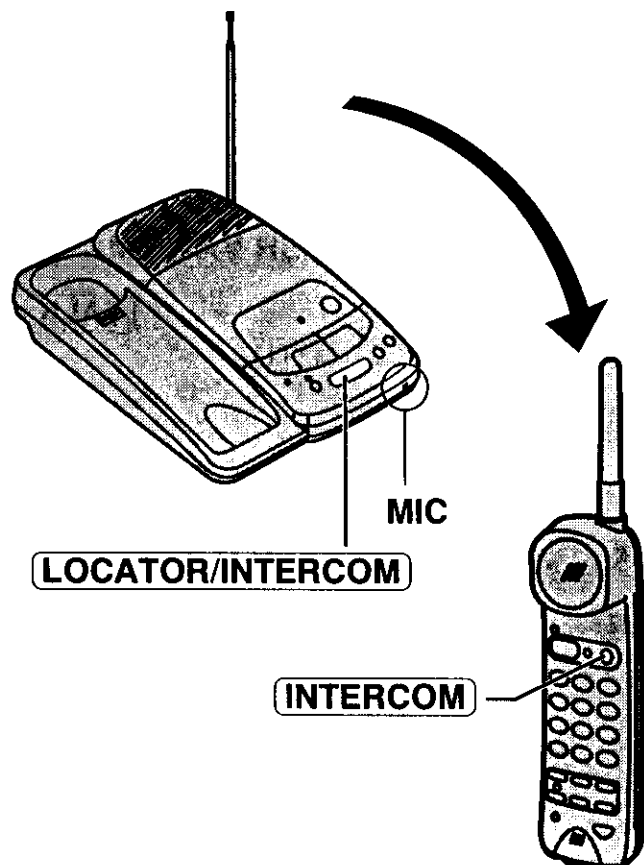



### During the intercom:

- Intercom calls can only be ended by the handset.
- If the handset user has difficulty hearing the base unit user, decrease the speaker volume by pressing **V**.
- If two tones sound, it means an incoming call has been received. To answer, press **TALK**. The intercom is ended.

## Special Features

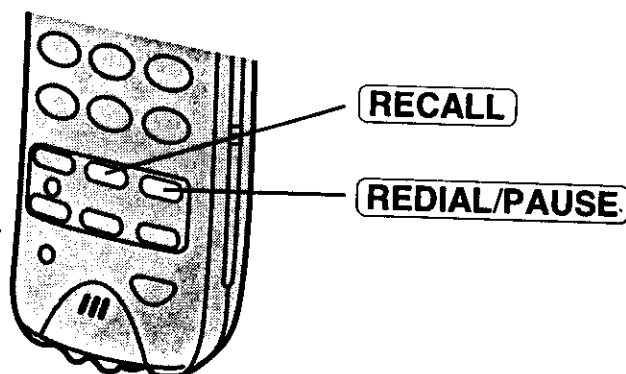

### Automatic Security Code Setting

Whenever you place the handset on the base unit, the unit automatically selects one of 65,000 security codes. These codes help to avoid unauthorized use of your telephone line by another cordless telephone.

### For Call Waiting Service Users

Press **RECALL** if you hear a call-waiting tone while talking.

- The first call is put on the hold and you can answer the second call.
- To return to the first caller, press **RECALL** again.
- Users in New Zealand should adjust the recall time to 600 msec for use with Telecom's Call Waiting Service. See page 26 on how to adjust recall time.

### If Your Unit is Connected to a PBX

We recommend you press **REDIAL/PAUSE** between the access number for an outside line and the phone number.

- Pressing **REDIAL/PAUSE** once makes a 3.5-second pause. This prevents misdialing when you redial or dial a stored number. (**REDIAL/PAUSE** counts as one digit.)

## ► Special Features

### RECALL Button

Pressing **RECALL** allows you to use special features of your host PBX such as transferring an extension call or accessing special telephone services (optional) such as call waiting.

For users in New Zealand please change the recall time to 600 msec or if connecting to a PBX consult with your PBX company as to the correct setting.

### Selecting the Recall Time

The recall time depends on your telephone exchange or host PBX. You can select from recall times "100, 250, 400 or 600 msec (millisecond)" by programming. The factory preset is "100 msec".

- 1 Press **PROGRAM/2WAY REC**.
  - The BATT LOW/PROG indicator lights.

- 2 Press the desired dialing button (1 to 4).
  - 1: 100 msec    2: 250 msec
  - 3: 400 msec    4: 600 msec

- 3 Press **AUTO**.

- 4 Press **RECALL**.
  - A confirmation tone sounds. (See below.)

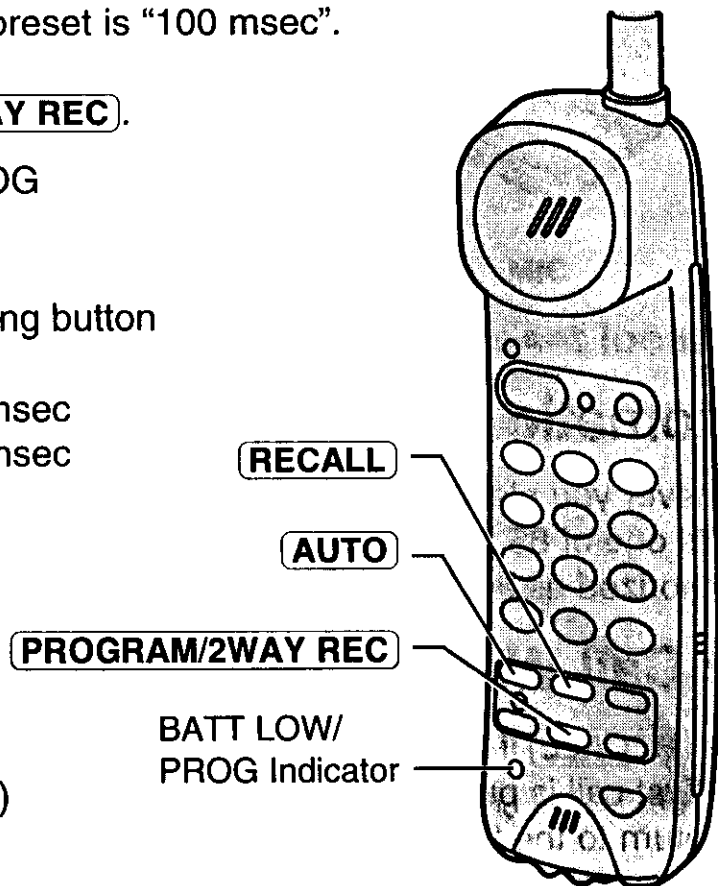

### What the confirmation tone means

- 1 beep: The new number is stored.
- 2 beeps: The number is the same as a previously stored one.
- 3 beeps: The number is not correct. Move toward the base unit or place the handset on the base unit. Then try again from the beginning.

- You can access Telecom's "CALL WAITING" service by setting "600 msec".
- If the host PBX cannot be controlled, select a higher recall time.
- For details, consult with your PBX telephone company.

# Automatic Answering Operation

When a call is received, the unit plays back your greeting message and records the caller's message.

## Setting the Unit to Answer Calls

Press **ANSWER ON** to turn on the answering system.

- The button lights.
- To turn off, press **ANSWER ON** again.  
The button's light goes out.

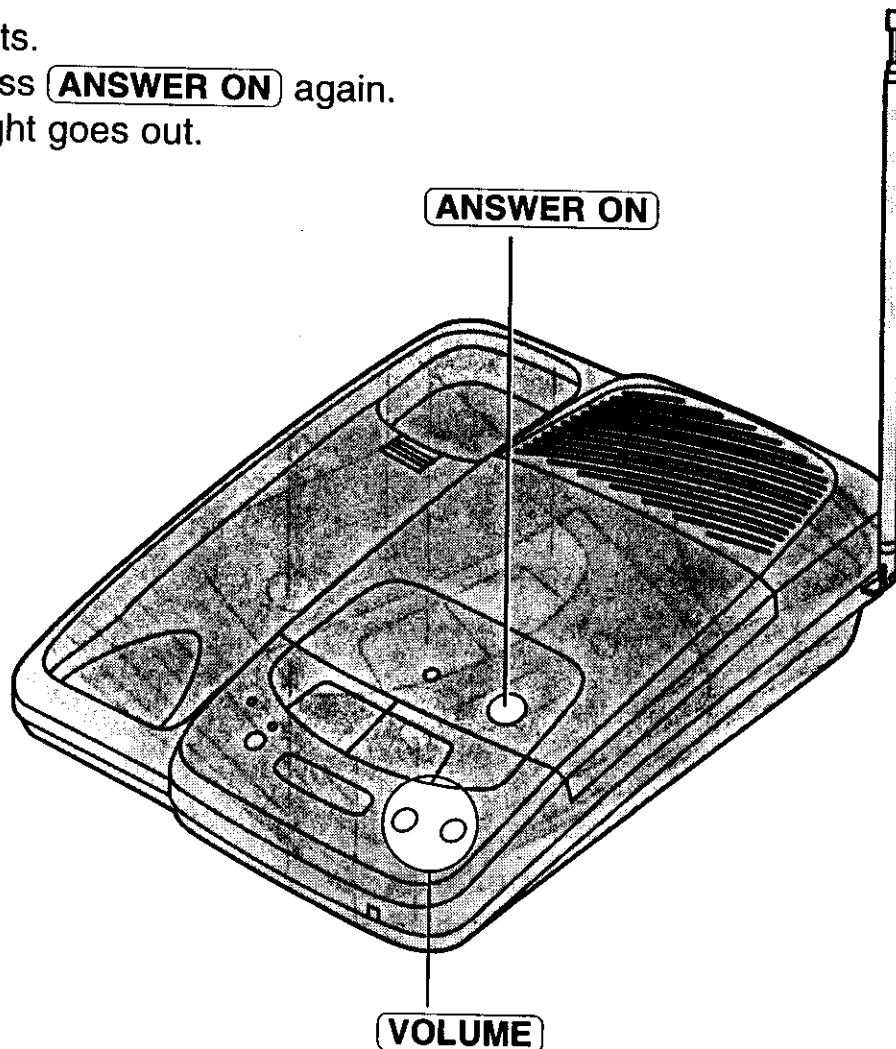

- You can also turn on the answering system with your handset or a remote phone (p. 39, 42).

## Monitoring incoming calls

When an incoming call is being recorded, you can monitor the call using the speaker. Adjust the volume with **VOLUME**.

To answer the call while monitoring, press **TALK** on the handset. The unit will stop recording.

To monitor using the handset, see page 42.

- KX-T4316NZ-W will not answer incoming calls on your FaxAbility number.

# Listening to the Recorded Messages

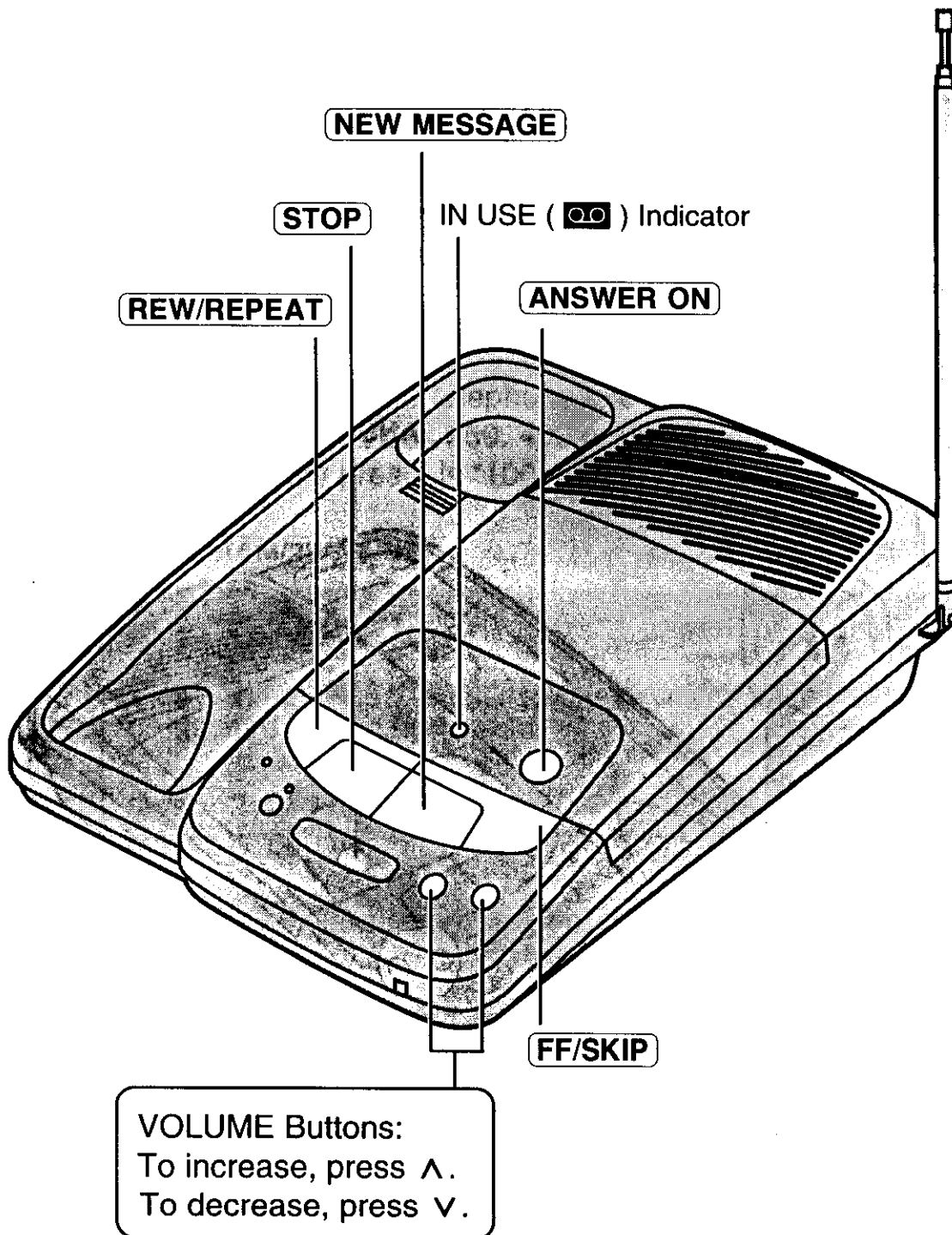

- When the tape is full, the IN USE ( ) indicator flashes rapidly. Use the opposite side of the tape or reset the tape (p. 30).
- When new incoming messages have been recorded, **ANSWER ON** flashes up to 15 times indicating the number of new messages.



## Listening to New Messages

Only the new messages you have not listened to will be played back.

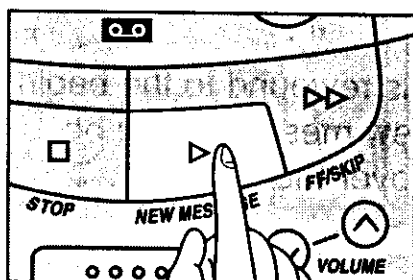

Press **NEW MESSAGE** lightly.

- A beep will sound.
- At the end of the newly recorded messages, 3 beeps sound and the tape stops.

## Listening to All of the (saved) Messages

All of the recorded messages including the reviewed ones will be played back.

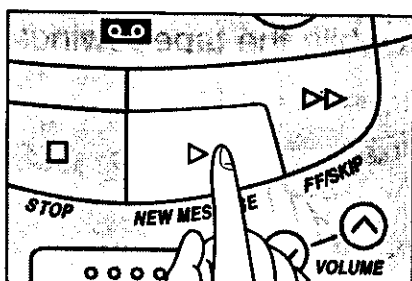

Press **NEW MESSAGE** firmly for more than 1 second.

- At the end of the recorded messages, 3 beeps sound and the tape stops.

To <b>repeat</b> the message	Press <b>REW/REPEAT</b> during playback. (If you press within 5 seconds of playback, the previous message is played.)
To <b>skip</b> the message	Press <b>FF/SKIP</b> during playback. The next message is played.
To <b>stop</b> the operation	Press <b>STOP</b> .

## ▶ Listening to the Recorded Messages

---

### Resetting the Tape

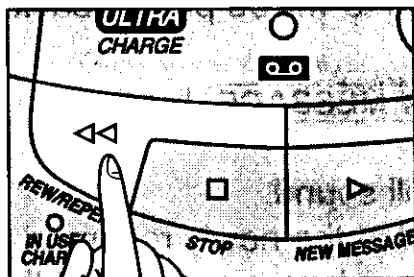

Press **REW/REPEAT** while not in playback mode.

- The tape is rewound to the beginning and the new messages will be recorded over the old ones.

### Erasing All of the Incoming Messages

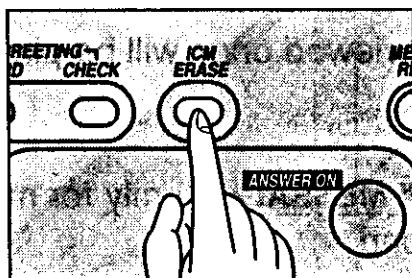

Press **ICM ERASE** after listening to all of the recorded messages.

- The unit erases all of the recorded messages while the tape rewinds.

### Saving Specific Messages

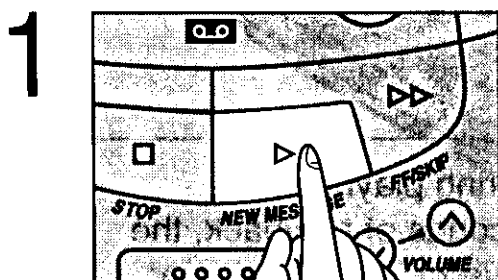

Play back the recorded messages to the end of the message(s) you want to save.

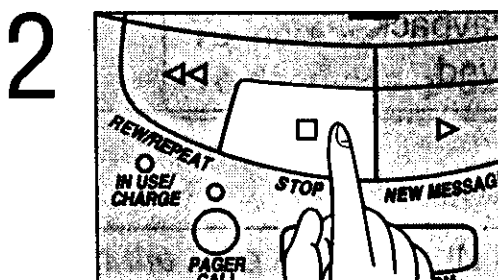

Press **STOP**.

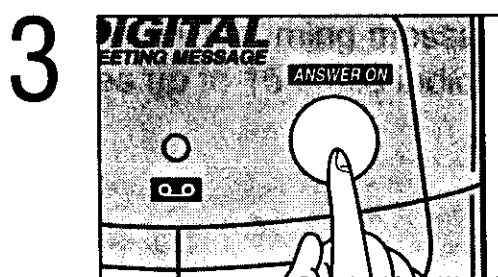

Press **ANSWER ON** to turn the answering system on.

- The button lights and the new messages will be recorded after the saved message(s).

# Recording a Memo Message

You may record a personal message.

1

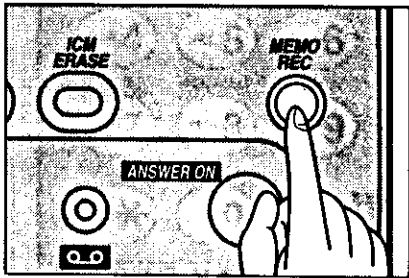

Press **MEMO REC**.

- A long beep sounds.

2

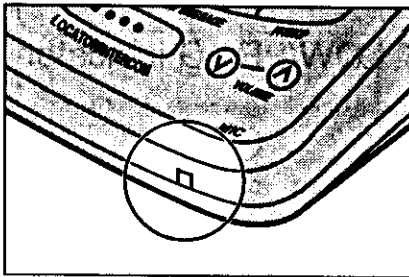

After the beep, speak clearly into the **MIC** (microphone).

- The IN USE (  ) indicator flashes.

3

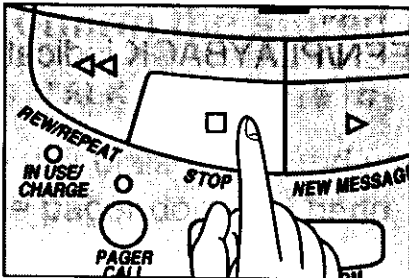

When finished, press **STOP**.

# Pager Call

Using this feature the unit informs you that you have received a message by calling your pager. Then you can retrieve the messages by using any touch tone telephone.

## Storing the Pager Number

Make sure that the TALK indicator light is off.

1

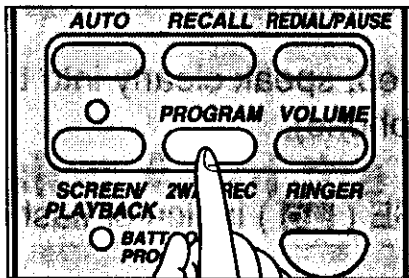

Press **PROGRAM/2WAY REC**.

- The BATT LOW/PROG indicator lights.

2

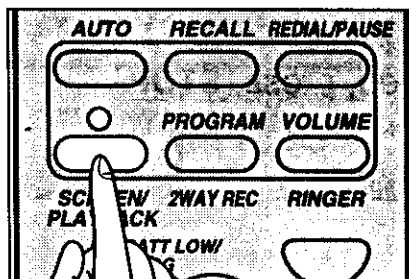

Press **SCREEN/PLAYBACK**.

- The SCREEN/PLAYBACK indicator lights.

3

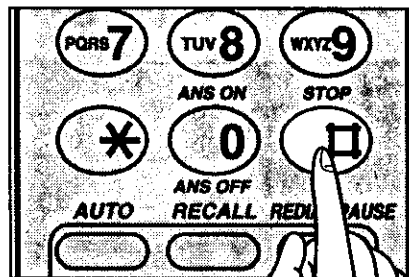

Press “#”.

4

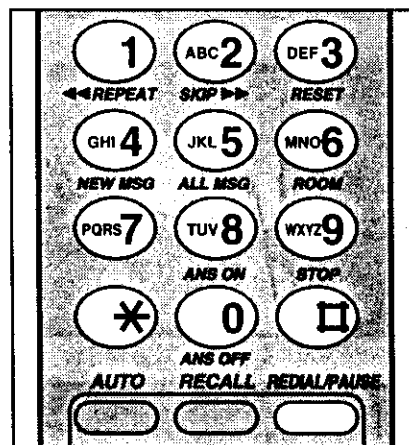

Enter the pager number up to 30 digits.

- If necessary, press **REDIAL/PAUSE**\*.
- If you misdial, press **PROGRAM/2WAY REC**, then restart from step 1.

\* Your pager company may require a delay after the pager number is dialed. Contact the pager company regarding the pause time required. Each time you press **REDIAL/PAUSE**, it creates a 3.5-second delay.



5

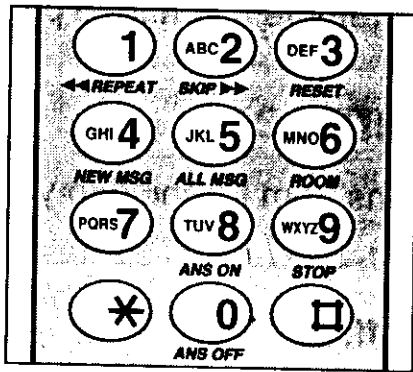

Enter the call back number you want to display on your pager.  
(Press # if required by your pager company. Please confirm with your pager company.)

6

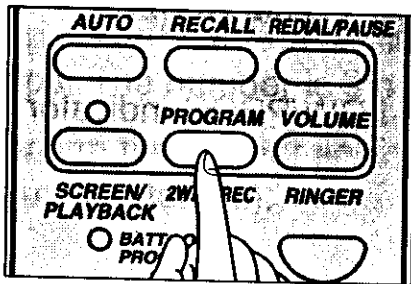

When finished, press **PROGRAM/2WAY REC**.

- The indicator lights go out.

## To confirm the stored number

Press **TALK** → **AUTO** → **#**.

- The unit dials the stored number and the pager beeps.
- If the pager does not beep, re-start from step 1.

## To erase the pager number

Press **PROGRAM/2WAY REC** → **SCREEN/PLAYBACK** → **#**  
→ **PROGRAM/2WAY REC**.

## Setting the Unit to Call the Pager

Make sure that the pager number has already been stored and “Answer on” is enabled.

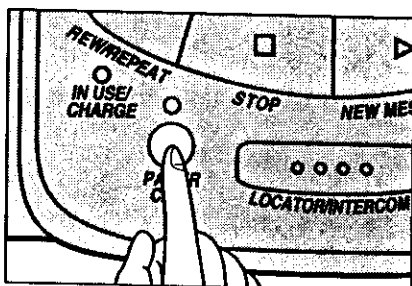

Press **PAGER CALL** to turn on the pager call mode.

- The PAGER CALL indicator lights.
- 6 beeps are heard if the pager number is not stored.
- The unit will call your pager only once about 30 seconds after recording each message.
- To turn off the mode, press

**PAGER CALL** again.

# Remote Operation from a Touch Tone Phone

You can operate the answering system from a remote touch tone phone.

## Setting the Remote Code Number

The remote code prevents unauthorized persons from listening to your messages.

Make sure that the TALK indicator light is off.

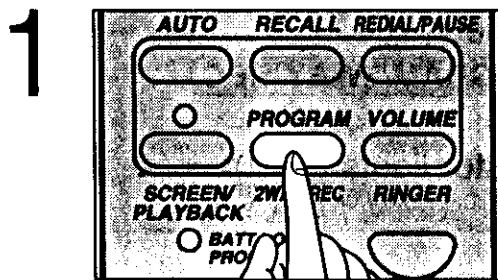

Press **PROGRAM/2WAY REC**.

- The BATT LOW/PROG indicator lights.

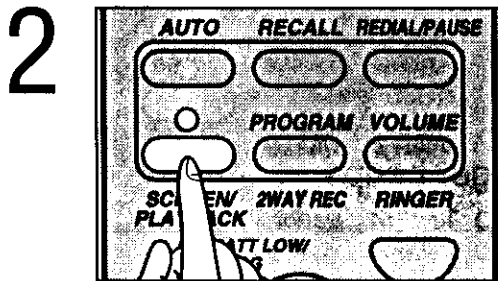

Press **SCREEN/PLAYBACK**.

- The SCREEN/PLAYBACK indicator lights.

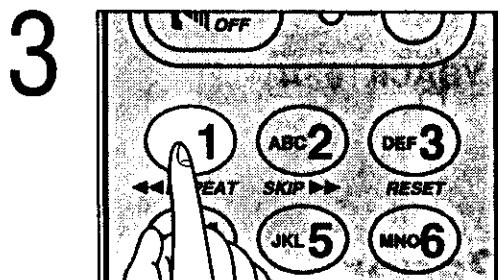

Press "1".

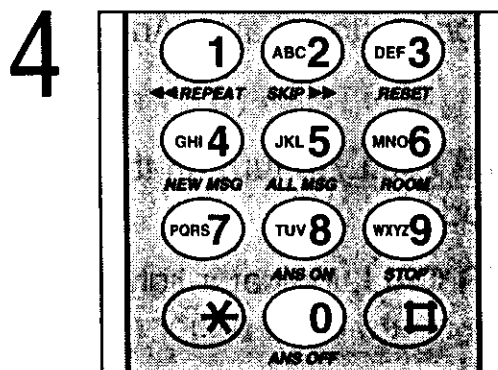

Enter a 2-digit remote code number (00–99).

5

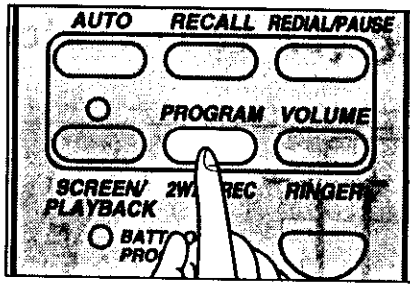

When finished,  
press **PROGRAM/2WAY REC**.

- The indicator lights go out.
- A confirmation tone sounds (see below).

## Confirmation tone meaning

1 beep: The new number is stored.

2 beeps: The number is the same as a previously stored one.

To confirm the current setting, repeat the same steps and listen for the confirmation tone(s).

## ► Remote Operation from a Touch Tone Phone

---

### Remote Operation Sequence

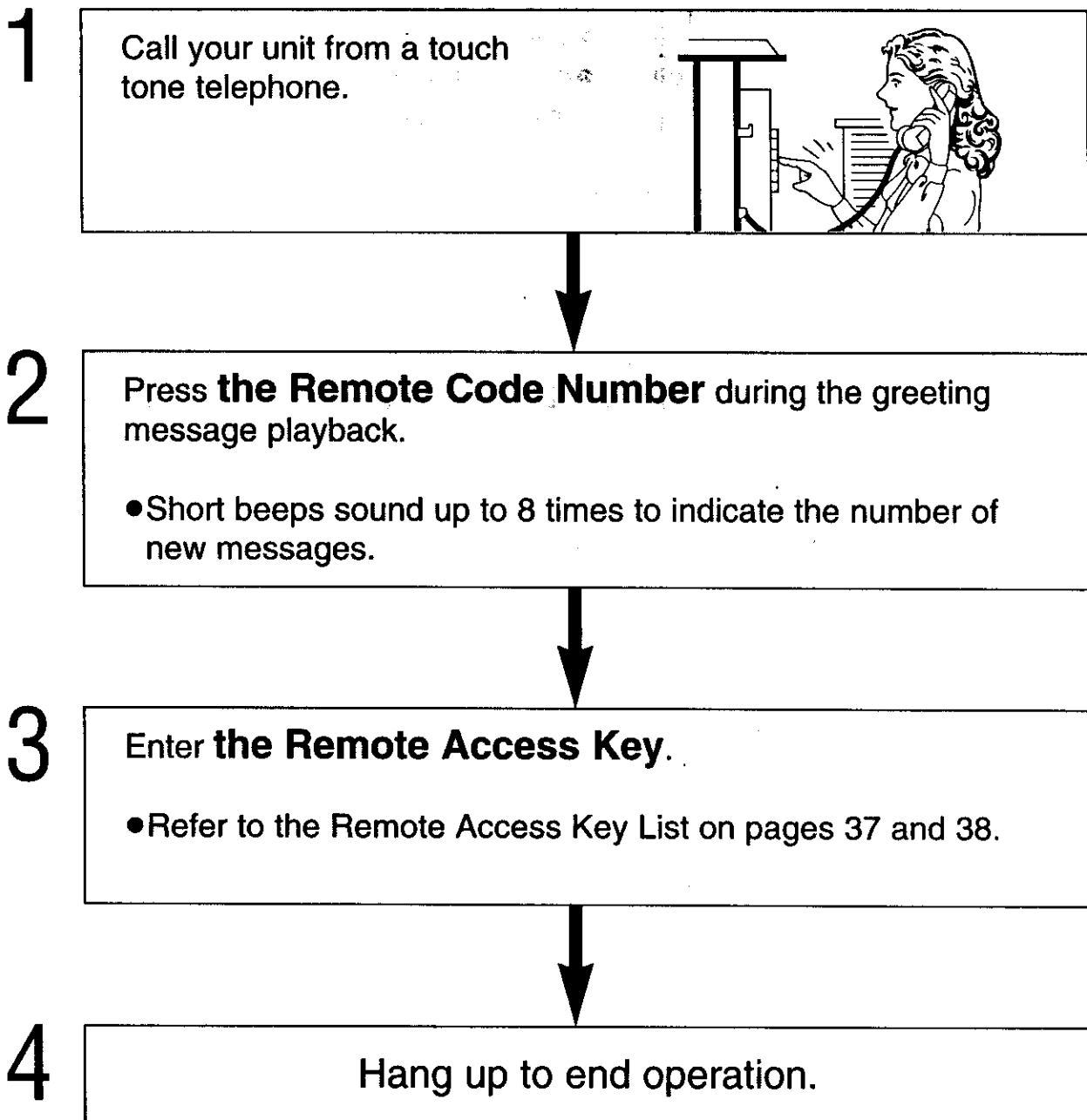



## Remote Access Key List

NEW MESSAGE PLAYBACK	<b>4</b>	<ul style="list-style-type: none"><li>• Only new messages are played back.</li><li>• 3 beeps sound at the end of playback. If you hear 6 long beeps, the incoming message tape is full. Reset the tape.</li></ul>
ALL MESSAGE PLAYBACK	<b>5</b>	<ul style="list-style-type: none"><li>• All of the messages are played back.</li><li>• 3 beeps sound at the end of playback. If you hear 6 long beeps, the incoming message tape is full. Reset the tape.</li></ul>
REPEAT	<b>1</b>	<ul style="list-style-type: none"><li>• The current message is repeated from the beginning.</li></ul>
SKIP	<b>2</b>	<ul style="list-style-type: none"><li>• The current message is skipped. Playback starts from the next message.</li></ul>
STOP	<b>9</b>	<ul style="list-style-type: none"><li>• Playback is stopped temporarily. To resume, press <b>9</b> again within 15 seconds or the call will be disconnected.</li></ul>
RESET	<b>3</b>	<ul style="list-style-type: none"><li>• Press within 10 seconds after hearing the last message.</li><li>• If pressed after new message playback, it will rewind to the beginning of the new messages. To rewind to the beginning of the tape, press <b>3</b> again after the beep.</li><li>• If pressed after all message playback, the tape will rewind to the beginning of the tape.</li><li>• To cancel the reset to save the messages, press <b>2</b>.</li></ul>

## ► Remote Operation from a Touch Tone Phone

---

ROOM SOUND  
MONITOR

6

- The sound around the base unit is monitored for 30 seconds.
- At the end of monitoring, a beep sounds. To continue, press **6** again within 10 seconds.

GREETING  
MESSAGE  
RECORDING

7

- A long beep sounds.



RECORD  
MESSAGE

- Speak immediately after the long beep up to 16 seconds.



9

- The new recorded message is played back.

PAGER CALL ON

\*

- The pager call feature is turned on.
- If you hear 6 beeps, the pager number is not stored. Store the number using the handset (p. 32).



7

PAGER CALL OFF

\*

- The pager call feature is turned off.



8

ANSWERING  
SYSTEM OFF

0

- The answering system is turned off.

---

## Skipping the greeting message

Callers can record messages without listening to the greeting.

After calling your unit, press **\*** during the greeting message playback.

- The unit skips the rest of the greeting and starts recording.

## Recording your own message (Marker message)

You can record your own message on the tape after listening to the last message.

1. Wait for 3 beeps indicating the end of the last message and another 10 seconds for 2 more beeps. Then leave your message.
2. When finished, hang up.

## Turning on the answering system

Call your unit and wait for 15 rings.

- The unit will answer and the greeting message is played.
- Hang up or enter the remote code number for more options.

# Operation from the Handset

You can operate your answering system from the handset.

## Operation Sequence

1

Press **SCREEN/PLAYBACK**.

- The indicator lights.
- Short beeps sound up to 8 times, indicating the number of new messages.

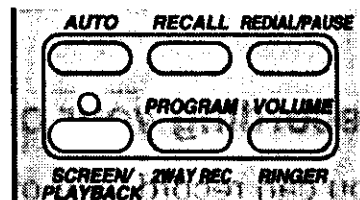

- If the SCREEN/PLAYBACK indicator flashes, the answering system is off. To turn on, see page 42.

2

Enter the **Access Key**.

- Refer to the Access Key List on pages 41 and 42.



3

Press **SCREEN/PLAYBACK** to end the operation.

- The indicator light goes out.

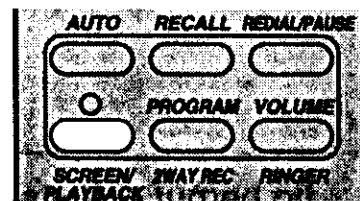

- When an incoming message has been recorded, 4 short beeps sound twice on the handset.





## Access Key List

NEW MESSAGE  
PLAYBACK

4

- Only new messages are played back.
- 3 beeps sound at the end of playback. If you hear 6 long beeps, the incoming message tape is full. Reset the tape.

ALL MESSAGE  
PLAYBACK

5

- All of the messages are played back.
- 3 beeps sound at the end of playback. If you hear 6 long beeps, the incoming message tape is full. Reset the tape.

REPEAT

1

- The current message is repeated from the beginning.

SKIP

2

- The current message is skipped. Playback starts from the next message.

STOP

9

- Playback is stopped temporarily. To resume, press **9** again within 15 seconds or the remote operation will be terminated.

RESET

3

- Press within 10 seconds after hearing the last message.
- If pressed after new message playback, it will rewind to the beginning of the new messages. To rewind to the beginning of the tape, press **3** again after the beep.
- If pressed after all message playback, the tape will rewind to the beginning.
- To cancel the reset to save the message, press **2**.

ROOM SOUND  
MONITOR

6

- The sound around the base unit is monitored for 30 seconds.
- At the end of monitoring, a beep sounds. To continue, press **6** again within 10 seconds.

## ► Operation from the Handset

ANSWERING  
SYSTEM ON

8

- The answering system is turned on. The SCREEN/PLAYBACK indicator lights.

ANSWERING  
SYSTEM OFF

0

- The SCREEN/PLAYBACK indicator light flashes and the answering system is turned off.

PAGER CALL ON

\* → 7

- The pager call feature is turned on.
- If you hear 6 beeps, the pager number is not stored. Store the number (p. 32).

PAGER CALL OFF

\* → 8

- The pager call feature is turned off.

## Monitoring incoming calls

When the SCREEN/PLAYBACK indicator flashes slowly, an incoming message is being recorded.

1. Press **SCREEN/PLAYBACK**.
  - The indicator lights steadily and you can listen to the incoming call.
  - To answer the call, press **TALK**. The recording is ended.
2. When finished, press **SCREEN/PLAYBACK**.

## Recording your telephone conversation

1. During a conversation, press **PROGRAM/2WAY REC**.
  - The SCREEN/PLAYBACK indicator lights and recording begins.
2. Continue your conversation.
3. When finished, press **PROGRAM/2WAY REC**.
  - The SCREEN/PLAYBACK indicator light goes out.

All persons using this device for recording telephone conversations shall comply with New Zealand law. This requires that at least one party to the conversation is to be aware that it is being recorded. In addition, the principles enumerated in the Privacy Act 1993 shall be complied with in respect to the nature of the personal information collected, the purpose for its collection, how it is to be used and what it disclosed to any other party.

## OPERATION FROM HANDSET

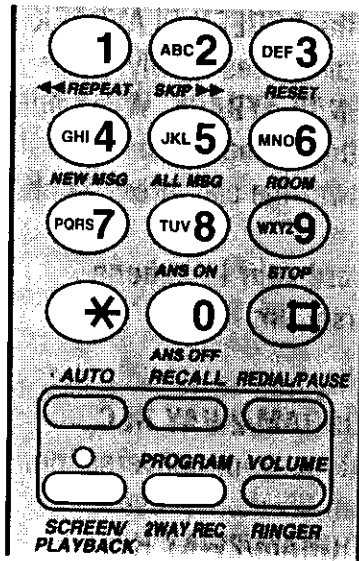

If the SCREEN/PLAYBACK indicator flashes when you press **SCREEN/PLAYBACK**, the answering system is off. To set the unit to answer calls, press "8".

Press **SCREEN/PLAYBACK**.

- To play back new messages, press "4".
- To play back all messages, press "5".
- To repeat, press "1".
- To skip, press "2".
- To reset the tape after playback, press "3".

Press **SCREEN/PLAYBACK** to end the operation.

## OPERATION FROM TONE PHONE

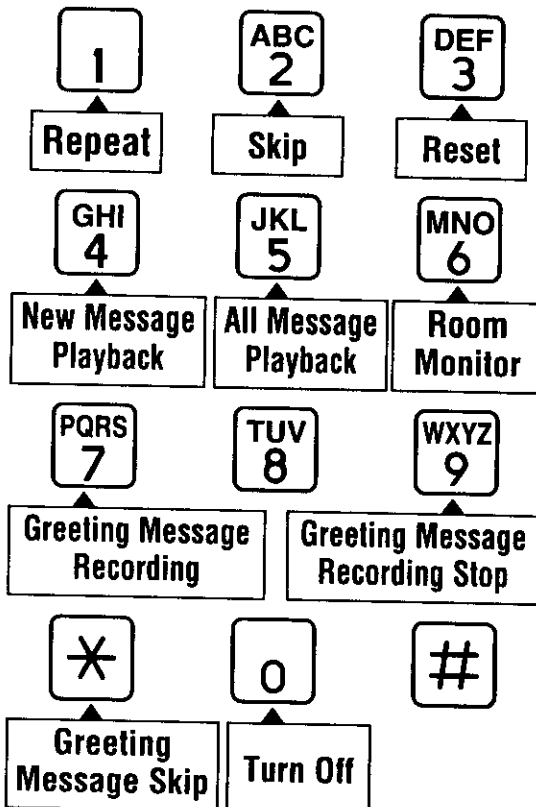

Call your unit.

Press remote code no. \_\_\_\_\_

- To play back new messages, press **4**.
- To play back all messages, press **5**.
- To repeat, press **1**.
- To skip, press **2**.
- To reset the tape after playback, press **3**.
- To record your message, speak after 2 beeps following the 3 beeps at the end of playback.
- To save the messages, hang up after playback.

When you press a button, press firmly.

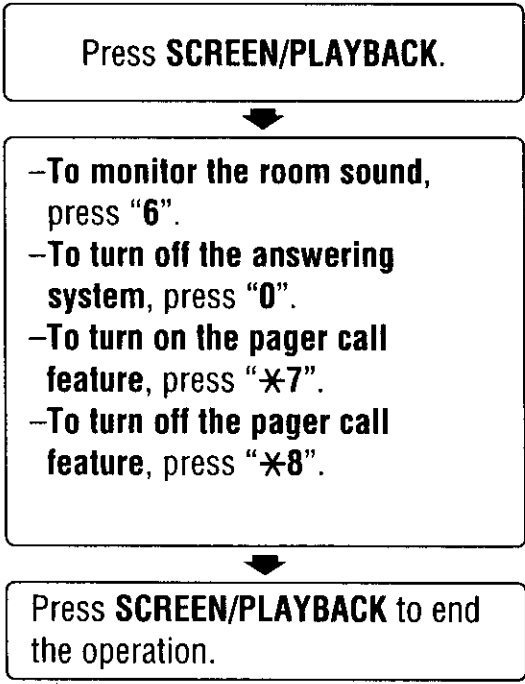

**To monitor incoming calls:**

When the SCREEN/PLAYBACK indicator flashes slowly, press **SCREEN/PLAYBACK**. When finished, press the button again. To answer the call, press **TALK**.

**To record your telephone conversation:**

1. During a conversation, press **PROGRAM/2WAY REC.**
2. Continue your conversation.
3. When finished, press **PROGRAM/2WAY REC.**

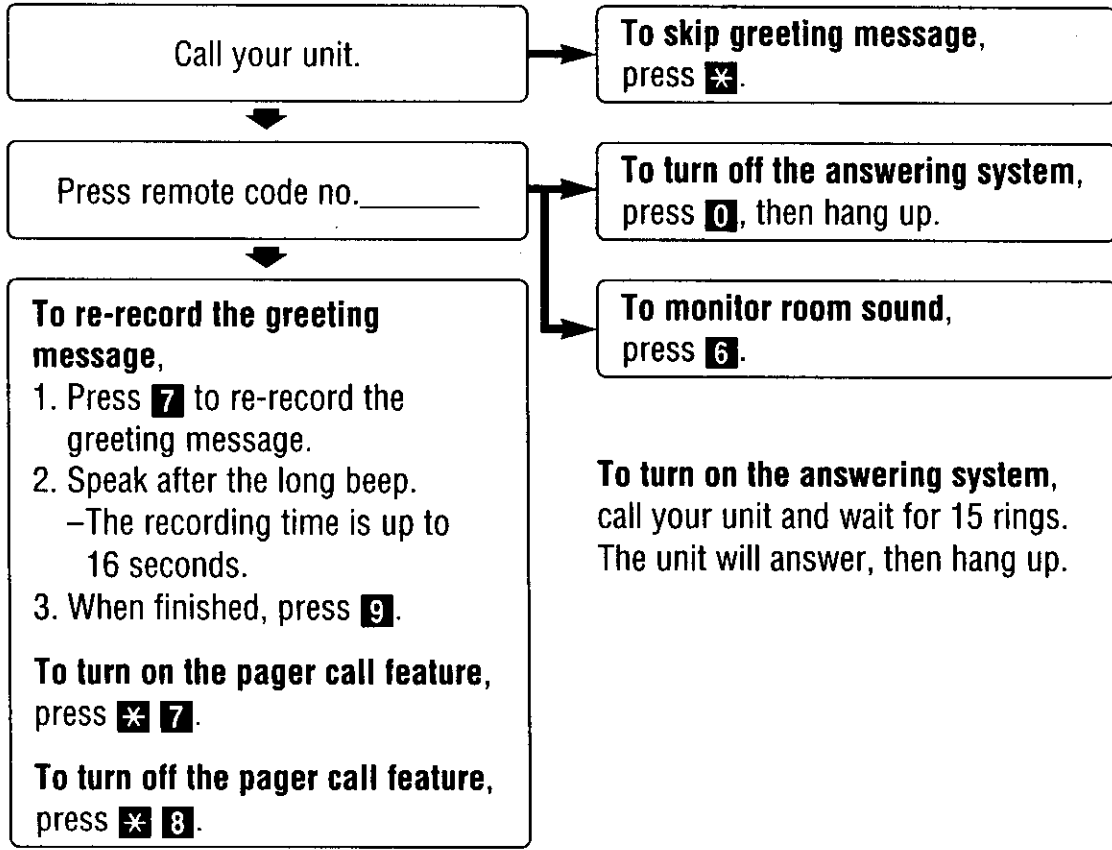

**To turn on the answering system,** call your unit and wait for 15 rings. The unit will answer, then hang up.

# Wall Mounting

This unit can be mounted on a wall.

- 1 Set the handset guide.
  - ① Push to remove.
  - ② Rotate 180°.
  - ③ Replace it with the tab facing upward.

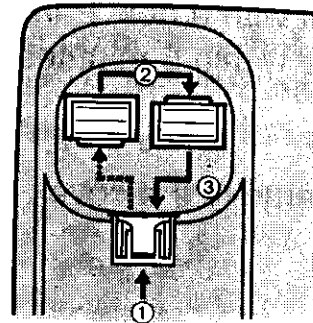

- 2 Connect the AC adaptor.

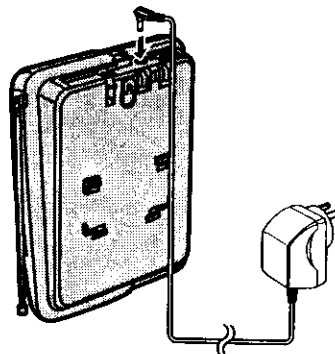

- 3 Tuck the telephone line cord inside the wall mounting adaptor, then push it in the direction of the arrow.

- The word "UP" should face upward.

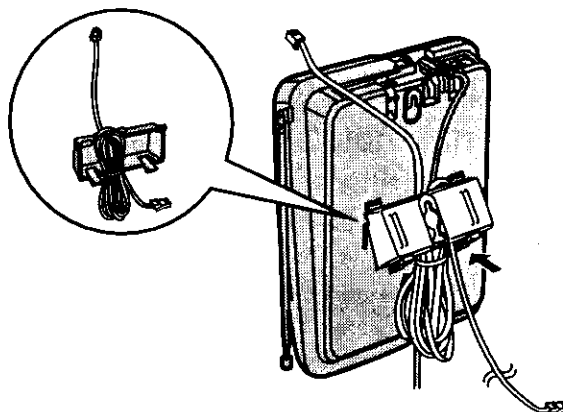

- 4 Install screws using the wall template below. Connect the telephone line cord. Mount the unit, then slide down.

- Extend the antenna fully.

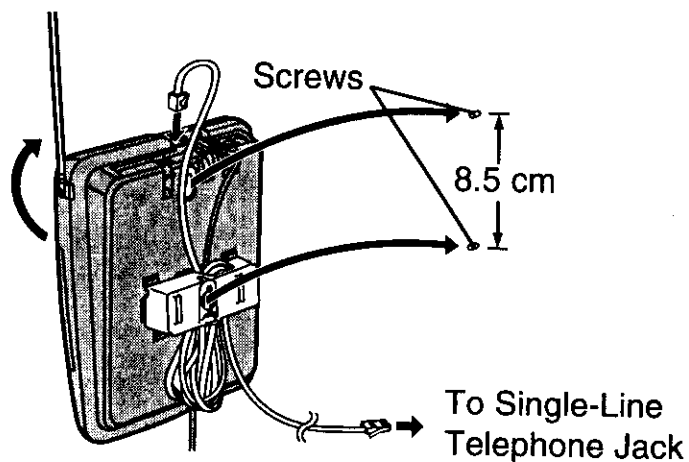

Wall Template

# Battery Replacement

---

If the BATT LOW/PROG indicator flashes after being fully charged, replace with a new Panasonic KX-A36A battery. To prevent memory loss, replace within 5 minutes.

- 1 Remove the cover.

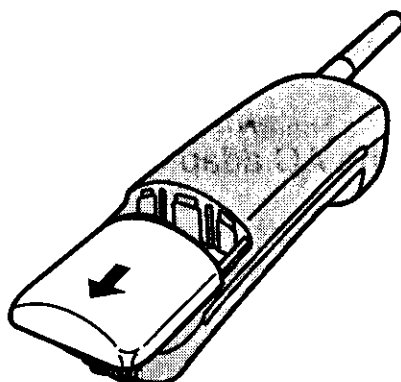

- 2 Replace the battery, then close the cover.

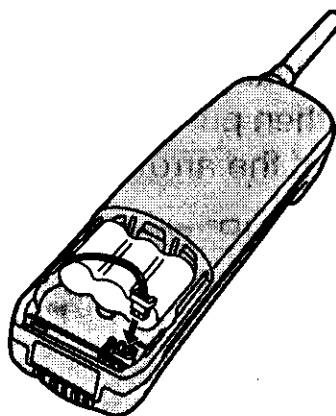

- 3 Charge the new battery for about 3 hours.

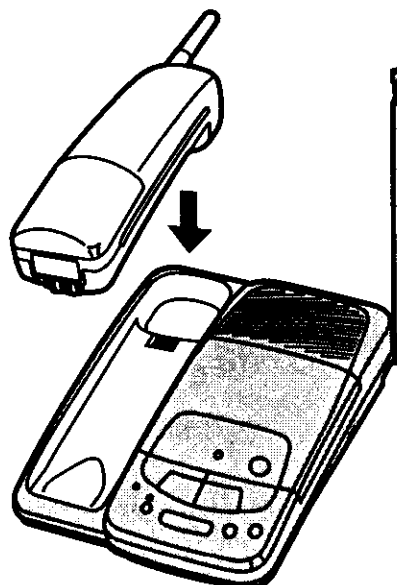

# Maintenance of Cassette Tape and Deck



## Cassette tape

- For optimum sound quality and performance, we recommend that you **use the opposite side of the cassette tape after six months and replace the tape with a new one every year** (assuming that the unit answers about ten calls a day).
- Never place a cassette tape near a magnetic source, such as a magnet or TV set. It may erase or distort the recorded message(s) on the tape.
- Slack in the tape can be tightened by rotating the tape reel with an instrument like a pencil, as shown.

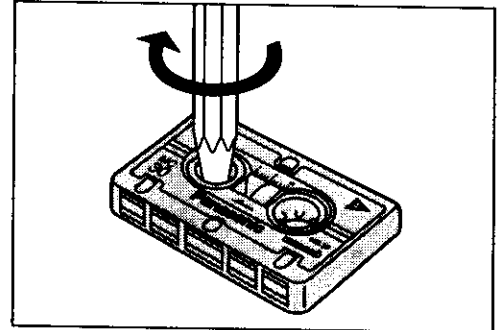

## Tape deck

Since the head and capstan assemblies are in contact with the tape, dirt and residue from the tape may easily adhere to these parts causing distortion. These parts should be cleaned periodically in the following manner. Clean the head surface, pinch roller, and capstan with a cotton swab. If these surfaces are extremely dirty, wipe them with a cotton swab dampened with alcohol, then dry with a soft cloth.

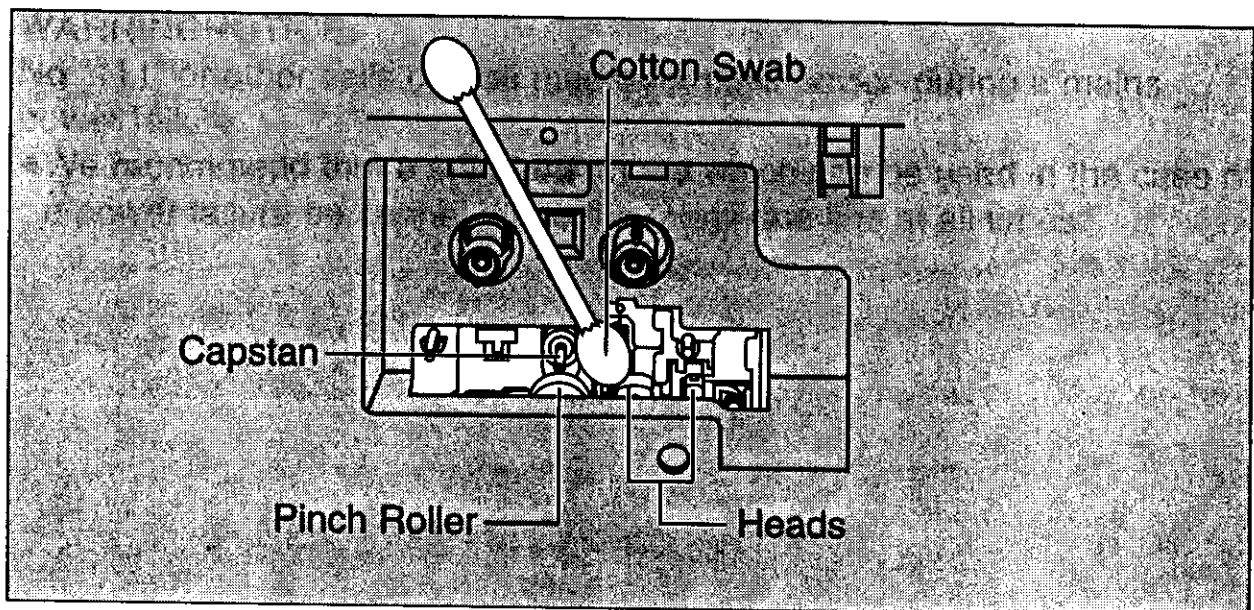

- Do not place magnetic or metal objects, such as a screwdriver, near the head assemblies. These objects can magnetize the heads.
- Do not oil any part of the unit.

## ► Maintenance of Cassette Tape and Deck

---

### Cassette cover installation

If the cover comes off, replace it by pushing down as shown.

Insert into the slots in  
the base unit carefully.

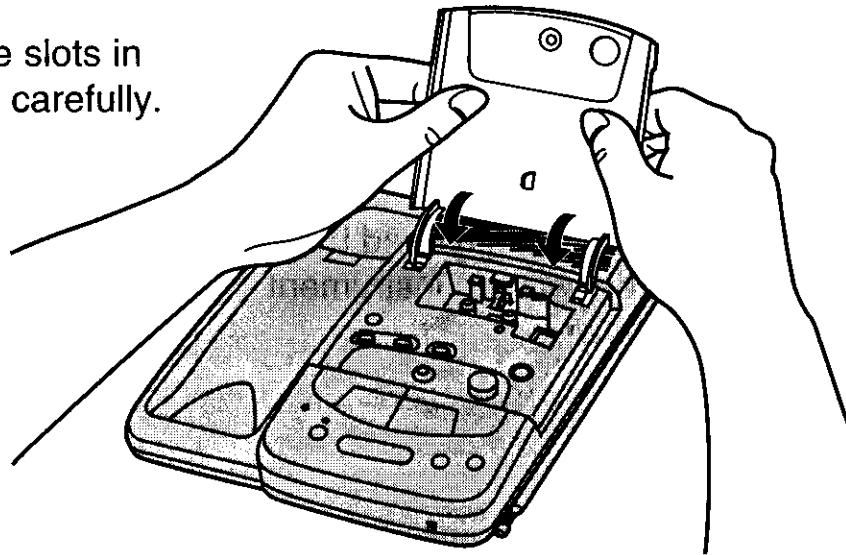



# Adding Another Phone

This unit will not function during a power failure. To connect a standard telephone on the same line, use a T-adaptor.

To Single-Line  
Telephone Jack

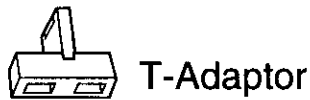

T-Adaptor

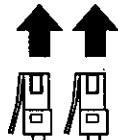

Telephone Line Cord

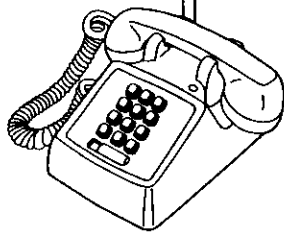

Standard Telephone

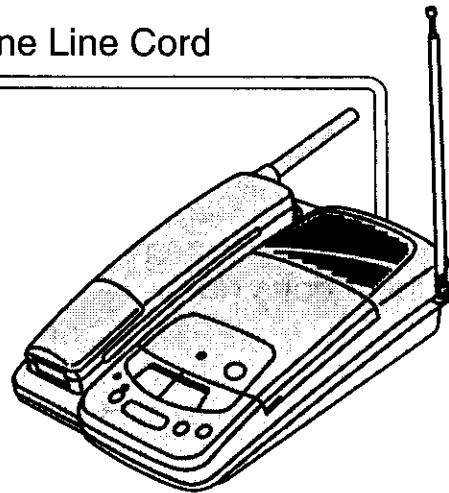

## WARNINGNOTICE:

No "111" or other calls can be made from this device during a mains power failure.

- We recommend that a standard phone which can be used in the case of a power failure be connected to the telephone line at all times.

# Before Requesting Help

## Cordless Telephone

Problem	Remedy
Static, sound cuts in/out, fades. Interference from other electrical appliances.	<ul style="list-style-type: none"><li>● Set the handset and base unit away from other electrical appliances.</li><li>● Move closer to the base unit.</li><li>● Extend the base unit antenna.</li><li>● Press <b>CH</b> to change the channel.</li></ul>
An alarm tone sounds when you press <b>TALK</b> , <b>SCREEN/PLAYBACK</b> or <b>INTERCOM</b> .	<ul style="list-style-type: none"><li>● Move toward the base unit and try again.</li><li>● Place the handset on the base unit and try again.</li><li>● Plug in the AC adaptor.</li><li>● Clean the charge contacts and charge again.</li></ul>
The handset does not ring.	<ul style="list-style-type: none"><li>● The ringer volume is "OFF". Press <b>VOLUME/RINGER</b> when the TALK and INTERCOM indicator lights are off.</li></ul>
You cannot store a phone number.	<ul style="list-style-type: none"><li>● The unit is in the talk or intercom mode.</li><li>● Do not pause for over 30 seconds while storing.</li></ul>
While storing a phone number, the unit starts to ring.	<ul style="list-style-type: none"><li>● Press <b>TALK</b> to answer. Restart storing after the call is ended.</li></ul>
During intercom, two tones are heard.	<ul style="list-style-type: none"><li>● An outside call is received. To answer, press <b>TALK</b>.</li></ul>
<b>REDIAL/PAUSE</b> does not function properly.	<ul style="list-style-type: none"><li>● The button has a double function; redial before dialing (p. 20) and pause during dialing (p. 25).</li></ul>
<b>VOLUME/RINGER</b> does not function properly.	<ul style="list-style-type: none"><li>● The button has a double function; receiver volume selector during a conversation (p. 20) and a ringer selector when the TALK and INTERCOM indicator lights are off (p. 21).</li></ul>
<b>LOCATOR/INTERCOM</b> does not function properly.	<ul style="list-style-type: none"><li>● The handset is too far from the base unit or an outside call is in process.</li></ul>



# Answering System

Problem	Remedy
The answering system is on, but incoming messages cannot be recorded.	<ul style="list-style-type: none"><li>● The incoming message tape is full. Use the opposite side or reset the tape.</li></ul>
You cannot operate the answering system from a touch tone phone.	<ul style="list-style-type: none"><li>● Turn the answering system on (p. 39).</li><li>● Press your correct remote code number.</li><li>● Press each button firmly to produce a long tone.</li><li>● In some areas, remote touch tone phones may not function due to telephone line conditions.</li></ul>
You cannot operate the answering system from the base unit.	<ul style="list-style-type: none"><li>● The handset is in use. Wait till the IN USE/CHARGE indicator light goes out.</li></ul>
The incoming message continues to be recorded after a caller hangs up.	<ul style="list-style-type: none"><li>● Set the VOX SENS function to "LOW" (p. 19).</li></ul>
I cannot operate the answering system with the handset.	<ul style="list-style-type: none"><li>● Move toward the base unit.</li><li>● Someone is using the answering system.</li></ul>
<b>VOLUME</b> does not function properly.	<ul style="list-style-type: none"><li>● Clean the heads.</li></ul>
4 short beeps are heard twice from the handset.	<ul style="list-style-type: none"><li>● A new message has just been recorded.</li></ul>
While operating the answering system from the handset, two tones are heard.	<ul style="list-style-type: none"><li>● An incoming call is received. Press <b>TALK</b> to answer. The remote operation is ended.</li></ul>
<b>PROGRAM/2WAY REC</b> does not function properly.	<ul style="list-style-type: none"><li>● The button has a double function. If pressed during a conversation, the unit records the conversation. If pressed when the TALK indicator light is off, the unit enters the programming mode.</li></ul>

## ► Before Requesting Help

---

### General

Problem	Remedy
My "Call Waiting" service is not activated when the RECALL button is pressed.	<ul style="list-style-type: none"><li>● Change the RECALL time to "600 msec" (p. 26).</li></ul>
The BATT LOW/PROG indicator flashes. Beeps sound intermittently.	<ul style="list-style-type: none"><li>● Charge the battery fully (p. 11).</li></ul>
You charged the battery fully, but the BATT LOW/PROG indicator flashes after a few telephone calls.	<ul style="list-style-type: none"><li>● Clean the charge contacts and charge again.</li><li>● Replace with a new battery (p. 46).</li></ul>
You cannot set-up any programmable preparations such as selecting the number of rings.	<ul style="list-style-type: none"><li>● You cannot program while the unit is in the talk or intercom mode.</li></ul>
During the programmable preparations, the unit starts to ring.	<ul style="list-style-type: none"><li>● Press <b>TALK</b> to answer. Restart programming after the call is ended.</li></ul>
The unit does not work.	<ul style="list-style-type: none"><li>● Check the settings (p. 10, 11).</li><li>● Clean the charge contacts and charge the battery fully.</li><li>● Place the handset on the base unit for security code identification.</li><li>● KX-T4316NZ-W is not designed to be used with rotary (pulse dialing) services.</li></ul>
While operating the unit, the AC adaptor feels warm. The IN USE/CHARGE indicator lights while the handset is on the base unit.	<ul style="list-style-type: none"><li>● These are normal operating conditions.</li></ul>

---

<b>Problem</b>	<b>Remedy</b>
I cannot use the unit during a power failure.	<ul style="list-style-type: none"><li>●The unit will not function during a power failure.</li><li>●We recommend that a standard phone which can be used in the case of a power failure be connected to the telephone line at all times (p. 49).</li></ul>
The unit stops working during operation.	<ul style="list-style-type: none"><li>●Place the handset on the base unit and unplug the AC adaptor to reset. Plug in and try again.</li><li>●Re-insert the handset battery and try again.</li></ul>

## Free Manuals Download Website

<http://myh66.com>

<http://usermanuals.us>

<http://www.somanuals.com>

<http://www.4manuals.cc>

<http://www.manual-lib.com>

<http://www.404manual.com>

<http://www.luxmanual.com>

<http://aubethermostatmanual.com>

Golf course search by state

<http://golfingnear.com>

Email search by domain

<http://emailbydomain.com>

Auto manuals search

<http://auto.somanuals.com>

TV manuals search

<http://tv.somanuals.com>