

# Panasonic

## Advanced Hybrid System User Manual

---

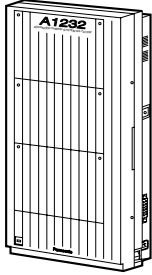

Model No. **KX-TA1232**



Please read this manual before using the Advanced Hybrid System.

---

Thank you for purchasing the Panasonic Telephone System.

# System Components

	<b>Model No.</b>	<b>Description</b>
<b>Service Unit</b>	KX-TA1232	Advanced Hybrid System (Main Unit)
<b>Telephone</b>	KX-T7130	Proprietary telephone with display
	KX-T7135	Proprietary telephone with backlit display
	KX-T7020	Proprietary telephone
	KX-T7030	Proprietary telephone with display
	KX-T7050	Proprietary telephone
	KX-T7055	Proprietary telephone
<b>Optional Equipment</b>	KX-T7040	DSS Console
<b>User-supplied Equipment</b>	Single Line Telephones	

For your future reference

SERIAL NO. _____ (found on the bottom of the unit)
DATE OF PURCHASE _____
NAME OF DEALER _____
DEALER'S ADDRESS _____ _____ _____
DEALER'S TEL. NO. _____

# Attention

## When using the KX-T7000 series, keep the following conditions in mind:

- If there is any trouble, unplug the extension line and connect a known working phone. If the known working phone operates properly, have the defective phone repaired by a specified Panasonic Factory Service Center. If the known working phone does not operate properly, check the Advanced Hybrid System and the internal extension wiring.
- Keep the unit away from heating appliances and electrical noise generating devices such as fluorescent lamps and motors.
- The unit should be kept free of dust, moisture and vibration, and should not be exposed to direct sunlight.
- Do not use benzine, thinner, or any abrasive powder to clean the cabinet. Wipe it with a soft cloth.
- Do not use any handset other than a Panasonic handset.

## When you ship the product

Carefully pack and send it prepaid, adequately insured and preferably in the original carton. Attach a postage-paid letter, detailing the symptom, to the outside of the carton. **DO NOT** send the product to the Executive or Regional Sales offices. They are **NOT** equipped to make repairs.

## Product service

Panasonic Factory Servicenters for this product are listed in the servicenter directory. Consult with your authorized Panasonic dealer for detailed instructions.

## **WARNING**

**TO PREVENT FIRE OR SHOCK HAZARD, DO NOT EXPOSE THIS PRODUCT TO RAIN OR ANY TYPE OF MOISTURE.**

## Accessory Order Information

- Replacement parts and accessories are available through your local authorized parts distributor.
- For ordering accessories, call toll free: 1-800-332-5368.

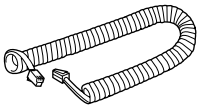
Part No.	Picture	Description	Comment
KX-J07W/B		Handset cord	213.36 cm (7 feet)
KX-J15W/B			457.2 cm (15 feet)
KX-J25W/B			762 cm (25 feet)

W:White

B:Black

---

# Introduction

## Who Should Use This Manual

This manual is designed for users of an Advanced Hybrid System, model number KX-TA1232. It is to be used after the system is installed and System Programming is completed. The focus is Proprietary Telephones (PTs); KX-T7020/KX-T7030/KX-T7130/KX-T7135/KX-T7050/KX-T7055, DSS Console; KX-T7040, Single Line Telephones (SLTs) and their features. The step-by-step procedures required to activate each feature are discussed in detail. Illustrations of the KX-TA1232 system and the required System Programming are provided under separate cover in the Installation Manual and the Programming Guide.

## Construction of This Manual

This manual consists of the following sections:

### (Section 1) PT Overview

Provides configuration information on PTs. It provides an illustration of each telephone, identifies their feature buttons, supplies background information on these feature buttons, and provides initial settings.

### (Section 2) Station Programming

Provides the steps required to assign features to PT flexible buttons and to the PT system.

### (Section 3) User Programming

Provides the steps required to assign some features to the system.

### (Section 4) Station Features and Operation (PT/SLT)

Provides background information on the PT/SLT features and lists the steps required to activate each feature.

### (Section 5) DSS Console Features

Provides configuration information on the DSS Console. It gives background information on the DSS Console features and lists the steps required to activate each feature.

### (Section 6) Appendix

Provides Display Examples, a Feature Number List, Tone List, and other information are explained in this section.

### (Section 7) Index

Provides the important words and phrases to help you access the required information easily.

## Features and Capabilities

KX-TA1232 systems is sophisticated and powerful system that satisfies just what you expect of an office communications system. Some of the remarkable features are listed below.

**Automatic Callback Busy (Camp-On)** informs you when the selected outside line or the called party becomes idle.

**Call Log, Incoming (— Option)** allows you to confirm the incoming outside call information on the display. You can also call back the caller by selecting one of the memorized numbers. This feature is available only for the KX-T7030, KX-T7130 and KX-T7135.

**Conference, Unattended** allows you to leave the conference and let the other two parties continue conversation when you are in a conference with two outside parties. You can also return to the conference.

**Data Line Security** prohibits various tones, such as a call waiting tone or hold recall tone, from sounding at the extension in the data communication mode. It also blocks overriding by other extensions, such as Executive Busy Override.

**Doorphone and Door Opener (— Option)** enables the conversation between you and a visitor at the door. You can also unlock the door a few seconds from your phone.

**Executive Busy Override** allows you to enter into an existing conversation at an extension/ outside line.

**Full One-Touch Dialing** allows you to have easy access to a desired party or system feature by pressing just one button.

**Message Waiting** allows you to leave a message notification for another extension. The message waiting lamp (MESSAGE indicator) gives a visual indication that a message notification has been received. Even if the Message button is not provided or assigned, a special tone after going off-hook indicates that a message notification has been received.

**Paralleled Telephone Connection** allows you to connect your PT in parallel with an SLT. Each telephone can have the same extension number so that you can use either telephone.

**VPS Integration (— Option)** enables forwarding any incoming call to Voice Mail. Recording or Playing back the message(s) is also available. To use Voice Mail services, installing a Voice Processing System (VPS) is required.

## Terms used in the Descriptions

### Feature Numbers

A feature number is an access code for various functions when programming or executing features using proprietary or single line telephones connected to the system. You can access available features by dialing the corresponding feature number (and additional number, if required).

There are two types of feature numbers as follows:

- Flexible feature number
- Fixed feature number

While fixed feature numbers cannot be changed, flexible feature numbers can be changed. Refer to the Features Guide for details. In this manual, the default numbers are used to describe each operation and illustration. Use the new programmed number if you have changed a flexible feature number. The lists of fixed numbers and default flexible feature numbers are shown in the Appendix .

### If you use a dial pulse (DP) type single line telephone (SLT);

It is not possible to access features that have "\*" or "#" in their feature numbers.

### Tones

Various tone types, such as a Confirmation tone, Dial tone, Call Waiting tone, etc. are explained in the Appendix.

### Display

The display examples are in each operation step, if required. The display information list is in the Appendix for your convenience.

**Programming Guide References**

The related and required programming titles are noted for your reference in the Programming Guide. System Programming should be done by the extension which is connected to Jack number 01 or the System Manager. A KX-T7030, KX-T7130 and KX-T7135 can be used for this programming. Station Programming is individual programming at your own proprietary telephone (PT). You can customize the extension to your needs using any type of proprietary telephone.

**Features Guide References**

The related feature titles are noted for your reference in the Features Guide.

**User Manual References**

The related feature titles are noted for your reference in this manual.

---



---

# Table of Contents

<b>1</b>	<b>PT Overview</b>	
<b>1.1</b>	<b>Configuration</b>	<b>14</b>
1.1.1	Configuration	14
1.1.2	Location of Controls	15
1.1.3	Feature Buttons	20
1.1.4	Initial Settings	25
1.1.5	LED Indication	27
<b>2</b>	<b>Station Programming</b>	
<b>2.1</b>	<b>Station Programming Instructions</b>	<b>30</b>
2.1.1	Station Programming Instructions	30
<b>2.2</b>	<b>Station Programming</b>	<b>35</b>
2.2.1	Initial Settings	35
2.2.2	Flexible Button Assignment	37
2.2.3	Phantom Extension Ringing On/Off Set	39
2.2.4	Self-Extension Number Confirmation (KX-T7030, KX-T7130 and KX-T7135 only)	40
2.2.5	Station Programming Data Default Set	41
<b>3</b>	<b>User Programming</b>	
<b>3.1</b>	<b>User Programming Instructions</b>	<b>44</b>
3.1.1	General Programming Instructions	44
3.1.2	Programming Methods	47
<b>3.2</b>	<b>User Programming</b>	<b>49</b>
3.2.1	[000] Date and Time Set	49
3.2.2	[001] System Speed Dialing Number Set	52
3.2.3	[003] Extension Number Set	55
3.2.4	[004] Extension Name Set	58
3.2.5	[017] DISA User Codes	60
<b>4</b>	<b>Station Features and Operation (PT/SLT)</b>	
<b>4.1</b>	<b>Before Operating</b>	<b>64</b>
4.1.1	Before Operating	64
<b>4.2</b>	<b>Basic Operations</b>	<b>66</b>
4.2.1	Making Calls	66
4.2.2	Receiving Calls	68
<b>4.3</b>	<b>Station Features and Operation</b>	<b>69</b>
4.3.1	Absent Message Capability	69
4.3.2	Account Code Entry	72
4.3.3	Alternate Calling — Ring / Voice	75
4.3.4	Answering, Direct Outside Line [PT only]	77
4.3.5	Automatic Callback Busy (Camp-On)	78
4.3.6	Background Music (BGM) [PT only]	80
4.3.7	Busy Station Signaling (BSS)	81
4.3.8	Call Forwarding — SUMMARY	82
4.3.9	Call Forwarding — All Calls	84
4.3.10	Call Forwarding — Busy	85



---

4.3.11	Call Forwarding — No Answer .....	86
4.3.12	Call Forwarding — Busy / No Answer .....	87
4.3.13	Call Forwarding — to Outside Line .....	88
4.3.14	Call Forwarding — Follow Me .....	89
4.3.15	Call Forwarding — CANCEL .....	90
4.3.16	Call Hold .....	91
4.3.17	Call Hold, Exclusive [PT only] .....	93
4.3.18	Call Hold Retrieve .....	95
4.3.19	Call Information / Log, Incoming .....	97
4.3.20	Call Log, Incoming [PT only] .....	99
4.3.21	Call Log Lock, Incoming in the Personal Area [PT only] .....	104
4.3.22	Call Park .....	106
4.3.23	Call Pickup, Directed .....	108
4.3.24	Call Pickup, Group .....	109
4.3.25	Call Pickup, Outside Line .....	110
4.3.26	Call Pickup Deny .....	111
4.3.27	Call Splitting .....	112
4.3.28	Call Transfer — to Extension .....	114
4.3.29	Call Transfer — to Outside Line .....	117
4.3.30	Call Waiting .....	119
4.3.31	Call Waiting from Central Office .....	122
4.3.32	Caller ID Call Waiting [PT only] .....	123
4.3.33	Camp-On Transfer to Phantom Extension / Ring Group .....	125
4.3.34	Conference .....	127
4.3.35	Conference, Unattended [PT only] .....	131
4.3.36	Data Line Security .....	133
4.3.37	Direct Inward System Access (DISA) .....	134
4.3.38	Do Not Disturb (DND) .....	138
4.3.39	Do Not Disturb (DND) Override .....	140
4.3.40	Doorphone Call .....	141
4.3.41	Electronic Station Lockout .....	145
4.3.42	Emergency Call .....	147
4.3.43	Executive Busy Override — Extension .....	148
4.3.44	Executive Busy Override — Outside Line [PT only] .....	150
4.3.45	Executive Busy Override Deny .....	152
4.3.46	External Feature Access .....	153
4.3.47	Flash [PT only] .....	155
4.3.48	Full One-Touch Dialing [PT only] .....	156
4.3.49	Hands-free Answerback [PT only] .....	157
4.3.50	Hands-free Operation [PT only] .....	158
4.3.51	Intercom Calling .....	160
4.3.52	Live Call Screening (LCS) [PT only] .....	162
4.3.53	Lockout .....	169
4.3.54	Log-In / Log-Out .....	170
4.3.55	Message Waiting .....	172
4.3.56	Microphone Mute [PT only] .....	176
4.3.57	Night / Day (Lunch / Break) Service .....	177
4.3.58	One-Touch Dialing [PT only] .....	180
4.3.59	Operator Call .....	181

4.3.60	Outward Dialing, Line Access — SUMMARY .....	182
4.3.61	Paging — SUMMARY .....	185
4.3.62	Paging — ANSWER .....	189
4.3.63	Paging — Deny [PT only] .....	190
4.3.64	Paging and Transfer .....	191
4.3.65	Paralleled Telephone Connection .....	195
4.3.66	Personal Speed Dialing .....	196
4.3.67	Phantom Extension .....	198
4.3.68	Pickup Dialing (Hot Line) .....	202
4.3.69	Privacy Release [PT only] .....	204
4.3.70	Pulse to Tone Conversion .....	206
4.3.71	Quick Dialing .....	207
4.3.72	Redial, Last Number .....	208
4.3.73	Redial, Saved Number [PT only] .....	209
4.3.74	Room Monitor .....	210
4.3.75	Secret Dialing [PT only] .....	213
4.3.76	Station Program Clear .....	214
4.3.77	System Speed Dialing .....	215
4.3.78	Timed Reminder .....	216
4.3.79	Toll Restriction Override — SUMMARY .....	219
4.3.80	Toll Restriction Override by Account Code Entry .....	220
4.3.81	Toll Restriction Override for System Speed Dialing .....	221
4.3.82	Trunk Answer From Any Station (TAFAS) .....	222
4.3.83	Two-Way Recording into Voice Mail [PT only] .....	223
4.3.84	Voice Mail Integration .....	225
4.3.85	Voice Mail Transfer [PT only] .....	228
4.3.86	Walking COS .....	229
<b>4.4</b>	<b>Operator / Manager Service Features .....</b>	<b>231</b>
4.4.1	Operator / Manager Service Features .....	231
4.4.2	Background Music (BGM) — External .....	232
4.4.3	Call Log, Incoming in the Common Area — CLEAR ALL .....	233
4.4.4	Call Log Lock Control, Incoming in the Personal Area — CANCEL .....	234
4.4.5	Call Log Lock, Incoming in the Common Area .....	235
4.4.6	Live Call Screening Password Control .....	237
4.4.7	Outgoing Message (OGM) .....	238
4.4.8	Remote Station Lock Control .....	241
4.4.9	System Working Report .....	242
4.4.10	The 301st Call Log, Incoming in the Common Area Treatment .....	243
4.4.11	Timed Reminder, Remote (Wake-Up Call) .....	245
<b>5</b>	<b>DSS Console Features</b>	
<b>5.1</b>	<b>Configuration .....</b>	<b>248</b>
5.1.1	Configuration .....	248
5.1.2	Location of Controls .....	249
5.1.3	Feature Buttons .....	250
<b>5.2</b>	<b>Station Programming .....</b>	<b>251</b>
5.2.1	Station Programming Instructions .....	251
5.2.2	Extension Number Assignment .....	253
5.2.3	One-Touch Dialing Assignment .....	254

---

---

5.2.4	One-Touch Access Assignment for System Features .....	255
<b>5.3</b>	<b>DSS Console Features .....</b>	<b>256</b>
5.3.1	Direct Station Dialing.....	256
5.3.2	One-Touch Dialing.....	257
5.3.3	One-Touch Access for System Features .....	258
5.3.4	Call Transfer.....	259
<b>6</b>	<b>Appendix .....</b>	<b>262</b>
<b>6.1</b>	<b>Appendix .....</b>	<b>262</b>
6.1.1	Display Examples.....	262
6.1.2	Feature Number List.....	268
6.1.3	Tone List .....	272
6.1.4	Troubleshooting .....	274
<b>7</b>	<b>Index .....</b>	<b>275</b>



# *Section 1*

## *PT Overview*

*Note: All illustrations used in the initial setting are based on model KX-T7130 / KX-T7135.*

# 1.1 Configuration

## 1.1.1 Configuration

Panasonic Proprietary Telephones (PTs) are available to utilize various features of KX-TA1232 System, in addition to supporting basic telephone services (making and receiving calls). There are six PT models.

	<b>KX-T7020</b>	<b>KX-T7030</b>	<b>KX-T7130</b>	<b>KX-T7135</b>	<b>KX-T7050</b>	<b>KX-T7055</b>
Display	None	16 char./line, 1-line LCD	16 char./line, 1-line LCD	16 char./line, 1-line, backlit LCD	None	None
Speakerphone	Yes	Yes	Yes	Yes	Monitor only	Monitor only
CO Buttons	12	12	12	12	12	3
Programmable Feature Buttons	4	4	12	12	4	3
Fixed Feature Buttons	Refer to the "Fixed Buttons" in 1.1.3 Feature Buttons					

## 1.1.2 Location of Controls

### ■ KX-T7020

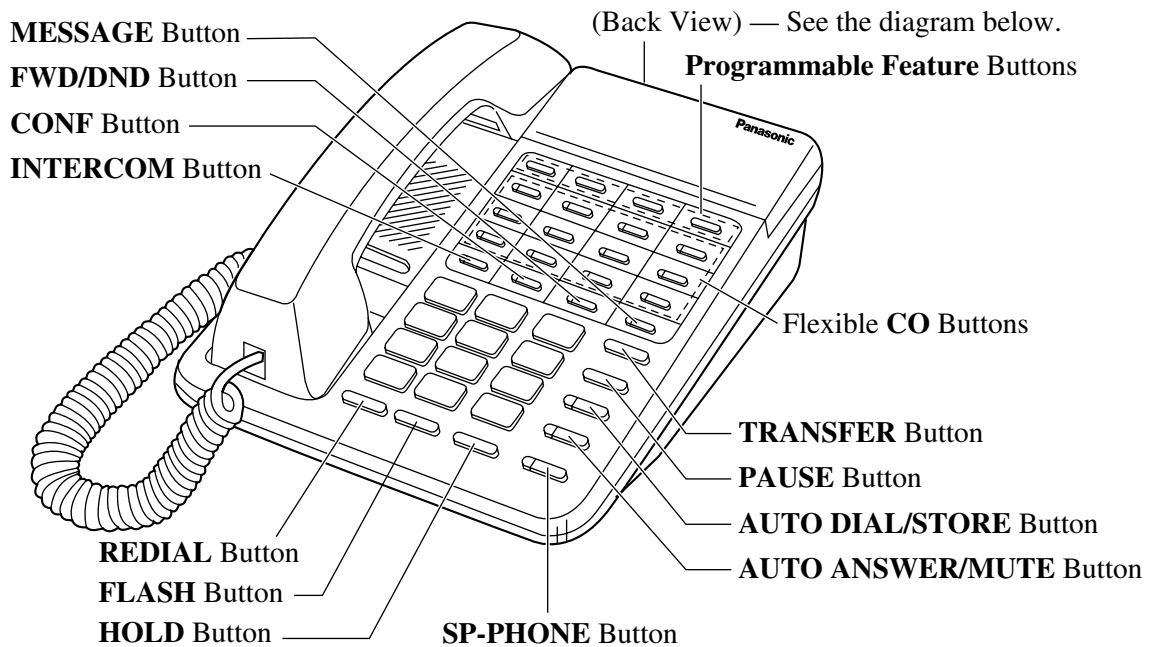

#### <Side View>

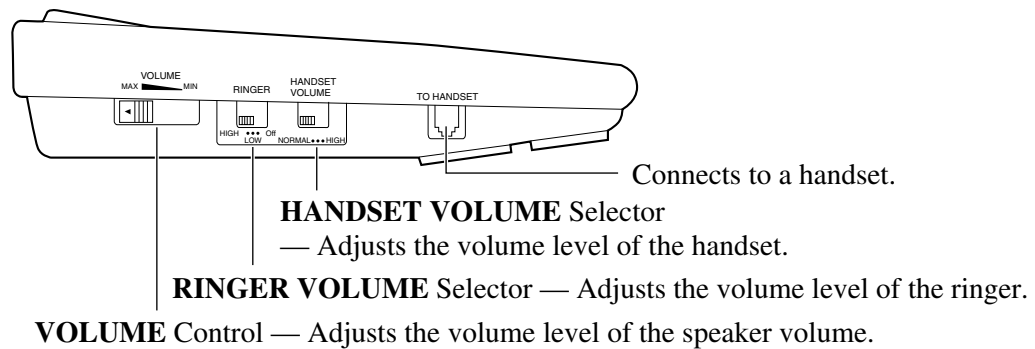

#### <Back View>

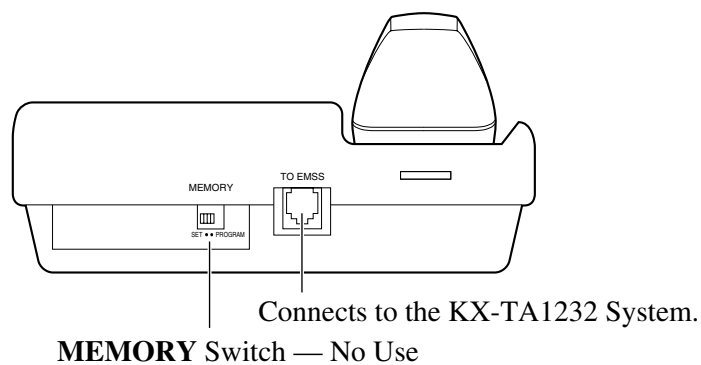

■ **KX-T7030**

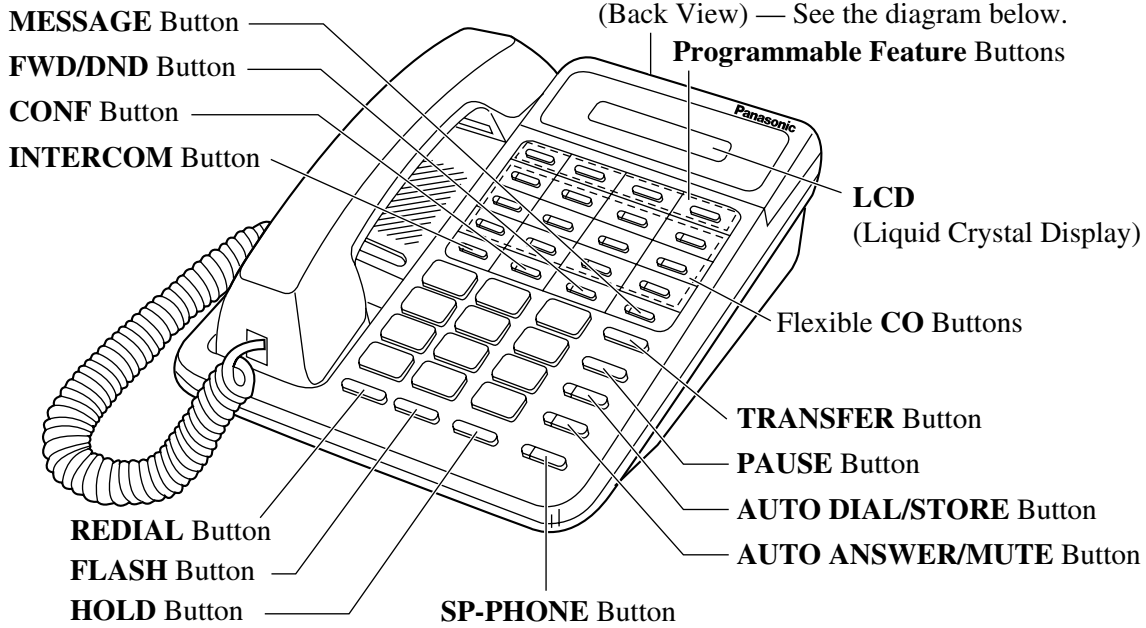

<Side View>

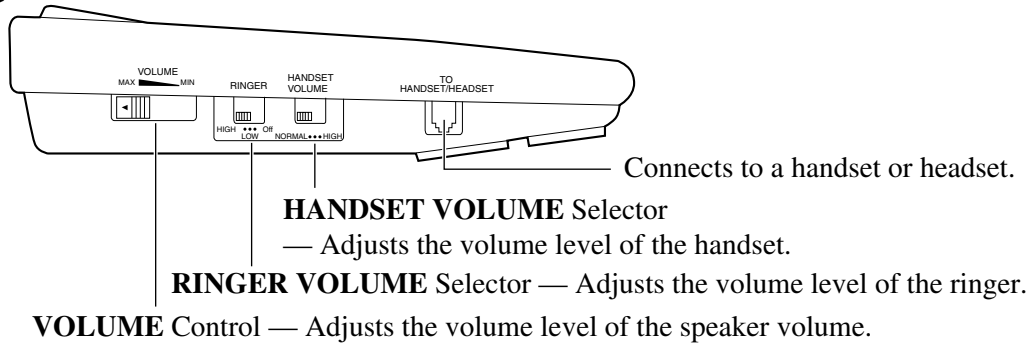

<Back View>

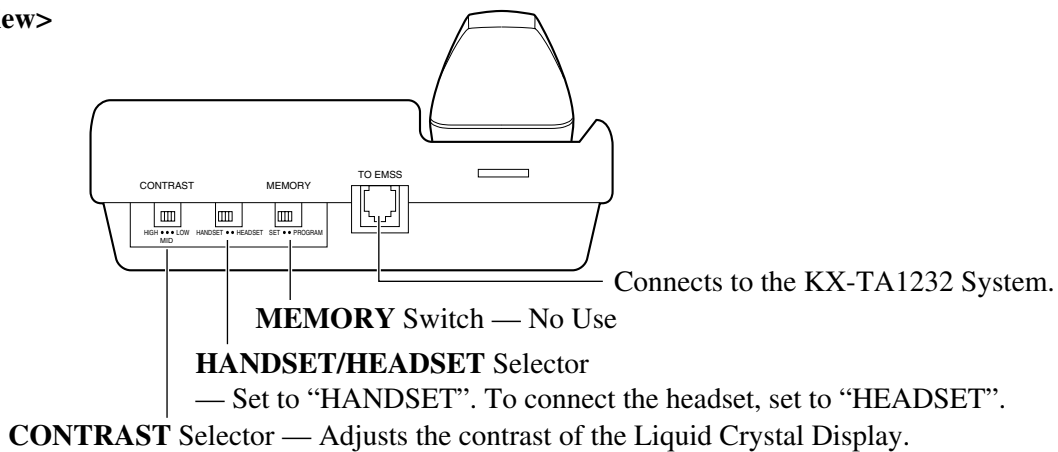



■ **KX-T7130 / KX-T7135**

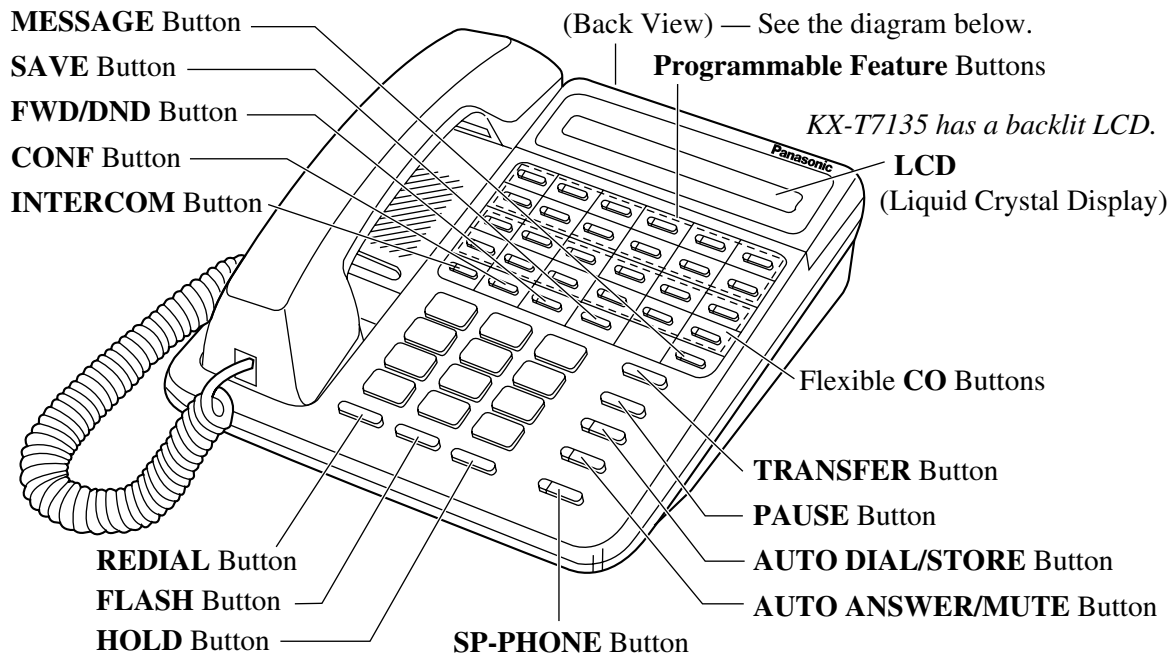

<Side View>

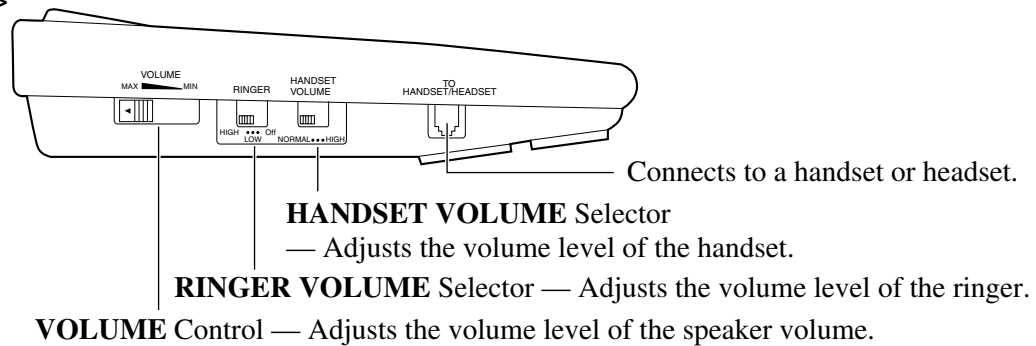

<Back View>

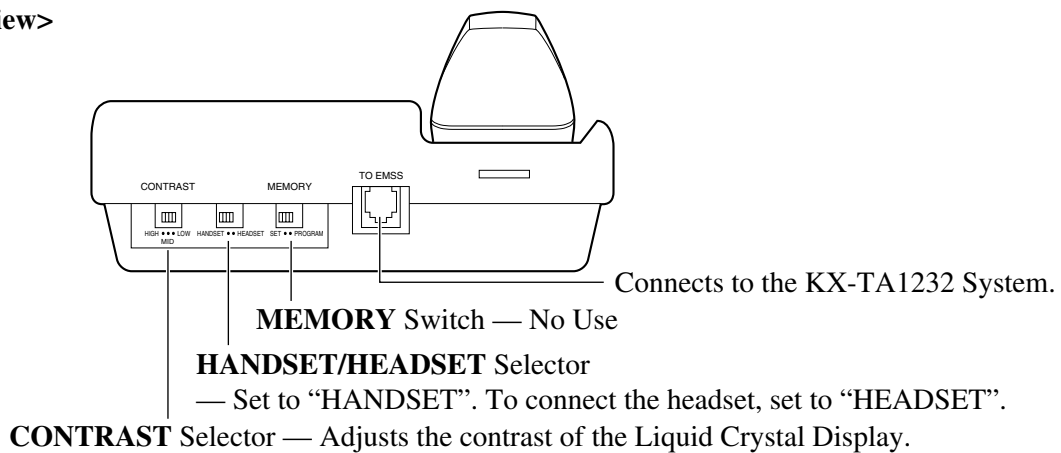

■ **KX-T7050**

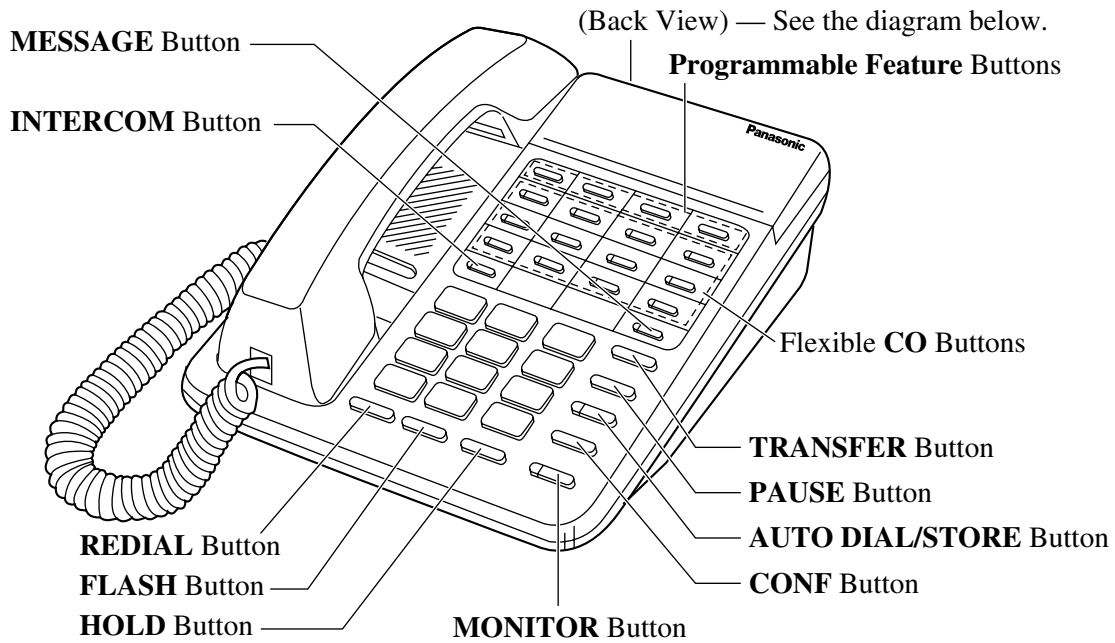

<Side View>

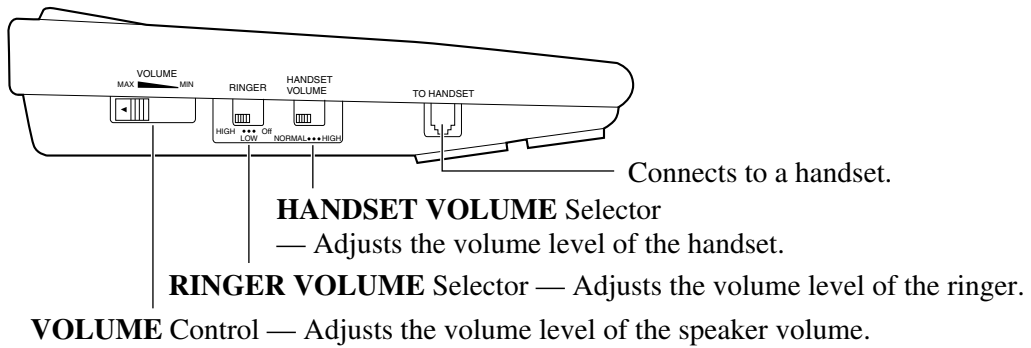

<Back View>

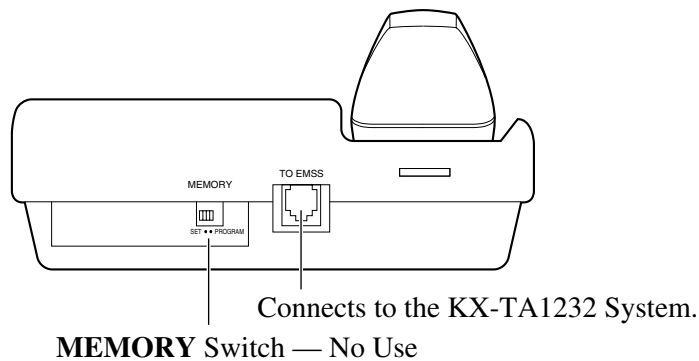

■ **KX-T7055**

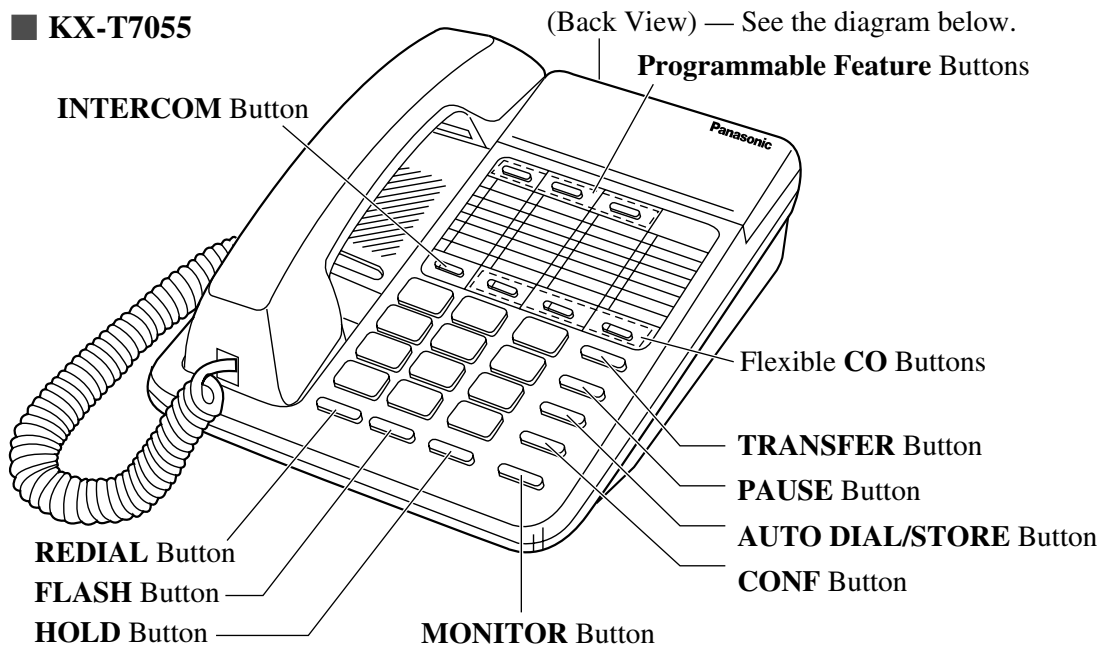

<Side View>

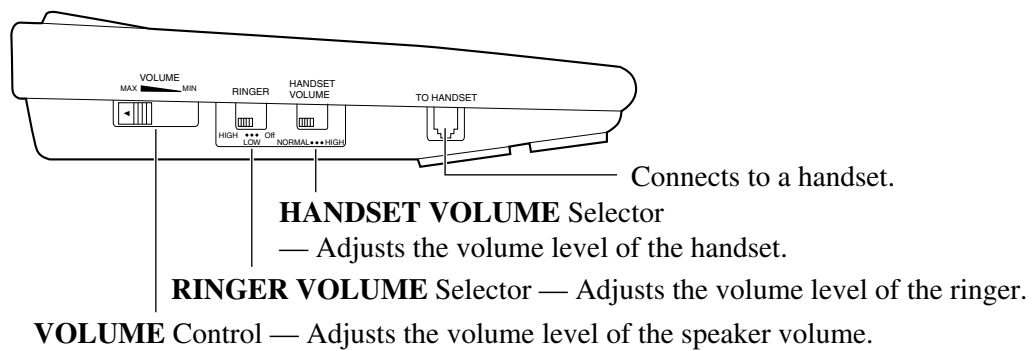

<Back View>

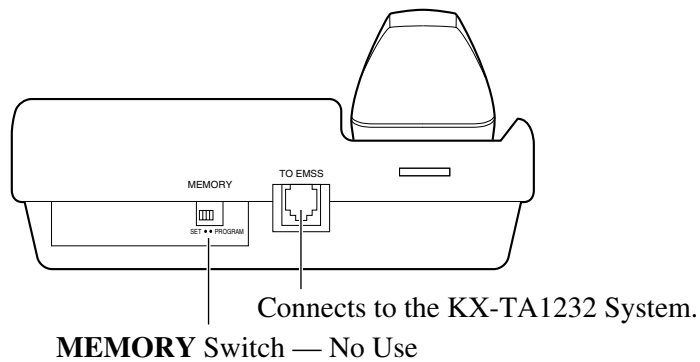

## 1.1.3 Feature Buttons

Proprietary telephones (PTs) have the following types of Feature Buttons:

- Fixed Buttons
- Flexible Buttons
- Programmable Feature Buttons

### Fixed Buttons

Fixed buttons have specific functions permanently assigned to them. These default function assignments cannot be changed. The following table lists the fixed buttons located on each PT model.

Feature Button	T7020	T7030	T7130	T7135	T7050	T7055
AUTO ANSWER/MUTE	✓	✓	✓	✓		
AUTO DIAL/STORE	✓	✓	✓	✓	✓	✓*
CONF	✓	✓	✓	✓	✓	✓
FLASH	✓	✓	✓	✓	✓	✓
FWD/DND	✓	✓	✓	✓		
HOLD	✓	✓	✓	✓	✓	✓
INTERCOM	✓	✓	✓	✓	✓	✓
MESSAGE	✓	✓	✓	✓	✓	
MONITOR					✓	✓*
PAUSE	✓	✓	✓	✓	✓	✓
REDIAL	✓	✓	✓	✓	✓	✓
SAVE			✓	✓		
SP-PHONE	✓	✓	✓	✓		
TRANSFER	✓	✓	✓	✓	✓	✓

" ✓ " indicates the button is available.

\* The button is not provided with an LED (Light Emitting Diode).

## Usage

**AUTO ANSWER/MUTE Button**

Used for Hands-free answer back; or it turns the microphone off during a conversation.

**AUTO DIAL/STORE Button**

Used for System Speed Dialing or storing program changes.

**CONF (Conference) Button**

Used to establish a three-party conference.

**FLASH Button**

Sends an External Feature Access signal to the central office or host PBX to access their system features. If a PBX is not being used, this button can be used to disconnect the current call and start another call without hanging up.

**FWD/DND (Call Forwarding/Do Not Disturb) Button**

Used to program the Call Forwarding feature or set the Do Not Disturb (DND) feature.

**HOLD Button**

Used to place a call on hold.

**INTERCOM Button**

Used to make or receive extension calls.

**MESSAGE Button**

Used to leave a notification to a busy extension or call back the message notification sender.

**MONITOR Button**

Used for a hands-free dialing operation.

**PAUSE Button**

Inserts a pause in speed dial numbers or in other numbers.

**REDIAL Button**

Used for the Last Number Redial.

**SAVE Button**

Used for Saved Number Redialing.

**SP-PHONE (Speakerphone) Button**

Used for a hands-free speakerphone operation.

**TRANSFER Button**

Transfers a call to another extension or external destination.

## Flexible Buttons

Flexible Buttons do not have specific features permanently assigned to them. Features are assigned to Flexible Buttons through System or Station Programming. "Flexible Button Assignment" is addressed in "Station Programming". The three types of Flexible Buttons are as follows:

- **Flexible CO buttons** (located on PT only)
- **Flexible DSS buttons** (located on DSS Console only)
- **Programmable Feature (PF) buttons** (located on PT and DSS Console)

The following table outlines the features that can be assigned to the Flexible Buttons:

Button	CO	DSS	PF
<b>Features to be assigned</b>			
Single-CO	✓		
Group-CO	✓		
Loop-CO	✓		
Caller ID Indication — Personal	✓		
Caller ID Selection — Personal	✓		
Caller ID Indication — Common	✓		
Caller ID Selection — Common	✓		
DSS (Direct Station Selection)	✓	✓	
Phantom Extension	✓	✓	
ONE-TOUCH (One-Touch Dialing)	✓	✓	✓
MESSAGE (Message Waiting)	✓	✓	
MESSAGE (Another/Phantom Extension)	✓		
FWD/DND (Call Forwarding/Do Not Disturb)	✓	✓	✓
SAVE (Saved Number Redial)	✓	✓	✓
ACCOUNT (Account Code Entry)	✓	✓	✓
CONF (Conference)	✓	✓	✓
Voice Mail (VM) Transfer	✓	✓	✓
Log-In/Log-Out	✓		
Two-Way Record*	✓	✓	

<b>Features to be assigned</b>	<b>Button</b>	<b>CO</b>	<b>DSS</b>	<b>PF</b>
Two-Way Transfer*		✓	✓	
LCS (Live Call Screening)*		✓	✓	
LCS (Live Call Screening) Cancel*		✓	✓	
Night/Day (Lunch/Break) Service		✓	✓	

" ✓ " indicates that the feature is available.

- \* Available when the Advanced Hybrid System is connected to a Proprietary Telephone capable Panasonic Voice Processing System (one that supports DPT Integration; e.g., KX-TVS50).

### Line Access Buttons

The following three types of CO buttons can be used to seize an outside line when making a call.

- **Single-CO (S-CO) button**
- **Group-CO (G-CO) button**
- **Loop-CO (L-CO) button**

### Conditions

- A flexible CO button can be assigned as a Line Access Button (S-CO, G-CO or L-CO) in either System/Station Programming. Once a flexible CO button is assigned as a Line Access Button, it provides the line status condition by lighting patterns and green/red indication. Please refer to "LED Indication" in this section.
- You can set the G-CO and L-CO buttons on one telephone. Incoming and outgoing calls on the line are shown on the button in the following priority.  
S-CO > G-CO > L-CO

### Single-CO (S-CO) button

An S-CO button is a outside line access button. This allows you to access a specific outside line by pressing an S-CO button. An incoming outside call can be directed to an S-CO button.

### Conditions

- The same outside line cannot be assigned to more than one S-CO button on a PT.
- It is possible to assign the same outside line to an S-CO button, a G-CO button and an L-CO button respectively.

## User Manual References

2.2.2 Flexible Button Assignment

4.3.60 Outward Dialing, Line Access — SUMMARY

### Group-CO (G-CO) button

To support efficient utilization of outside lines, a group of outside lines (outside line group) can be assigned to a CO button. This button is referred to as Group-CO (G-CO) button. Any incoming calls from any outside line in the same trunk group arrive at the G-CO button. To make an outside call, you can access an idle outside line in the trunk group by simply pressing the assigned G-CO button.

### Conditions

- It is possible to assign the same outside line to an S-CO button, a G-CO button, and an L-CO button.
- It is necessary to program the extension for making and/or receiving calls in outside line groups.
- When your extension is assigned as an incoming call destination for an outside line, you cannot receive any incoming outside calls unless a G-CO, L-CO or S-CO button associated with the outside line is assigned.

## User Manual References

2.2.2 Flexible Button Assignment

4.3.60 Outward Dialing, Line Access — SUMMARY

### Loop-CO (L-CO) button

All outside lines can be assigned to a flexible CO button on a proprietary telephone. The assigned button serves as an L-CO button. An incoming call on any outside line arrives at the L-CO button, unless there are S-CO or G-CO buttons associated with the line or unless the button is already in use. To make a outside call, you simply press the dedicated L-CO button. Pressing the L-CO button provides the same operation as dialing an automatic line access code.

## User Manual References

2.2.2 Flexible Button Assignment

4.3.60 Outward Dialing, Line Access — SUMMARY



## 1.1.4 Initial Settings

### Display Contrast Adjustment (KX-T7030, KX-T7130 and KX-T7135 only)

The CONTRAST selector is used to adjust the display contrast.

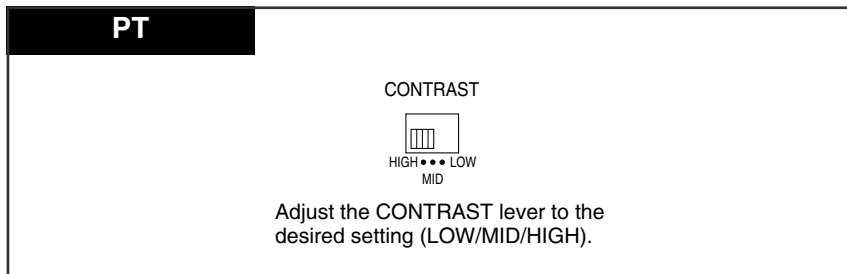

### When using the headset (KX-T7030, KX-T7130 and KX-T7135 only)

The Panasonic Advanced Hybrid System supports the use of a headset on a proprietary telephone (PT). When you use the headset (optional), you should switch the selection mode first.

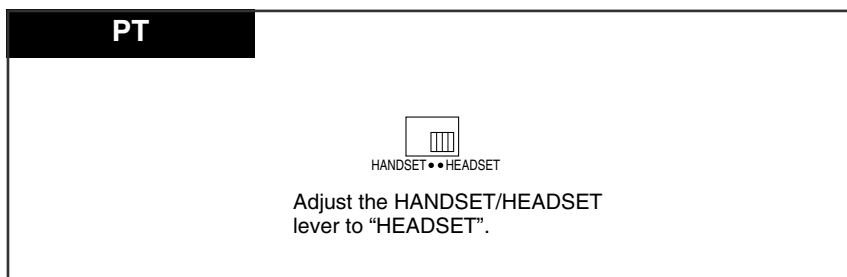

### Volume Control — Handset Receiver/Headset/Ringer/Speaker

Allows you to adjust the following volumes as required.

- Handset Receiver volume
- Headset volume
- Ringer volume
- Speaker volume

#### To adjust the handset receiver volume

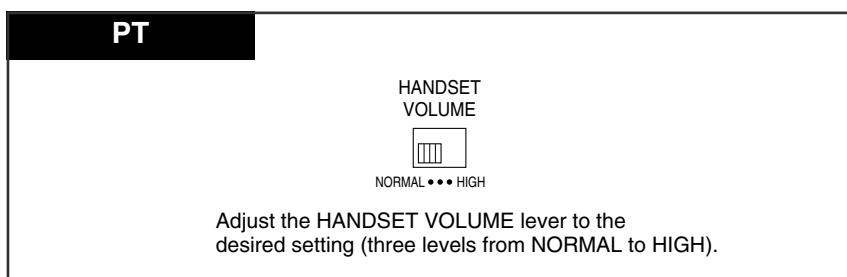

- You may also adjust the handset receiver volume during a conversation using the handset receiver.

**To adjust the headset volume**

**PT**

*Be sure the headset is connected.*

HANDSET  
VOLUME



NORMAL ••• HIGH

Adjust the HANDSET VOLUME lever to the desired setting (three levels from NORMAL to HIGH).

**To adjust the ringer volume**

**PT**

RINGER

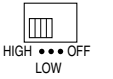

HIGH ••• OFF  
LOW

Adjust the RINGER Volume lever to the desired setting (OFF/LOW/HIGH).

**To adjust the speaker volume**

**PT**

VOLUME

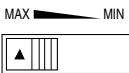

MAX      MIN

Adjust the VOLUME Control lever to the desired setting (MAX to MIN).

## 1.1.5 LED Indication

The Light Emitting Diode (LED) buttons indicate the line conditions with lighting patterns.

### Flashing light patterns

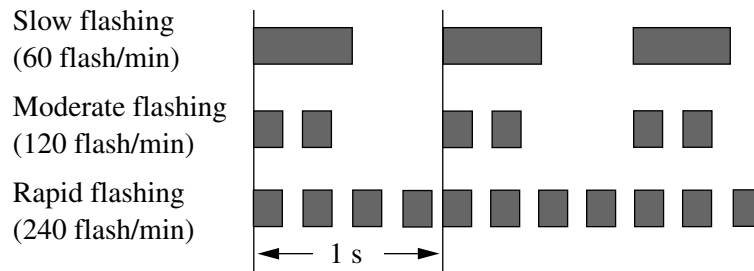

### LED Indication on the INTERCOM Button

The table below shows the lighting patterns for intercom line conditions.

INTERCOM button	Intercom Line Condition
Off	Idle
Green On	Intercom call / Conference established
Green slow flashing	Intercom call hold
Green moderate flashing	Intercom call exclusive hold / Consultation hold
Green rapid flashing	Incoming intercom/doorphone call

### LED Indication on the CO Button

The table below shows the lighting patterns for outside line conditions.

CO Button	Outside Line Condition
Off	Idle
Green On	You are using the line.
Green slow flashing	You have a held call.
Green moderate flashing	You have one of the following: (1) Exclusive hold, (2) Outside-to-Outside line call, or (3) Conference, Unattended
Green rapid flashing	Privacy Release possible* / Hold Recall / Incoming call
Red On	Other-use / Log-out
Red slow flashing	Other-hold*

— Items marked with "\*" are only available on the Single-CO button.

---

**BLF on DSS Button**

The Busy Lamp Field (BLF) indicator button is red when the corresponding extension is busy. This is available for Direct Station Selection (DSS) buttons on a DSS console and for flexible CO buttons assigned as DSS buttons on proprietary telephones.

**LED Indication on the FWD/DND Button**

The table below shows the lighting patterns for the FWD/DND Button.

<b>System Programming [990] Area (09), Bit (4,3)</b>	<b>When Call Forwarding (FWD) is set</b>	<b>When Do Not Disturb (DND) is set</b>
11 (default)	Red Slow Flashing	Red On
10	Red On	Red On
01	Red On	Red Slow Flashing
00	Red Slow Flashing	Red Slow Flashing

**Programming Guide Reference**

[990] System Additional Information

# *Section 2*

## *Station Programming*

*Note: All illustrations used in this section are based on model KX-T7130 / KX-T7135.*

## 2.1 Station Programming Instructions

### 2.1.1 Station Programming Instructions

Station Programming allows you, the proprietary telephone (PT) users, to program certain features from your telephone individually. To program, you need to switch your telephone to the Station Programming mode. During programming mode, your telephone is in the busy condition to both inside and outside callers. If you want to make a normal call handling operation, you must finish the programming mode.

#### Programming Mode Display

When you enter into the Station Programming mode, the display shows the following message as the initial programming mode;

PT-PGM Mode

We recommend a PT with display for Station Programming to avoid mis-operation. The display also gives you helpful or stored data information related to your programming steps. In this section, we note the display example in the programming steps, if required. You can also refer to the "Display Examples" in the Appendix (Section 6).

#### Entering Station Programming mode

**PT**

*Be sure that the telephone is idle and on-hook.*

PAUSE

9 9

9

9

Press **PAUSE**.                      Dial 99.

- The STORE indicator lights.
- If 99 is not dialed within 5 seconds after the PAUSE button is pressed, the Station Programming mode is canceled.

**<PT Display Example>**

PT-PGM Mode

— Initial programming display

- If there is no entry within one minute, the Station Programming mode is canceled and normal call handling mode resumes automatically.

## Exiting Station Programming mode

**PT**

When the display shows the initial programming mode;

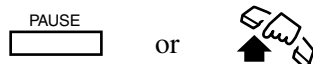

Press **PAUSE** or lift the handset.

- To exit the Station Programming mode, press PAUSE. You are in the call handling mode.

## Confirming the assigned function data

— Be sure that you are in the Station Programming mode: Press [PAUSE] [9] [9].

**PT**

**program access number**

Enter the program access number.

**HOLD**

Press **HOLD (END)**.

- The display shows the initial programming mode.

- Enter the **program access number\*** as follows.
  - 1:Preferred Line Assignment — Outgoing
  - 2:Preferred Line Assignment — Incoming
  - 3:Full One-Touch Dialing Assignment
  - 4:Intercom Alert Assignment
  - 5:Call Waiting Tone Type Assignment
  - 6:Self-Extension Number Confirmation
  - 7:Live Call Screening Mode Set<sup>†</sup>
  - 81:Initial Display Selection
  - 01:Remote Station Look Control (— Operator / Manager only)
  - 02:Call Log Lock Control, Incoming (— Operator / Manager only)
  - 03:Live Call Screening Password Control<sup>†</sup> (— Operator / Manager only)
  - #:Station Programming Data Default Set

- The display shows the programmed data.

### <PT Display Example>

When you press [5], the display shows:

C.W. Tone1 (— The Call Waiting tone is currently programmed to Tone 1.)

\* A **programming access number** is required to program/confirm the function data by Station Programming.

<sup>†</sup> : Available when the Advanced Hybrid System is connected to a Proprietary Telephone capable Panasonic Voice Processing System (one that supports DPT Integration; e.g., KX-TVSS50)

— To exit the Station Programming mode: Press [PAUSE] or lift the handset.

— If you wish to change the data, follow the programming procedure explained in this section.

### Confirming the assigned data on the Flexible button

— Be sure that you are in the Station Programming mode: Press [PAUSE] [9] [9].

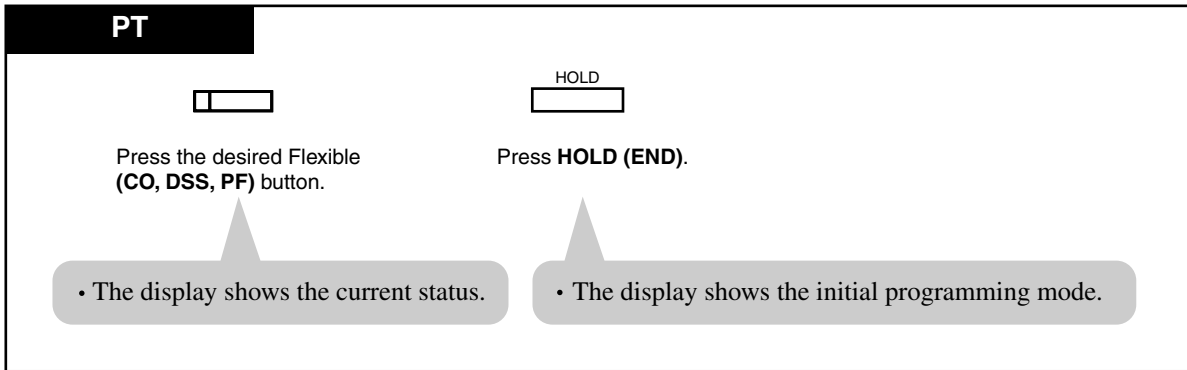

— To exit Station Programming mode: Press [PAUSE] or lift the handset.

— If you wish to change the data, follow the programming procedure explained in this section.

### Clearing the data on the Flexible button

— Be sure that you are in the Station Programming mode: Press [PAUSE] [9] [9].

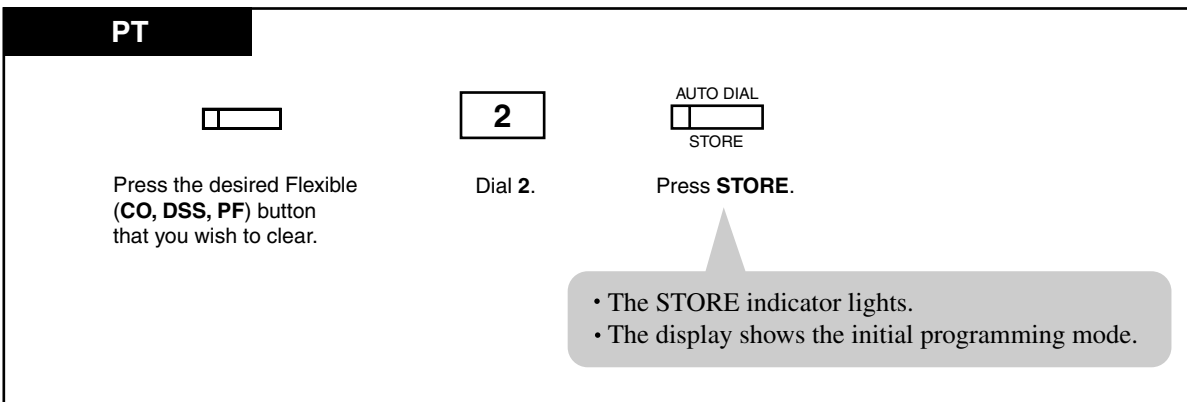

— To exit Station Programming mode: Press [PAUSE] or lift the handset.

— The lists on the following pages are the buttons and programming access numbers used for Station Programming. Detailed operating instructions are explained on each page in this section.



## Station Programming [Flexible Button Assignment]

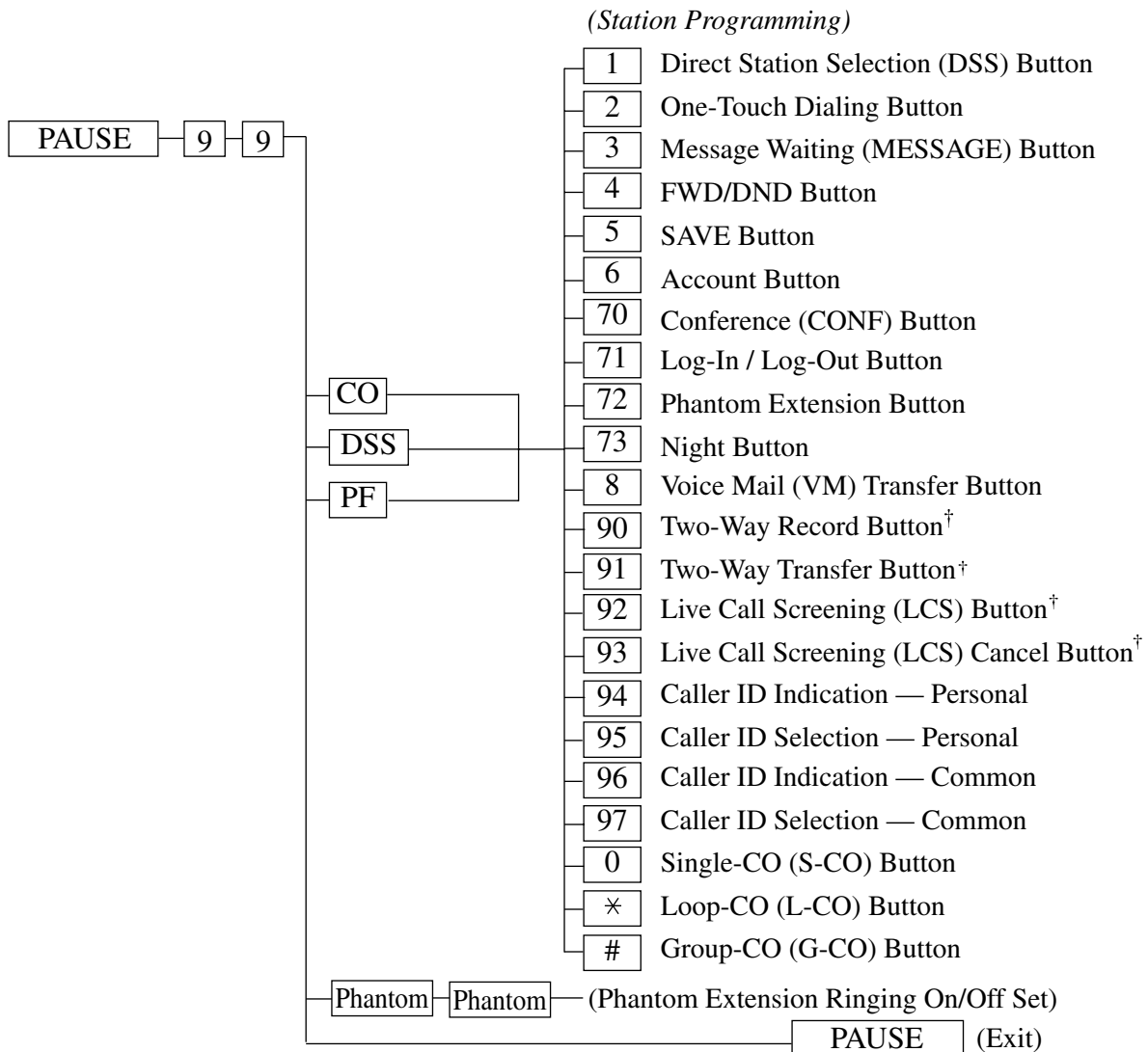

<sup>†</sup>: Available when the Advanced Hybrid System is connected to a Proprietary Telephone capable Panasonic Voice Processing System (one that supports DPT Integration; e.g., KX-TVS50).

### Note

For details about the flexible buttons assignment, refer to 2.2.2 Flexible Button Assignment.

**Station Programming [Function Assignment]**

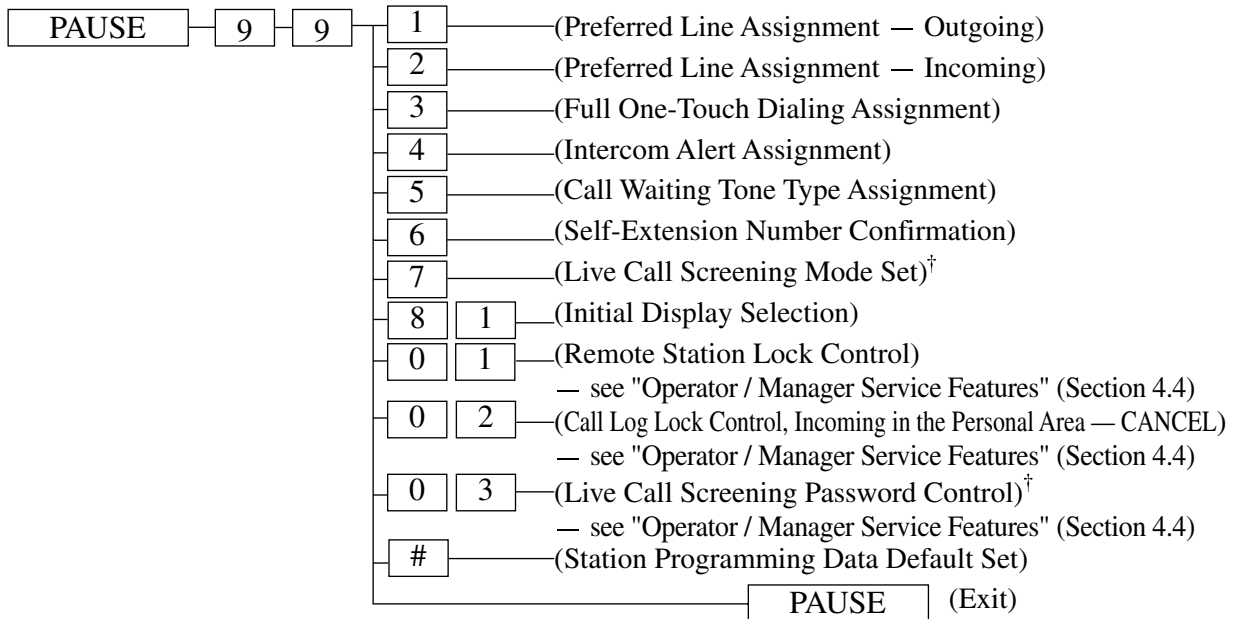

<sup>†</sup>: Available when the Advanced Hybrid System is connected to a Proprietary Telephone capable Panasonic Voice Processing System (one that supports DPT Integration; e.g., KX-TV550).

**Note**

For details about the function assignment, refer to 2.2 Station Programming.

## 2.2 Station Programming

### 2.2.1 Initial Settings

The original setting are shown in bold letters in the shaded boxes. Find and mark your desired selections for programming.

— Be sure that you are in the Station Programming mode : Press [PAUSE] [9] [9].

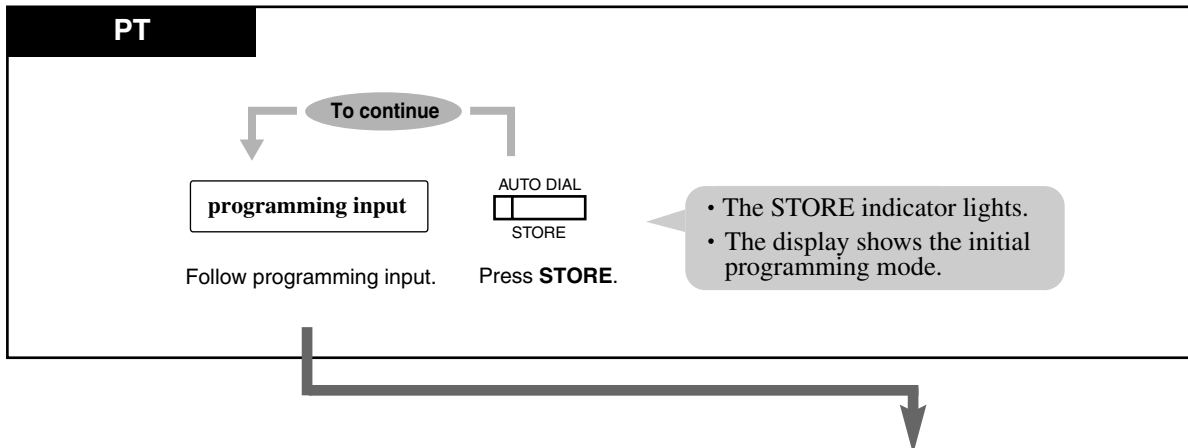

Item	Selection	Programming Input
<b>Preferred Line Assignment – Outgoing</b> Which line do you prefer to seize when you go off-hook to make calls?	<input type="checkbox"/> No line	<input type="text" value="1"/> <input type="text" value="1"/>
	<input type="checkbox"/> An idle outside line	<input type="text" value="1"/> <input type="text" value="2"/>
	<input type="checkbox"/> A pre-assigned outside line	<input type="text" value="1"/> <input type="text" value="3"/> <b>Outside line no.</b> (01-12)
	<input type="checkbox"/> <b>The Intercom line</b>	<input type="text" value="1"/> <input type="text" value="INTERCOM"/>

Item	Selection	Programming Input
<b>Preferred Line Assignment – Incoming</b> Which line do you prefer to seize when you go off-hook to receive calls?	<input type="checkbox"/> No line	<input type="text" value="2"/> <input type="text" value="1"/>
	<input type="checkbox"/> A ringing line	<input type="text" value="2"/> <input type="text" value="2"/>
	<input type="checkbox"/> A pre-assigned outside line	<input type="text" value="2"/> <input type="text" value="3"/> <b>Outside line no.</b> (01-12)
<b>Full One-Touch Dialing Assignment</b> Which way do you prefer to dial the One-Touch Dialing feature?	<input type="checkbox"/> Going Off-hook and then pressing the One-Touch Dialing button.	<input type="text" value="3"/> <input type="text" value="1"/>
	<input type="checkbox"/> Pressing the One-Touch Dialing button.	<input type="text" value="3"/> <input type="text" value="2"/>
<b>Intercom Alert Assignment</b> Which way do you prefer to receive an intercom call?	<input type="checkbox"/> Ringing	<input type="text" value="4"/> <input type="text" value="1"/>
	<input type="checkbox"/> Directly – the party's voice is heard without ringing.	<input type="text" value="4"/> <input type="text" value="2"/>
<b>Call Waiting Tone Type Assignment</b> Do you prefer to distinguish the Call Waiting tone from an outside line and an intercom call?	<input type="checkbox"/> No. Use the same tone. (Call Waiting Tone 1)	<input type="text" value="5"/> <input type="text" value="1"/>
	<input type="checkbox"/> Yes. Use a different tone. (Call Waiting Tone 2)	<input type="text" value="5"/> <input type="text" value="2"/>
<b>Live Call Screening Mode Set</b> Which voice mail service do you prefer when a caller is recording a message in your mailbox?	<input type="checkbox"/> You can monitor the message through the telephone speaker. (Hands-free mode)	<input type="text" value="7"/> <input type="text" value="1"/>
	<input type="checkbox"/> Only an alert tone is heard. (Private mode)	<input type="text" value="7"/> <input type="text" value="2"/>
<b>Initial Display Selection</b> Which display do you prefer when a call is received?	<input type="checkbox"/> Caller ID	<input type="text" value="8"/> <input type="text" value="1"/> <input type="text" value="1"/>
	<input type="checkbox"/> Outside line name	<input type="text" value="8"/> <input type="text" value="1"/> <input type="text" value="2"/>

— To exit the Station Programming mode: Press [PAUSE] or lift the handset.

## 2.2.2 Flexible Button Assignment

— Be sure that you are in the Station Programming mode: Press [PAUSE] [9] [9].

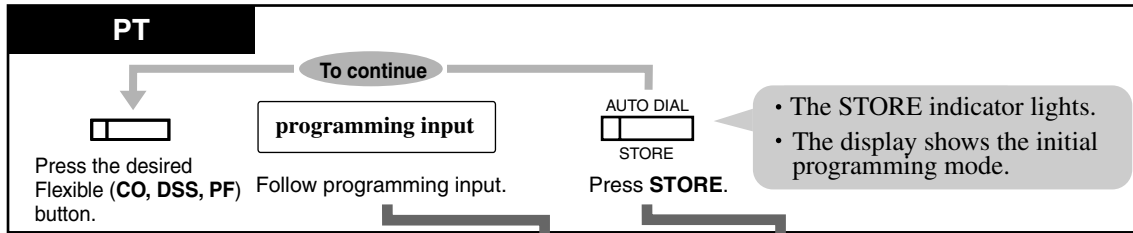

Button	Programmable Button			Programming Input	
	CO	DSS	PF		
Direct Station Selection (DSS)	✓	✓		[ 1 ]	Extension no.
One-Touch Dialing	✓	✓	✓	[ 2 ]	Desired no.* <sup>1</sup> (max. 16 digits)
MESSAGE (Own Extension)	✓	✓		[ 3 ]	
FWD/DND (Forward/Do Not Disturb)	✓	✓	✓	[ 4 ]	
SAVE	✓	✓	✓	[ 5 ]	
Account	✓	✓	✓	[ 6 ]	
CONF (Conference)	✓	✓	✓	[ 7 ] [ 0 ]	
Log-In/Log-Out	✓			[ 7 ] [ 1 ]	
Phantom Extension	✓	✓		[ 7 ] [ 2 ]	Phantom extension no.
Night/Day (Lunch/Break)	✓	✓		[ 7 ] [ 3 ]	
Voice Mail Transfer * <sup>2</sup>	✓	✓	✓	[ 8 ]	Voice mail extension no.
Two-Way Record * <sup>2</sup>	✓	✓		[ 9 ] [ 0 ]	Voice mail extension no.
Two-Way Transfer * <sup>2</sup>	✓	✓		[ 9 ] [ 1 ]	Voice mail extension no.
Live Call Screening * <sup>2</sup>	✓	✓		[ 9 ] [ 2 ]	
Live Call Screening Cancel * <sup>2</sup>	✓	✓		[ 9 ] [ 3 ]	
Caller ID Indication — Personal	✓			[ 9 ] [ 4 ]	
Caller ID Selection — Personal	✓			[ 9 ] [ 5 ]	
Caller ID Indication — Common	✓			[ 9 ] [ 6 ]	
Caller ID Selection — Common	✓			[ 9 ] [ 7 ]	
Single-CO	✓			[ 0 ]	Outside line no. (01-12)
Loop-CO	✓			[ * ]	
Group-CO	✓			[ # ]	Outside line group no. (1-8)

— To exit the Station Programming mode: Press [PAUSE] or lift the handset.

### Conditions

- \*1 "×", "#", FLASH, PAUSE, SECRET (INTERCOM) and — (CONF) can also be stored.
  - If you do not want to display the stored number, press the SECRET (INTERCOM) button before and after the numbers you wish to conceal.
  - If you store an external party's number, you should first store a line access number (9, 81 to 88).
  - If you need to enter an account code, you can enter the specified account code before the line access number.

<Example>

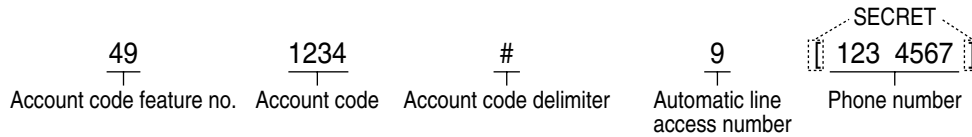

- \*2 This button is used for the voice mail integration feature.
- To exit the mode at any time, lift the handset.

## 2.2.3 Phantom Extension Ringing On/Off Set

Allows you to assign a ringing On/Off function on a Phantom button (default: On).

— Be sure that you are in the Station Programming mode: Press [PAUSE] [9] [9].

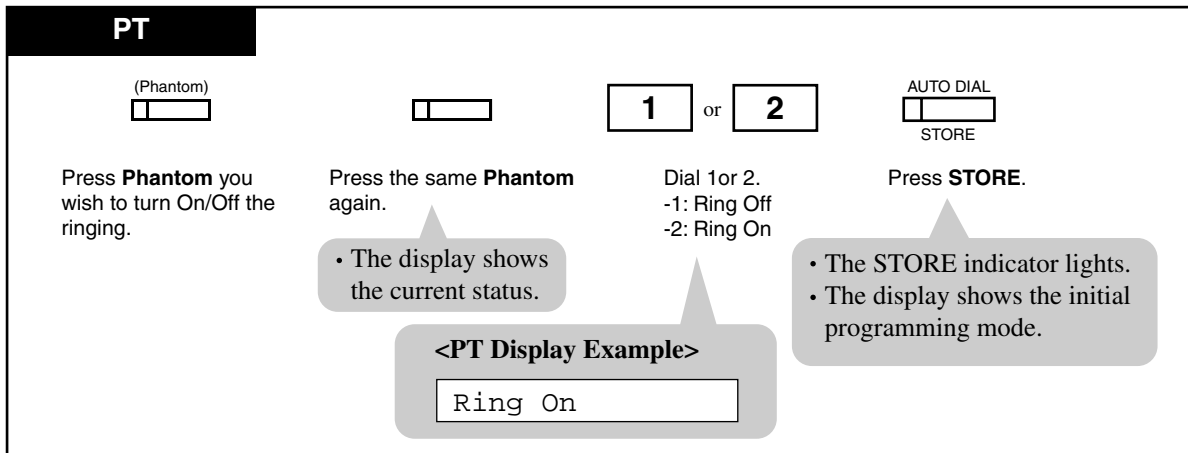

— To exit the Station Programming mode: Press [PAUSE] or lift the handset.

## 2.2.4 Self-Extension Number Confirmation (KX-T7030, KX-T7130 and KX-T7135 only)

Allows you to display your extension port physical number and extension number.

— Be sure that you are in the Station Programming mode: Press [PAUSE] [9] [9].

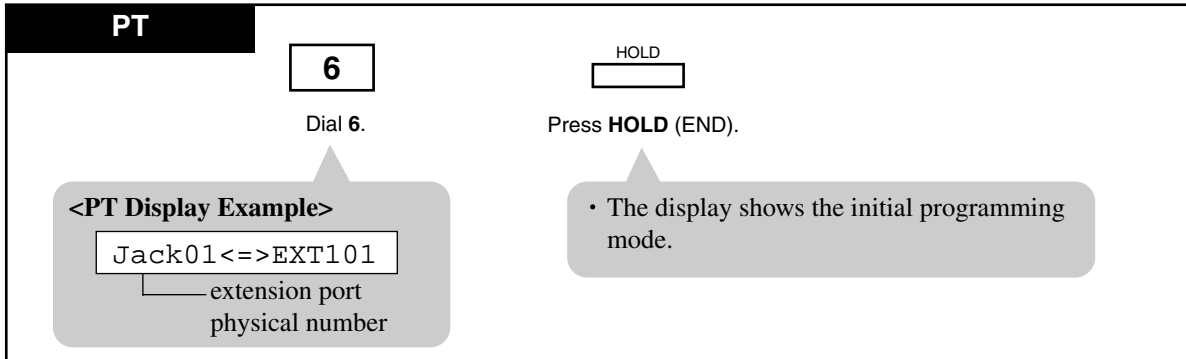

— To exit the Station Programming mode: Press [PAUSE] or lift the handset.



## 2.2.5 Station Programming Data Default Set

Allows you to return each of the following items assigned by Station Programming to their default settings.

- a) Call Waiting Tone Type Assignment (default: Tone 1)
- b) Full One-Touch Dialing Assignment (default: on)
- c) Initial Display Selection (default: Caller ID)
- d) Intercom Alert Assignment (default: Ring Call)
- e) Live Call Screen Mode Set (default: Hands-free)
- f) Preferred Line Preference — Incoming (default: Ringing Line)
- g) Preferred Line Preference — Outgoing (default: INTERCOM Line)

— Be sure that you are in the Station Programming mode: Press [PAUSE] [9] [9].

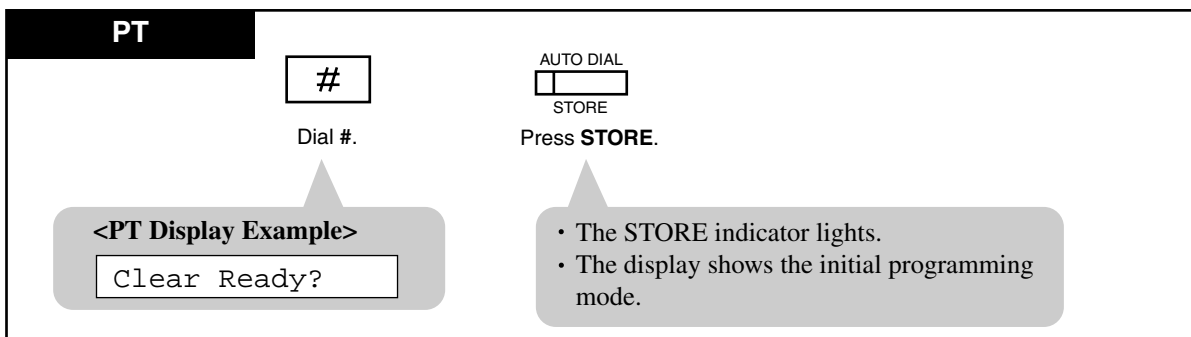

— To exit the Station Programming mode: Press [PAUSE] or lift the handset.



# *Section 3*

## *User Programming*

## 3.1 User Programming Instructions

### 3.1.1 General Programming Instructions

User Programming allows you, any extension user who knows the User Programming Password, to program the following system features from your telephone individually.

- [000] Date and Time Set
- [001] System Speed Dialing Number Set
- [003] Extension Number Set
- [004] Extension Name Set
- [005] Flexible CO Button Assignment
- [006] Operator / Manager Extension Assignment
- [007] DSS Console Port and Paired Telephone Assignment
- [008] Absent Messages
- [009] Quick Dial Number Set
- [014] VM Name Set
- [017] DISA User Codes

To program, you need to switch your telephone to the User Programming mode. During the programming mode, your telephone is in a busy condition for outside callers. If you want to make a normal call operation, you must finish the programming mode.

#### Default Setting

This system has default factory settings. Any required changes can be written in the "Programming Tables".

#### Required Telephone Set

One of the following Proprietary Telephone (PT) sets with display is required for User Programming:

- Proprietary Telephone (PTs): KX-T7135, KX-T7130, KX-T7030.

#### Using the Overlay

A programming overlay is packed with the telephone at the factory. This overlay should be used at all times in the programming mode since the functions of the telephone keys change during programming.

During Normal Operation	During Programming
(PAUSE)	PAUSE
(SP-PHONE)	NEXT
(REDIAL)	PREV (PREVIOUS)

During Normal Operation	During Programming
(AUTO ANSWER / MUTE)	SELECT
(FLASH)	FLASH
(TRANSFER)	CLEAR
(FWD/DND)	➡
(CONF)	- / ⬅
(INTERCOM)	SECRET
(AUTO DIAL / STORE)	STORE
(HOLD)	END

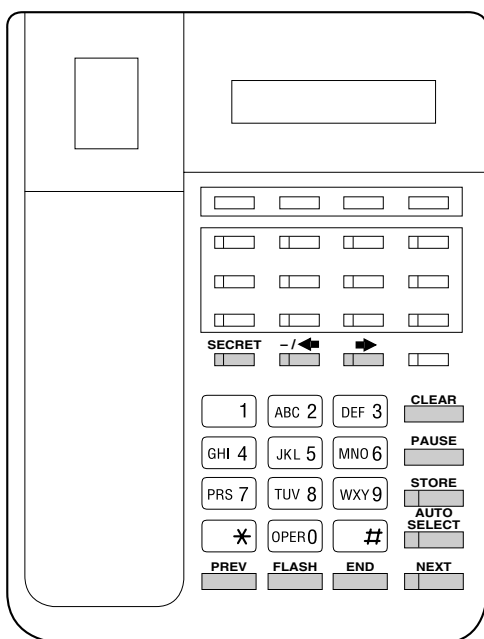
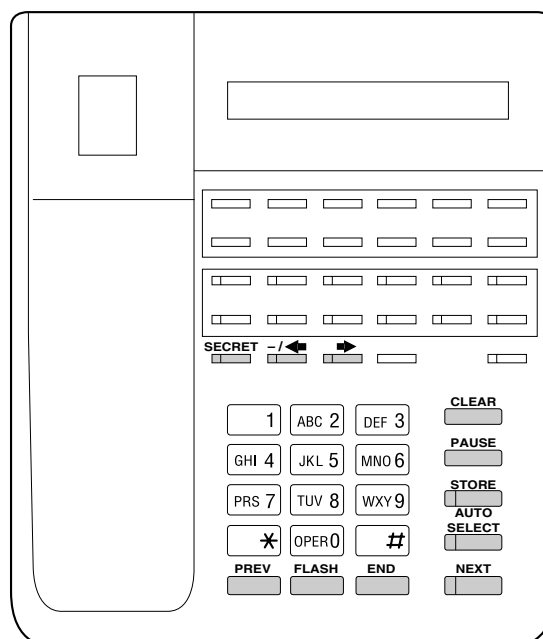
**KX-T7030****KX-T7130/KX-T7135**

### Before entering the user programming mode

Before entering the user programming mode, confirm that:

- Your telephone is on-hook, and
- No calls are on hold at your telephone.

### Entering the user programming mode

To enter the User Programming mode:

Press **PAUSE + \* + \* + User Programming Password (default:1234)**

- The display shows the Initial Message: USR-PGM NO? →

**Note**

- If nothing is entered within five seconds after the PAUSE button is pressed, programming mode is canceled.
- During the programming mode, your extension is treated as a busy extension.
- Only one proprietary telephone can be in programming mode at any one time.
- The User Programming Password is not shown on the display for security reason. The password can be changed by System Programming.

**Programming Guide References**

[120] User Password

In this section, programs [001] through [004] and [017] are explained. Please consult with your dealer when you need to change the following programs:

- [005] Flexible CO Button Assignment
- [006] Operator / Manager Extension Assignment
- [007] DSS Console Port and Paired Telephone Assignment
- [008] Absent Messages
- [009] Quick Dial Number Set
- [014] VM Name Set

---

## 3.1.2 Programming Methods

### Advancing to the next stage

When "USR-PGM NO?→" is displayed, you can select one of the following:

- To go to program [000], press the **NEXT** button.
- To go to another program, enter the 3-digit program address.

### Storing your data

Press **STORE** to store your data.

- The **STORE** indicator lights red and a confirmation tone sounds.

\* **Confirmation tone (one beep)**

After pressing **STORE**, you will hear a beep. This informs you that storage has been completed successfully.

\* **Confirmation tone (two beeps)**

This informs you that the parameter has already been stored.

\* **Alarm tone (three beeps)**

If you hear this alarm, your entry is not valid.

### Making another selection within the same program address

- To go to the next selection, press **NEXT**.
- To go to the previous selection, press **PREV**.
- To make a specific selection, press **SELECT** and then enter the number.

### Accessing another program address

a) While displaying the program address and title:

- To go to the next **Larger program address**:  
Press the **➡** or **MESSAGE** button.
- To go to the next **Smaller program address**:  
Press the **⬅** or **SECRET (INTERCOM)** button.

b) While programming:

- To go to a specific program address:  
Press **END**, then enter the program address.

### Returning to the operation mode

1. Lift the handset while in programming mode.
2. When the Initial Message: USR-PGM NO?→ is displayed, press the **PAUSE** button.  
(To display the Initial Message, press **END**.)

## Entering Characters

Each character can be entered by using the dial key pad or various buttons for storing names.

**Combination Table** shows the combination of the keys and the number of times to press the SELECT (AUTO ANSWER/MUTE) button to enter each character. (The AUTO ANSWER/MUTE button becomes the SELECT button when using the overlay.)

To enter a character, find the key and number of times to press the SELECT button from the table. Press the corresponding key first, then press the SELECT button the required number of times.

**Combination Table**

Pressing SELECT (Times)	0	1	2	3	4	5	6	7	8
Keys									
1	1	Q	q	Z	z	!	?		
2	2	A	a	B	b	C	c		
3	3	D	d	E	e	F	f		
4	4	G	g	H	h	I	i		
5	5	J	j	K	k	L	l		
6	6	M	m	N	n	O	o		
7	7	P	p	Q	q	R	r	S	s
8	8	T	t	U	u	V	v		
9	9	W	w	X	x	Y	y	Z	z
0	0		.	,	'	:	;		
*	*	/	+	-	=	<	>		
#	#	\$	%	&	@	(	)		

<Example>

See Combination Table.

- 1) Press 6 and then press the SELECT button once to enter "M".
- 2) Press 4 and then press the SELECT button six times to enter "i".
- 3) Press 5 and then press the SELECT button four times to enter "k".
- 4) Press 3 and then press the SELECT button four times to enter "e".

### Note

- To erase the last word (to backspace), press the CONF button.  
(The CONF button becomes the "←" (backspace) key when using the overlay.)



## 3.2 User Programming

### 3.2.1 [000] Date and Time Set

#### Notice

It is assumed that you have read Section 3.1 "User Programming Instructions".

#### **Description**

Sets the current date and time.

#### **Selection**

- Year: **00 through 99**
- Month: **Jan. through Dec.**
- Day: **1 through 31**
- Day of the week: **SUN / MON / TUE / WED / THU / FRI / SAT**
- Hour: **1 through 12**
- Minute: **00 through 59**
- **AM / PM**
- Hour format: **12 or 24**

#### **Default**

'01 Jan. 1 MON 12:00 AM 12

## Programming

Display PT

<Date Setting>

0

0

0

Dial 000.

NEXT

Press NEXT.

year

Enter the **year**  
(last 2 digits).

→

Press →.

<PT Display>

000 DATE / TIME

<PT Display Example>

'01 Jan. 1 MON

- To change the current entry, press CLEAR and enter the new year.

SELECT

Keep pressing **SELECT** until the desired month is displayed.

→

Press →.

day

Enter the **day**  
(1 through 31).

→

Press →.

SELECT

Keep pressing **SELECT** until the desired day of the week is displayed.

- To change the current entry, press CLEAR and enter the new day.

<Time Setting>

STORE

Press **STORE**.

NEXT

Press **NEXT**.

hour

Enter the **hour**  
(1 through 12).

→

Press →.

minute

Enter the **minute**  
(00 through 59).

<PT Display Example>

12:00 AM 12

- To change the current entry, press CLEAR and enter the new hour.

- To change the current entry, press CLEAR and enter the new minute.

→

Press →.

SELECT

Press **SELECT** for AM or PM.

→

Press →.

SELECT

Press **SELECT** for 12 or 24 (hour format).

STORE

Press **STORE**.

END

Press **END**.

**Conditions**

- After changing an entry, you can press **STORE**. You do not have to perform the rest of the steps.
- To return to the previous field, press **◀** in steps 4 through 9 and steps 13 through 18.
- If you hear an alarm after pressing **STORE**, check that the date is valid.
- The clock starts immediately after the **STORE** button is pressed.
- You cannot leave an entry empty.

**Features Guide References**

Display, in Idle

## 3.2.2 [001] System Speed Dialing Number Set

### Description

Used to program the System Speed Dialing numbers. These numbers are available for any extension user in the system.

### Selection

- Speed dial numbers: **000 through 499**
- Telephone number: **24 digits (max.)**

### Default

All speed dial numbers — Not Stored

## Programming

Display PT

0

0

1

Dial **001**.

<PT Display>

001 SYS SPD DIAL

NEXT

Press **NEXT**.

<PT Display>

SPD Code?→

speed dial no.

Enter a **speed dial number**  
(000 through 499).

• To enter speed dial number 000,  
you can also press NEXT.

<PT Display Example>

000:Not Stored

Repeat these steps

telephone no.

Enter a **telephone number**.

- To delete the current entry, press **CLEAR**.
- To change the current entry, press **CLEAR** and enter the new number.

STORE

Press **STORE**.

<To continue:> [When SELECT is pressed]

NEXT

PREV

SELECT

Press **NEXT** or  
**PREV** or **SELECT**.

speed dial no.

Enter the desired **speed dial number**  
(000 through 499).

<To end:>

END

Press **END**.

### Conditions

- Each speed dial number has a maximum of 24 digits. The valid characters are **0 through 9, \*, and # keys, and the FLASH, PAUSE, SECRET and "-" (hyphen) buttons.**
  - To store the flash signal, press **FLASH**.

Note: The Stored flash will only be effective during an established call.

  - To store a hyphen, press the "-" button.
  - To store a pause, press **PAUSE**.

(Refer to Pulse to Tone Conversion in the Features Guide)

- To store a feature number to convert pulse signals to DTMF (Dual Tone Multi-Frequency) signals, press the \* and # keys. (Refer to Pulse to Tone Conversion in the Features Guide.)
- To prevent displaying of all or part of the number, press **SECRET** before and after the secret number, or your entry will not be stored. (Refer to Secret Dialing in the Features Guide.)
- If you are storing an external number, enter the line access code (default: 9, 81 through 88) before the number. When dialing, a pause is automatically inserted after the code.
- If you are storing an account code, enter the account code before the line access code. (Refer to Account Code Entry in the Features Guide)
- It is possible to store a number consisting of 25 digits or more by storing it in two speed dial numbers. The line access code should be stored in the first speed dial number.
- To access another speed dial number in step 3 through 6, press **SELECT** and start with step 3.
- To display parts of the number which have scrolled off the display, press **▶** or **◀**.

## User Manual References

### 4.3.77 System Speed Dialing

### 3.2.3 [003] Extension Number Set

#### Description

Assigns an extension number to each extension.

#### Selection

- Jack number: **01 through 32**
- Extension Number: **2 through 4 digits**

#### Default

Jack 01 through 32 = 101 through 132

## Programming

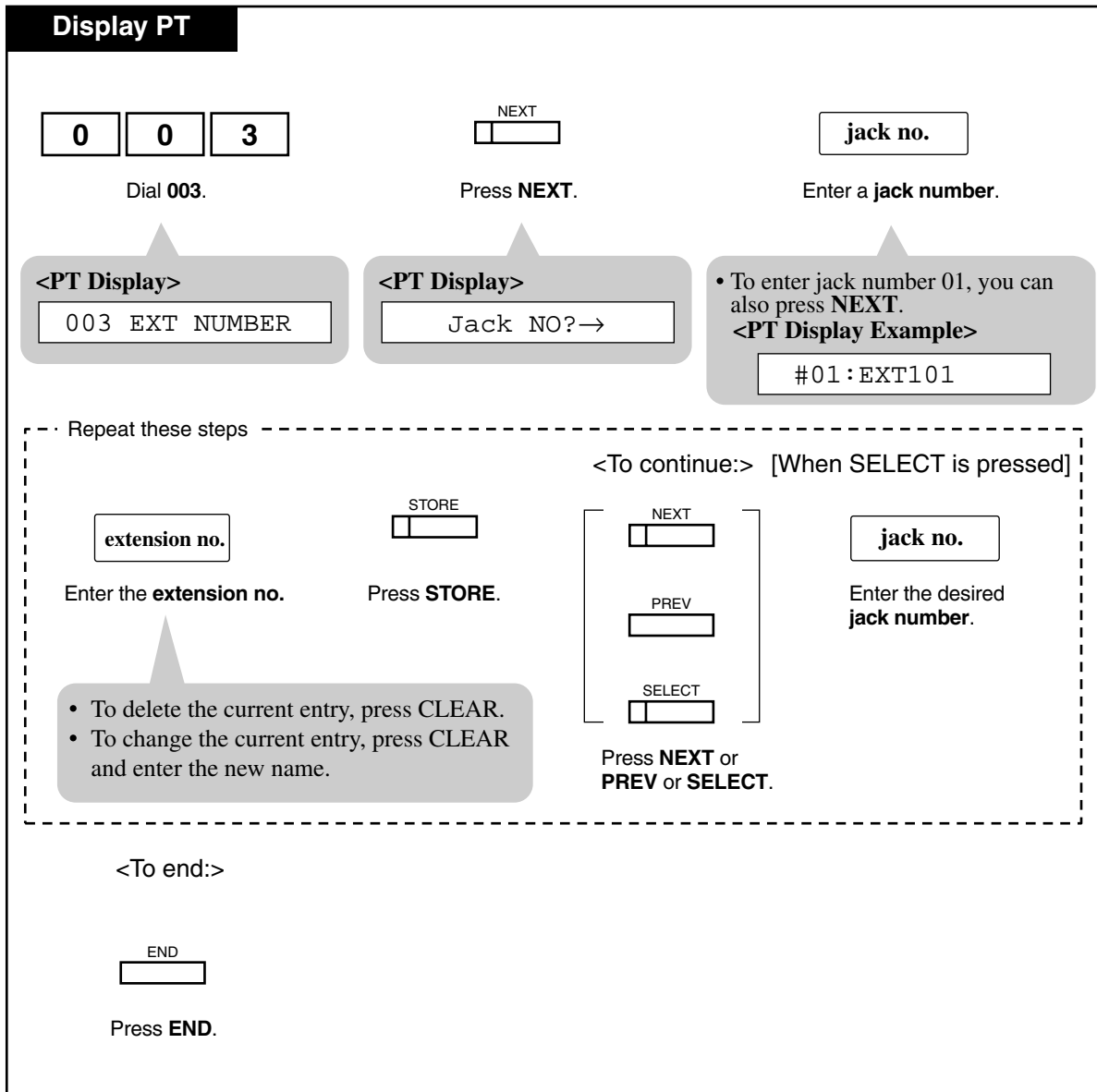

### Conditions

- There is a maximum of 32 extension numbers. Each extension number can be two, three, or four digits, consisting of **0 through 9**. The \* and # keys cannot be used.
- An extension number is invalid if the first or second digits do not match with the program [100] "Flexible Numbering, (01)-(16) 1st through 16th hundred extension blocks" setting. If one digit is assigned as the leading digit, some extensions have two digits and some have three digits. If two digits are assigned, some have three digits and some have four digits.
- A double entry or incompatible entry is invalid including the program [118] "Voice Mail Extension Number Assignment", [124] "Phantom Extension Number Assignment" and



[813] "Floating Number Assignment". Valid entry examples are: 10 and 11; 10 and 110.  
Invalid entry examples are: 10 and 106.

- Program [004] "Extension Name Set" is used to name the extension numbers.

## **User Manual References**

4.3.51 Intercom Calling

## 3.2.4 [004] Extension Name Set

### Description

Assigns names to the extension numbers programmed in program [003] Extension Number Set.

### Selection

- Jack number: **01 through 32**
- Name: **10 characters (max.)**

### Default

All extension ports — Not Stored

## Programming

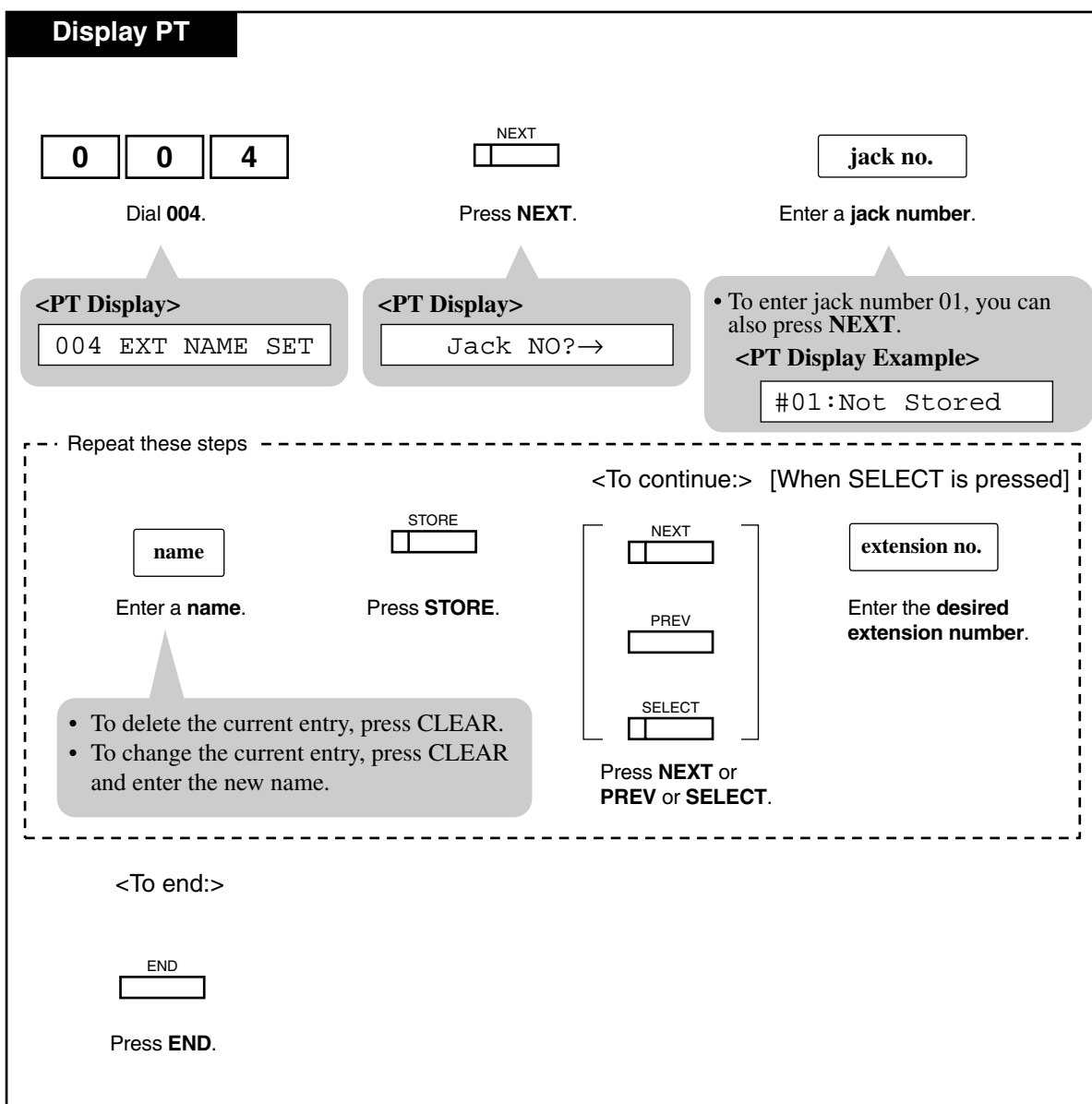

### Conditions

- There is a maximum of 32 names. Each name has a maximum of 10 characters.
- For entering characters, see "Entering Characters" in 3.1.2 Programming Methods.
- Program [003] Extension Number Set is used to assign extension numbers.

### User Manual References

4.3.51 Intercom Calling

## 3.2.5 [017] DISA User Codes

### Description

Assigns the Direct Inward System Access (DISA) User Codes and a Class of Service (COS) to each code. The code COS determines the toll restriction level of the DISA caller.

### **Warning**

When you enable the Outside-Outside Line Call feature of DISA function, if a third party discovers the password (a DISA User Code) of the system, you have a risk that they will make illegal phone calls using your telephone line, and the cost may be charged to your account.

In order to avoid this problem, we strongly recommend the following points:

- 1: Carefully maintain the secrecy of the password.
- 2: Specify a complicated password as long and random as you can make it.
- 3: Change the password frequently.

### Selection

- DISA user code number: **01 through 32**
- DISA user code: **4 through 10 digits**
- COS number: **1 through 8**

### Default

All DISA user code numbers - DISA user code=Blank; COS number=8

## Programming

Display PT

0

1

7

NEXT

DISA user code no.

Dial 017.                      Press NEXT.                      Enter a DISA user code number (01-32).

<PT Display>

017 USER CODES

<PT Display>

User Code NO?→

- To enter user code number 01, you can also press NEXT.

<PT Display Example>

01 :                      C : 8

Repeat these steps

DISA user code

→

COS no.

STORE

DISA user code no.

Enter a DISA user code (Blank or 4-10 digits).      Press →.      Enter COS number (1-8).      Press STORE.

- To delete the current entry, press CLEAR.
- To change the current entry, press CLEAR and enter the new name.

NEXT

PREV

SELECT

DISA user code no.

Press NEXT or PREV or SELECT.

<To continue:> [When SELECT is pressed]

<To end:>

END

Press END.

### Conditions

- This setting is required if Trunk (Outside line) Security mode is selected in program [809] DISA Security Type.
- Each code should be unique and composed of four through ten numerical digits, **0 through 9**.

### User Manual References

4.3.37 Direct Inward System Access (DISA)



# *Section 4*

## *Station Features and Operation (PT/SLT)*

## 4.1 Before Operating

### 4.1.1 Before Operating

#### What kind of telephone do you use?

In this manual, you will find your way to operate the feature depending on the telephone you use. Please use the proper operation for your telephone.

**If you use a Panasonic proprietary telephone** which has the special function button and/or the display, you will follow the operation with the button or display for easy access.

- If you use a Panasonic proprietary telephone which does not have the function button, you may change one of the unused buttons to another button. Refer to 2.2 Station Programming.
- A Panasonic proprietary telephone has the Light Emitting Diode (LED) button indicators, so you can see the line conditions by the lighting patterns.
- If "Idle Line Preference — Outgoing", "No Line Preference — Outgoing" or "Prime Line Preference (CO Line) — Outgoing" is assigned on the extension, it is **not** possible to have access to any PT features after simply going off-hook. To access PT features, press the INTERCOM button after going off-hook.

**If you use single line devices** such as a single line telephone or data terminal, you will follow the steps which enter the feature number.

- If you use a dial pulse (DP) type single line device which does not have the "\*" and "#" keys, it is impossible to access features that have "\*" or "#" in their feature numbers.
- When the "Pickup Dialing (Hot Line)" feature is set on your telephone, the dialing sequence should be done within a certain period of time (Pickup Dial Waiting Time — default: 1 s) after lifting the handset.  
This time can be changed by System Programming.

#### Note

- If your telephone is not noted in the operating step box (ex. only "PT" is noted), this means your telephone does not have the ability to execute that feature.
- If your telephone has the ability to perform several operations for one feature, you can select the method according to your needs.
- In this manual, the default feature numbers are used to describe each operation and illustration. Use the new programmed numbers if default feature numbers are changed by System Programming.
- For proprietary telephone operations, all button illustrations are based on the model KX-T7130.



## Description of Symbols Used

In this section, many symbols are used. Most symbols do not need a description, but some symbols do. They are as follows.



Lift the handset, or press the SP-PHONE or MONITOR button. (Off-hook)



Replace the handset, or press the SP-PHONE or MONITOR button. (On-hook)



Flash the hookswitch on a single line telephone.



Tones which vary depending on the condition (Refer to 6.1.3 Tone List).

## 4.2 Basic Operations

### 4.2.1 Making Calls

#### Intercom Calling

You can make a call to another extension.

Any Telephone



Lift the handset or press SP-PHONE/MONITOR.

extension no.

Dial **extension number**.

or

(DSS)

Press **DSS**.



Talk.



Hang up or press SP-PHONE/MONITOR.

- The INTERCOM indicator light turns green.

#### Outward Dialing

You can make a call to an outside party using one of the following line access methods.

- a) Line Access, Automatic (default: 9)
- b) Line Access, Individual (CO button)
- c) Line Access, Outside Line Group (default: 81 through 88)

PT and SLT



Lift the handset or press SP-PHONE/MONITOR.

(CO)

For PT

line access code

For SLT, PT



Dial tone

phone no.

Dial the **phone number**.



Talk.



Hang up or press SP-PHONE/MONITOR.

For PT: Press **CO** assigned as Loop-CO / Group-CO / Single-CO.  
For SLT, PT: Dial the **line access code** (9 or 81 through 88).

- The selected CO indicator light turns green.

- The display shows the phone number.

## Conditions

### <PT>

- There are four types of Line Preference for outgoing calls (— Idle Line/No Line/Prime Line/Prime INTERCOM Line). Each preference can be selected by Station or System Programming.
- With the KX-T7135, KX-T7130 or KX-T7030, you can execute the "Intercom Calling" feature to extensions by using the "Extension Dialing" display feature.
- Helpful hints for the Handsfree (speakerphone) operation are noted in the "Handsfree Operation" feature.

## User Manual References

- 2.2.1 Initial Settings
- 4.3.50 Hands-free Operation [PT only]
- 4.3.51 Intercom Calling
- 4.3.60 Outward Dialing, Line Access — SUMMARY

## 4.2.2 Receiving Calls

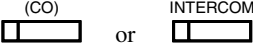
Any Telephone	PT
 <p>Lift the handset or press SP-PHONE.</p>	 <p>Press a rapid flashing <b>CO</b> or <b>INTERCOM</b>.</p> <ul style="list-style-type: none"><li>• The CO or INTERCOM indicator light turns steady green.</li></ul>

### Conditions

<PT>

- There are three types of Line Preference for incoming calls (— No Line/Prime Outside Line/Ringing Line). Each preference can be selected by Station Programming.
- Helpful hints for the Handsfree (speakerphone) operation are noted in the "Handsfree Operation" feature.

### Programming Guide References

[400] Outside Line Connection Assignment

[603-604] DIL 1:N Extension and Delayed Ringing — Day / Night

### User Manual References

2.2.1 Initial Settings

4.3.4 Answering, Direct Outside Line [PT only]

4.3.50 Hands-free Operation [PT only]

## 4.3 Station Features and Operation

### 4.3.1 Absent Message Capability

You can select one of nine pre-programmed Absent Messages (1-9) for your extension. The display PT users calling your extension see the message you select. Absent messages are used to inform the party calling to your extension of the reason for your absence. By default, Messages No. 1-6 are provided with default messages and the other three messages are left blank.

**Any Telephone**

Lift the handset or press SP-PHONE/MONITOR.      Dial **750**.      Dial **message number** (1 through 9)      Dial **parameters** if required      Confirmation tone and dial tone      Hang up or press SP-PHONE/MONITOR.

DISPLAY MESSAGE	MESSAGE NO.	PARAMETER
Will Return Soon	<b>1</b>	None
Gone Home	<b>2</b>	None
At Ext %%%	<b>3</b>	<b>extension no.</b> Dial extension number.
Back at %%:%%(time)	<b>4</b>	<b>hour</b> <b>minute</b> Enter hour (00 through 23) and minute (00 through 59).
Out Until %%/%% (month/day)	<b>5</b>	<b>month</b> <b>day</b> Enter month (01 through 12) and day (01 through 31).
In a Meeting	<b>6</b>	None
(Programmable)	<b>7</b>	
(Programmable)	<b>8</b>	
(Programmable)	<b>9</b>	

**Note**

Enter the desired value in the "%" space. You must make an entry in all of the %s using 0 through 9, "#" or "\*".

## Canceling the absent message

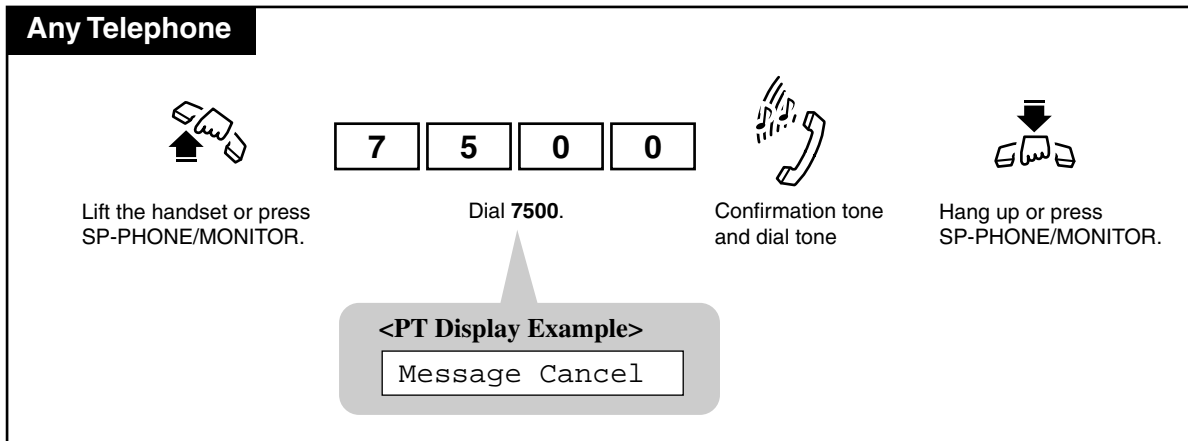

### Conditions

- All nine messages can be programmed either by User or System Programming.

#### <display PT>

- The message you select is shown on the display of your PT whenever you go off-hook.
- Regarding Message 3;
  - a) If the extension number you want to enter has more than the number of "%" characters, refer to System Programming to change the setting.
  - b) If the extension number you want to enter has less than the number of "%" characters, fill the remaining "%" characters with "#" or "\*".
- With the KX-T7135, KX-T7130 or KX-T7030, you can execute this feature using the display operation.

### Programming Guide References

[008] Absent Messages

## 4.3.2 Account Code Entry

An Account Code is used to identify outside calls for accounting and billing purposes. The account code is appended to the "Station Message Detail Recording (SMDR)" call record. For incoming outside calls, account code are not required. For outgoing outside calls, you may be required to enter an account code.

Your Account Code Entry mode is set to one of the following three modes by System Programming.

### In "Verified - All Calls" mode

- You must always enter a system-registered account code to make an outside call.

### In "Verified - Toll Restriction Override" mode

- You can override the Toll Restriction imposed on your extension by entering a system-registered account code before making an outside call (Toll Restriction Override by Account Code Entry).

### In "Option" mode

- You may enter any account code.

One mode is selected for each extension on a "Class of Service"<sup>1</sup> basis.

### Entering account codes before dialing

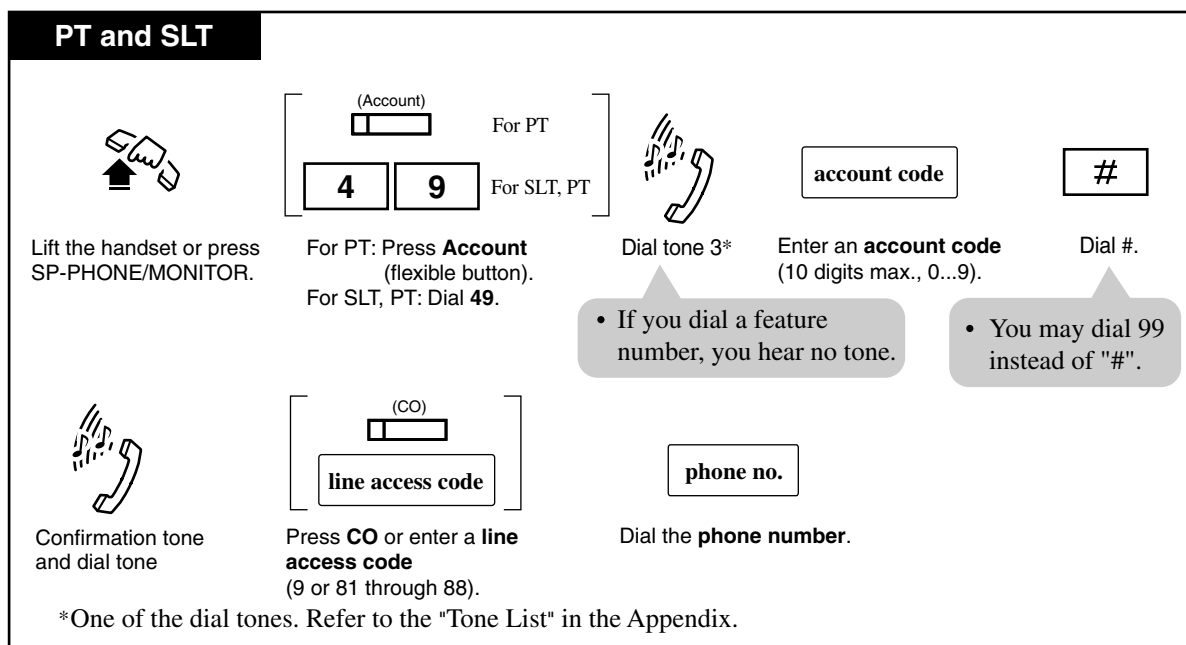

<sup>1</sup> Class of Service (COS) is used to define the features which are allowed for a group of extensions. For more details, please consult with your dealer.



### Entering account codes during or after a conversation

During a conversation or within 15 seconds after the other party hangs up;

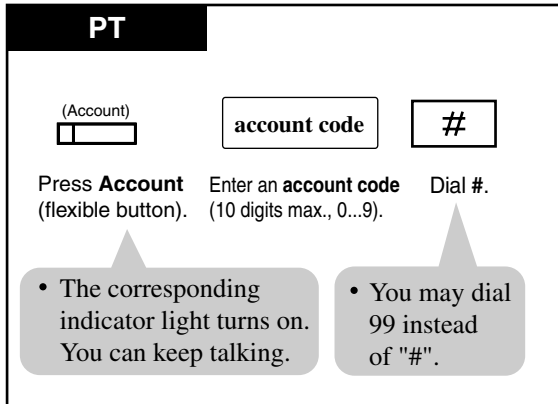

### Conditions

- In Verified - All Calls mode, you must always enter a pre-assigned account code when making any of the following calls.
  - a) Call Forwarding — to Outside Line
  - b) Manual Dialing (Selecting an outside line)
  - c) One-Touch Dialing
  - d) Personal Speed Dialing
  - e) Pickup Dialing (Hot Line)
  - f) System Speed Dialing

If the user uses Last Number Redial or Saved Number Redial, he/she does not have to re-enter the Account Code.

- In Option mode, it is possible to record a calling or called party's account code in the SMDR, during a conversation or within fifteen seconds after the other party hangs up.
- There is no need for an account code entry when receiving incoming calls.
- To clear and re-enter the account code, press "\*".
- An account code can be up to 10 numeric digits (0 through 9). FLASH, PAUSE, etc. are not allowed. After entering an account code, the delimiter "#" or "99" must be entered.
- **Memory Dialing**  
An account code can be stored into Memory Dialing ("One-Touch Dialing", "System / Personal Speed Dialing" ). The sequence to enter an account code into Memory Dialing is:  
— [Feature Number] [Account Code] [#] [Line Access Code] [Phone Number]  
or  
— [Feature Number] [Account Code] [99] [Line Access Code] [Phone Number]

**<PT>**

- Pressing the Account button (flexible button) while entering an account code cancels the entry.
- If an entered account code does not match the pre-assigned account code, in the verified-all calls mode or the verified-toll restriction override mode;
  - a) When making an outside call, a reorder tone is returned.
  - b) During a conversation, the code entry is accepted and the call is maintained (= Option mode).
  - c) After a CPC signal\*<sup>1</sup> has been detected, the code entry is accepted (= Option mode).
- **Account button**  
The Account button can be used instead of dialing the feature number. It can be assigned to a flexible (CO, DSS, PF) button by Station, User or System Programming.

**<SLT>**

- You cannot enter an account code during a call or while hearing a reorder tone.
- Flashing the hookswitch while entering an account code cancels the entry.

**Programming Guide References**

- [105] Account Codes
- [508] Account Code Entry Mode
- [601] Class of Service

**Features Guide References**

- Station Message Detail Recording (SMDR)

**User Manual References**

- 2.2.2 Flexible Button Assignment
- 4.3.80 Toll Restriction Override by Account Code Entry

---

\*<sup>1</sup> A Calling Party Control (CPC) signal is an on-hook indication sent from a CO line when the other end hangs up. You hear a reorder tone when then signal is detected.

### 4.3.3 Alternate Calling — Ring / Voice

You can voice-announce your intercom call or have the called extension ring. When you make an intercom call by voice-announcement, the other party hears your voice over the built-in speaker of PT and can speak in the hands-free mode.

#### Alternating (to Voice-Calling mode)

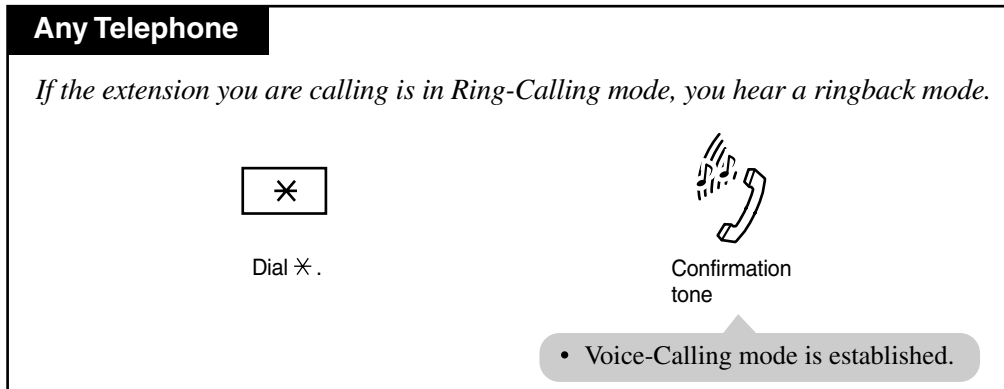

#### Alternating (to Ring-Calling mode)

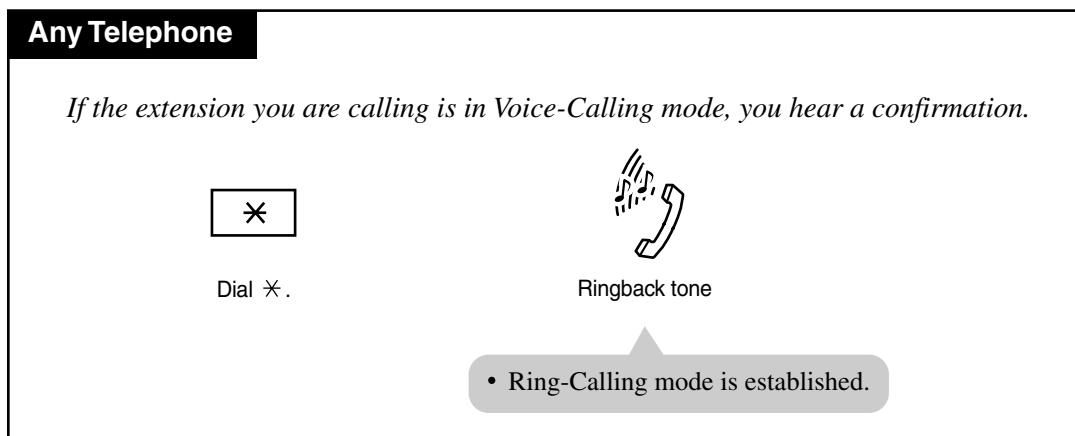

#### Conditions

- **Voice-signaling is not available in the following cases:**
  - if the other extension is an SLT.
  - if the other extension is busy on another call.
  - if another call is ringing on the other extension.
- **One time switching**  
You can switch the desired calling mode only once during a call.
- If the party you are calling is using a single line telephone (SLT), only Ring-Calling mode is available.

**<PT>**

- **Mode Selection**

You can select either to be ring-signaled or voice-signaled by Station Programming (Intercom Alert Assignment).

The default is Ring-Calling mode.

**User Manual References**

2.2.1 Initial Settings

4.3.49 Hands-free Answerback [PT only]

4.3.51 Intercom Calling

## 4.3.4 Answering, Direct Outside Line [PT only]

You can answer an outside call by pressing a flashing a CO button directly. You do not have to lift the handset or press the SP-PHONE/MONITOR button.

### To answer an incoming outside call

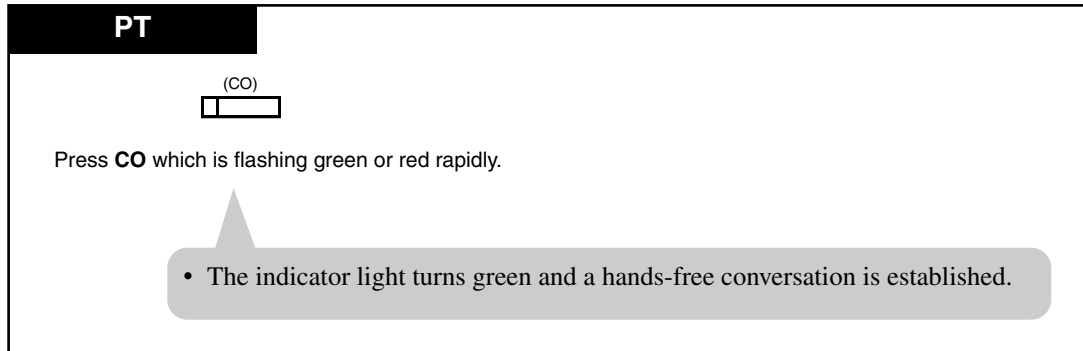

### Conditions

- You can choose the desired line to answer when more than one call is ringing on your PT by this feature.
- There are three types of CO buttons: Group-CO (G-CO) button, Loop-CO (L-CO) button and Single-CO (S-CO) button. These can be assigned to flexible CO buttons by Station, User or System Programming.

### User Manual References

- 2.2.1 Initial Settings
- 2.2.2 Flexible Button Assignment
- 4.3.50 Hands-free Operation [PT only]

### 4.3.5 Automatic Callback Busy (Camp-On)

Allows you to set to receive callback ringing when the dialed line becomes idle. When you answer the callback ringing;

**For an extension:** The called extension starts ringing without dialing.

**For an outside line:** The line is seized.

#### Setting

Any Telephone

*If you hear a busy tone after making a call (intercom or outside);*

6

Dial 6.



Confirmation tone and reorder tone



Hang up or press SP-PHONE/MONITOR.

Wait for the Camp-On recall.

**<PT Display Example>**

Callback Extxxxx

extension number

#### Answering an intercom recall

Any Telephone

*If you hear the telephone ringing;*



Lift the handset or press SP-PHONE/MONITOR.

**<PT Display Example>**

xxxx: Free

extension number

- You hear a ringback tone and the other extension begins to ring automatically.

## Answering an outside line recall

**Any Telephone**

*If you hear the telephone ringing;*



Lift the handset or press SP-PHONE/MONITOR.



Dial tone

phone no.

Dial the **phone number**.

<PT Display Example>

COXX: Free

\_\_\_\_\_ outside line number

## Canceling

**Any Telephone**



Lift the handset or press SP-PHONE/MONITOR.

4

6

Dial **46**.



Confirmation tone and dial tone



Hang up or press SP-PHONE/MONITOR.

## Conditions

- If you do not answer the recall ringing within 10 seconds (four callback ring signals), this feature will be automatically canceled.
- If the called party becomes busy again after the callback ringing starts, the ringing stops but this feature will be executed again when the extension becomes free.

### 4.3.6 Background Music (BGM) [PT only]

You can hear background music through the built-in speaker of your PT. An external music source, such as a radio, must be connected. The music stops whenever a call comes in or when you go off-hook.

#### Setting / Canceling

**PT**

*When the handset is on the cradle and the SP-PHONE/MONITOR button is off;*

**1**

Dial 1.

- The display shows either one of the following for five seconds depending on whether BGM is on or off:  
**<PT Display Example>**

BGM On

or

BGM Off

#### Conditions

- **Turning on/off**  
You can turn on/off the BGM only when your PT is not in use.

#### Programming Guide References

- [803] Music Source Use
- [990] System Additional Information



## 4.3.7 Busy Station Signaling (BSS)

You can prompt a busy extension (ringing or during a call) to answer your call. The other extension hears three beeps and knows that you are waiting.

**Any Telephone**  
*If you hear a busy tone after making an intercom call;*

<b>1</b>	
Dial 1.	Wait for an answer and talk.

### Conditions

- To answer the signal from the calling extension, see 4.3.30 Call Waiting.
- This feature is only available if the called extension has set the "Call Waiting" feature.
- Only the extensions which have enabled "Call Waiting" can receive Call Waiting tones.

### User Manual References

4.3.30 Call Waiting

## 4.3.8 Call Forwarding — SUMMARY

Automatically transfers incoming calls to another extension or to an external destination. The following types are available:

Type	Description
Call Forwarding — All Calls	All incoming calls are forwarded to another extension.
Call Forwarding — Busy	All incoming calls are forwarded to another extension when your extension is busy.
Call Forwarding — No Answer	All incoming calls are forwarded to another extension when you do not answer the call.
Call Forwarding — Busy/No Answer	All incoming calls are forwarded to another extension when you do not answer or when your extension is busy.
Call Forwarding — to Outside Line	All incoming calls are forwarded to an outside line.
Call Forwarding — Follow Me	Allows you to set the "Call Forwarding — All Calls" feature from another extension.

### Note

You can also set Voice Mail as the forwarding destination. Refer to 4.3.84 Voice Mail Integration.

### Conditions

- To cancel Call Forwarding features, refer to 4.3.15 Call Forwarding — CANCEL.
- Forwarded call is not forwarded furthermore**  
Call Forwarding can only be extended to one target telephone. For example, extension A is forwarded to extension B, and extension B is forwarded to extension C. A call to extension A is forwarded to extension B, but the call would not be forwarded to extension C. Consequently, extension B is treated as the final destination of Call Forwarding.

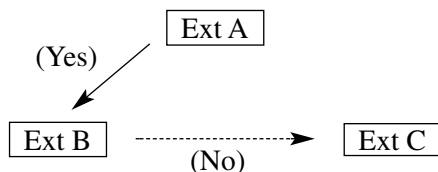

- Setting a new "Call Forwarding" function (All Calls, Busy, Busy/No Answer, etc.) cancels any other "Call Forwarding" functions.
- Floating Station**  
A floating station such as a DISA (Direct Inward System Access) or external pager cannot be programmed as a forwarding destination.

- Two extensions can set each other as the destination extension. In this case, an intercom call to the other party while he/she is absent will not be forwarded back to the original extension.
- **Confirmation tone**  
Confirmation tone 2 (two beeps) is sent when the previously programmed data is same as the new data. If it is not, confirmation tone 1 (one beep) is sent. Refer to the "Tone List" in the Appendix.
- You can call the original extension from the Call Forwarding destination extension. (Boss Secretary)

**<PT>**

- Both the Call Forwarding and Do Not Disturb (DND) functions can be programmed at the same time, but either one of them can be activated at a time.
- You can enable or disable the Call Forwarding or Do Not Disturb (DND) function by pressing the FWD/DND button while on-hook. If you set both Call Forwarding and DND, alternating the mode is also available by pressing the FWD/DND button. In this case, pressing the button changes the setting as follows:

→DND →FWD →OFF

The lighting patterns of the FWD/DND button are as follows:

Off: Both functions are canceled.

Red on : DND mode\*<sup>1</sup>

Red flash : FWD mode\*<sup>1</sup>

## User Manual References

- 2.2.2 Flexible Button Assignment
- 4.3.15 Call Forwarding — CANCEL
- 4.3.38 Do Not Disturb (DND)
- 4.3.84 Voice Mail Integration

---

\*<sup>1</sup> This setting can be changed by System Programming.

## 4.3.9 Call Forwarding — All Calls

All of calls coming to your extension are forwarded to the pre-assigned extension automatically.

### Setting

PT and SLT



Lift the handset  
or press  
SP-PHONE/MONITOR.

FWD/DND

7

1

0

For PT: Press **FWD/DND**.  
For SLT, PT: Dial **710**.

For PT  
For SLT, PT

2

Dial **2**.

extension no.

Enter the destination  
**extension number**.



Confirmation  
tone and  
dial tone

- You may press the flexible button assigned as the FWD/DND button instead.

**<PT Display Example>**

FWD(All) Extxxxx

extension number where  
the call is to be forwarded

- The FWD/DND indicator light flashes red slowly.



Hang up or press  
SP-PHONE/MONITOR.

## 4.3.10 Call Forwarding — Busy

You can forward calls to another extension when your extension is busy.

### Setting

PT and SLT



Lift the handset  
or press  
SP-PHONE/MONITOR.

FWD/DND

7

1

0

For PT: Press **FWD/DND**.  
For SLT, PT: Dial **710**.

For PT

3

Dial **3**.

extension no.

Enter the destination  
**extension number**.



Confirmation  
tone and  
dial tone

- You may press the flexible button assigned as the FWD/DND button instead.



Hang up or press  
SP-PHONE/MONITOR.

**<PT Display Example>**

FWD(BSY) Extxxxx

extension number where  
the call is to be forwarded

- The FWD/DND indicator light flashes red slowly.

### 4.3.11 Call Forwarding — No Answer

Your calls are forwarded to another extension when you do not answer the call within a pre-determined time.

#### Setting

PT and SLT



Lift the handset or press SP-PHONE/MONITOR.

FWD/DND

7

1

0

For PT: Press **FWD/DND**.  
For SLT, PT: Dial **710**.

For PT

4

Dial **4**.

extension no.

Enter the destination **extension number**.



Confirmation tone and dial tone

- You may press the flexible button assigned as the FWD/DND button instead.

**<PT Display Example>**

FWD (NA)
Extxxxx

\_\_\_\_\_ extension number where the call is to be forwarded

- The FWD/DND indicator light flashes red slowly.



Hang up or press SP-PHONE/MONITOR.

#### Conditions

- The number of rings before a call is forwarded can be changed for each extension with program "[619] Extension Call Forwarding — No Answer Time". If "[619] Extension Call Forwarding — No Answer Time" is not set, program "[202] Call Forwarding — No Answer Time" will be used.

#### Programming Guide References

- [202] Call Forwarding — No Answer Time
- [619] Extension Call Forwarding — No Answer Time

## 4.3.12 Call Forwarding — Busy / No Answer

You can forward your calls to another extension when your extension is busy or you do not answer the call within a pre-determined time.

### Setting

PT and SLT



Lift the handset  
or press  
SP-PHONE/MONITOR.

FWD/DND

7

1

0

For PT: Press **FWD/DND**.  
For SLT, PT: Dial **710**.

For PT

5

For SLT, PT

Dial **5**.

extension no.

Enter the destination  
**extension number**.



Confirmation  
tone and  
dial tone

- You may press the flexible button assigned as the FWD/DND button instead.

Hang up or press  
SP-PHONE/MONITOR.

**<PT Display Example>**

FWD ( B / NA ) Extxxxx

— extension number where  
the call is to be forwarded

- The FWD/DND indicator light flashes red slowly.

### Conditions

- The number of rings before a call is forwarded can be changed for each extension with program "[619] Extension Call Forwarding — No Answer Time". If "[619] Extension Call Forwarding — No Answer Time" is not set, program "[202] Call Forwarding — No Answer Time" will be used.

### Programming Guide References

[202] Call Forwarding — No Answer Time

[619] Extension Call Forwarding — No Answer Time

### 4.3.13 Call Forwarding — to Outside Line

You can forward all incoming calls to your extension to an outside party via a CO. The telephone number of the outside party must be pre-programmed.

PT and SLT



Lift the handset or press SP-PHONE/MONITOR.

FWD/DND

7

1

0

For PT: Press **FWD/DND**.  
For SLT, PT: Dial **710**.

For PT

For SLT, PT

6

Dial 6.

line access code

Enter a **line access code** (9 or 81 through 88).

phone no.

Dial the **phone number**.

#

Dial #.



Confirmation tone and dial tone



Hang up or press SP-PHONE/MONITOR.

**<PT Display Example>**

- When you dial "1234567":

FWD ( CO ) 91234567

- The FWD/DND indicator light flashes red slowly.

#### Conditions

- Up to 16 digits (including a line access code) can be programmed.
- Valid digits are "0 through 9", "\*". PAUSE (pausing time) can be stored by dialing \*\*.
- Class of Service**  
Class of Service programming determines the extensions that can perform this feature.
- Outside-to-Outside Line Call**  
If an incoming outside call is forwarded to an outside line, the "Outside-to-Outside Line Call Duration Time" is applied to the call and the line will be disconnected when it expires (default: 10 min).

#### Programming Guide References

- [206] Outside-to-Outside Line Call Duration Time
- [504] Call Forwarding to Outside Line
- [601] Class of Service



## 4.3.14 Call Forwarding — Follow Me

You can set the "Call Forwarding" feature from the destination extension. This is useful if you forget to set "Call Forwarding — All Calls" before you leave your desk.

### Setting

PT and SLT

*At the destination extension;*



Lift the handset  
or press  
SP-PHONE/MONITOR.

FWD/DND

7

1

0

For PT: Press **FWD/DND**.  
For SLT, PT: Dial **710**.

For PT  
For SLT, PT

7

Dial 7.

your extension no.

Dial your  
**extension number**.



Confirmation  
tone and  
dial tone

- You may press the flexible button assigned as the FWD/DND button instead.

**<PT Display Example>**

FWD ( From ) Extxxxx

your extension number

- The FWD/DND indicator light flashes red slowly at your extension.



Hang up or press  
SP-PHONE/MONITOR.

### Conditions

- This feature can be canceled either at your own extension or at the destination extension.
- Class of Service**  
Class of service programming determines the extensions that can perform this feature.

### Programming Guide References

[991] COS Additional Information

### 4.3.15 Call Forwarding — CANCEL

There are two canceling methods for "Call Forwarding". The canceling method depends on the Call Forwarding type that is assigned.

#### Canceling Call Forwarding at your (original) extension

**PT and SLT**



Lift the handset or press SP-PHONE/MONITOR.

FWD/DND

7

1

0

For PT

For SLT, PT

0



Confirmation tone and dial tone



Hang up or press SP-PHONE/MONITOR.

- You may press the flexible button assigned as the FWD/DND button instead.

**<PT Display Example>**

FWD/DND Cancel

- The FWD/DND indicator light turns off.

#### Canceling Call Forwarding at the destination extension — "Follow Me (All Calls)" only

**PT and SLT**



Lift the handset or press SP-PHONE/MONITOR.

FWD/DND

7

1

0

For PT

For SLT, PT

8

your extension no.



Confirmation tone and dial tone

- You may press the flexible button assigned as the FWD/DND button instead.

**<PT Display Example>**

FWD Cancel EXXXX

— your extension number.

- The FWD/DND indicator light on your own extension turns off.







Hang up or press SP-PHONE/MONITOR.



## 4.3.16 Call Hold

Allows you to place an intercom or outside call on hold. While the call is on hold, you can make and receive other calls.

### To place a call on hold

PT	SLT
<p><i>During a conversation;</i></p> <div style="display: flex; justify-content: space-around; align-items: center;"> <div style="text-align: center;">  <p>Press <b>HOLD</b>.</p> </div> <div style="text-align: center;">  <p>Confirmation tone and dial tone</p> </div> </div> <div style="margin-top: 10px;"> <ul style="list-style-type: none"> <li>You may replace the handset.</li> <li>The corresponding CO or INTERCOM indicator light flashes green slowly.</li> </ul> </div>	<p><i>During a conversation;</i></p> <div style="display: flex; justify-content: space-around; align-items: center;"> <div style="text-align: center;">  <p>Flash the hookswitch.</p> </div> <div style="text-align: center;"> <div style="border: 1px solid black; padding: 2px 10px;">5</div> <div style="border: 1px solid black; padding: 2px 10px;">0</div> <p>Dial <b>50</b>.</p> </div> </div> <div style="margin-top: 10px;">  <p>Confirmation tone and dial tone</p> <ul style="list-style-type: none"> <li>You may replace the handset.</li> </ul> </div>

### Retrieving a call on hold

PT	SLT
<p><i>At the holding extension;</i></p> <div style="display: flex; justify-content: center; align-items: center; margin-bottom: 10px;"> <div style="text-align: center; margin-right: 20px;"> <small>(CO)</small>   </div> <div style="text-align: center; margin-right: 20px;">or</div> <div style="text-align: center;"> <small>INTERCOM</small>   </div> </div> <p>Press <b>CO</b> or <b>INTERCOM</b> which is flashing green slowly.</p> <div style="margin-top: 10px;"> <ul style="list-style-type: none"> <li>The CO or INTERCOM indicator light turns steady green.</li> </ul> </div>	<p><i>At the holding extension;</i></p> <div style="display: flex; justify-content: space-around; align-items: center; margin-bottom: 10px;"> <div style="text-align: center;">  <p>Lift the handset.</p> </div> <div style="text-align: center;"> <div style="border: 1px solid black; padding: 2px 10px;">5</div> <div style="border: 1px solid black; padding: 2px 10px;">0</div> <p>Dial <b>50</b>.</p> </div> </div>

### Conditions

- To retrieve a call on hold at another extension, refer to 4.3.18 Call Hold Retrieve.
- Music on Hold**  
"Music on Hold" is sent to the party on hold, if available.
- What if a call on hold is not retrieved?**  
If a call on hold is not retrieved in a specified period of time (default: 60 s), Hold Recall (if the extension on-hook) or Hold Warning tone (if engaged in another call) rings the extension where the call is held. Refer to 6.1.3 Tone List for details about Tone Patterns.

- **Automatic Disconnection**

If a call (outside, extension) placed on hold is not retrieved within 30 minutes, it is automatically disconnected.

**<PT>**

- With outside calls, you can put multiple calls on hold. However, with intercom calls, you can put only one call on hold.

## **Programming Guide References**

[200] Hold Recall Time

## **Features Guide References**

Hold Recall

## **User Manual References**

4.3.18 Call Hold Retrieve

### 4.3.17 Call Hold, Exclusive [PT only]

Allows you to prevent other extension users from retrieving your held call. A call put on exclusive hold can only be retrieved from the extension that placed it on hold.

#### To place a call on exclusive hold

PT

*During a conversation;*

HOLD

Press **HOLD**.

HOLD

Press **HOLD** again.

- The CO or INTERCOM indicator light flashes green moderately.
- The current call is placed on exclusive hold.

- The CO or INTERCOM indicator light flashes green slowly.
- The current call is placed on hold.

#### Retrieving a call on exclusive hold

PT

(CO)

or

INTERCOM

Press the **CO** or **INTERCOM** which is on exclusive hold.

- The CO or INTERCOM indicator light turns steady green.
- You can talk to the held party again.

#### Conditions

- What if a call on Exclusive Hold is not retrieved?**  
If a call on Exclusive Hold is not retrieved in a specific period of time (default: 60 s), Hold Recall (if the extension is on-hook) or Hold Warning tone (if engaged in another call) rings the extension where the call is held. After this, the held call can be retrieved from any other extension. Refer to 6.1.3 Tone List for details about Tone Patterns.
- Automatic Disconnection**  
If a outside call placed on hold is not retrieved in 30 minutes, it is automatically disconnected.
- With outside calls, you can put multiple calls on exclusive hold. However, with intercom calls, you can put only one call on exclusive hold.

#### Programming Guide References

[200] Hold Recall Time

## **Features Guide References**

Hold Recall

## **User Manual References**

4.3.16 Call Hold

## 4.3.18 Call Hold Retrieve

Allows you to retrieve a call that has been placed on hold at other extensions.

### Retrieving an outside call on hold

**Any Telephone**

*At the other extension;*



Lift the handset or press  
SP-PHONE/MONITOR.

5

3

Dial **53**.

outside line no.

Enter the held  
**outside line number**.  
(01-12)



Confirmation  
tone (optional)

**PT**

*At the other extension;*

(CO)

Press **CO** whose indicator  
is flashing red slowly.

- The CO indicator light  
turns steady green.

### Retrieving an intercom call on hold

**Any Telephone**

*At the other extension;*



Lift the handset or press  
SP-PHONE/MONITOR.

5

1

Dial **51**.

extension no.

Dial the **extension  
number** at which a call is  
placed on hold.



Confirmation tone  
(optional)

### Conditions

- **Confirmation Tone**  
A confirmation tone is sent to the extension user who retrieved the held call. Eliminating the tone is programmable.
- "Call Park" cannot be retrieved by this feature.

## **Programming Guide References**

[990] System Additional Information

## **User Manual References**

4.3.16 Call Hold



## 4.3.19 Call Information / Log, Incoming

Provides you with the caller's telephone number and name simultaneously on the outside (CO) line assigned to receive Caller ID service\*<sup>1</sup> calls. If the call is not answered, the call information is automatically recorded.

### Display Operation ( — for the KX-T7030/KX-T7130/KX-T7135)

While receiving an incoming outside call, the display shows the caller's telephone number or name.

- If you want to see other information, press the Caller ID Selection button or press #.
- The display changes as follows:

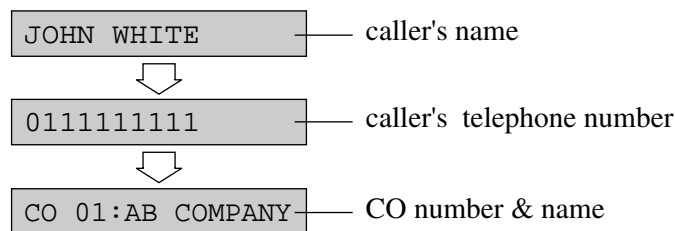

### To call back

1. Lift the **handset** or press the **SP-PHONE** button.
2. Press the **Caller ID Selection** or **FWD/DND** button to see other information.
  - The display changes as follows:

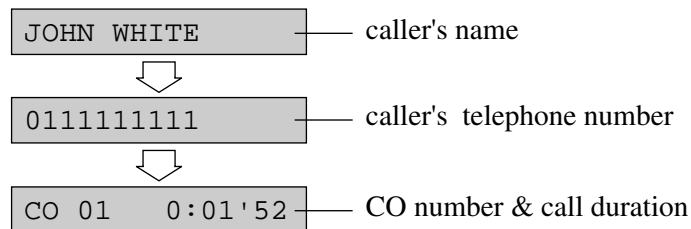

### Conditions

- The Caller ID Indication button indicator light may turn on when an incoming outside call is not answered.
- Even if you answer a call, the call information can be recorded by pressing the Caller ID Indication button during the conversation.
- You can modify and call back the logged numbers. Refer to 4.3.20 Call Log, Incoming [PT only].
- A caller's name will not be displayed unless it is sent from the Central Office. However, the caller's name will be displayed when a caller's name is not sent from the Central Office but

\*<sup>1</sup> The Caller ID service provides you with the caller's information, such as the name and telephone number, on the outside (CO) line assigned to receive Caller ID service calls. Refer to the Installation Manual.

the sent number matches one programmed in the system. A CO name will not displayed unless it has been assigned by System Programming.

- If "OUT OF AREA" is displayed, the call may be from out of the calling area.
- If "PRIVATE" is displayed, the caller chose not to reveal their information.

### **Programming Guide References**

[005] Flexible CO Button Assignment

[100] Flexible Numbering

[110] Caller ID Code Set

[111] Caller ID Name Set

[406] Caller ID Assignment

### **User Manual References**

4.3.20 Call Log, Incoming [PT only]

4.3.21 Call Log Lock, Incoming in the Personal Area [PT only]

4.4.5 Call Log Lock, Incoming in the Common Area

## 4.3.20 Call Log, Incoming [PT only]

If a call is not answered, the incoming outside call information from the Caller ID service<sup>\*1</sup> is automatically logged in the system and the Caller ID Indication button indicator lights. There are two kinds of call log areas available in the system. One is the personal area, which stores call logs for each extension. The other is the common area, which stores call logs for the system. A call comes directly to a certain extension is stored in the extension's personal area. A call for multiple extensions is stored in the common area. To check the caller's information stored in the personal area, you need to assign the Caller ID Indication — Personal button. For common area, the Caller ID Indication — Common button is necessary. Up to 20 calls can be logged in each personal area and up to 300 calls in the common area. When the call log in the personal area is full (20 calls are stored), you can select how the 21st call is treated. Either a new call can be disregarded or the new call can overwrite the oldest call that have been already confirmed (Default: Record the new call.). As for the common area, only the operator or manager can control this. (Refer to 4.4.10 The 301st Call Log, Incoming in the Common Area Treatment.)

### Setting overwriting the call log in the personal area

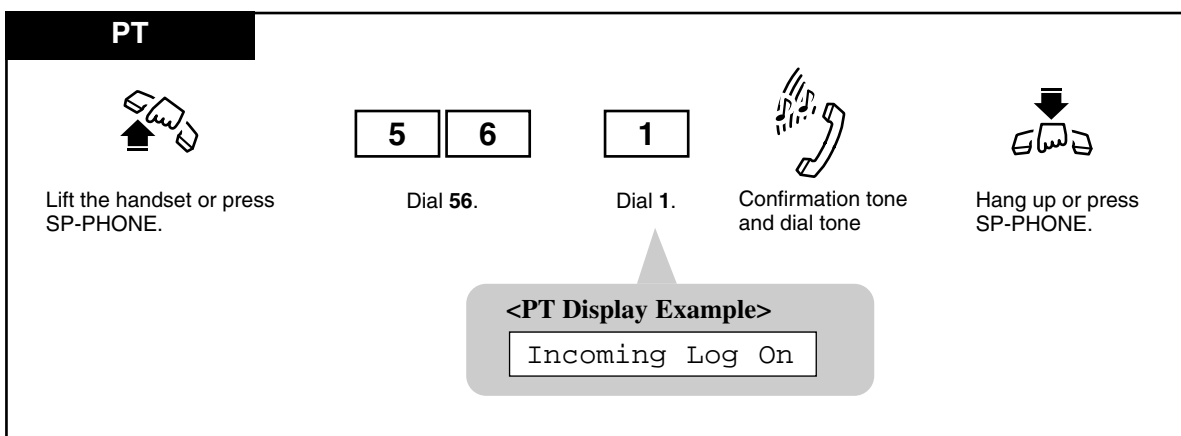

### Canceling overwriting the call log (Disregarding the 21st call) in the personal area

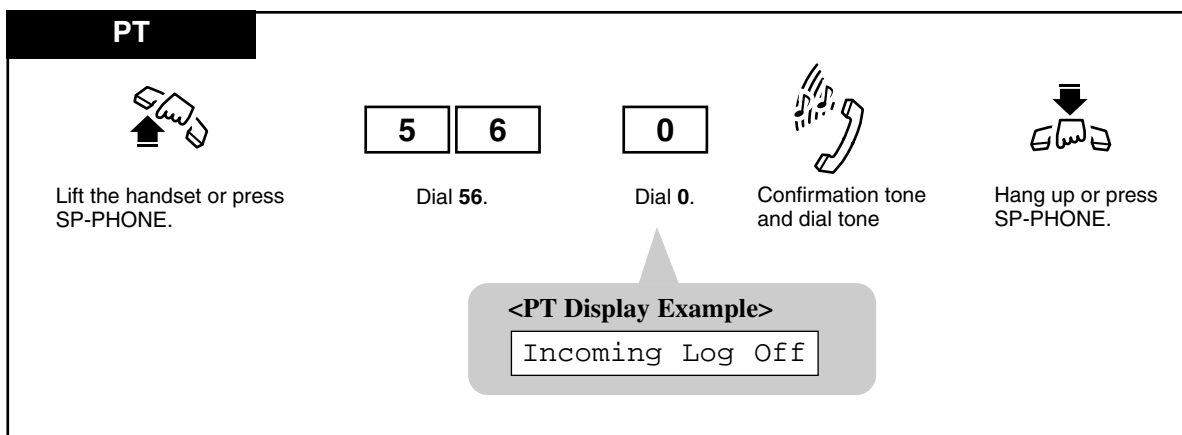

<sup>\*1</sup> The Caller ID service provides you with a caller's information, such as his/her name and telephone number, on the CO line assigned to receive Caller ID service calls. Refer to "Caller ID Service" in the Features Guide for further information.

## Confirming and calling back

### Display Operation (— for the KX-T7030/KX-T7130/KX-T7135)

When the Caller ID Indication — Personal button indicator is red, there are new calls logged in the personal area. When the Caller ID Indication — Common button indicator is red, there are new calls logged in the common area.

#### To confirm

1. Press the **Caller ID Indication** button to see the incoming call information.
  - The new information that you have not confirmed will be displayed first.

001:0111111111

2. You can confirm another caller's information by pressing the **Caller ID Indication** button again. After displaying all of the new information, the old information you have already confirmed will be displayed.

002:0924773333

- To modify the telephone number, use the \* button to erase and "0 to 9" to add numbers from the first digit.
- To clear the displayed information, press the TRANSFER button.
- To clear all logged call information in the common area, only the operator or manager can clear all logged call information. (Refer to 4.4.3 Call Log, Incoming in the Common Area — CLEAR ALL.)
- To return to the initial display, go off-hook and on-hook.
- Pressing the Caller ID Selection — Personal button or # button provides you with further information about the party stored in the personal area. Pressing the Caller ID Selection — Common button or # button provides you with further information about the party stored in the common area.

The display changes as follows:

<Example>

If the information is stored in log 003,

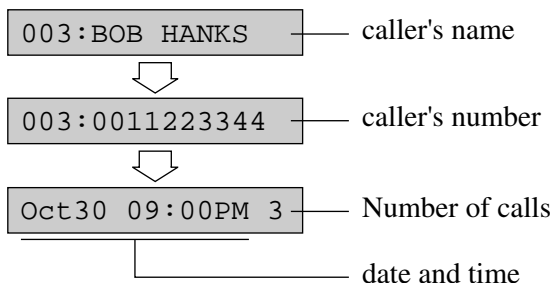

- Only twelve digits (or characters) of caller's number (or name) can be displayed even though fifteen digits (or characters) of information may have been received. To scroll the display, press **➡** (the FWD/DND button).

## Confirming the number of logged calls

**PT**

— *In the Personal Area*

(CID-P S)

Press **Caller ID Selection — Personal** (flexible button) while on-hook.

**<PT Display Example>**

New:002 Old:003

- The above information will be displayed for 3 seconds.

— *In the Common Area*

(CID-C S)

Press **Caller ID Selection — Common** (flexible button) while on-hook.

**<PT Display Example>**

New:002 Old:003

- The above information will be displayed for 3 seconds.

## Clearing all call logs in the personal area

**PT**

 Lift the handset or press SP-PHONE.

**5 9 0 1**

Dial 5901.

 Confirmation tone and dial tone

 Hang up or press SP-PHONE.

**<PT Display Example>**

CID Log Clear

### To call back

- Confirm the displayed number you desired after pressing the **Caller ID Indication** button, and then lift the **handset** or press the **SP-PHONE** button.

003:0011223344

- Press the **Caller ID Indication** button.
  - You may press a CO button first to select a specified outside (CO) line. The last displayed number is dialed.

## Conditions

- When "Disregarding the 21st call in the personal area" has been set and 20 calls are logged, the Caller ID Selection — Personal button indicator lights and informs you that no more calls can be logged.
- When "Overwriting the 21st call in the personal area" has been set and all of old information has been overwritten in the personal area, the Caller ID selection — Personal button indicator lights and informs you that no more calls can be logged.
- System Programming determines who can check the caller's information stored in the common area.
- If nobody has assigned the Caller ID Indication — Common button, a call directed to multiple extensions will be stored in an extension's personal area that is connected to the lowest jack number and the extension's Caller ID Indication — Personal button indicator will light.
- If a Direct In Lines (DIL) 1 : 1 call is forwarded by Call Forwarding, the data will be logged at both the forwarding and forwarded extension.
- You can lock the display so that incoming call information is not shown on the display. (Refer to 4.3.21 Call Log Lock, Incoming in the Personal Area [PT only].)
- If you modify the displayed telephone number, the new number will be memorized.
- Only operators or a manager can set or cancel overwriting the call log in the common area.
- When the call log in the personal area is displayed, you can select the display mode in System Programming as follows:
  - Separate mode: Caller's information is displayed separately as many times as identical calls were received.
  - Counter mode (default): Caller's information is displayed in one information with a counter that indicates the number of times identical calls were received.

## Programming Guide References

- [100] Flexible Numbering
- [110] Caller ID Code Set
- [111] Caller ID Name Set
- [125] Area Code Assignment
- [126] Caller ID Modification for Local Call
- [127] Caller ID Modification for Long Distance Call
- [406] Caller ID Assignment
- [417] Outside Line Name Assignment
- [624] Common Area Call Log Check Assignment
- [991] COS Additional Information

## User Manual References

- 2.2.1 Initial Settings
- 2.2.2 Flexible Button Assignment
- 4.3.21 Call Log Lock, Incoming in the Personal Area [PT only]

- 4.4.3 Call Log, Incoming in the Common Area — CLEAR ALL
- 4.4.5 Call Log Lock, Incoming in the Common Area
- 4.4.10 The 301st Call Log, Incoming in the Common Area Treatment

### 4.3.21 Call Log Lock, Incoming in the Personal Area [PT only]

Allows you to lock the display of your extension so that the "Call Log, Incoming" feature is not shown on the display, when you press the Caller ID Indication — Personal button, if you do not want others to see the information stored in the personal area.

#### Locking

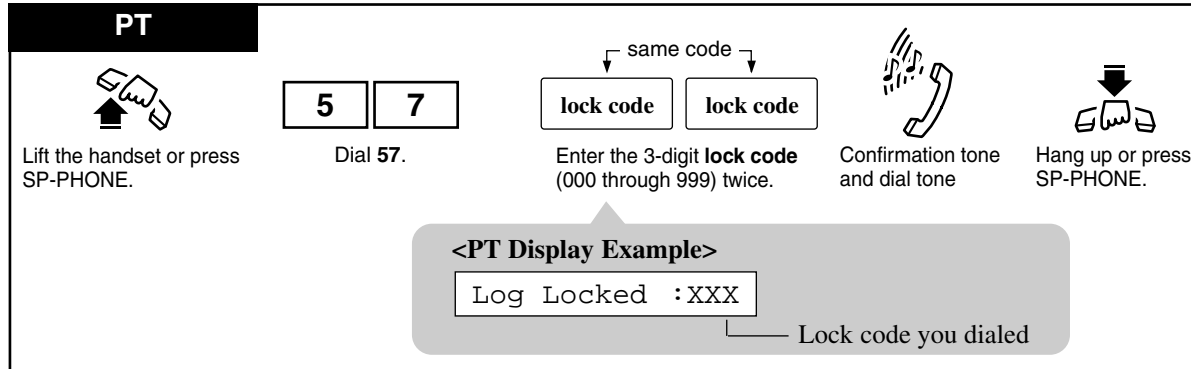

#### Unlocking

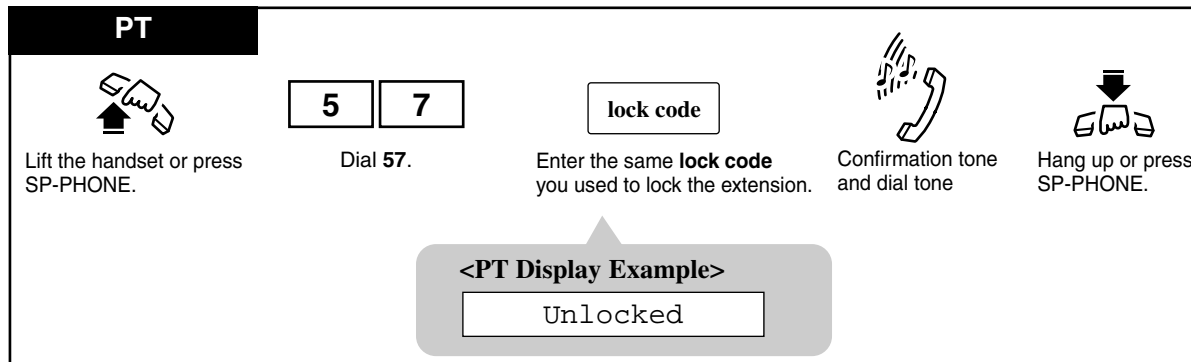

#### Conditions

- **Call Log Lock Control, Incoming in the Personal Area — CANCEL**  
The Manager or an Operator can unlock the call log display for any extension, if you forget your lock code (4.4.4 Call Log Lock Control, Incoming in the Personal Area — CANCEL).

#### Programming Guide References

- [100] Flexible Numbering
- [406] Caller ID Assignment



### **User Manual References**

- 4.3.20 Call Log, Incoming [PT only]
- 4.4.4 Call Log Lock Control, Incoming in the Personal Area — CANCEL
- 4.4.5 Call Log Lock, Incoming in the Common Area

### 4.3.22 Call Park

Allows you to place a held call into a system parking area. You can be released from the parked call to perform other operations. The parked call can be retrieved from any extension. Up to ten calls can be parked.

#### Parking a call

PT and SLT

*During a conversation;*

TRANSFER

For PT



For SLT

For PT: Press **TRANSFER**.  
For SLT: Flash the hookswitch.



Confirmation tone  
and dial tone

5

2

Dial **52**.

parking zone no.

Enter a **parking zone number** (0 through 9).



Confirmation tone  
and dial tone

**<PT Display Example>**

Call. Parked at x

Parking zone number  
(0 through 9)

- If you hear a busy tone, it indicates the specified parking zone is unavailable.

**<PT Display Example>**

Park at x N/A

- You can change the parking zone simply by entering the parking zone number while hearing the busy tone.

## Retrieving a parked call

Any Telephone



Lift the handset or press  
SP-PHONE/MONITOR.

5

2

Dial 52.

parking zone no.

Enter a **parking zone number**  
(0 through 9) where the call  
is parked.



Confirmation tone  
(optional)

You can talk  
to the party.

- If there is no held call, you will hear a reorder tone.

<PT Display Example>

No Held Call

### Conditions

- **Call Park Recall**  
If a parked call is not retrieved in a specific period of time (default: 12 rings), "Call Park Recall" occurs. If a parked call is an outside call, it is possible to select whether "Call Park Recall" will go to the initiating extension or to Operator 1 by System Programming. If a parked call is an intercom call, "Call Park Recall" will return to the initiating extension.
- **Automatic Disconnection**  
If a parked call is not retrieved in 30 minutes, it is automatically disconnected.
- **Confirmation Tone**  
A confirmation tone is sent to the extension user who retrieved the parked call. Eliminating the tone is programmable.

### Programming Guide References

[219] Call Park Recall Time

[990] System Additional Information

### 4.3.23 Call Pickup, Directed

Allows you to answer an incoming call ringing at any other extension.

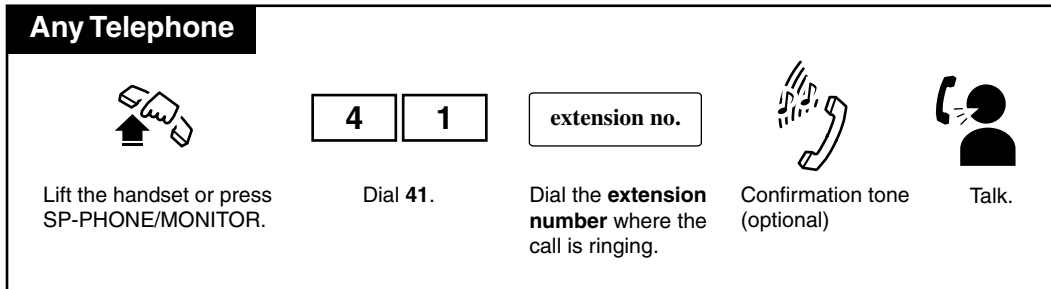

#### Conditions

- Doorphone calls can be picked up from extensions that are not programmed to answer doorphone calls.
- **Confirmation tone**  
A confirmation tone is audible when the call is picked up. Eliminating the tone is programmable.
- If you receive a call waiting tone during a conversation, you may ask a third party to pick up your second call by Directed Call Pickup.

#### Programming Guide References

[990] System Additional Information

#### User Manual References

4.3.26 Call Pickup Deny

## 4.3.24 Call Pickup, Group

Allows you to answer a call that is ringing at another telephone within your extension group.

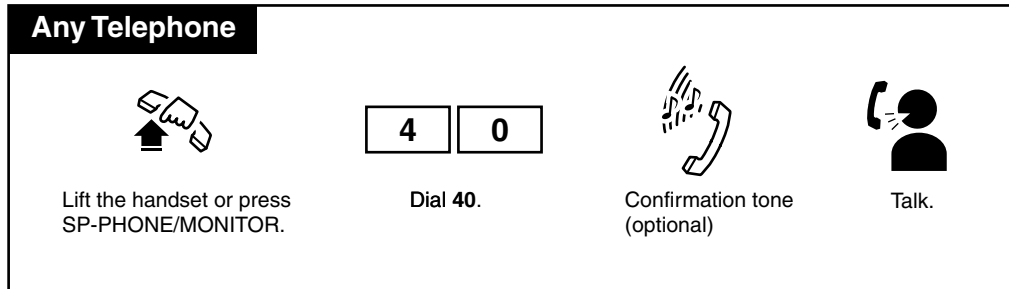

### Conditions

- **Confirmation tone**  
A confirmation tone is audible when the call is picked up. Eliminating the tone is programmable.
- You can pick up an incoming outside, intercom or doorphone call.

### Programming Guide References

- [602] Extension Group Assignment
- [990] System Additional Information

### Features Guide References





- Extension Group

### User Manual References

- 4.3.26 Call Pickup Deny
- 4.3.30 Call Waiting

## 4.3.25 Call Pickup, Outside Line

Allows you to answer an incoming outside call that is ringing at another extension.

Any Telephone			
			
Lift the handset or press SP-PHONE/MONITOR.	Dial 4*.	Confirmation tone (optional)	Talk.

### Conditions

- **Confirmation Tone**

A confirmation tone is audible when the call is picked up. Eliminating the tone is programmable.

### Programming Guide References

[990] System Additional Information

### User Manual References

4.3.26 Call Pickup Deny

4.3.30 Call Waiting

## 4.3.26 Call Pickup Deny

Allows you to prevent another extension from picking up your calls with the "Call Pickup" feature.

### Setting / Canceling

Any Telephone



Lift the handset or press  
SP-PHONE/MONITOR.

7	2	0	1	To set.
7	2	0	0	To cancel.

To set: Dial **7201**.  
To cancel: Dial **7200**.



Confirmation tone  
and dial tone



Hang up or press  
SP-PHONE/MONITOR.

**<PT Display Example>**

- When setting:

C.Pickup Deny

- When canceling:

C.Pickup Allow



### User Manual References

- 4.3.23 Call Pickup, Directed
- 4.3.24 Call Pickup, Group
- 4.3.25 Call Pickup, Outside Line

### 4.3.27 Call Splitting

Allows you to have two callers on a line and alternate between them. If a call comes in while you are already on the line, you can place the current call (1st call) on hold and have a conversation with the other party (2nd call).

**When you are engaged in the 2nd call (inside/outside), while placing the 1st call (inside/outside) on hold temporarily (Consultation Hold<sup>\*1</sup>)**

<b>PT</b>	<div style="text-align: center;">  <p>TRANSFER</p> </div> <p>Press <b>TRANSFER</b>.</p> <div style="border: 1px solid gray; border-radius: 15px; padding: 5px; width: fit-content; margin-left: auto; margin-right: auto;"> <ul style="list-style-type: none"> <li>You are connected to the 1st caller.</li> <li>Pressing the TRANSFER button alternates between two callers.</li> </ul> </div>
<b>SLT</b>	<div style="text-align: center;">  <p>Flash the hookswitch.</p> </div> <div style="border: 1px solid gray; border-radius: 15px; padding: 5px; width: fit-content; margin-left: auto; margin-right: auto;"> <ul style="list-style-type: none"> <li>You are connected to the 1st caller.</li> <li>Flashing the switchhook alternates between two callers.</li> </ul> </div>

**When you are engaged in the 2nd call (inside), while placing the 1st call (inside) on (exclusive) hold**

<b>PT</b>	<p><i>Between two extensions;</i></p> <div style="text-align: center;">  <p>HOLD</p> </div> <p>Press <b>HOLD</b>.</p> <div style="border: 1px solid gray; border-radius: 15px; padding: 5px; width: fit-content; margin-left: auto; margin-right: auto;"> <ul style="list-style-type: none"> <li>Pressing the HOLD button alternates between two callers.</li> </ul> </div>
-----------	--

**When you are engaged in the 2nd call (inside/outside), while placing the 1st call (inside/outside) on (exclusive) hold**

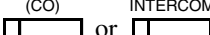
<b>PT</b>	<div style="display: flex; justify-content: space-around; align-items: flex-start;"> <div style="text-align: center;">  <p>HOLD</p> <p>Press <b>HOLD</b>.</p> </div> <div style="text-align: center;"> <p>(CO) or INTERCOM</p>  <p>Press <b>CO</b> or <b>INTERCOM</b>.</p> </div> </div> <div style="border: 1px solid gray; border-radius: 15px; padding: 5px; width: fit-content; margin-left: auto; margin-right: auto;"> <ul style="list-style-type: none"> <li>Repeating these operations (steps 1 and 2) alternates between two callers.</li> </ul> </div>
-----------	--

#### Conditions

- This feature does not work during a doorphone call or paging.

<sup>\*1</sup> Consultation Hold places a call on hold temporarily to transfer it or makes a Conference call or Call Splitting.



## **Features Guide References**

Consultation Hold

## **User Manual References**

4.3.16 Call Hold

4.3.17 Call Hold, Exclusive [PT only]

### 4.3.28 Call Transfer — to Extension

Allows you to transfer the call you received to another extension. There are two ways.

**Screened Call Transfer:** The destination confirms the transfer before you send it.

**Unscreened Call Transfer:** The line is released after transferring the call without confirmation.

#### Screened Call Transfer to Extension

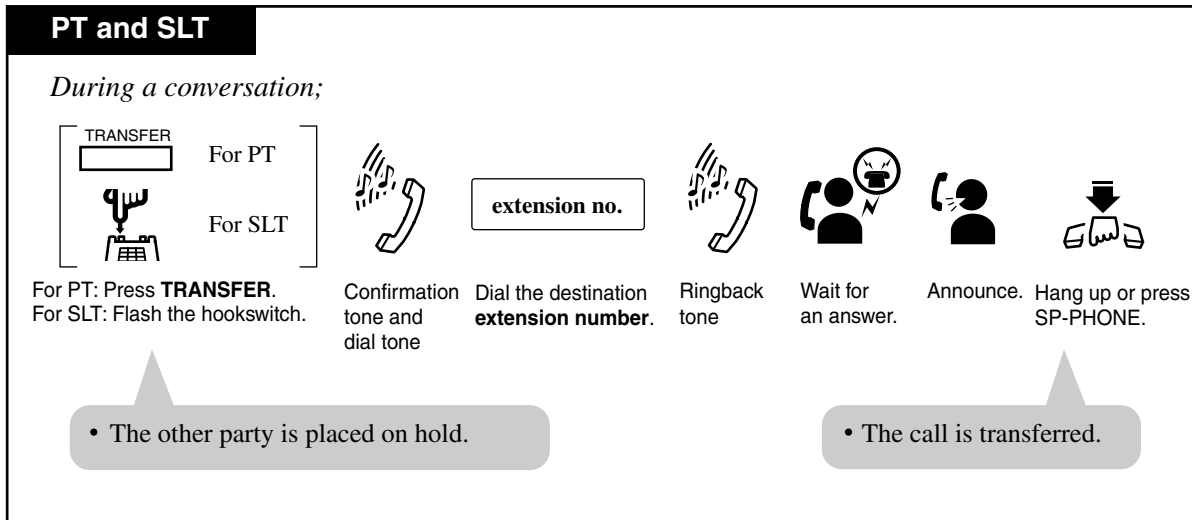

#### Unscreened Call Transfer to Extension

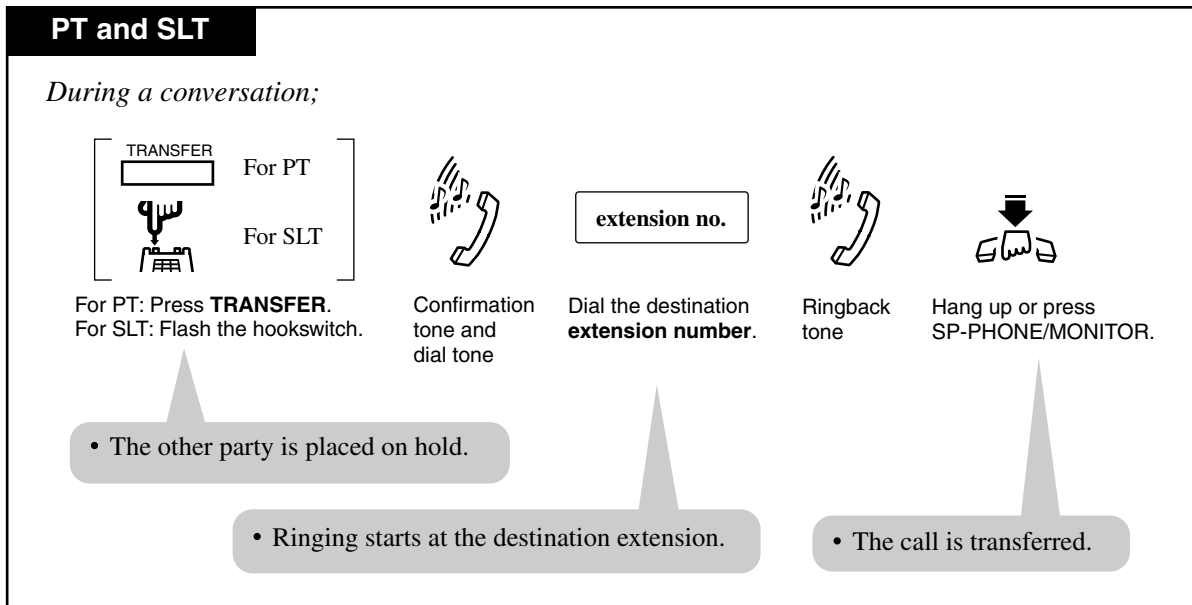

## Call Transfer using a DSS button

Allows PT users to perform Screened or Unscreened Call Transfer by using a DSS button. There are two operations, depending on whether or not One-Touch Transfer<sup>\*1</sup> is set.

### When "One-Touch Transfer" mode is enabled:

PT

*During a conversation;*

(DSS)  



Press **DSS** (flexible button).

- The other party is placed on hold and the destination extension is called immediately.

### When "One-Touch Transfer" mode is disabled:

PT

*During a conversation;*

TRANSFER  

Press **TRANSFER**.

(DSS)  

Press **DSS** (flexible button).

## Conditions

- **Automatic Disconnection**  
If there is no answer for 30 minutes after "Transfer Recall" starts, the line will be disconnected.
- If the destination extension does not answer the call within twelve rings (default), "Transfer Recall" occurs. If the transferred call is an outside call, it is possible to select whether Transfer Recall will go to the initiating extension or to Operator 1 by System Programming.

<sup>\*1</sup> One-Touch Transfer allows you to hold an outside call and transfer it to an extension by pressing one key. This feature provides automatic hold and transfer, without pressing the TRANSFER button. System Programming is required to use this function.

**<PT>**

- The destination extension shows the Caller ID and the extension number where the call was transferred from on the display.

<Example> The Caller ID number "123456789" is transferred from extension 101.

101 → 123456789

The priority of the display is:

Caller ID name > Caller ID number > Outside line name > Blank (if none of these is assigned).

- A flexible CO button can be assigned as a DSS button.
- To use "One-Touch Transfer", System Programming is required.
- Pressing the FLASH button while dialing clears the display. Then you can enter the revised number.
- If you want to return to the held call, press the TRANSFER button or corresponding CO, INTERCOM button before the destination extension answers.
- When "Transfer Recall" occurs, the display shows:

<Example>

RCL: Ext 103

**<SLT>**

- If you want to return to the held call, flash the hookswitch before the destination extension answers.

**Programming Guide References**

[108] Automatic Hold by CO / DSS Button

[201] Transfer Recall Time

[990] System Additional Information

**User Manual References**

4.3.22 Call Park

## 4.3.29 Call Transfer — to Outside Line

You can transfer a call (intercom, outside) to an outside party via outside line.

### Screened Call Transfer

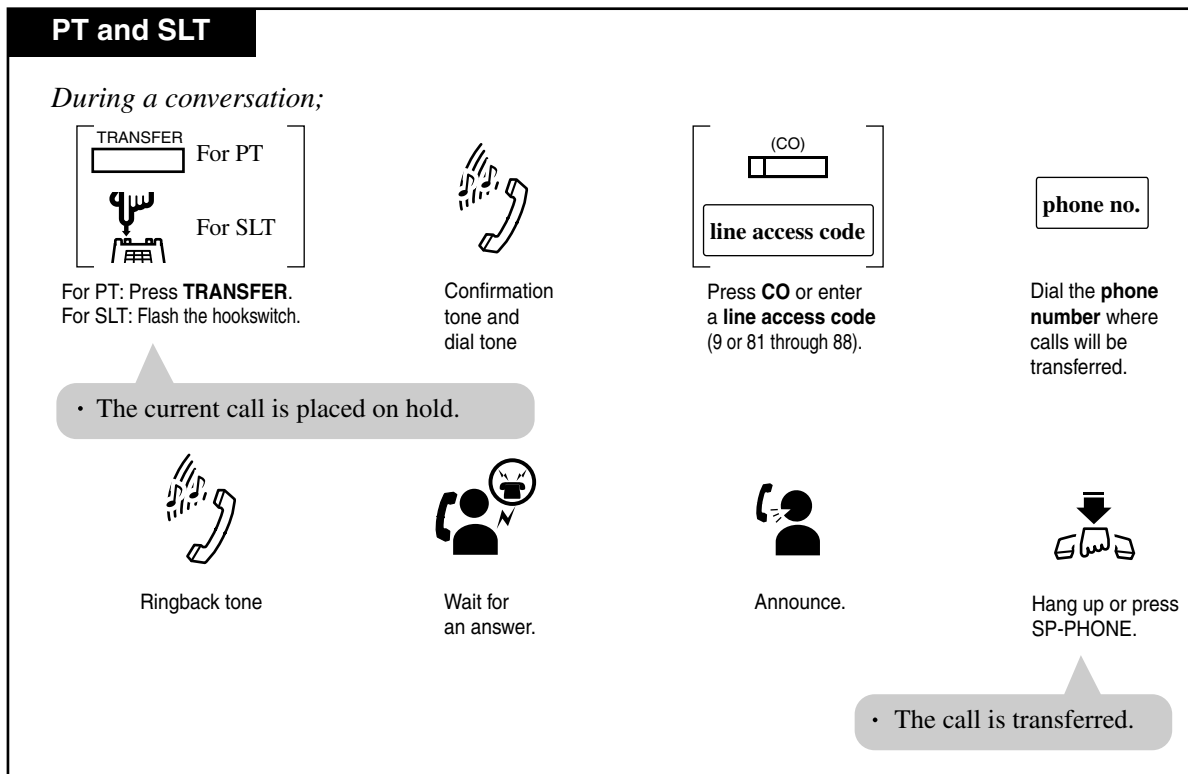

### Conditions

- **Class of Service**  
Class of Service programming determines the extensions that can perform this feature.
- **Outside-to-Outside Line Call**  
If an outside call is transferred to an outside party, "outside-to-outside call" is established and the call duration is restricted by a system timer "Outside-to-Outside Line Call Duration Time (1-64 min)".  
Hold Recall tone  
Hold Recall tone is generated to the extension who transferred the call 50 seconds before the time-out.  
Hold Alarm tone  
Hold Alarm tone is generated to both outside parties 15 seconds before the time-out. The call is disconnected at the time-out unless the extension user (who transferred the call) joins the outside-to-outside call to establish a conference call.

### <PT>

- Pressing the FLASH button while dialing clears the display. Then you can enter the revised number.

- If you want to return to the held call, press the TRANSFER button or corresponding CO or INTERCOM button before the destination party answers.
- If you want to join the conversation after transferring the call or while hold recall tone is sent, press the corresponding CO button. A conference call is established.

### **Programming Guide References**

[206] Outside-to-Outside Line Call Duration Time

[503] Call Transfer to Outside Line

[601] Class of Service

### **Features Guide References**

Hold Recall

### 4.3.30 Call Waiting

During a call, a Call Waiting tone informs you that there is another call waiting for you. You can answer the second call by disconnecting or placing the current call on hold.

#### Setting

Any Telephone



Lift the handset or press  
SP-PHONE/MONITOR.

7	3	1	1
---	---	---	---

Dial 7311.



Confirmation tone  
and dial tone

**<PT Display Example>**  
Call Waiting On



Hang up or press  
SP-PHONE/MONITOR.

#### Canceling

Any Telephone



Lift the handset or press  
SP-PHONE/MONITOR.

7	3	1	0
---	---	---	---

Dial 7310.









Confirmation tone  
and dial tone















Hang up or press  
SP-PHONE/MONITOR.

**<PT Display Example>**  
Call Waiting Off

**To talk to the new party by terminating the current call**

PT	SLT
<p><i>While hearing a Call Waiting tone;</i></p> <div style="display: flex; justify-content: space-around; align-items: center;"> <div style="text-align: center;"> <p>(CO)  or INTERCOM </p> <p>Press the flashing <b>CO</b> or <b>INTERCOM</b>.</p> </div> <div style="text-align: center;">  <p>Talk to the new caller.</p> </div> </div> <div style="border: 1px solid gray; border-radius: 15px; padding: 5px; margin-top: 10px; background-color: #f0f0f0;"> <ul style="list-style-type: none"> <li>• The current call is disconnected.</li> </ul> </div>	<p><i>While hearing a Call Waiting tone;</i></p> <div style="display: flex; justify-content: space-around; align-items: center;"> <div style="text-align: center;">  <p>Hang up.</p> </div> <div style="text-align: center;">  <p>Lift the handset.</p> </div> <div style="text-align: center;">  <p>Talk to the new caller.</p> </div> </div> <div style="border: 1px solid gray; border-radius: 15px; padding: 5px; margin-top: 10px; background-color: #f0f0f0;"> <ul style="list-style-type: none"> <li>• The current call is disconnected.</li> </ul> </div>

**To talk to the new party by holding the current call**

PT
<p><i>While hearing the Call Waiting tone and the CO or INTERCOM indicator is flashing rapidly;</i></p> <div style="display: flex; justify-content: space-around; align-items: center;"> <div style="text-align: center;"> <p>HOLD </p> <p>Press <b>HOLD</b>.</p> </div> <div style="text-align: center;"> <p>(CO)  or INTERCOM </p> <p>Press the flashing <b>CO</b> or <b>INTERCOM</b>.</p> </div> <div style="text-align: center;">  <p>Talk to the new caller.</p> </div> </div> <div style="border: 1px solid gray; border-radius: 15px; padding: 5px; margin-top: 10px; background-color: #f0f0f0;"> <ul style="list-style-type: none"> <li>• The current call is placed on hold.</li> <li>• If both the current call and new call are extension calls, you will be connected to the new caller simply by pressing HOLD.</li> </ul> </div>
SLT
<p><i>While hearing a Call Waiting tone;</i></p> <div style="display: flex; justify-content: space-around; align-items: center;"> <div style="text-align: center;">  <p>Flash the hookswitch.</p> </div> <div style="text-align: center;">  <p>Confirmation tone and dial tone</p> </div> <div style="text-align: center;"> <p> </p> <p>Dial 50.</p> </div> <div style="text-align: center;">  <p>Dial tone</p> </div> <div style="text-align: center;">  <p>Hang up.</p> </div> <div style="text-align: center;">  <p>Lift the handset.</p> </div> <div style="text-align: center;">  <p>Talk to the new caller.</p> </div> </div> <div style="border: 1px solid gray; border-radius: 15px; padding: 5px; margin-top: 10px; background-color: #f0f0f0;"> <ul style="list-style-type: none"> <li>• The current call is placed on hold.</li> </ul> </div>

**Conditions**

- The call waiting tone is generated when an outside call, a doorphone call is received, or when an extension caller executes Busy Station Signaling.
- **Data Line Security**  
Setting Data Line Security temporarily cancels Call Waiting which has been turned on by an extension user.



**<PT>**

- **Call Waiting Tone Type Selection**

For PT users, two types of call waiting tones are provided to prevent them from missing the tone. You can change the desired Call Waiting tone for an incoming outside call and intercom call (Tone 1 and Tone 2). As for a doorphone call, Tone 1 is used as a Call Waiting tone (not changeable).

**User Manual References**

2.2.1 Initial Settings

4.3.7 Busy Station Signaling (BSS)

4.3.36 Data Line Security

### 4.3.31 Call Waiting from Central Office

During a conversation, a call waiting tone offered by the local Central Office signals your extension that there is another call waiting. You can answer the second call by placing the first call on hold.

#### Using the FLASH button

**PT**

*While hearing a Call Waiting tone through the handset;*

FLASH  



Press **FLASH**.

- The current call is placed on hold and you can talk to the second caller.

#### Using the feature number

**SLT**

*While hearing a Call Waiting tone through the handset;*



Flash the hookswitch.

- The first party is placed on hold.

6

Dial 6.

- You can talk to the second party.

#### Conditions

- This is an optional telephone company service.  
For more information, consult the local telephone company.

#### <PT>

- You can return to the original party by pressing the FLASH button again.

#### <SLT>

- You can return to the original party by flashing the hookswitch and then dialing 6 again.

### 4.3.32 Caller ID Call Waiting [PT only]

During a conversation, a Call Waiting tone offered by your Central Office informs you that there is a call waiting. If the Caller ID service provides you with a caller's information, such as the name and telephone number, the new caller's information will be displayed (flashing) on your extension (KX-T7030, KX-T7130 and KX-T7135 only) during the assigned time. You can answer the second call by disconnecting the first call or placing it on hold.

**To talk to the new party by holding the current call**

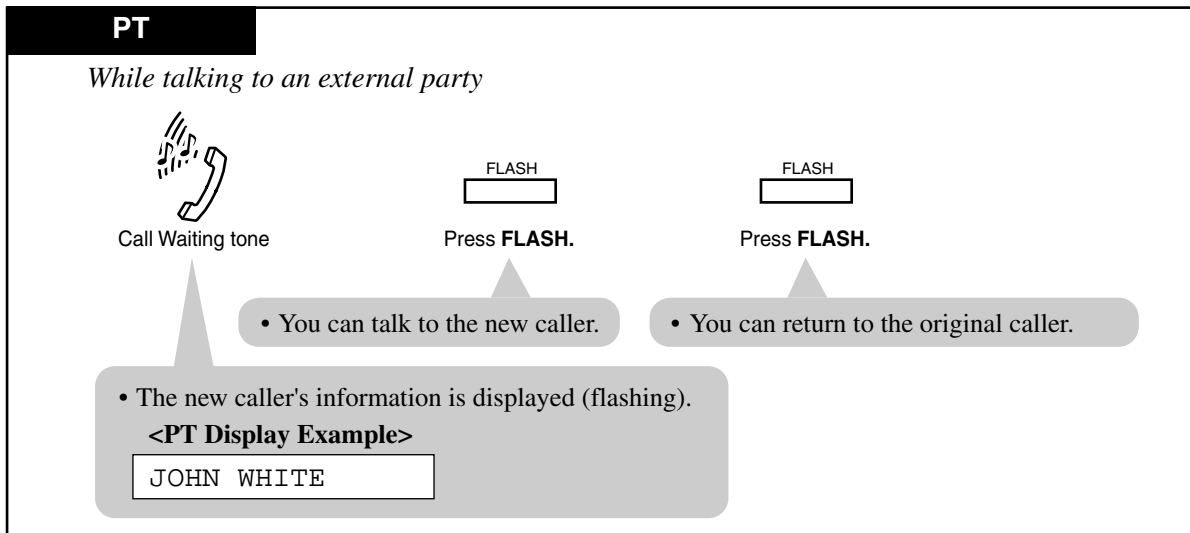

**To talk to the new party by terminating the current call**

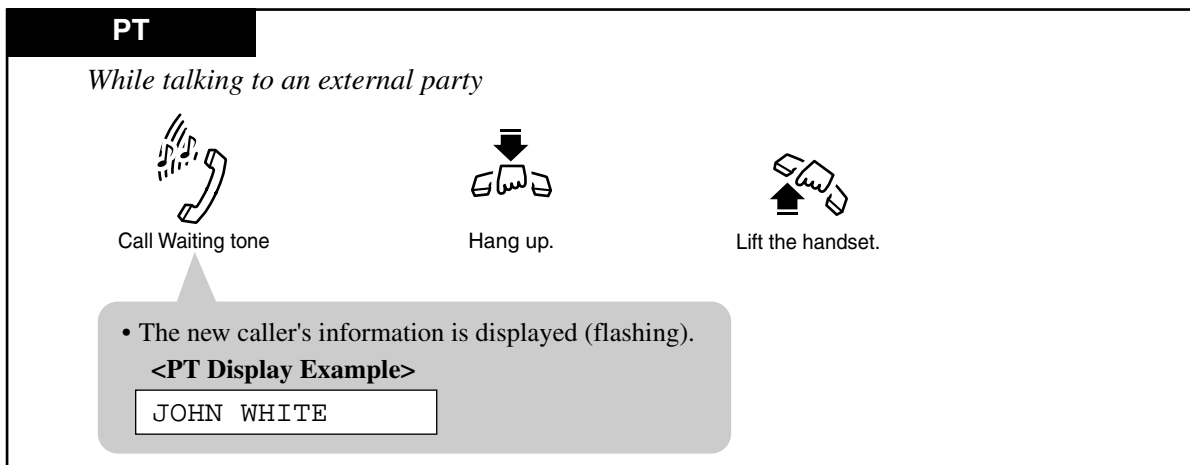

#### Conditions

- You can program the new caller information display timer. If you do not press the FLASH button while the information is displayed (flashing), the display stops flashing. In this situation, the caller information is automatically recorded in your personal area and your Caller ID Indication — Personal button indicator lights if the call has been directed to your extension. A call directed to multiple extensions (Direct In Lines [DIL] 1:N) is automatically recorded in the common area and all corresponding Caller ID Indication —

Common button indicators light. However in this case, if nobody has assigned the Caller ID Indication — Common button, the call information is recorded in an extension's personal area that is connected to the lowest jack number and the extension's Caller ID Indication — Personal button indicator lights.

- A contract with your Central Office may be required for the Caller Waiting service. Consult the Central Office for details.

### **Programming Guide References**

[221] Caller ID Call Waiting Time

[462] Caller ID Call Waiting Assignment

### **User Manual References**

4.3.19 Call Information / Log, Incoming

### 4.3.33 Camp-On Transfer to Phantom Extension / Ring Group

Allows you to transfer a call to busy phantom extensions or extensions in a Ring Group<sup>\*1</sup>. The call is transferred when at least one extension becomes free.

**PT**

*During a conversation;*

 Press **TRANSFER**.

 Confirmation tone

 Dial tone

or

Dial the destination **phantom extension number**.

Dial the **floating number of ringing group**.

 Busy tone

 Hang up or press **SP-PHONE/MONITOR**.

**SLT**

*During a conversation;*

 Flash the hookswitch.

 Confirmation tone

 Dial tone

or

Dial the destination **phantom extension number**.

Dial the **floating number of ringing group**.

 Busy tone

 Hang up or press **SP-PHONE/MONITOR**.

<sup>\*1</sup> A Ring Group is a station hunting type where all extensions in a ring group ring simultaneously by dialing the floating number of the extension group. For more details, please consult with your dealer.

### **Conditions**

- If the destination extension does not become free within twelve rings (default), "Transfer Recall" occurs. If the transferred call is an outside call, it is possible to select whether Transfer Recall will go to the initiating extension or to Operator 1 by System Programming.
- If there is no answer within thirty minutes after "Transfer Recall" starts, the line will be disconnected.

#### **<PT>**

- If you misdial, press the FLASH button, and re-enter the number.

#### **<SLT>**

- If you want to return to the held call, flash the hookswitch before the destination extension answers.

### **Programming Guide References**

[201] Transfer Recall Time

[990] System Additional Information

### **Feature Guide References**

Ring Group

### **User Manual References**

4.3.67 Phantom Extension

### 4.3.34 Conference

During a two-party conversation, you can add a third party to make a three-party conference. The members of a conference on a line may be three extensions, one extension and two outside lines, or two extensions and one outside line.

#### To establish a conference

**PT**

*During a two-party conversation;*

Press **CONF**. Confirmation tone and dial tone

Dial the **phone number** of the third party.

Talk to the third party.

Press **CONF**. Confirmation tone (optional)

A three-party conference is now established.

- The CONF indicator light turns steady red.
- The corresponding CO or INTERCOM indicator light turns green.

- You must dial a line access code (9 or 81 through 88) as the first digit when calling an outside party.

- The current party is placed on hold.
- The CONF indicator light flashes red slowly.

**SLT**

*During a two-party conversation;*

Flash the hookswitch. Confirmation tone and dial tone

Dial the **phone number** of the third party.

Talk to the third party.

Flash the hookswitch.

Dial **3**. Confirmation tone (optional)

A three-party conference is now established.

- You must dial a line access code (9 or 81 through 88) as the first digit when calling an outside party.

- The other party is placed on hold.

### To leave the conference

**Any Telephone**



Hang up or press SP-PHONE.

- The other two parties may continue their conversation.
- If both other two parties are on outside lines, they will be disconnected.

### To terminate one party and talk to the other

**PT**

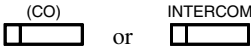

Press the **CO** or **INTERCOM** of the party to remain connected.



Confirmation tone (optional)



Talk.

- A conversation with the desired party is established and the other party is disconnected.
- This operation is available only when the extension user established the conference call by using two different line access buttons. (Not available when only one button is used.)

### To talk to the third party while holding the original party

**PT**



Press **TRANSFER**.



Confirmation tone (optional)



Talk to the third party.

- If both other two parties are extensions, the INTERCOM indicator light flashes green moderately.



### To talk to the original party while holding the third party

SLT



Flash the switchhook.



Confirmation tone  
(optional)



Talk to the original party.

### To put both parties on hold

PT

HOLD

Press **HOLD**.

- This feature is only available when at least one party is on an outside line.

### Conditions

- Up to six conference calls are allowed simultaneously.
- Executive Busy Override, Privacy Release**  
A 3-party conference call is also established by Executive Busy Override or Privacy Release.
- Confirmation tone**  
When a 2-party call is changed to a 3-party conference call or vice versa, a confirmation tone is sent to all three parties. Eliminating the tone is programmable.

#### <PT>

- Pressing a CO button which is not in the conference, allows you to exit from the conference leaving the other two parties connected unless they both are on outside lines. If they both are on outside lines, they will be disconnected.
- You can return to the original party before the third party answers by pressing the TRANSFER button.

#### <SLT>

- You can return to the original party before the third party answers by flashing the hookswitch.

### Programming Guide References

[990] System Additional Information

## **User Manual References**

- 2.2.2 Flexible Button Assignment
- 4.3.35 Conference, Unattended [PT only]
- 4.3.43 Executive Busy Override — Extension
- 4.3.44 Executive Busy Override — Outside Line [PT only]
- 4.3.69 Privacy Release [PT only]

### 4.3.35 Conference, Unattended [PT only]

When you are in a conference with two outside parties, you can leave the three-party conference allowing the other two parties to continue their conversation.

#### To establish an Unattended Conference

**PT**

*During a conversation with two outside parties;*

CONF  

Press **CONF** to leave the conference.

- An outside-to-outside line call between the other two parties is established.

#### To return to the conference

**PT**



(CO)  

Press **CO** flashing green moderately.

#### To answer Hold Recall (To return to the conference on the line)

**PT**

*While hearing Hold Recall;*

 or 

Lift the handset or press SP-PHONE.      Press **CO** button which is flashing rapidly.

#### Conditions

- When an Unattended Conference is established, an alarm tone is sent to both outside parties fifteen seconds before the assigned duration time limit (default: 10 min). "Hold Recall" is activated to the extension that leaves the conference fifty seconds before the time out. The call is disconnected at the time out unless the extension returns to the conference.
- If you are off-hook and hear "Hold Recall" during the Unattended Conference mode, the display flashes "CO 02 & CO 03", for example, for five seconds at fifteen second intervals.
- Whether an extension is able to establish a "Conference, Unattended" depends on the "Class of Service\*1" assignment.

### **Programming Guide References**

[206] Outside-to-Outside Line Call Duration Time

[503] Call Transfer to Outside Line

[601] Class of Service

### **Features Guide References**

Hold Recall

### **User Manual References**

4.3.34 Conference

---

\*1 Class of Service (COS) is used to define the features which are allowed for a group of extensions. Refer to "Class of Service (COS)" in the Features Guide.

## 4.3.36 Data Line Security

Your extension is protected against interruptions from the "Call Waiting", "Hold Recall", and "Executive Busy Override" features. Data communication devices, such as computers and facsimiles, operate uninterrupted.

### Setting / Canceling

Any Telephone



Lift the handset or press  
SP-PHONE/MONITOR.

7	3	0	1
To set.			
7	3	0	0
To cancel.			

To set: Dial **7301**.  
To cancel: Dial **7300**.



Confirmation tone  
and dial tone



Hang up or press  
SP-PHONE/MONITOR.

**<PT Display Example>**

- When setting:

Data Mode On

- When canceling:

Data Mode Off

### Conditions

- **Automatic Privacy**  
Assigning Data Line Security always offers conversation privacy unless Privacy Release is executed.
- If one extension in a conversation has set Data Line Security, it applies to the both extensions.

### Features Guide References

Hold Recall

### User Manual References

- 4.3.30 Call Waiting
- 4.3.44 Executive Busy Override — Outside Line [PT only]
- 4.3.43 Executive Busy Override — Extension
- 4.3.69 Privacy Release [PT only]

### 4.3.37 Direct Inward System Access (DISA)

Allows an outside caller to access specific system features as if the caller is an extension in the system. A DISA outgoing message is used to give outside callers assistance, such as listing the extension numbers in the system. The pre-assigned DISA user code may be necessary depending on the mode to have direct access to the features within the system.

#### Warning for the Direct Inward System Access Users

When you enable the Outside - Outside Line Call feature of **Direct Inward System Access (DISA) function**, if a third party discovers the password (a DISA User Code) of the system, you have a risk that they will make illegal phone calls using your telephone line, and the cost may be charged to your account.

In order to avoid this problem, we strongly recommend the following points:

- 1: Carefully maintain the secrecy of the password.
- 2: Specify a complicated password as long and random as you can make it.
- 3: Change the password frequently.

#### Calling an extension

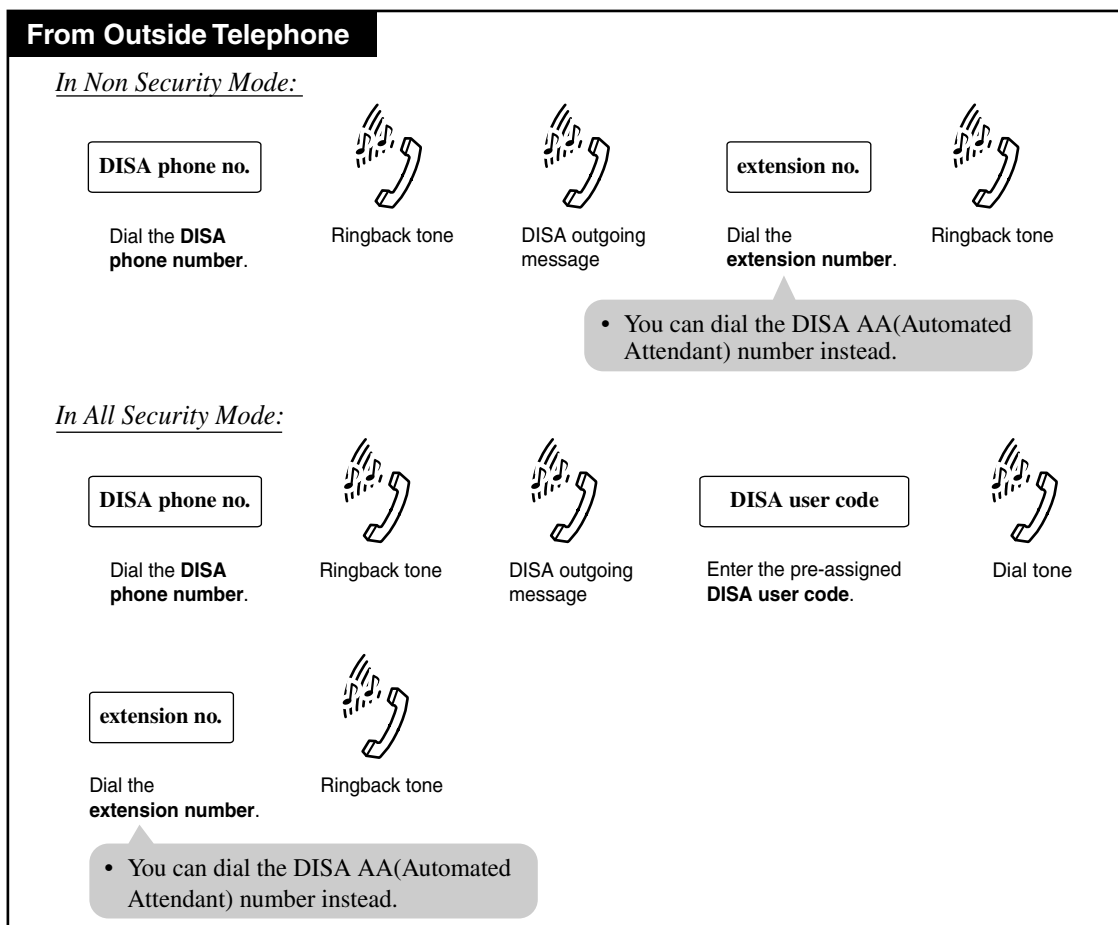

## Calling an outside party

### From Outside Telephone

#### In Non Security Mode:

**DISA phone no.**

Dial the **DISA phone number**.



Ringback tone



DISA outgoing message

**line access code**

Enter a **line access code** (9 or 81 through 88).

**phone no.**

Dial the **phone number** of the outside party.

#### In Outside Line Security Mode:

**DISA phone no.**

Dial the **DISA phone number**.



Ringback tone



DISA outgoing message

**line access code**

Enter a **line access code** (9 or 81 through 88).

**DISA user code**

Enter the pre-assigned **DISA user code**.

**phone no.**

Dial the **phone number** of the outside party.

#### In All Security Mode:

**DISA phone no.**

Dial the **DISA phone number**.



Ringback tone



DISA outgoing message

**DISA user code**

Enter the pre-assigned **DISA user code**.

**line access code**

Enter a **line access code** (9 or 81 through 88).

**phone no.**

Dial the **phone number** of the outside party.

## Extending the call duration while calling an outside line

### From Outside Telephone

*When you make a call to any outside line using the DISA feature, the line is disconnected after a preprogrammed time (default: 10 min). However, you can prolong your call by pressing a key. Your call is prolonged by a preprogrammed period of time (default: 3min).*

*You prolong a call an infinite number of times by default (this can be limited to ten times).*

**any key except "✖"**

Dial **any key except "✖"** after the warning tone.

## Re-try

From Outside Telephone

*It is possible (by System Programming) to dial a different number during a conversation with an outside party or while hearing a ringback, reorder, or busy tone.*

✖

Press ✖.

desired no.

Dial the **desired number**.

- You hear a dial tone.
- If you dial "✖" while hearing a DISA outgoing message, dial tone, or after the DISA outgoing message, the call will be disconnected.

- You must dial a line access code (9 or 81 through 88) when calling an outside party.

## Conditions

### Calling an extension

- You can choose Non Security or All Security mode. In All Security mode, the caller must enter a pre-assigned DISA user code to make intercom calls.
- If the DISA call is not answered within a specified period of time, the system redirects it to the pre-determined IRNA destination.  
If IRNA destination is not programmed, the DISA call continues to ring at the first destination extension.

### Calling an outgoing outside line

- You can choose Non Security, Outside Line Security or All Security mode. In Outside Line Security mode, the caller must enter a pre-assigned DISA user code to make outside calls. In All Security mode, the caller must enter a pre-assigned DISA user code to make both outside and intercom calls.

### General

- If the caller does not dial any digits during and after the playback of DISA outgoing message, the system will direct him or her to the pre-determined destination (Intercept Routing). "Intercept Routing" is activated 5 seconds after (default) or immediately after the playback depending on System Programming.
- **DISA User Code**  
You can store up to 32 programmable DISA user codes. These codes can have four to ten digits, and they must be unique. You can assign a "Class of Service" number to each code. The "Class of Service" appended to the code denies the "Toll Restriction". You can change your DISA User Code at any time. Refer to 3.2.5 [017] DISA User Codes.
- **DISA User Code Entry Failure**  
If the DISA caller fails to enter a valid DISA user code three times consecutively, the call will be disconnected.
- **DISA built-in Automated Attendant Number**  
This system supports up to ten programmable DISA built-in auto attendant numbers.



Each number must be one digit.

The DISA built-in auto attendant number may be the same as the first digit of other numbers (extension number, Floating Number, etc.). To avoid confusion, the system waits for the second digit for a pre-programmed amount of time (default: 1 s). If the second digit is not dialed until the timer expires, the system assumes that the first digit is a DISA built-in auto attendant number.

- **DISA Call Duration**

Extending the call duration can be enabled (from 1 to 7 minutes) or disabled by System Programming. The caller can extend the call duration up to 10 times, or as many times as the caller wants (no limit) depending on System Programming.

- **Outside-to-Outside Line Call Duration**

When the "Outside-to-Outside Line Call Duration Time" expires, both lines are disconnected unless the caller re-tries or extends the time (default: 3 min), if available. A warning tone is sent at five second intervals to both parties, fifteen seconds before the time limit.

## Programming Guide References

### <To enable DISA feature>

- [017] DISA User Codes
- [407-408] DIL 1:1 Extension — Day / Night
- [809] DISA Security Type
- [813] Floating Number Assignment
- [815] DISA Built-in Auto Attendant
- [990] System Additional Information

### <To set DISA timer values>

- [202] Call Forwarding — No Answer Time
- [206] Outside-to-Outside Line Call Duration Time
- [214] DISA Prolong Time
- [218] DISA AA Wait Time

### <To enable the Intercept Routing feature>

- [203] Intercept Time
- [409-410] Intercept Extension — Day / Night
- [990] System Additional Information

## Features Guide References

Intercept Routing

## User Manual References

- 3.2.5 [017] DISA User Codes
- 4.4.7 Outgoing Message (OGM)

### 4.3.38 Do Not Disturb (DND)

Allows you to prevent other parties from disturbing you. Your extension will not receive intercom and outside calls.

#### Setting / Canceling

PT and SLT



Lift the handset or press SP-PHONE/MONITOR.

FWD/DND

For PT

7

1

0

For SLT, PT

For PT: Press **FWD/DND**.  
For SLT, PT: Dial **710**.

1

To set.

0

To cancel.

To set: Dial **1**.  
To cancel: Dial **0**.



Confirmation tone and dial tone



Hang up or press SP-PHONE/MONITOR.

- When setting, the FWD/DND indicator lights.  
**<PT Display Example>**  

Do Not Disturb
- When canceling, the FWD/DND indicator light turns off.  
**<PT Display Example>**  

FWD/DND Cancel

#### Conditions

- DND also works for an incoming call from a doorphone.
- DND does not work for the following calls:**
  - Hold Recall
  - Timed Reminder Alarm Tone
- Do Not Disturb Override**  
An extension in DND mode can be called by other extension users who are allowed to override DND in their Class of Service.

#### <PT>

- An extension user may have only one type of Call Forwarding / Do Not Disturb feature in effect at any time. If one of Call Forwarding/Do Not Disturb feature is assigned, another does not function but the assignment itself is preserved for future use. The extension user can choose either one by pressing the FWD/DND button while on-hook. In this case, pressing the button changes the settings as follows:



- The lighting patterns of the FWD/DND button are as follows:  
 Off : Both functions are canceled  
 Red on : DND mode  This setting can be changed by System Programming.  
 Red flash : FWD mode

- A PT user in DND mode can answer a call by pressing a flashing button which shows the arrival of the call.

### **User Manual References**

- 2.2.2 Flexible Button Assignment
- 4.3.8 Call Forwarding — SUMMARY
- 4.3.39 Do Not Disturb (DND) Override

### 4.3.39 Do Not Disturb (DND) Override

You can override the "Do Not Disturb (DND)" feature set on the other extension, if permitted by System Programming beforehand.

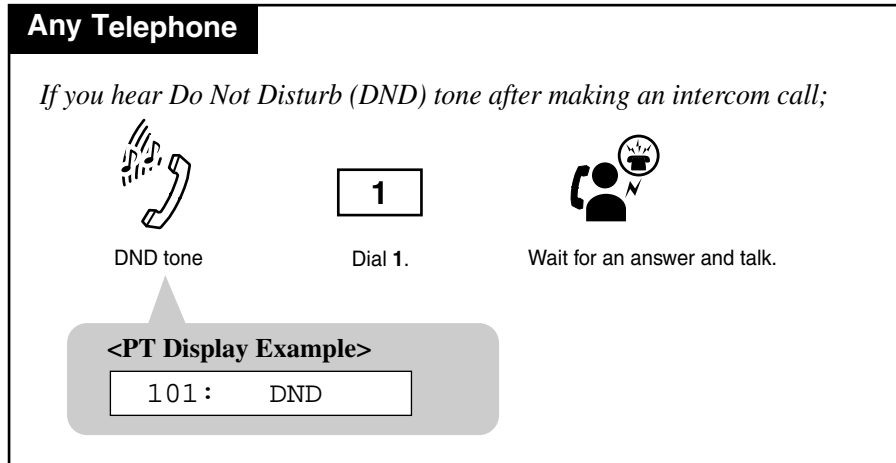

#### Conditions

- **Class of Service**  
Class of Service (COS) programming determines the extension that can perform this feature.
- If you hear a reorder tone after dialing 1, your extension is not permitted to execute "Do Not Disturb (DND) Override" feature by System Programming.
- **What if a busy tone is heard after DND override?**  
The other extension in DND mode is busy.  
In this case, you may perform the following features.
  - Automatic Callback (Camp-on)
  - Busy Station Signaling (BSS)
  - Executive Busy Override

#### Programming Guide References

[507] Do Not Disturb Override

[601] Class of Service

#### User Manual References

4.3.38 Do Not Disturb (DND)

## 4.3.40 Doorphone Call

Allows you to have a conversation with a visitor at your doorphone. You can also unlock the door from your telephone.

### Calling an extension from a doorphone — operation for a visitor

Doorphone

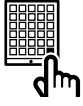

Press the Doorphone button for one second.



Wait for an answer and talk.

### Answering a doorphone call

Any Telephone

*When you hear the doorphone ring tone at the extension;*



Lift the handset or press SP-PHONE/MONITOR.

### Calling a doorphone

Any Telephone



Lift the handset or press SP-PHONE/MONITOR.

3

1

Dial 31.

doorphone no.

Enter a **doorphone number** (1 through 4).



Confirmation tone



Talk.

**<PT Display Example>**

Doorphone    x

doorphone number  
(1 through 4)

**To unlock the door from an assigned extension**

**Any Telephone**

Lift the handset or press SP-PHONE/MONITOR.

Dial **55**.

Enter a **doorphone number** (1 through 4).

Confirmation tone

Hang up or press SP-PHONE/MONITOR.

- The door is left unlocked for the preprogrammed amount of time (default: 5 s).

**<PT Display Example>**

Door 1 Open

door opener number (1 through 4)

**To unlock the door while talking to the visitor at the doorphone from any extension**

**PT**

Dial **5**.

Confirmation tone

Hang up or press SP-PHONE/MONITOR.

- The door is left unlocked for the preprogrammed amount of time (default: 5 s).

**<PT Display Example>**

Door 1 Open

door opener number

**SLT**

Flash the switchhook.

Confirmation tone and dial tone

Dial **5**.

Confirmation tone

- The door is left unlocked for the preprogrammed amount of time (default: 5 s).

## Conditions

- An optional Doorphone / Door Opener Interface Card and a doorphone are necessary for this feature.
- Doorphone 1 and Doorphone 2 cannot receive calls simultaneously when one is in use, an extension user cannot have a conversation with the other. This is the same for Doorphone 3 and Doorphone 4.
- If you dial "5" again while the door is open, the door will stay open for another five seconds.
- **Doorphone Call Destination**  
It is necessary to program the extensions that can receive doorphone calls during day and night mode.
- **What if a doorphone call is not answered?**  
If not answered within 30 seconds, the call stops ringing and is canceled. You can change from 30 seconds to 15 seconds by System Programming.
- **Unlocking the door opener**  
During a doorphone call, any extension user can unlock the door opener (user-supplied) from their extensions by dialing "5" to let the visitor in.
- You cannot hold and transfer the doorphone call.
- The door can be unlocked by the following:
  - 1) Extensions that are programmed to receive doorphone calls.
  - 2) Any extension that is engaged in a doorphone call.
- The door opener will open the door, even if a doorphone is not installed.
- You can modify the door opener time through System Programming.

### <PT>

- While talking to a doorphone, you can unlock the door using the one-touch dialing button instead of dialing "5". In this case, "5" must be stored in the one-touch dialing button by Station or System Programming.
- **Doorbell/Door Chime** (user-supplied)  
You can receive not only ringing but also chiming as a doorphone call by connecting a doorbell/door chime to the relay connected with a door opener, when a visitor presses a doorphone button.  
You can recognize which doorphone call is coming by assigning a distinctive chime pattern (8 patterns) to each doorphone. Also you can select the ringing way (Ring, Chime, Ring & Chime) for each doorphone. As for connection or programming, consult your dealer.

## Programming Guide References

- [607-608] Doorphone Ringing Assignment — Day / Night
- [820] Doorphone Ringing Time
- [821] Doorphone Ring/Chime Selection
- [822] Doorphone Chime Assignment
- [823] Doorphone Chime Pattern Selection
- [990] System Additional Information

## **User Manual References**

### 2.2.2 Flexible Button Assignment



## 4.3.41 Electronic Station Lockout

Allows you to lock your extension so that other users cannot make outgoing outside calls from your extension.

### Locking

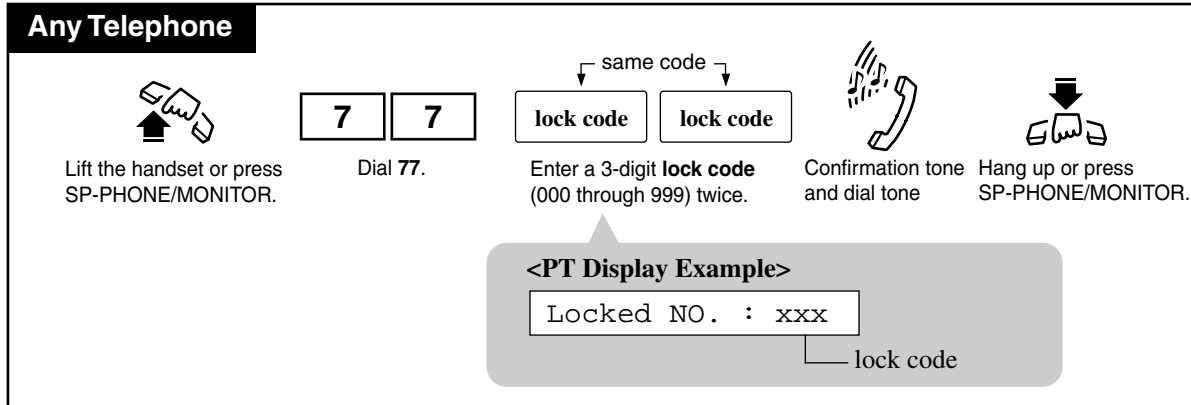

### Unlocking

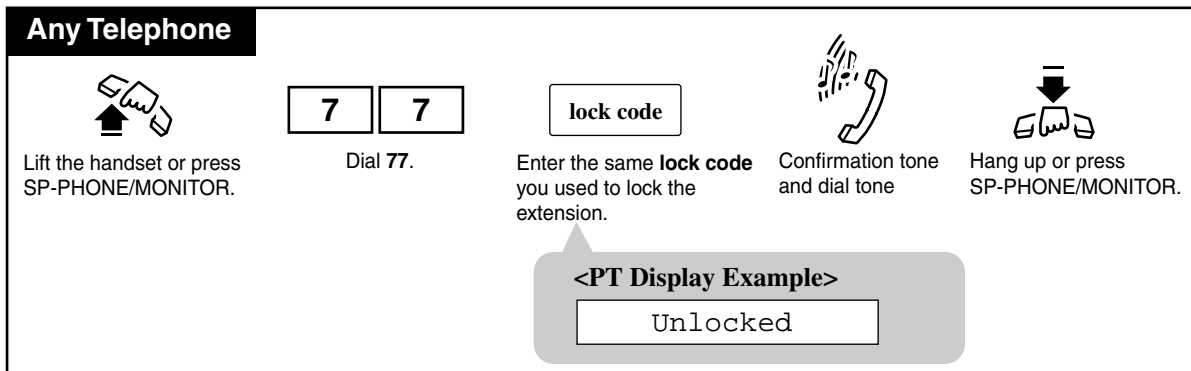

### Conditions

- **How does this feature restrict the extension?**  
This feature restricts the extension from making an outside call only. Other operations are not affected.
- **Remote Station Lock**  
Remote Station Lock Control overrides Electronic Station Lockout. If the Manager or an Operator sets Remote Station Lock on an extension that has already been locked by the extension user, the extension user cannot unlock it.

### <PT>

- If someone tries to make an outgoing outside call from a locked extension, he or she hears a reorder tone and "Restricted" is shown on the display.

**<SLT>**

- If another user tries to access an outside line from a looked extension, the user hears a reorder tone.

**User Manual References**

4.4.8 Remote Station Lock Control

## 4.3.42 Emergency Call

Allows you to dial out a pre-assigned emergency number after seizing an outside line regardless of the restrictions imposed on your extension. Up to 10 emergency dial numbers can be stored in the system.

### Dialing

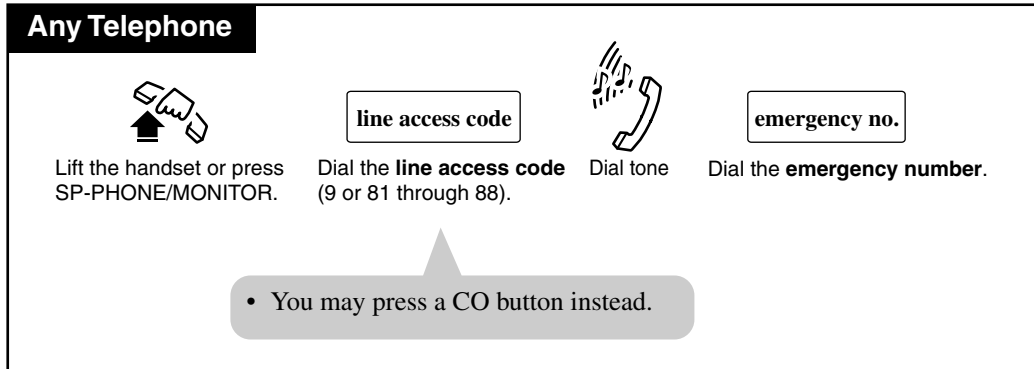

### Conditions

- The emergency number "911" is already stored at the factory. System Programming is required to store other emergency numbers.
- An emergency call is allowed even in the following cases;
  - in Account Code – Verified (All Calls, Toll Restriction Override) mode
  - in any toll restriction level
  - in Electronic Station Lockout / Remote Station Lock
- If your telephone is connected to a host PBX, you must dial the host PBX line access code after dialing the line access code and it must be included as the first digit of the emergency no.

### Programming Guide References

[334] Emergency Dial Number Set

### 4.3.43 Executive Busy Override — Extension

You can interrupt an existing extension call (either between two inside parties or between an outside party and an inside party) by dialing "2". This establishes a 3-party conference call.

<b>Any Telephone</b>		
<i>If you hear a busy tone after making an intercom call;</i>		
<div style="border: 1px solid black; padding: 2px; display: inline-block;">2</div>		<u>A three-party conference is now established.</u>
Dial 2.	Confirmation tone (optional)	

#### To leave the conference

<b>Any Telephone</b>	
	<u>The other two parties continue their conversation.</u>
Hang up or press SP-PHONE.	

#### To terminate one party and talk to the other

<b>PT</b>		
<div style="display: flex; align-items: center; gap: 10px;"> <div style="border: 1px solid black; padding: 2px;">(CO)</div> <span>or</span> <div style="border: 1px solid black; padding: 2px;">INTERCOM</div> </div>		
Press the <b>CO</b> or <b>INTERCOM</b> of the party to remain connected.	Confirmation tone (optional)	

#### Conditions

- **Class of Service**  
Class of Service programming determines the extension that can perform this feature.
- This feature does not work when "Data Line Security" or "Executive Busy Override Deny" is set at either or both of the other parties.
- **Executive Busy Override Deny**  
It is possible for extension users (if allowed by Class of Service Programming) to prevent this feature from being executed by another extension user.
- **Confirmation tone**  
When a 2-party call is changed to a 3-party call and vice versa, a confirmation tone is sent to all three parties. This tone can be eliminated by System Programming.
- **Terminate one party and talk to the other**  
This feature can be performed only during conference with an outside party and inside party.

### **Programming Guide References**

[505] Executive Busy Override

[601] Class of Service

[990] System Additional Information

### **User Manual References**

4.3.34 Conference



4.3.36 Data Line Security

4.3.45 Executive Busy Override Deny

## 4.3.44 Executive Busy Override — Outside Line [PT only]

Allow you to connect to an existing outside call or add a third party to your existing conversation.



### Setting

PT		
		
Lift the handset or press SP-PHONE/MONITOR.	Press the red lit <b>CO</b> corresponding to the desired caller.	Confirmation tone (optional)
<u>A three-party conference is now established.</u>		

### To leave the conference

PT	
	<u>The other two parties continue their conversation.</u>
Hang up or press SP-PHONE/MONITOR.	

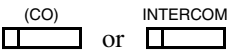
### To terminate one party and talk to the other

PT	
	
Press <b>CO</b> or <b>INTERCOM</b> of the party to remain connected.	Confirmation tone (optional)

### Conditions

- **Executive Busy Override Deny**  
Extension users can prevent this function from being executed by another extension user.
- **Class of Service**  
Class of Service programming determines the extension that can perform this feature.
- The pre-assigned extension users can interrupt an existing outside call even if access to that line is not allowed by System Programming.
- This feature does not work if Executive Busy Override Deny or Data Line Security is set at the extension engaged in the existing outside call.
- **Confirmation tone**  
When a 2-party call is changed to a 3-party call and vice versa, a confirmation tone is sent to all three parties. This tone can be eliminated by System Programming.

### **Programming Guide References**

[505] Executive Busy Override

[601] Class of Service

[990] System Additional Information

### **User Manual References**

4.3.34 Conference

4.3.36 Data Line Security

4.3.45 Executive Busy Override Deny

### 4.3.45 Executive Busy Override Deny

Allows you to prevent other extension users from interrupting your telephone conversation.

**Any Telephone**



Lift the handset or press  
SP-PHONE/MONITOR.

7	3	3	1	To set.
7	3	3	0	To cancel.

To set: Dial **7331**.  
To cancel: Dial **7330**.



Confirmation tone  
and dial tone



Hang up or press  
SP-PHONE/MONITOR.

**<PT Display Example>**

- When setting:  

Busy Ovrde Deny
- When canceling:  

Busy Ovrde Allow

#### Conditions

- **Class of Service**  
"Class of Service" programming determines the extensions that can perform this feature.

#### Programming Guide References

[506] Executive Busy Override Deny

#### User Manual References

- 4.3.44 Executive Busy Override — Outside Line [PT only]
- 4.3.43 Executive Busy Override — Extension



## 4.3.46 External Feature Access

Allows you to access special features (e.g., Call Waiting) offered by a host PBX, Centrex or Central Office. This feature is effective only during an outside call.

You can access the feature by using either the FLASH button or the feature number.

### Using the FLASH button

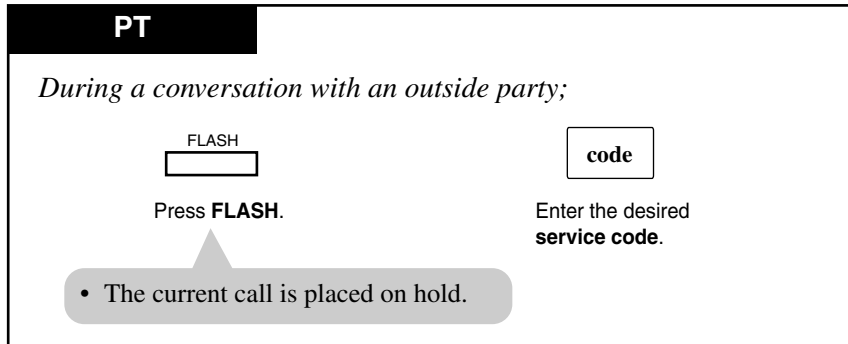

### Using the feature number

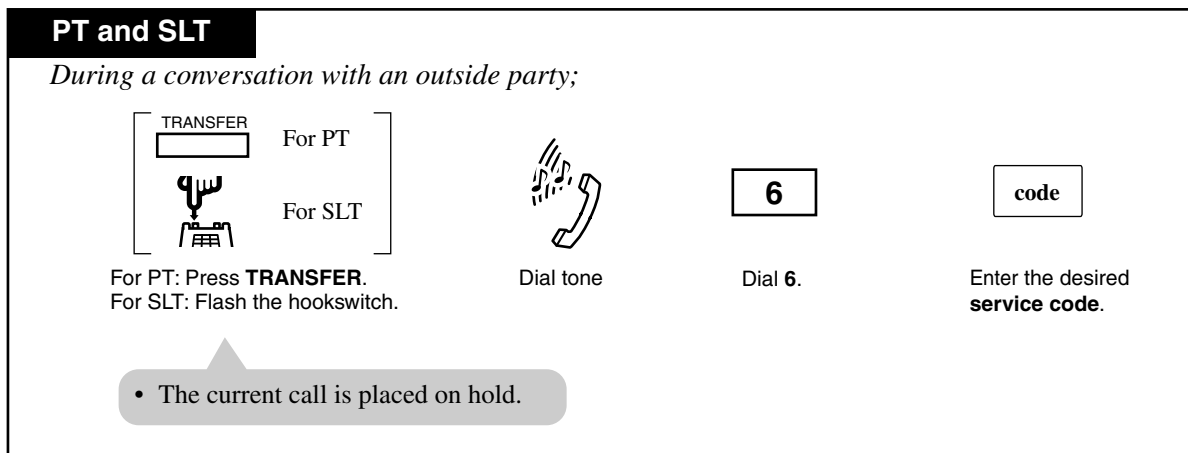

### Conditions

- Flash Time**

The flash time must be assigned as required by the Centrex, host PBX or outside line.

<PT>

- Memory Dialing**

During outside calls, a FLASH stored in System Speed Dialing or One-Touch Dialing works as External Feature Access, not as Flash (Disconnect Signal).

<SLT>

- This feature does not function, if an SLT has a call on Consultation Hold.

### Programming Guide References

[413] Flash Time

[990] System Additional Information

**User Manual References**

4.3.47 Flash [PT only]

## 4.3.47 Flash [PT only]

You can disconnect the current call and make another call without hanging up.

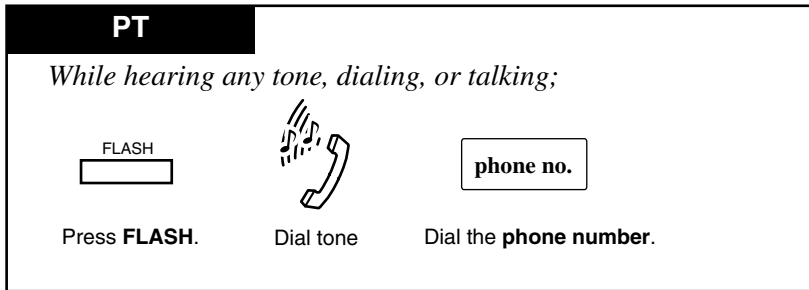

### Conditions

- A disconnection signal must be selected by System Programming in order to execute this feature.

### Programming Guide References

[414] Disconnect Time

[990] System Additional Information

### User Manual References

4.3.46 External Feature Access

### 4.3.48 Full One-Touch Dialing [PT only]

The hands-free speakerphone is automatically activated. You can enter a phone number or access a system feature with the touch of a button.

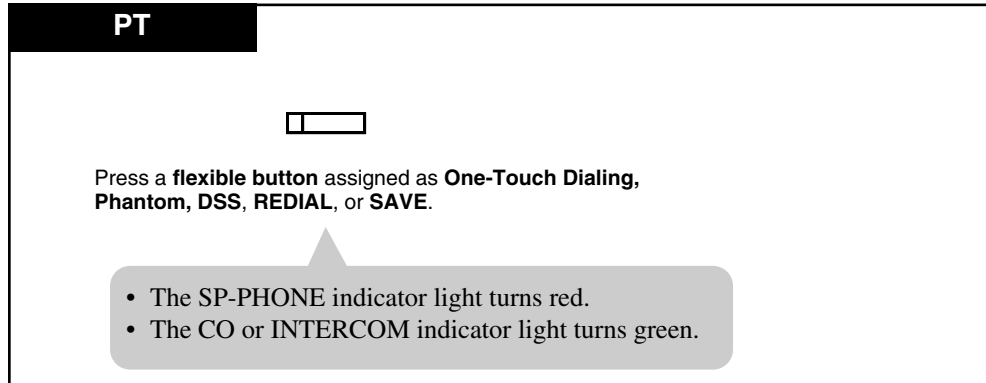

#### Conditions

- DSS buttons on a DSS Console can also activate this feature.
- This feature must be initially assigned by Station Programming (Full One-Touch Dialing Assignment).

#### User Manual References

- 2.2.1 Initial Settings
- 2.2.2 Flexible Button Assignment
- 4.3.58 One-Touch Dialing [PT only]
- 4.3.67 Phantom Extension
- 4.3.72 Redial, Last Number
- 4.3.73 Redial, Saved Number [PT only]

## 4.3.49 Hands-free Answerback [PT only]

You can answer an intercom call without lifting the handset.

### Setting

**PT**

*When the SP-PHONE and the AUTO ANSWER/MUTE indicator are off;*

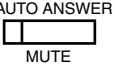

Press **AUTO ANSWER/MUTE**.

- The AUTO ANSWER/MUTE indicator turns on.

### Canceling

**PT**

*When the AUTO ANSWER/MUTE indicator is on;*

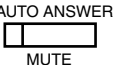

Press **AUTO ANSWER/MUTE**.

- The AUTO ANSWER/MUTE indicator turns off.

### Conditions

- **Ring/Voice Intercom Alerting Mode Override**  
This feature overrides the "Alternate Calling — Ring/Voice" feature. A hands-free conversation mode is established as soon as a confirmation tone is sent.
- This feature does not work for the following calls:
  - Outside calls
  - Doorphone calls
- When an outside call is transferred to your extension, this feature is overridden and a ringing tone is heard.
- This feature is not available for KX-T7050 and KX-T7055.

### User Manual References

- 4.3.3 Alternate Calling — Ring / Voice

### 4.3.50 Hands-free Operation [PT only]

You can answer an intercom call without lifting the handset.

#### Setting

**PT**

SP-PHONE



Press **SP-PHONE**.

- The microphone and speaker are now activated and the hands-free operation is available.

#### Switching from the handset to hands-free mode

**PT**

SP-PHONE



Press **SP-PHONE**.



Hang up.

- Do not replace the handset without pressing the SP-PHONE button first, or the line will be disconnected.

#### Switching from hands-free to the handset mode

**PT**



Lift the handset.

#### Conditions

- The hands-free mode is canceled if you do not start dialing within 10 seconds.
- The KX-T7050 and KX-T7055 have a MONITOR button instead of a SP-PHONE button. It can be used for hands-free dialing, etc., but not for a hands-free conversation.
- You can enable hands-free mode by pressing a CO or INTERCOM button without going off-hook.
- When "Full One-Touch Dialing" is enabled, pressing a One-Touch Dialing, DSS, Phantom, REDIAL or SAVE button provides the hands-free mode.

### **Helpful hints**

- Use this unit in a quiet room for best performance.
- If the other party has difficulty hearing you, decrease the volume.
- If you and the other party speak at the same time, parts of your conversation will be lost. To avoid this, speak alternately.

### **User Manual References**

4.3.48 Full One-Touch Dialing [PT only]

## 4.3.51 Intercom Calling

You can make a call to another extension user within the system or a tenant.

### Using the handset

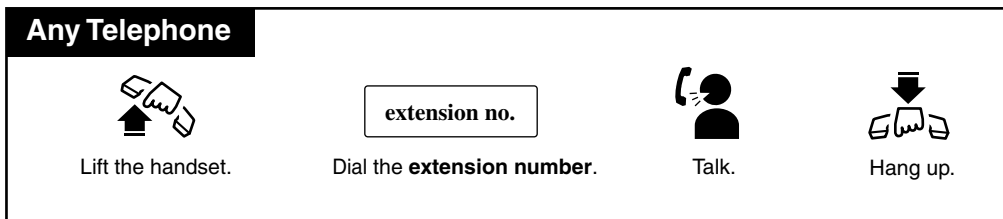

### Using the Speakerphone

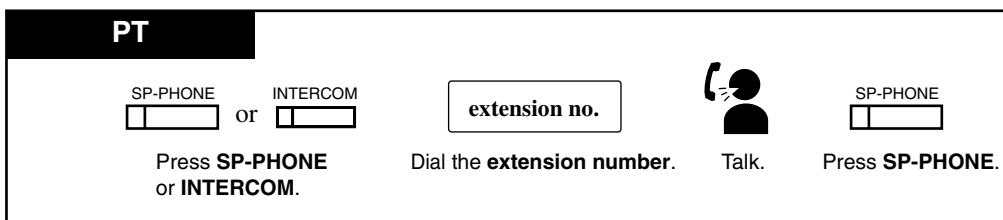

### Using a DSS (Direct Station Selection) button

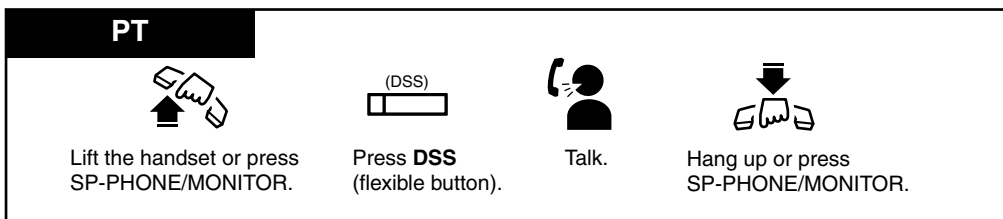

### Conditions

- **Extension Number Assignment**  
Extension numbers are assigned to all extensions according to [003] Extension Number Set in the Programming Guide.
- **Call Progress Tone**  
After dialing an extension number, you will hear one of the following tones:  
**Ringback tone:** Indicates the destination extension is being called.  
**Confirmation tone:** Indicates you can perform voice calling (e.g., Paging).  
**Busy tone:** Indicates the destination extension is busy.  
**Do Not Disturb (DND) tone:** Indicates the destination extension has set the "Do Not Disturb (DND)" feature.

#### <PT>

- You can assign a DSS button on a proprietary telephone (PT) or DSS Console by Station, User or System Programming.
- Extension names can be given to all extensions by User or System Programming. An extension number and a name, if programmed, are shown on the display PT during an intercom call.



### **Programming Guide References**

[003] Extension Number Set

[004] Extension Name Set

### **User Manual References**

2.2.2 Flexible Button Assignment

3.2.3 [003] Extension Number Set

3.2.4 [004] Extension Name Set

### 4.3.52 Live Call Screening (LCS) [PT only]\*<sup>1</sup>

When you have set a Voice Mail extension as the Call Forwarding destination and have activated the LCS feature, you can monitor a message while a caller is leaving the message in your mailbox. If desired, you can answer the call while monitoring. There are two methods available. In both modes, if you are currently having a conversation, you will hear a Call Waiting tone.

**Hands-free mode:** You can monitor a message automatically through the telephone speaker at the same time.

**Private mode:** You will hear an alert tone while the caller is leaving a message.

#### Preparation

- Activating the LCS mode (System Programming)
- Assigning the LCS button (Station/System Programming)
- Selecting the mode, Hands-free or Private (Station Programming)
- Setting the Password (Feature Number/System Programming)
- Setting the LCS feature

---

\*<sup>1</sup> Available when the Advanced Hybrid System is connected to a Proprietary Telephone capable Panasonic Voice Processing System (one that supports DPT Integration; e.g., KX-TVS50).

**Flowchart of the Live Call Screening (LCS) Feature**

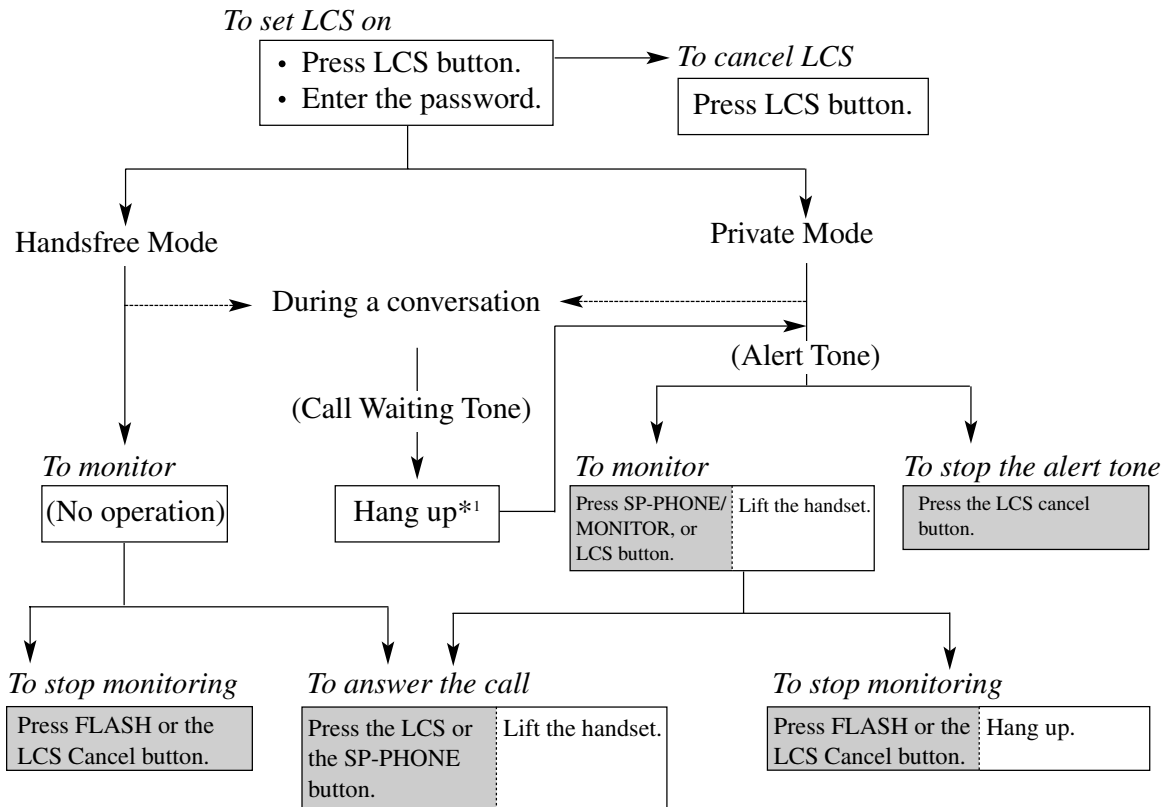

- \*1: To hold the current call, press the HOLD button.  
To return to the held call, press the CO button whose indicator light flashes green slowly.
- The shaded areas are for the Handsfree operation.

**Setting the password**

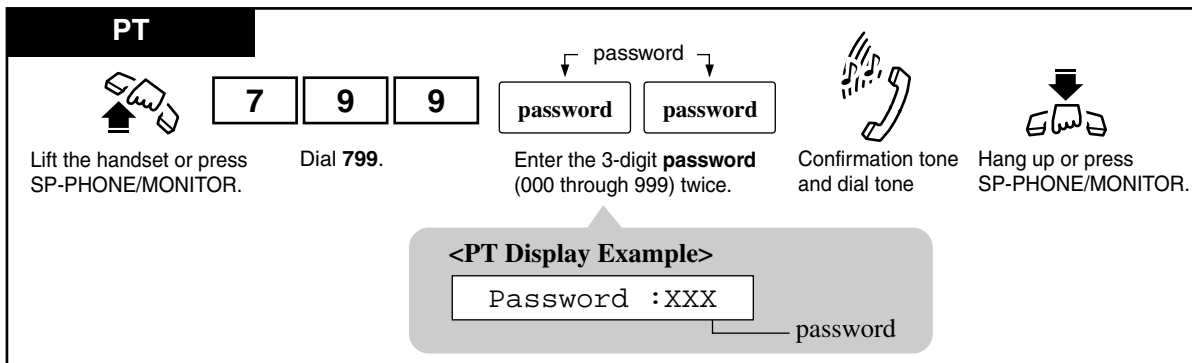

**Note**

In order to change the password, cancel the current password and then set a new password.

### Canceling the password

**PT**



Lift the handset or press SP-PHONE/MONITOR.

7

9

9

Dial **799**.

password

Enter the same **password** you used to set.



Confirmation tone and dial tone



Hang up or press SP-PHONE/MONITOR.

<PT Display Example>

Password Cancel

### Setting Live Call Screening

**PT**

*When the telephone is idle and on-hook;*

(LCS)

Press **LCS** (flexible button).

– In the Hands-free mode;  
<PT Display Example>

Live Call Screen

– In the Private mode;  
<PT Display Example>

- If a caller ID call is received at your extension, the display will show the caller's telephone number:

1 2 3 4 5 6 7

- In all other cases, the display will show:

Live Call Screen

password

Enter the **password**.

- The LCS indicator light turns on.

### Canceling Live Call Screening

**PT**

*When the telephone is idle and on-hook;*

(LCS)

Press **LCS** (flexible button).

- The LCS indicator light turns off.

**In the Hands-free mode:**

When callers are connected to your voice mailbox, the message recording is monitored automatically through your extension speaker. While monitoring in the Hands-free mode, the LCS indicator light flashes green slowly.

**Having a conversation with a party**

**PT**

Lift the handset or press SP-PHONE/MONITOR.

or Press **LCS** (flexible button).

- The LCS indicator light turns red from flashing green slowly.
- In Keep Recording mode, the Two-Way Record indicator turns on. Pressing the Two-Way Record button cancel the recording and the light turns off.

**Stopping the monitoring**

**PT**

Press **FLASH** or **LCS Cancel** (flexible button).

- The LCS indicator light turns red from flashing green slowly.

**In the Private mode:**

When callers are connected to your voice mailbox, an alert tone is sent. The LCS indicator light flashes green rapidly when a caller is connected to your voice mailbox. (When using a single line telephone, which is connected with a proprietary telephone in parallel, you hear ringing.)

**Stopping the alert tone**



**PT**

Press **FLASH** or **Live Call Screening Cancel** button.

- The LCS indicator light turns red from flashing green rapidly
- The alert tone stops.

### Monitoring the recording message

PT

or

or

Lift the handset or press  
SP-PHONE/MONITOR.



Press the flashing  
**LCS** (flexible button).

Press **INTERCOM**.

- The LCS indicator light flashes green slowly.
- To stop monitoring, lift the **handset**.  
The **FLASH** button or the **LCS Cancel** button can also be used to stop monitoring.  
The LCS indicator light turns red from flashing green slowly.

### Having a conversation with a party

PT

or

Lift the handset or press  
SP-PHONE/MONITOR.

Press the flashing  
**LCS** (flexible button).

- The LCS indicator light turns red from flashing green slowly.
- In Keep Recording mode, the Two-Way Record indicator lights.

### During a conversation with another party:

When the extension user is having a conversation, a call waiting tone is sent. The LCS indicator light flashes green rapidly.

- If you want to terminate the current call

### Monitoring

PT



Hang up or press  
SP-PHONE/MONITOR.

- An alarm tone is sent.



Lift the handset or press  
SP-PHONE/MONITOR.

- Monitoring Starts.

### Having a conversation with a party

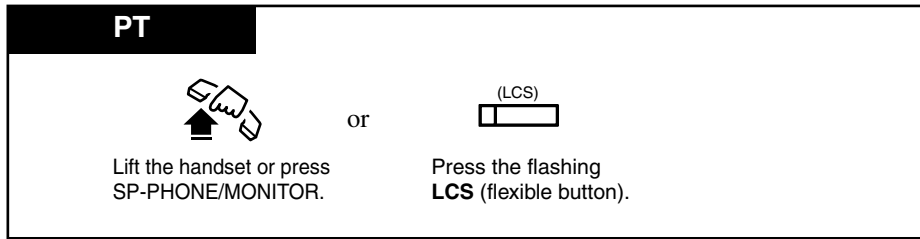

- If you want to hold the current call

### Monitoring

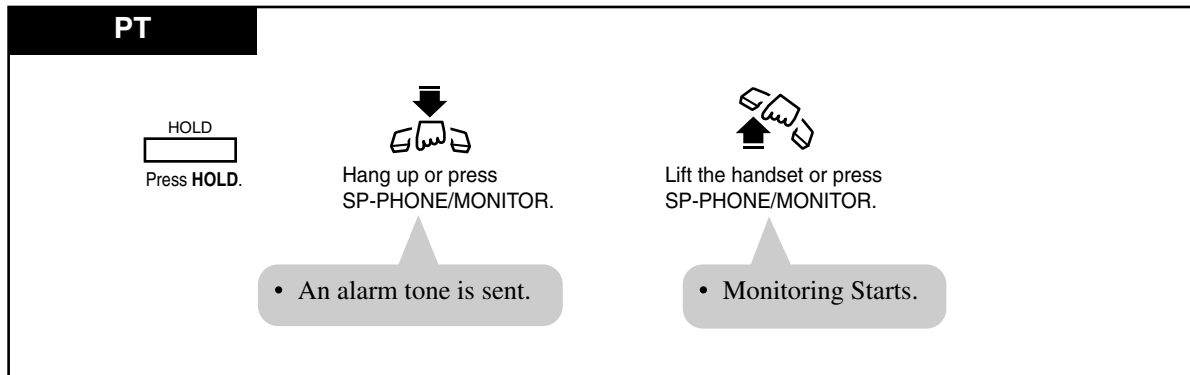

### Having a conversation with the party

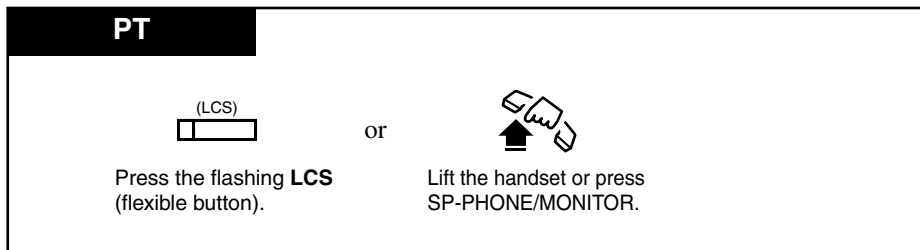

### Conditions

- The LCS indicator shows the feature status as follows.
  - Red (steady) : The Live Call Screening mode is on.
  - Off : The Live Call Screening mode is off.
  - Flashing green slowly : Live Call Screening is acting.\*1
  - Flashing green rapidly : Alarm tone is ringing in the Private mode.\*1
- The Two-Way Record indicator shows the feature status as follows.
  - On : Recording the conversation
  - Off : Not recording

\*1 The DSS button indicator lights red steady while Live Call Screening is active.

- During Keep Recording mode, if you want to stop recording the conversation, press the Two-Way Recording button.
- An incoming call via a voice mail service can be monitored by the LCS feature while the caller is leaving a message in your mailbox even when you have not set a Voice Mail extension as the Call Forwarding destination.
- **Call Waiting**  
If the extension user is busy on a call when a caller begins to leave a message, a call waiting tone is sent (if programmed beforehand). The extension user can put the current call on hold before accessing LCS.
- **LCS button/LCS Cancel button**  
A flexible CO and DSS button can be assigned as an LCS/LCS Cancel button.
- **LCS Password Clear**  
To prevent unauthorized monitoring, a 3-digit password must be set by the extension user. If the user forgets their password, it can be cleared by the Manager extension or an Operator.

### **Programming Guide References**

[610] Live Call Screening Recording Mode Assignment

### **User Manual References**

- 2.2.1 Initial Settings
- 2.2.2 Flexible Button Assignment
- 4.3.84 Voice Mail Integration
- 4.4.6 Live Call Screening Password Control



### **4.3.53 Lockout**

If one party in a conversation goes on-hook, they both are disconnected from the speech path automatically. A reorder tone is sent to the off-hook party before it is disconnected. No operation is necessary.

## 4.3.54 Log-In / Log-Out





Allows you to assign the Log-In mode or Log-Out mode within a hunting or ring group. When in the Log-Out mode, you can leave the group temporarily, preventing hunting calls from being sent to your extension. The lightning patterns of the Log-In / Log-Out button and status are as follows.

**Off** : Log-In mode

**Red** : Log-Out mode

### Log-In / Log-Out (Using the Log-In / Log-Out button)

**PT**

 Lift the handset or press SP-PHONE/MONITOR.	<p>(Log-In/Log-Out)</p>  Press <b>Log-In/Log-Out</b> (flexible button).	 Confirmation tone and dial tone	 Hang up or press SP-PHONE/MONITOR.
---	--	---	--

- The Log-In/Log-Out indicator light turns off in Log-In mode or turns steady red in Log-Out mode.

## Log-In / Log-Out (Using the feature number)

Any Telephone



Lift the handset  
or press  
SP-PHONE/MONITOR.

4	5	1
To Log-In.		
4	5	0
To Log-Out.		

For Log-In mode: Dial **451**.  
For Log-Out mode: Dial **450**.



Confirmation tone  
and dial tone



Hang up or press  
SP-PHONE/MONITOR.

**<PT Display Example>**

Log-in

or

Log-out

### Conditions

- By default, all extensions in the group are in "Log-In" mode.
- When extensions are logged out, calls directed to the above mentioned group do not come in on their extension.  
However, calls directed to their individual extension (extension call, DIL 1:1, DIL 1:N, etc.) still ring at their extension.

### <PT>

- **Log-In/Log-Out button**  
The Log-In/Log-Out button can be assigned to a flexible CO button.

### Programming Guide References

[990] System Additional Information

### Features Guide References

Station Hunting

Ring Group

### User Manual References

2.2.2 Flexible Button Assignment

### 4.3.55 Message Waiting

When the called extension or phantom extension is busy or does not answer your call, you can leave a notification so that the called party may call you back.

As a message receiver, the MESSAGE button light and an indication tone which you will hear when going off-hook let you know that a call has been received. If you receive notification, you can call back the original party with a simple operation. If required, you can assign a Flexible CO button as the Another Extension Message Waiting button or the Phantom Extension Message Waiting button by program "[005] Flexible CO Button Assignment". For details, consult your dealer or manager.

#### Setting

**Any Telephone**



Lift the handset or press SP-PHONE/MONITOR.

7

0

1

Dial 701.

extension no.

 or 

phantom extension no.

Dial the **extension number** or the **phantom extension number** where you left a message notification.



Confirmation tone and dial tone



Hang up or press SP-PHONE/MONITOR.

**PT**

*If the called extension or phantom extension is busy or does not answer;*

MESSAGE

Press **MESSAGE**.



Confirmation tone and dial tone



Hang up or press SP-PHONE/MONITOR.

## Canceling

Any Telephone



Lift the handset or press  
SP-PHONE/MONITOR.

7

0

0

Dial **700**.

extension no.

or

phantom extension no.

Dial the **extension number** or the **phantom extension number** where you left a message notification.



Confirmation tone  
and dial tone.



Hang up or press  
SP-PHONE/MONITOR.

## Checking and Selecting a message notification by the receiver

Display PT

*If there is any message notification, the message waiting lamp, another extension message waiting lamp or phantom extension message waiting lamp (MESSAGE indicator) light will be on. When the telephone is idle and on-hook;*

MESSAGE

OR

MESSAGE

OR

MESSAGE

(Another Extension  
Message Waiting)

(Phantom Extension  
Message Waiting)

Press **MESSAGE** button, **Another Extension Message Waiting** button or the **Phantom Extension Message Waiting** button repeatedly until the desired message appears.

- The message notifications you received are shown on the display in the order they were received.

<PT Display Example>  
When Tony at extension 123 left a message notification:

123 : Tony

## Calling back the message notification sender

PT



Lift the handset or press  
SP-PHONE/MONITOR.



Dial tone 4\*, when  
a message has been  
received at your  
extension.

MESSAGE

OR

MESSAGE

OR

MESSAGE

(Another Extension  
Message Waiting)

(Phantom Extension  
Message Waiting)

Press **MESSAGE** button, **Another Extension Message Waiting** button or the **Phantom Extension Message Waiting** button.



Talk.

- If there are more than one message notification left on your extension, you can choose the desired message sender (display PT only).

- The message notification is cleared after the conversation.

\* One of the dial tones. Refer to the "Tone List" in the Appendix (Section 6).

Any Telephone



Lift the handset or press SP-PHONE/MONITOR.



Dial tone 4\*, when a message has been received at your extension.

7

0

2

Dial **702**.



Talk.

- The message notification is cleared after the conversation.

\* One of the dial tones. Refer to the "Tone List" in the Appendix (Section 6).

### Clearing all message notifications left on your extension

PT



Lift the handset or press SP-PHONE/MONITOR.



Dial tone 4\*, when a message has been received at your extension.

7

0

0

Dial **700**.

your extension no.

Dial your **extension number**.



Hang up or press SP-PHONE/MONITOR.

- All message notifications are cleared.

\* One of the dial tones. Refer to the "Tone List" in the Appendix (Section 6).

### Conditions

- The system supports a maximum of 128 simultaneous messages. Except these, up to 128 phantom messages can be recorded. If you try to set the 129th message, you will hear a reorder tone.
- Callback Order**  
If multiple message notifications are left at your extension, callback is executed in the order received.
- If you select a specific message to call back, callback is executed in the order received, starting with the one selected.
- VPS Integration**  
If VPS Integration is employed, a VM extension informs an extension that a message is left in his/her mailbox by turning on the MESSAGE lamp.  
The extension user can listen to the message in the mailbox simply by pressing the red lit MESSAGE lamp.

- Even if the MESSAGE buttons are neither provided nor assigned, dial tone 4<sup>\*1</sup> after going off-hook informs you if a message has been received at your extension. For single line telephone users, a special ring tone can be provided as notification.

### **Programming Guide References**

[005] Flexible CO Button Assignment

### **User Manual References**

2.2.2 Flexible Button Assignment

---

\*1 One of the dial tones.

### 4.3.56 Microphone Mute [PT only]

During a conversation in the hands-free mode, you can turn off your PT's microphone so that you can consult privately with others in the room. When you activate Microphone Mute, you can still listen to your caller's voice but your caller cannot hear your voice.

#### Setting

**PT**

*During a conversation in the hands-free mode;*

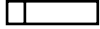
AUTO ANSWER  
  
MUTE

Press **AUTO ANSWER/MUTE**.

- The AUTO ANSWER/MUTE indicator light flashes red slowly.

#### Canceling

**PT**

*When microphone mute is established;*

AUTO ANSWER  
  
MUTE

Press **AUTO ANSWER/MUTE**.

- The AUTO ANSWER/MUTE indicator light turns off.

#### Conditions

- This feature is only available during a hands-free conversation.
- This feature is not available for KX-T7050 and KX-T7055.



### 4.3.57 Night / Day (Lunch / Break) Service

This system supports both the night and day modes of operation. The day mode includes the lunch and break modes. The system operation for originating and receiving calls can be changed depending on the mode. You can transfer received outside calls to assigned extension groups while in the lunch or break mode. Toll restriction calls can be programmed to prevent unauthorized toll calls at night. The Day/Lunch/Break/Night modes can be switched manually at any desired time by a pre-assigned extension user, operator or manager.

If the Night/Day button is assigned, its lighting patterns and status are as follows:

Off: Day/Lunch/Break mode

Red: Night mode

#### Switching Day/Night mode (Night/Day button operation)

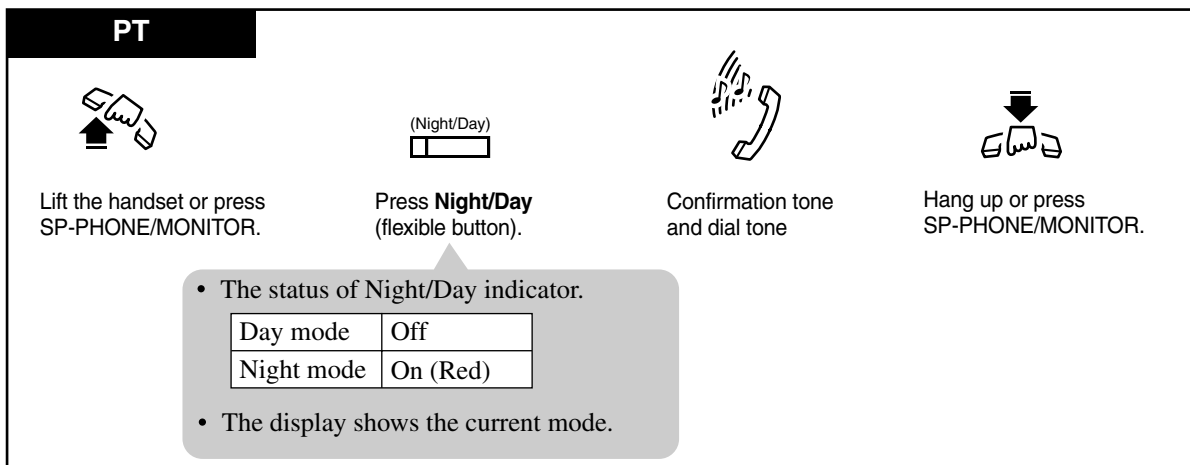

#### Switching Day/Night modes (Feature number operation)

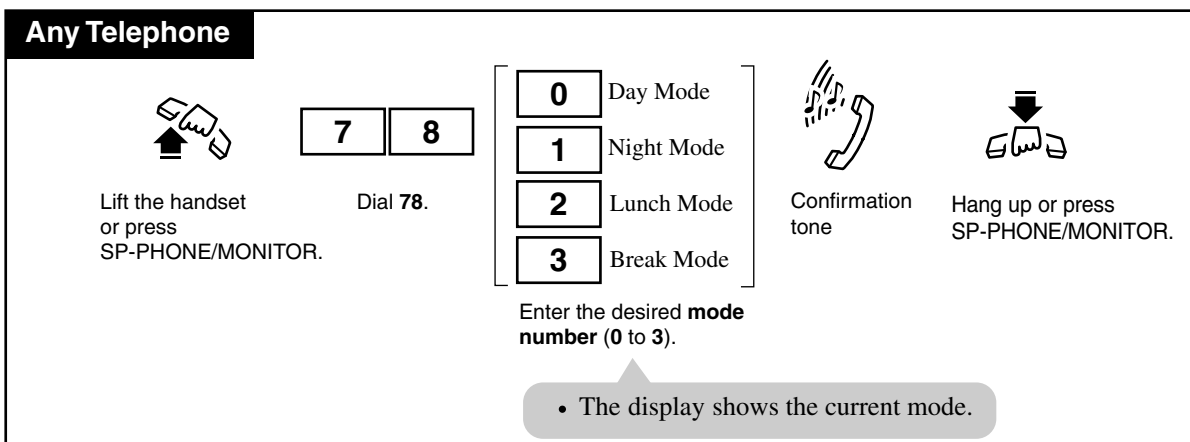

### Confirming the current mode

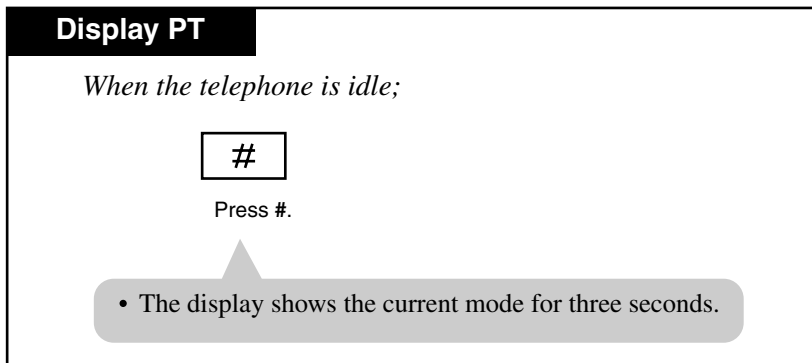

### Conditions

- The following items have separate day and night programming.
  - a) Outgoing Permitted Outside Line Assignment
  - b) Direct In Lines (DIL)
  - c) Doorphone Ringing Assignment
  - d) Extension Ringing Assignment
  - e) Ringing, Delayed
  - f) Toll Restriction Level
  - g) Intercept Routing
- In the lunch/break mode, the DIL 1:1 destination of [457-458] or [463-464] is effective; if it is not assigned, DIL 1:1 (Day)/DIL 1:N (Day) perform in the day mode as usual. Using feature numbers, you can go from day mode to any other mode. However, from night mode, you can only go to day mode.
- You can assign the Extension, Voice Mail, Phantom Extension, DISA or Extension Group as the DIL 1:1 destination in System Programming when a call arrives at the extension in the lunch/break mode.
- **Class of Service**  
Class of Service programming determines the extensions that can perform this feature.
- The Day/Lunch/Break/Night mode is automatically switched at a predetermined time (default: 9:00 a.m. for all days of the week; 12:00 p.m – 12:59 p.m for lunch; 3:00 p.m – 3:29 p.m for break; 5:00 p.m. for all nights of the week) if automatic switching mode is selected in System Programming.

<PT>

- A flexible CO and DSS button can be assigned as the Night/Day button.

### Programming Guide References

- [101] Day / Night Service Switching Mode
- [102] Day / Night Service Starting Time
- [150] Lunch Service Starting / Ending Time
- [151] Break Service Starting / Ending Time

- [407-408] DIL 1:1 Extension — Day / Night
- [457-458] DIL 1:1 — Lunch / Break Group
- [463-464] DIL 1:1 Extension — Lunch / Break
- [510] Night Service Access
- [620] Lunch / Break Group Assignment

### **Features Guide References**

- Direct In Lines (DIL)
- Intercept Routing
- Lunch / Break Service
- Night Service
- Outside Line Connection Assignment — Outgoing
- Ringing, Delayed
- Toll Restriction

### **User Manual Reference**

- 2.2.2 Flexible Button Assignment
- 4.3.40 Doorphone Call

## 4.3.58 One-Touch Dialing [PT only]

Allows you to make a call (intercom or outside) or access a system feature with the touch of a button. This is done by storing an extension number, telephone number or feature number (up to 16 digits) in a One-Touch Dialing button.

### Dialing

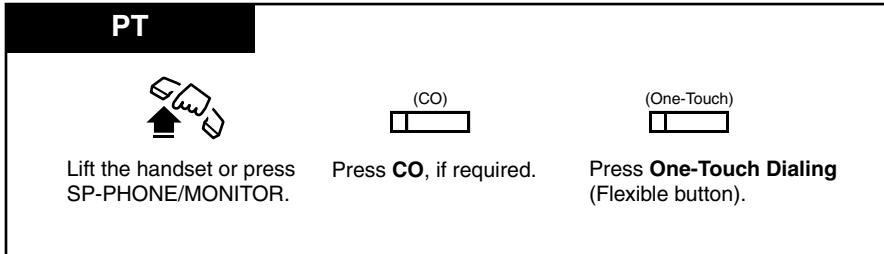

### Conditions

- One-Touch Dialing button can be programmed by Station, User or System Programming.
- If you store the telephone number of an outside party, a line access code (9, or 81 through 88) must be stored as the leading digit.
- You may press a CO button to select a desired outside line directly before pressing the One-Touch Dialing button.
- **Combination dialing**  
Speed Dialing, One-Touch Dialing, manual dialing, Last Number Redial and Saved Number Redial can be used in a combination.
- **Storing more than 16 digits number**  
It is possible to store a number consisting of 17 digits or more by dividing it and storing it in two One-Touch Dialing buttons. In this case, an outside line access code should be stored in the first button.
- **Full One-Touch Dialing**  
If "Full One-Touch Dialing" is enabled by Station Programming, you can press the One-Touch Dialing button directly without going off-hook.

### User Manual References

- 2.2.2 Flexible Button Assignment
- 4.3.48 Full One-Touch Dialing [PT only]

## 4.3.59 Operator Call

Allows you to call an operator within the system. Two extensions can be assigned as Operator 1 and 2.

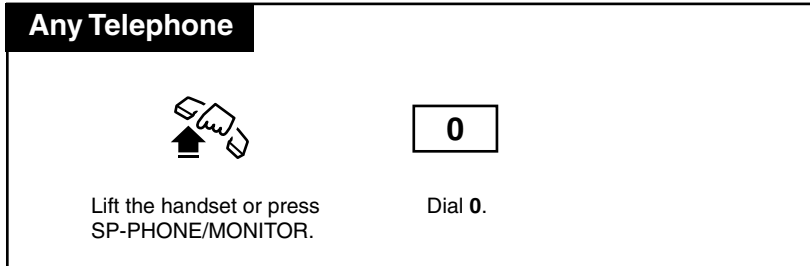

### Conditions

- If no operator is assigned, this feature is not available and you will hear a reorder tone after dialing the feature number.
- The call is routed to Operator 1 first. If Operator 1 is busy, then it is routed to Operator 2. Through System Programming, it is possible to change the routing so that Operator 1 and Operator 2 are called simultaneously when the operator is called.

### Programming Guide References

[990] System Additional Information

## 4.3.60 Outward Dialing, Line Access — SUMMARY

A CO line can be accessed in the following ways.

### <PT users>

<b>Line Access, Automatic</b>	Dial the <b>feature number (9)</b> . or Press a <b>Loop-CO (L-CO)</b> button
<b>Line Access, Outside Line Group</b>	Dial the <b>feature number (8)</b> and an <b>outside line group (1-8)</b> . or Press a <b>Group-CO (G-CO)</b> button.
<b>Line Access, Individual</b>	Press a <b>Single-CO (S-CO)</b> button.

### <SLT users>

<b>Line Access, Automatic</b>	Dial the <b>feature number (9)</b> .
<b>Line Access, Outside Line Group</b>	Dial the <b>feature number (8)</b> and an <b>outside line group number (1-8)</b> .

### Conditions

- The CO button assignment on your telephone can be re-arranged as required. Refer to 2.2.2 Flexible Button Assignment.
- After dialing the feature number or pressing the CO button, you will hear one of the following tones:

**Dial tone** : Indicates an idle outside line is accessed.

`COXX`

—is shown on the display. (xx: outside line number)

**Busy tone** : Indicates the selected outside line is busy.

`CO in use`

—is shown on the display.

**Reorder tone** :

1) Indicates the outside line you have attempted to access is not assigned.

`CO Not Assigned`

—is shown on the display.

2) Indicates access to outside lines is denied.

`Restricted`

—is shown on the display.

- `Restricted` may show on the display or if you hear a reorder tone, the call is restricted for one of the following reasons.

- The extension has been locked by the owner (Electronic Station Lockout) or the operator / manager (Remote Station Lock Control).
- The extension is restricted by the account code mode, "Verified - All Calls" or "Verified - Toll Restriction Override".
- The extension is restricted from making toll calls (Toll Restriction).

### Programming Guide References

- [103] Automatic Access Outside Line Assignment
- [400] Outside Line Connection Assignment
- [605-606] Outgoing Permitted Outside Line Assignment — Day / Night

### Features Guide References

- Toll Restriction

### User Manual References

- 2.2.2 Flexible Button Assignment
- 4.3.2 Account Code Entry
- 4.3.44 Executive Busy Override — Outside Line [PT only]
- 4.4.8 Remote Station Lock Control

### Line Access, Automatic

Allows you to select an available outside line automatically.

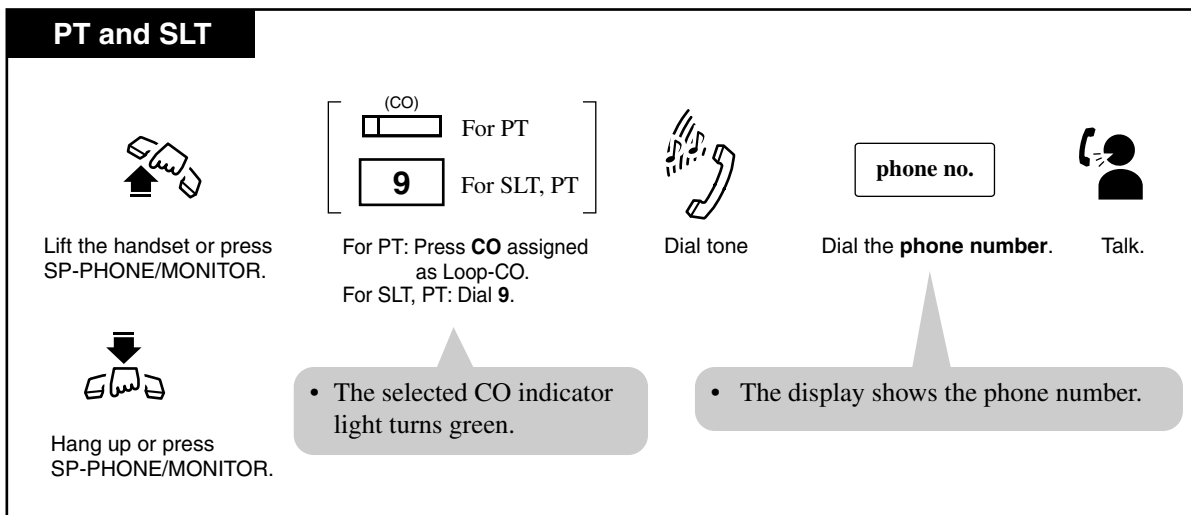

### Conditions

- You may press the L-CO button directly without first going off-hook.

### Line Access, Individual [PT only]

You can get an idle outside line for making a call by simply pressing a CO button (Single-CO) directly.

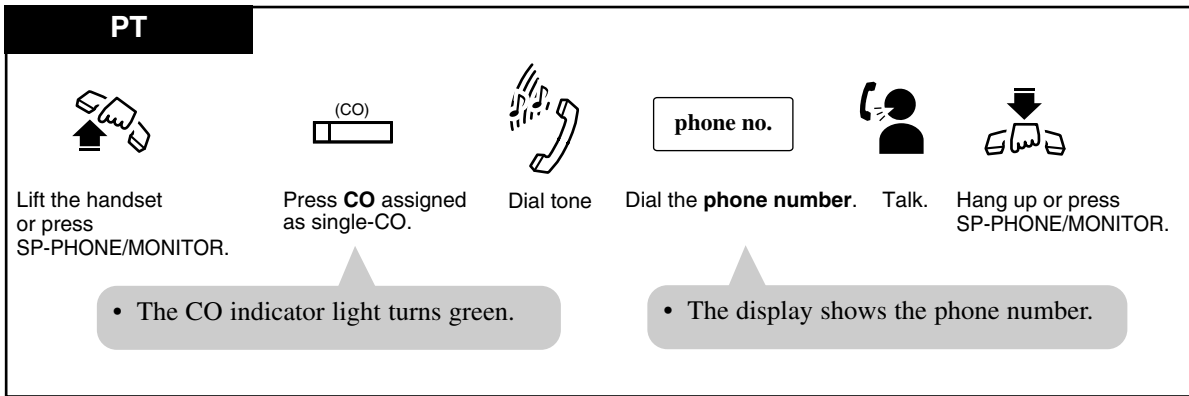

### Conditions

- You may press the CO button directly without first going off-hook.

### Line Access, Outside Line Group

Allows you to select an idle outside line within a designated trunk group. Through programming, outside lines can be divided into eight line groups.

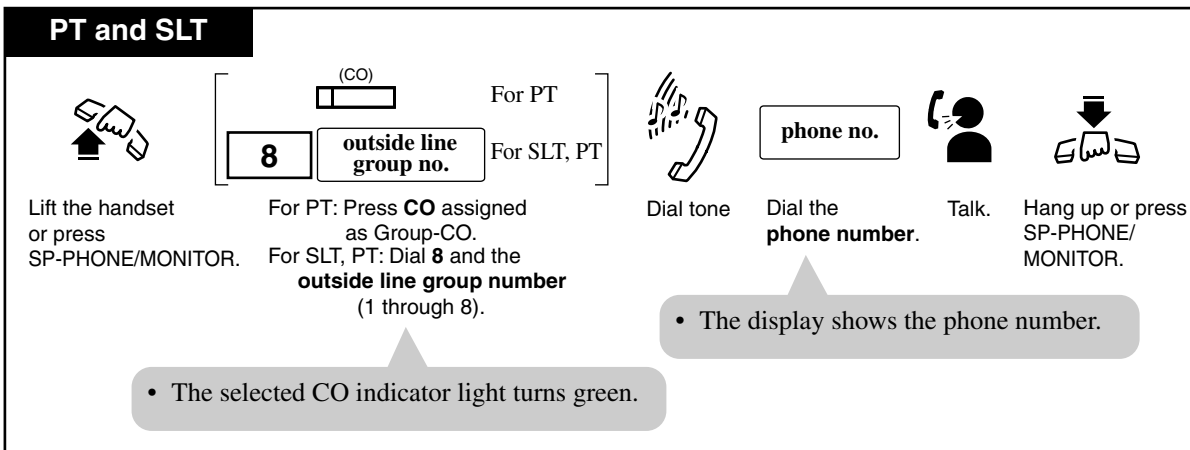

### Conditions

- You may press the G-CO button directly without first going off hook.



## 4.3.61 Paging — SUMMARY

Allows you to make a voice announcement to several people at the same time. Your message is announced over the built-in speakers of proprietary telephones (PT) and/or external speakers (External Pagers). The paged person can answer your page from a nearby telephone. There are three types of paging as shown below. You can select the appropriate type according to your needs.

Type	Description
Paging — All	Paging through both the built-in speakers of PTs and external pagers.
Paging — External	Paging through all of the external pagers simultaneously.
	Paging to a specific external pager.
Paging — Group	Paging to all paging groups simultaneously.
	Paging to a particular group of extensions through the built-in speakers of PTs.

### Conditions

- To answer the page, refer to 4.3.62 Paging — ANSWER.
- The paged extension users hear a confirmation tone before the voice announcement.
- A confirmation tone from external pagers (External Pager Confirmation Tone) is audible at the paged side, before the voice announcement. Eliminating the tone is programmable.
- A confirmation tone is sent to extension before making the voice announcement. Eliminating the tone is programmable by System Programming.

### <PT>

- To deny receiving the page, refer to 4.3.63 Paging — Deny [PT only].

### Programming Guide References

- [602] Extension Group Assignment
- [805] External Pager Confirmation Tone
- [990] System Additional Information

### User Manual References

- 4.3.62 Paging — ANSWER
- 4.3.63 Paging — Deny [PT only]

### Paging — All

Allows you to make a voice announcement to all extensions. Your message is announced over the built-in speakers of the proprietary telephones (PT) and external pagers.

**Any Telephone**

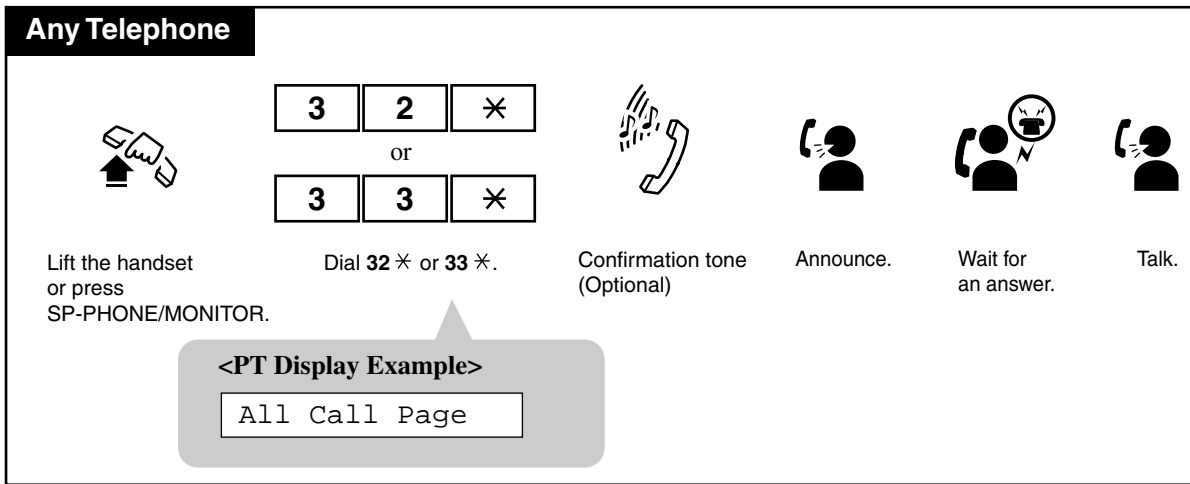

Lift the handset or press SP-PHONE/MONITOR.

Dial **3 2 \*** or **3 3 \***.

Confirmation tone (Optional)

Announce.

Wait for an answer.

Talk.

**<PT Display Example>**  
All Call Page

### Paging — External

Allows you to make a voice announcement over external pagers.

#### To access all external pagers

**Any Telephone**

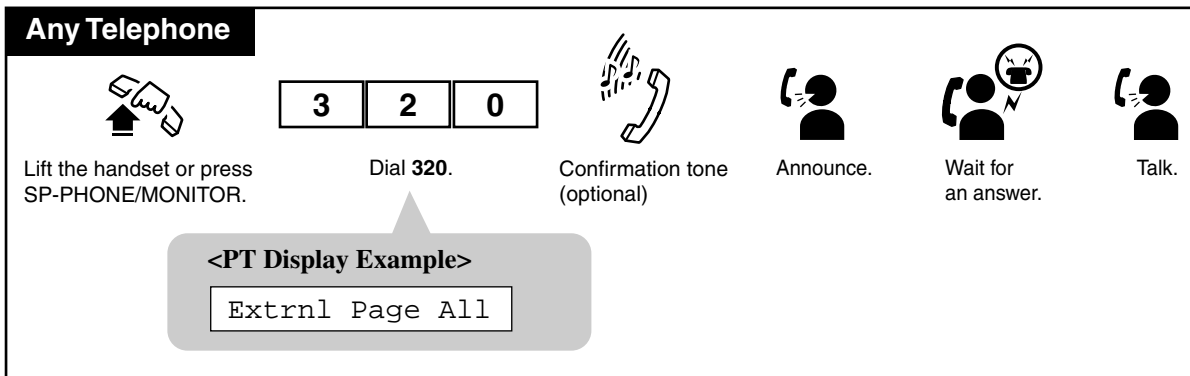

Lift the handset or press SP-PHONE/MONITOR.

Dial **3 2 0**.

Confirmation tone (optional)

Announce.

Wait for an answer.

Talk.

**<PT Display Example>**  
Extrnl Page All

### To access a particular pager

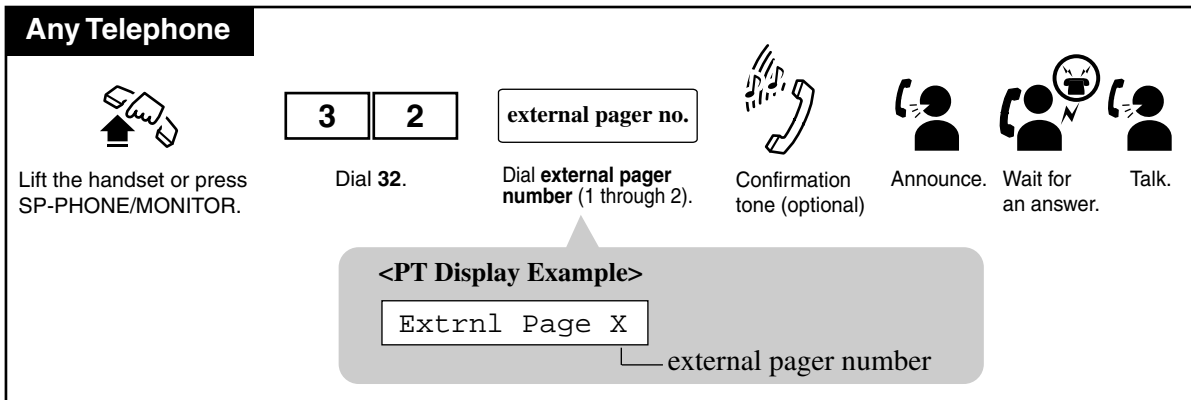

### Conditions

- If the designated pager is in use, a busy tone is heard.
- The paging priorities are as follows:
  - a) TAFAS (Trunk Answer From Any Station)
  - b) Paging – External
  - c) Background Music (BGM) – External

If a higher priority page is requested when a lower priority page is active, the higher priority overrides the lower one.

### User Manual References

- 4.4.2 Background Music (BGM) — External
- 4.3.82 Trunk Answer From Any Station (TAFAS)

## Paging — Group

You can make a paging announcement by selecting a particular paging group.

You can select a maximum of 8 paging groups simultaneously.

The announcement can only be heard through the built-in speakers of PTs.

### To access all paging groups (1-8) simultaneously

Any Telephone



Lift the handset or press  
SP-PHONE/MONITOR.

3	3	0
---	---	---

Dial **330**.



Confirmation tone  
(optional)



Announce.



Wait for an answer.



Talk.

<PT Display Example>

Group Page All
----------------

### To access a particular paging group

Any Telephone



Lift the handset or press  
SP-PHONE/MONITOR.

3	3	paging group no.
---	---	------------------

Dial **33**.

Enter the **paging group number**  
(1 through 8).



Confirmation tone  
(optional)



Announce.



Wait for an answer.



Talk.

<PT Display Example>

Group Page X
--------------

paging group number  
(1 through 8)



## Conditions

- There is a maximum of eight extension groups. "Paging – Group" to different groups can be performed simultaneously.
- The "Paging – Group" feature overrides Do Not Disturb (DND) at an extension.



## 4.3.62 Paging — ANSWER

Allows you to answer an announced page at any extension within the system.

### Answering a page sent through a built-in speaker

Any Telephone					
	<table border="1"><tr><td>4</td><td>3</td></tr></table>	4	3		
4	3				
Lift the handset or press SP-PHONE/MONITOR.	Dial <b>43</b> .	Confirmation tone (optional)	Talk.		

### Answering a page sent through a particular external pager

Any Telephone							
	<table border="1"><tr><td>4</td><td>2</td></tr></table>	4	2	<table border="1"><tr><td>external pager no.</td></tr></table>	external pager no.		
4	2						
external pager no.							
Lift the handset or press SP-PHONE/MONITOR.	Dial <b>42</b> .	Dial <b>external pager number</b> (1 through 2).	Confirmation tone (optional)	Talk.			

### Conditions

- Only extensions within the paged group can answer "Paging — Group".
- A confirmation tone is audible when the page is answered. Eliminating the tone is programmable by System Programming.

### Programming Guide References

[990] System Additional Information

### 4.3.63 Paging — Deny [PT only]

Allows you to deny receiving paging announcement through the built-in speakers of your telephone.

#### Setting

**PT**

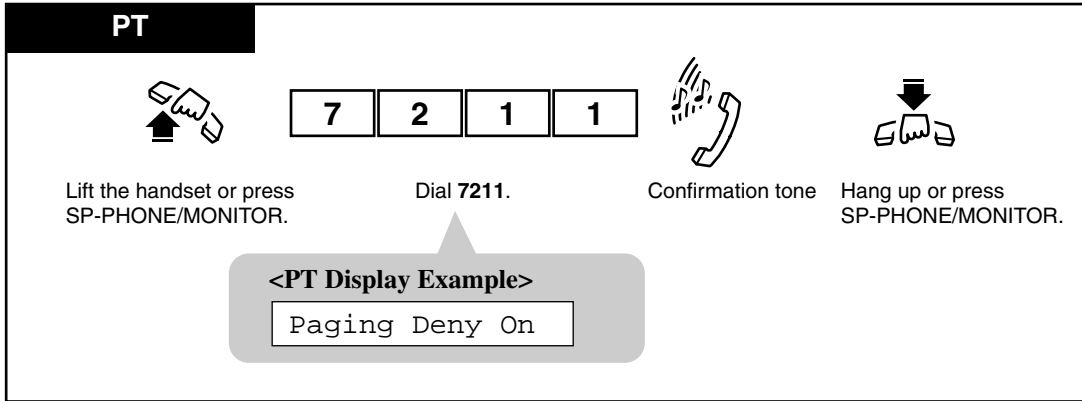

The diagram illustrates the steps to set 'Paging Deny On'. It features a central sequence of four boxes containing the digits 7, 2, 1, and 1. To the left, an icon of a handset being lifted is accompanied by the text 'Lift the handset or press SP-PHONE/MONITOR.' To the right, a musical note icon is labeled 'Confirmation tone'. Further right, an icon of a handset being hung up is labeled 'Hang up or press SP-PHONE/MONITOR.' Below the digit sequence, a callout box titled '<PT Display Example>' shows a display screen with the text 'Paging Deny On'.

Lift the handset or press SP-PHONE/MONITOR.

Dial 7211.

Confirmation tone

Hang up or press SP-PHONE/MONITOR.

<PT Display Example>  
Paging Deny On

#### Canceling

**PT**

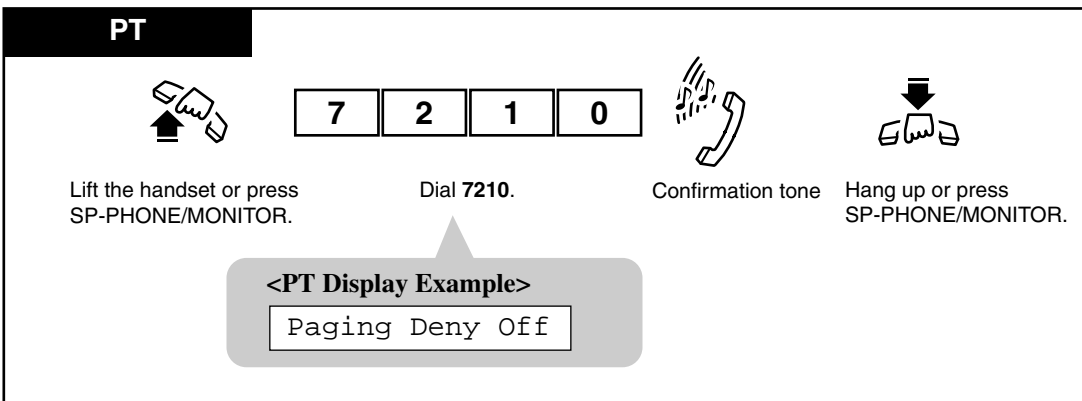

The diagram illustrates the steps to cancel 'Paging Deny On'. It features a central sequence of four boxes containing the digits 7, 2, 1, and 0. To the left, an icon of a handset being lifted is accompanied by the text 'Lift the handset or press SP-PHONE/MONITOR.' To the right, a musical note icon is labeled 'Confirmation tone'. Further right, an icon of a handset being hung up is labeled 'Hang up or press SP-PHONE/MONITOR.' Below the digit sequence, a callout box titled '<PT Display Example>' shows a display screen with the text 'Paging Deny Off'.

Lift the handset or press SP-PHONE/MONITOR.

Dial 7210.

Confirmation tone

Hang up or press SP-PHONE/MONITOR.

<PT Display Example>  
Paging Deny Off

## 4.3.64 Paging and Transfer

You can transfer a call after making a paging announcement via Paging — All, Paging — External, or Paging — Group.

### Using Paging — All

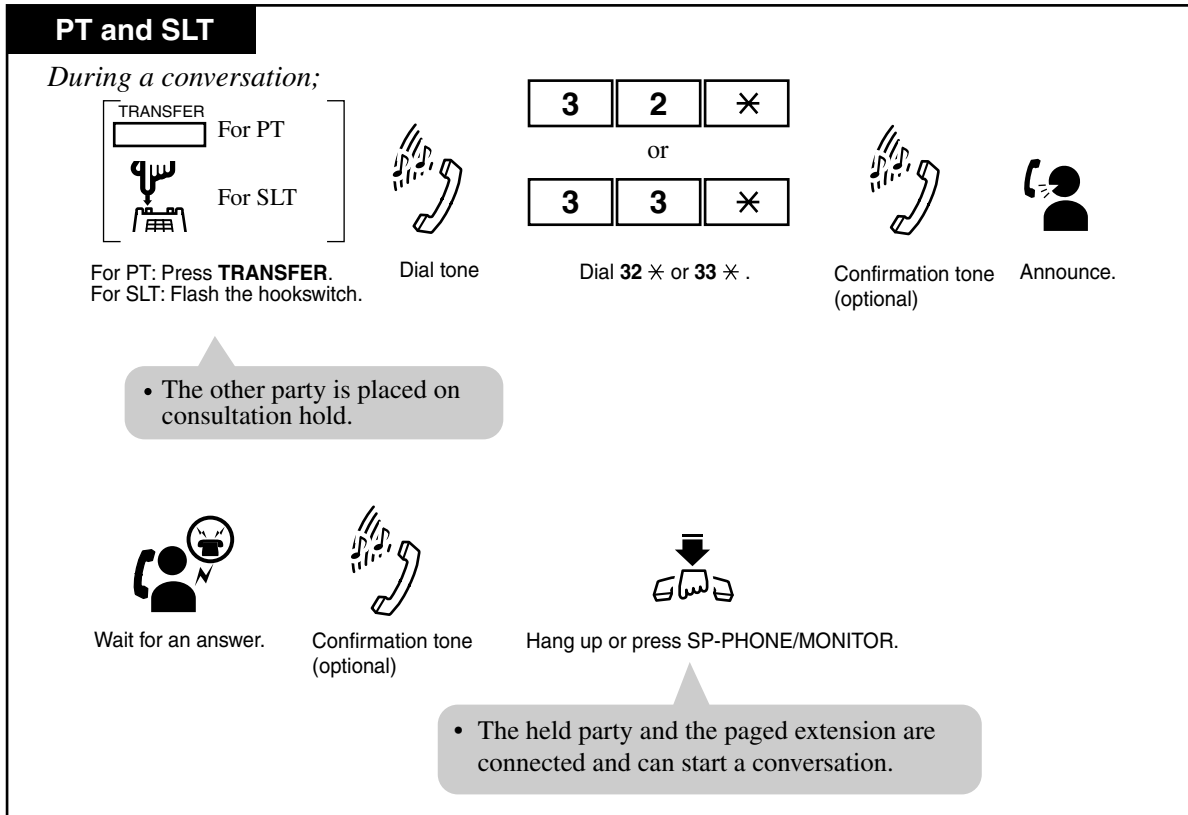

### Using Paging — External: to all external pagers

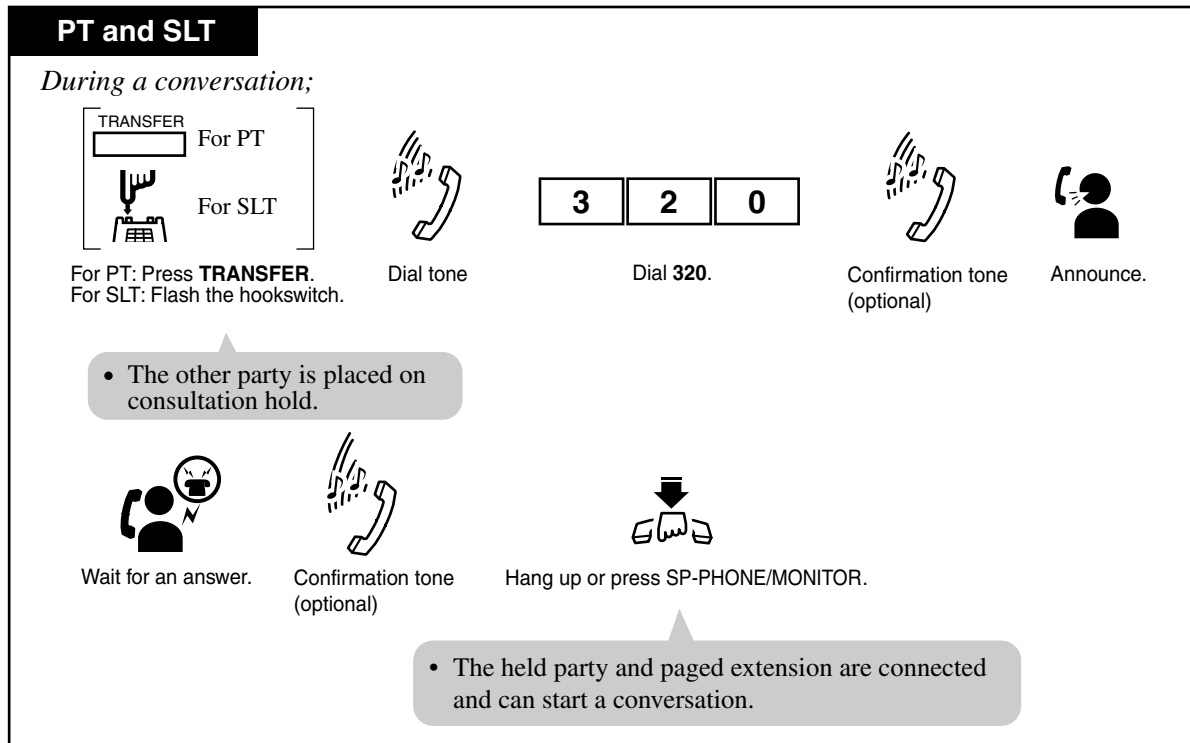

### Using Paging — External: to a particular external pager

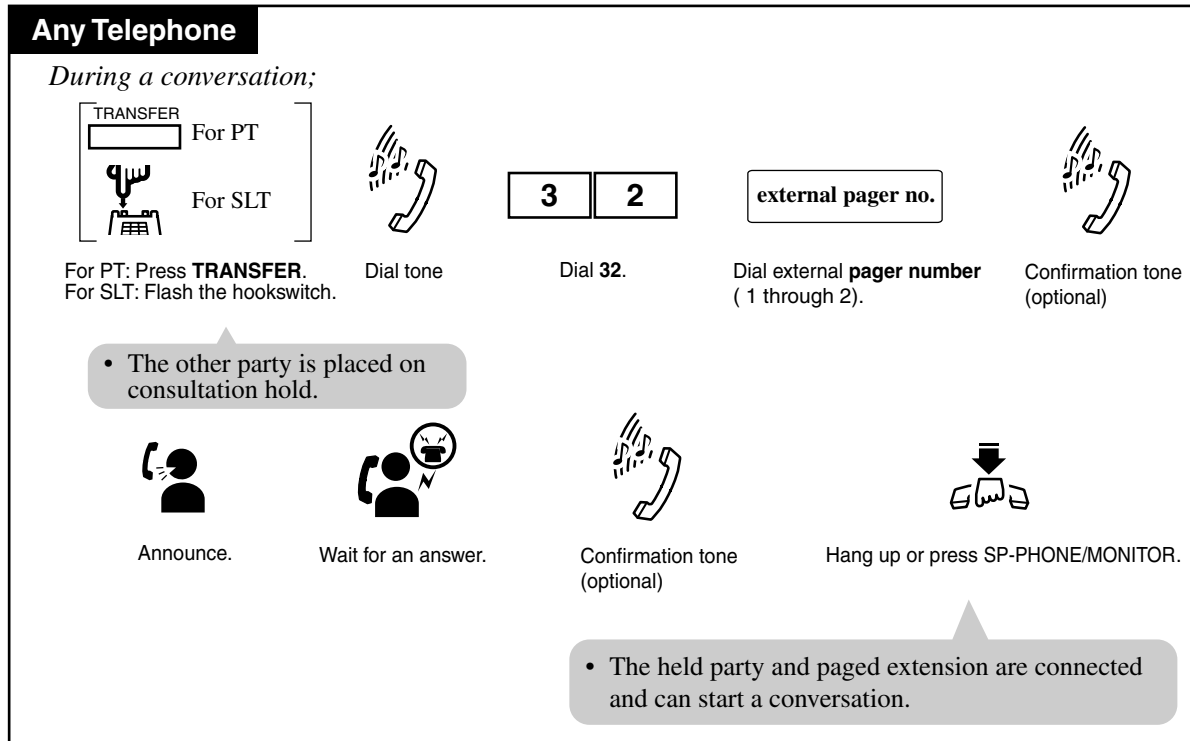





### Using Paging — Group: to all paging groups

**PT and SLT**

*During a conversation;*

TRANSFER For PT

 For SLT



Dial tone

3

3

0

Dial 330.



Confirmation tone (optional)

For PT: Press **TRANSFER**.  
For SLT: Flash the hookswitch.

- The other party is placed on consultation hold.



Announce.



Wait for an answer.



Confirmation tone (optional)



Hang up or press SP-PHONE.

- The held party and the paged extension are connected and can start a conversation.

### Using Paging — Group: to a particular paging group

**PT and SLT**

*During a conversation;*

TRANSFER For PT

 For SLT



Dial tone

3

3

Dial 33.

paging group no.

Enter a **paging group number** (1 through 8).



Confirmation tone (optional)

For PT: Press **TRANSFER**.  
For SLT: Flash the hookswitch.

- The other party is placed on consultation hold.



Announce.



Wait for an answer.



Confirmation tone (optional)



Hang up or press SP-PHONE.

- The held party and the paged extension are connected and can start a conversation.

### **Conditions**

- A confirmation tone is audible before making the voice announcement.  
Eliminating the tone is programmable.

### **Programming Guide References**

- [602] Extension Group Assignment
- [805] External Pager Confirmation Tone
- [990] System Additional Information

## 4.3.65 Paralleled Telephone Connection

A Proprietary Telephone (PT) can be connected in parallel with a single line telephone (SLT). This feature allows you to enable or disable SLT ringing. When a parallel connection is made, either telephone can be used.

### To enable / disable SLT ringing

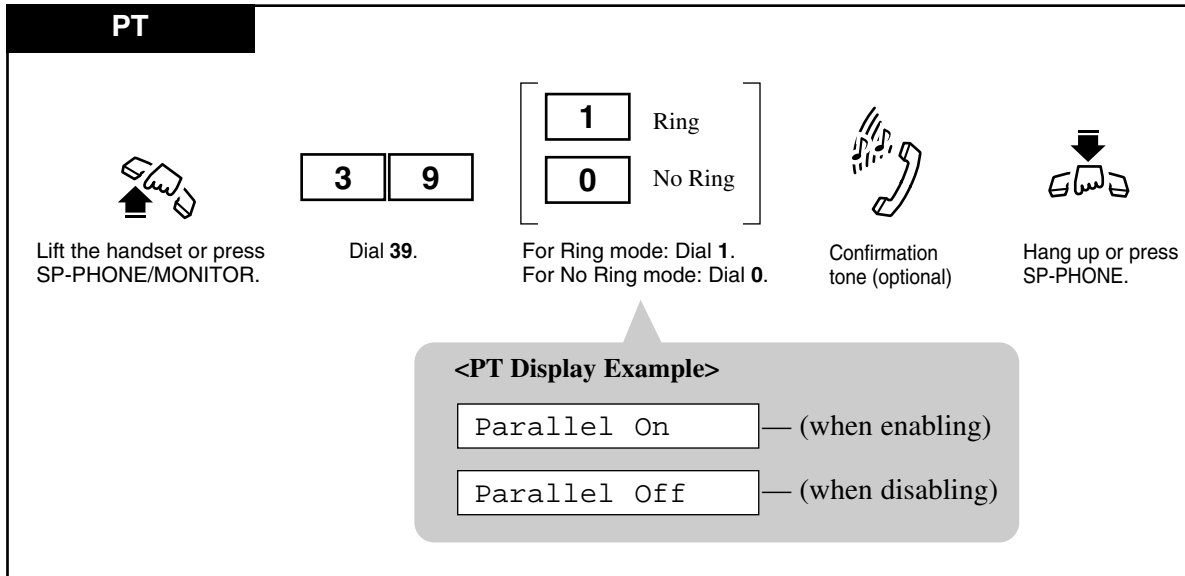

### Conditions

- The default is "Parallel Off (No ring)".
- The PT can be used to perform normal operations whether or not the SLT is set to ring.
- **When receiving a call:**
  - If SLT ringing is enabled, then both the PT and the SLT will ring except when the PT is in "Hands-free Answerback" mode or Voice-Calling mode with the "Alternate Calling — Ring/Voice" feature.
  - If SLT ringing is disabled, then the PT rings but the SLT does not. However, the SLT can answer the call.
- When the SLT is in use, the display and the indicators of the PT will work in the same way as if the PT is in use.
- While the PT is receiving a call from a doorphone, the paired SLT will not ring.



### User Manual References

- 4.3.3 Alternate Calling — Ring / Voice
- 4.3.49 Hands-free Answerback [PT only]

## 4.3.66 Personal Speed Dialing

Allows you to store up to 10 speed dial numbers at your extension. These numbers are available for your extension only.

### Storing the phone number

Any Telephone						
	<b>3</b>	<b>0</b>	personal speed dial no.	desired no.	#	
Lift the handset or press SP-PHONE/MONITOR.	Dial <b>30</b> .	Enter the <b>personal speed dial number</b> (0 through 9).	Enter the <b>desired number</b> .	Dial #.	Confirmation tone and dial	Hang up or press SP-PHONE/MONITOR.

### Dialing

Any Telephone		
	<b>3</b>	<b>*</b>
Lift the handset or press SP-PHONE/MONITOR.	Dial <b>3*</b> .	Enter the <b>personal speed dial number</b> (0 through 9).

### Conditions

- You can store an extension number, a telephone number, or a feature number up to 16 digits. Valid digits are "0 through 9", "\*" and PAUSE button. For SLT users, PAUSE (pausing time) can be stored by dialing\*\*.
- To store the telephone number of an outside party, the line access code (9 or 81 through 88) must be stored as the leading digit.
- "Personal Speed Dialing" can be followed by manual dialing to supplement the dialed digits.

#### <PT>

- One-Touch Dialing**

A PT user may make a call with One-Touch Dialing button, instead of Personal Speed Dialing.

## **User Manual References**

### 2.2.2 Flexible Button Assignment

### 4.3.67 Phantom Extension

Allows you to route calls to a phantom extension. The call arrives at the extension who has the corresponding Phantom button. A flexible CO button can be assigned as the Phantom button. The lighting patterns of Phantom button and status are as follows.

Off : Idle

Red : You are calling a phantom extension.

Flashing green rapidly : Incoming call

#### To call a phantom extension

**PT**

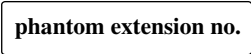

*While the Phantom button indicator light is off;*

 (Phantom)      or       phantom extension no.

Press **Phantom** (flexible button).      Dial the **phantom extension number**.

- You may dial the phantom extension number instead.
- The Phantom indicator light turns red (steady).

**SLT**

Lift the handset.      Dial the **phantom extension number**.      Talk.

**To transfer a call to a phantom extension (Screened Call Transfer)**

**PT**

*During a conversation;*

Press **TRANSFER**.

Confirmation tone

Dial tone

(Phantom)

Press **Phantom** (flexible button).

Ringback tone

- The other party is placed on consultation hold.
- You may dial the phantom extension number instead.

Wait for an answer.

Announce.

Hang up or press SP-PHONE/MONITOR.

- The call is transferred.

**SLT**

*During a conversation;*

Flash the switchhook.

Confirmation tone

Dial tone

phantom extension no.

Dial the destination **phantom extension number**.

Ringback tone

- The other party is placed on consultation hold.

Wait for an answer.

Announce.

Hang up.

- The call is transferred.

**To transfer a call to a phantom extension (Unscreened Call Transfer)**

**PT**

*During a conversation;*

Press **TRANSFER**. Confirmation tone Dial tone

(Phantom)

Press **Phantom** (flexible button). Ringback tone Hang up or press SP-PHONE/MONITOR.

- The other party is placed on hold. consultation hold.
- Ringing starts at the destination extension.
- The call is transferred.

**SLT**

*During a conversation;*

Flash the switchhook. Confirmation tone Dial tone

phantom extension no.

Dial the **destination phantom extension number**. Ringback tone Hang up.

- The other party is placed on hold. consultation hold.
- Ringing starts at the destination extension.

**To answer a phantom extension call**

**PT**

*While the Phantom button indicator light is flashing green;*

(Phantom)

Press **Phantom** (flexible button).



**Conditions**

- A phantom number must be assigned by System Programming before assigning the Phantom Extension button by Station Programming or System Programming.
- If several extensions have the same phantom extension number, they will ring simultaneously.
- A maximum of 128 phantom numbers can be assigned by System Programming.
- The Phantom button cannot be used for feature settings such as "Call Forwarding".
- It is programmable not to ring the extension when a call is received at a phantom extension by Station Programming.
- **Phantom Extension button on a DSS Console:**  
Allows the operator to transfer a call to a phantom extension by the Phantom Extension button on the DSS Console.

**Programming Guide References**

[005] Flexible CO Button Assignment

[124] Phantom Extension Number Assignment

**User Manual References**

2.2.2 Flexible Button Assignment

2.2.3 Phantom Extension Ringing On/Off Set

### 4.3.68 Pickup Dialing (Hot Line)

You can make a call to the pre-programmed party simply by going off-hook.

#### Programming the phone number

**Any Telephone**

Lift the handset or press SP-PHONE/MONITOR.

Dial **742**.

Enter the **phone number**. Dial **#**.

Confirmation tone and dial tone

Hang up or press SP-PHONE/MONITOR.

- You must dial a line access code (9 or 81 through 88) as the first digit when storing an outside phone number.

#### Setting / Canceling

**Any Telephone**

Lift the handset or press SP-PHONE/MONITOR.

To set: Dial **741**.  
To cancel: Dial **740**.

Confirmation tone and dial tone

Hang up or press SP-PHONE/MONITOR.

#### Dialing

**Any Telephone**

Lift the handset or press SP-PHONE/MONITOR.

Wait for an answer.

Talk.

#### Conditions

- This feature does not work if you go off-hook to answer an incoming call or retrieve a call on hold (Consultation Hold).
- Up to 16 digits, consisting of "0 through 9" and "\*", can be stored. "#" cannot be stored.
- Valid digits are "0 through 9", "\*" and PAUSE button. For SLT users, PAUSE (pausing time) can be stored by dialing \*\*.
- During the waiting time after going off-hook, you can dial another party and override this feature. This waiting time (between going off-hook and connecting with the called line) can be changed by System Programming. (Default: 1 s)

## **Programming Guide References**

[204] Pickup Dial Waiting Time



### 4.3.69 Privacy Release [PT only]

Allows you to establish a three-party conference call while connected to an existing call.

#### Setting

**PT**

*During a conversation with an outside party, to allow another extension to join the conversation;*

-at your extension (CO) 	-at the other extension (CO) 	
Press the corresponding <b>CO</b> .	Press the flashing <b>CO</b> within five seconds.	Confirmation tone (optional)

- The corresponding CO indicator light flashes green rapidly.
- A three-party conference is now established.

#### To leave the conference

**PT**





Hang up or press SP-PHONE/MONITOR.

- The other two parties may continue their conversation.

#### To terminate one party and talk to the other

**PT**

(CO)  or INTERCOM 

Press **CO** or **INTERCOM** of the desired party.

**Conditions**

- The CO button pressed to join the conversation needs to be assigned as a Single-CO (S-CO) button.
- After the user presses the CO button, the CO indicator light of the other extension flashes rapidly for only 5 seconds. Pressing the CO button again gives you an additional 5 seconds.
- This feature overrides "Data Line Security" and "Executive Busy Override Deny".
- When a two-party call is changed to a three-party call and vice versa, a confirmation tone is sent to all three parties. Eliminating the tone is programmable.

**Programming Guide References**

[990] System Additional Information

**User Manual References**

- 2.2.2 Flexible Button Assignment
- 4.3.34 Conference
- 4.3.36 Data Line Security
- 4.3.45 Executive Busy Override Deny

### 4.3.70 Pulse to Tone Conversion

You can change the dialing mode from Pulse to Tone temporarily to access services such as computer telephone services, Voice Mail, etc., that require a tone.

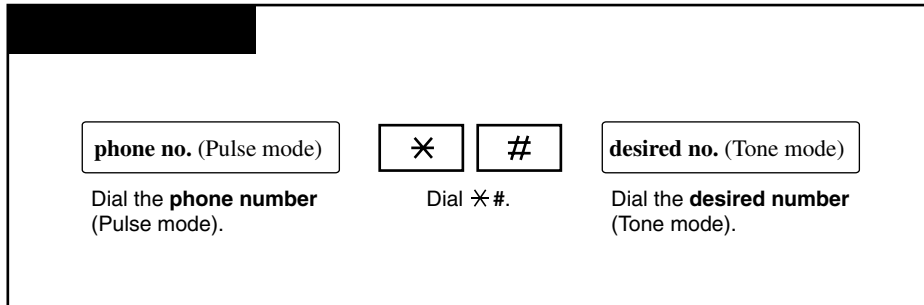

#### Conditions

- You cannot change the dialing mode from Tone to Pulse.

## 4.3.71 Quick Dialing

Allows you to make a quick dial call by dialing a pre-assigned quick dial number. For example, Quick Dialing is convenient for room service calls in a hotel.

### Dialing

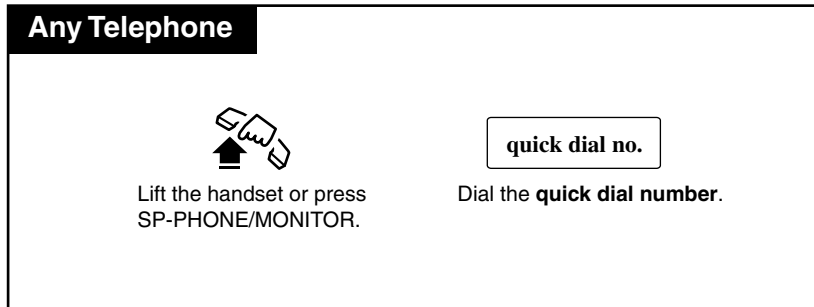

### Conditions

- Up to eight quick dial numbers can be stored by System Programming.
- You must assign a feature number in program [100] Flexible Numbering in the programming Guide first and then a quick dial number in program [009] Quick Dial Number Set in the Programming Guide in order for Quick Dial to be effective.
- Quick Dialing is convenient for frequently dialed phone numbers.





### Programming Guide References

[009] Quick Dial Number Set

[100] Flexible Numbering

## 4.3.72 Redial, Last Number

Automatically saves the last outside call number you dialed so that you can make a call to the same party later with a simple operation.

PT		SLT	
 Lift the handset or press SP-PHONE/MONITOR.	REDIAL  Press <b>REDIAL</b> .	 Lift the handset.	 Dial #.

### Conditions

- Up to 24 digits can be stored and redialed; this does not include an outside line access code.
- "\*", "#", "PAUSE", and "INTERCOM" (for secret dialing) are counted as one digit.
- The memorized telephone number is replaced by a new one if at least one digit sent to an outside line is dialed. Dialing an outside line access code alone does not change the memorized number.

#### <PT>

- If you hear a busy tone when attempting to redial, select another line and press the REDIAL button.

#### <SLT>

- If you hear a busy tone when attempting to redial, select another line and dial "#".



### 4.3.73 Redial, Saved Number [PT only]

Allows you to store a telephone number during the conversation, so that you can redial the same party later with a simple operation. The saved number can be redialed until another number is stored.

#### Storing

PT

*During a conversation or while hearing a busy tone;*

AUTO DIAL



STORE

Press **STORE**.

(SAVE)



Press **SAVE** (flexible button).

#### Dialing

PT



Lift the handset or press  
SP-PHONE/MONITOR.

(SAVE)



Press **SAVE** (flexible button).

#### Conditions

- Up to 24 digits can be stored and redialed; excluding a line access code.
- "×", "#", "PAUSE", and "INTERCOM" (for secret dialing) are counted as one digit.
- **SAVE button**  
A flexible button can be assigned as the SAVE button by Station, User or System Programming.

#### User Manual References

- 2.2.2 Flexible Button Assignment

### 4.3.74 Room Monitor

Allows you to monitor a room through a proprietary telephone with an AUTO ANSWER/MUTE button. The proprietary telephone you want to monitor should be prepared for monitoring beforehand. You can also monitor through a doorphone. You can use a proprietary telephone with an AUTO ANSWER/MUTE button and single line telephone with a MUTE button for monitoring.

#### Setting a monitored PT

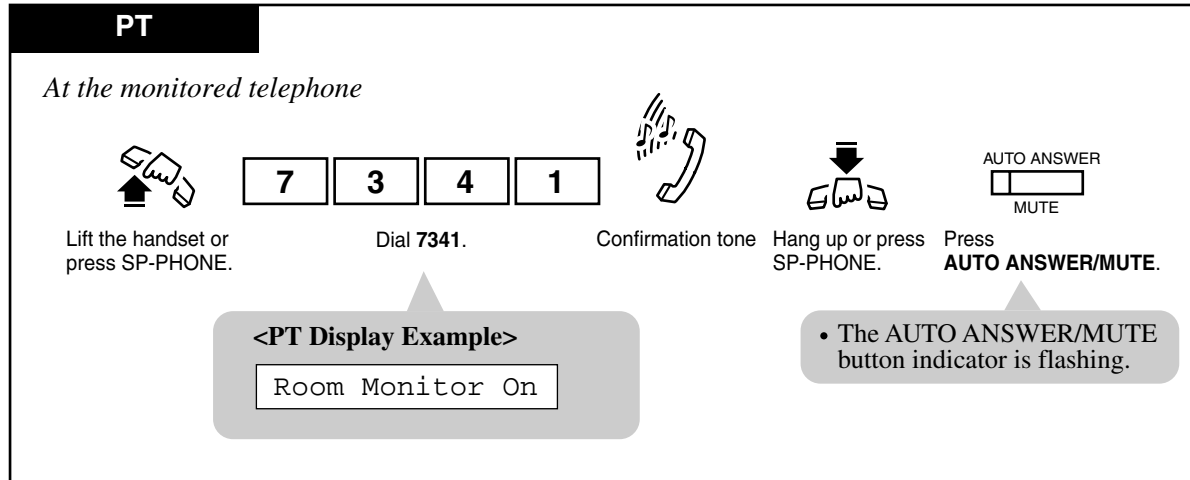

#### Monitoring

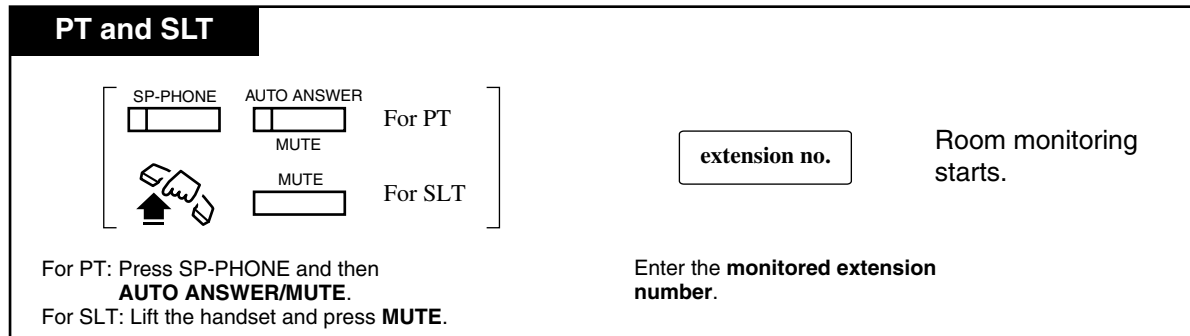

#### Talking with a person in the monitored room

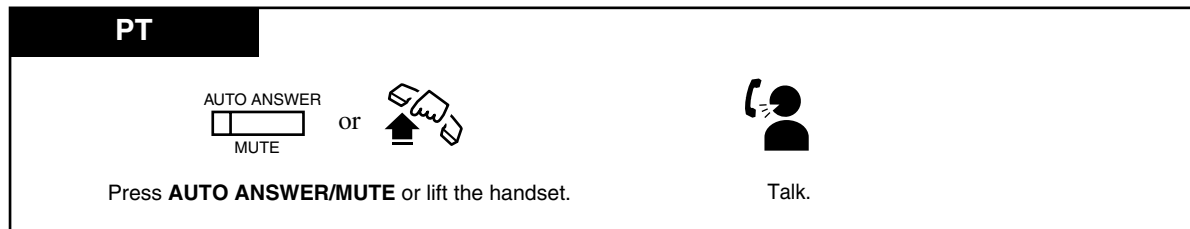

### Canceling a monitor temporarily

**PT**

*At the monitored telephone*

Press **AUTO ANSWER/MUTE**.

- The **AUTO ANSWER/MUTE** button indicator turns off.

### Canceling

**PT**

*At the monitored telephone*

Lift the handset or press **SP-PHONE**.

Dial **7340**.

Confirmation tone

Hang up or press **SP-PHONE**.

**<PT Display Example>**  
Room Monitor Off

### Monitoring through a doorphone

**PT and SLT**

For **PT**: Press **SP-PHONE** and then **AUTO ANSWER/MUTE**.

For **SLT**: Lift the handset and press **MUTE**.

Dial **31**. Enter the **monitored doorphone number** (1 through 4).

Monitoring starts.

### Conditions

- The doorphone access tone can be disabled by System Programming.

#### <PT>

- The access tone will not be sent to the monitored PT. The paging access tone will also not be sent to the monitored PT.
- System Programming is required to monitor through a PT.
- This feature is not available for the KX-T7050 and KX-T7055.

### **Programming Guide References**

[625] Room Monitor Assignment

[819] Doorphone Access Tone Selection

### 4.3.75 Secret Dialing [PT only]

Allows you to conceal all or part(s) of a "System Speed Dialing" or "One-Touch Dialing" number assigned to a flexible button on your PT and DSS console which normally appears on the display.

PT

*When storing the phone number;*

INTERCOM

Press **INTERCOM** before and after the part you wish to conceal.

**<PT Display Example>**

9-1-[123]...

– "123" is not shown on the display when you dial.

#### Conditions

- The secret code, "[" or "]" (pressing the INTERCOM button), are counted as one digit.
- You can conceal one or more parts of a telephone number.
- If the phone number "9-1-[123]-456-7890" has been stored, the display shows the following when the call is made:

-1-...-456-7890

- The concealed part will be printed out by Station Message Detail Recording (SMDR).

#### Programming Guide References

[001] System Speed Dialing Number Set

#### User Manual References

- 2.2.2 Flexible Button Assignment
- 3.2.2 [001] System Speed Dialing Number Set
- 4.3.58 One-Touch Dialing [PT only]
- 4.3.66 Personal Speed Dialing
- 4.3.77 System Speed Dialing

### 4.3.76 Station Program Clear

Allows you to reset the following station features to the default settings.

(a)	<b>Absent Message Capability</b> (The message set on your extension)
(b)	<b>Automatic Callback Busy (Camp-On)</b>
(c)	<b>Background Music</b> that has been turned on*
(d)	<b>Call Forwarding</b>
(e)	<b>Call Log, Incoming</b>
(f)	<b>Call Pickup Deny</b>
(g)	<b>Call Waiting</b>
(h)	<b>Data Line Security</b>
(i)	<b>Do Not Disturb (DND)</b>
(j)	<b>Executive Busy Override Deny</b>
(k)	<b>Log-In / Log-Out</b>
(l)	<b>Message Waiting</b> (All messages that have been left on your extension by other extension users)
(m)	<b>Paging Deny*</b>
(n)	<b>Paralleled Telephone Connection*</b>
(o)	<b>Pickup Dialing (Hot Line)</b> – (The stored telephone number will be removed)
(p)	<b>Room Monitor</b>
(q)	<b>Timed Reminder</b>

\*: PT only

#### Clearing the current feature settings

**Any Telephone**



Lift the handset or press SP-PHONE/MONITOR.

7	9	0
---	---	---

Dial 790.



Confirmation tone and dial tone



Hang up or press SP-PHONE/MONITOR.

<PT Display Example>

Ext Data Clear

## 4.3.77 System Speed Dialing

Allows you to make a call using speed dial numbers programmed previously. This system supports **five hundred** speed dial numbers which are available to all extension users.

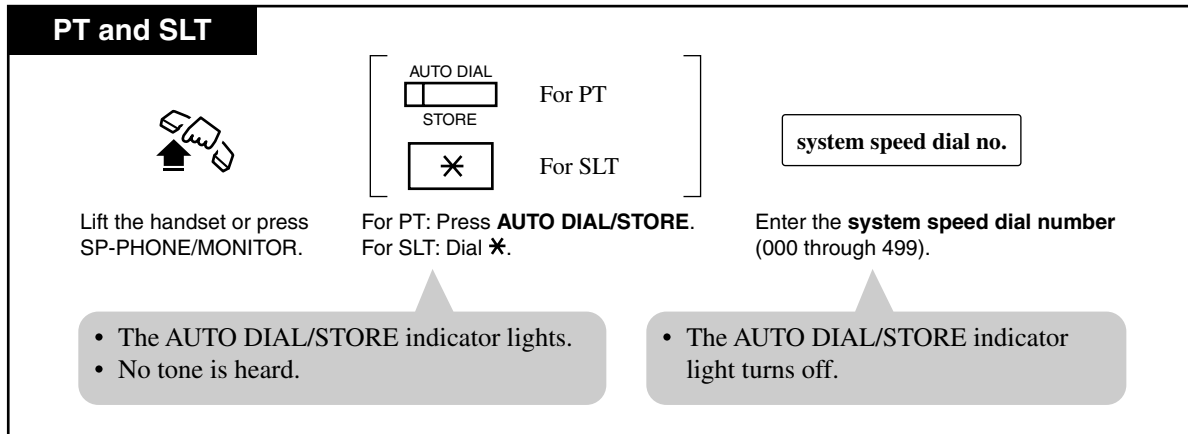

### Conditions

- System Speed Dial numbers must be stored either by the User (Manager) or System Programming.
- It is possible to cancel toll restriction with this feature (Toll Restriction Override for System Speed Dialing). In this case, System Programming is necessary.

### <PT>

- "Speed Dialing", "One-Touch Dialing", "Redial, Last Number/Saved Number" and manual dialing can be used together.
- Continuous use of a speed dial number is possible, if the number is divided when stored.  
<Example>  
If the number is divided and stored in System Speed Dial numbers 001 and 002;  
Press: [AUTO DIAL/STORE] [0] [0] [1] [AUTO DIAL/STORE] [0] [0] [2]
- The dialed number appears on the display.
- You may press a CO button to select a desired outside line before pressing the AUTO DIAL/STORE button.

### Programming Guide References

[001] System Speed Dialing Number Set

### User Manual References

3.2.2 [001] System Speed Dialing Number Set

4.3.81 Toll Restriction Override for System Speed Dialing

### 4.3.78 Timed Reminder

Allows you to set your extension to sound an alarm once or daily at a preset time. Each telephone can be set to generate an alarm tone at a preset time as a reminder. When this feature is set, an alarm tone will ring for 30 seconds (default) at the programmed time.

#### Wake-Up Call

If a voice message is recorded beforehand, wake-up message is heard instead of an alarm tone when an extension user goes off-hook.

This feature can be activated only once or everyday at a specified time.

#### Setting

**Any Telephone**



Lift the handset or press SP-PHONE/MONITOR.

7

6

1

Dial **761**.

hour

Enter the **hour**  
(01 through 12).

minute

Enter the **minute**  
(00 through 59).

0

 or 

1

For AM: Dial **0**.  
For PM: Dial **1**.

0

 or 

1

For a one time alarm\*<sup>1</sup>: Dial **0**.  
For a daily alarm\*<sup>2</sup>: Dial **1**.



Confirmation tone and dial tone



Hang up or press SP-PHONE/MONITOR.

\*<sup>1</sup> An alarm will be heard at the preset time and then the setting is cleared.  
\*<sup>2</sup> An alarm will be heard daily at the preset time until the setting is changed or canceled.

#### Canceling

**Any Telephone**



Lift the handset or press SP-PHONE/MONITOR.

7

6

0

Dial **760**.



Confirmation tone and dial tone



Hang up or press SP-PHONE/MONITOR.

<PT Display Example>  
Alarm Cancelled



## Checking the setting time

Display PT



Lift the handset or press  
SP-PHONE.

7

6

2

Dial **762**.



Dial tone



Hang up or press  
SP-PHONE.

- If "10:10 AM" has been set:  
<PT Display Example>

Alarm 10:10AM
– one time

or

Alarm 10:10AM\*
– daily

## Stopping the alarm

Any Telephone



Lift the handset.

- Pressing any key also stops the alarm (PT only).

## Conditions

- **System Time**  
The system clock must be set before the alarm is set.
- Timed Reminder message can be recorded by the Manager or an Operator. ("Outgoing Message (OGM)"). When the alarm is heard, you can hear the message by going off-hook, if it has been recorded. You hear an intermittent tone (dial tone 3) instead of the message in the following cases:
  - a) A DISA Card is not equipped.
  - b) All DISA ports are busy or OUS (Out-of-Service).
- If other extension user calls your extension when the alarm is sounding, he or she will hear a busy tone.
- If you receive an incoming outside call during the alarm, the ringing starts after the alarm stops.
- If you are having a conversation at the time the alarm is set to sound, the alarm starts after the conversation.

- **Station Message Detail Recording (SMDR)**  
SMDR automatically records the detailed Timed Reminder information (data, time, extension number, start/no answer). It is programmable by System Programming to print out when the Timed Reminder starts and the alarm is not answered.
- Setting a new time clears the preset time.
- **Timed Reminder Ringing Time**  
The alarm continues for a specified period of time (default: 30 s).  
This period of time can be changed by System Programming.

<PT>

- If an alarm time has not been set, the display shows the following:

Alarm Not Stored

### Programming Guide References

- [000] Date and Time Set
- [215] Outgoing Message Time
- [217] Timed Reminder Alarm Ring Time
- [990] System Additional Information

### User Manual References

- 3.2.1 [000] Date and Time Set
- 4.4.7 Outgoing Message (OGM)

### **4.3.79 Toll Restriction Override — SUMMARY**

There are two types of toll restriction override:

- **Toll Restriction Override by Account Code Entry**
- **Toll Restriction Override for System Speed Dialing**

## 4.3.80 Toll Restriction Override by Account Code Entry

Allows you to temporarily override toll restriction and make a toll call from a toll-restricted telephone. You can carry out this feature by entering an appropriate account code before dialing the telephone number. For operation procedure, refer to 4.3.2 Account Code Entry.

### Conditions

- This feature changes the toll restriction level to level 2. This can be used by extension users assigned to restriction levels 3 through 8. Levels 1 and 2 can not be changed.
- A "Class of Service" which is assigned to the "Account Code Entry — Verified - Toll Restriction Override" mode permits the class members to override their toll restrictions.
- Up to 128 account codes can be programmed for the Verified mode.
- If you do not enter an account code or you enter an invalid account code, standard toll restriction is in effect.

### Programming Guide References

[105] Account Codes

[500]-[501] Toll Restriction Level — Day / Night

[508] Account Code Entry Mode

[601] Class of Service

### Features Guide References

Toll Restriction

### User Manual References

2.2.2 Flexible Button Assignment

4.3.2 Account Code Entry

### **4.3.81 Toll Restriction Override for System Speed Dialing**

Allows you to cancel toll restriction in "System Speed Dialing". Normally, calls originated by "System Speed Dialing" are restricted depending on the extension's toll restriction level. Once this option is set, it permits all extension users to make "System Speed Dialing" calls with no restrictions. You can override toll restriction for "System Speed Dialing" through System Programming.

#### **Programming Guide References**

[300] TRS Override for System Speed Dialing

#### **Features Guide References**

Toll Restriction

#### **User Manual References**

4.3.77 System Speed Dialing

## 4.3.82 Trunk Answer From Any Station (TAFAS)

Allows you to answer an incoming outside call, paged through an external pager, from any extension.

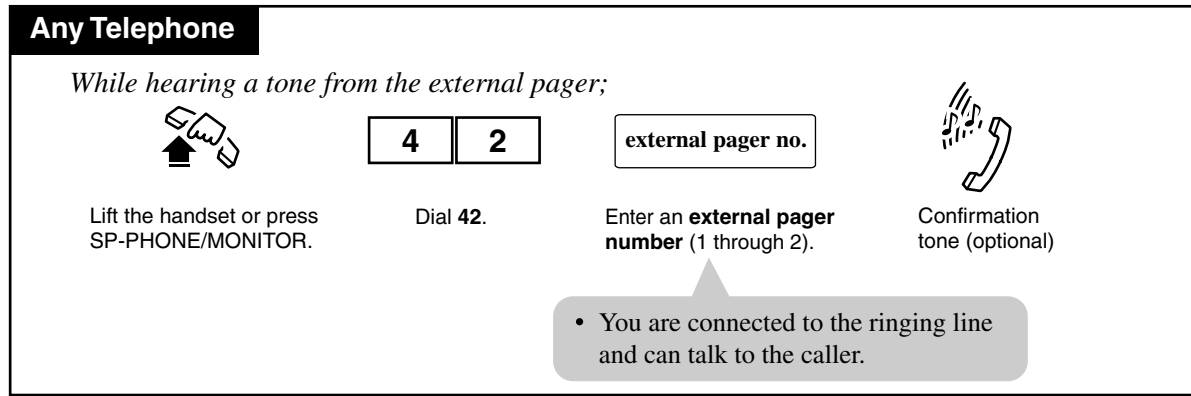

### Conditions

- TAFAS can be used in the following cases:
  - a) The floating number<sup>\*1</sup> of an external pager is assigned as the Direct in Lines (DIL) 1:1 destination. In this case all of the incoming calls on the specified line will be signaled.
  - b) A DISA (Direct Inward System Access) caller dials the floating number of an external pager.
  - c) The floating number of an external pager is assigned as the Intercept Routing destination. In this case incoming calls redirected to the destination will be signaled.
- **Confirmation Tone**  
A confirmation tone is sent to the extension user before being connected to the caller. Eliminating the tone is programmable.

### Programming Guide References

[407-408] DIL 1:1 Extension — Day / Night  
 [409-410] Intercept Extension — Day / Night  
 [813] Floating Number Assignment  
 [990] System Additional Information

### Features Guide References

Floating Station

<sup>\*1</sup> A Floating Number (FN) is a virtual extension number which appears to be an extension. Refer to "Floating Station" in the Features Guide.

### 4.3.83 Two-Way Recording into Voice Mail \*1 [PT only]

Allows you to record a conversation into your mailbox or the desired mailbox.

#### Recording into your mailbox

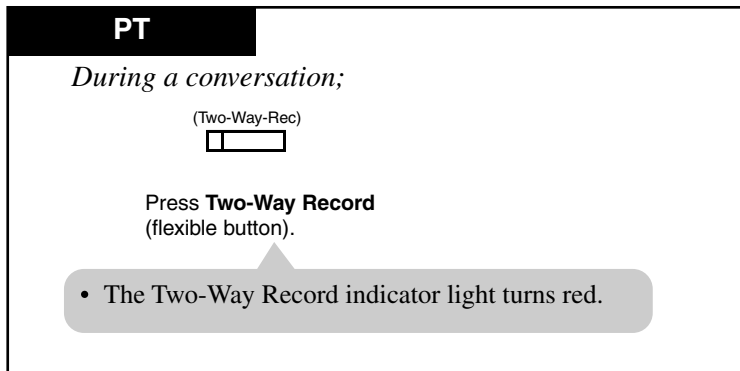

#### Stopping recording

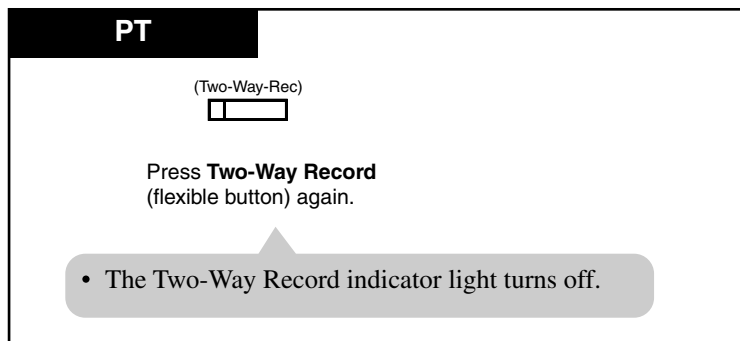

\*1 Available when the Advanced Hybrid System is connected to a Proprietary Telephone capable Panasonic Voice Processing System (one that supports DPT Integration; e.g., KX-TVS50).

### Recording into the mailbox of another extension

PT

*During a conversation;*

(Two-Way-Tran)

extension no.    or    **phantom extension no.**    or    (DSS)

Press **Two-Way Transfer** (flexible button).      Dial the **extension number**, the **phantom extension number** or press DSS (flexible button) where you left a message notification.

- The Two-Way Transfer indicator light turns red.

### Stopping recording

PT

(Two-Way-Tran)

Press **Two-Way Transfer**(flexible button).

- The Two-Way Transfer indicator light turns off.

### Conditions

- A flexible CO and DSS button can be assigned as a Two-Way Record button or a Two-Way Transfer button.
- Pressing the Two-Way Record button sends an alarm tone, if no idle voice mail port exists.
- Pressing the Two-Way Transfer button followed by an extension number sends an alarm tone, if no idle voice mail port exists.
- When you record Two-way telephone conversations, you should inform the other party that the conversation is being recorded.
- **Two-Way Recording into Phantom mailbox:**  
Allows you to record a conversation into the Phantom mailbox by entering the phantom extension number after pressing the Two-way Transfer button. The Phantom Message Waiting indicator light turns on. It will turn off after one of the phantom extension users listens to the recorded conversation.

### User Manual References

- 2.2.2 Flexible Button Assignment



### 4.3.84 Voice Mail Integration

Allows you to have your calls forwarded to your Voice Processing System mailbox. If your telephone has a MESSAGE button, the button light turns on and lets you know you have messages. Even if you do not have a MESSAGE button, you will hear a special tone when going off-hook.

#### Setting Call Forwarding destination to Voice Mail

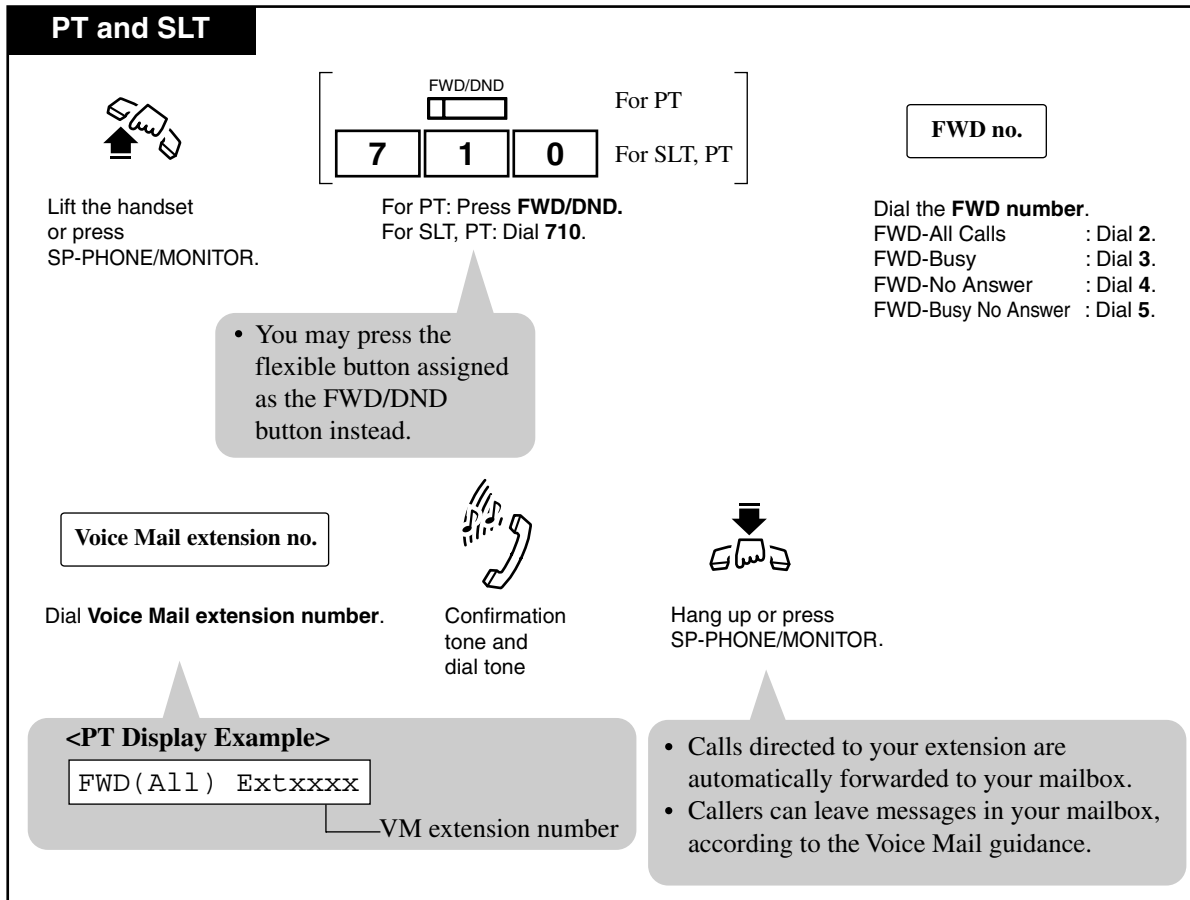

## Canceling

PT and SLT



Lift the handset or press SP-PHONE/MONITOR.

FWD/DND

7

1

0

For PT: Press **FWD/DND**.  
For SLT, PT: Dial **710**.

0



Dial **0**. Confirmation tone and dial tone



Hang up or press SP-PHONE/MONITOR.

- You may press the flexible button assigned as the FWD/DND button instead.
- <PT Display Example>  

FWD/DND Cancel

## Listening to a stored message

You can listen to the messages stored in your mailbox easily. There are two operations to play back messages.

### Using the Message Waiting (MESSAGE) button

PT

*If there is a message in the mailbox, the MESSAGE indicator light is on.*



Lift the handset or press SP-PHONE/MONITOR.

MESSAGE

Press **MESSAGE**.

- You can listen to the stored message.

## Manual dialing

Any Telephone



Lift the handset or press SP-PHONE/MONITOR.

Voice Mail extension no.

Enter the **Voice Mail extension number**.

- You can listen to the stored message by following the Voice Mail guidance.

## Conditions

- Outside callers can leave their messages in your mailbox. When an incoming outside call arrives, the Operator answers the call and transfers it to your extension. And...
    - If you set the "Call Forwarding" function whose destination is Voice Mail;**  
The call will be forwarded to Voice Mail automatically.
    - If you do not set the "Call Forwarding" function;**  
The Operator will retrieve the call. Then the Operator transfers the call to Voice Mail with Voice Mail Transfer button.
  - Voice Mail can be assigned as the destination of the following features.
    - a) Call Forwarding — All Calls
    - b) Call Forwarding — Busy
    - c) Call Forwarding — No Answer
    - d) Call Forwarding — Busy/No Answer
    - e) Intercept Routing
- <PT>
- A flexible button can be assigned as the MESSAGE or FWD/DND button.

## User Manual References

- 2.2.2 Flexible Button Assignment
- 4.3.8 Call Forwarding — SUMMARY
- 4.3.85 Voice Mail Transfer [PT only]

### 4.3.85 Voice Mail Transfer [PT only]

You can transfer the calls to the Voice Processing System so that callers can leave their messages in a desired extension mailbox. When you transfer the call to the designated extension;

—**If the extension has set the "Call Forwarding" function whose destination is Voice Mail;**

The call will be forwarded to Voice Mail.

—**If the extension has not set the "Call Forwarding" function;**

You can retrieve the call and then transfer the call to Voice Mail by One-Touch.

PT

*If the call returns to you;*

(VM Transfer)

extension no.

or

phantom extension no.

or

(DSS)

Press **Voice Mail (VM) Transfer** (flexible button).

Dial the **extension number** or the **phantom extension number** or press **DSS** (flexible button) where you left a message notification.

- The call will be forwarded to the Voice Mail.
- The caller can leave the message according to the Voice Mail guidance.

#### Conditions

- A flexible button can be assigned as the Voice Mail (VM) Transfer button.
- Voice Mail Transfer to Phantom Mailbox:**  
Allows you to transfer received outside calls to the Phantom Mailbox by entering the phantom extension number after pressing the Voice Mail Transfer button. The Phantom Message Waiting indicator light turns on. It will turn off after one of the phantom extension users listens to the stored message.

#### User Manual References

- 2.2.2 Flexible Button Assignment
- 4.3.84 Voice Mail Integration

## 4.3.86 Walking COS

Allows you to use your calling privileges (Class of Service) at another extension. You may override restrictions which may be set at the extension.

### Making a call

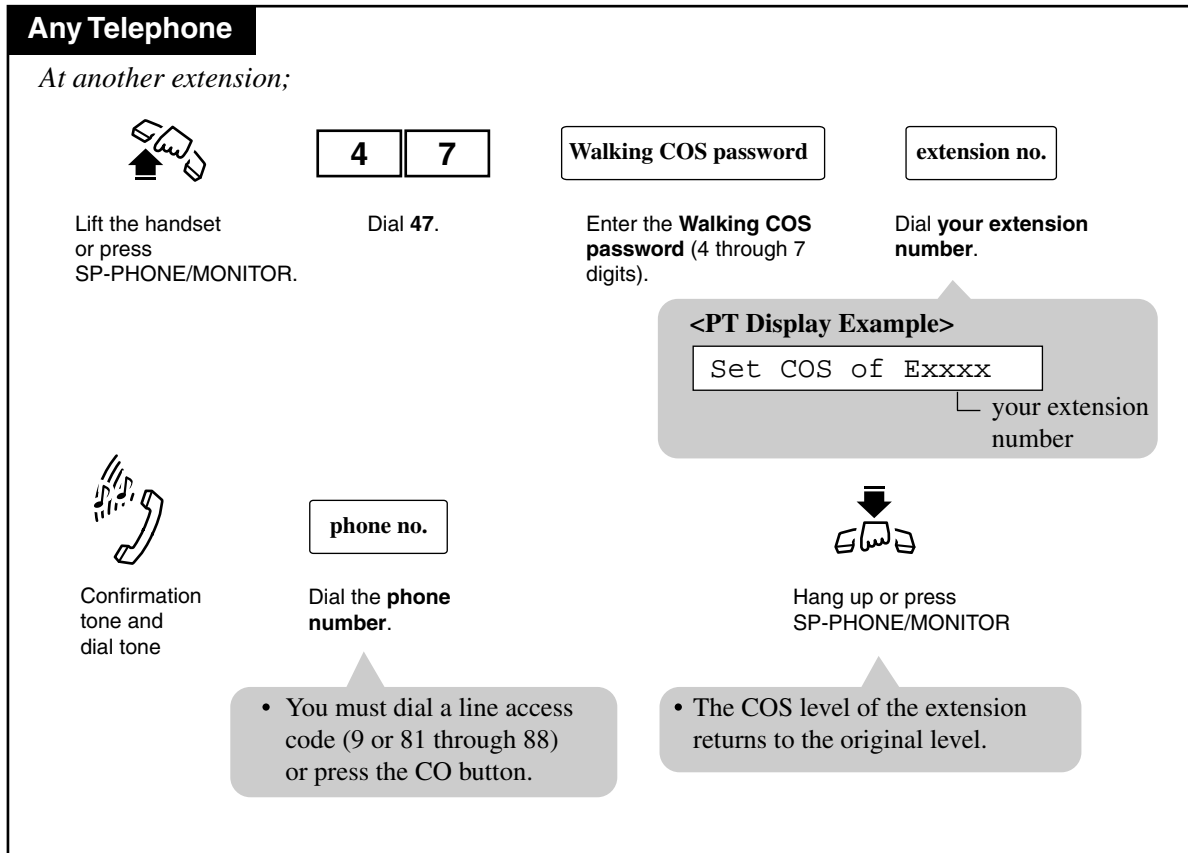

### Conditions

- Class of Service (COS) programming is used to define the features which are allowed for a group of extensions. Each extension is assigned a COS number. The programmable items are as follows:
  - Outgoing call restriction level (Day mode / Night mode) – 1 through 8
  - Restriction of an outside call duration
  - Transfer a call to an outside party
  - Forward a call to an outside party
  - Executive Busy Override
  - Executive Busy Override Deny
  - Override Do Not Disturb of the called extension

- h) Account Code Entry operation – verified – all calls / verified – to toll restriction override / option
- i) Access the Night Service
- j) The number of allowed dialing digits during an outside call

### **Programming Guide References**

[121] Walking COS Password

[601] Class of Service

### **Features Guide References**

Class of Service (COS)

## 4.4 Operator / Manager Service Features

### 4.4.1 Operator / Manager Service Features

The system supports up to two operators and one manager. An extension assigned as the Manager or an Operator by System Programming has the ability to perform the following special features:

- a) Background Music (BGM) — External
- b) Call Log, Incoming in the Common Area— CLEAR ALL
- c) Call Log Lock Control, Incoming in the Personal Area — CANCEL
- d) Call Log Lock, Incoming in the Common Area
- e) Live Call Screening Password Control<sup>\*1</sup>
- f) Outgoing Message (OGM)
- g) Remote Station Lock Control
- h) Switching the day / night mode manually (Refer to page 177).
- i) System Working Report
- j) The 301st Call Log, Incoming in the Common Area Treatment
- k) Timed Reminder, Remote (Wake-Up Call)

#### Programming Guide References

[006] Operator / Manager Extension Assignment

---

<sup>\*1</sup> Available when the Advanced Hybrid System is connected to a Proprietary Telephone capable Panasonic Voice Processing System (one that supports DPT Integration; e.g., KX-TVS50).

## 4.4.2 Background Music (BGM) — External

Allows the Manager and the Operators to broadcast background music (BGM) in the office through the external pagers.

### Setting / Canceling

**Any Telephone**



Lift the handset or press  
SP-PHONE/MONITOR.

3

5

Dial 35.



Confirmation tone



Hang up or press  
SP-PHONE/MONITOR.

- The display shows either one of the following depending on whether the BGM is on or off.

**<PT Display Example>**

External BGM On
— BGM is on

or

External BGM Off
— BGM is off

### Conditions

- To make BGM-External possible, you must enable BGM and select a music source in [803] Music Source Use (System Programming).
- External Pager Priority**  
Priority of access to external pager is: (1) TAFAS; (2) Paging; (3) BGM  
Higher priorities will override the BGM.
- The default is "External BGM Off".

### Programming Guide References

- [803] Music Source Use
- [804] External Pager BGM
- [990] System Additional Information

### User Manual References

- 4.3.6 Background Music (BGM) [PT only]



### 4.4.3 Call Log, Incoming in the Common Area — CLEAR ALL

The operator or manager can clear all call information stored in the common area.

#### Setting

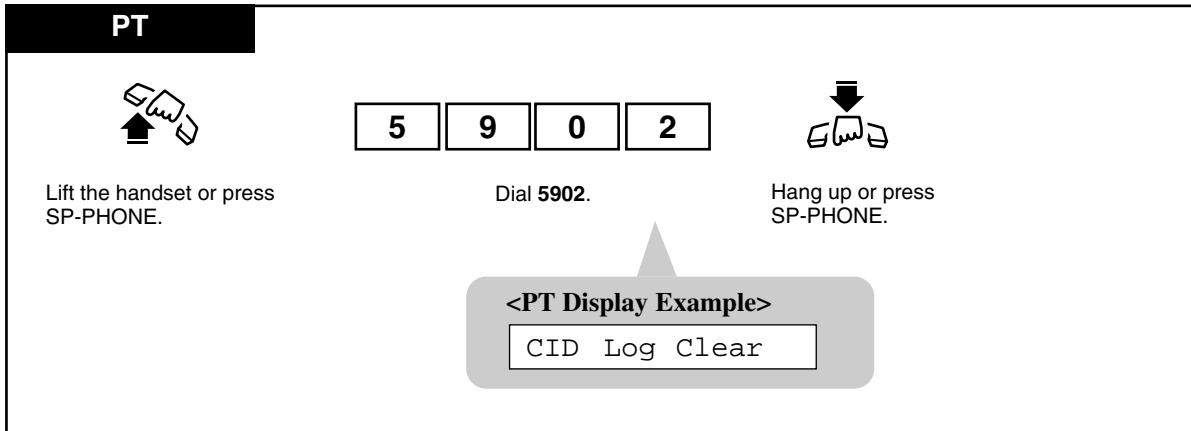

#### Conditions

- This operation is not available while someone is checking a call information stored in the common area.

## 4.4.4 Call Log Lock Control, Incoming in the Personal Area — CANCEL

The Manager and the Operators can cancel the "Call Log Lock, Incoming in the Personal Area" feature set at any other extension.

### Programming

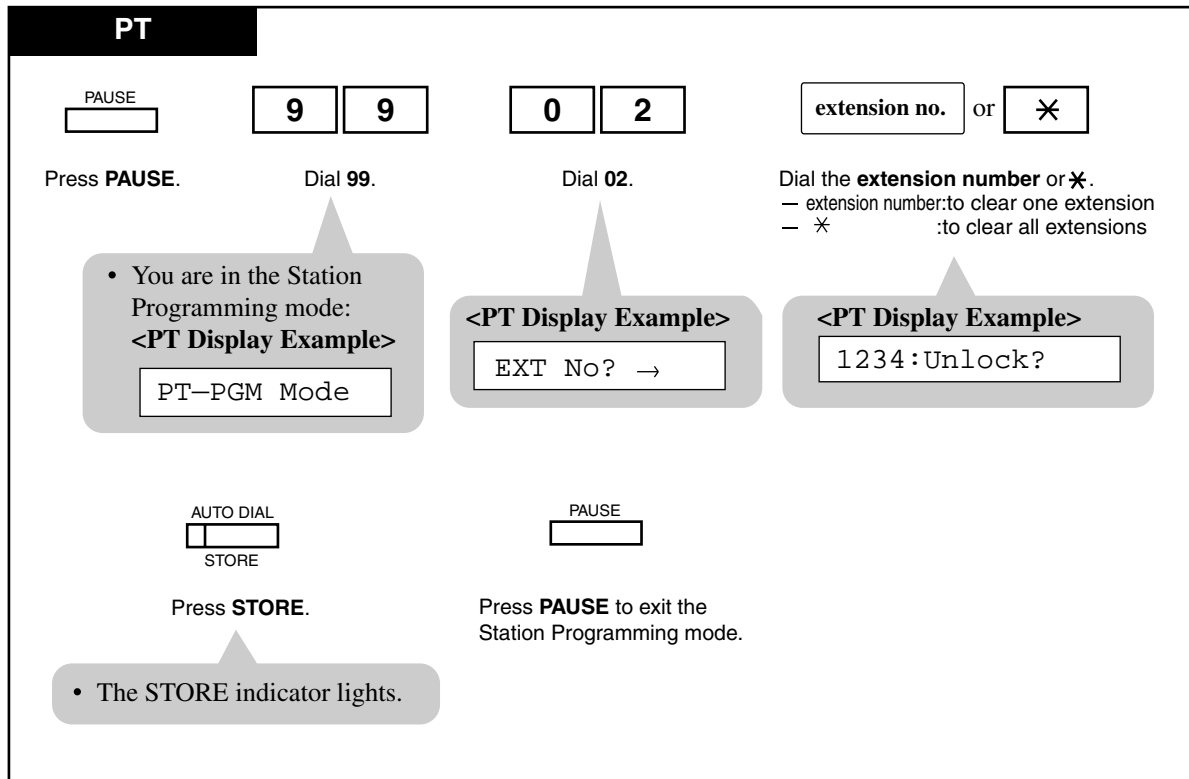

### Conditions

- If the extension user forgets their preset password, they can ask the Manager or an Operator to clear the password.

### User Manual References

4.3.21 Call Log Lock, Incoming in the Personal Area [PT only]

## 4.4.5 Call Log Lock, Incoming in the Common Area

The operator or manager can lock the displays of extensions so that the "Call Log, Incoming" feature is not shown on the displays when the Caller ID Indication — Common button is pressed. It prevents others from seeing the information stored in the common area.

### Locking

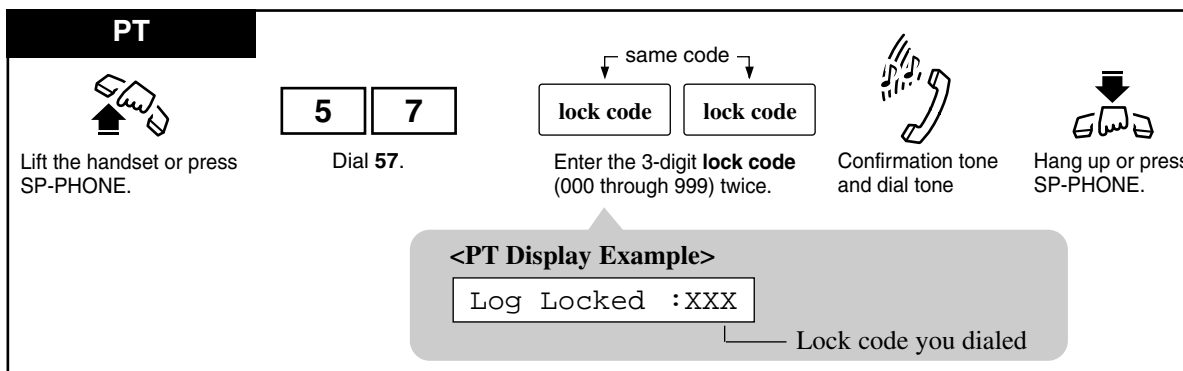

### Unlocking

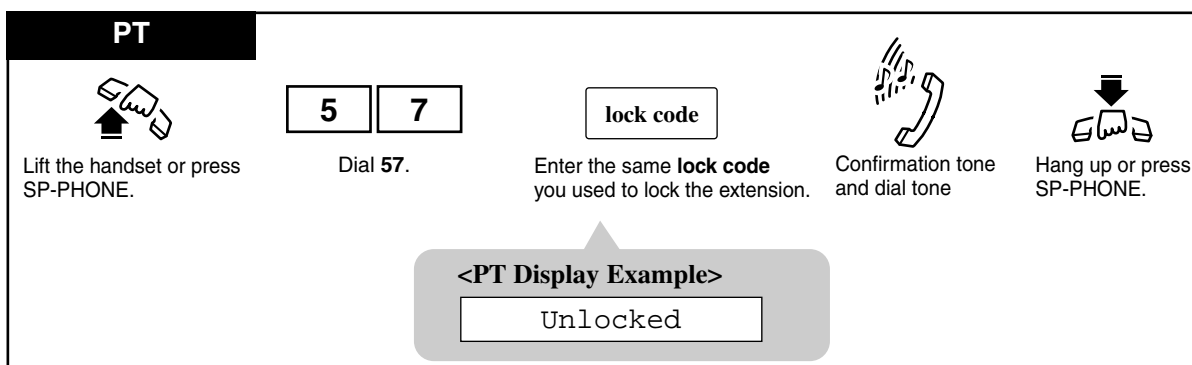

### Conditions

- **Call Log Lock Control, Incoming in the Common Area — CANCEL**  
If the Manager or an Operator forgets the lock code, refer to 4.4.4 Call Log Lock Control, Incoming in the Personal Area — CANCEL.

### Programming Guide References

- [100] Flexible Numbering
- [406] Caller ID Assignment

### **User Manual References**

4.3.20 Call Log, Incoming [PT only]

4.3.21 Call Log Lock, Incoming in the Personal Area [PT only]

## 4.4.6 Live Call Screening Password Control\*<sup>1</sup>

The Manager and the Operators can clear the Live Call Screening password of any extension.

### Programming

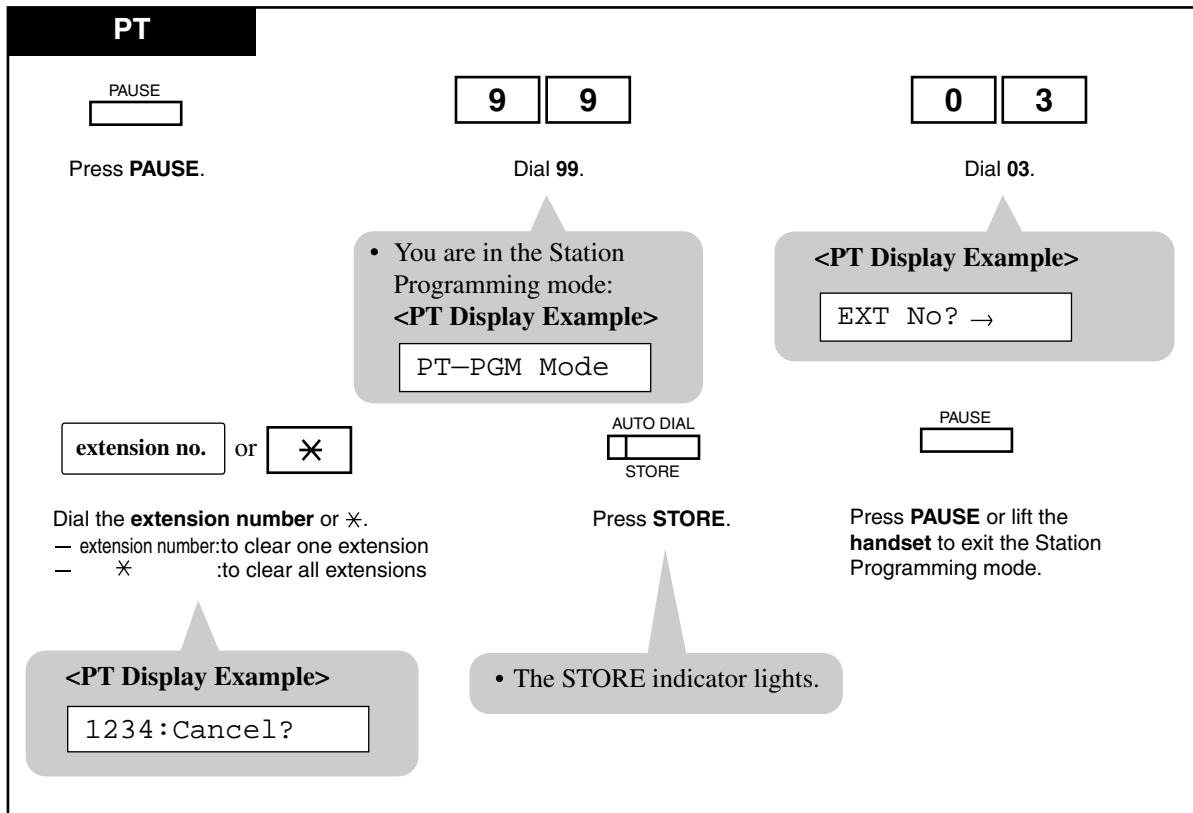

### Conditions

- If the extension user forgets their pre-set password, they can ask the Manager or an Operator to clear the password.

### User Manual References

4.3.52 Live Call Screening (LCS) [PT only]

\*<sup>1</sup> Available when the Advanced Hybrid System is connected to a Proprietary Telephone capable Panasonic Voice Processing System (one that supports DPT Integration; e.g., KX-TV50).

## 4.4.7 Outgoing Message (OGM)

The Manager and the Operators can record and play back outgoing voice messages.

The following three types of outgoing messages can be recorded.

**DISA message:**

This message is played when an outside caller accesses the system via DISA line. There are two different DISA messages.

**Timed Reminder (wake-up) message:**

This message is used in Timed Reminder. When answering the Timed Reminder alarm (often used as a wake-up call), the extension user will hear this message. There is only one Timed Reminder message.

## Recording a message

Any Telephone



Lift the handset or press  
SP-PHONE/MONITOR.

3	6	1
---	---	---

Dial **361**.

OGM no.

Enter OGM number  
(1 through 3).



Confirmation  
tone

**<PT Display Example>**

OGM 2	Rec. : 00
-------	-----------

Time counter  
(seconds)

OGM number  
selected  
(1 through 3)

- The STORE indicator light flashes red slowly  
Recording starts after the confirmation tone.



Record a message.

AUTO DIAL  
  
 STORE

Press **STORE** or wait until  
a maximum recording time  
has elapsed.



Confirmation  
tone

- The recording is stopped and STORE indicator light turns steady red.
- The recorded message will be played back automatically.

**<PT Display Example>**

OGM 2	Play : 28
-------	-----------

AUTO DIAL  
  
 STORE

Press **STORE** or wait until  
playback is finished



Confirmation  
tone



Hang up or press  
SP-PHONE/MONITOR.

- The STORE indicator light turns off.

## Playing back a message

Any Telephone



Lift the handset or press SP-PHONE/MONITOR.

3	6	2
---	---	---

Dial **362**.

OGM no.
---------

Enter **OGM number** (1 through 3).



Confirmation tone

AUTO DIAL
STORE

Press **STORE** or wait until playback is finished.



Confirmation tone

**<PT Display Example>**

OGM 1	Play: 28
-------	----------

Time counter (seconds)

- The STORE indicator lights.
- The message is played back and the counter starts.

- The STORE indicator light turns off.

### Conditions

- OGM Type**
  - 1: for DISA Message 1
  - 2: for DISA Message 2
  - 3: for Timed Reminder Message
  - 4: No Use
- You can select a maximum recording time of 0/16/32/64 seconds for each message (Outgoing Message Time). The total length must be under sixty four seconds.

### Programming Guide References

[215] Outgoing Message Time

### User Manual References

- 4.3.37 Direct Inward System Access (DISA)
- 4.3.78 Timed Reminder



## 4.4.8 Remote Station Lock Control

The Manager and the Operators can remotely lock or unlock any extension. To lock an extension, you can select to lock outside calls or intercom calls.

### Programming

PT

PAUSE

Press **PAUSE**.

Dial **99**.

Dial **01**.

or

Dial the **extension number** or **\***.

— extension number: to clear one extension  
— \* : to clear all extensions

**<PT Display Example>**

PT-PGM Mode

**<PT Display Example>**

EXT No? →

or  or

Dial **1** or **2** or **3**.

— 1 : to unlock  
— 2 : to lock outside calls  
— 3 : to lock intercom calls (except operator calls)

AUTO DIAL  
  
STORE

Press **STORE**.

PAUSE

Press **PAUSE** or lift the **handset** to exit the Station Programming mode.

**<PT Display Example>**

1234 : CO Lock

**<PT Display Example>**

The STORE indicator lights.

### Conditions

- This feature supersedes the "Electronic Station Lockout" feature. If "Electronic Station Lockout" has already been set by the extension user and this feature is set, the extension user cannot cancel the lock. Only the Manager and the Operators can cancel the lock.
- "Operator Call" is always available from any extension whether it is locked or not.

### User Manual References

4.3.41 Electronic Station Lockout

## 4.4.9 System Working Report

The operator or manager can print or clear the system working report. For details about the recorded contents, please consult with your dealer.

Any Telephone



Lift the handset  
or press SP-PHONE  
/MONITOR.

7

9

4

Dial **794**.

1

 or 

0

Dial **1** or **0**.  
– **1**: to print out the data  
– **0**: to clear the data



Confirmation  
tone and dial  
tone



Hang up or press  
SP-PHONE  
/MONITOR.

**<PT Display Example>**

SWR Data Dump

 – 1: to print out  

SWR Data Clear

 – 0: to clear

### Conditions

- A printer connected to the Serial Interface (RS-232C) connector can be used to print the recorded data.
- If the recorded data is cleared, new data will be recorded.

### Features Guide References

System Working Report

## 4.4.10 The 301st Call Log, Incoming in the Common Area Treatment

When the call log is full in the common area (300 calls are stored), you can select how the 301st call is treated. Either a new call can be disregarded or the new call can overwrite the oldest call that has been already confirmed (Default: Record the new call.).

### Overwriting the call log in the common area

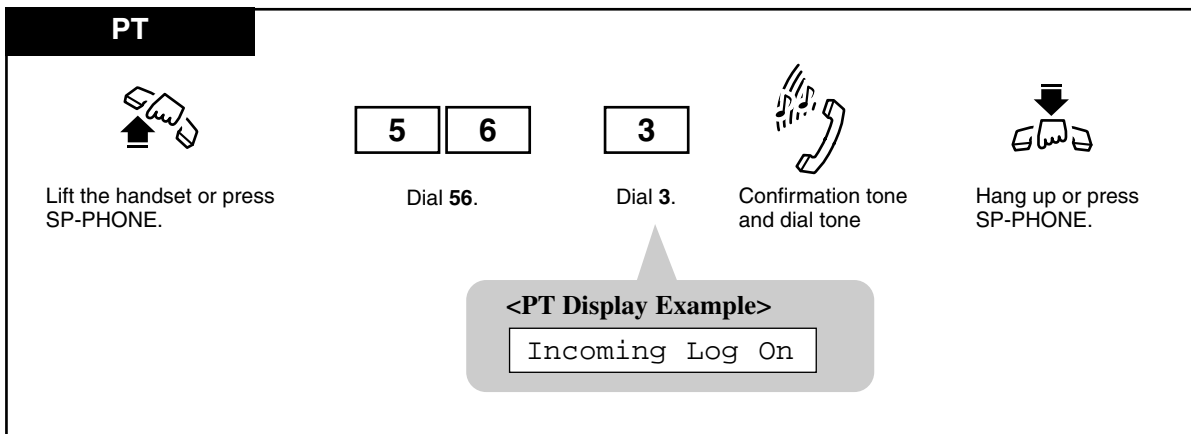

### Disregarding the 301st call in the common area

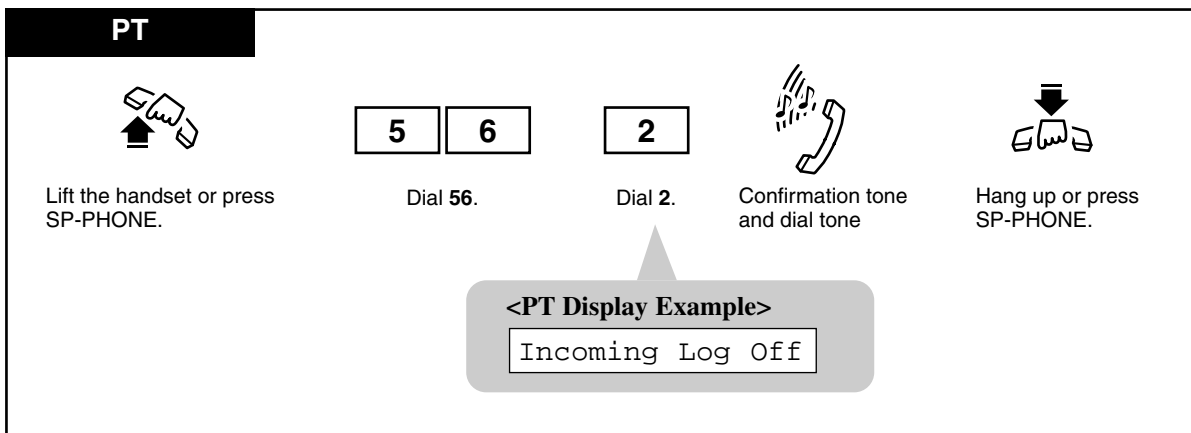

### Conditions

- When "Disregarding the 301st call in the common area" has been set and 300 calls are logged or all of the old information has been overwritten, the Caller ID Selection — Common button indicator lights and informs you that no more calls can be logged.
- When "Overwriting the 301st call in the common area" has been set and all of old information has been overwritten in the common area, the Caller ID selection — Common button indicator lights and informs you that no more calls can be logged.

## **User Manual References**

4.3.20 Call Log, Incoming [PT only]

## 4.4.11 Timed Reminder, Remote (Wake-Up Call)

The Manager and the Operators can remotely set or cancel the Timed Reminder to the desired extension.

### Setting

**Any Telephone**

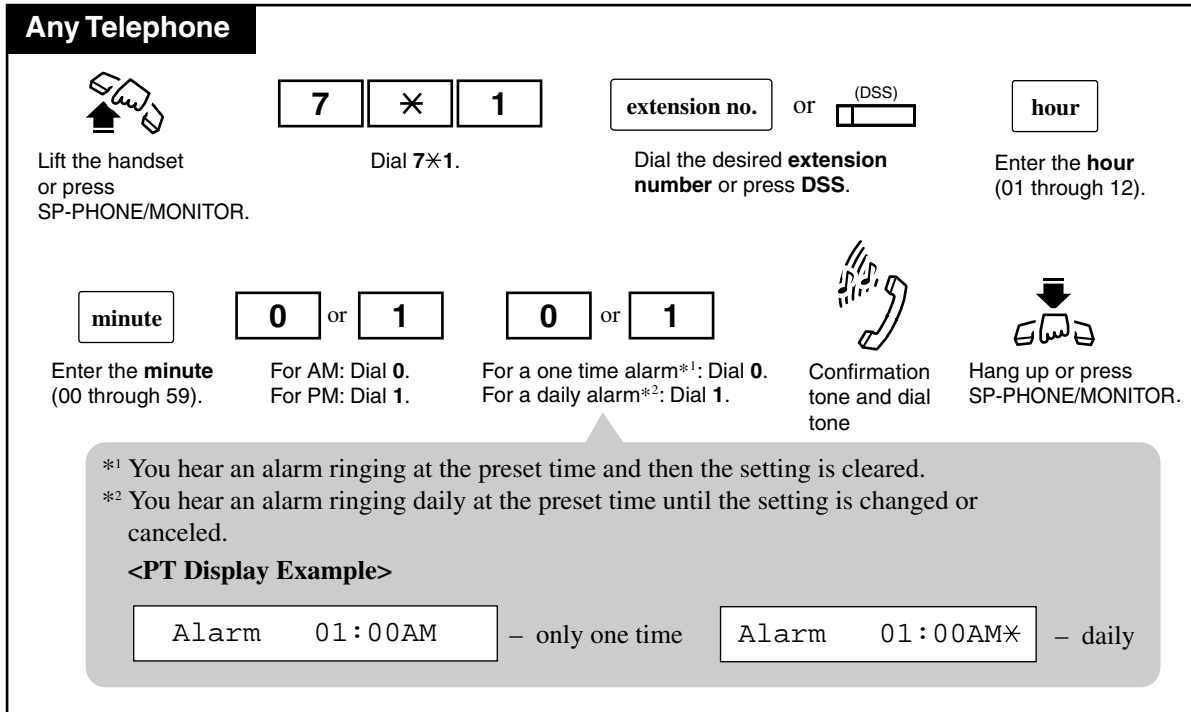

The diagram illustrates the steps to set a timed reminder. It starts with lifting the handset or pressing SP-PHONE/MONITOR. The user then dials 7\*1. Next, they dial the desired extension number or press DSS. Then, they enter the hour (01 through 12). After that, they enter the minute (00 through 59). For AM, they dial 0; for PM, they dial 1. For a one-time alarm, they dial 0; for a daily alarm, they dial 1. Finally, they hear a confirmation tone and dial tone, and then hang up or press SP-PHONE/MONITOR.

Lift the handset or press SP-PHONE/MONITOR.

Dial 7\*1.

Dial the desired **extension number** or press **DSS**.

Enter the **hour** (01 through 12).

Enter the **minute** (00 through 59).

For AM: Dial 0.  
For PM: Dial 1.

For a one time alarm\*<sup>1</sup>: Dial 0.  
For a daily alarm\*<sup>2</sup>: Dial 1.

Confirmation tone and dial tone

Hang up or press SP-PHONE/MONITOR.

\*<sup>1</sup> You hear an alarm ringing at the preset time and then the setting is cleared.  
\*<sup>2</sup> You hear an alarm ringing daily at the preset time until the setting is changed or canceled.

<PT Display Example>

Alarm 01:00AM – only one time      Alarm 01:00AM\* – daily

### Canceling

**Any Telephone**

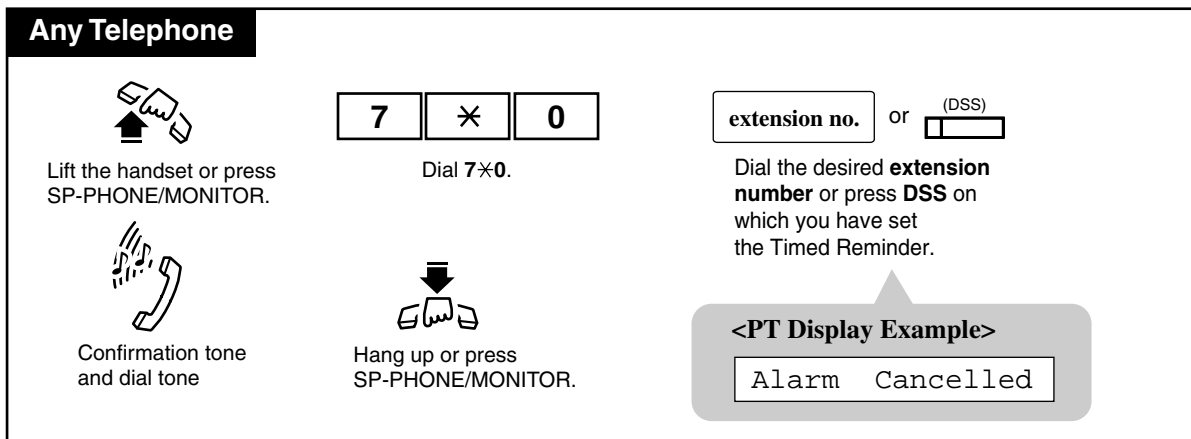

The diagram illustrates the steps to cancel a timed reminder. It starts with lifting the handset or pressing SP-PHONE/MONITOR. The user then dials 7\*0. Next, they dial the desired extension number or press DSS. Finally, they hear a confirmation tone and dial tone, and then hang up or press SP-PHONE/MONITOR.

Lift the handset or press SP-PHONE/MONITOR.

Dial 7\*0.

Dial the desired **extension number** or press **DSS** on which you have set the Timed Reminder.

Confirmation tone and dial tone

Hang up or press SP-PHONE/MONITOR.

<PT Display Example>

Alarm Cancelled

### Checking the time setting

Display PT



Lift the handset or press  
SP-PHONE.

7

\*

2

Dial 7\*2.

extension no.

OR

(DSS)



Hang up or press  
SP-PHONE.

**<PT Display Example>**

- If "10:10" has been set, the display shows;
 

Alarm 10:10AM	– only one time	Alarm Not Stored
or		
Alarm 10:10AM*	– daily	
- If time setting is not stored.

### Conditions

- The system clock must be set correctly beforehand.
- There is no limit to the number of the extensions who can set the Timed Reminder at the same time.
- Only the latest time setting is valid at the extension whether it was set by the extension user (Timed Reminder) or by the Manager extension or an Operator (Timed Reminder, Remote).
- **Station Message Detail Recording (SMDR)**  
SMDR automatically records the detailed Timed Reminder information (date, time, extension number, start/no answer). It is programmable to be printed out when the Timed Reminder starts and the alarm is not answered. Refer to "Station Message Detail Recording (SMDR)" in the Features Guide for further information.

### Programming Guide References

- [000] Date and Time Set
- [217] Timed Reminder Alarm Ring Time
- [990] System Additional Information

### User Manual References

- 4.3.78 Timed Reminder

# *Section 5*

## *DSS Console Features*

*Note: All illustrations of the PT (paired telephone) used in these operating instructions are based on model KX-T7130 / KX-T7135.*

## 5.1 Configuration

### 5.1.1 Configuration

With a Directed Station Selection (DSS) Console, you can make or transfer calls and access system features with the touch of a button. The DSS Console must be connected to the Panasonic Advanced Hybrid System and paired with a PT. System Programming is required to designate the jack number of the paired PT. With a paired telephone, you can carry out the following operations using the DSS Console:

- Direct access to an extension (Direct Station Dialing)
- Quick access to an outside party (One-Touch Dialing)
- Quick access to a system feature (One-Touch Access for System Features)
- Easy transfer to an extension (Call Transfer)

The above functions are enabled simply by pressing buttons on the console which are pre-programmed as function buttons through Station Programming.

Panasonic KX-T series DSS Console is categorized as follows:

KX-T7040	DSS Console (32-DSS buttons, 16-PF buttons)
----------	---

#### Conditions

- The DSS Console and the PT should be placed side by side on your desk.
- A single line telephone cannot be utilized in conjunction with the DSS Console.
- For System Programming, please consult with your dealer.

#### Programming Guide References

[007] DSS Console Port and Paired Telephone Assignment



## 5.1.2 Location of Controls

### **DSS Buttons with a Busy Lamp Field (BLF) (01 through 32):**

These are used to access extensions. The BLF indicates the busy or idle status of each extension in the system. These buttons can also be changed to other feature buttons.

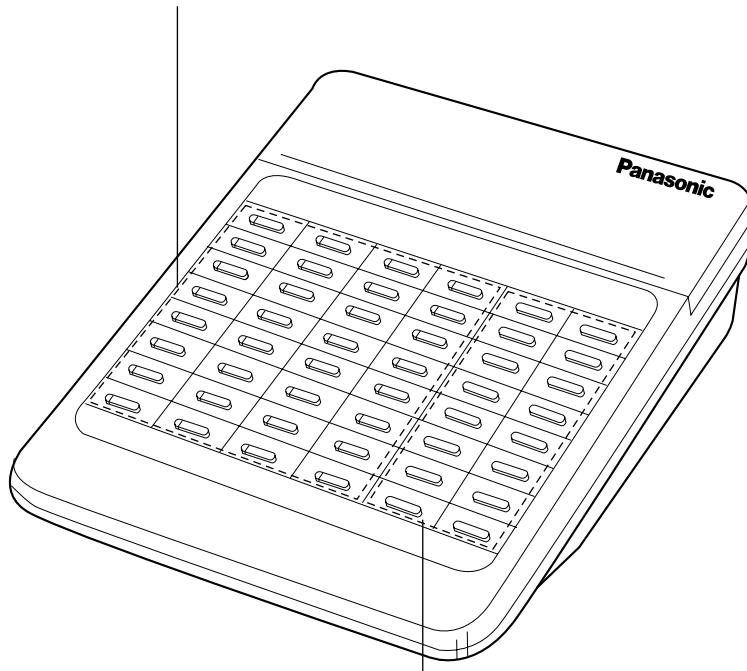

### **PF (Programmable Features) Buttons (01 through 16):**

These buttons are provided with no default settings. With a paired telephone, you can program the buttons as other feature buttons.

### **<Back View>**

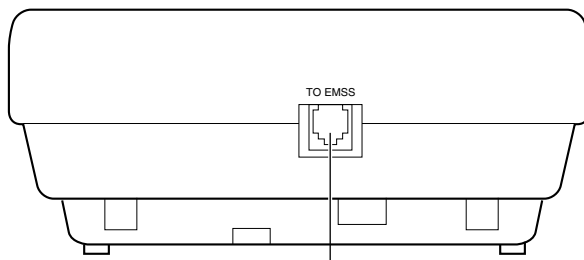

Connects to the KX-TA1232 System.

### 5.1.3 Feature Buttons

A DSS Console has the following types of Feature Buttons:

**DSS Buttons with Busy Lamp Field (BLF)**

Used to access extensions. The BLF indicates the busy or idle status of each extension in the system. These buttons can also be changed to other function buttons.

**PF (Programmable Feature) Buttons**

These buttons are provided with no default settings. With a paired telephone, you can program the buttons as other function buttons.

## 5.2 Station Programming

### 5.2.1 Station Programming Instructions

PF buttons are provided with no default settings, while each DSS button has a default setting as follows. DSS 01-32: extension numbers 101-132 (DSS 33-66: not stored).

To meet your various needs, DSS buttons can be changed to other function buttons.

Every DSS or PF button can be assigned to another extension number, telephone number or feature number through Station Programming.

#### Conditions

- DSS buttons and PF buttons can be changed to any of the following feature buttons through Station Programming:

Button	DSS	PF
<b>Features to be assigned</b>		
Another DSS (Direct Station Selection)	✓	
Phantom Extension	✓	
ONE-TOUCH (One-Touch Dialing)	✓	✓
MESSAGE (Message Waiting)	✓	
FWD/DND (Call Forwarding/Do Not Disturb)	✓	✓
SAVE (Saved Number Redial)	✓	✓
ACCOUNT (Account Code Entry)	✓	✓
CONF (Conference)	✓	✓
Voice Mail (VM) Transfer	✓	✓
Two-Way Record*	✓	
Two-Way Transfer*	✓	
LCS (Live Call Screening)*	✓	
LCS (Live Call Screening) Cancel*	✓	
Night/Day (Lunch/Break) Service	✓	

- \* Available when the Advanced Hybrid System is connected to a Proprietary Telephone capable Panasonic Voice Processing System (one that supports DPT Integration; e.g., KX-TVS50).

" ✓ " indicates that the feature is available.

- When the STORE button is pressed after programming, you will hear beep tones as follows.
  - One beep: The entry is changed from one that was stored previously.
  - Two beeps: The entry is the same as on stored previously.

### **Programming Guide References**

[007] DSS Console Port and Paired Telephone Assignment

### **User Manual References**

2.2.2 Flexible Button Assignment

## 5.2.2 Extension Number Assignment

You can assign the desired extension number to a DSS button.

– Be sure that you are in the Station Programming mode: Press [PAUSE] [9] [9].

**PT and DSS Console**

[DSS Console]	[Paired telephone]	[Paired telephone]	[Paired telephone]
<input type="text" value="(DSS)"/>	<input type="text" value="1"/>	<input type="text" value="extension no."/>	<input type="text" value="AUTO DIAL"/> <input type="text" value="STORE"/>
Press the desired <b>DSS</b> button.	Dial <b>1</b> .	Enter the <b>desired extension number</b> .	Press <b>STORE</b> .

**<PT Display Example>**

EXT-

**<PT Display Example>**

EXT-xxxx

 (-xxxx:extension number)
 

- To erase an incorrect entry, press the **TRANSFER (CLEAR)** button.  
(The TRANSFER button becomes the CLEAR button in the Station Programming mode.)

- The STORE indicator lights.
- The display shows the initial programming mode.

— To exit the Station Programming mode: Press [PAUSE] or lift the handset.

### 5.2.3 One-Touch Dialing Assignment

You can assign a DSS or PF button as a One-Touch Dialing button. The number can be an extension number or a telephone number. Up to 16 digits can be stored into each memory location.

—Be sure that you are in the Station Programming mode: Press [PAUSE] [9] [9].

**PT and DSS Console**

[DSS Console]	[Paired telephone]	[Paired telephone]	[Paired telephone]
(DSS) <input type="text"/> or (PF) <input type="text"/>	<input style="width: 40px; height: 25px; border: 1px solid black;" type="text" value="2"/>	<input style="width: 100px; height: 25px; border: 1px solid black;" type="text" value="desired no."/>	AUTO DIAL <input style="width: 40px; height: 15px; border: 1px solid black;" type="text"/> STORE
Press the desired <b>DSS</b> or <b>PF</b> button.	Dial <b>2</b> .	Enter the <b>desired number</b> (extension number, phone number, etc.).	Press <b>STORE</b> .

- Up to 16 digits can be stored.
- When you assign an outside phone number, you must enter a line access code first.
- To erase an incorrect entry, press the **TRANSFER (CLEAR)** button.  
(The TRANSFER button becomes the CLEAR button in the Station Programming mode.)

- The STORE indicator lights.
- The display shows the initial programming mode.

— To exit the Station Programming mode: Press [PAUSE] or lift the handset.

## 5.2.4 One-Touch Access Assignment for System Features

You can assign the desired feature number to a DSS or PF button.

—Be sure that you are in the Station Programming mode: Press [PAUSE] [9] [9].

**PT and DSS Console**

[DSS Console]	[Paired telephone]	[Paired telephone]	[Paired telephone]
(DSS) <input style="width: 40px; height: 15px;" type="text"/> or (PF) <input style="width: 40px; height: 15px;" type="text"/>	<input style="width: 40px; height: 25px; border: 1px solid black; text-align: center; font-size: 1.2em;" type="text" value="2"/>	<input style="width: 80px; height: 20px; border: 1px solid black; text-align: center;" type="text" value="feature no."/>	AUTO DIAL <input style="width: 40px; height: 15px;" type="text"/> STORE
Press the desired <b>DSS</b> or <b>PF</b> button.	Dial <b>2</b> .	Enter the <b>desired feature number</b> .	Press <b>STORE</b> .

- Up to 16 digits can be stored.
- For example, if you wish to gain access to the "Paging-All" feature, enter the feature number 330.
- To erase an incorrect entry, press the **TRANSFER (CLEAR)** button.  
(The TRANSFER button becomes the CLEAR button in the Station Programming mode.)

- The STORE indicator lights.
- The display shows the initial programming mode.

— To exit the Station Programming mode: Press [PAUSE] or lift the handset.

## 5.3 DSS Console Features

### 5.3.1 Direct Station Dialing

An extension can be called and accessed, simply by pressing a DSS button. The BLF shows if the extension is busy.

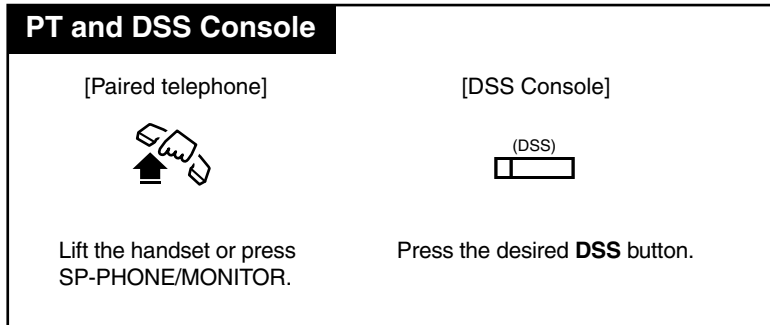



## 5.3.2 One-Touch Dialing

The stored number is dialed automatically by pressing a programmed DSS or PF button.

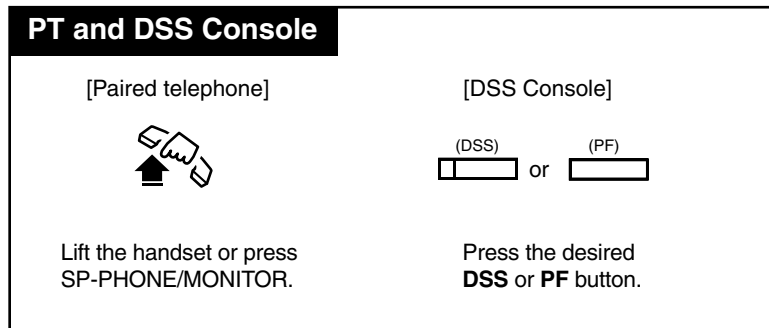

### 5.3.3 One-Touch Access for System Features

You can access system features by pressing a programmed DSS or PF button.

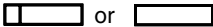
PT and DSS Console	
[Paired telephone]	[DSS Console]
	(DSS) or (PF) 
Lift the handset or press SP-PHONE/MONITOR.	Press the desired <b>DSS</b> or <b>PF</b> button.

## 5.3.4 Call Transfer

A call can be transferred to an extension by using the DSS button.

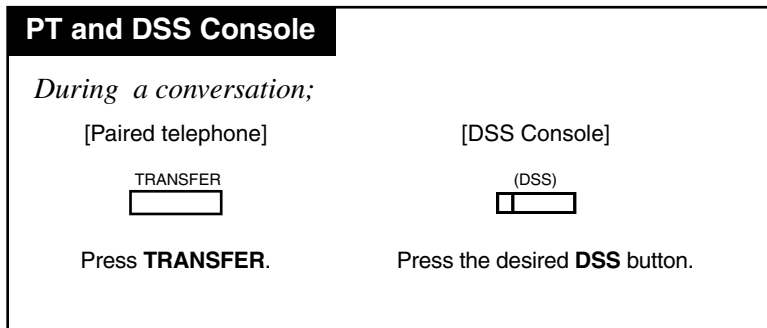

### One-Touch Transfer

An outside call can be transferred to an extension with an One-Touch operation.

The One-Touch Transfer function must be set through System Programming.

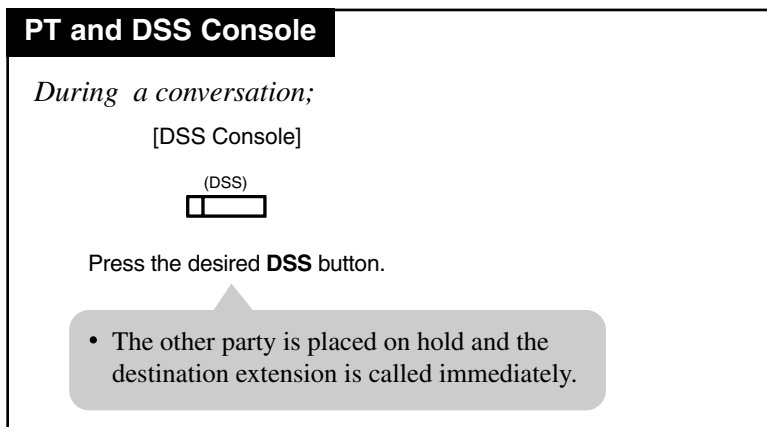

### Programming Guide References

[108] Automatic Hold by CO / DSS Button



# *Section 6*

# *Appendix*

## 6.1 Appendix

### 6.1.1 Display Examples

The following explains the displays in more detail.

Display	Description
Set Time & Date	Factory setting. — Shown on the manager's display only.
FRI JAN01 12:00A	The current date and time are not set. — Pressing "*" while on-hook alternates between this display and the self extension number and name display.
123:	Make or receive an intercom call, name is not assigned.
123:Tony Viola	Make or receive an intercom call; name is assigned. Make or receive an intercom call after the call is transferred; name is assigned. Confirm key programming on the DSS or MESSAGE button.
123→CO02:	Called by an outside line after a call is transferred.
234: Busy	Destination extension is busy. Destination extension is busy after the call is transferred.
456: DND	Destination extension is set to "Do Not Disturb (DND)".
567: Free	Called by "Camp-On" (intercom recall).
1234567890	Called by an outside line with the Caller ID* <sup>1</sup> -number.
Panasonic	Called by an outside line, with the Caller ID*-number.
950-1001PP12345&	Confirm key programming on the REDIAL, SAVE, or One-Touch Dialing button.
456: DND	Destination extension is set to "Do Not Disturb (DND)" after the call is transferred.
Account	Confirm key programming on the Account button.
Alarm 10:15AM	Complete to set or called by "Timed Reminder" (one-time mode). Confirm "Timed Reminder" programming.
Alarm 10:15AM*	Complete to set or called by "Timed Reminder" (everyday mode). Confirm "Timed Reminder" programming.
Alarm Cancelled	Cancel "Timed Reminder".

<b>Display</b>	<b>Description</b>
Alarm Not Stored	Confirm "Timed Reminder" programming when it is not stored.
All Call Page	Access to "Paging — All".
At Ext 123	Absent Message 3.
Back at 11:00	Absent Message 4.
BGM On	Start BGM.
BGM Off	Stop BGM.
Break Mode	Complete to set "Break Mode".
Busy	Resource is busy.
Busy Ovrde Allow	Cancel "Executive Busy Override Deny".
Busy Ovrde Deny	Complete to set "Executive Busy Override Deny".
C.Pickup Allow	Cancel "Call Pickup Deny".
C.Pickup Deny	Complete to set "Call Pickup Deny".
Callback Ext1234	Complete to set "Camp-On".
Callback CO01	Complete to set "Camp-On".
Callback TRG 1	Complete to set "Camp-On".
Callback CO *	Complete to set "Camp-On" when there is no idle outside line.
Call Parked at 1	Complete to set "Call Park".
Call Waiting Off	Cancel "Call Waiting".
Call Waiting on	Complete to set "Call Waiting".
CID Log Clear	Clear all logs.
CO 01	Idle outside line is captured.
CO01:	Called by an outside line.
CO 01 0:01'15	Duration time of incoming outside call.
CO 01 & CO 02	Conference with two outside lines. Called by hold recall. — "Conference, Unattended"
CO 03: Free	Called by "Camp-On" (Outside line recall).
CO 02:AB COMPANY	Received an outside call with a Caller ID; the outside line number and the outside line name are assigned.
Conference	Confirm key programming on the Conference button.
CO in Use	The selected outside line is busy.
CO Not Assigned	The desired outside line is restricted (not assigned).

Display	Description
Data Mode Off	Cancel "Data Line Security".
Data Mode On	Complete to set "Data Line Security".
Day Mode	Day mode status. (Cancel Night mode.) — "Night Service"
Do Not Disturb	Confirm key programming on the FWD/DND button. Complete to set "Do Not Disturb (DND)".
Door 1 Open	Complete to open the door.
Doorphone 1	Make or receive a doorphone call.
E123 & CO 01	Conference with an extension and CO line.
E123 & E234	Conference with two extensions.
Enter ACCNT Code	Pressing Account Button. — "Account Code Entry"
Ext Data Clear	Execute "Station Feature Clear".
External BGM Off	Stop BGM through external pager. — "Background Music (BGM) — External"
External BGM On	Start BGM through external pager. — "Background Music (BGM) — External"
Extrnl Page All	Access to "Paging — External" (- to all external pagers).
Extrnl Page 1	Access to "Paging — External" (- to a specific external pagers).
FWD(ALL) Ext123	Complete to set "Call Forwarding — All Calls". Confirm key programming on the FWD/DND button.
FWD(B/NA)Ext100	Complete to set "Call Forwarding — Busy/No Answer". Confirm key programming on the FWD/DND button.
FWD(BSY) Ext234	Complete to set "Call Forwarding — Busy". Confirm key programming on the FWD/DND button.
FWD(CO) 91201431	Complete to set "Call Forwarding — to Outside Line". Confirm key programming on the FWD/DND button.
FWD(From)Ext123	Complete to set "Call Forwarding — Follow Me".
FWD(NA)Ext345	Complete to set "Call Forwarding — No Answer". Confirm key programming on the FWD/DND button.
FWD Cancel E123	Cancel "Call Forwarding — Follow Me (All Calls)" at another extension.
FWD/DND Cancel	Cancel "Call Forwarding" or "Do Not Disturb (DND)".



<b>Display</b>	<b>Description</b>
Gone Home	Absent Message 2.
Group Page 1	Access to "Paging — Group" (- to a particular paging group).
Group Page All	Access to "Paging — Group" (- to all paging groups).
In a Meeting	Absent Message 6.
Incoming Log Off	Cancel "Incoming Call Log".
Incoming Log On	Complete to set "Incoming Call Log".
Locked NO. :123	Complete to set "Electronic Station Lockout".
Log Locked :123	Complete to set "Call Log Lock, Incoming".
Lunch Mode	Complete to set "Lunch Mode".
Message Cancel	Cancel Absent Message.
MW at Ext 1234	Complete to set "Message Waiting".
MW Not Accepted	Not complete to set "Message Waiting".
MW Cancel:E1234	Cancel "Message Waiting" of desired extension.
MW Cancelled	Cancel one's own "Message Waiting".
New:002 Old:003	Confirm the number of logged calls.
Night Mode	Night mode status. (Cancel Day mode.) — "Night Service"
No Held Call	There is no held call when retrieving call on hold or parked call.
No Incoming Call	There is no incoming call when trying to pick up the call.
Not Valid	Illegal operation.
OGM 1 Play:28	When playing back the OGM.
OGM 1 Rec:12	When recording back the OGM.
Out Until 12/12	Absent Message 5.
Paging Deny Off	Cancel "Paging — DENY".
Paging Deny On	Complete to set "Paging — DENY".
Parallel Off	Cancel "Paralleled Telephone Connection".
Parallel On	Complete to set "Paralleled Telephone Connection".
Park at 0 N/A	Not complete to set "Call Park".
PT-PGM Mode	Entered the Station Programming mode.
RCL:Tony Viola	Called by transfer recall, with name. — "Call Transfer"

Display	Description
RCL:Ext 1234	Called by transfer recall, without name. — "Call Transfer"
Restricted	An outgoing call is restricted.
Room Monitor Off	Cancel "Room Monitor".
Room Monitor On	Complete to set "Room Monitor".
Transfer to CO	The destination extension is set "Call Forwarding — to Outside Line".
Unlocked	Cancel "Call Log Lock, Incoming". Cancel "Electronic Station Lockout".
Will Return Soon	Absent Message 1.

<sup>1</sup> Provides you with a caller's information, such as his/her name and telephone number, on the outside line assigned to receive Caller ID service calls. This requires a subscription for caller identification services. For more details, please consult with your dealer.

### Examples — in Station Programming mode

Display	Description
Account	Account button is assigned.
CID-C Indication	The Caller ID Indication — Common button is assigned.
CID-P Indication	The Caller ID Indication — Personal button is assigned.
CID-C Selection	The Caller ID Selection — Common button is assigned.
CID-P Selection	The Caller ID Selection — Personal button is assigned.
C.W. Tone1	Select Call Waiting tone.
Clear Ready?	Available to clear Station Programming data.
CO-01	Single-CO (S-CO) button is assigned.
Conference	Conference (CONF) button is assigned.
140:CO Lock	Complete to lock the outside calls of other extension. — "Remote Station Lock Control".
140:ICM Lock	Complete to lock the intercom calls of other extension. — "Remote Station Lock Control".
140:Unlock	Cancel "Remote Station Lock Control".
Ext-123	DSS button is assigned.
FWD/DND	FWD/DND button is assigned.
Hands-free:Off	Disable "Full One-Touch Dialing" mode.

Display	Description
Hands-free:On	Enable "Full One-Touch Dialing" mode.
Jack04 <=> EXT104	Confirm jack number and extension number.
Loop-CO	Loop-CO (L-CO) button is assigned.
Message Waiting	Message Waiting (MESSAGE) button is assigned.
MW-123	The Another Extension Message Waiting button is assigned.
NIGHT	Night/Day button is assigned.
Not Stored	No programming is assigned.
Pref.In :CO-02	Select "Prime Line (Outside Line) Preference — Incoming".
Pref.In :NO	Select "No Line Preference — Incoming".
Pref.In :Ring	Select "Ring Line Preference — Incoming".
Pref.Out:CO-02	Select "Prime Line (Outside Line) Preference — Outgoing".
Pref.Out:ICM	Select "Prime Line (INTERCOM) Preference — Outgoing".
Pref.Out:Idle	Select "Idle Line Preference — Outgoing".
Pref.Out:No	Select "No Line Preference — Outgoing".
Save	SAVE button is assigned.
Tone Call	Select Ring-Calling mode.
TRK GRP-3	Group-CO (G-CO) button is assigned.
VTR-101	Voice Mail (VM) Transfer button is assigned.
Voice Call	Select Voice-Calling mode.
092-555-2111	One-Touch Dialing button is assigned.

### Conditions

- If the displayed characters exceed sixteen digits, "&" is shown at the right-hand edge.
- The duration time display is only shown when you make or receive an outside call. Count start time for outgoing calls can be programmed as desired.
- When you confirm key programming, be sure to press a button while on-hook. If the "Full One-Touch Dialing" feature is set, dialing mode will start when pressing PF (Programmable Feature), DSS (Direct Station Selection), SAVE or REDIAL button.

## 6.1.2 Feature Number List

Numbers listed below are the initial factory settings (default value). There are flexible feature numbers and fixed feature numbers. To change the flexible feature numbers, System Programming is required. For programming instructions, please consult with dealer. Some Additional Required Digits are different depending on the mode of the Advanced Hybrid System your telephone is connected to.

### Flexible Feature Numbers

Feature	Default	Additional Digits
1st hundred block extension	1	0-9, 00-99
2st hundred block extension	2	0-9, 00-99
3st through 16th hundred block extension block	—	0-9, 00-99
Absent Message capability set/cancel	750	1-9/0
Account Code Entry	49	Account code + # (99)
Automatic Callback Busy (Camp-On) cancel	46	
Background Music (BGM) — External on/off	35	
Call Forwarding — set/cancel	710	2-6/0
Call Forwarding — Follow Me set/cancel	710	7/8
Call Hold	50	
Call Hold, Retrieve outside call	53	01-12
Call Hold, Retrieve intercom call	51	extension no.
Call Log Incoming clear — personal / common	590	1/2
Call Log Incoming overwrite / disregard — personal — common	56	1/0 3/2
Call Log Lock Incoming lock	57	000-999 twice
Call Log Lock Incoming Unlock	57	000-999 (same lock code)
Call Park/Call Park Retrieve	52	0-9
Call Pickup, Directed	41	EXTN. (extension no.)
Call Pickup, Group	40	
Call Pickup, Outside Line	4*	
Call Pickup Deny set/cancel	720	1/0
Call Waiting set/cancel	731	1/0
Data Line Security set/cancel	730	1/0

---



---

**Flexible Feature Numbers**

<b>Feature</b>	<b>Default</b>	<b>Additional Digits</b>
Do Not Disturb (DND) set/cancel	710	1/0
Doorphone Call calling / door open	31 / 55	1-4
Electronic Station Lockout set	77	000-999 twice
Electronic Station Lockout cancel	77	000-999
Executive Busy Override Deny set/cancel	733	1/0
External Feature Access	6	
Live Call Screening (LCS) Password set	799	000-999 twice
Live Call Screening (LCS) Password cancel	799	000-999
Log-In/Log-Out	45	1/0
Message Waiting set/cancel	70	1+extension no. / 0+extension no.
Message Waiting call back	70	2
Night Service (Day / Night / Lunch / Break)	78	0-3
Operator Call	0	
Outgoing Message (OGM) recording/playback	36	1+OGM No. (1-3) / 2+OGM No. (1-3)
Outward Dialing — Line Access, Automatic	9	
Outward Dialing — Outside Line Group	8	1-8
Paging — All	32 / 33	*
Paging — Deny set / cancel	721	1/0
Paging — External all	32	0
Paging — External particular	32	1-2
Paging — External Answer/TAFAS Answer	42	1-2
Paging — Group all / particular	33	0/1-8
Paging — Group Answer	43	
Paralleled Telephone Connection set/cancel	39	1/0
Personal Speed Dialing	3*	0-9
Personal Speed Dialing programming	30	(0-9)+phone no. +#
Pickup Dialing (Hot Line) assign/set/cancel	74	2+phone no. +#/1/0
Redial, Last Number (for SLT)	#	
Room Monitor — set / cancel	734	1/0
Room Monitor — through a doorphone	31	
Station Program clear	790	

---



---

### Flexible Feature Numbers

Feature	Default	Additional Digits
System Speed Dialing (for SLT)	*	000-499
System Working Report print out / clear	794	1/0
Timed Reminder set	76	1+hhmm* <sup>1</sup> +(0/1)+(0/1)
Timed Reminder cancel/confirm	76	0/2
Timed Reminder, Remote set	7*	1+extension no. +hhmm* <sup>1</sup> +(0/1)+(0/1)
Timed Reminder, Remote cancel/confirm	7*	0+extension no. /2+extension no.
Walking COS set	47	Walking COS password+your extension no.

\*<sup>1</sup> hhmm hh: hour(01-12) mm: minute(00-59)

### Fixed Feature Numbers

Feature	Default
<b><i>While a busy tone is heard:</i></b>	
Automatic Callback Busy (Camp-On)	6
Busy Station Signaling (BSS)	1
Executive Busy Override	2
<b><i>While Do Not Disturb tone is heard:</i></b>	
Do Not Disturb (DND) Override	1
<b><i>During calling or talking:</i></b>	
Account Code Delimiter	#/99
Alternate Calling — Ring/Voice	*
Conference	3
Door open	5
Pulse to Tone Conversion	*#
<b><i>When the telephone is on-hook:</i></b>	
Background Music (BGM) on/off	1
Day/Night mode display	#
Date and Time display/Self-Extension Number and name display switching	*

### Conditions

- Extension numbers can be three or four digits in length. Any number can be set as the leading first or second digit.
- Flexible feature numbers can only be dialed while a dial tone is heard.

- When "\*" or "#" are included in a feature number, it will not be possible for users with dial pulse (DP) telephones to access the feature.

**Programming Guide References**

[003] Extension Number Set

[100] Flexible Numbering

**User Manual References**

3.2.3 [003] Extension Number Set

### 6.1.3 Tone List

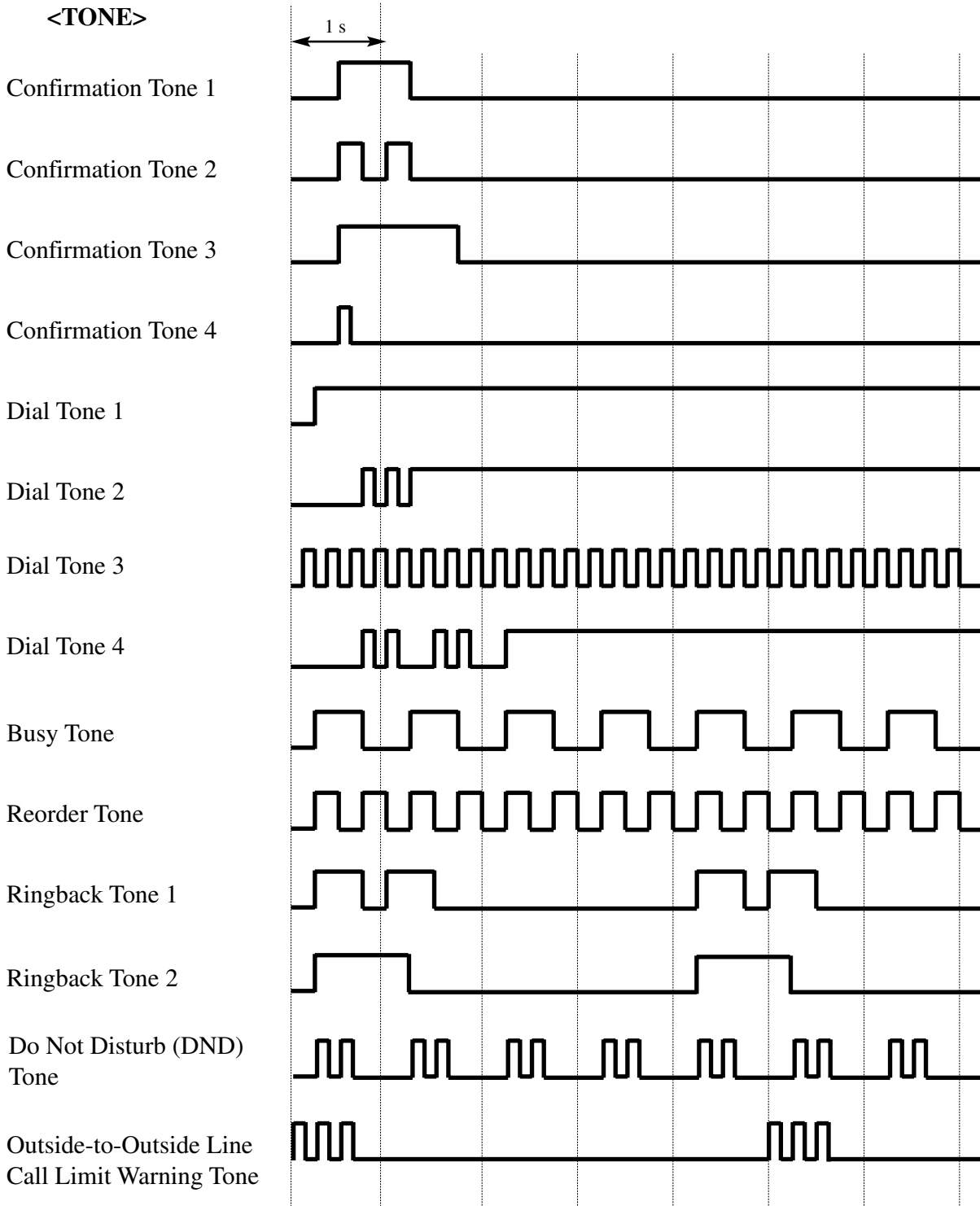



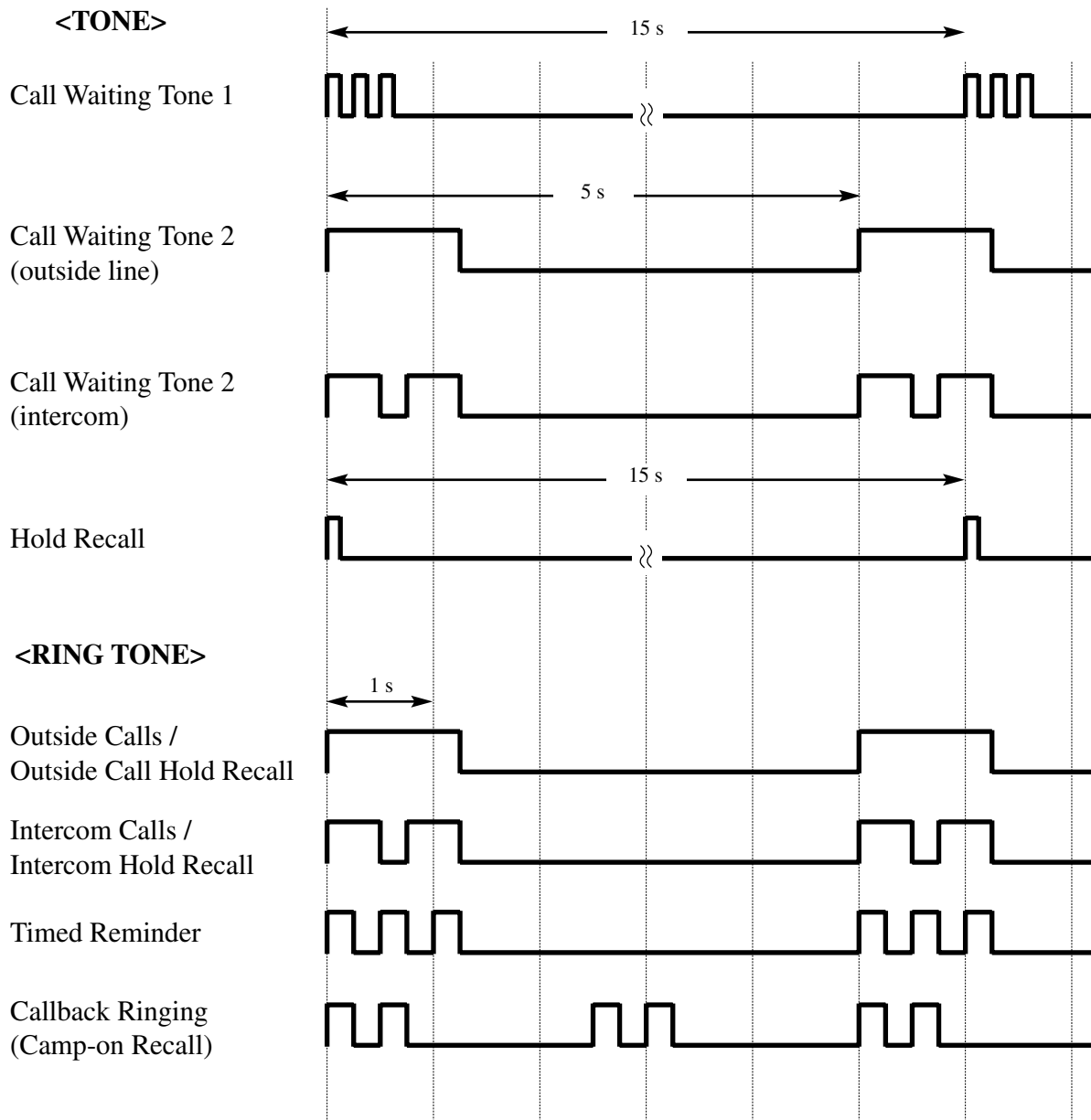

## 6.1.4 Troubleshooting

### If a power failure should occur...

Your System enables conversations between specific outside lines and extensions (Power Failure Transfer), and supports system data backup.

### Power Failure Transfer

Specific extensions are automatically connected straight to specific outside lines. This provides outside line conversations between the pre-assigned extensions and outside lines:

Outside line 01 is connected to extension jack number 01.

Outside line 03 is connected to extension jack number 09.

Outside line 09 is connected to extension jack number 17.

- All other conversations are disconnected during a power failure.
- Proprietary telephones (PTs) cannot be used during a power failure. SLTs can work in the event of a power failure.
- When power is restored after a power failure, your system automatically restarts operation, maintaining as much of the previous system data as possible.

Problem	Probable Cause	Possible Solution
Nothing is heard in the hands-free mode.	The "Headset" mode is selected.	When the headset is not used, set the mode to "Handset". Refer to "1.1.4 Initial Settings".
The unit does not ring.	<ul style="list-style-type: none"> <li>• The outside number is not programmed.</li> <li>• The Ringer Volume is set to "OFF".</li> </ul>	<ul style="list-style-type: none"> <li>• For programming outside numbers, refer to the Installation Manual.</li> <li>• Increase the Ringer Volume. Refer to "1.1.4 Initial Settings".</li> </ul>
The display flashes the following message: <div style="border: 1px solid black; padding: 2px; width: fit-content; margin: 5px 0;">Set Time &amp; Date</div>  <div style="border: 1px solid black; padding: 2px; width: fit-content; margin: 5px 0;">THU JAN01 12:00A</div>	The system internal clock does not work properly.	Consult with an authorized Panasonic Factory Service Center.

# *Section 7*

## *Index*

**A**

Absent Message Capability 69  
Accessory 4  
ACCOUNT 22, 251  
Account Code Entry 72  
Advanced Hybrid System 4, 5  
Alternate Calling - Ring / Voice 75  
Another DSS 251  
Answering, Direct Outside Line 77  
AUTO ANSWER 20  
AUTO DIAL 20  
Automatic Callback Busy (Camp-On) 78  
Automatic Disconnection 92, 93, 107, 115  
Automatic Privacy 133

**B**

Background Music (BGM) 80, 232  
Busy Station Signaling (BSS) 81  
Busy tone 160

**C**

Call Forwarding 82  
Call Forwarding - All Calls 84  
Call Forwarding - Busy 85  
Call Forwarding - Busy / No Answer 87  
Call Forwarding - CANCEL 90  
Call Forwarding - Follow Me 89  
Call Forwarding - No Answer 86  
Call Forwarding - to Outside Line 88  
Call Hold 91  
Call Hold Retrieve 95  
Call Hold, Exclusive 93  
Call Information / Log, Incoming 97  
Call Log Lock Control, Incoming in the Personal Area - CANCEL 104, 234, 235  
Call Log Lock, Incoming in the Common Area 235  
Call Log Lock, Incoming in the Personal Area 104  
Call Log, Incoming 99  
Call Log, Incoming in the Common Area - CLEAR ALL 233  
Call Park 106  
Call Park Recall 107  
Call Pickup Deny 111  
Call Pickup, Directed 108  
Call Pickup, Group 109  
Call Pickup, Outside Line 110  
Call Splitting 112  
Call Transfer 259  
Call Transfer - to Extension 114  
Call Transfer - to Outside Line 117  
Call Waiting 119, 168  
Call Waiting from Central Office 122  
Call Waiting Tone Type Assignment 36  
Call Waiting Tone Type Selection 121

Callback Order 174  
Caller ID Call Waiting 123  
Caller ID Indication - Common 22  
Caller ID Indication - Personal 22  
Caller ID Selection - Common 22  
Caller ID Selection - Personal 22  
Caller ID service 97  
Camp-On Transfer to Phantom Extension / Ring Group 125  
Class of Service 60, 88, 89, 117, 140, 148, 150, 152, 229  
CLEAR 45  
CONF 20, 22, 251  
Conference 127  
Conference, Unattended 131  
Configuration 14, 248  
Confirmation tone 160  
Consultation Hold 202

**D**

Data Line Security 120, 133, 148, 150, 205  
Date and Time Set 49  
Direct Inward System Access (DISA) 134  
Direct Station Dialing 256  
DISA built-in Automated Attendant 137  
DISA User Code Entry Failure 136  
DISA User Codes 60, 136  
Display Contrast Adjustment 25  
Display Examples 262  
Do Not Disturb (DND) 138  
Do Not Disturb (DND) Override 138, 140  
Do Not Disturb (DND) tone 160  
Door Opener 143  
Doorphone Call 141  
DSS 22  
DSS Console 248  
DTMF (Dual Tone Multi-Frequency) signal 54

**E**

Electronic Station Lockout 145  
Emergency Call 147  
END 45  
Entering Characters 48  
Executive Busy Override 129  
Executive Busy Override - Extension 148  
Executive Busy Override - Outside Line 150  
Executive Busy Override Deny 148, 150, 152, 205  
Extension Name Set 58  
Extension Number Assignment 160, 253  
Extension Number Set 55  
External Feature Access 153  
External Pager Priority 232

**F**

Feature Buttons 20, 250

Feature Number List 268  
 Fixed Buttons 20  
 FLASH 20, 38, 45, 122  
 Flash 155  
 Flash Time 153  
 Flexible Button Assignment 33, 37  
 Flexible Buttons 22  
 Floating Station 82  
 Full One-Touch Dialing 156, 180  
 Full One-Touch Dialing Assignment 36, 156  
 Function Assignment 34  
 FWD/DND 20, 22, 251

## G

Group-CO 22

## H

Hands-free Answerback 157  
 Hands-free mode 162  
 Hands-free Operation 158  
 HOLD 20

## I

Initial Display Selection 36  
 Initial Settings 25, 35  
 INTERCOM 20  
 Intercom Alert Assignment 36, 76  
 Intercom Calling 160

## L

LCS (Live Call Screening) 23, 251  
 LCS (Live Call Screening) Cancel 23, 251  
 LCS Password 168  
 LED Indication 27  
 Line Access, Automatic 182  
 Line Access, Individual 182  
 Line Access, Outside Line Group 182  
 Live Call Screening (LCS) 162  
 Live Call Screening Mode Set 36  
 Live Call Screening Password Control 237  
 Location 15, 249  
 Lockout 169  
 Log-In / Log-Out 22, 170  
 Loop-CO 22

## M

Making Calls 66  
 Memory Dialing 73, 153  
 MESSAGE 20, 22, 251  
 Message Waiting 172  
 Microphone Mute 176  
 MONITOR 20  
 Music on Hold 91  
 MUTE 20

## N

NEXT 44  
 Night / Day (Lunch / Break) Service 23, 177, 251

## O

One time switching 75  
 ONE-TOUCH 22, 251  
 One-Touch Access Assignment for System Features 255  
 One-Touch Access for System Features 258  
 One-Touch Dialing 180, 257  
 One-Touch Dialing Assignment 254  
 One-Touch Transfer 259  
 Operator / Manager Service Features 231  
 Operator Call 181  
 Outgoing Message (OGM) 238  
 Outside-to-Outside Line Call 88, 117, 137  
 Outward Dialing, Line Access 182  
 Overlay 44

## P

Paging 185  
 Paging - All 185  
 Paging - ANSWER 189  
 Paging - Deny 190  
 Paging - External 185  
 Paging - Group 185  
 Paging and Transfer 191  
 Paralleled Telephone Connection 195  
 PAUSE 20, 38, 44  
 Personal Speed Dialing 196  
 Phantom 22, 251  
 Phantom Extension 198  
 Phantom Extension Ringing 39  
 Pickup Dialing (Hot Line) 202  
 Power Failure Transfer 274  
 Preferred Line Assignment 35  
 PREV 44  
 Privacy Release 129, 204  
 Private mode 162  
 Programming Methods 47  
 Programming Mode 30  
 Proprietary Telephone 5  
 Pulse to Tone Conversion 206

## Q

Quick Dialing 207

## R

Receiving Calls 68  
 REDIAL 20  
 Redial, Last Number 208  
 Redial, Saved Number 209  
 Remote Station Lock 145

Remote Station Lock Control 241  
Ring/Voice Intercom Alerting Mode Override  
157  
Ringback tone 160  
Room Monitor 210

## S

SAVE 20, 22, 251  
Screened Call Transfer 114, 117, 199  
SECRET 38, 45  
Secret Dialing 213  
SELECT 45  
Self-Extension Number Confirmation 40  
Serial Interface (RS-232C) 242  
Single Line Telephone 5  
Single-CO 22  
SP-PHONE 20  
Station Message Detail Recording (SMDR) 218,  
246  
Station Program Clear 214  
Station Programming 30  
Station Programming Data Default Set 41  
STORE 20, 45  
System Speed Dialing 215  
System Speed Dialing Number Set 52  
System Working Report 242

## T

The 301st Call Log, Incoming in the Common Area  
Treatment 243  
Timed Reminder 216  
Timed Reminder, Remote 245  
Toll Restriction Override 219  
Toll Restriction Override by Account Code  
Entry 220  
Toll Restriction Override for System Speed  
Dialing 221  
Tone List 272  
TRANSFER 20  
Troubleshooting 274  
Trunk Answer From Any Station (TAFAS) 222  
Two-Way Record 22, 251  
Two-Way Recording into Phantom mailbox 224  
Two-Way Recording into Voice Mail 223  
Two-Way Transfer 23, 251

## U

Unscreened Call Transfer 114, 200  
User Programming 44  
User Programming Password 45

## V

Voice Mail (VM) Transfer 22, 228, 251  
Voice Mail Integration 225  
Voice Mail Transfer to Phantom Mailbox 228

Volume Control 25  
VPS Integration 174

## W

Wake-Up Call 216, 245  
Walking COS 229



**Panasonic Consumer Electronics  
Company, Division of Matsushita  
Electric Corporation of America**

One Panasonic Way, Secaucus,  
New Jersey 07094  
www.panasonic.com

**Panasonic Sales Company (“PSC”),  
Division of Matsushita Electric of  
Puerto Rico, Inc.**

Ave. 65 de Infantería, Km. 9.5,  
San Gabriel Industrial Park, Carolina,  
Puerto Rico 00985

**Copyright:**

This manual is copyrighted by Panasonic Communications Co., Ltd. (PCC). Under the applicable copyright laws, this manual may not be reproduced in any form, in whole or part, without the prior written consent of PCC and its licensee.

© 2001 Panasonic Communications Co., Ltd. All Rights Reserved.

Printed in the United Kingdom

**PSQX2424XA** KA0701HK2013



## Free Manuals Download Website

<http://myh66.com>

<http://usermanuals.us>

<http://www.somanuals.com>

<http://www.4manuals.cc>

<http://www.manual-lib.com>

<http://www.404manual.com>

<http://www.luxmanual.com>

<http://aubethermostatmanual.com>

Golf course search by state

<http://golfingnear.com>

Email search by domain

<http://emailbydomain.com>

Auto manuals search

<http://auto.somanuals.com>

TV manuals search

<http://tv.somanuals.com>