

KX-E2000

Operator's Instruction Manual



Panasonic

FOR USERS IN UNITED STATES ONLY

This equipment has been tested and found to comply with the limits for a Class B digital device, pursuant to Part 15 of the FCC Rules. These limits are designed to provide reasonable protection against harmful interference in a residential installation. This equipment generates, uses and can radiate radio frequency energy and, if not installed and used in accordance with the instructions, may cause harmful interference to radio communications. However, there is no guarantee that interference will not occur in a particular installation. If this equipment does cause harmful interference to radio or television reception, which can be determined by turning the equipment off and on, the user is encouraged to try to correct the interference by one or more of the following measures:

- Reorient or relocate the receiving antenna.
- Increase the separation between the equipment and receiver.
- Connect the equipment into an outlet on a circuit different from that to which the receiver is connected.
- Consult the dealer or an experienced radio/TV technician for help.

The user may find the booklet "Something About Interference" available from FCC local regional offices helpful.

FCC Warning: To assure continued FCC emission limit compliance, the user must use only the recommended shielded interface cable when connecting to computer or peripheral. Also, any unauthorized changes or modifications to this equipment would void the users authority to operate this device.

WARNING

- When you operate this equipment, the power-outlet should be near the equipment and be easily accessible.
- Power source voltage of this unit is listed on the nameplate. Do not fail to plug the typewriter into an outlet with the proper voltage.
- To prevent fire or shock hazard, do not expose this product to rain or any type of moisture.

The serial number of the unit may be found on the inside label. For your convenience, note this number in the space provided below, and retain this book along with your proof of purchase, to serve as a permanent record in the event of a theft, or for future reference.

MODEL NO. _____ NAME OF DEALER _____

SERIAL NO. _____ DATE OF PURCHASE _____

Preface

Congratulations! You are about to enter the exciting world of electronic typing with one of the most advanced electronic typewriters available today.

Your Panasonic typewriter has been designed to help you prepare your typing projects as simply and efficiently as possible.

Many of your tedious typing tasks may now be performed quickly and automatically. By reading through the manual, you will learn how to operate all of the functions which will help you on a day-to-day basis.

It is important that you read this manual and do the exercises. It has been designed to teach you every function your Panasonic typewriter has to offer. Once you have completed this manual, you will find it easier to do many of your daily typing projects.

Take the time to learn everything you can about your new typewriter. We are convinced you will find typing much more interesting and your finished projects cleaner, more professional looking, and much easier to do.

We hope you enjoy using your Panasonic typewriter and are confident you will have many years of reliability ahead of you.

TABLE OF CONTENTS

Preface

LEARNING THE BASICS	1
● Parts Functions	2
Power On/Off Switch	2
Paper Release Lever	2
Paper Bail Release Lever	2
Copy Control Lever	3
Cover Interlock Switch	3
KEYBOARD LAYOUT	4
● Character Keys	4
● Selector Switches	5
Line Spacing Selector	5
Mode Selector	5
Pitch Selector	5
Impact Control Selector	6
KB I/KB II Selector	6
Accessing KB II	6
● Function Keys	7
USING THE TYPEWRITER	9
● Automatic Paper Insertion	9
Changing the Paper Insertion Position	9
● Automatic Paper Eject	9
Automatically Ejecting the Paper	9
● Margins and Tabs	10
Setting Margins and Tabs	10
Clearing a Tab Stop	11
Clearing All Tabs and Retaining Margins	11
Clearing All Margins and Tabs	11
Storing Margin Formats	12
Recalling Margin Formats	13
Adjustable Hot Zone	13
Setting the Hot Zone	13
● Index (↓) and Reverse Index (↑)	14
● Micro Index	14
Micro Indexing	14
● Corrections	15
Correcting Errors on the Same Line	16
Out of the Correction Memory	17
Using the No Print Method	17
Making Manual Corrections	18

AUTOMATED TYPING FEATURES	20
● Caps Lock	20
● Bold Print	20
● Underscore	21
Continuous Underscore	21
Word by Word Underscore	21
Double Underscore	22
● Centering	23
Between Margins	23
Over a Point	23
Between Tab Stops	24
Aligned at the Right Margin	24
Centering Application for Columns	25
● Indent	26
Left Indent	26
Indenting the Left Side of the Text	26
Block Indent	27
Indenting Both Sides of the Text	27
● Decimal Tabulation	28
Using Decimal Tabulation	28
● Temporary Hyphen	30
Inserting a Temporary Hyphen	30
● Permanent Space	31
Entering a Permanent Space	31
● Micro Space	31
Entering a Micro Space	31
● Permanent Backspace	32
Entering a Permanent Backspace	32
SPELLSCAN	33
● Turning SpellScan On	33
● Turning SpellScan Off	34
● Inserting a Word Into the Glossary	34
● Deleting a Word From the Glossary	35
● Listing the Glossary	36
DEFAULT SETTINGS	37
● Resetting the Printer	38
CODE OPERATIONS CHART	39
CAUTIONS	41
● Batteries	41
● Cleaning	41
● Cables	41

CHANGING SUPPLIES	42
● Changing the Ribbon Cartridge	42
● Changing the Correction Tape	43
● Changing the Daisywheel	44
● Changing the Batteries	45
PLATEN REMOVAL AND INSTALLATION	46
● Removing the Platen	46
● Installing the Platen	47
SHIPPING INFORMATION	48
TROUBLESHOOTING	49
OPTIONS	50
SPECIFICATIONS	51
INDEX	52

LEARNING THE BASICS

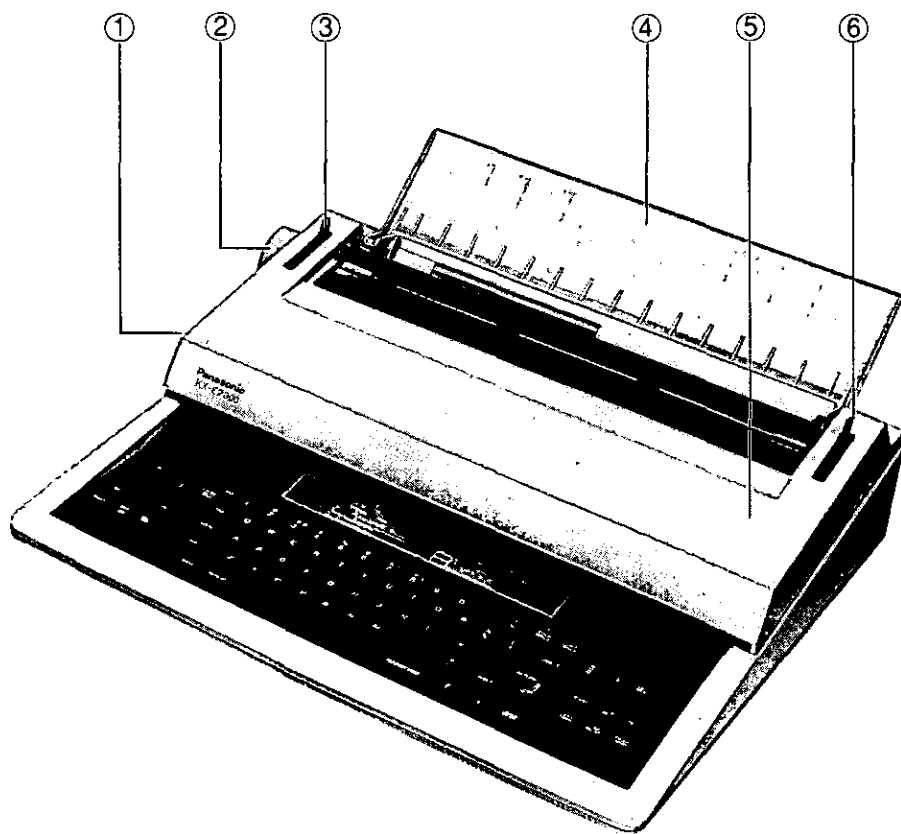

① **Power ON/OFF Switch**

② **Platen Knob**

Manually feeds paper

③ **Paper Bail Release Lever**

Moves the paper bail away from the platen

④ **Paper Support**

⑤ **Top Cover**

⑥ **Paper Release Lever**

Releases paper

Parts Functions

Power On/Off Switch

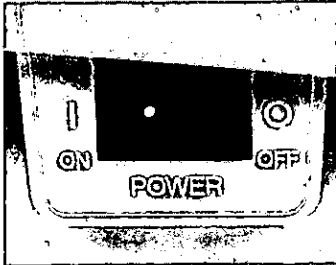

The power ON/OFF switch is located toward the back left-hand side of the machine.

When you turn the unit on, the printer will move to the current left margin and the daisywheel will spin to position itself accurately. The typewriter will remember the last margins and tabs used when you turn the machine off.

Paper Release Lever

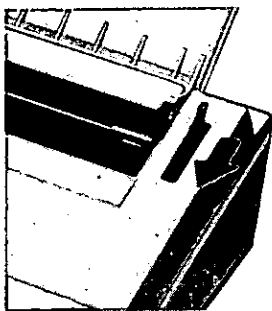

Pulling forward on the Paper Release Lever releases the paper so that the operator can adjust it freely.

Paper Bail Release Lever

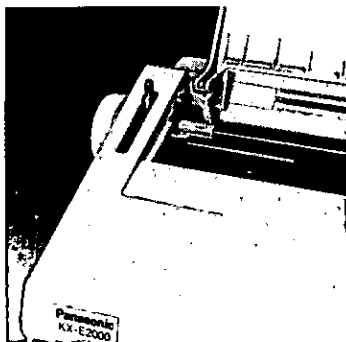

Pulling forward on the Paper Bail Release Lever moves the paper bail away from the platen. Additional forward movement of this lever activates the automatic paper insert function.

Copy Control Lever

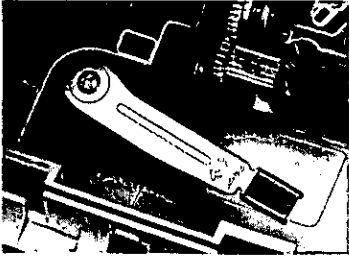

Located inside the unit on the right side underneath the ribbon cartridge is a green lever, which is for copy control. Position 1 is for one to three copies; position 2 is for three to five copies (dependent upon paper weight). Set according to your requirements.

Cover Interlock Switch

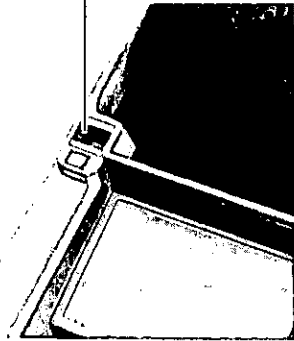

Cover Interlock Switch

The top cover has a safety interlock switch which deactivates the printer and keyboard whenever the top cover is opened.

KEYBOARD LAYOUT

In order to simplify the explanation of the typewriter and its capabilities, the keyboard has been divided into three (3) separate sections: **Character Keys**, **Selector Switches**, and **Function Keys**.

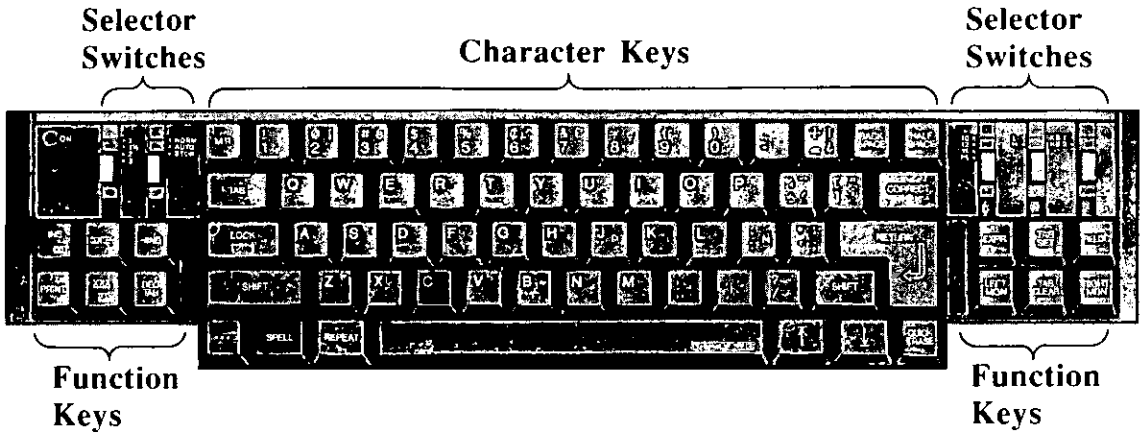

Character Keys

The KX-E2000 Character Keys are clearly labeled for ease of use. All coded functions are labeled in blue and correspond with the CODE key, which is also labeled in blue. All operations which need to be performed with the SHIFT key are framed in a box. Keys with one or two characters to the right of the traditional characters offer special symbols. These symbols are accessed in KB II. For more information on KB II refer to page 6.

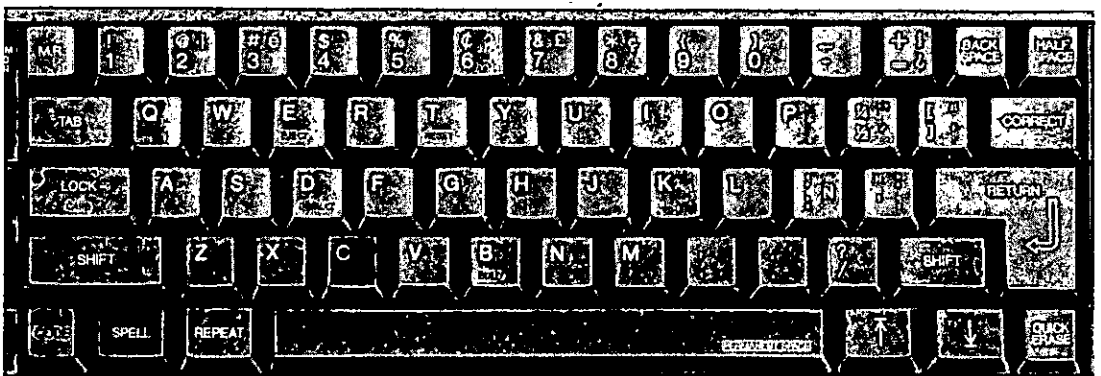

Selector Switches

A total of five selector switches are located on the KX-E2000

Line Spacing Selector

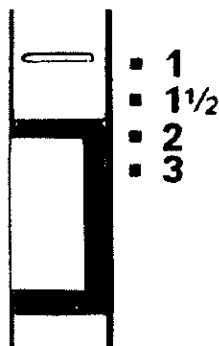

The Line Spacing Selector is located on the top left of the keyboard. It is marked 1, 1½, 2 and 3 and is used to control the number of lines between each RETURN.

You may also select from three different lines per vertical inch settings which are accessed through the default menu discussed on page 37. These choices and their uses are listed below.

- 5 25 - legal applications (court reporting)
- 6 - normal correspondence
- 8 - used in conjunction with 15 pitch

Mode Selector

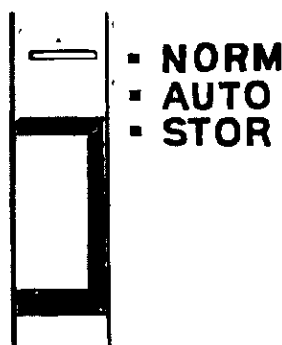

The Mode Selector is located to the immediate right of the Line Spacing Selector. It offers three options.

- NORM** Prints each character as you type and requires a manual return at the end of each line.
- AUTO** Prints each character as you type and automatically returns at the end of each line.
- STOR** This mode is used to store margin and tab formats in Code X, Y, or Z. You cannot type in this mode.

Pitch Selector

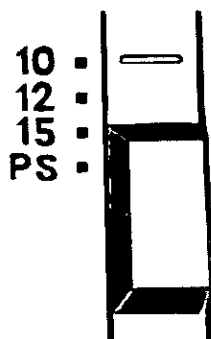

On the right side of the keyboard is the Pitch Selector which is labeled 10, 12, 15 and PS. The Pitch Selector indicates the number of characters printed per inch as outlined below.

- | | |
|-----------------|------------------------|
| 10 PICA | 10 Characters per inch |
| 12 ELITE | 12 Characters per inch |
| 15 MIKRON | 15 Characters per inch |
| PS PROPORTIONAL | Variable Spacing |

For the best results, your Pitch Selector switch should correspond with the pitch of the daisywheel in your typewriter.

Impact Control Selector



The Impact Control Selector, which is located to the right of the Pitch Selector, dictates to the printer how hard the characters on the daisywheel will strike the page. You have a choice of two settings: L (light) and H (heavy).

KB I/KB II Selector

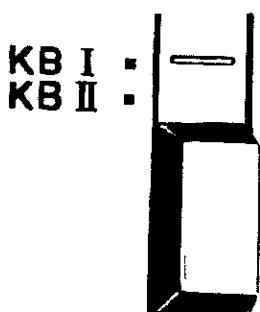

The KB I/KB II selector switch is located to the far right of the keyboard. KB I allows printing of the alpha/numeric symbols normally associated with a traditional keyboard. On the keys which contain three or more characters, KB II enables you to access the symbols located on the right side of the traditional characters.

Accessing KB II

- Move the selector switch to KB II

The symbols to the right side of the traditional characters are now available for use.

If the symbol is located on the upper right side of the traditional character,

- **PRESS SHIFT + THE DESIRED KEY**

If the symbol is located to the lower right side of the traditional character,

- **PRESS THE DESIRED KEY (no shift is required)**

Panasonic offers two types of daisywheels:

- D1 - For International Symbols
- D2 - For American Symbols

When using a D1 daisywheel, which is provided with your KX-E2000, you have the ability to type the following International symbols:

£ ¢ é ì ù Ñ ñ

When using the D2 daisywheel, you have the ability to type the following American symbols:

² • ® § ¶ < >

Function Keys

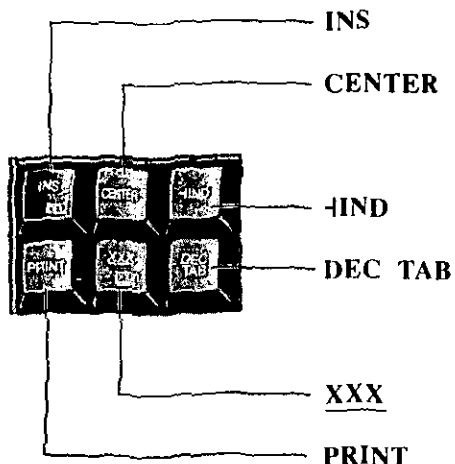

INS Inserts a word into the spell user glossary

CENTER Allows you to center four ways: between margins, over a point, between tabs, or right margin flush.

-IND Sets a temporary left margin.

DEC TAB Advances the printer to the next tab position and aligns the decimal point or comma on the tab position.

XXX Sets and releases automatic underscore command

PRINT Advances to "fill-in" positions in Forms Layout. The No Print mode is activated when used in conjunction with the CODE key.

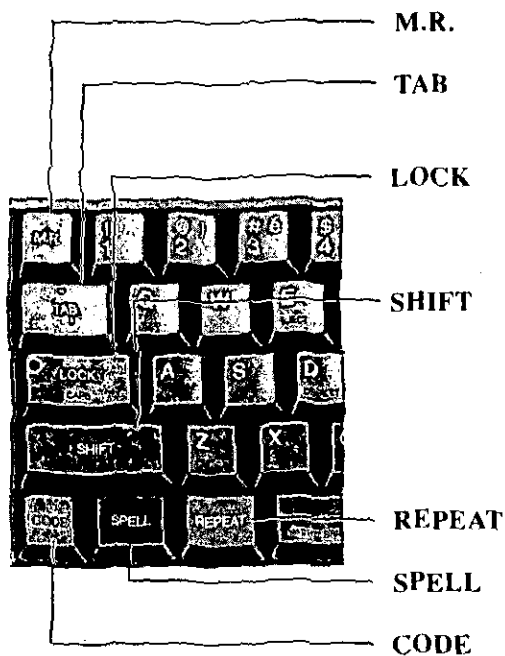

M.R. Margin release for left and right margins.

TAB Advances the printer to the next tab position, and aligns all characters to the right of the tab setting.

LOCK Allows typing of capital letter without holding down the SHIFT key. Caps lock is activated when used with the CODE key.

SHIFT Allows typing of capital letters. It also accesses the automated features which are framed in a box on the keytops.

You must hold down the SHIFT key while pressing the desired key.

REPEAT Makes every key a repetitive key.

SPELL Turns the spell feature on and off.

CODE Is used in conjunction with other keys (most of which are clearly labeled in blue) to perform automated functions.

You must hold down the CODE key while pressing the desired key.

SPACE BAR Advances the printer to the right. When used with the CODE key, it advances the printer 1/6th of a space if your pitch is set on 10.

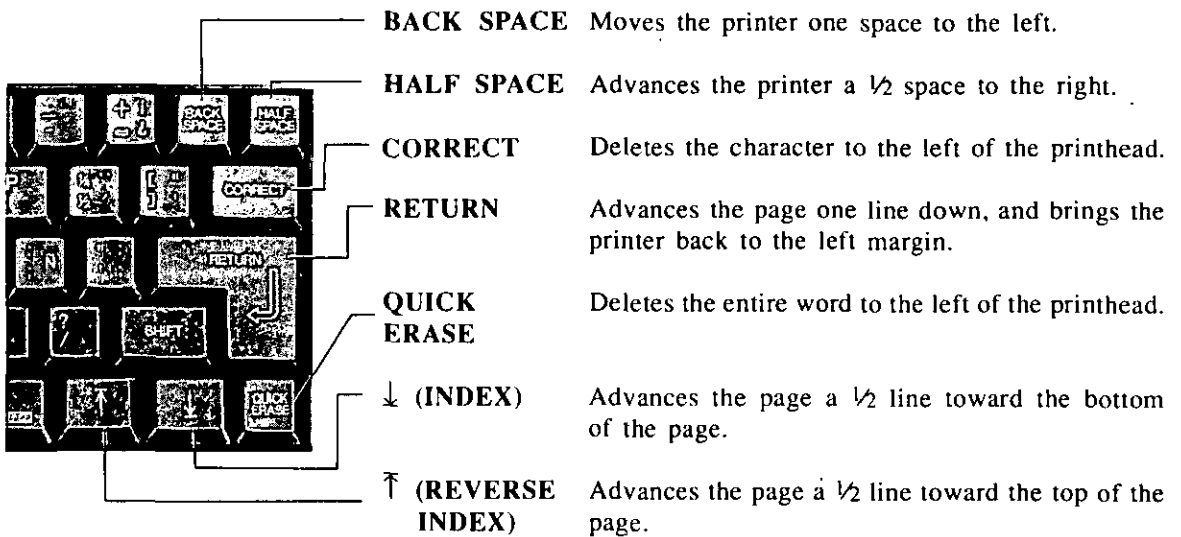
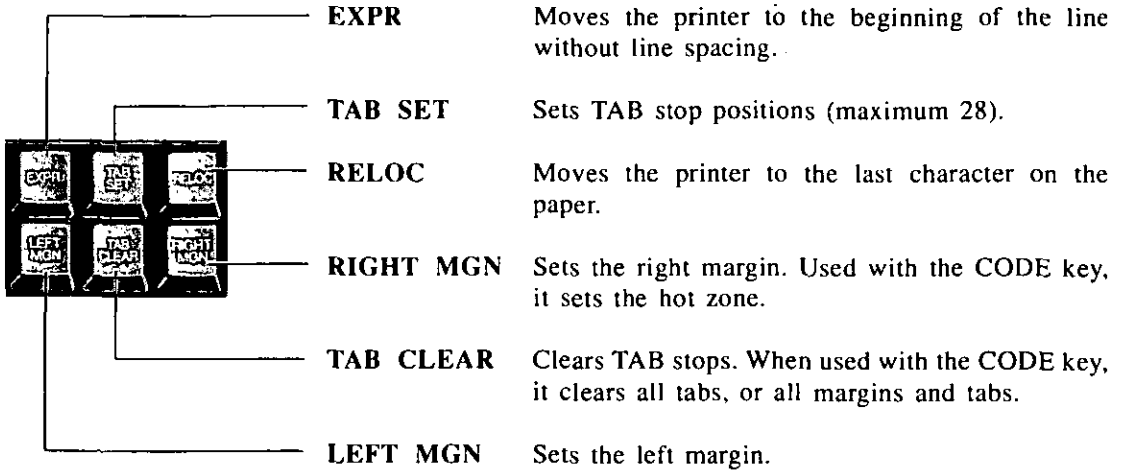

USING THE TYPEWRITER

Automatic Paper Insertion

The Panasonic typewriter is pre-programmed to insert your paper seven (7) lines from the top of the page. Place your paper in the machine and pull the paper bail release lever toward you until the paper begins to insert.

Changing the Paper Insertion Position

- 1 Place your paper against the paper support guide with the left edge of the page aligned with 0 on the margin scale (located on the top cover)
- 2 Pull the Paper Bail Release Lever towards you until the paper begins to insert
- 3 Press **RETURN**, **INDEX** (↓) or **REVERSE INDEX** (↑) to position the paper at the desired insertion point
- 4 Press **CODE + A**

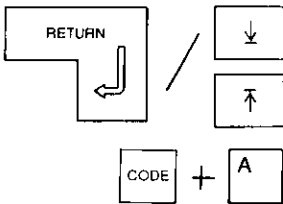

The new position is now stored and will remain the point of insertion until you change the setting again by following the steps outlined above.

NOTE: You can reset the auto paper insertion point to the default setting (7 lines) by changing the default parameter (refer to page 37).

Automatic Paper Eject

After typing a project, you can instruct your typewriter to automatically eject the paper.

Automatically Ejecting the Paper

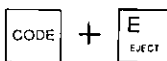

- Press **CODE + E**

The KX-E2000 has been pre-programmed for standard 8½×11" paper (66 lines), and will eject the paper based on that setting. If you are using legal or ledger size paper (longer than 11"), the paper will not eject fully from the typewriter unless you change the paper length default setting (see page 37).

Margins and Tabs

Because there are no preset margins or tabs, the KX-E2000 enables you to set margins and tabs to meet your requirements. A maximum of 28 tab stops can be set on a writing line.

Panasonic also gives you the ability to store three different margin formats (margins, tabs, and hot zones). These formats are stored in X, Y and Z, and can be recalled at any time; thus, eliminating the need to manually set frequently used margin formats.

Setting Margins and Tabs

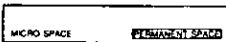

- 1 Press **SPACE BAR**

This moves the printer toward the right. When you have reached the desired left margin position,



- 2 Press **LEFT MGN**

To position the printer at the first required TAB stop,

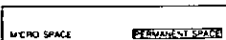

- 3 Press **SPACE BAR**



- 4 Press **TAB SET**

Repeat the last two steps for each tab stop required. The maximum number of tab stops on one line is 28.

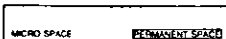

- 5 Press **SPACE BAR** to reach the right margin setting



- 6 Press **RIGHT MGN**

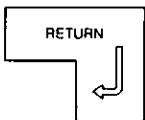

- 7 Press **RETURN**

- You may also change the left margin as you would on a traditional typewriter by using the M.R., SPACE or BACK SPACE key, and pressing LEFT MGN at the new position.

Clearing a Tab Stop



1 **TAB** to the desired tab setting



2 Press **TAB CLEAR**

Clearing All Tabs and Retaining Margins



OR



1 **SPACE** or **TAB** to the first tab position

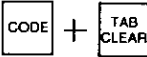

2 Press **CODE + TAB CLEAR**

Clearing All Margins and Tabs

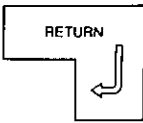

1 Press **RETURN**

This positions the printer at the left margin. (The printer must be at the left margin to clear all of the settings.)

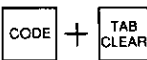

2 Press **CODE + TAB CLEAR**

The printer will move to the far left, clearing all existing margins and tabs.

Storing Margin Formats

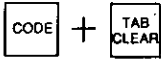

1 Press **CODE + TAB CLEAR** to clear the current margin format

2 Set the desired margins and tabs

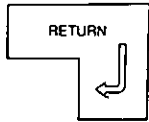

3 Press **RETURN**

4 Move the MODE selector to **STOR**

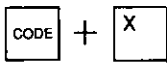

5 Press **CODE + X (Y or Z)**

6 Move the MODE selector to **NORM** or **AUTO**

The typewriter will beep once to let you know the format has been stored.

The typewriter will beep three times if you attempt to type or set a new format while in the **STOR** mode.

NOTE: When you want to change any of the stored margin formats, simply set the new format and store it over the previous format.

Exercise

Following the steps outlined above, store the following formats.

Press **CODE+TAB CLEAR** to clear the current margins and tabs. Set the new margins and tabs as follows:

	<u>Format "X"</u>	<u>Format "Y"</u>
Left Margin	15	11
Tabs	30, 45, 60	20, 33, 45, 54
Right Margin	74	64

Recalling Margin Formats

NEVER position the MODE selector on **STOR** to recall margin formats from memory (only to store them).

- 1 Move the MODE selector to **NORM** or **AUTO**

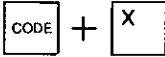

- 2 Press **CODE + X (Y or Z)**

The designated format will be recalled.

Adjustable Hot Zone

The Hot Zone represents the number of spaces between the bell and the right margin. It is preprogrammed for 0.7 of an inch (7 spaces in 10 pitch) from the right margin. You may change the setting within one inch of the right margin (max 10 spaces).

Setting the Hot Zone

- 1 Position the MODE selector on **NORM**

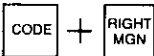
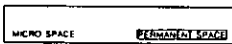

- 2 Press **SPACE BAR** or **TAB** to position the printer at the right margin

- 3 **BACKSPACE** to the required new bell position

- 4 Press **CODE + RIGHT MGN**

Index (↓) and Reverse Index (↑)

The INDEX (↓) key allows you to advance the paper a ½ line toward the bottom of the page. The REVERSE INDEX (↑) key allows you to advance the paper a ½ line towards the top of the page.

These keys are useful when typing subscripts and superscripts. You will also use them in conjunction with other features discussed later in this manual.

The scientific equation for water is H₂O.

To type this, you would first enter "H"

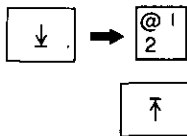

1 Press INDEX (↓) and type "2"

2 Press REVERSE INDEX (↑) to reposition the printer on the actual typing line and continue typing

Micro Index

Micro Indexing moves the printer vertically in increments of 1/48th of an inch up or down on the paper. This is extremely useful when aligning the printer with pre-printed forms. The Forms Layout feature will be covered later in the manual.

Micro Indexing

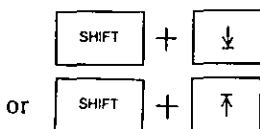

• Press **SHIFT + INDEX (↓)** or **SHIFT + REVERSE INDEX (↑)**

The SHIFT key must be held down while pressing either key.

NOTE: Micro Indexing is not stored in the correction memory.

Corrections

Your typewriter has a one line correction memory. Very simply, this means that if you make an error on the current typing line, you may instruct the typewriter to “lift off” the error automatically.

Errors can be corrected both in correction memory and out of correction memory. The KX-E2000 even offers two ways to correct out of the correction memory.

If you have typed several lines and notice an error above the current line, you may correct the error with a manual correction.

Listed below are the keys you will use when making corrections.

- **SPACE BAR** is used to position the printer one space to the right of the incorrect character.
- **BACKSPACE** is used to move the printer one space to the right of the incorrect character.
- **CORRECT** deletes characters to the left of the printhead.
- **EXPRESS (EXPR)** moves the printer to the beginning of the line without line spacing.
- **RELOCATE (RELOC)** moves the printer to the last printed character on the page, or to the last manual return.
- **QUICK ERASE** deletes one word at a time to the left of the printhead.

Correcting Errors on the Same Line



1 **BACKSPACE** to position the printer one space to the right of the character you wish to delete



2 Press the **CORRECT** to delete one character at a time
or
Press **QUICK ERASE** to delete one word at a time

3 Type the correct character (s)

Exercise

Set the mode selector on **NORM**, and type the following sentence. Be sure to include the errors, and do not **RETURN** at the end of the line

The KX-E2000 has sohpnsticated junctions but is easy to yse.

Using the steps outlined above, make the following corrections

Change "sohpnsticated" to "sophisticated"
"junctions" to "functions"
"yse" to "use"

Out of the Correction Memory

Two methods of correction are available outside of the correction memory; the No Print method and Manual Correction.

Using the No Print Method

The **No Print** method enables you to retype errors into the correction memory without re-printing them. This feature is especially useful when correcting errors typed in proportional spacing.

After reaching the end of the correction memory,

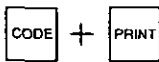
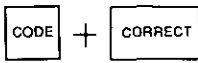

- 1 Press **CODE + CORRECT** to exit the correction memory
- 2 Press **REVERSE INDEX** (↑) to position the printer on the desired line
- 3 Position the mode selector on **NORM**
- 4 **SPACE** to position the printer over the first incorrect character(s)
- 5 Press the **CODE + PRINT** key and retype the characters exactly as they appear on the paper

If the text was typed in PS (Proportional Spacing), retype from the beginning of the line to the error to ensure proper spacing.

- 6 Press **CORRECT** to delete the error(s)
- 7 Retype the correct character(s)
- 8 Press **RELOC**

Making Manual Corrections

Manual correction is ideal for correcting one or two errors outside of the correction memory.

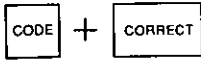

- 1 Press **CODE + CORRECT** to advance beyond the correction

The printer will automatically move to the left margin



- 2 Press **REVERSE INDEX** (\uparrow) to position the printer on the line containing the error

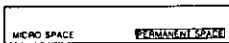

- 3 **SPACE** to position the printer directly over the error

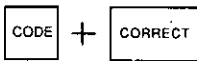

- 4 Press **CODE + CORRECT**

- 5 Retype the incorrect character

This will lift the character off the paper.

- 6 Type the correct character

- 7 Repeat the steps outlined above for each incorrect character on the same line



- 8 Press **RELOC**

This repositions the printer at the last printed character or RETURN.

NOTE: If you have multiple corrections to make on different lines, you must RETURN to position the printer at the left margin in order to REVERSE INDEX (\uparrow) to the next line containing the error.

Exercise

Type the following exercise including the errors. When finished, use the correction procedures you have just learned. Be sure to make the corrections within the correction memory first, and then make the corrections out of correction memory.

- Set the mode selector on **NORM** and use the **CODE + X** format.

Distantly related to the opossum, the Koala bear is only 3/4 of an inch long at birth and weighs only 1/5 of an ounce. Usually only one Koala is born at a time, with the mother bearing young only every other year.

infant — The infznt will remain in its mother's pouch until it is ready to emerge at six months of age. It will then
cling — climg to its mother's back until it is a year old.
weigh — When fully grown, it will stand about two feet high and may wieth as much as 33 pounds. At the age of four, the animal will have attained full sexual maturity and its life span may be as long as 20 years. *tall*

When the Koala is ready to strike out on it's won, it will find its own eucalyptus tree, whose leaves are almost its only food. Only on rare occasions will it leave the tree, as when it seeks another tree to tkae up new residence. *its own* *take*

clawed — The Koala is suited for climbing, as all four of its sharp clawde feet are made for grasping. During the day the Koala sleeps, usually curled up inconspicuously in the crotch of a tree, and feeds only at nighttime. *nighttime*

At one time, the Koala, a native of Australia, was severely threatened with extinction. Now the Australian governemtn is taking drastic stesp to insure its survival.

steps

government

AUTOMATED TYPING FEATURES

Caps Lock

The **Caps Lock** feature enables you to type capital letters and numbers at the same time without having to shift back and forth from upper to lower case. The **LOCK** key's indicator light will flash when this feature is activated.

To Activate CAPS LOCK:

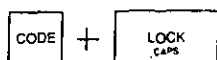

- Press **CODE + LOCK**

Every letter you type will be in CAPITAL LETTERS, when you use the number keys you will not get the traditional shift symbols, you will get the numbers.

To Deactivate CAPS LOCK:

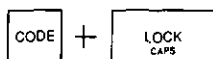

- Press **CODE + LOCK** again

The indicator light on the lock key will no longer flash.

Bold Print

This feature instructs the printer to strike each character twice, this will "highlight" or emphasize certain words for you.

To Activate Bold Print:

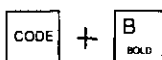

- Press **CODE + B** and type the word(s) to be highlighted.

To Deactivate Bold Print:

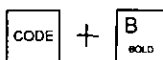

- Press **CODE + B** again

Underscore

The KX-E2000 offers you three ways to underscore: Continuous, Word by Word, and Double.

Continuous Underscore

To Activate:



- Press XXX

Both the characters and spaces will be underscored.

To Deactivate:



- Press XXX again

Example

This is continuous underscore.

Word by Word Underscore

To Activate:

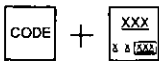

- Press **CODE** + XXX

Only words will be underscored.

To Deactivate:

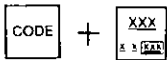

- Press **CODE** + XXX again

Example

This is word by word underscore.

Double Underscore

To Activate

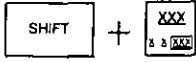

- Press **SHIFT + XXX**

Both characters and spaces will be underscored with a double line

To Deactivate

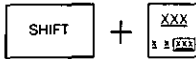

- Press **SHIFT + XXX** again

Example

This is double underscore.

Centering

There are four ways to center information; between margins, over a point, between tab stops and aligned at the right margin.

Between Margins

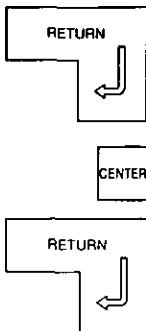

- 1 Press **RETURN** to position the printer at the left margin
- 2 Press **CENTER** and type the information to be centered
- 3 Press **RETURN** to print

Example

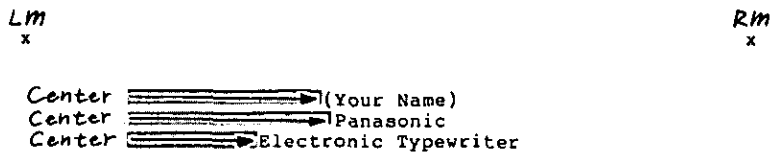

Over a Point

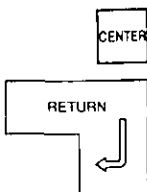

- 1 Press the **SPACE BAR** to move your printer to the desired position
- 2 Press **CENTER** and type the information to be centered
- 3 Press **TAB** or **RETURN** to print

Example

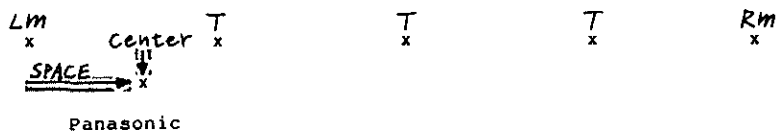

Between Tab Stops

- 1 Choose the tabs you would like to center between
- 2 **TAB** to the left stop position
- 3 Press **CENTER** and type the information
- 4 Press **RETURN** or **TAB** to print

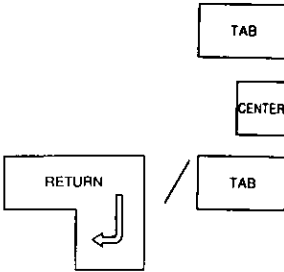

Example

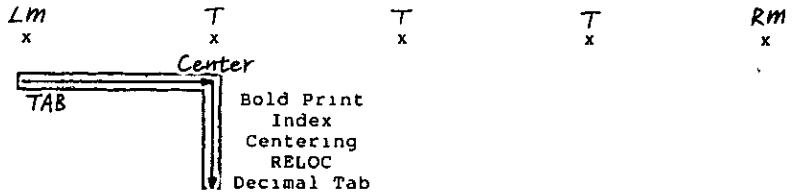

Aligned at the Right Margin

- 1 **TAB** to the right margin
- 2 Press **CENTER** and type the information to be aligned
- 3 Press **RETURN** to print

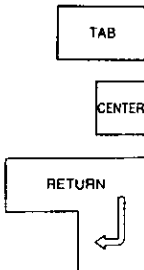

Example

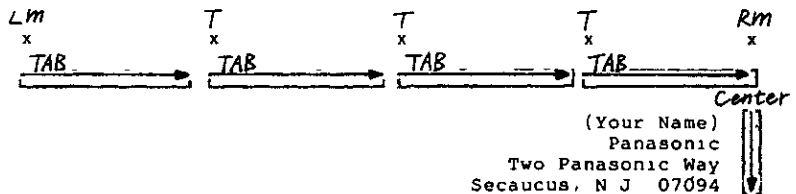

Centering Application for Columns

The CENTER key is ideal to use when trying to determine proper tab settings to align columns of information. Below is an easy way to define proper tab positions before you begin typing the actual chart.

1 Insert a sheet of paper

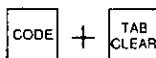

2 At the left margin, press **CODE + TAB CLEAR** to clear all margins and tabs

3 Set your margins at the edge of the paper and press **RETURN**



4 At the left margin press the **CENTER** key

5 Type the longest word or number in the first column

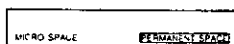

6 Press the **SPACE BAR** to enter the desired number of spaces between the first and second column

7 Repeat steps 5 and 6 for each column of information

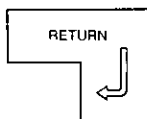

8 After typing the longest word or number in the last column, press **RETURN**

The longest word in each column will print evenly spaced on the paper. If the columns appear too close together, repeat from step #4 and enter additional space between each column. If you are unable to complete the longest word in each column, repeat from step #4 and enter fewer spaces between each column.

9 Space across and set margins and tabs to agree with the print out. Be sure to set a tab on the decimal point to properly align a column of numbers. Set the right margin one or two spaces after the last column.

Example

Darlene	93 Webb Street	\$158.95
↑	↑	↑
LEFT	TAB	TAB
MGN	SET	RIGHT
		MGN

Indent

Indent allows you to set a temporary left margin and eliminates the need to TAB before typing each indented line. When INDENT is activated the printer will return to the point of indentation rather than to the left margin.

There are two forms of indent available on the KX-E2000: Paragraph and Block Indent.

Left Indent

Left Indent will provide indentation from the left side only.

Indenting the Left Side of the Text

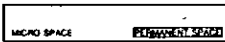

or



1 SPACE or TAB to the point of indentation

2 Press -IND to activate the command

3 Type the text

4 Press -IND to deactivate the command

Example

Lm
x



T
x

T
x

T
x

Rm
x

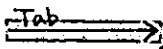
Below is the revised company policy regarding the use of limousine services during business travel.

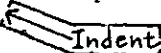
  Company employees may use Westerly Limo Service and have the charges billed directly to the company. If a different limo service is used, a paid receipt must accompany your expense report. 

Block Indent

Block indent automatically indents the right margin in proportion to the left margin. This feature creates a uniform appearance and centers the text between margins.

The temporary margins set with block indent must be more than one inch apart.

Indenting Both Sides of the Text

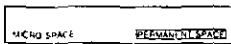

OR

TAB

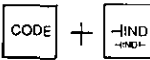

1 **SPACE** or **TAB** to the point of indentation

2 Press **CODE + -IND** to activate the command

The same number of spaces indented from the left will automatically be indented from the right.

3 Type the text

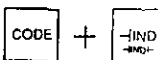

4 Press **CODE + -IND** to deactivate the command

Example

Lm *T* *T* *T* *Rm*
x x x x x

If Westerly Limo Service is not available at the time of your request, please contact the company's travel agency.

A diagram showing the text from the example with annotations. A box labeled 'Tab' has an arrow pointing to the start of the indented text. A box labeled 'Code + Indent' has an arrow pointing to the start of the indented text. Another box labeled 'Code + Indent' has an arrow pointing to the end of the indented text.

Utopia Travel is located on the third floor of the north administration building. You may contact them on extension 1234.

If you have any questions concerning business travel, please let us know.

Decimal Tabulation

The DEC TAB key advances the printer to the next tab position and aligns alpha or numeric characters to the left of that tab position. It aligns a period (decimal point) or comma on the tab stop and places the characters following the period or comma to the right of the tab position.

Because DEC TAB aligns all characters before a period or a comma to the left of the tab position, it is ideal for whole numbers or characters that require a flush right appearance. For statistical typing, DEC TAB simplifies the tedious task of manually aligning a column of numbers.

For statistical typing in foreign countries, numbers are aligned at the comma position instead of the decimal point. If this is required, you may change the alignment character by accessing the default settings menu (see page 37).

Using Decimal Tabulation

1 Set tab stops

Remember, set the tab stop in the position you want the decimal point to appear.

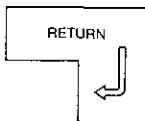

2 Press **RETURN**

This will bring the printer back to the Left Margin.



3 Press **DEC TAB**

4 Type the numbers, decimal point, or text to be aligned

The printer backtraces once for every character entered before the decimal point.



5 Press **DEC TAB** to advance to the next tab stop

6 Repeat steps 4 & 5 until you have completed all your entries

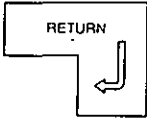

7 Press **RETURN**

Begin typing the second line of information.

Example

LM		T		T		T		RM
		DEC	TAB			TAB		
				DEC	TAB			
		123.64				Main Street		
		1,000				Trask Avenue		
		.12				Gleccourt Ave		
		7.38				Sky Top Lane		
		246				Ravens Crest Ave		

Temporary Hyphen (Soft Hyphen)

A Temporary Hyphen enables you to hyphenate words that fall within the Hot Zone (between the bell and the right margin). A Temporary Hyphen triggers an Auto Return and should only be used in the AUTO typing mode. Because the temporary hyphen enables you to fit more characters on a line, it gives the right margin a less ragged appearance.

Inserting a Temporary Hyphen

1 Type until you hear the “beep” (bell) as you near the end of the line

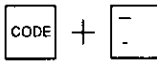

2 Press **CODE + HYPHEN (-)** at the desired hyphenation point

The character after the hyphen will trigger an automatic return.

Exercise

Type this exercise below.

- Set the mode selector on **AUTO** and use the **CODE + Y** format.

Soft hyphens are entered in the hot zone to prevent long words from causing extremely ragged margins on the right side of the page. However, remember to use the **CODE** key before you depress the hyphen key. This tells the typewriter to return at the next character typed.

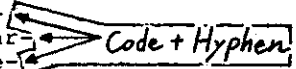

Permanent Space

Permanent Space enables you to type a space between two words within the Hot Zone, without triggering an Auto Return. This feature is ideal when typing proper names or dates which should appear on the same line.

Entering a Permanent Space

- 1 Type until you hear the "beep" (bell) as you near the end of the line
- 2 Press **SHIFT + SPACE BAR** between the two words that you want to appear on the same line

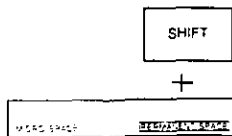

Exercise

Type the following using permanent space feature where indicated.

- Set the mode selector on **AUTO** and use the **CODE + Y** format.

Permanent spaces prevent names or dates from being separated. In instances such as San Francisco, Ca. or New York, N.Y. or dates such as September 30, 1990 you may instruct the typewriter never to separate these characters or numbers onto different typing lines.

Shift + space

Shift + space

Micro Space

A micro space allows you to move the printhead 1/6th of a space in 10 pitch.

Entering a Micro Space

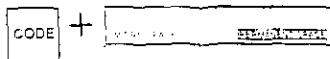

- Press **CODE + SPACE BAR**

Permanent Backspace

When typing characters that overlap, use the Permanent Backspace feature to include both characters in the correction memory. This means you can automatically correct the both letters. For instance, if you type Ø without using the Permanent Backspace feature, you will only be able to correct the slash (/), not the zero (0).

Entering a Permanent Backspace

1 Type the first character

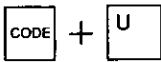

2 Press **CODE + U**

3 Type the character you want to overlap the first entry

SpellScan offers a base dictionary of 86,000 words. The dictionary is ROM (Read Only Memory) based, which simply means that you may only read the words in the dictionary; you cannot delete or edit them.

In addition to the base dictionary, Panasonic has included a 1K (approximately 120 words) user glossary. The glossary enables you to store frequently used words such as medical or legal terms, proper or company names. Words may be added or deleted from the glossary at any time, without disturbing the 86,000 words base dictionary.

The spelling of each word is checked against the base dictionary and the words you have entered into the glossary. If a word is not found in the dictionary or the glossary, the typewriter will beep twice to signal that an error has been made.

The typewriter will recognize the end of a word when a space, tab or carrier return is entered. It will check a word whether it is typed in upper or lower case and will ignore the fact that it is underscored or in bold print. It will also accept apostrophes and certain abbreviations such as "don't", "isn't", "1st", "2nd" and "3rd"

SpellScan® is a registered trademark of Panasonic Communications & Systems Company, Division of Matsushita Electric Corporation of America.

Turning SpellScan On



- Press the **SPELL** key

The typewriter will "beep" once to confirm.

SpellScan will remain on until the feature or the typewriter is turned off.

The typewriter will "beep" twice to alert you that a misspelled or unrecognized word has been typed. If the word is spelled correctly, ignore the beeps and continue typing.

If correction is needed, press the **CORRECT** key to delete the error.

Exercise

Follow the instructions outlined on the previous page, type the paragraph below correcting the errors when you hear the beeps. There is no need to correct proper names; therefore, continue typing and ignore the warning.

There will be a company meetiing in the large conferance room located in the south lobbie. Mr. Penter will be arriving at the airpout at approximatly the same time as Dr. Carlton. The doctor is our guast speaker at this meeting. Please arrange for a limosine to pick them up at the airport, promptly at 5:30 o'clock.

Turning SpellScan Off

A rectangular button with the word "SPELL" inside.

- Press the **SPELL** key again

The typewriter will beep once to confirm.

Inserting a Word Into the Glossary

Words can only be entered into the glossary one at a time, and they cannot exceed 30 characters. The typewriter will beep three times when the glossary is full.

A rectangular button with the word "SPELL" inside.

- 1** Press the **SPELL** key to activate SpellScan
- 2** Type the word that you want added into the glossary (max. 30 characters), and space once

The typewriter will beep twice informing you that it does not recognize this word.

A rectangular button with "INS" on the top line and "LIST" and "DEL" on the bottom line.

- 3** Press **INS**

The typewriter will beep once to confirm that the word has been inserted into the glossary.

Exercise

With SpellScan activated, type the sentence below correcting the errors when alerted, and insert the word "cardiopathy" into the glossary as you are typing.

Dr. Carlton will be discussing the probable cause of cardiopathy affecting men and women 30 years of age and older.

Now insert the following medical terms into the glossary:

adenopathy, rhinopathy, angiopathy, dermatopathy

Deleting a Word From the Glossary

You can delete one word at a time from the glossary.

- 1 Be sure SpellScan is on
- 2 Type the word to be deleted from the glossary and space once
- 3 Press **SHIFT + INS**

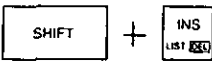

The typewriter will beep once to confirm that the word was deleted from the glossary. Repeat these steps for each word to be deleted.

Exercise

Delete the word "angiopathy" from the glossary. Your glossary should now contain only four medical terms.

Listing the Glossary

When listing, the glossary will print each word in alphabetical order.

1 Insert a sheet of paper

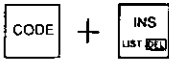

2 Press **CODE + INS**

The glossary will begin printing.

You will hear three beeps if you attempt to list the glossary when there are no words present.

NOTE: To stop printing, press the **PRINT** key. To resume printing, press the **PRINT** key again

To cancel printing, press the **PRINT** key and then the **CORRECT** key.

DEFAULT SETTINGS

You may change specific default settings of the typewriter. Default simply means that certain settings are pre-programmed into the typewriter and will remain that way until you change them. The settings that can be changed are outlined under step #2 below. Changing the default settings:

1 Insert a sheet of paper

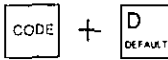

2 Press **CODE + D**

The numbers 60, 66, 6, P, N, D, 1 will print.

They represent:

60 - Page end - number of lines to print per page
(01 - 99 lines)

66 - Paper length - total number of lines on the paper
(01 - 99 lines)

6 - Lines per vertical inch
(5:5.25- legal, 6:6 -normal, 8:8 - 15 pitch)

P - Dec tab alignment character
(P:decimal point, C:comma)

N - Impact control
(N:normal impact, L:low impact)

D - Auto paper insertion point
(D:default - at seven lines, N:not default)

1 - Daisywheel
(1:100 series, 2:200 series)

3 **BACKSPACE** to the desired default setting



4 Press **CORRECT** and type the appropriate parameter



5 Press **RETURN**

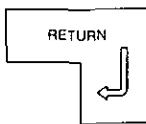

The new default settings will print confirming your changes, and communication parameters (N, N) are also printed. Communication parameters are settings when you communicate with interface option. These settings will remain the default until changed again.

NOTE: ● If you change the automatic paper insertion point, your default prompt will automatically be changed. When CODE+D is pressed, the Default setting will read:

60, 66, 6, P, N, N, 1

You can reset the auto paper insertion point back to the default (seven lines from the top), by changing the second "N" to "D".

- If the impact control parameter is set on L (low impact) and you are not using this type of ribbon, Panasonic will not assume responsibility for inconsistent print quality. If you experience inconsistent print quality, change this setting to correspond with the correct type of ribbon.

Resetting the Printer

In the event of a paper jam or improper printing, it may be necessary to reset the printer. When the printer is reset, the daisywheel will spin, and the printhead will move to the left end of the platen before returning to the left margin. You will not lose the margin formats you have stored, and all default settings will remain.

To Reset the Printer:

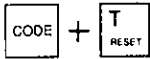

- Press **CODE + T** twice

Your printhead will move to the left side of the platen beep once, and then move back to the left margin.

CODE OPERATIONS CHART

<u>CODE</u>	<u>FUNCTION</u>	<u>Page</u>
CODE + A	Set auto paper insertion	9
CODE + B	Bold print	20
CODE + D	Default settings	37
CODE + E	Auto paper eject	9
CODE + T	Reset printer and correction memory	38, 49
CODE + U	Permanent backspace	32
CODE + X	Margin format recall/store	13
CODE + Y	Margin format recall/store	13
CODE + Z	Margin format recall/store	13
CODE + CORRECT	Escape correction memory	17
CODE + HYPHEN	Soft hyphen	30
CODE + IND	Block indent	27
CODE + INS	Listing the glossary	36
CODE + LOCK	Caps lock	20
CODE + PRINT	No print mode	17
CODE + RIGHT MGN	Set new bell position	13
CODE + SPACE BAR	Micro space	31
CODE + TAB CLEAR	Clear margins and tabs	11
CODE + <u>XXX</u>	Underscore by word	21

SHIFT + INDEX (↓)	Advance the paper 1/48 of an inch toward the bottom of page	14
SHIFT + INS	Deletes a word from the glossary	35
SHIFT + REVERSE INDEX (↑)	Advance the paper 1/48 of an inch toward the top of page	14
SHIFT + SPACE BAR	Permanent space	31
SHIFT + <u>XXX</u>	Double underscore	22

CAUTIONS

Be sure that the carrier stopper which holds the printer stationary during shipping is removed before turning the unit on.

Be sure to keep this stopper so that the unit can be transported safely, if the need arises.

For the best possible operation of your typewriter, do not use a power outlet which is presently being used for a copier or other device which consumes a large volume of power.

Do not use your typewriter in the following environmental conditions:

- In direct sunlight where additional heat will be generated.
- In areas where the atmosphere is extremely salty or where corrosive gases are present.
- On surfaces that are not flat, or subject to vibration.

Batteries

If improperly used, the batteries may leak and cause corrosion. Therefore, observe the following:

- Insert batteries properly so that the polarity matches the plus (+) and minus (-) positions indicated in the bottom of the battery compartment.
- Do not use new and old batteries together.
- Do not use batteries of different types together. Some batteries differ in voltage, even though they have the same shape.
- Do not attempt to recharge the batteries.

Cleaning

Use only a soft, dry cloth to clean your typewriter. Water or thinners may damage the cover, case, or electronic circuitry.

Cables

The Parallel Interface (KX-EIP2) requires a shielded cable less than 6½ feet in length.

CHANGING SUPPLIES

Changing the Ribbon Cartridge

- 1 Lift the top cover of your typewriter
- 2 Grasp the cartridge on both sides and lift it up and out of the machine

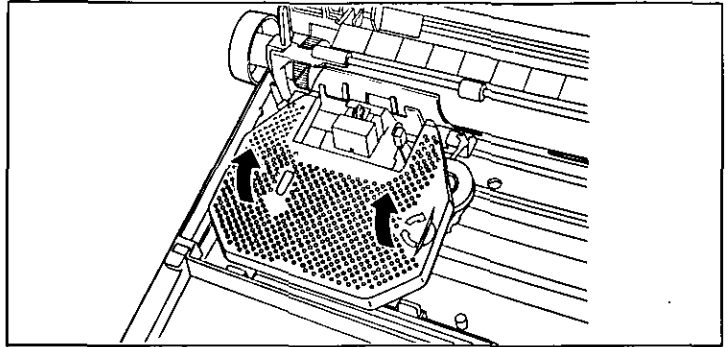

- 3 To insert a new cartridge, place the front portion (where the ribbon is exposed) between the card holder and the tape guides. Snap the back end of the cartridge onto the printer

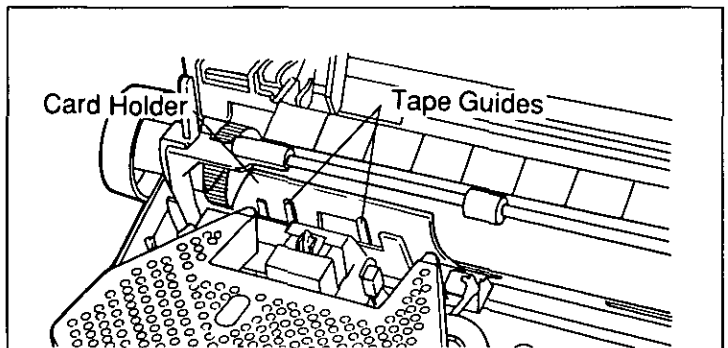

- 4 Advance the thumb wheel on the cartridge clockwise until the ribbon slack is tightened

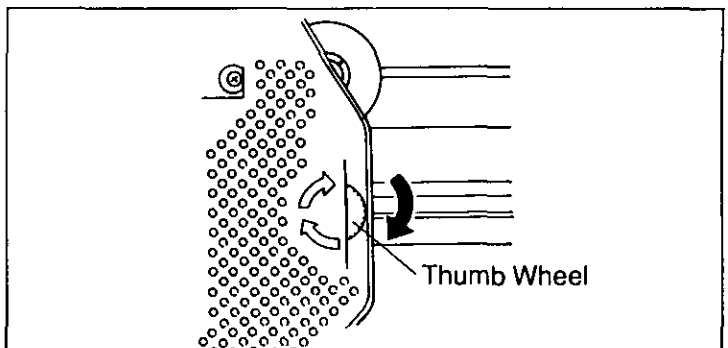

Changing the Correction Tape

- 1 Lift out the ribbon cartridge and remove the two spools of lift-off tape

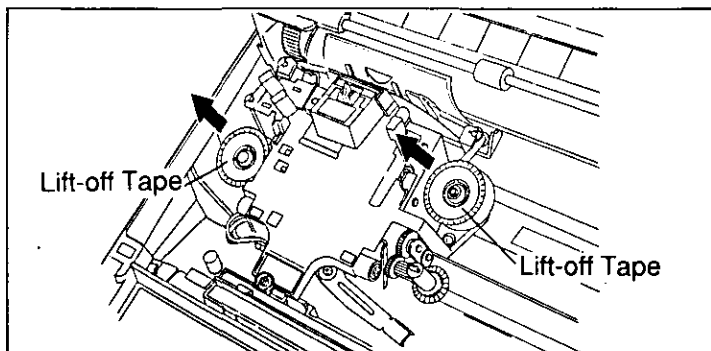

- 2 Place the loaded spool of the new tape on the left pin
- 3 Feed tape around white spools. Place empty spool of the correction tape on the right pin

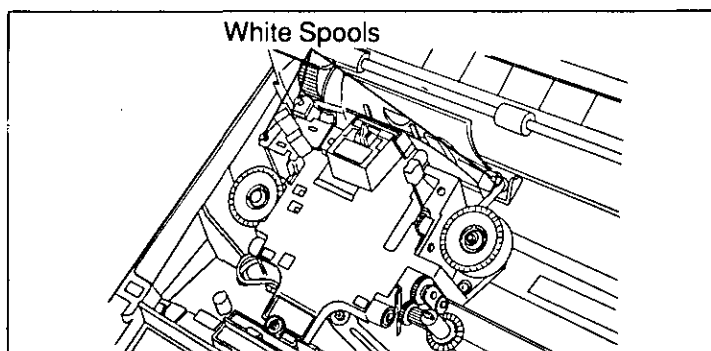

- 4 Manually turn the right hand spool counter-clockwise, tightening the tape until resistance is felt

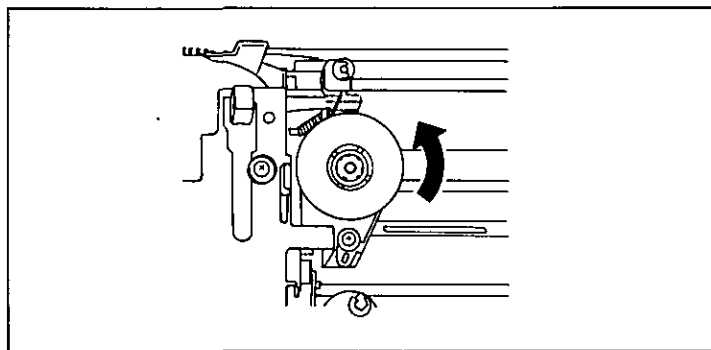

- 5 Replace the typing ribbon cartridge

Changing the Daisywheel

- 1 Lift out the ribbon cartridge
- 2 Pull the green lever that is located to the right of the printhead towards you. Grasp the clear plastic cartridge and lift the daisywheel out of the machine.

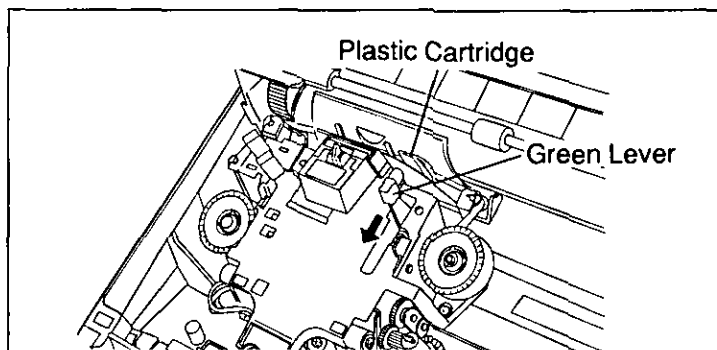

- 3 Place the plastic cartridge of another daisywheel in the carrier with the characters facing the platen. Push the right side of plastic cartridge down into the carrier and push the green lever back into position.

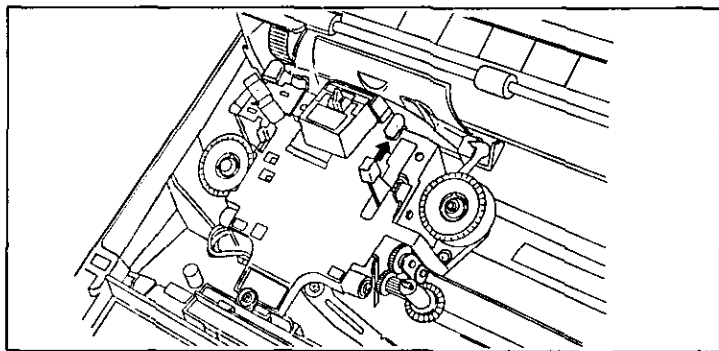

- 4 Replace ribbon
- 5 Close top cover

Changing the Batteries

The unit must remain on when the batteries are being replaced to insure that the memory remains intact. When your typewriter is turned off, the memory (auto insertion point, formats, forms layout, etc.) is retained through three "AA" size batteries. Your typewriter will alert you when the batteries need to be replaced. You will hear a prolonged beep when turning the typewriter on.

To replace the batteries:

- 1 Press SPACE BAR or TAB to position the printer at the far right of the typewriter
- 2 Open the top cover
- 3 Remove the battery compartment lid

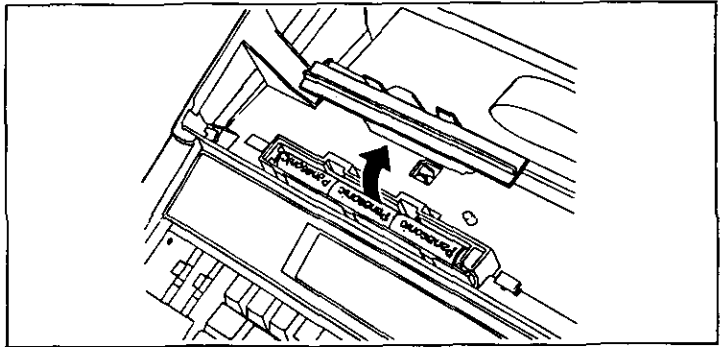

- 4 Push the left edge of the right battery and remove all batteries

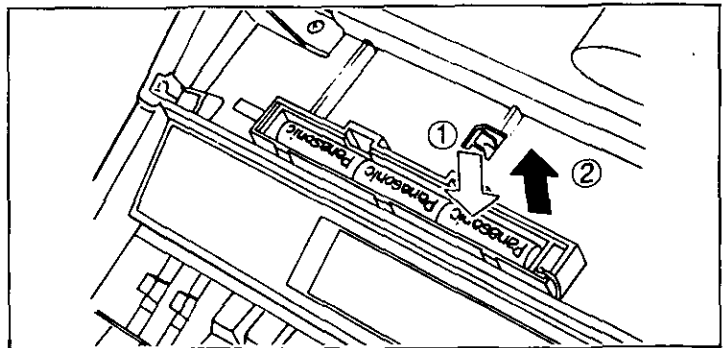

- 5 Insert the new batteries as shown in the bottom of the compartment
- 6 Replace the lid and close the top cover

PLATEN REMOVAL AND INSTALLATION

Removing the Platen

If you have to remove the platen to clear a gummed label or clean the platen, please follow the instructions below:

- 1 Turn the power off
- 2 Open the top cover
- 3 Pull the paper release lever and paper bail release lever toward the front of the machine

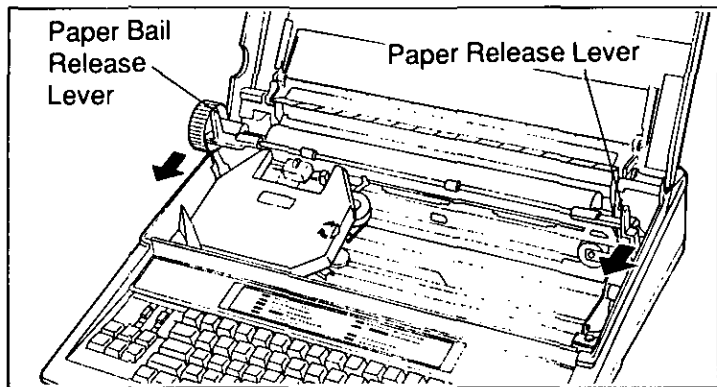

- 4 Pull both black levers of the platen holders towards the front of the machine to unlock

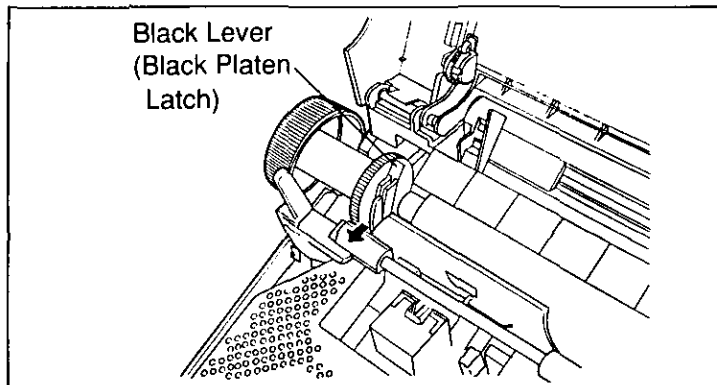

- 5 Lift out the platen

Installing the Platen

- 1** Position the black platen latches (included with Black Levers) inside the side carriage slots.
- 2** Push both levers of the platen holders back to secure the platen.
- 3** Reset the paper release lever, the paper bail release lever and the eraser table. Then close the top cover.

SHIPPING INFORMATION

The carrier stopper keeps the printer stationary during shipping. Remove the stopper before turning the unit on.

When you transport or ship the typewriter, be sure to follow the steps below.

- 1 Position the printer at the far left of the unit.
- 2 Install the carrier stopper on the carrier shaft so that the printer does not move.

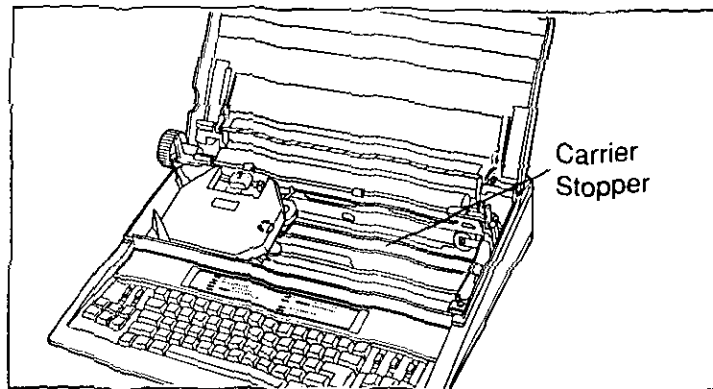

TROUBLESHOOTING

PROBLEM	REMEDY
1. Character spacing is erratic.	<ul style="list-style-type: none">● Make sure the "Pitch Selector" agrees with the pitch indicated on the daisywheel.
2. Character printout is not clear.	<ul style="list-style-type: none">● Make sure the ribbon is good.● Make sure the "Pitch Selector" and "Impact Control Selector" are set correctly.
3. Characters cannot be printed.	<ul style="list-style-type: none">● Make sure the daisywheel is mounted correctly on the printer.● Change the ribbon cartridge.
4. Characters cannot be cancelled.	<ul style="list-style-type: none">● Make sure the correction tape matches the type of ribbon cartridge being used.● Make sure the correction tape is installed correctly.● Change the correction tape.
5. Character printout is scrambled.	<ul style="list-style-type: none">● The printwheel is misaligned. Press CODE+T twice to reset the typewriter.

If the problem persists after performing all of the above checks, call for service.

KX-EIP2

Parallel Interface

SPECIFICATIONS

Print Element:	Daisywheel; 100 char.
Print Speed:	16 char./sec. (max. speed)
Print Pitch:	10 char./inch 12 char./inch 15 char./inch Proportional Spacing
Line Spacing:	1, 1½, 2 and 3 lines
Paper Width:	14.2 inches Max. (361 mm Max)
Writing Line:	11.5 inches Max. (292 mm Max.)
Ribbon Cassette:	Correctable Carbon Ribbon (Black, Blue, Brown) Non-Correctable Single Strike Carbon Ribbon (Black) Multi-Strike Ribbon (Black) Fabric Ribbon (Black)
Correcting Tape:	Lift Off Tape Cover Up Tape
Keyboard	Alpha/Numeric Key; 45 keys Function key; 28 keys
Correction Memory:	One line Max
Line Format Memory:	3 formats + current
Power Requirements:	Refer to the nameplate located on the rear of the typewriter
Memory Protection:	1 year - 3 "AA" size batteries
Storage Environment:	-4°F - 140°F (-20°C - 60°C) temperature, 10% - 90% humidity
Operating Environment:	50°F - 104°F (10°C - 40°C) temperature, 20% - 80% humidity
Dimension:	20 ¹ / ₁₆ (W) × 17 ³ / ₈ (D) × 6 ⁷ / ₈ (H) in. (510 × 442 × 174mm)
Weight:	Approx. 19 lbs. (8.6kg)

Specifications subject to change without notice.

- A** Auto paper eject9
Auto paper insertion9
- B** **BACKSPACE**8
Batteries41,45
Bold print20
- C** Caps lock20
CENTER7
Centering23
 At right margin24
 Between margins23
 Between tabs24
 Columns25
 Over a point23
Character keys4
CODE7
Code operations39
Copy control lever3
CORRECT8
Correcting errors15
 On the same line16
 Outside correction memory . .17
 Using **NO PRINT** method . .17
Correction tape43
Cover interlock switch3
- D** Daisywheel44
DEC TAB7
Decimal tabulation28
 With decimal point28
 With comma28,37
Default settings37
- E** **EXPR**8
- F** Function keys7
- H** **HALF SPACE**8
Hot zone13
Hyphen (temporary hyphen) . .30
- I** Impact control6
Indent (**↑ IND**)7,26
 Block indent27
 Left indent26
INDEX (**↓**)14
Insert (**INS**)7
- K** **KB I/KB II**6
Keyboard layout4
- L** Left margin (**LEFT MGN**) . . .8
Lines per vertical inch5,37
Line spacing5
- M** Margin formats12
 Storing12
 Recalling13
Margins10
 Clearing11
 Setting10
Margin release (**M.R.**)7
Micro indexing14
Micro space31
Mode selector5
 AUTO5
 NORM5
 STOR5
- O** **ON/OFF** switch2
Overlapped characters32
- P** Paper bail release2
Paper length9,37
Paper release lever2
Paper support1
Permanent space31
Pitch selector5
Platen46
 Installing47
 Removing46
PRINT7
- Q** **QUICK ERASE**8,15,16
- R** **RELOC**8
REPEAT7
REVERSE INDEX (**↑**)8
Ribbon cartridge42
Right margin (**RIGHT MGN**) . .8
Right margin alignment24

S	Selector switches5.6
	SHIFT7
	SPELL7
	SpellScan33
	Deleting a word35
	Inserting a word34
	Listing36
	Turning off34
	Turning on33
	Subscripts14
	Superscripts14
	Supplies42-45
T	TAB CLEAR8
	TAB SET8
	TAB7
	Tabs10
	Clearing11
	Decimal28
	Setting10
U	Underscore21
	Continuous21
	Double22
	Word by word21
X	<u>XXX</u>7

Panasonic Communications & Systems Company
Division of Matsushita Electric Corporation of America
Two Panasonic Way, Secaucus, New Jersey 07094

PJQX6130ZA S1090B0

Free Manuals Download Website

<http://myh66.com>

<http://usermanuals.us>

<http://www.somanuals.com>

<http://www.4manuals.cc>

<http://www.manual-lib.com>

<http://www.404manual.com>

<http://www.luxmanual.com>

<http://aubethermostatmanual.com>

Golf course search by state

<http://golfingnear.com>

Email search by domain

<http://emailbydomain.com>

Auto manuals search

<http://auto.somanuals.com>

TV manuals search

<http://tv.somanuals.com>