

Panasonic

Video Cassette Recorder

NV-HV60 Series (Hi-Fi)

NV-HV50 Series (Hi-Fi)

NV-MV15 Series (Mono)



NV-SV120 Series (S-VHS, Hi-Fi)



VHS
PAL

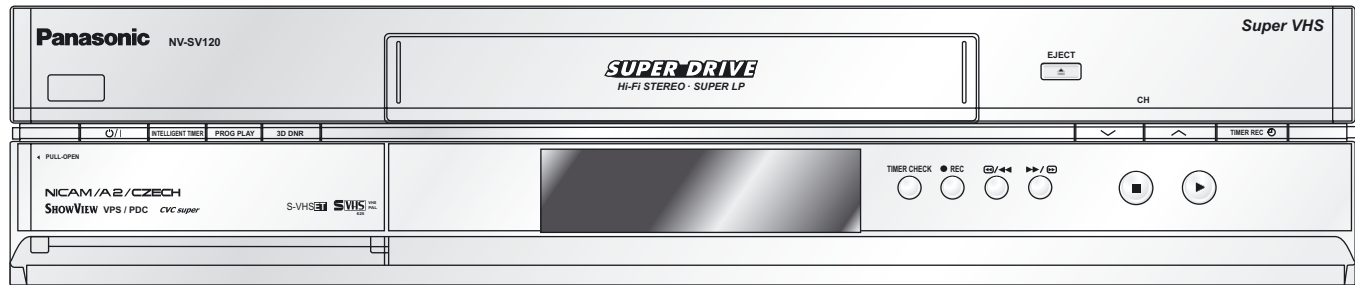

Operating Instructions

Contents	page
Precautions	2
Warning	3
Remote control functions	4- 5
Front	6
Connectors	7
Settings	8
Auto Setup	9
Recording	10
Timer recording	
Automatic SP/LP selection	11
VPS/PDC function	11
Timer recording	12-13
ShowView	14
INTELLIGENT TIMER	15
General functions	16-17
Menu Overview	18
Manual Setup	
Setting a new Channel	19
Changing the name of TV stations	20
Changing the order of TV stations	20
Creating a new station table	21
Shipping condition, factory defaults	21
Menu Others	22-23
Decoder	24
External recording control	25
Amplifier, NICAM sound system	26
NTSC playback	26
Batteries, Cassette erasure protection	27
Before requesting service	28-29
Specifications	30-31
Index	32

Dear customer

Thank you for purchasing this product. For optimum performance and safety, please read these instructions carefully. Please keep this manual for future reference.

Precautions

Voltage: Only use power sources complying with the specifications (220-240 VAC, 50/60 Hz). You may otherwise overload the unit and cause fire. Do not use DC power sources. Check the source carefully when setting up the unit on a ship or other place where DC is used.

AC mains lead protection: Ensure the AC mains lead is connected correctly and not damaged. Poor connection and lead damage can cause fire or electric shock.

Service: Do not attempt to repair this unit by yourself. If the sound fails, the display is off, smoke escapes from the unit or any other problem occurs that is not described in these operating instructions, disconnect the power supply and contact your dealer or an authorised aftersales service centre.

Accessories Included (Remote control unit depends on the model)



Remote Control
N2QAKB000043/ N2QAHB000031

Remote Control Batteries
AA, UM3 or R6

AC Mains Lead
RJA0043-1C

Operating Instructions
RQTD0080-Y

RF Coaxial Cable

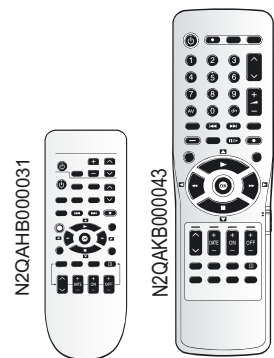

Warning

WARNING:

TO REDUCE THE RISK OF FIRE, ELECTRIC SHOCK OR PRODUCT DAMAGE, DO NOT EXPOSE THIS APPARATUS TO RAIN, MOISTURE, DRIPPING OR SPLASHING AND ENSURE THAT NO OBJECTS FILLED WITH LIQUIDS, SUCH AS VASES, SHALL BE PLACED ON THE APPARATUS.

CAUTION!

- **DO NOT INSTALL, OR PLACE THIS UNIT, IN A BOOKCASE, BUILT-IN CABINET OR IN ANOTHER CONFINED SPACE. ENSURE THE UNIT IS WELL VENTILATED. TO PREVENT RISK OF ELECTRIC SHOCK OR FIRE HAZARD DUE TO OVERHEATING, ENSURE THAT CURTAINS AND ANY OTHER MATERIALS DO NOT OBSTRUCT THE VENTILATION VENTS.**
- **DO NOT OBSTRUCT THE UNIT'S VENTILATION OPENINGS WITH NEWSPAPERS, TABLECLOTHS, CURTAINS, AND SIMILAR ITEMS.**
- **DO NOT PLACE SOURCES OF NAKED FLAMES, SUCH AS LIGHTED CANDLES, ON THE UNIT.**
- **DISPOSE OF BATTERIES IN AN ENVIRONMENTALLY FRIENDLY MANNER.**

THIS UNIT IS INTENDED FOR USE IN MODERATE CLIMATES.

This product may receive radio interference caused by mobile telephones during use. If such interference is apparent, please increase separation between the product and the mobile telephone.

Remote control functions

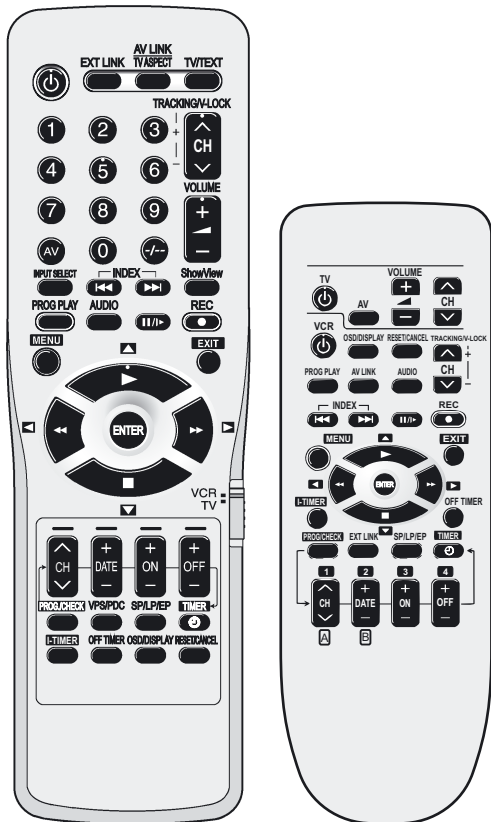















Some Panasonic TV sets accept control signals from the video recorder's remote control unit. In the table, the TV buttons are marked with 'TV', the video recorder buttons with 'VCR'.













Control menu

	OSD menu selection buttons.	VCR
	Displays the menu.	VCR
	Quits a menu.	VCR
	Selects or saves a setting.	VCR

Playback functions

	Playback	VCR
	Fast winding / Forward and backward search <ul style="list-style-type: none"> • Goes from Stop into Fast Forward or Fast Rewind mode. • Starts the search for a frame during playback. Press button twice to increase the speed of search (JET SEARCH). Press the Playback button ► to quit the Search mode. • The unit keeps searching while the button is pressed. 	VCR P. 17
	Press Stop to stop recording, playing back or winding. To eject a cassette: Press button for more than 3 seconds.	VCR
	Still Playback: In Playback mode. Press button again or press the Playback button ► to quit. Slow Playback: Press for more than 2 seconds while in Playback mode. Press the Playback button ► to quit.	VCR P. 17

	Stand-by/on switch  Press to switch the unit from on to stand-by mode or vice versa. In stand-by mode, the unit is still consuming a small amount of power.	VCR TV
	Activates the recording timer for externally controlled recording.	VCR P.25
	Toggles between TV reception and video playback channel. Changes the screen format.	VCR TV
	Toggles between TV reception and video text reception.	TV
	Selects a programme memory location and inputs the ShowView number. Example: 18=  1 	VCR TV
	Selects the TV set's AV port.	TV
	Channel selector Tracking control of disturbed VCR image.	VCR TV
	Volume control.	TV
	Toggles between AV inputs A1, A2 and A3.	VCR
	Finds the start of a programme.	VCR P. 16
	Displays the ShowView menu.	VCR P. 14
	Plays back programmed recordings.	VCR P. 13

	Audio mode	VCR P. 16
	Record	VCR P. 10
	TV : Selects the AV input and navigates in the teletext menu. VCR: Menu entries.	VCR TV
	Displays the Timer menu.	VCR P. 12
	Controls the beginning and end of a recording session by a special signal.	VCR P. 11
	Sets the tape speed.	VCR P. 10
	Activates the recording timer.	VCR P. 12
	Defines programmes transmitted to the same programme memory location at the same time.	VCR P. 15
	Switches the unit into stand-by mode after the set time of recording, playback or in Stop mode.	VCR P. 17
	Press the button repeatedly to display the time, tape counter or remaining tape.	VCR P. 10
	RESET : Resets the counter to 0:00.00. CANCEL: Clears an entry you made.	VCR
	VCR / TV switch	VCR TV

Front

NV-HV60, NV-HV50, NV-MV15

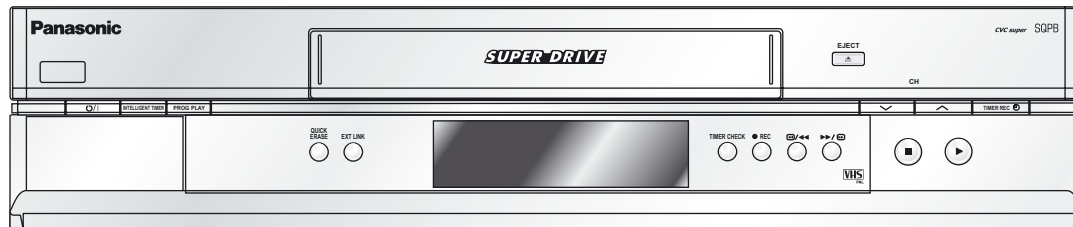

NV-SV120

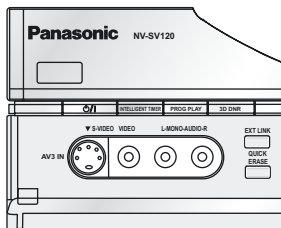
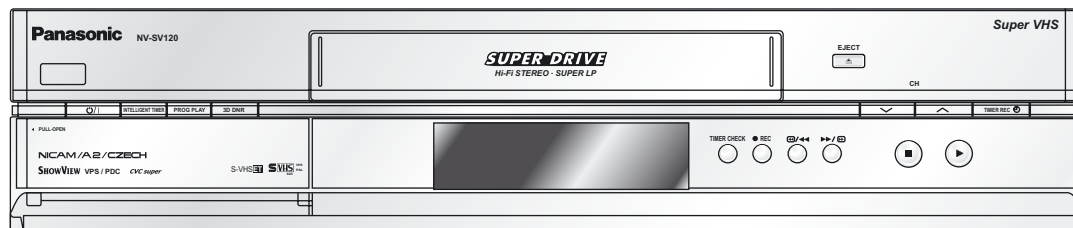

CVC Super

The CVC function provides a picture of perfect quality. The picture is automatically rendered as clear and sharp as possible.

3D DNR

To ensure high playback picture quality with less noise.

	Stand-by/on switch		Activates the recording timer.
	Defines timer programmes.		Displays the timer programme for verification.
	Plays back programmed recordings.		Record button
	3-Dimensional Digital Noise Reduction (S-VHS only)		Fast winding / jet search
	Ejects the cassette.		Stop button
	Selects a channel.		Playback button
	Activates the recording timer for externally controlled recording.		Erases a cassette.

Connectors

**AC IN~
SECTEUR~** = Power supply

AV2 (DECODER/DECODEUR/EXT)

AV1 (TV)

**S-VIDEO
OUT/SORTIE** = S-VIDEO output

VIDEO = VIDEO output

L/G = AUDIO output left channel

R/D = AUDIO output right channel

**IN/
ENT** = Antenna input

**OUT/
SORTIE** = Antenna output

NV-SV120

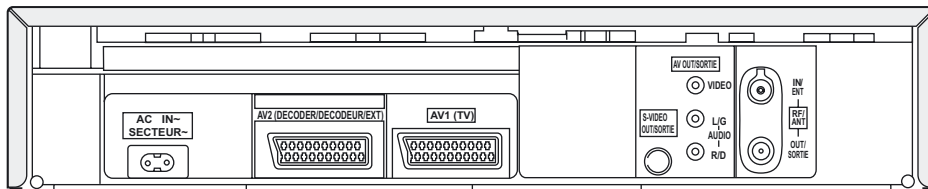

NV-HV60

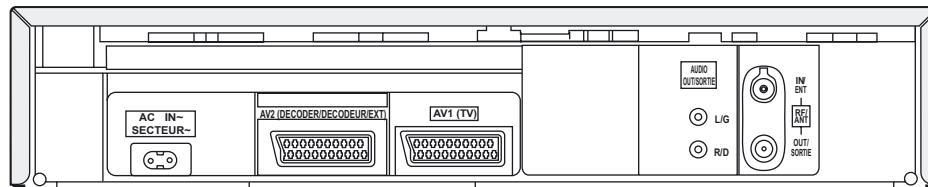

NV-MV15 NV-HV50

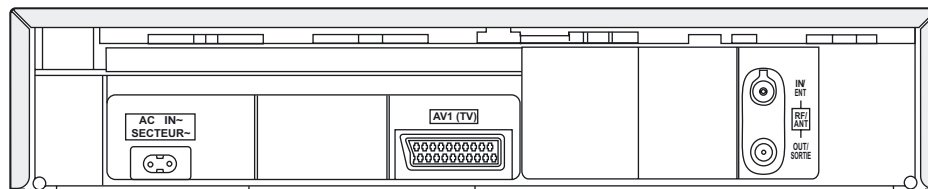

Settings

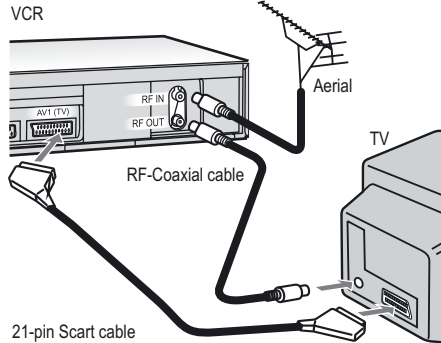

Connect all the cables as shown in the illustration, then connect the AC Mains lead (part of the package) to an AC wall outlet.
To be able to receive TV programmes it is mandatory to connect the RF-Coaxial cable even if the video recorder is connected by a 21-pin Scart cable.

If you decide to just use the RF-Coaxial cable to connect the TV set you must adjust the video output channel with the TV set's input channel.

-  Switch on the video recorder
- Press the **MENU** button for approx. 7 seconds. The preset channel appears on the display.
- Tune the TV set until the test pattern appears.
If there is any interference select another channel for the TV set and video recorder.
- Press the **CH** button to change the channel (e.g. to 38).
- Tune the TV set until the test pattern appears.
- Press **ENTER** to confirm.



Recording

SV120 HV60 HV50 MV15



Set the TV set to the video channel and insert a cassette into the video recorder; make sure that the cassette's protection tab is still in.

- Select a channel to record from.
Select the AV channel if you are recording via the 21-pin scart cable.
 - Press **REC** to start recording.
 - Press the Stop button ■ to stop recording.
 - To pause recording: ■▶
The function will switch itself off after approx. 5 minutes to protect the video heads.
 - To resume recording: ■▶▶
- * Recordings in the S-VHS or S-VHS ET REC mode are supported by the PAL TV system only. (Only SV120, page 23)

SV120 HV60 HV50 MV15

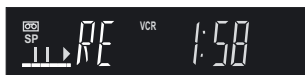

OSD/DISPLAY



Tap e remain counter

The display of the video recorder shows: time - counter - tape remain
The start of a cassette is indicated as -----.

- Press **OSD/DISPLAY** until 'RE' is displayed.

SV120 HV60 HV50 MV15



SP/LP/EP



- Prior to starting the recording session, press **SP/LP/EP** to set the tape speed.
SP : normal recording time - optimal picture quality
LP : double recording time - simple picture quality
EP : triple recording time - reduced picture quality

* When you play back LP or EP recordings, some cassettes (e.g. E-300 type) may produce interference. This is not indicative of a malfunction.

Timer recording

SV120 HV60 HV50 MV15

Automatic SP/LP selection

A: If, at the beginning of a timer programme, there is not enough tape remain to complete it, the SP/LP function will automatically run the tape at LP speed. This ensures that the entire programme will be recorded. If the LP mode is not enough to 'stretch' the remaining tape to fit you will not be able to record all of the TV programmes.

* It is not possible to automatically activate the EP mode.

SV120 HV60 HV50 MV15

VPS/PDC function



This setting defines how a special signal controls the beginning and end of a recording session. If a TV programme begins or ends earlier or later than planned, this function synchronises the beginning and end of the recording session with the actual beginning and end of the TV programme.

ON : The station transmits VPS/PDC signals. You must set the timer to the time specified in the TV magazines. Use the special VPS time the TV magazine may indicate.

- - - : The station does not transmit VPS/PDC signals. Try to set the start and stop time such that the entire film can be recorded even if a programme begins or ends earlier or later than planned.

Timer recording

SV120 HV60 HV50 MV15

PROG/CHECK



The Timer recording allows you to programme the recording time of TV programmes up to 1 month in advance. Use the on-screen menu to programme a maximum of 16 recordings.

Timer recording							1 / 3	
Pos	Date	Start	Stop		VPS/PDC			
1	ARD	31/12	10:30	11:30	SP	ON		
1	ARD	31/12	11:30	12:30	SP	ON		
2	ZDF	31/12	12:30	13:30	SP	ON		
4	RTL	31/12	13:30	14:30	SP	ON		
6	VOX	31/12	14:30	15:30	SP	ON		
--	----	--/--	--:--	--:--	SP	---		

:select **ENTER** : store
CANCEL : delete **EXIT** : exit

• PROG/CHECK

• ENTER

Use the cursor keys or to make the next entries.



• Select a station ▲▼, ► or press CH

• Set the date, week or day of week ▲▼, ► or press DATE

• Enter the start time: ▲▼, ► or press ON

• Enter the stop time: ▲▼, ► or press OFF

Keep the buttons pressed to change the time in 30-minute steps.

• Set the tape speed: **A** (Automatic), **SP**, **LP**, **EP** ▲▼, ►

• Press ▲▼ or the **VPS/PDC** button to change the VPS/PDC setting (does not apply to HV50, MV15).

• Press **ENTER** to save the timer programme.

• Repeat these steps for further recordings you may wish to programme.

• Press **TIMER** to activate the recorder's timer mode

Ensure that the video recorder symbol is displayed.

TIMER



* Do not forget to verify that there is enough tape remain. The length of the recording must not exceed the time remain on the video cassette.

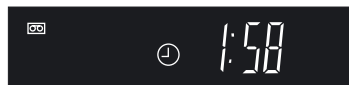

Timer recording

SV120 HV60 HV50 MV15



Quitting the timer mode

- Press **TIMER**; the video recorder symbol ☹ turns off.
You can now play back a cassette or make a manual recording.
Press **TIMER** again to reactivate the timer programme you entered previously.

TIMER CHECK



Displays the timer programmes for verifications (buttons on the unit only)

Repeatedly press the button to view the details of the timer programmes on the video recorder's display panel.

PROG/CHECK



Checking the timer programme

- Press **PROG/CHECK**, the Timer Recording menu will appear.
- Press **PROG/CHECK** again or **EXIT** to quit the menu.

Changing or cancelling a timer programme

- Press **PROG/CHECK** to display the Timer Recording menu.
- Press **▲▼** to select the entry you wish to edit.
- **ENTER**
- To change the entries: **◀▶▲▼**
- **ENTER**
- Press **RESET/CANCEL** to cancel the timer programme.

PROG PLAY



Playing back programmed recordings

The unit will rewind to the beginning of the programmed recording and automatically start playing it back.

- * You can also play back programmed recordings manually.

ShowView

SV120 HV60 HV50 MV15

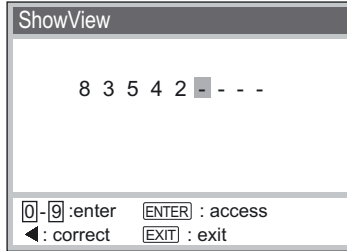

ShowView



- Press the ShowView button.
- Enter the ShowView number (press ◀ to correct any mistakes)
- **ENTER**

The Timer Recording screen is displayed.

- Press **TIMER** to activate the timer mode.
- Ensure that the video recorder symbol ⏻ is displayed.

TIMER

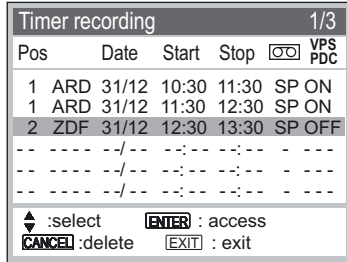

If the unit fails to automatically detect the station press ▲▼ or **CH** to enter it manually. The video recorder will store the information so that you will not have to enter it again later.

Editing the Timer recording data

- **ENTER**
- Select a station ▲▼, ► or press **CH**
- Set the date, week or day of week ▲▼, ► or press **DATE**
- Enter the start time: ▲▼, ► or press **ON**
- Enter the stop time: ▲▼, ► or press **OFF**
- Set the tape speed: **A** (Automatic), **SP**, **LP**, **EP** ▲▼, ►

- **ENTER**
- Press **TIMER** to activate the timer mode.

TIMER



* ShowView is a trademark of Gemstar Development Corporation.
The ShowView system is manufactured under licence from Gemstar Development Corporation.

INTELLIGENT TIMER

SV120 HV60 HV50 MV15



This function makes it easier for you to time the recording of programmes transmitted by the same station at the same time but on different days. You can fully modify the programmes once they have been transferred to the Timer Recording menu. The INTELLIGENT TIMER menu lists the information of the last 5 timer programmes.

To use the INTELLIGENT TIMER function you must first programme at least one normal timer programme.

INTELLIGENT TIMER		25/10/03				VPS PDC	
Pos	Date	Start	Stop				
1	ARD	25/10	10:30 11:30	SP	ON		
1	ARD	25/10	18:30 19:30	SP	OFF		
2	ZDF	25/10	12:30 13:30	A	ON		

◆ I-TIMER : select TIMER : store
 ENTER : edit ◀ : unlock ▶ : lock
 CANCEL : delete EXIT : exit

Timer recording		1 / 3				VPS PDC	
Pos	Date	Start	Stop				
1	ARD	26/10	10:30 11:30	SP	ON		
1	ARD	26/10	18:30 19:30	SP	OFF		
--	--	--/--	--:--	--	--		
--	--	--/--	--:--	--	--		
--	--	--/--	--:--	--	--		
--	--	--/--	--:--	--	--		

◀ :select ENTER : store
 CANCEL : delete EXIT : exit

- Press **I-TIMER**.
- Press **▲▼** or **I-TIMER** to select a programme.
- Press **TIMER** to activate the timer mode.
The oldest programmes will be cancelled automatically.
- Press **RESET/CANCEL** to cancel a programme.
- To protect the data press **▶**, the symbol is displayed.
- To unprotect the data press **◀**.

Editing a programme

- Press **I-TIMER**.
- Press **▲▼** or **I-TIMER** to select a programme.
- Press **ENTER** to display the Timer recording screen.
- To change any of the data press **◀▶▲▼**.
- Press **ENTER** to store a change.
- Press **TIMER** to activate the timer mode.

General functions



SV120 HV60 HV50 MV15

Repeat playback

The video recorder repeats playback from beginning to the end of the recording.

- In Stop or Playback mode, press the Playback button ► for longer than 5 seconds. The video recorder displays an 'R'.
- Press Stop ■ to stop playing back.



SV120 HV60 HV50 MV15

AUDIO settings

At each press of the **AUDIO** button, the selected sound output is indicated with L (Left) and R(Right).

Stereo	:	Display: LR
Left channel	:	Display: L -
Right channel	:	Display: - R
Mono	:	Display: - -

SV120 HV60 HV50 MV15



Finding the start of a recording

Quickly finds the start of a recording during playback or in Stop mode.

- ►► Fast forward / ◀◀ Rewind
Every time you press the button (max. 20 times) the video recorder will find the start of the next recording. Playback will start automatically.
- Press Stop ■ to exit the Search function.



General functions

SV120 HV60 HV50 MV15

Forward/backward search, jet search, still playback, slow playback

To protect the video heads, the unit automatically quits the Forward/Backward search, JET SEARCH, Still Playback, Slow Playback functions after 5-10 minutes. Interference and motor noise are not indicative of a malfunction.

SV120 HV60 HV50 MV15

Erasing a cassette

Press the **QUICK ERASE** button on the unit to remove all recordings from a cassette. It takes approx. 30 minutes to erase an E-180 cassette. Erasing avoids problems that may occur at the beginning and end of a recording taken straight over an existing one.

SV120 HV60 HV50 MV15



OFF TIMER



Limiting the recording and playback time

Switches the unit into stand-by mode after the set time of recording, playback or in Stop mode. Press the button repeatedly to extend the switch-off time from 30 to 60, 120, 180 or 240 minutes. The timer setting appears on the display of the video recorder.

SV120 HV60 HV50 MV15

3D DNR, 3-Dimensional Digital Noise Reduction

Press the **3D DNR** button on the unit to activate the function. The setting of this function is displayed on the TV screen.

Menu Overview

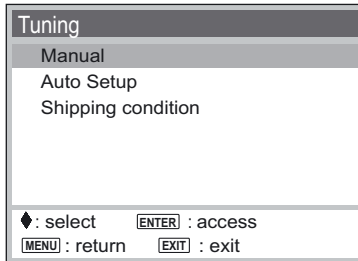
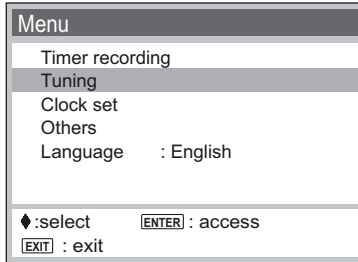

The cursor keys of the remote control unit ◀▶▲▼ allow you to move between menus and to change settings.

- Press **MENU** to display the Menu screen.
- Select an entry by pressing ▲▼.
- **ENTER**

The selected menu is displayed.

- Select the item you wish to edit ▲▼.
- **ENTER**
- Make the changes as appropriate. Follow the on-screen instructions.
- Press **MENU** to return to the previous menu.
- Press **EXIT** to quit the menu.

Manual Setup

Tuning					
Pos	Name	Ch	Pos	Name	Ch
1	ARD	7	6	VOX	8
2	ZDF	4	7	PRO7	95
3	N3	2	8	RTL2	85
4	RTL	12	9	KABE	97
5	SAT1	13	10	S-RT	98

[A]: delete [B]: move
 ◀ select [ENTER]: access
 [MENU]: return [EXIT]: exit

Pos	: 7
Name	: ----
Channel	: ----
Fine tuning	: AUTO
Decoder	: OFF
Video system	: AUTO
Mono	: OFF
Audio mode	: DK

Options available for fine-tuning the channels
 (Not every model supports all of the functions.)

Setting a new Channel

- Tuning ▼
 - ENTER
 - Manual
 - ENTER
 - Select a free line down the list: ◀▶▲▼
 - ENTER
- Press ◀▶ or the numeric keys to enter the channel number. Channel tuning will start. Wait until the desired station has been set. 'Fine tuning' may help to minimise any interference. 'Mono' may rid you of audio problems.
 - Press **MENU** to return to the Tuning screen.

Pos		Station position setting.
Name		Station name setting.
Channel		Channel setting.
Fine tuning	AUTO / MAN.	Fine-tuning of disturbed picture.
Decoder	ON / OFF	If a decoder is attached.
Video System	AUTO / PAL / MESECAM	TV system set-up.
Mono	ON / OFF	Stereo-to-mono toggle.
Audio mode	BG / I / DK	Audio system set-up

Manual Setup

Tuning					
Pos	Name	Ch	Pos	Name	Ch
1	ARD	7	6	VOX	8
2	ZDF	4	7	PRO7	95
3	N3	2	8	RTL2	85
4	RTL	12	9	KABE	97
5	SAT1	13	10	S-RT	98

[A]: delete [B]: move
◀ select [ENTER]: access
[MENU]: return [EXIT]: exit

Pos	:	1
Name	:	ARD
Channel	:	7
Fine tuning	:	AUTO
Decoder	:	OFF
Video system	:	AUTO
Mono	:	OFF
Audio mode	:	DK

◀ : select
[MENU]: return [EXIT]: exit

Tuning					
Pos	Name	Ch	Pos	Name	Ch
▶ 1	ARD	7	6	VOX	8
2	ZDF	4	7	PRO7	95
3	N3	2	8	RTL2	85
4	RTL	12	9	KABE	97
5	SAT1	13	10	S-RT	98

[A]: delete [B]: move
◀ move [ENTER]: store
[MENU]: return [EXIT]: exit

Changing the name of TV stations

- Tuning ▼
- **ENTER**
- Manual
- **ENTER**
- Select a TV station ◀▶▶▼
- **ENTER**

- Select the Name entry ◀▶.
- The cursor will mark the first letter **ARD**.
- Change that letter ▲▼
- Next letter ▶, **ARD**
- **MENU**
- The new name will be stored in the station table.

Changing the order of TV stations or deleting a station

- Tuning ▼
- **ENTER**
- Manual
- **ENTER**
- **[B]/Green**, an arrow at the left edge indicates which field has been selected.
- You can now move the station to any other location ◀▶▶▼.
- **ENTER**
- **[A]/Red** to delete the station.

Manual Setup

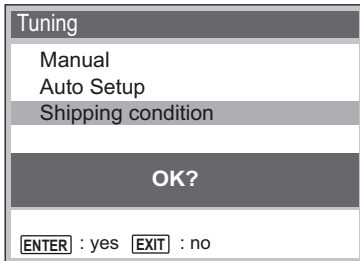
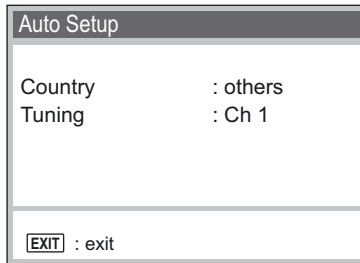
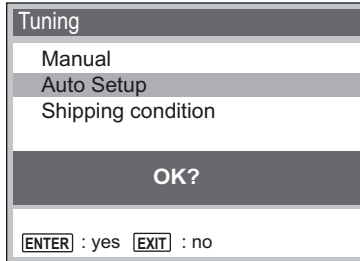

Creating a new station table

- Tuning ▼
- **ENTER**
- Auto Setup ▼
- **ENTER**

The Country menu will be displayed.

- Select a country ◀▶▶▼
- **ENTER**

The Auto Setup menu will be displayed.

The Automatic Tuning will start.

Shipping condition / restoring factory defaults

- Tuning ▼
- **ENTER**
- Shipping condition ▼
- **ENTER**

* To restore the factory defaults (shipping condition) briefly unplug the AC Mains lead.

Menu Others

SV120

Others		1 / 2
Tape length	:	AUTO (◀E-240)
AV2	:	DECODER
AV2 IN	:	VIDEO
AV1 OUT	:	VIDEO
TV system	:	AUTO
S-VHS playback	:	AUTO
OSD	:	4:3
◀ : select		
MENU : return EXIT : exit		

HV60

Others		1 / 2
Tape length	:	AUTO(◀E-240)
AV2	:	DECODER
TV system	:	AUTO
SQP B	:	AUTO
OSD	:	4:3
Power save	:	OFF
VCR display	:	ON

MV15 HV50

Others		1 / 2
Tape length	:	AUTO(◀E-240)
TV system	:	AUTO
SQP B	:	AUTO
OSD	:	4:3
Power save	:	OFF
VCR display	:	ON
RFC system	:	DK

Tape length	Sets the tape length of the cassette you use. AUTO (◀E - 240), E - 195, E - 260, E - 300
AV2	Selects the type of external unit connected to the video recorder's AV2 outlet. DECODER: If a decoder is connected. EXT : If another video recorder or satellite receiver is connected.
AV2 IN	Allows you to record the S-Video signal of an external unit connected to the video recorder's AV2 outlet. VIDEO : If the unit does not support S-VIDEO. S-VIDEO : If the unit support S-VIDEO. To connect use a 21-pin scart cable.
AV1 OUT	VIDEO : Video signal via the 21-pin scart cable. S-VIDEO : S-Video signal via the 21-pin scart cable.
TV system	AUTO : Automatically detects PAL or MESECAM. PAL : If you are using the PAL system. MESECAM: If you are using the MESECAM system.
S-VHS playback	AUTO : The VCR automatically detects the type of recording. ON : Plays back S-VHS format cassettes in the S-VHS format. OFF : Plays back cassettes recorded in VHS format only.
OSD	4:3 : Displays appear at the edge of the screen (displays not visible on 16:9 format screens). WIDE : Displays appear at the edge of the screen (displays appear in the middle on 4:3 format screens). OFF : No on-screen displays.
SQP B	AUTO : The VCR automatically detects the type of recording. ON : Plays back S-VHS format cassettes in quasi S-VHS format. OFF : Plays back cassettes recorded in VHS format only.

Menu Others

SV120

Others		2 / 2
Power save	: OFF	
VCR display	: DIMMED	
S-VHS REC	: ON	
S-VHS ET REC	: OFF	
RFC system	: DK	
EXT LINK	: 2	
◀ : select [MENU] : return [EXIT] : exit		

HV60

Others		2 / 2
RFC system	: DK	
EXT LINK	: 2	
◀ : select [MENU] : return [EXIT] : exit		

MV15 HV50

Others		2 / 2
EXT LINK	: 2	
◀ : select [MENU] : return [EXIT] : exit		

Press ▲▼ to display the 2nd screen.

Power save (only in stand-by mode)	ON : The video recorder's display unit is off. In Power Save mode, you cannot change the VCR display setting. OFF : Factory setting; you can change the VCR display setting.
VCR display (only in stand-by mode)	Available only if the unit is not in Power save mode. DIMMED : The video recorder's display is dimmed. ON : The video recorder's display unit is on at normal brightness.
S-VHS REC	In conjunction with the PAL TV system only. ON : For S-VHS format recordings on a S-VHS type cassette. OFF : For VHS format recordings on a S-VHS type cassette.
S-VHS ET REC In SP mode only	In conjunction with the PAL TV system only. ON : Takes recordings at a higher picture quality on VHS-HG cassettes. OFF : Takes standard quality recordings.
RFC system	DK / I / BG : TV system set-up
EXT LINK	2 : External recording control by satellite receivers or digital receivers (video signal). 1 : For digital receivers transmitting a special recording control signal, e.g. the F.U.N. receiver (TU-DSF31).

Decoder

SV120 HV60 HV50 MV15

Others		1 / 2
Tape length	: AUTO(◀ E - 240)	
AV2	: DECODER	
AV2 IN	: VIDEO	
AV1 OUT	: VIDEO	
TV system	: AUTO	
S-VHS playback	: AUTO	
OSD	: 4:3	
◀ : select		
[MENU] : return [EXIT] : exit		

Connecting a decoder

Use a 21-pin scart cable to connect the decoder to the video recorder's AV2 socket.

- Others ▼
- Set AV2 to DECODER ▼
This setting does not allow you to change option AV2 IN.
- Press **MENU** to return to the Menu screen.

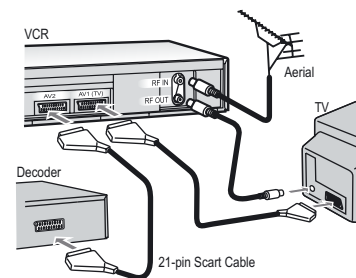

DECODER : If a decoder is connected.

EXT : If an external unit is connected, e.g. a second recorder or satellite receiver.

Tuning					
Pos	Name	Ch	Pos	Name	Ch
1	ARD	7	6	VOX	8
2	ZDF	4	7	PRO7	95
3	N3	2	8	RTL2	85
4	RTL	12	9	PREM	97
5	SAT1	13	10	S-RT	98
[A] : delete [B] : move					
◀ : select [ENTER] : access					
[MENU] : return [EXIT] : exit					

Setting the channel to Decoder

- Tuning ▼
- **ENTER**
- Manual
- **ENTER**
- Select a coded channel ▲▼
- **ENTER**
- Set Decoder to ON ▼,◀▶
- Press **MENU** to return to the station table.

Pos	: 9
Name	: PREM
Channel	: 97
Fine tuning	: AUTO
Decoder	: ON
Video system	: PAL
Mono	: OFF
Audio mode	: DK
◀ : select	
[MENU] : return [EXIT] : exit	

External recording control

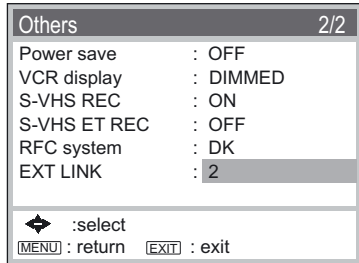

SV120 HV60 HV50 MV15

External recording control

- Others ▼
- Select EXT LINK 2 or 1
- Press **MENU** to return to the Menu screen.

EXT LINK 2: External recording control of some satellite or digital receivers (video signal).

EXT LINK 1: For digital receivers transmitting a special recording control signal, e.g. the F.U.N. receiver (TU-DSF31).

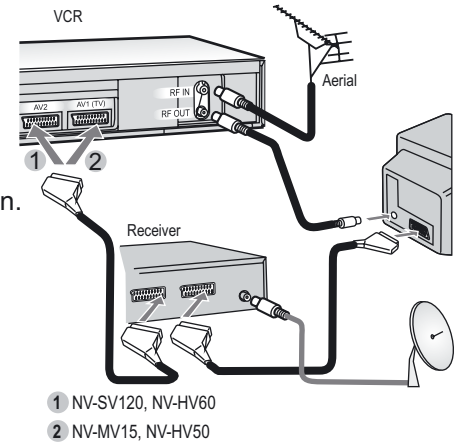

- Press **EXT LINK** to activate the recorder's recording stand-by mode. The video recorder will record all video output transmitted by the satellite- or digital receiver.

The following screen will be shown if you selected EXT LINK:

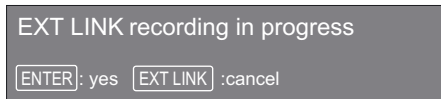

- Press **ENTER** to hide the message.
 - Press **EXT LINK** to stop recording.
- * Be sure that the timer programmes stored by your video recorder do not overlap the ones of the satellite or digital receiver.

Amplifier

SV120 HV60 HV50 MV15

Connect an amplifier

Use an audio cable to connect your video recorder to a stereo amplifier.

Left = white (L/G) Right = red (R/D)

If you have a scart adapter cable you can also connect the video recorder's AV socket to an amplifier.

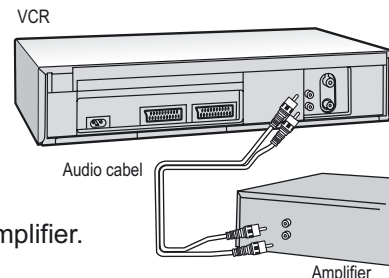

NICAM sound system

SV120 HV60 HV50 MV15

Select Mono: ON to record mono sound on the Hi-Fi-Audio tracks of the video recorder or if the quality of stereo sound reception is bad.

- Tuning ▼
- **ENTER**
- Manual
- **ENTER**
- Select a channel ◀▶▲▼
- **ENTER**
- Mono to ON or OFF ◀▶

Pos	:	1
Name	:	ARD
Channel	:	7
Fine tuning	:	AUTO
Decoder	:	OFF
Video system	:	PAL
Mono	:	OFF
Audio mode	:	BG
◀▶ : select		
[MENU] : return [EXIT] : exit		

Tuning					
Pos	Name	Ch	Pos	Name	Ch
1	ARD	7	6	VOX	8
2	ZDF	4	7	PRO7	95
3	N3	2	8	RTL2	85
4	RTL	12	9	KABE	97
5	SAT1	13	10	S-RT	98

[A] : delete [B] : move
◀▶ : select [ENTER] : access
[MENU] : return [EXIT] : exit

NTSC playback

SV120 HV60 HV50 MV15

Playing back NTSC video cassettes

You can play back NTSC video cassettes for viewing on a PAL system TV set. Try to fine-tune your TV set if you experience interference when playing back NTSC cassettes. Please refer to the operating instructions of your TV set. You cannot record on or copy video cassettes to NTSC-format cassettes.

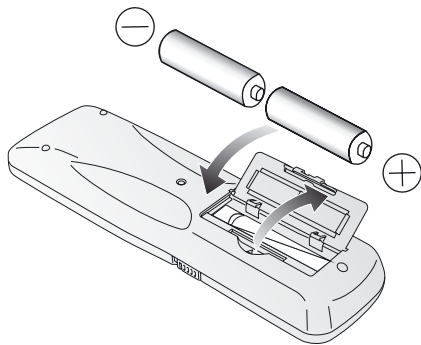

Inserting batteries into the remote control unit:

The batteries last for about a year, depending on how often you use the RC unit.

- Do not mix old with new batteries or batteries of different types. .
- Only use batteries without any harmful substances (such as lead, cadmium, mercury).
- Do not use rechargeable type batteries.
- Remove the batteries if the remote control unit will remain unused for longer periods of time.
- Do not heat or short-circuit the batteries.
- Immediately remove used-up batteries and replace with batteries of type AA, UM3 or R6.
- Be sure to put in the batteries the right way round (+and -).

Dispose of **batteries**, packaging material and the unit according to statutory regulations.

They must not be thrown into the household refuse.

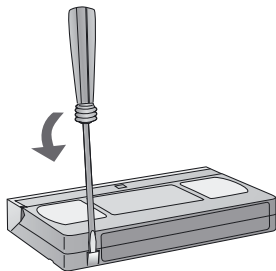

Cassette erasure protection

Break out the erasure protection tab to protect the cassette against accidental erasure of recordings you wish to keep. Stick adhesive tape over the gap if you wish to re-record a protected cassette.

Before requesting service

Manual correction of a bad picture:	<ul style="list-style-type: none">• If you notice interference or a shift of the picture during normal, still or slow motion playback, press the TRACKING / V-LOCK button towards + or - to correct the picture.• Press + and - together to actuate automatic correction. Some video cassettes do not support tracking control. This is not indicative of a malfunction.
The display of the video recorder does not light up:	<ul style="list-style-type: none">• Verify that the AC mains lead is properly attached.• Check your Power save setting (page 23).
The display of the video recorder is on but the unit does not respond to any input:	<ul style="list-style-type: none">• There is an active timer programme. Press the TIMER button to deactivate it.
Noise from the transport mechanism:	<ul style="list-style-type: none">• The unit's transport mechanism produces some noise when winding the tape fast forward or backward. This is not indicative of a malfunction.
The automatic clock does not set correctly:	<ul style="list-style-type: none">• Set Clock set to AUTO (page 9).• Set Time and Date manually if the unit does not find a station emitting the time signal.• Check your Power save setting (page 23).

Before requesting service

Bad picture or sound:	<ul style="list-style-type: none">• The use of E-300 cassettes may cause problems if the recordings were taken at slow tape speeds (LP or EP).• Check the settings for PAL, MESECAM (page 22), NTSC (page 26).• Verify that the aerial and/or scart cables are attached and work properly.• Check the SQPB setting for S-VHS cassettes (page 22).• Faulty recordings taken at slow tape speed (EP) in MESECAM are not indicative of a malfunction.• Please contact your service technician if the video heads are dirty or worn out. Having a technical service shop clean the video heads is not covered by the guarantee.
The remote control unit does not work properly:	<ul style="list-style-type: none">• Check the distance between the RC unit and the VCR (max. 7 metres).• Check the batteries in the remote control unit (page 27).
The recording functions do not work properly:	<ul style="list-style-type: none">• If  flashes on the unit, check if the protection tab of the video cassette is still in.• Check the Clock set menu (page 9).• Check the start and stop time of the timer programme (page 12).• Check if the TIMER button has been pressed to put the unit into timer mode after programming a recording (page 12).• Check the start and stop time of a VPS/PDC recording (page 11).

Please contact our aftersales service if you fail to remove problems yourself.

The model number and serial number of this product can be found on the back of the unit. Please note them and keep for future reference.

Model No. _____

Serial No. _____

Specifications

	SV120	HV60	HV50	MV15
Power consumption				
Power consumption in operation	20W	18W	18W	16W
in Power save	3W	3W	3W	3W
Playback functions				
Video TV system	PAL	PAL	PAL	PAL
NTSC Playback on PAL TV	X	X	-	-
Record/ Playback time	SP/LP/EP	SP/LP/EP	SP/LP/EP	SP/LP/EP
S-VHS Quasi Playback (SQPB)	-	X	X	X
S-VHS	X	-	-	-
S-VHS ET	X	-	-	-



This equipment complies with European conformity requirements, in accordance with the conditions of electromagnetic compatibility and product safety.



This equipment complies with the requirements of protection class 2.



This equipment complies with the safety requirements of the VDE.
(German Association of Electrical Engineers)



This device complies with the safety requirements of PCBC
(Polish Centre for Testing and Certification)

Matsushita Electric Industrial Co., Ltd.

<http://www.panasonic.co.jp/global/>

Specifications

Power supply	220-240 V AC, 50/60 Hz
Controls	multifunctional remote control (VCR and Panasonic TV) / VCR direct controls (main functions)
Video and Audio heads (helical scanning system)	4 heads (Super Ferrite Head) / 2 heads Hi-Fi
Tape speed	SP: 23.39 mm/s , LP: 11.7 mm/s
Record and playback time (E-240 cassette)	SP: 240 min, LP: 480 min
Fast forward or fast rewind time (E-180 cassette)	approx. 60 s
Video TV Colour system	PAL colour signal
Video input and output level	1.0 V peak-to-peak, 75 Ohm, terminated
RF modulated	UHF channel (21-69), 75 Ohm
Audio Input level	-6 dBV, more than 10 kOhm
Audio Output level	-6 dBV, less than 1 kOhm
Horizontal resolution (colour)	more than 240 lines (VHS, SP), 400 lines (S-VHS/ S-VHS-ET, SP)
Signal-to-noise ratio video (colour)	more than 43 dB (SP)
Signal-to-noise ratio audio	more than 43 dB (SP, normal)
Dynamic range audio	more than 90 dB (Hi-Fi sound tracks)
Audio frequency response	80 Hz to 8 kHz (SP, normal) 20 Hz to 20 kHz (Hi-Fi sound tracks)
Operating temperature / humidity	5°C to 40°C / 35-80% relative humidity
Weight and Dimensions (approximate value)	3.5 kg / 430 (width) x 87 (height) x 282 mm (depth)

*** These specifications are subject to change without notice.**

Index

	Page		Page		Page
3D DNR	6,17	MESECAM	22,29	Tape length	22
AC mains lead protection	2	NICAM	26	Tape remain	5,10
Antenna IN/OUT	7	NTSC	26,29	Tape speed	5,10
AUDIO	5,16	OFF TIMER	5,17	Time	9,28,29
AUDIO output	7	OSD	22	TIMER CHECK	6,13
AV LINK	5	PAL	22,29	TRACKING/V-LOCK	5,28
AV1 OUT	22	Power save	23,28	TV control button	5
AV1(TV)	7	Power supply	7	TV system	22
AV2	22,24	QUICK ERASE	17	VCR display	23
AV2 IN	22	Remote	4,5	VIDEO	22
AV2(DECODER)	7	RF-Coaxial Cable	8	VIDEO output	7
Channel	8,19,24	RFC	23	Voltage	2
Country	9	Satellite Receiver	22,23,25	VOLUME	5
CVC Super	6	Scart Cable	8,10,24,29	VPS/PDC	5,11,12
Date	9,28,29	Screen format	5		
DECODER	22,24	Service	2		
Digital Receiver	23,25	ShowView	5,14		
Erasure protection	10,27,29	Slow playback	4,17		
EXT	22,24	SQPB	22,29		
EXT LINK	5,23,25	Still playback	4,17		
Factory defaults	21	S-VHS ET REC	23		
INDEX	16	S-VHS playback	22		
INTELLIGENT TIMER	15	S-VHS REC	23		
JET SEARCH	4,17	S-VIDEO	22		
		S-VIDEO output	7		

F26B03-0
RQTD0080-Y

Free Manuals Download Website

<http://myh66.com>

<http://usermanuals.us>

<http://www.somanuals.com>

<http://www.4manuals.cc>

<http://www.manual-lib.com>

<http://www.404manual.com>

<http://www.luxmanual.com>

<http://aubethermostatmanual.com>

Golf course search by state

<http://golfingnear.com>

Email search by domain

<http://emailbydomain.com>

Auto manuals search

<http://auto.somanuals.com>

TV manuals search

<http://tv.somanuals.com>