

Wired Remote Controller Installation Manual

SAFETY PRECAUTIONS

- Read the following "SAFETY PRECAUTIONS" carefully before installation.
- Electrical work must be installed by a licensed electrician.
- The caution items stated here must be followed because these important contents are related to safety. The meaning of each indication used is as below. Incorrect installation due to ignoring of the instruction will cause harm or damage, and the seriousness is classified by the following indications.

	WARNING	This indication shows the possibility of causing death or serious injury.
	CAUTION	This indication shows the possibility of causing injury or damage to properties only.

The items to be followed are classified by the symbols:

	Symbol with white background denotes item that is PROHIBITED from doing.
	Symbol with dark background denotes item that must be carried out.

- Carry out test running to confirm that no abnormality occurs after the installation. Then, explain to user the operation, care and maintenance as stated in instructions. Please remind the customer to keep the operating instructions and installation instruction for future reference.

WARNING

- ⊘ Do not modify the length of the remote controller cable. Otherwise, it will cause fire or electrical shock.
- ⚠ Be sure to turn off the main power before installing and connecting the remote controller. Otherwise, it will cause the electrical shock.
- ⚠ Engage authorized dealer or specialist for installation. If installation done by the user is defective, it will cause electrical shock or fire.
- ⚠ Install according to this installation instructions strictly. If installation is defective, it will cause electrical shock or fire.
- ⚠ Use the attached accessories parts and specified parts for installation. Otherwise, it will cause the set to fall, fire or electrical shock.
- ⚠ For electrical work, follow the local national wiring standard, regulation and this installation instruction. Otherwise, it will cause the electrical shock or fire.
- ⚠ Wire routing must be properly arranged so that control board cover is fixed properly. If control board cover is not fixed perfectly, it will cause fire or electrical shock.
- ⚠ If passing the remote controller cable through a wall, be sure to install a water trap above the cable. Otherwise, it will cause the electrical shock.

CAUTION

- ⊘ Do not touch the sharp aluminium fin of air conditioner unit during wired remote controller installation, sharp parts may cause injury.
- ⚠ Install in a flat surface to avoid warping of remote controller, else damage to the LCD case or operation problems may result.
- ⚠ Avoid installing the remote controller cable near refrigerant pipes or drain pipes, else will cause electrical shock or fire.
- ⚠ Install the remote controller cable at least 1 31/32"(5cm) away from electric wires of other appliances to avoid miss operation (electromagnetic noise).
- ⚠ Be sure to use only the accessory screws to avoid damage of remote controller PCB.

ATTACHED ACCESSORIES

No.	Name	Qty	Diagram	Remark
1	Remote controller	1		
2	Remote controller cable	1		Length 32.5ft (9.9m)
3	Screw (M4 machine pitched - 1 3/16" (30mm))	3		Installing the remote controller to an outlet box (embedded cable)
4	Screw (M4 self tapping - 9/16"(14mm))	3		Installing the remote controller to the wall (exposed cable)
5	Remote controller cable holder	1		Holder for remote controller cable at control board
6	Screw (M4 machine screw & washer - 13/32"(10mm))	1		Tighten remote controller cable with holder
7	Screw (M3 self tapping - 5/16"(8mm))	1		Installing the remote controller cable to control board
8	Screw (M4 self tapping - 5/16"(8mm))	1		Installing the green wire to terminal board complete

1. SELECTING THE INSTALLATION LOCATION

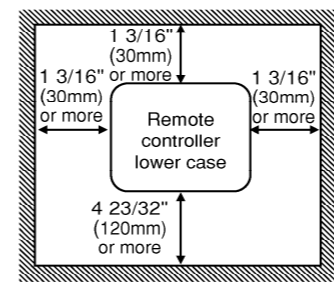
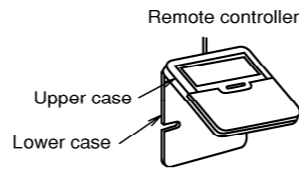

- Allow sufficient space around the remote controller 1 as shown in the illustration above.
- Install in a place which is away from direct sunlight and high humidity.
- Install in a flat surface to avoid warping of the remote controller. If installed to a wall with an uneven surface, damage to the LCD case or operation problems may result.
- Install in a place where the LCD can be easily seen for operation. (Standard height from the floor is 3.9ft to 4.9ft (1.2 to 1.5 meters.))
- Avoid installing the remote controller cable near refrigerant pipes or drain pipes, else it will cause electrical shock or fire.

2. INSTALLING THE REMOTE CONTROLLER UNIT TO THE WALL

1. Remove the remote controller 1 lower case. (Insert a flat-tipped screw driver or similar tool 3/32" to 1/8" (2 to 3 mm) into one of the gaps at the bottom of the case, and twist to open. Refer to the illustration at right.) Be careful not to damage the lower case.
2. Do not remove the protective tape which is affixed to the upper case circuit board when remove the remote controller lower case.
3. Secure the lower case to an outlet box or wall. Refer to (A) or (B) instructions below depending on your choice of cable installation.
4. Be sure to use only the screws provided.
5. Do not over tighten the screws, as it may result in damage to the lower case.

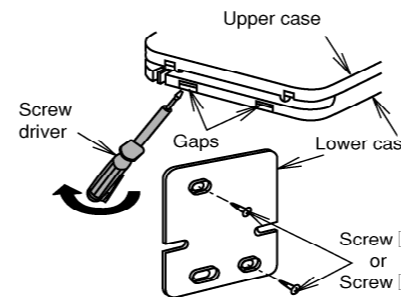

A. IF REMOTE CONTROLLER CABLE IS EMBEDDED

1. Embed an outlet box (JIS C 8336) into the wall. Outlet box may be purchased separately. Medium-sized square outlet box (obtain locally) Part No. DS3744 (Panasonic Co., Ltd.) or equivalent.
2. Secure the remote controller lower case to the outlet box with the two accessory screws 3. Make sure that the lower case is flat against the wall at this time, with no bending.
3. Pass the remote controller cable 2 into the box.
4. Route the remote controller cable 2 inside the lower case through rear feeding-out direction.
5. Insert firmly the connector of remote controller cable 2 to connector (CON1) in the upper case circuit board. [Refer to the illustration at below.]
6. Secure the remote controller upper case to the lower case with the tabs provided.

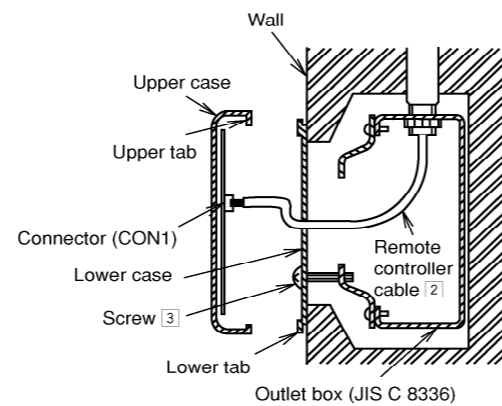

CAUTION

When the wall is hollow, please be sure to use the sleeve for remote controller cable to prevent dangers caused by mice biting the cable.

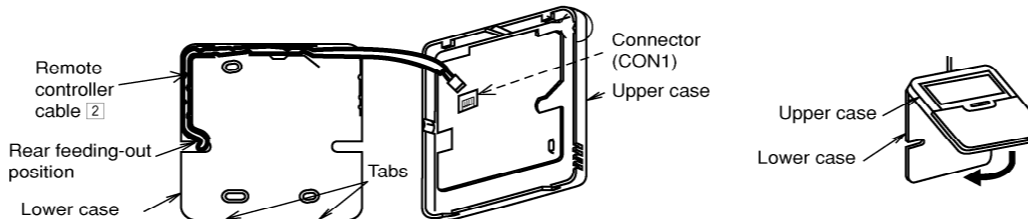

B. IF REMOTE CONTROLLER CABLE IS EXPOSED

1. Install the remote controller lower case to the wall with the two accessory screws 4.
2. Fasten the screws properly until screw head is lower than the rib and reach the base of remote controller lower case to ensure they do not damage the PCB inside the remote controller 1.

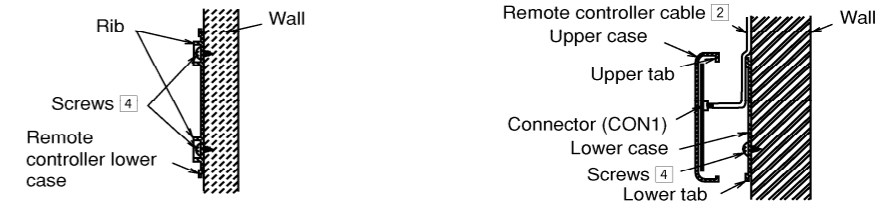

3. The feeding-out direction for the remote controller cable can be either via top, left or right side.
4. Use nipper to cut a notch at the upper case. (Select the intended feeding-out position)
5. Route the remote controller cable 2 inside the lower case in accordance with the intended feeding-out direction. (Refer to the illustration at below)
6. Insert firmly the connector of remote controller cable 2 to connector (CON1) in the upper case circuit board. (Refer to the illustration at below)
7. Secure the remote controller upper case to the lower case with the tabs provided.

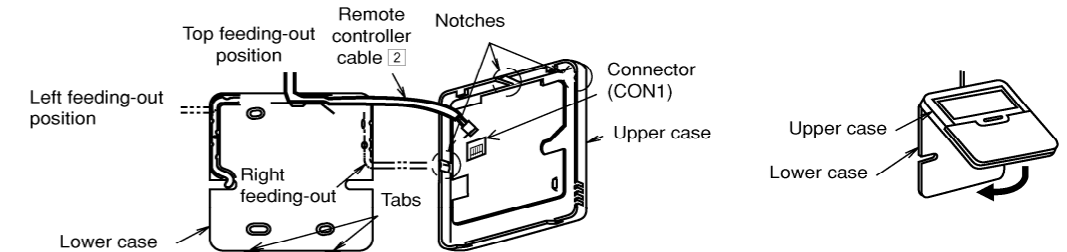

3. CONNECTING THE REMOTE CONTROLLER CABLE TO INDOOR UNIT

CAUTION

Be sure to turn off the main power before installing and connecting the remote controller. Otherwise, it will cause the electrical shock.

1. Open front grille complete (Please refer HOW TO TAKE OUT FRONT GRILLE).
2. Open the control board cover complete and terminal board cover complete.
3. Connect remote controller cable 2 to remote controller 1 and guide the remote controller cable 2 into the unit through the wire insertion hole.
4. Guide the remote controller cable 2 into the remote controller cable holder 5 and tighten with screws 6. Fasten the remote controller cable holder to control board with screw 7.
5. Install back terminal board cover complete. Be careful not to clamp the cable between terminal board cover and control board.
6. Insert firmly the connector of remote controller cable 2 to indoor PCB connector (CN-RMT) and tighten green wire from remote controller cable 2 with screw 8 to the grounding location provided.
7. After complete, install back removed parts follow reverse procedure.

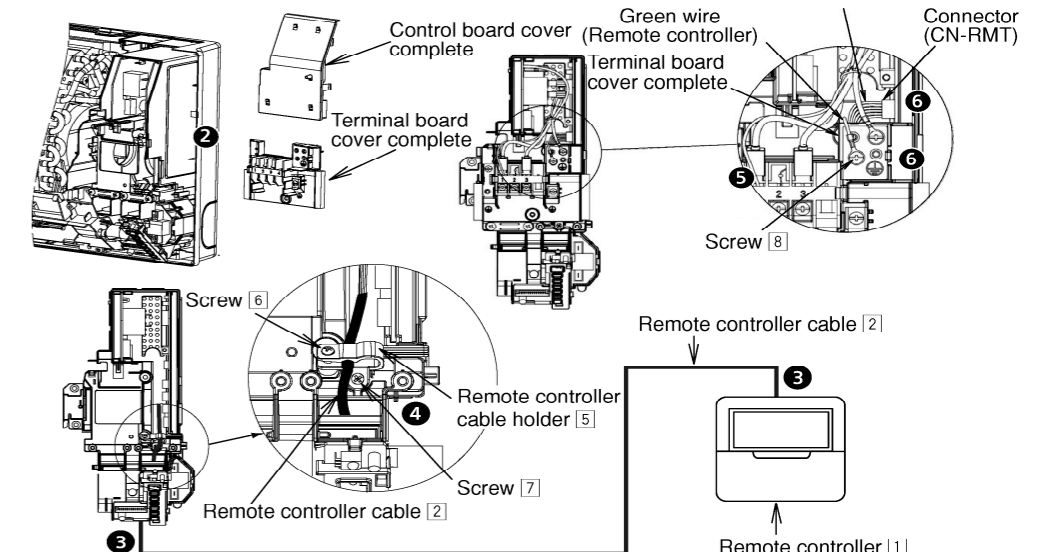
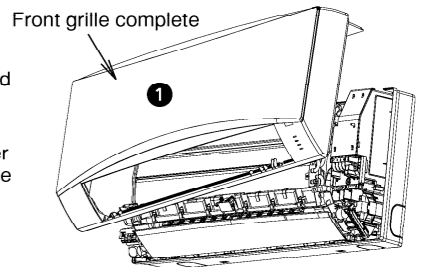

* Make sure remote control cable wire not touching to wire connected to terminal board as shown

Note: Remote controller cable cannot be extended.

Free Manuals Download Website

<http://myh66.com>

<http://usermanuals.us>

<http://www.somanuals.com>

<http://www.4manuals.cc>

<http://www.manual-lib.com>

<http://www.404manual.com>

<http://www.luxmanual.com>

<http://aubethermostatmanual.com>

Golf course search by state

<http://golfingnear.com>

Email search by domain

<http://emailbydomain.com>

Auto manuals search

<http://auto.somanuals.com>

TV manuals search

<http://tv.somanuals.com>