

Panasonic

Industrial Company

Surface Mount Type Aluminum Electrolytic Capacitors



Contents	Page
Product System	4
Quick Guide	5
VS Series	6
HA Series	16
HB Series	23
HC Series	29
HD Series	34
FC Series	40
FK Series	46
TA Series	55
TG Series	60
TK Series	68
EB Series	73
Certified Products by Industry Organization	77
Application Guidelines	78
Packaging Specifications	84
Environmental Management	85
Reflow Profile	86

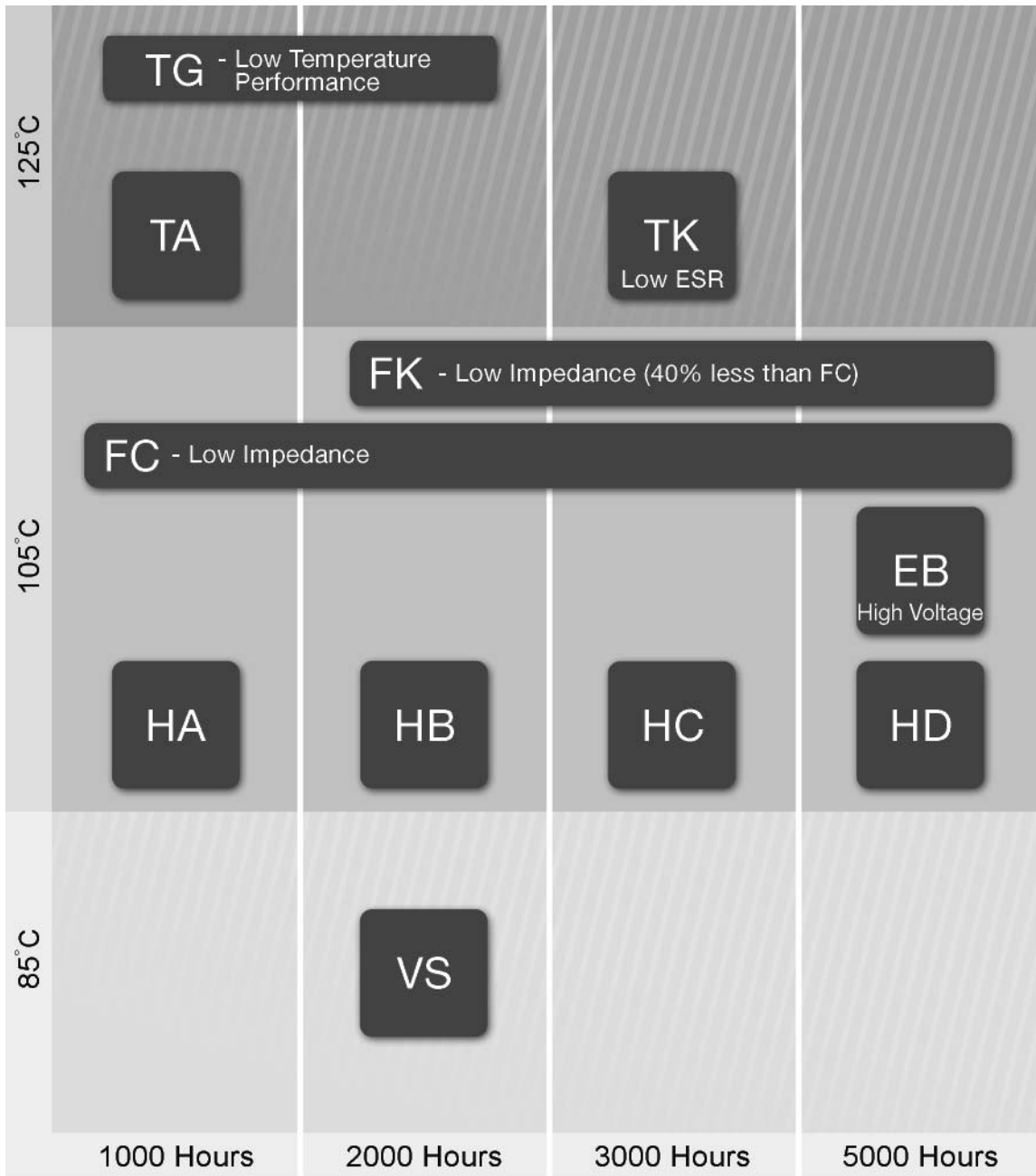

	Series	Part Number	Case Size Dia. x Height (mm)	Temp. Range	W.V. (V) Cap (μ F)	Duration	Features
General Purpose	VS	ECE-VxxS/Axxx EEE-xA/Sxxxxx	ϕ 3 x 5.5 to ϕ 10 x 10.5	-40 ~ +85°C	(4 ~ 100 VDC) 0.1 ~ 1,500 μ F	2000 h / +85°C	<ul style="list-style-type: none"> General purpose, 2,000 hrs @ 85°C Very compact size
Long Life	HA	EEV-HAxxxxx EEE-HAxxxxx	ϕ 4 x 5.5 to ϕ 10 x 10.5	-40 ~ +105°C	(6.3 ~ 100 VDC) 0.1 ~ 1,500 μ F	1000 - 2000 h / +105°C	<ul style="list-style-type: none"> Long life, 1000 to 2,000 hrs. @ 105°C Very compact size
	HB	EEV-HBxxxxx EEE-HBxxxxx	ϕ 4 x 6.1 to ϕ 6.3 x 6.1		(4 ~ 50 VDC) 0.1 ~ 470 μ F	2000 h / +105°C	<ul style="list-style-type: none"> Long life, 2,000 hrs. @ 105°C 6.0 mm height
	HC	EEE-HCxxxxx	ϕ 4 x 6.1 to ϕ 10 x 10.5		(6.3 ~ 50 VDC) 0.1 ~ 1,000 μ F	3000 - 5000 h / +105°C	<ul style="list-style-type: none"> Long life, 3,000 hrs. @ 105°C 5.8 mm height
	HD	EEV-HDxxxxx	ϕ 4 x 6.1 to ϕ 10 x 10.5		(10 ~ 100 VDC) 0.47 ~ 330 μ F	5000 h / +105°C	<ul style="list-style-type: none"> Very long life, 5,000 hrs. @ 105°C Industrial grade
	EB	EEV-EBxxxxx	ϕ 10 x 14.0 to ϕ 18 x 22.0	-25 ~ +105°C	(160 ~ 450 VDC) 2.2 ~ 100 μ F	3000 - 5000 h / +105°C	<ul style="list-style-type: none"> Low impedance, 3,000 to 5,000 hrs. @ 105°C Large can, 10 ~ 18 mm (Dia.)
Automotive Applications 125°C	TA	EEV-TAxxxxx	ϕ 8 x 6.5 to ϕ 10 x 10.5	-40 ~ +125°C	(10 ~ 50 VDC) 10 ~ 330 μ F	1000 h / +125°C	<ul style="list-style-type: none"> High temperature, 1,000 hrs. @ 125°C Automotive applications
	TG	EEV-TGxxxxx EEE-TGxxxxx	ϕ 8 x 6.5 to ϕ 18 x 17.0		(10 ~ 100 VDC) 10 ~ 4,700 μ F	1000 - 2000 h / +125°C	<ul style="list-style-type: none"> High temperature, 2,000 hrs. @ 125°C Compact Size
	TK	EEV-TKxxxxx EEE-TKxxxxx	ϕ 8 x 10.5 to ϕ 10 x 10.5		(10 ~ 35 VDC) 47 ~ 470 μ F	3000 h / +125°C	<ul style="list-style-type: none"> High temperature, 3,000 hrs. @ 125°C Low ESR
Low Impedance	FC	EEV-FCxxxxx EEE-FCxxxxx	ϕ 4 x 5.5 to ϕ 10 x 10.3	-40 ~ +105°C	(6.3 ~ 50 VDC) 1 ~ 1,500 μ F	1000 h / +105°C	<ul style="list-style-type: none"> 1,000 hrs. @ 105°C Low impedance
	FK	EEV-FKxxxxx EEE-FKxxxxx	ϕ 4 x 6.1 to ϕ 18 x 17.0	-55 ~ +105°C	(6.3 ~ 100 VDC) 3.3 ~ 6,800 μ F	2000 - 5000 h / +105°C	<ul style="list-style-type: none"> Long life, 2,000 to 5,000 hrs. @ 105°C Low ESR, Tantalum replacement Compact & wide size range, 4 ~ 18 mm (Dia.)

	Series	Part Number	Case Size Dia. x Height (mm)	Temp. Range	W.V. (V) Cap (μ F)	Duration	Features
Bi-Polar	VS-BP	ECE-VxxAxxxN EEE-VxxAxxxN	ϕ 4 x 5.5 to ϕ 6.3 x 5.5	-40 ~ +85°C	6.3 ~ 50 VDC 0.22 ~ 47 μ F	1000 h / +85°C	<ul style="list-style-type: none"> General Purpose 5.5mm max. in height
	HB-BP	EEV-HPxxxxx EEE-HPxxxxx	ϕ 4 x 6.1 to ϕ 6.3 x 6.1	-40 ~ +105°C		2000 h / +105°C	<ul style="list-style-type: none"> Industrial Grade 6.1mm max. in height



Surface Mount Type

Series: S Type : V

- Features Endurance: 85°C 2000 h
5.4 mm (≤φ6.3) height, RoHS directive compliant (Parts No:EEE*)

■ Specifications

Category temp. range	-40 to +85°C										
Rated W.V. Range	4 to 100 V .DC										
Nominal Cap. Range	0.1 to 1500 μF										
Capacitance Tolerance	±20 % (120Hz/+20°C)										
DC Leakage Current	I ≤ 0.01 CV or 3(μA) after 2 minutes (Bi-Polar I ≤ 0.02 CV or 6 (μA)) (Whichever is greater)										
tan δ	Please see the attached standard products list										
Characteristics at Low Temperature	W.V. (V)	4	6.3	10	16	25	35	50	63	100	(Impedance ratio at 120 Hz)
	-25 / +20 °C	7	4	3	2	2	2	2	3	3	
	-40 / +20 °C	15	8	6	4	4	3	3	4	4	
Endurance	After applying rated working voltage for 2000 hours at +85±2°C and then being stabilized at +20°C, capacitors shall meet the following limits.										
	Capacitance change : ±20% of initial measured value										
	Size code	Rated W.V.	Cap. change		tan δ		≤200% of initial specified value				
	A(φ3)		4 to 50W.V.	±30%	Initial measured value for 1000 hours	DC leakage current					
A(φ3) to D8(φ6.3)		4 W.V.									
		6.3 W.V.									
≤ D(φ6.3)Miniature		≥ 10 W.V.	±20%								
Shelf Life	After storage for 1000 hours at +85±2°C with no voltage applied and then being stabilized at +20°C, capacitors shall meet the limits specified in Endurance. (With voltage treatment)										
Resistance to Soldering Heat	After reflow soldering (Refer to page 86 for recommended temperature profile) and then being stabilized at +20°C, capacitor shall meet the following limits.										
	Capacitance change		±10% of initial measured value								
	tan δ		≤ initial specified value								
	DC leakage current		≤ initial specified value								

■ Marking

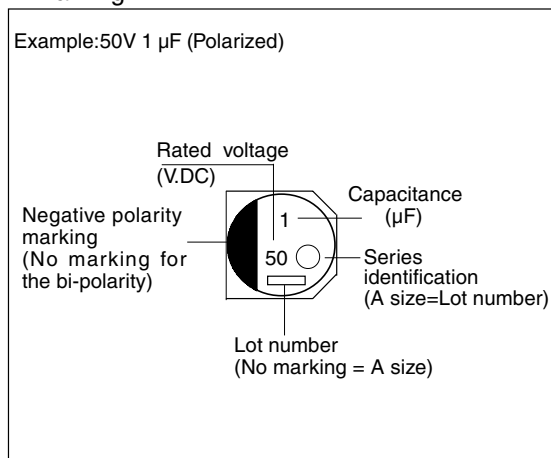

■ Dimensions in mm (not to scale)

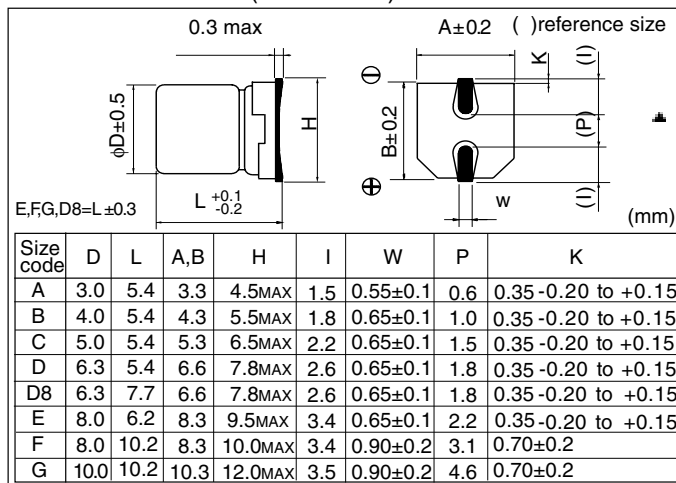

■ Case size

W.V.(V)	4 (0G)	6.3 (0J)	10 (1A)	16 (1C)	25 (1E)	35 (1V)	50 (1H)	63 (1J)	100 (2A)
Cap.(μF)	Polar-ized	Polar-ized	Bi-polar	Polar-ized	Bi-polar	Polar-ized	Bi-polar	Polar-ized	Bi-polar
0.1							A,B		
0.22							A,B	B	
0.33							A,B	B	
0.47							A,B	B	
1.0							A,B	B	
2.2						A	A,B	C	
3.3					B	A	B	C	E
4.7					B	A,B	C	D	F(E)
10					C	C(B)	D	D(C)	F(E)
22	A	B(A)	C	(B)	B	C(B)	D	D(C)	G(F)
33	B	(B)		C(B)	D	(C)	D	D(C)	
47	B	C(B)	D	(C)	D	D(C)	E(D)	F(E),D8	G
100	C	D(C)		D(C)	E(D)	F(E),D8	G(F),D8	G(F)	
220	D	(D)		E,D8	F,D8	G(F)	G(F)	G	
330	(D)	E,D8		F	G(F)	G(F)	G		
470	D8	F		G(F)	G(F)				
1000		G(F)		G					
1500		G							

■ Standard Products

W.V. (V)	Cap. (±20%) (μF)	Case size			Specification			Part No. (RoHS: not compliant)	Reflow	Part No. (RoHS: compliant)	Reflow	Min. Packaging Q'ty Taping (pcs)
		Dia. (mm)	Length (mm)	Size Code	Ripple Current (120Hz) (+85°C) (mA)	tan δ (120Hz) (+20°C)	Endur- ance (hours)					
4	22	3	5.4	A	19	0.37	1000	ECEV0GS220SR	(1)	EEE0GS220SR	(4)	2000
	33	4	5.4	B	26	0.35	1000	ECEV0GA330SR	(1)	EEE0GA330SR	(4)	2000
	47	4	5.4	B	34	0.35	1000	ECEV0GA470SR	(1)	EEE0GA470SR	(4)	2000
	100	5	5.4	C	61	0.35	1000	ECEV0GA101SR	(1)	EEE0GA101SR	(4)	1000
	220	6.3	5.4	D	82	0.35	1000	ECEV0GA221SP	(1)	EEE0GA221SP	(4)	1000
	330	6.3	5.4	D	80	0.50	1000	ECEV0GA331WP	(1)	EEE0GA331WP	(4)	1000
	470	6.3	7.7	D8	200	0.35	2000	ECEV0GA471XP	(1)	EEE0GA471XP	(4)	900
6.3	22	3	5.4	A	20	0.35	1000	ECEV0JS220WR	(1)	EEE0JS220WR	(4)	2000
		4	5.4	B	29	0.26	2000	ECEV0JA220SR	(1)	EEE0JA220SR	(4)	2000
	33	4	5.4	B	22	0.35	1000	ECEV0JA330WR	(1)	EEE0JA330WR	(4)	2000
		4	5.4	B	36	0.35	1000	ECEV0JA470WR	(1)	EEE0JA470WR	(4)	2000
	47	5	5.4	C	46	0.26	2000	ECEV0JA470SR	(1)	EEE0JA470SR	(4)	1000
		5	5.4	C	47	0.35	1000	ECEV0JA101WR	(1)	EEE0JA101WR	(4)	1000
	100	6.3	5.4	D	71	0.26	2000	ECEV0JA101SP	(1)	EEE0JA101SP	(4)	1000
		6.3	5.4	D	74	0.35	1000	ECEV0JA221WP	(1)	EEE0JA221WP	(4)	1000
	330	6.3	7.7	D8	188	0.26	2000	ECEV0JA331XP	(1)	EEE0JA331XP	(4)	900
		8	6.2	E	300	0.35	2000	ECEV0JA331P	(2)	EEE0JA331P	(5)	1000
	470	8	10.2	F	380	0.35	2000	ECEV0JA471P	(2)	EEE0JA471P	(5)	500
1000	8	10.2	F	500	0.35	2000	ECEV0JA102UP	(2)	EEE0JA102UP	(5)	500	
	10	10.2	G	700	0.35	2000	ECEV0JA102P	(2)	EEE0JA102P	(5)	500	
10	22	4	5.4	B	28	0.30	1000	ECEV1AA220WR	(1)	EEE1AA220WR	(4)	2000
		4	5.4	B	29	0.30	1000	ECEV1AA330WR	(1)	EEE1AA330WR	(4)	2000
	33	5	5.4	C	43	0.20	2000	ECEV1AA330SR	(1)	EEE1AA330SR	(4)	1000
		5	5.4	C	47	0.30	1000	ECEV1AA470WR	(1)	EEE1AA470WR	(4)	1000
	100	5	5.4	C	50	0.30	1000	ECEV1AA101WR	(1)	EEE1AA101WR	(4)	1000
		6.3	5.4	D	70	0.26	2000	ECEV1AA101SP	(1)	EEE1AA101SP	(4)	1000
	220	6.3	7.7	D8	173	0.20	2000	ECEV1AA221XP	(1)	EEE1AA221XP	(4)	900
		8	6.2	E	250	0.26	2000	ECEV1AA221P	(2)	EEE1AA221P	(5)	1000
	330	8	10.2	F	390	0.26	2000	ECEV1AA331P	(2)	EEE1AA331P	(5)	500
	470	8	10.2	F	390	0.26	2000	ECEV1AA471UP	(2)	EEE1AA471UP	(5)	500
10		10.2	G	400	0.26	2000	ECEV1AA471P	(2)	EEE1AA471P	(5)	500	
1000	10	10.2	G	580	0.26	2000	ECEV1AA102P	(2)	EEE1AA102P	(5)	500	
16	10	3	5.4	A	20	0.18	1000	ECEV1CS100SR	(1)	EEE1CS100SR	(4)	2000
		4	5.4	B	28	0.16	2000	ECEV1CA100SR	(1)	EEE1CA100SR	(4)	2000
	22	4	5.4	B	28	0.26	1000	ECEV1CA220WR	(1)	EEE1CA220WR	(4)	2000
		5	5.4	C	39	0.16	2000	ECEV1CA220SR	(1)	EEE1CA220SR	(4)	1000
	33	5	5.4	C	35	0.26	1000	ECEV1CA330WR	(1)	EEE1CA330WR	(4)	1000
		5	5.4	C	39	0.26	1000	ECEV1CA470WR	(1)	EEE1CA470WR	(4)	1000
	47	6.3	5.4	D	70	0.16	2000	ECEV1CA470SP	(1)	EEE1CA470SP	(4)	1000
		6.3	5.4	D	70	0.26	1000	ECEV1CA101WP	(1)	EEE1CA101WP	(4)	1000
	100	8	6.2	E	200	0.20	2000	ECEV1CA101P	(2)	EEE1CA101P	(5)	1000
		6.3	7.7	D8	162	0.16	2000	ECEV1CA221XP	(1)	EEE1CA221XP	(4)	900
220	8	10.2	F	280	0.20	2000	ECEV1CA221P	(2)	EEE1CA221P	(5)	500	

An explanation of the taping dimensions can be found on page 84.

Reflow profiles can be found on page 86.

Standard Products

W.V. (V)	Cap. (±20%) (μF)	Case size			Specification			Part No. (RoHS: not compliant)	Reflow	Part No. (RoHS: compliant)	Reflow	Min. Packaging Q'ty Taping (pcs)
		Dia. (mm)	Length (mm)	Size Code	Ripple Current (120Hz) (+85°C) (mA)	tan δ (120Hz) (+20°C)	Endur- ance (hours)					
16	330	8	10.2	F	320	0.20	2000	ECEV1CA331UP	(2)	EEE1CA331UP	(5)	500
		10	10.2	G	380	0.20	2000	ECEV1CA331P	(2)	EEE1CA331P	(5)	500
	470	8	10.2	F	350	0.20	2000	ECEV1CA471UP	(2)	EEE1CA471UP	(5)	500
		10	10.2	G	420	0.20	2000	ECEV1CA471P	(2)	EEE1CA471P	(5)	500
25	4.7	3	5.4	A	12	0.16	1000	ECEV1ES4R7SR	(1)	EEE1ES4R7SR	(4)	2000
		4	5.4	B	22	0.14	2000	ECEV1EA4R7SR	(1)	EEE1EA4R7SR	(4)	2000
	10	4	5.4	B	22	0.20	1000	ECEV1EA100WR	(1)	EEE1EA100WR	(4)	2000
		5	5.4	C	28	0.14	2000	ECEV1EA100SR	(1)	EEE1EA100SR	(4)	1000
	22	5	5.4	C	35	0.20	1000	ECEV1EA220WR	(1)	EEE1EA220WR	(4)	1000
		6.3	5.4	D	55	0.14	2000	ECEV1EA220SP	(1)	EEE1EA220SP	(4)	1000
	33	5	5.4	C	42	0.20	1000	ECEV1EA330WR	(1)	EEE1EA330WR	(4)	1000
		6.3	5.4	D	65	0.14	2000	ECEV1EA330SP	(1)	EEE1EA330SP	(4)	1000
	47	6.3	5.4	D	70	0.20	1000	ECEV1EA470WP	(1)	EEE1EA470WP	(4)	1000
	100	6.3	7.7	D8	143	0.14	2000	ECEV1EA101XP	(1)	EEE1EA101XP	(4)	900
		8	6.2	E	91	0.16	2000	ECEV1EA101UP	(2)	EEE1EA101UP	(5)	1000
		8	10.2	F	180	0.16	2000	ECEV1EA101P	(2)	EEE1EA101P	(5)	500
	220	8	10.2	F	230	0.16	2000	ECEV1EA221UP	(2)	EEE1EA221UP	(5)	500
		10	10.2	G	310	0.16	2000	ECEV1EA221P	(2)	EEE1EA221P	(5)	500
	330	8	10.2	F	270	0.16	2000	ECEV1EA331UP	(2)	EEE1EA331UP	(5)	500
		10	10.2	G	340	0.16	2000	ECEV1EA331P	(2)	EEE1EA331P	(5)	500
	470	10	10.2	G	380	0.16	2000	ECEV1EA471P	(2)	EEE1EA471P	(5)	500
	35	2.2	3	5.4	A	8	0.14	1000	ECEV1VS2R2SR	(1)	EEE1VS2R2SR	(4)
3.3		3	5.4	A	10	0.14	1000	ECEV1VS3R3SR	(1)	EEE1VS3R3SR	(4)	2000
4.7		4	5.4	B	22	0.12	2000	ECEV1VA4R7SR	(1)	EEE1VA4R7SR	(4)	2000
10		4	5.4	B	22	0.16	1000	ECEV1VA100WR	(1)	EEE1VA100WR	(4)	2000
		5	5.4	C	30	0.12	2000	ECEV1VA100SR	(1)	EEE1VA100SR	(4)	1000
22		5	5.4	C	36	0.16	1000	ECEV1VA220WR	(1)	EEE1VA220WR	(4)	1000
		6.3	5.4	D	60	0.12	2000	ECEV1VA220SP	(1)	EEE1VA220SP	(4)	1000
33		6.3	5.4	D	60	0.16	1000	ECEV1VA330WP	(1)	EEE1VA330WP	(4)	1000
		8	6.2	E	130	0.14	2000	ECEV1VA330P	(2)	EEE1VA330P	(5)	1000
47		6.3	5.4	D	70	0.16	1000	ECEV1VA470WP	(1)	EEE1VA470WP	(4)	1000
		8	6.2	E	165	0.14	2000	ECEV1VA470P	(2)	EEE1VA470P	(5)	1000
100		6.3	7.7	D8	132	0.12	2000	ECEV1VA101XP	(1)	EEE1VA101XP	(4)	900
		8	10.2	F	140	0.14	2000	ECEV1VA101UP	(2)	EEE1VA101UP	(5)	500
		10	10.2	G	210	0.14	2000	ECEV1VA101P	(2)	EEE1VA101P	(5)	500
220		8	10.2	F	200	0.14	2000	ECEV1VA221UP	(2)	EEE1VA221UP	(5)	500
		10	10.2	G	310	0.14	2000	ECEV1VA221P	(2)	EEE1VA221P	(5)	500
330		10	10.2	G	350	0.14	2000	ECEV1VA331P	(2)	EEE1VA331P	(5)	500
50		0.1	3	5.4	A	1	0.14	1000	ECEV1HS0R1SR	(1)	EEE1HS0R1SR	(4)
	4		5.4	B	1	0.12	2000	ECEV1HA0R1SR	(1)	EEE1HA0R1SR	(4)	2000
	0.22	3	5.4	A	2	0.14	1000	ECEV1HSR22SR	(1)	EEE1HSR22SR	(4)	2000
		4	5.4	B	2	0.12	2000	ECEV1HAR22SR	(1)	EEE1HAR22SR	(4)	2000
	0.33	3	5.4	A	3	0.14	1000	ECEV1HSR33SR	(1)	EEE1HSR33SR	(4)	2000
		4	5.4	B	3	0.12	2000	ECEV1HAR33SR	(1)	EEE1HAR33SR	(4)	2000

An explanation of the taping dimensions can be found on page 84.

Reflow profiles can be found on page 86.

■ Standard Products

W.V. (V)	Cap. (±20%) (μF)	Case size			Specification			Part No. (RoHS: not compliant)		Part No. (RoHS: compliant)		Min. Packaging Q'ty Taping (pcs)
		Dia. (mm)	Length (mm)	Size Code	Ripple Current (120Hz) (+85°C) (mA)	tan δ (120Hz) (+20°C)	Endur- ance (hours)		Reflow		Reflow	
50	0.47	3	5.4	A	5	0.14	1000	ECEV1HSR47SR	(1)	EEE1HSR47SR	(4)	2000
		4	5.4	B	5	0.12	2000	ECEV1HAR47SR	(1)	EEE1HAR47SR	(4)	2000
	1	3	5.4	A	8	0.14	1000	ECEV1HS010SR	(1)	EEE1HS010SR	(4)	2000
		4	5.4	B	10	0.12	2000	ECEV1HA010SR	(1)	EEE1HA010SR	(4)	2000
	2.2	3	5.4	A	10	0.14	1000	ECEV1HS2R2SR	(1)	EEE1HS2R2SR	(4)	2000
		4	5.4	B	16	0.12	2000	ECEV1HA2R2SR	(1)	EEE1HA2R2SR	(4)	2000
	3.3	4	5.4	B	16	0.12	2000	ECEV1HA3R3SR	(1)	EEE1HA3R3SR	(4)	2000
	4.7	4	5.4	B	18	0.14	1000	ECEV1HA4R7WR	(1)	EEE1HA4R7WR	(4)	2000
		5	5.4	C	23	0.12	2000	ECEV1HA4R7SR	(1)	EEE1HA4R7SR	(4)	1000
	10	5	5.4	C	27	0.14	1000	ECEV1HA100WR	(1)	EEE1HA100WR	(4)	1000
		6.3	5.4	D	35	0.12	2000	ECEV1HA100SP	(1)	EEE1HA100SP	(4)	1000
	22	6.3	5.4	D	40	0.14	1000	ECEV1HA220WP	(1)	EEE1HA220WP	(4)	1000
		8	6.2	E	120	0.12	2000	ECEV1HA220P	(2)	EEE1HA220P	(5)	1000
	33	6.3	7.7	D8	65	0.12	2000	ECEV1HA330XP	(1)	EEE1HA330XP	(4)	900
		8	6.2	E	65	0.12	2000	ECEV1HA330UP	(2)	EEE1HA330UP	(5)	1000
		8	10.2	F	110	0.12	2000	ECEV1HA330P	(2)	EEE1HA330P	(5)	500
	47	6.3	7.7	D8	105	0.12	2000	ECEV1HA470XP	(1)	EEE1HA470XP	(4)	900
		8	10.2	F	110	0.12	2000	ECEV1HA470UP	(2)	EEE1HA470UP	(5)	500
		10	10.2	G	130	0.12	2000	ECEV1HA470P	(2)	EEE1HA470P	(5)	500
	100	8	10.2	F	200	0.12	2000	ECEV1HA101UP	(2)	EEE1HA101UP	(5)	500
10		10.2	G	250	0.12	2000	ECEV1HA101P	(2)	EEE1HA101P	(5)	500	
220	10	10.2	G	300	0.12	2000	ECEV1HA221P	(2)	EEE1HA221P	(5)	500	
63	22	8	6.2	E	35	0.18	2000	ECEV1JA220UP	(2)	EEE1JA220UP	(5)	1000
		8	10.2	F	40	0.18	2000	ECEV1JA220P	(2)	EEE1JA220P	(5)	500
	33	8	10.2	F	45	0.18	2000	ECEV1JA330P	(2)	EEE1JA330P	(5)	500
	47	8	10.2	F	45	0.18	2000	ECEV1JA470UP	(2)	EEE1JA470UP	(5)	500
		10	10.2	G	50	0.18	2000	ECEV1JA470P	(2)	EEE1JA470P	(5)	500
100	10	10.2	G	60	0.18	2000	ECEV1JA101P	(2)	EEE1JA101P	(5)	500	
100	3.3	8	6.2	E	50	0.18	2000	ECEV2AA3R3P	(2)	EEE2AA3R3P	(5)	1000
		8	6.2	E	50	0.18	2000	ECEV2AA4R7UP	(2)	EEE2AA4R7UP	(5)	1000
	4.7	8	10.2	F	80	0.18	2000	ECEV2AA4R7P	(2)	EEE2AA4R7P	(5)	500
		8	6.2	E	50	0.18	2000	ECEV2AA100UP	(2)	EEE2AA100UP	(5)	1000
	10	8	10.2	F	85	0.18	2000	ECEV2AA100P	(2)	EEE2AA100P	(5)	500
		8	10.2	F	70	0.18	2000	ECEV2AA220UP	(2)	EEE2AA220UP	(5)	500
	22	10	10.2	G	85	0.18	2000	ECEV2AA220P	(2)	EEE2AA220P	(5)	500
		33	10	10.2	G	90	0.18	2000	ECEV2AA330P	(2)	EEE2AA330P	(5)

An explanation of the taping dimensions can be found on page 84.

Reflow profiles can be found on page 86.

■ Standard Products(Bi-polar)

W.V. (V)	Cap. (±20%) (μF)	Case size			Specification			Part No. (RoHS: not compliant)	Reflow	Part No. (RoHS: compliant)	Reflow	Min. Packaging Q'ty Taping (pcs)
		Dia. (mm)	Length (mm)	Size Code	Ripple Current (120Hz) (+85°C) (mA)	tan δ (120Hz) (+20°C)	Endur- ance (hours)					
6.3	22	5	5.4	C	29	0.52	2000	ECEV0JA220NR	(1)	EEE0JA220NR	(4)	1000
	47	6.3	5.4	D	46	0.52	2000	ECEV0JA470NP	(1)	EEE0JA470NP	(4)	1000
10	10	4	5.4	B	25	0.40	2000	ECEV1AA100NR	(1)	EEE1AA100NR	(4)	2000
	33	6.3	5.4	D	43	0.40	2000	ECEV1AA330NP	(1)	EEE1AA330NP	(4)	1000
16	4.7	4	5.4	B	20	0.32	2000	ECEV1CA4R7NR	(1)	EEE1CA4R7NR	(4)	2000
	10	5	5.4	C	25	0.32	2000	ECEV1CA100NR	(1)	EEE1CA100NR	(4)	1000
	22	6.3	5.4	D	39	0.32	2000	ECEV1CA220NP	(1)	EEE1CA220NP	(4)	1000
25	3.3	4.0	5.4	B	12	0.28	2000	ECEV1EA3R3NR	(1)	EEE1EA3R3NR	(4)	2000
	4.7	5	5.4	C	21	0.28	2000	ECEV1EA4R7NR	(1)	EEE1EA4R7NR	(4)	1000
	10	6.3	5.4	D	28	0.28	2000	ECEV1EA100NP	(1)	EEE1EA100NP	(4)	1000
35	2.2	4	5.4	B	12	0.24	2000	ECEV1VA2R2NR	(1)	EEE1VA2R2NR	(4)	2000
	4.7	5	5.4	C	22	0.24	2000	ECEV1VA4R7NR	(1)	EEE1VA4R7NR	(4)	1000
	10	6.3	5.4	D	30	0.24	2000	ECEV1VA100NP	(1)	EEE1VA100NP	(4)	1000
50	0.22	4	5.4	B	2	0.24	2000	ECEV1HAR22NR	(1)	EEE1HAR22NR	(4)	2000
	0.33	4	5.4	B	3	0.24	2000	ECEV1HAR33NR	(1)	EEE1HAR33NR	(4)	2000
	0.47	4	5.4	B	5	0.24	2000	ECEV1HAR47NR	(1)	EEE1HAR47NR	(4)	2000
	1	4	5.4	B	10	0.24	2000	ECEV1HA010NR	(1)	EEE1HA010NR	(4)	2000
	2.2	5	5.4	C	16	0.24	2000	ECEV1HA2R2NR	(1)	EEE1HA2R2NR	(4)	1000
	3.3	5	5.4	C	21	0.24	2000	ECEV1HA3R3NR	(1)	EEE1HA3R3NR	(4)	1000
	4.7	6.3	5.4	D	31	0.24	2000	ECEV1HA4R7NP	(1)	EEE1HA4R7NP	(4)	1000

An explanation of the taping dimensions can be found on page 84.

Reflow profiles can be found on page 86.

■ Frequency Correction Factor of Rated Ripple Current

	Frequency (Hz)			
	50,60	120	1k	10k~
coefficient	0.70	1.0	1.3	1.7

■ Endurance

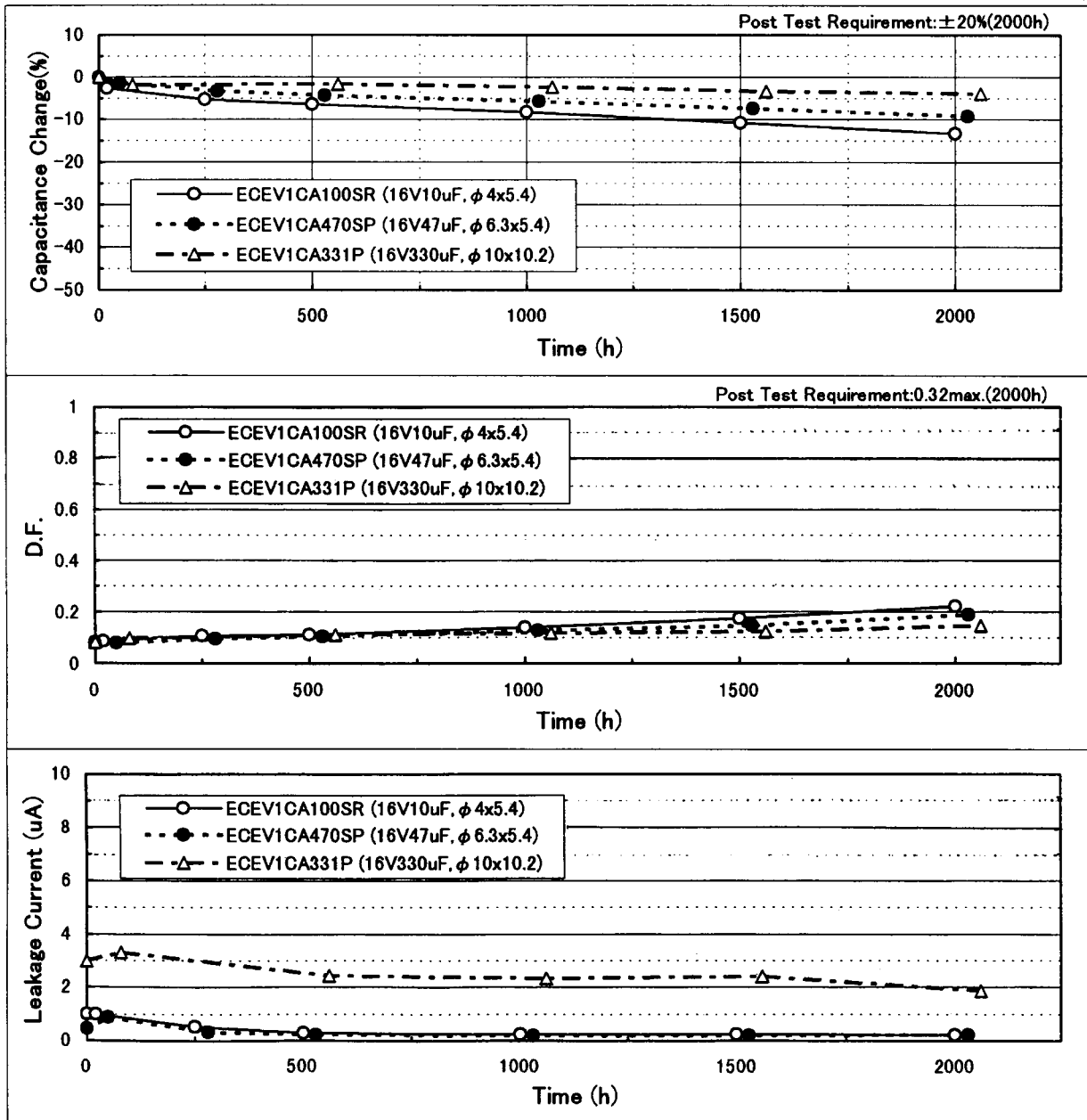

■ Frequency Characteristics

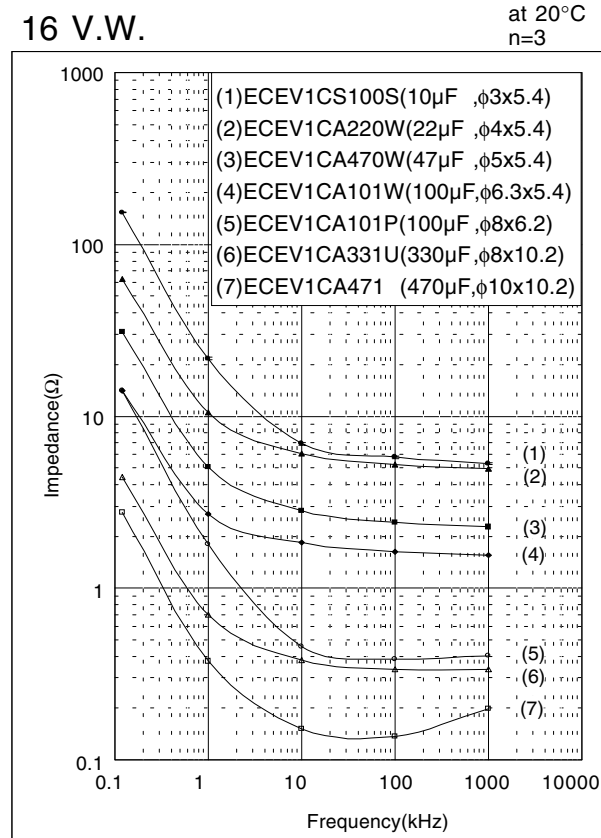
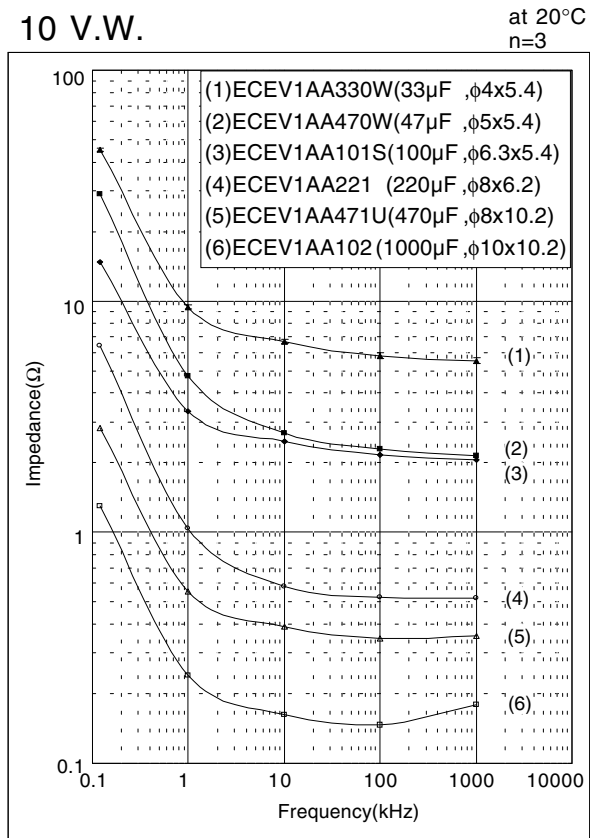
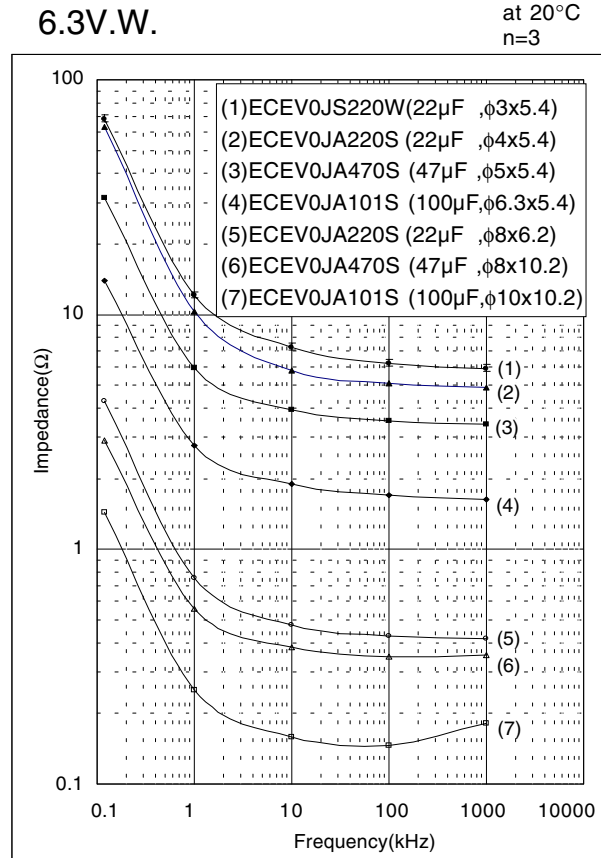
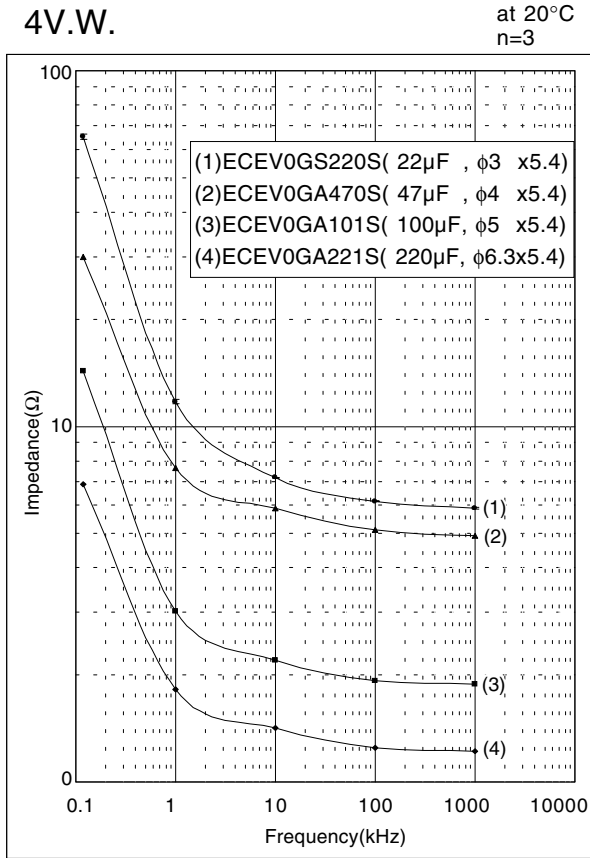

35 V.W.

at 20°C
n=3

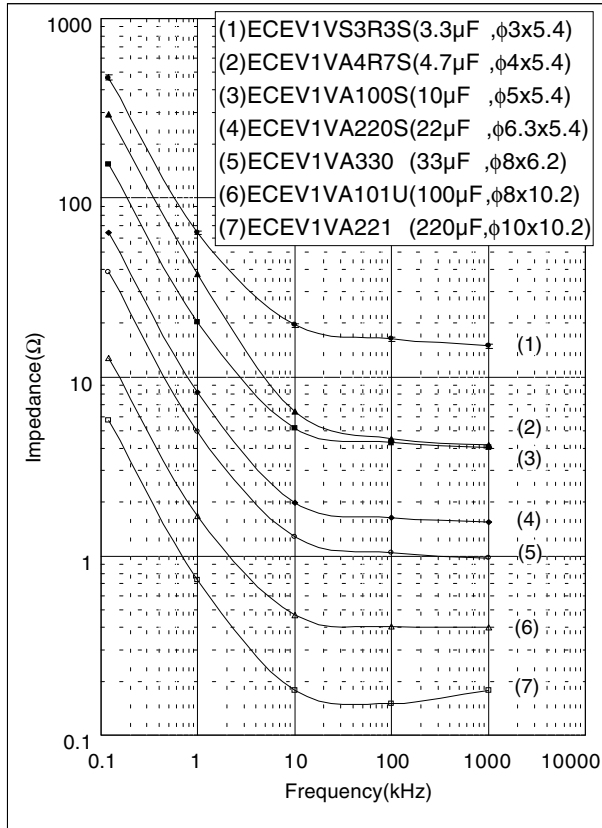

Temperature Characteristics

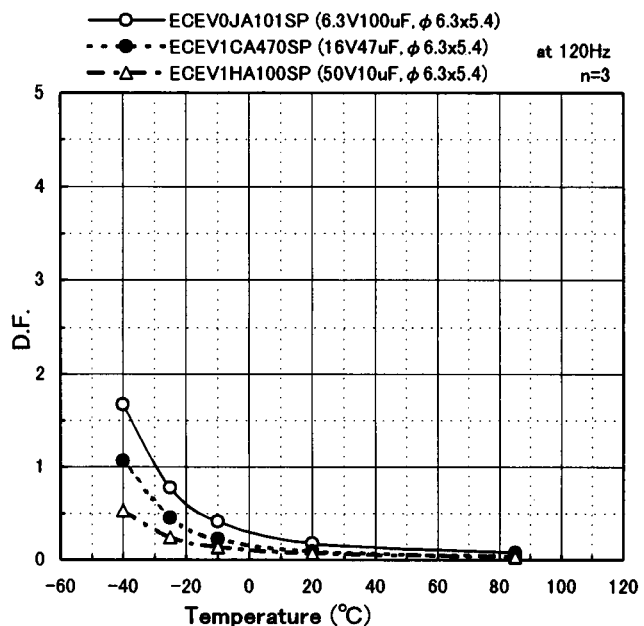
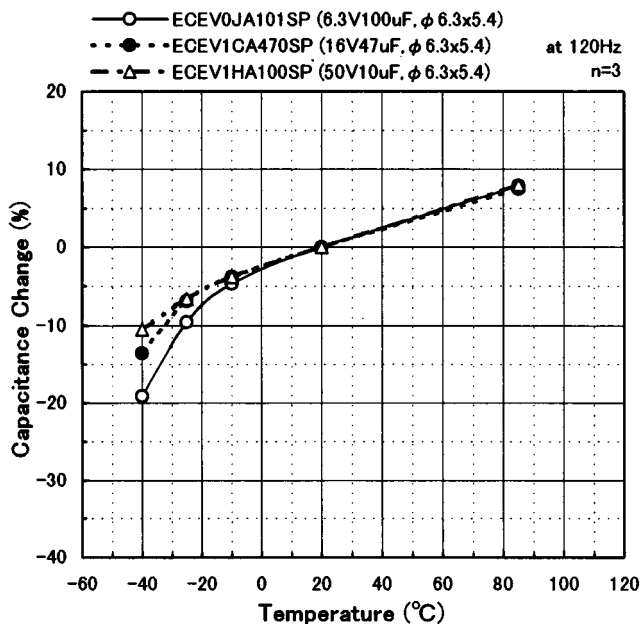

Temperature Characteristics

Parts No.; ECEV1VA100SR(35V 10 μ F)
(ϕ 5 X 5.4)

n=3

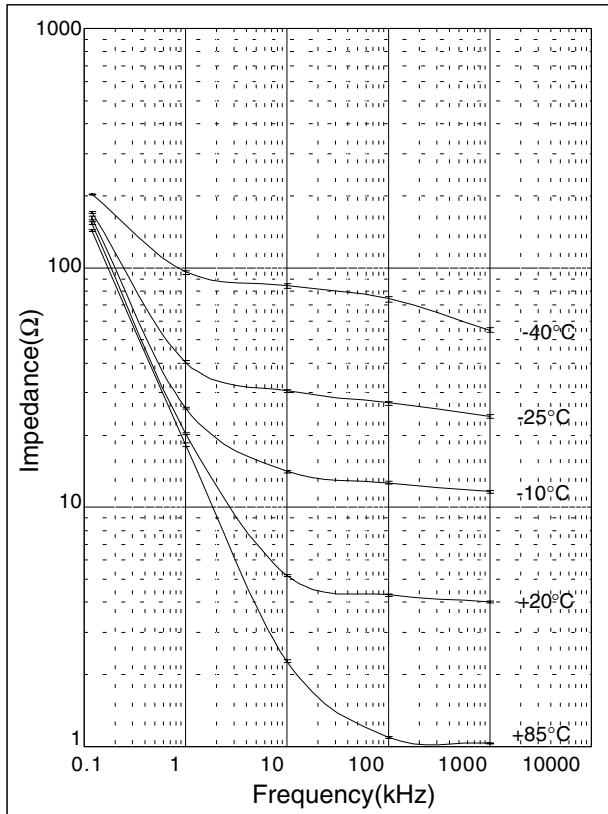

Parts No.; ECEV1VA220SP(35V 22 μ F)
(ϕ 6.3 X 5.4)

n=3

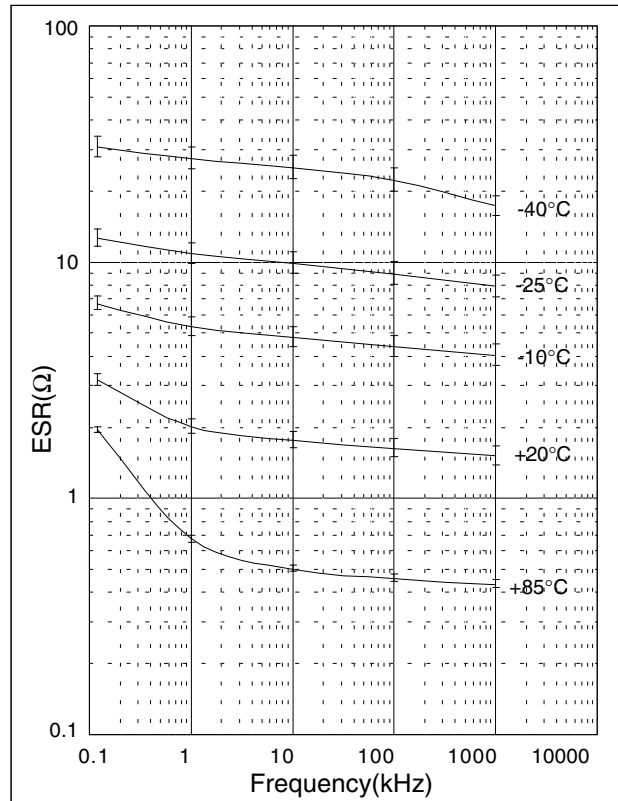
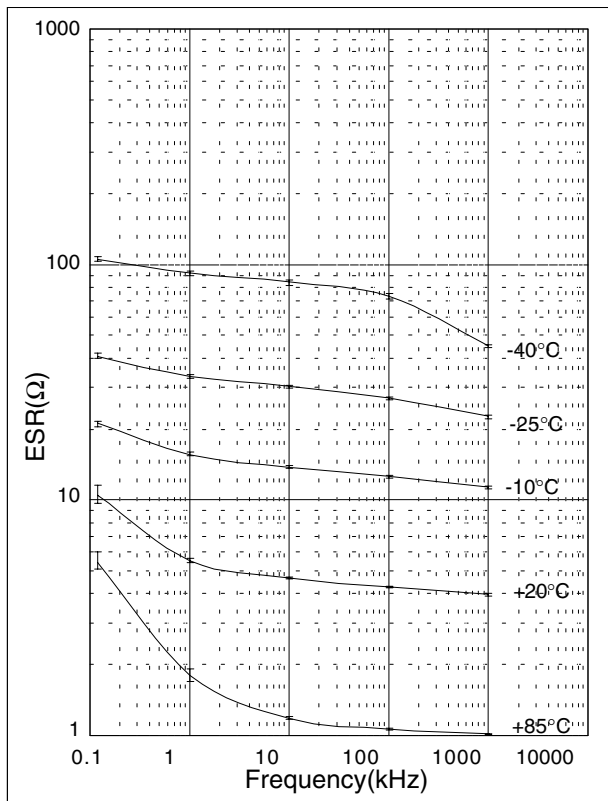
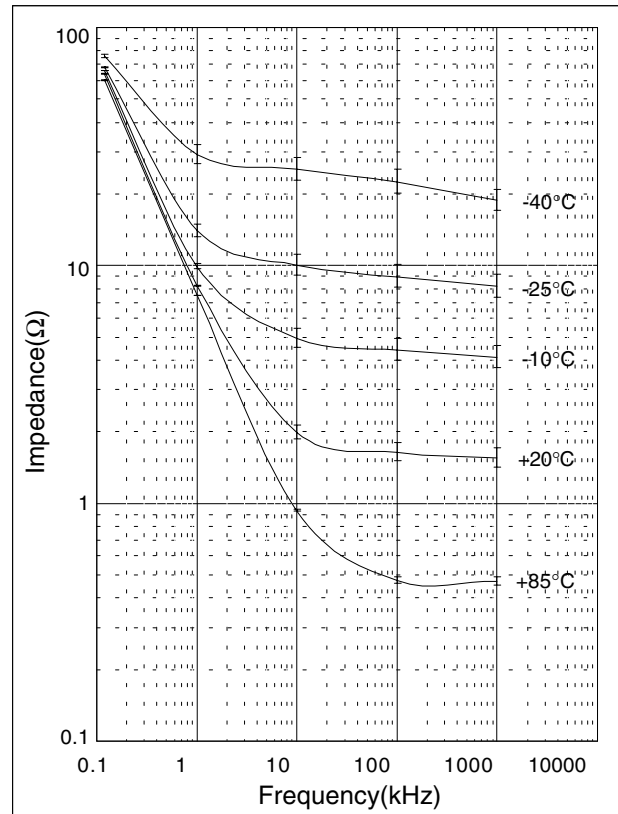

■ Temperature Characteristics

Parts No.:ECEV1EA101P(25V 100 μ F)
(ϕ 8 X 10.2) n=3

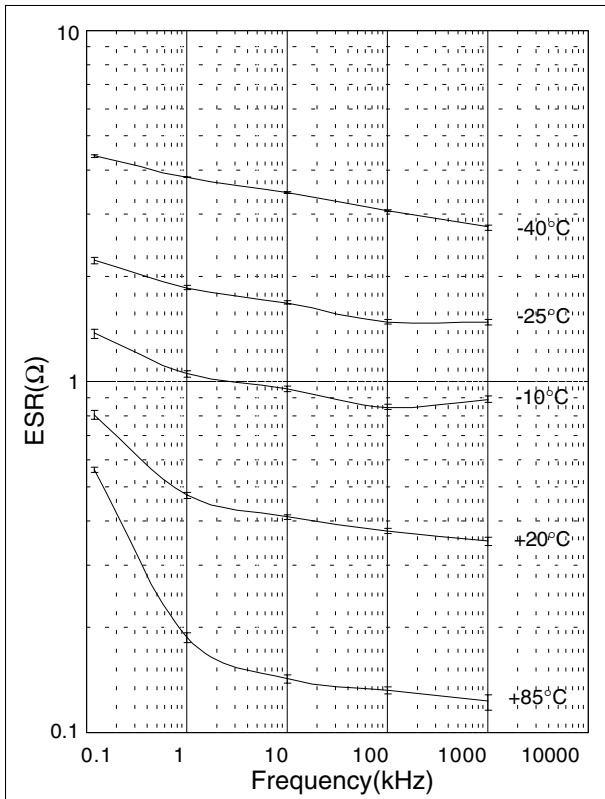
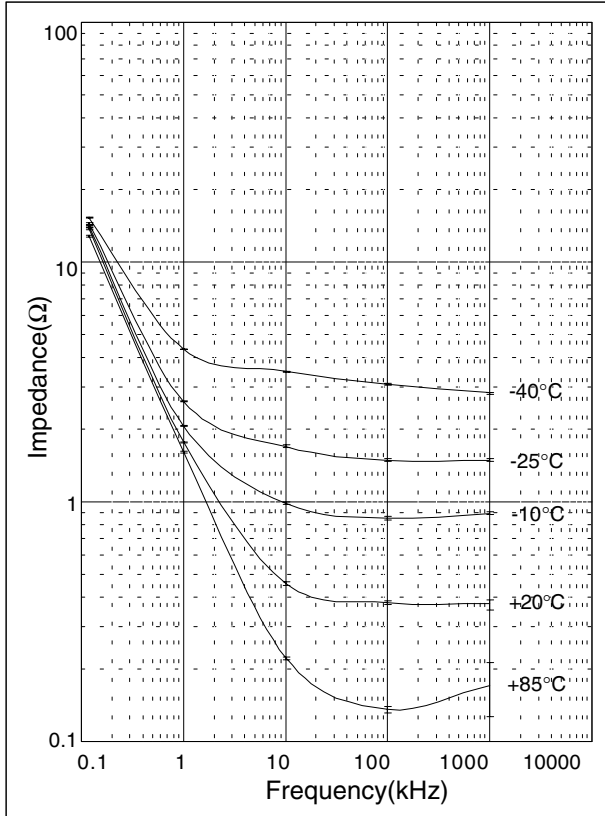

Surface Mount Type

Series: HA Type : V



- Features
 - Endurance: 105°C 1000-2000h
 - 5.4 mm height ($\leq \phi 6.3$)
 - Vibration-proof product is available upon request. ($\phi 8 \leq$)
 - RoHS directive compliant(Parts No:EEE*)

■ Specifications

Category temp. range	-40 to +105°C									
Rated W.V. Range	6.3 to 100 V .DC									
Nominal Cap. Range	0.1 to 1500 μ F									
Capacitance Tolerance	$\pm 20\%$ (120Hz/+20°C)									
DC Leakage Current	$I \leq 0.01 CV$ or $3(\mu A)$ after 2 minutes (Whichever is greater)									
tan δ	Please see the attached standard products list									
Characteristics at Low Temperature	W.V. (V)	6.3	10	16	25	35	50	63	100	(Impedance ratio at 120 Hz)
	-25 / +20 °C	4	3	2	2	2	2	3	3	
	-40 / +20 °C	8	6	4	4	3	3	4	4	
Endurance	After applying rated working voltage for 1000 hours for B~D8 sizes, 2000 hours for E~G sizes +105 \pm 2°C and then being stabilized at +20°C, capacitors shall meet the following limits.									
	Capacitance change	$\pm 20\%$ of initial measured value ($\pm 30\%$ for E~G size of 6.3V & UP suffix)								
	tan δ	$\leq 200\%$ of initial specified value ($\pm 30\%$ for E~G size of 6.3V & UP suffix)								
	DC leakage current	\leq initial specified value								
Shelf Life	After storage for 1000 hours at +105 \pm 2°C with no voltage applied and then being stabilized at +20°C, capacitors shall meet the limits specified in Endurance (With voltage treatment)									
	After reflow soldering (Refer to page 86 for recommended temperature profile.) and then being stabilized at +20°C, capacitor shall meet the following limits.									
Resistance to Soldering Heat	Capacitance change	$\pm 10\%$ of initial measured value								
	tan δ	\leq initial specified value								
	DC leakage current	\leq initial specified value								

■ Marking

Example: 50V 1 μ F (Polarized)

W.V. code

V	6.3	10	16	25	35	50	63	100
Code	j	A	C	E	V	H	J	2A

■ Dimensions in mm (not to scale)

E, F, G = L ± 0.3
D8

Size code	D	L	A, B	H	I	W	P	K
B	4.0	5.4	4.3	5.5MAX	1.8	0.65 \pm 0.1	1.0	0.35 -0.20 to +0.15
C	5.0	5.4	5.3	6.5MAX	2.2	0.65 \pm 0.1	1.5	0.35 -0.20 to +0.15
D	6.3	5.4	6.6	7.8MAX	2.6	0.65 \pm 0.1	1.8	0.35 -0.20 to +0.15
D8	6.3	7.7	6.6	7.8MAX	2.6	0.65 \pm 0.1	1.8	0.35 -0.20 to +0.15
E	8.0	6.2	8.3	9.5MAX	3.4	0.65 \pm 0.1	2.2	0.35 -0.20 to +0.15
F	8.0	10.2	8.3	10.0MAX	3.4	0.90 \pm 0.2	3.1	0.70 \pm 0.2
G	10.0	10.2	10.3	12.0MAX	3.5	0.90 \pm 0.2	4.6	0.70 \pm 0.2

■ Case size

Cap. (μ F)	W.V.(V)								
	6.3 (0J)	10 (1A)	16 (1C)	25 (1E)	35 (1V)	50 (1H)	63 (1J)	100 (2A)	
0.1 to 2.2						B			
3.3						B		E	
4.7				B	B	C		F(E)	
10			B	C(B)	C(B)	D	E	F	
22	B	(B)	C(B)	D(C)	D(C)	E	F(E)	G(F)	
33	(B)	C(B)	(C)	D(C)	E(D)	(E)FD8	G	G	
47	C(B)	(C)	D(C)	E(D)	F(E)	G(F),D8	G(F)	(G)	
100	D(C)	E(D)	(D)	F, D8(E)	G(F), D8	G(F)	G(F)		
220	(D)	F, D8	G(F), D8	G(F)	G(F)	G			
330	F, D8		G(F)	G(F)	G				
470	(F)	G(F)	G(F)	G					
680			G						
1000	G(F)	G							
1500	G								

■ Standard Products

W.V. (V)	Cap. (±20%) (μF)	Case size			Specification		Part No. (RoHS: not compliant)		Part No. (RoHS: compliant)		Min. Packagng Q'ty
		Dia. (mm)	Length (mm)	Size Code	Ripple current (120Hz) (+105°C) (mA)	tan δ (120Hz) (+20°C)		Reflow	Reflow	Taping (pcs)	
6.3	22	4	5.4	B	29	0.30	EEVHA0J220R	(1)	EEEHA0J220R	(4)	2000
	33	4	5.4	B	29	0.35	EEVHA0J330WR	(1)	EEEHA0J330WR	(4)	2000
	47	4	5.4	B	36	0.35	EEVHA0J470WR	(1)	EEEHA0J470WR	(4)	2000
				C	46	0.30	EEVHA0J470R	(1)	EEEHA0J470R	(4)	1000
	100	5	5.4	C	47	0.35	EEVHA0J101WR	(1)	EEEHA0J101WR	(4)	1000
				D	71	0.30	EEVHA0J101P	(1)	EEEHA0J101P	(4)	1000
	220	6.3	5.4	D	74	0.35	EEVHA0J221WP	(1)	EEEHA0J221WP	(4)	1000
	330	6.3	7.7	D8	105	0.30	EEVHA0J331XP	(1)	EEEHA0J331XP	(4)	900
				F	230	0.35	EEVHA0J331P	(2)	EEEHA0J331P	(5)	500
	470	8	10.2	F	300	0.35	EEVHA0J471UP	(2)	EEEHA0J471UP	(5)	500
	1000	8	10.2	F	300	0.35	EEVHA0J102UP	(2)	EEEHA0J102UP	(5)	500
G				400	0.35	EEVHA0J102P	(2)	EEEHA0J102P	(5)	500	
1500	10	10.2	G	480	0.35	EEVHA0J152P	(2)	EEEHA0J152P	(5)	500	
10	22	4	5.4	B	28	0.30	EEVHA1A220WR	(1)	EEEHA1A220WR	(4)	2000
	33	4	5.4	B	29	0.30	EEVHA1A330WR	(1)	EEEHA1A330WR	(4)	2000
				C	43	0.22	EEVHA1A330R	(1)	EEEHA1A330R	(4)	1000
	47	5	5.4	C	43	0.30	EEVHA1A470WR	(1)	EEEHA1A470WR	(4)	1000
	100	6.3	5.4	D	71	0.30	EEVHA1A101WP	(1)	EEEHA1A101WP	(4)	1000
				E	110	0.26	EEVHA1A101P	(2)	EEEHA1A101P	(5)	1000
	220	6.3	7.7	D8	105	0.22	EEVHA1A221XP	(1)	EEEHA1A221XP	(4)	900
				F	160	0.26	EEVHA1A221P	(2)	EEEHA1A221P	(5)	500
	470	8	10.2	F	200	0.26	EEVHA1A471UP	(2)	EEEHA1A471UP	(5)	500
				G	270	0.26	EEVHA1A471P	(2)	EEEHA1A471P	(5)	500
	1000	10	10.2	G	400	0.26	EEVHA1A102P	(2)	EEEHA1A102P	(5)	500
16	10	4	5.4	B	28	0.16	EEVHA1C100R	(1)	EEEHA1C100R	(4)	2000
	22	4	5.4	B	28	0.26	EEVHA1C220WR	(1)	EEEHA1C220WR	(4)	2000
				C	39	0.16	EEVHA1C220R	(1)	EEEHA1C220R	(4)	1000
	33	5	5.4	C	35	0.26	EEVHA1C330WR	(1)	EEEHA1C330WR	(4)	1000
	47	5	5.4	C	39	0.26	EEVHA1C470WR	(1)	EEEHA1C470WR	(4)	1000
				D	70	0.16	EEVHA1C470P	(1)	EEEHA1C470P	(4)	1000
	100	6.3	5.4	D	70	0.26	EEVHA1C101WP	(1)	EEEHA1C101WP	(4)	1000
	220	6.3	7.7	D8	105	0.16	EEVHA1C221XP	(1)	EEEHA1C221XP	(4)	900
				F	150	0.20	EEVHA1C221UP	(2)	EEEHA1C221UP	(5)	500
				G	210	0.20	EEVHA1C221P	(2)	EEEHA1C221P	(5)	500
	330	8	10.2	F	170	0.20	EEVHA1C331UP	(2)	EEEHA1C331UP	(5)	500
G				230	0.20	EEVHA1C331P	(2)	EEEHA1C331P	(5)	500	
470	8	10.2	F	340	0.20	EEVHA1C471UP	(2)	EEEHA1C471UP	(5)	500	
			G	340	0.20	EEVHA1C471P	(2)	EEEHA1C471P	(5)	500	
680	10	10.2	G	380	0.20	EEVHA1C681P	(2)	EEEHA1C681P	(5)	500	
25	4.7	4	5.4	B	22	0.14	EEVHA1E4R7R	(1)	EEEHA1E4R7R	(4)	2000
	10	4	5.4	B	22	0.20	EEVHA1E100WR	(1)	EEEHA1E100WR	(4)	2000
				C	28	0.14	EEVHA1E100R	(1)	EEEHA1E100R	(4)	1000
	22	5	5.4	C	35	0.20	EEVHA1E220WR	(1)	EEEHA1E220WR	(4)	1000

An explanation of the taping dimensions can be found on page 84.

Reflow profiles can be found on page 86.

Endurance: 105°C 1000h - 2000h

■ Standard Products

W.V. (V)	Cap. (±20%) (μF)	Case size			Specification		Part No. (RoHS: not compliant)	Reflow	Part No. (RoHS: compliant)	Reflow	Min. Packagng Q'ty Taping (pcs)
		Dia. (mm)	Length (mm)	Size Code	Ripple current (120Hz) (+105°C) (mA)	tan δ (120Hz) (+20°C)					
25	22	6.3	5.4	D	55	0.14	EEVHA1E220P	(1)	EEEHA1E220P	(4)	1000
	33	5	5.4	C	45	0.20	EEVHA1E330WR	(1)	EEEHA1E330WR	(4)	1000
		6.3	5.4	D	65	0.14	EEVHA1E330P	(1)	EEEHA1E330P	(4)	1000
	47	6.3	5.4	D	70	0.20	EEVHA1E470WP	(1)	EEEHA1E470WP	(4)	1000
		8	6.2	E	91	0.16	EEVHA1E470P	(2)	EEEHA1E470P	(5)	1000
	100	6.3	7.7	D8	91	0.14	EEVHA1E101XP	(1)	EEEHA1E101XP	(4)	900
		8	6.2	E	91	0.16	EEVHA1E101UP	(2)	EEEHA1E101UP	(5)	1000
		8	10.2	F	130	0.16	EEVHA1E101P	(2)	EEEHA1E101P	(5)	500
	220	8	10.2	F	160	0.16	EEVHA1E221UP	(2)	EEEHA1E221UP	(5)	500
		10	10.2	G	190	0.16	EEVHA1E221P	(2)	EEEHA1E221P	(5)	500
330	8	10.2	F	180	0.16	EEVHA1E331UP	(2)	EEEHA1E331UP	(5)	500	
	10	10.2	G	340	0.16	EEVHA1E331P	(2)	EEEHA1E331P	(5)	500	
470	10	10.2	G	360	0.16	EEVHA1E471P	(2)	EEEHA1E471P	(5)	500	
35	4.7	4	5.4	B	22	0.12	EEVHA1V4R7R	(1)	EEEHA1V4R7R	(4)	2000
	10	4	5.4	B	22	0.16	EEVHA1V100WR	(1)	EEEHA1V100WR	(4)	2000
		5	5.4	C	30	0.12	EEVHA1V100R	(1)	EEEHA1V100R	(4)	1000
	22	5	5.4	C	35	0.16	EEVHA1V220WR	(1)	EEEHA1V220WR	(4)	1000
		6.3	5.4	D	60	0.12	EEVHA1V220P	(1)	EEEHA1V220P	(4)	1000
	33	6.3	5.4	D	42	0.16	EEVHA1V330WP	(1)	EEEHA1V330WP	(4)	1000
		8	6.2	E	84	0.14	EEVHA1V330P	(2)	EEEHA1V330P	(5)	1000
	47	8	6.2	E	84	0.14	EEVHA1V470UP	(2)	EEEHA1V470UP	(5)	1000
		8	10.2	F	98	0.14	EEVHA1V470P	(2)	EEEHA1V470P	(5)	500
	100	6.3	7.7	D8	84	0.12	EEVHA1V101XP	(1)	EEEHA1V101XP	(4)	900
		8	10.2	F	120	0.14	EEVHA1V101UP	(2)	EEEHA1V101UP	(5)	500
		10	10.2	G	160	0.14	EEVHA1V101P	(2)	EEEHA1V101P	(5)	500
	220	8	10.2	F	170	0.14	EEVHA1V221UP	(2)	EEEHA1V221UP	(5)	500
10		10.2	G	210	0.14	EEVHA1V221P	(2)	EEEHA1V221P	(5)	500	
330	10	10.2	G	250	0.14	EEVHA1V331P	(2)	EEEHA1V331P	(5)	500	
50	0.1	4	5.4	B	1	0.12	EEVHA1HR10R	(1)	EEEHA1HR10R	(4)	2000
	0.22	4	5.4	B	2	0.12	EEVHA1HR22R	(1)	EEEHA1HR22R	(4)	2000
	0.33	4	5.4	B	3	0.12	EEVHA1HR33R	(1)	EEEHA1HR33R	(4)	2000
	0.47	4	5.4	B	5	0.12	EEVHA1HR47R	(1)	EEEHA1HR47R	(4)	2000
	1	4	5.4	B	10	0.12	EEVHA1H1R0R	(1)	EEEHA1H1R0R	(4)	2000
	2.2	4	5.4	B	16	0.12	EEVHA1H2R2R	(1)	EEEHA1H2R2R	(4)	2000
	3.3	4	5.4	B	16	0.12	EEVHA1H3R3R	(1)	EEEHA1H3R3R	(4)	2000
	4.7	5	5.4	C	23	0.12	EEVHA1H4R7R	(1)	EEEHA1H4R7R	(4)	1000
	10	6.3	5.4	D	35	0.12	EEVHA1H100P	(1)	EEEHA1H100P	(4)	1000
	22	8	6.2	E	70	0.12	EEVHA1H220P	(2)	EEEHA1H220P	(5)	1000
	33	6.3	7.7	D8	70	0.12	EEVHA1H330XP	(1)	EEEHA1H330XP	(4)	900
		8	6.2	E	70	0.12	EEVHA1H330UP	(2)	EEEHA1H330UP	(5)	1000
		8	10.2	F	91	0.12	EEVHA1H330P	(2)	EEEHA1H330P	(5)	500
	47	6.3	7.7	D8	63	0.12	EEVHA1H470XP	(1)	EEEHA1H470XP	(4)	900
8		10.2	F	95	0.12	EEVHA1H470UP	(2)	EEEHA1H470UP	(5)	500	
10		10.2	G	100	0.12	EEVHA1H470P	(2)	EEEHA1H470P	(5)	500	

An explanation of the taping dimensions can be found on page 84.

Reflow profiles can be found on page 86.

Endurance: 105°C 1000h - 2000h

■ Standard Products

W.V. (V)	Cap. (±20%) (μF)	Case size			Specification		Part No. (RoHS: not compliant)	Reflow	Part No. (RoHS: compliant)	Reflow	Min. Packaging Q'ty Taping (pcs)
		Dia. (mm)	Length (mm)	Size Code	Ripple current (120Hz) (+105°C) (mA)	tan δ (120Hz) (+20°C)					
50	100	8	10.2	F	110	0.12	EEVHA1H101UP	(2)	EEEHA1H101UP	(5)	500
		10	10.2	G	120	0.12	EEVHA1H101P	(2)	EEEHA1H101P	(5)	500
	220	10	10.2	G	150	0.12	EEVHA1H221P	(2)	EEEHA1H221P	(5)	500
63	10	8	6.2	E	25	0.18	EEVHA1J100P	(2)	EEEHA1J100P	(5)	1000
	22	8	6.2	E	25	0.18	EEVHA1J220UP	(2)	EEEHA1J220UP	(5)	500
		8	10.2	F	30	0.18	EEVHA1J220P	(2)	EEEHA1J220P	(5)	500
	33	10	10.2	G	45	0.18	EEVHA1J330P	(2)	EEEHA1J330P	(5)	500
	47	8	10.2	F	45	0.18	EEVHA1J470UP	(2)	EEEHA1J470UP	(5)	500
		10	10.2	G	50	0.18	EEVHA1J470P	(2)	EEEHA1J470P	(5)	500
100	3.3	8	6.2	E	30	0.18	EEVHA2A3R3P	(2)	EEEHA2A3R3P	(5)	1000
	4.7	8	6.2	E	30	0.18	EEVHA2A4R7UP	(2)	EEEHA2A4R7UP	(5)	1000
		8	10.2	F	50	0.18	EEVHA2A4R7P	(2)	EEEHA2A4R7P	(5)	500
	10	8	10.2	F	55	0.18	EEVHA2A100P	(2)	EEEHA2A100P	(5)	500
	22	8	10.2	F	55	0.18	EEVHA2A220UP	(2)	EEEHA2A220UP	(5)	500
		10	10.2	G	60	0.18	EEVHA2A220P	(2)	EEEHA2A220P	(5)	500
	33	10	10.2	G	65	0.18	EEVHA2A330P	(2)	EEEHA2A330P	(5)	500
47	10	10.2	G	65	0.18	EEVHA2A470UP	(2)	EEEHA2A470UP	(5)	500	

An explanation of the taping dimensions can be found on page 84.

Reflow profiles can be found on page 86.

Endurance: 105°C 1000h - 2000h

■ Frequency Correction Factor of Rated Ripple Current

	Frequency (Hz)			
	50,60	120	1k	10k~
coefficient	0.70	1.0	1.3	1.7

Temperature Characteristics

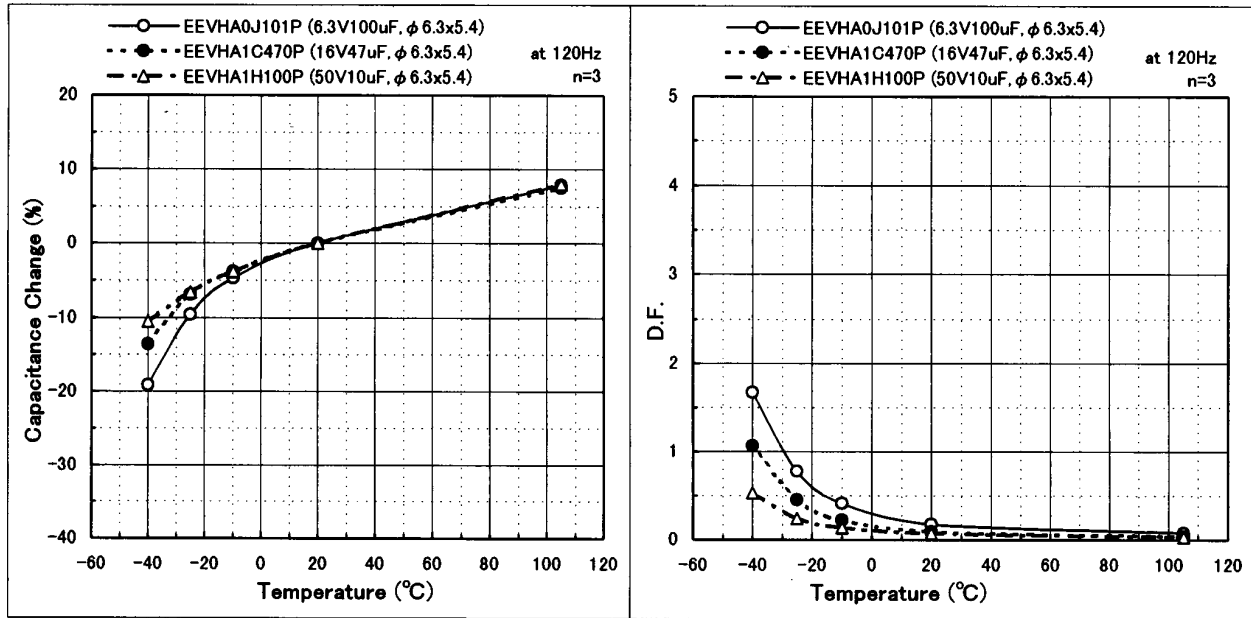

Endurance

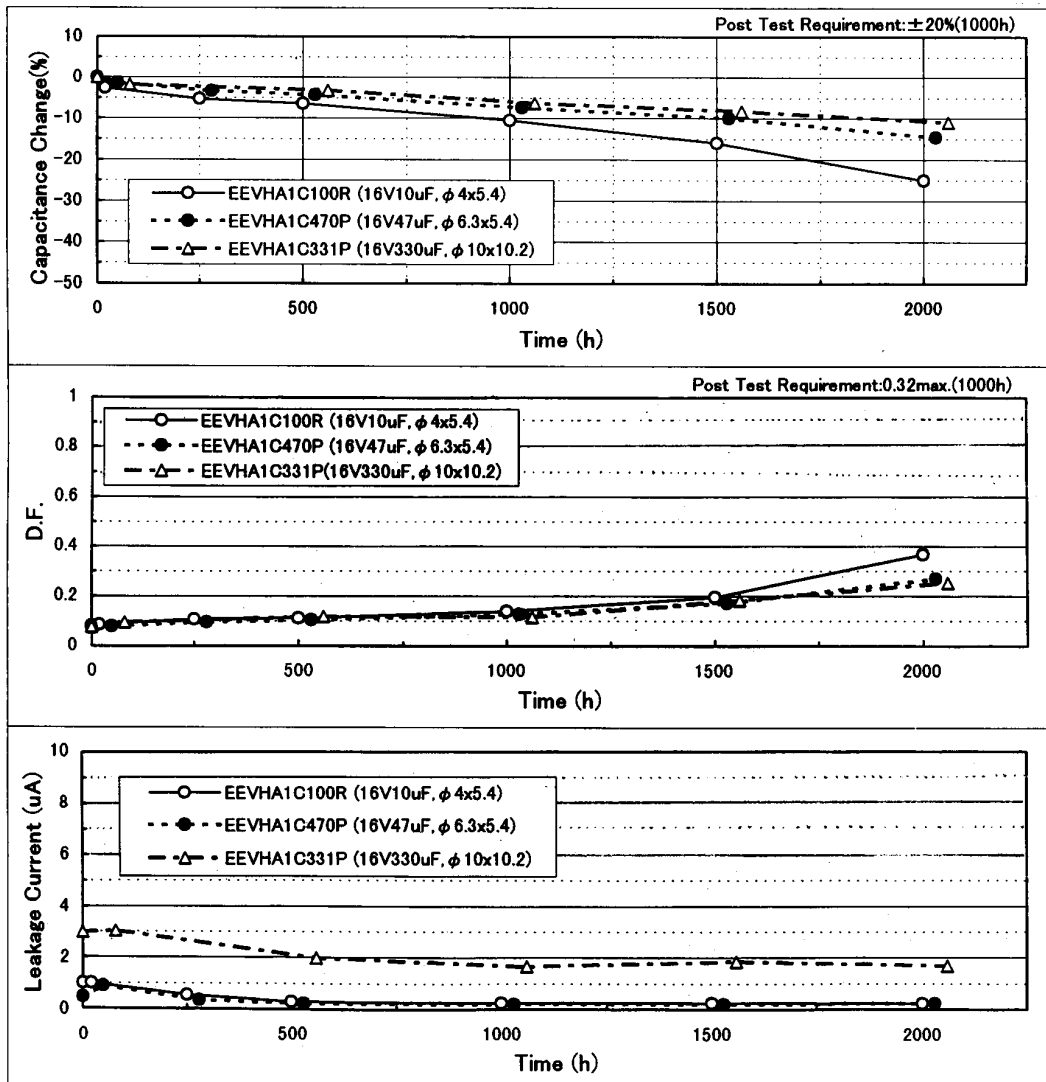

■ Frequency Characteristics

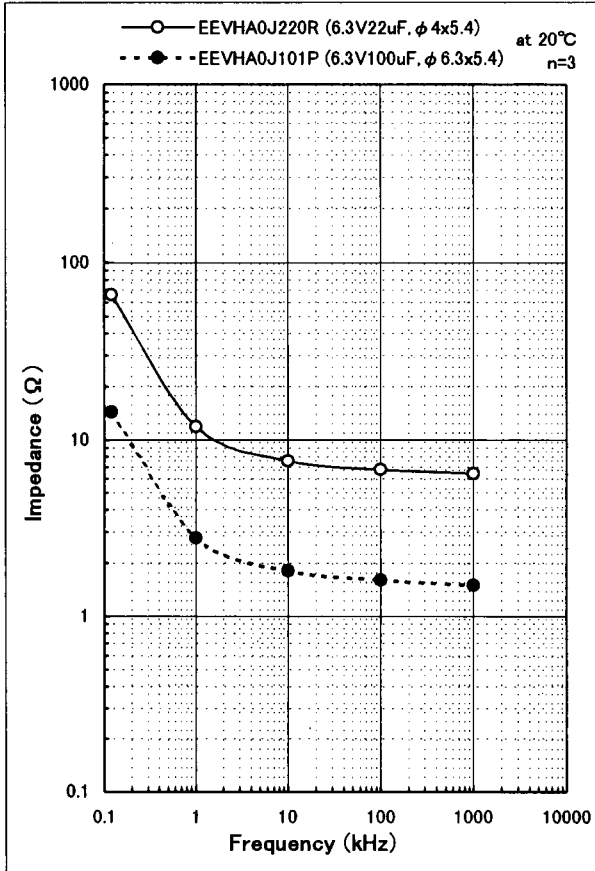

◎35WV

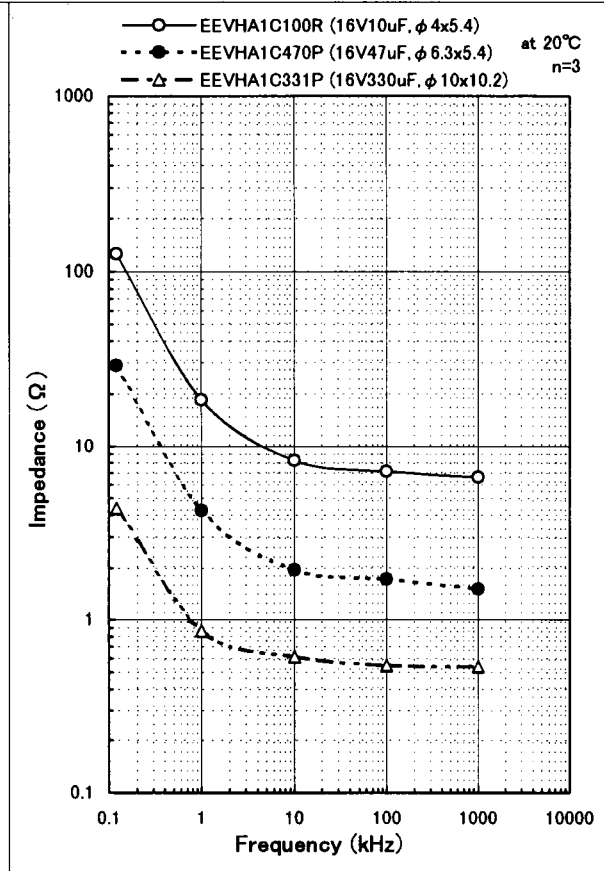

◎50WV

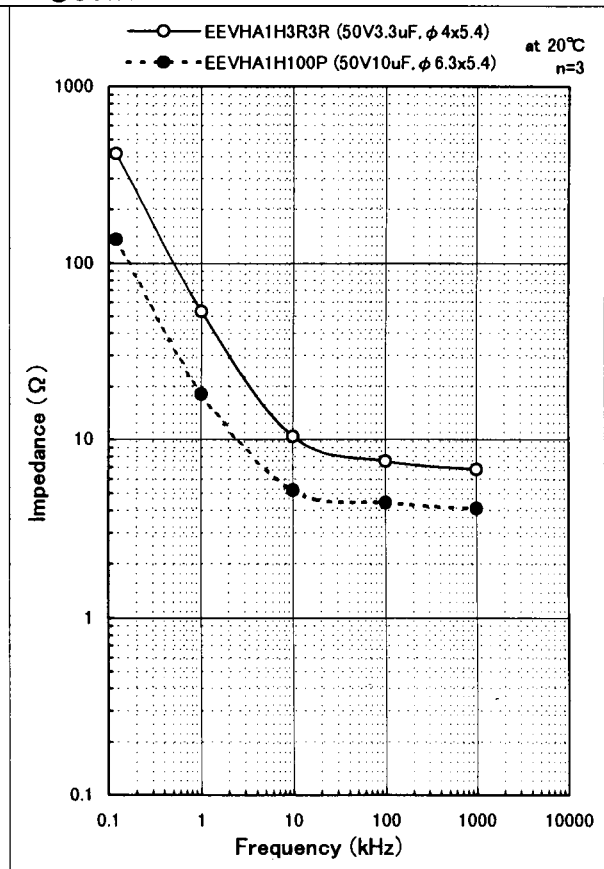
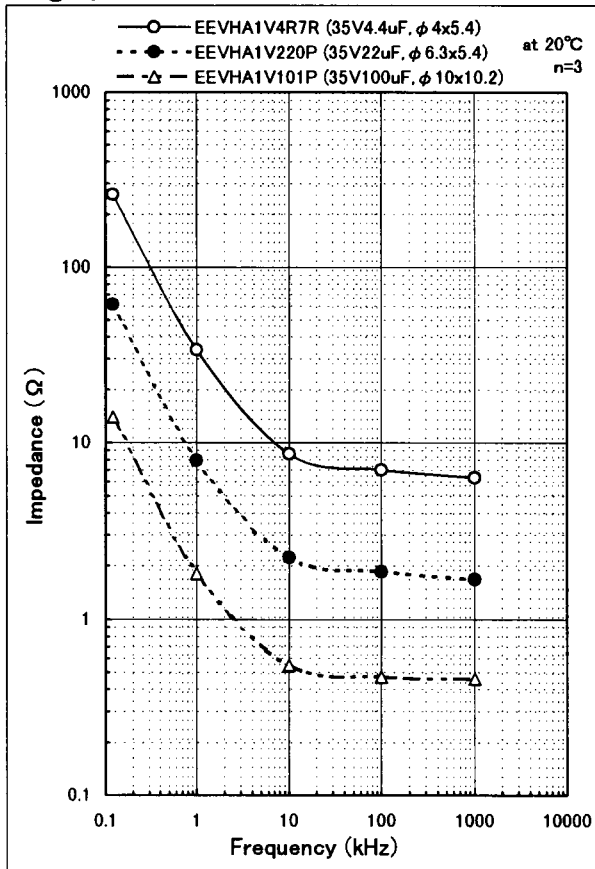

Temperature Characteristics

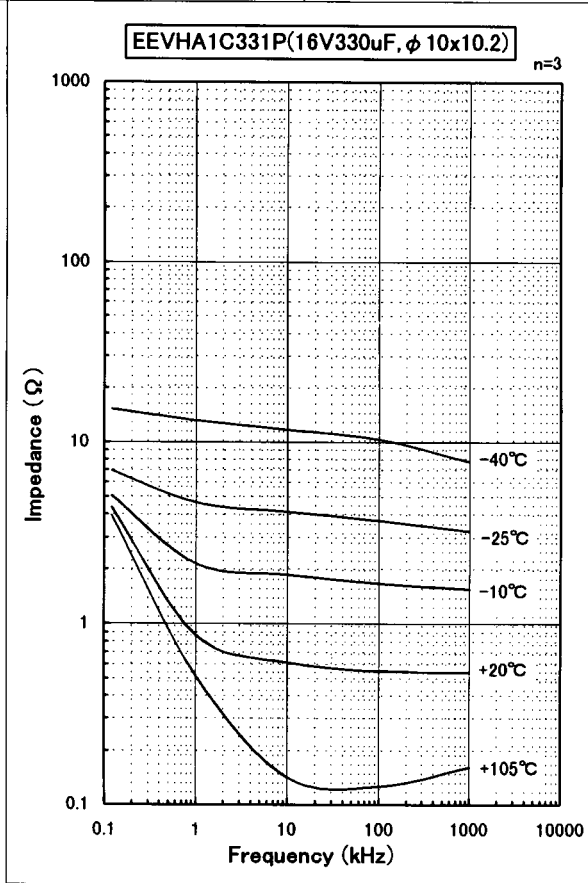
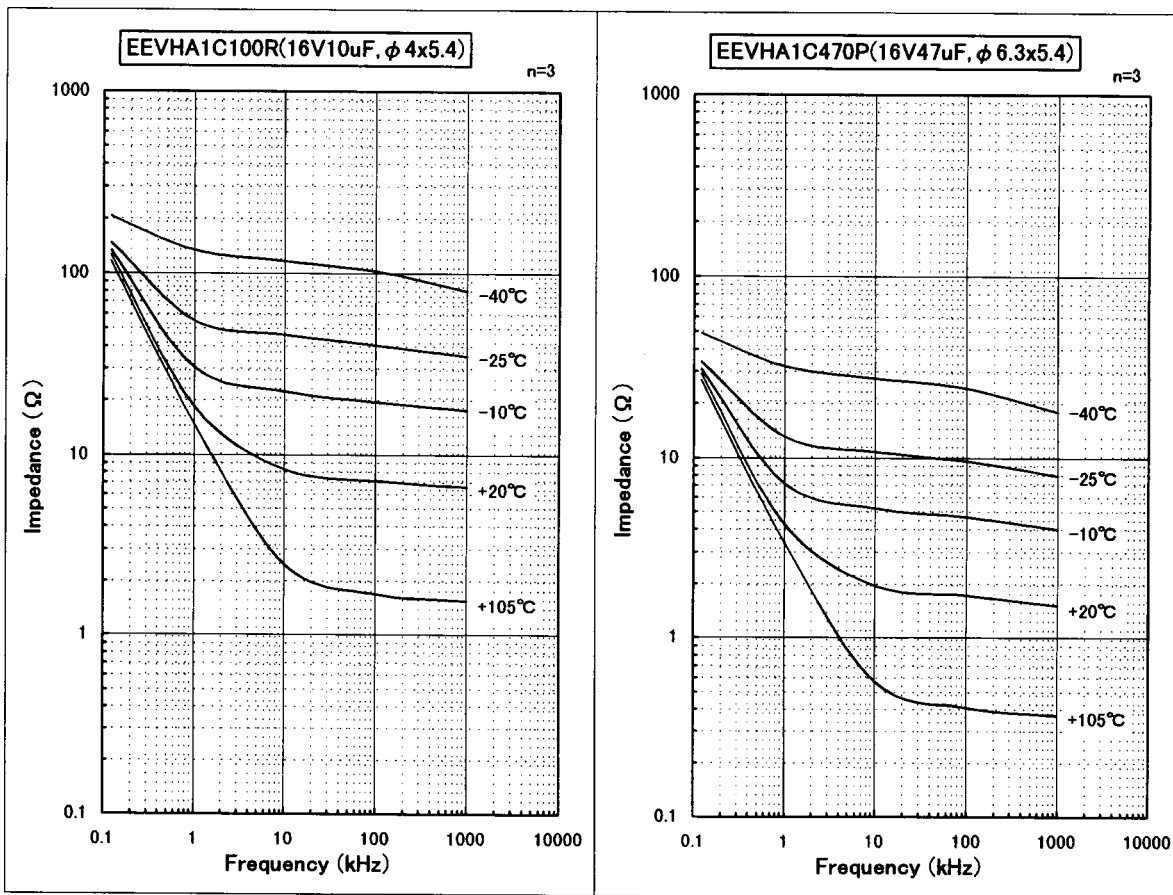

Surface Mount Type

Series: **HB** Type : **V**

- **Features**
 - Endurance: 105°C 2000 h
 - 5.8 mm height ($\leq \phi 6.3$)
 - Vibration-proof product is available upon request. ($\phi 8 \leq$)
 - RoHS directive compliant (Parts No.:EEE*)



■ Specifications																									
Category temp. range	-40 to +105°C																								
Rated W.V. Range	4 to 50 V .DC																								
Nominal Cap. Range	0.1 to 220 μ F																								
Capacitance Tolerance	$\pm 20\%$ (120Hz/+20°C)																								
DC Leakage Current	$I \leq 0.01 CV$ or $3(\mu A)$ after 2 minutes (Whichever is greater) (Bi-Polar $I=0.02 CV$ or $6(\mu A)$ after 2 minutes) (Whichever is greater)																								
tan δ	Please see the attached standard products list																								
Characteristics at Low Temperature	<table border="1"> <thead> <tr> <th>W.V. (V)</th> <th>4</th> <th>6.3</th> <th>10</th> <th>16</th> <th>25</th> <th>35</th> <th>50</th> </tr> </thead> <tbody> <tr> <td>-25 / +20 °C</td> <td>7</td> <td>4</td> <td>3</td> <td>2</td> <td>2</td> <td>2</td> <td>2</td> </tr> <tr> <td>-40 / +20 °C</td> <td>15</td> <td>8</td> <td>6</td> <td>4</td> <td>4</td> <td>3</td> <td>3</td> </tr> </tbody> </table>	W.V. (V)	4	6.3	10	16	25	35	50	-25 / +20 °C	7	4	3	2	2	2	2	-40 / +20 °C	15	8	6	4	4	3	3
	W.V. (V)	4	6.3	10	16	25	35	50																	
	-25 / +20 °C	7	4	3	2	2	2	2																	
-40 / +20 °C	15	8	6	4	4	3	3																		
(Impedance ratio at 120 Hz)																									
Endurance	After applying rated working voltage for 2000 hours at +105 \pm 2°C and then being stabilized at +20°C, capacitors shall meet the following limits.																								
	Capacitance change	$\pm 20\%$ of initial measured value (4W.V.: $\pm 35\%$, 6.3W.V.: $\pm 25\%$)																							
	tan δ	$\leq 200\%$ of initial specified value																							
Shelf Life	After storage for 1000 hours at +105 \pm 2°C with no voltage applied and then being stabilized at +20°C, capacitors shall meet the limits specified in Endurance. (With voltage treatment)																								
	After reflow soldering (Refer to page 86 for recommended temperature profile.) and then being stabilized at +20°C, capacitor shall meet the following limits.																								
Resistance to Soldering Heat	Capacitance change	$\pm 10\%$ of initial measured value																							
	tan δ	\leq initial specified value																							
	DC leakage current	\leq initial specified value																							

■ Marking

Example: 50V 1 μ F (Polarized)

W.V. code

Negative polarity marking (No marking for the bi-polar)

Capacitance (μ F)

Series identification (HP:Bi-polar)

Lot number

W.V. code

V	4	6.3	10	16	25	35	50
Code	g	j	A	C	E	V	H

■ Dimensions in mm (not to scale)

Size code	D	L	A, B	H	I	W	P	K
B	4.0	5.8	4.3	5.5MAX	1.8	0.65 \pm 0.1	1.0	0.35 -0.20 to +0.15
C	5.0	5.8	5.3	6.5MAX	2.2	0.65 \pm 0.1	1.5	0.35 -0.20 to +0.15
D	6.3	5.8	6.6	7.8MAX	2.6	0.65 \pm 0.1	1.8	0.35 -0.20 to +0.15

■ Case size

W.V.(V)	4		6.3		10		16		25		35		50	
Cap. (μ F)	Polar-ized	Polar-ized	Bi - polar	Polar-ized	Bi - polar	Polar-ized	Bi - polar	Polar-ized	Bi - polar	Polar-ized	Bi - polar	Polar-ized	Bi - polar	
0.1 to 0.47												B	B	
1.0												B	B	
2.2												B	B	
3.3									B			B	D	
4.7								B	B			C	D	
6.8								B				C		
10					B	B	C		D	C		D		
22		B							D	D				
33		B		C	D				D					
47	B	C	D											
68														
100	C	D												
150	D													
220	D													

■ Standard Products

W.V. (V)	Cap. (±20%) (μF)	Case size			Specification		Part No. (RoHS: not compliant)		Part No. (RoHS: compliant)		Min. Packaging Q'ty
		Dia. (mm)	Length (mm)	Size Code	Ripple current (120Hz) (+105°C) (mA)	tan δ (120Hz) (+20°C)	Reflow	Reflow	Taping (pcs)		
4	47	4	5.8	B	34	0.50	EEVHB0G470R	(1)	EEEHB0G470R	(4)	2000
	100	5	5.8	C	61	0.50	EEVHB0G101R	(1)	EEEHB0G101R	(4)	1000
	150	6.3	5.8	D	82	0.50	EEVHB0G151P	(1)	EEEHB0G151P	(4)	1000
	220	6.3	5.8	D	82	0.50	EEVHB0G221P	(1)	EEEHB0G221P	(4)	1000
6.3	22	4	5.8	B	26	0.30	EEVHB0J220R	(1)	EEEHB0J220R	(4)	2000
	33	4	5.8	B	29	0.30	EEVHB0J330R	(1)	EEEHB0J330R	(4)	2000
	47	5	5.8	C	46	0.30	EEVHB0J470R	(1)	EEEHB0J470R	(4)	1000
	100	6.3	5.8	D	71	0.30	EEVHB0J101P	(1)	EEEHB0J101P	(4)	1000
10	33	5	5.8	C	43	0.22	EEVHB1A330R	(1)	EEEHB1A330R	(4)	1000
16	10	4	5.8	B	28	0.16	EEVHB1C100R	(1)	EEEHB1C100R	(4)	2000
	22	5	5.8	C	39	0.16	EEVHB1C220R	(1)	EEEHB1C220R	(4)	1000
	47	6.3	5.8	D	70	0.16	EEVHB1C470P	(1)	EEEHB1C470P	(4)	1000
25	4.7	4	5.8	B	22	0.14	EEVHB1E4R7R	(1)	EEEHB1E4R7R	(4)	2000
	6.8	4	5.8	B	25	0.14	EEVHB1E6R8R	(1)	EEEHB1E6R8R	(4)	2000
	33	6.3	5.8	D	65	0.14	EEVHB1E330P	(1)	EEEHB1E330P	(4)	1000
35	10	5	5.8	C	28	0.12	EEVHB1V100R	(1)	EEEHB1V100R	(4)	1000
	22	6.3	5.8	D	55	0.12	EEVHB1V220P	(1)	EEEHB1V220P	(4)	1000
50	0.1	4	5.8	B	1	0.12	EEVHB1HR10R	(1)	EEEHB1HR10R	(4)	2000
	0.22	4	5.8	B	2	0.12	EEVHB1HR22R	(1)	EEEHB1HR22R	(4)	2000
	0.33	4	5.8	B	3	0.12	EEVHB1HR33R	(1)	EEEHB1HR33R	(4)	2000
	0.47	4	5.8	B	5	0.12	EEVHB1HR47R	(1)	EEEHB1HR47R	(4)	2000
	1	4	5.8	B	10	0.12	EEVHB1H1R0R	(1)	EEEHB1H1R0R	(4)	2000
	2.2	4	5.8	B	16	0.12	EEVHB1H2R2R	(1)	EEEHB1H2R2R	(4)	2000
	3.3	4	5.8	B	16	0.12	EEVHB1H3R3R	(1)	EEEHB1H3R3R	(4)	2000
	4.7	5	5.8	C	23	0.12	EEVHB1H4R7R	(1)	EEEHB1H4R7R	(4)	1000
	6.8	5	5.8	C	23	0.12	EEVHB1H6R8R	(1)	EEEHB1H6R8R	(4)	1000
10	6.3	5.8	D	35	0.12	EEVHB1H100P	(1)	EEEHB1H100P	(4)	1000	

An explanation of the taping dimensions can be found on page 84.

Reflow profiles can be found on page 86.

Endurance: 105°C 2000h

■ Standard Products(Bi-polar)

W.V. (V)	Cap. (±20%) (μF)	Case size			Specification		Part No. (RoHS: not compliant)	Reflow	Part No. (RoHS: compliant)	Reflow	Min. Packaging Q'ty Taping (pcs)
		Dia. (mm)	Length (mm)	Size Code	Ripple current (120Hz) (+105°C) (mA)	tan δ (120Hz) (+20°C)					
6.3	47	6.3	5.8	D	35	0.60	EEVHP0J470P	(1)	EEEHP0J470P	(4)	1000
10	10	4	5.8	B	20	0.44	EEVHP1A100R	(1)	EEEHP1A100R	(4)	2000
	33	6.3	5.8	D	26	0.44	EEVHP1A330P	(1)	EEEHP1A330P	(4)	1000
16	10	5	5.8	C	25	0.32	EEVHP1C100R	(1)	EEEHP1C100R	(4)	1000
25	3.3	4	5.8	B	12	0.28	EEVHP1E3R3R	(1)	EEEHP1E3R3R	(4)	2000
	4.7	4	5.8	B	12	0.28	EEVHP1E4R7R	(1)	EEEHP1E4R7R	(4)	2000
	10	6.3	5.8	D	28	0.28	EEVHP1E100P	(1)	EEEHP1E100P	(4)	1000
	22	6.3	5.8	D	55	0.28	EEVHP1E220P	(1)	EEEHP1E220P	(4)	1000
35	2.2	4	5.8	B	10	0.24	EEVHP1V2R2R	(1)	EEEHP1V2R2R	(4)	2000
50	0.22	4	5.8	B	2	0.24	EEVHP1HR22R	(1)	EEEHP1HR22R	(4)	2000
	0.33	4	5.8	B	3	0.24	EEVHP1HR33R	(1)	EEEHP1HR33R	(4)	2000
	0.47	4	5.8	B	5	0.24	EEVHP1HR47R	(1)	EEEHP1HR47R	(4)	2000
	1	4	5.8	B	10	0.24	EEVHP1H1R0R	(1)	EEEHP1H1R0R	(4)	2000
	3.3	6.3	5.8	D	16	0.24	EEVHP1H3R3P	(1)	EEEHP1H3R3P	(4)	1000
	4.7	6.3	5.8	D	23	0.24	EEVHP1H4R7P	(1)	EEEHP1H4R7P	(4)	1000

An explanation of the taping dimensions can be found on page 84.

Reflow profiles can be found on page 86.

Endurance: 105°C 2000h

■ Frequency Correction Factor of Rated Ripple Current

	Frequency (Hz)			
	50,60	120	1k	10k~
coefficient	0.70	1.0	1.3	1.7

Temperature Characteristics

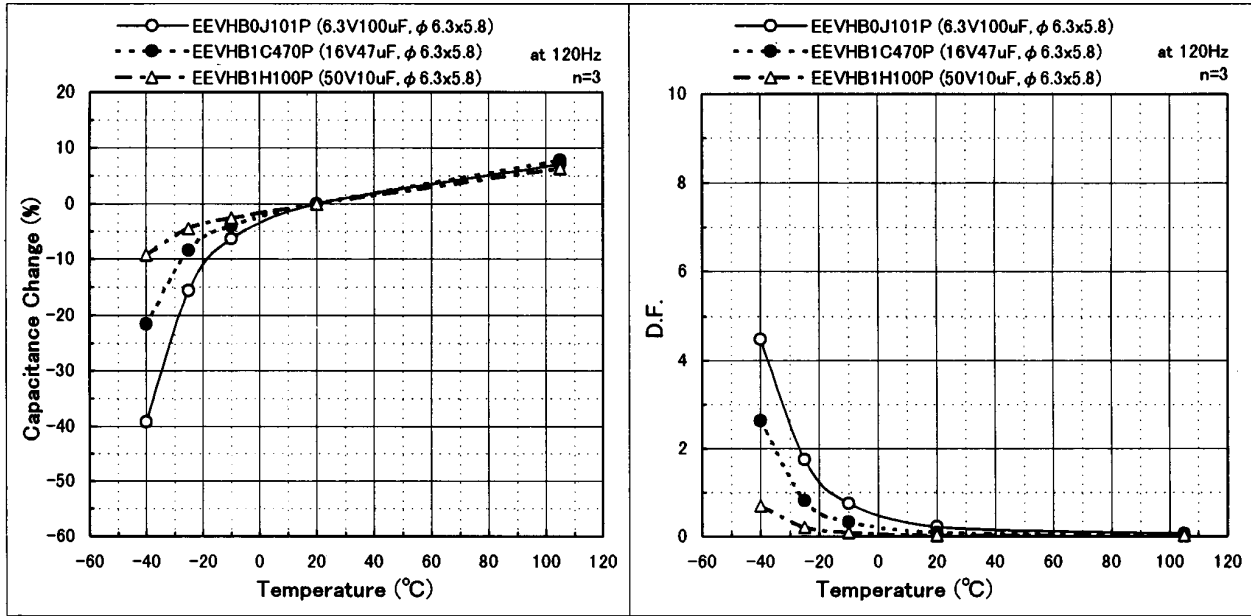

Endurance

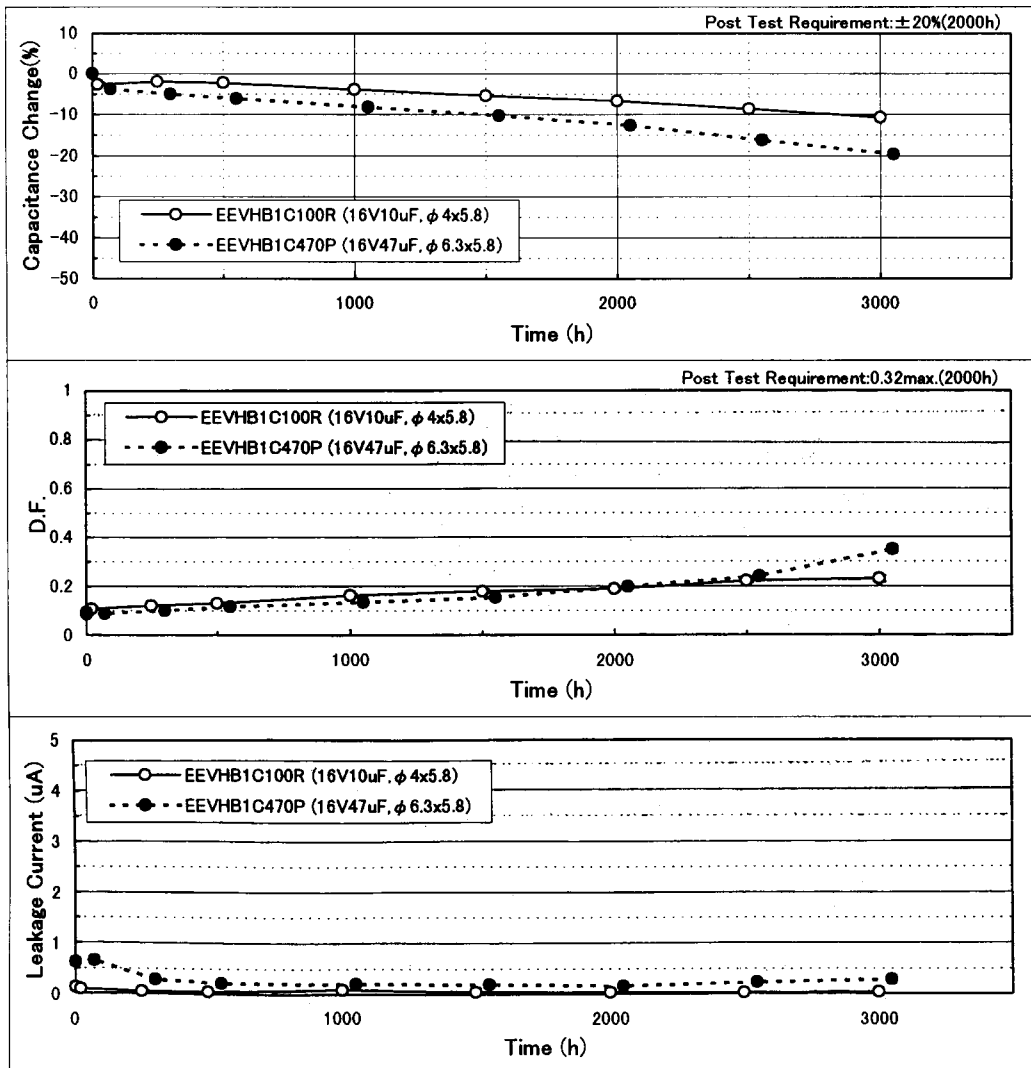

■ Frequency Characteristics

◎6.3WV

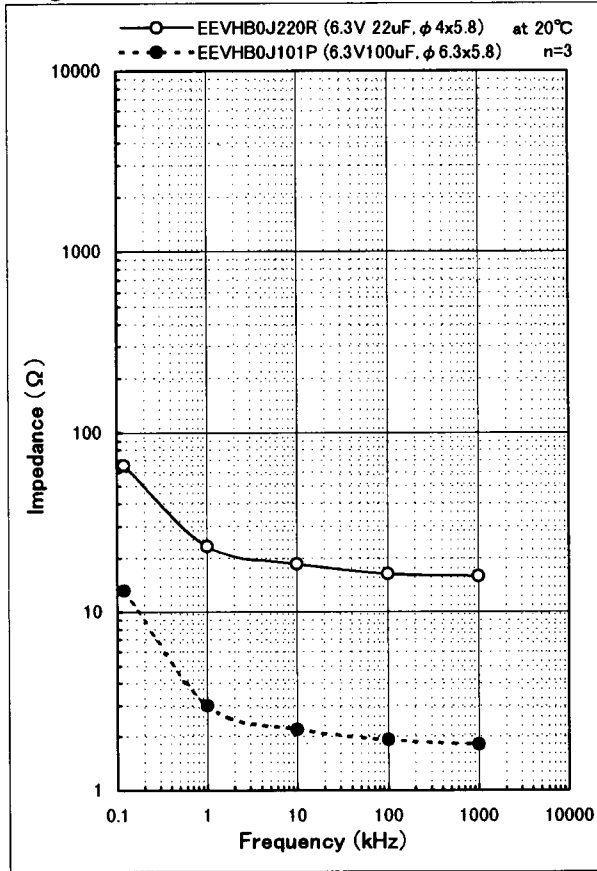

◎16WV

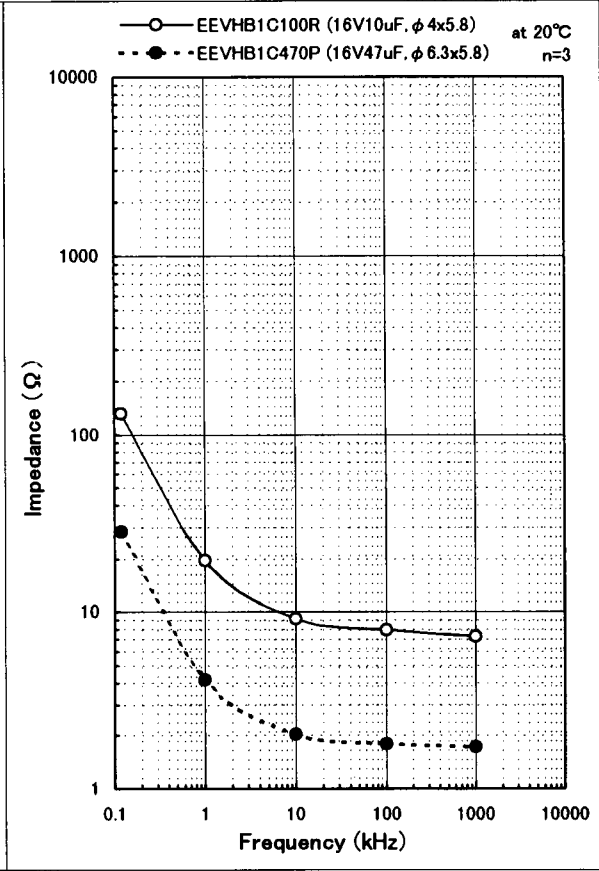

◎50WV

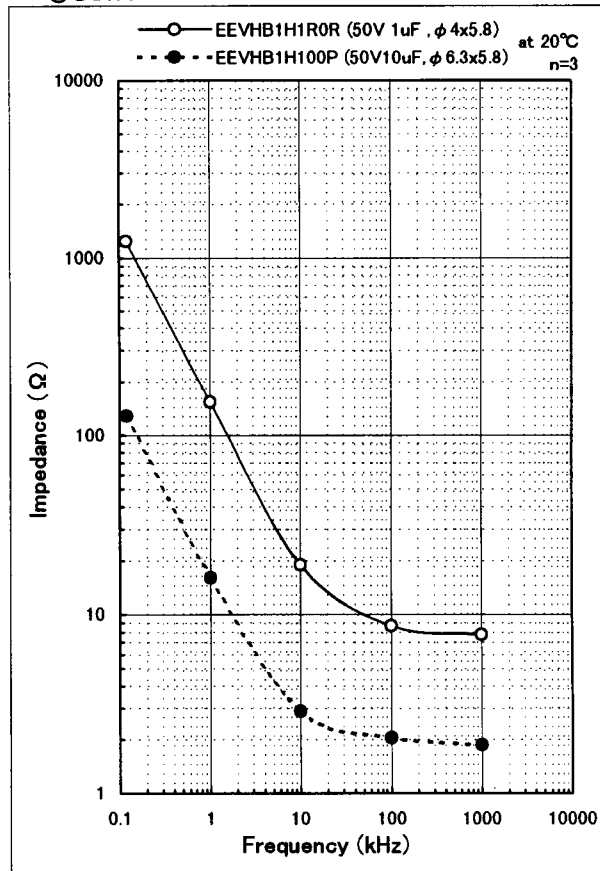

Temperature Characteristics

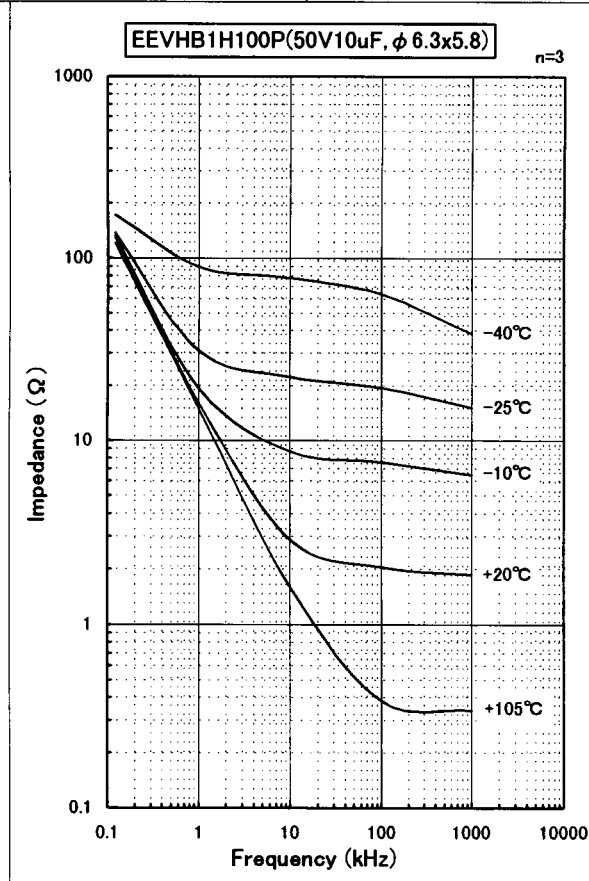
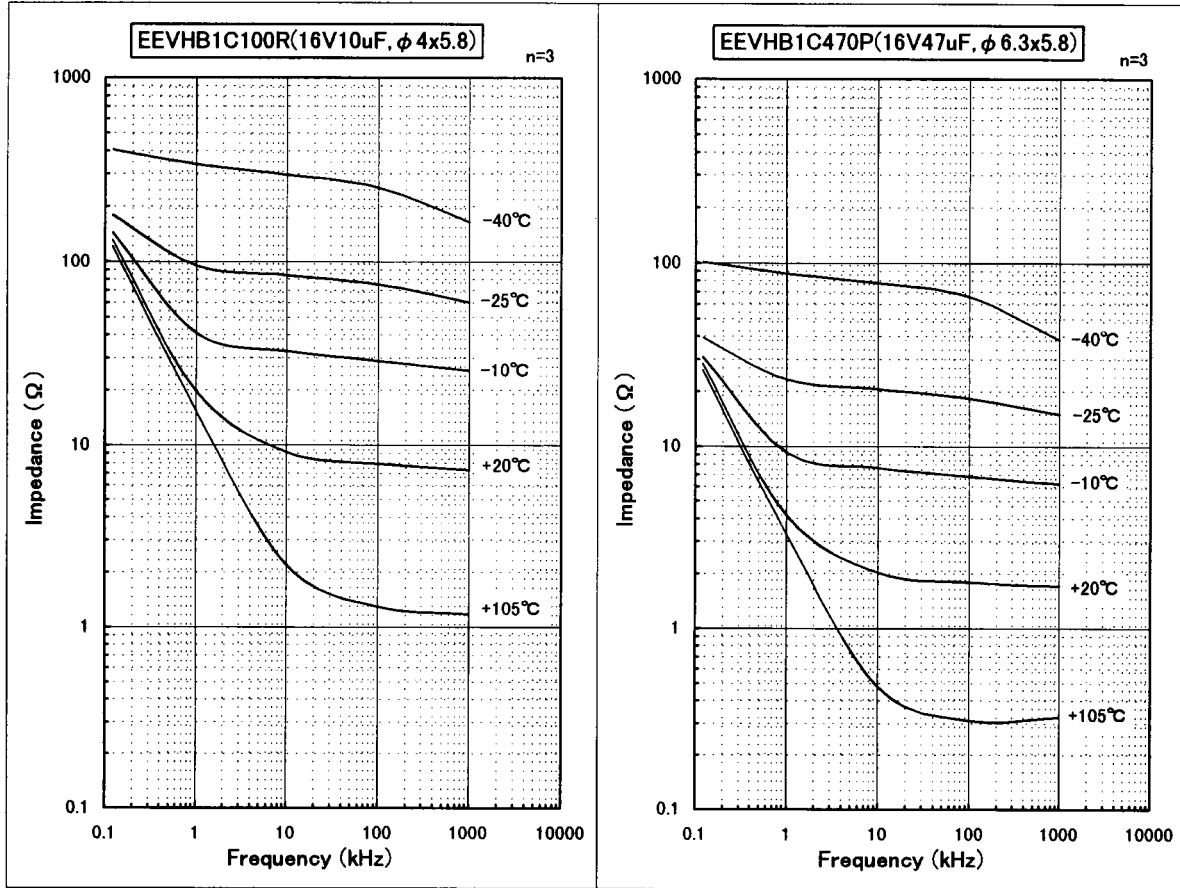

Surface Mount Type

Series: **HC** Type : **V**

- Features Life time: 3000 hours at 105°C
(φ8,φ10: 5000 hours)
RoHS directive compliant

Long life



■ Specification

Category Temp.Range	-40 ~ +105°C						
Rated W.V.Range	6.3 ~ 50 V .DC						
Nominal Cap.Range	0.1 ~ 1000 μF						
Capacitance Tolerance	±20 % (120Hz/+20°C)						
Leakage Current	I ≤ 0.01 CV or 3(μA) After 2 minutes application of rated working voltage at +20°C (Whichever is greater)						
tan δ	6.3V	10V	16V	25V	35V	50V	(120Hz / 20°C)
	0.3(*)	0.26	0.20	0.16	0.14	0.12	(*1000μF:0.5)
Characteristics at Low Temperature	R.V.(V.DC)	6.3	10	16	25	35	50
	Z(-25°C)/Z(20°C)	3	3	2	2	2	2
	Z(-40°C)/Z(20°C)	8	5	4	3	3	3
Endurance	φ4 to φ6 (105°C 3000h After applying rated working voltage) φ8,φ10 (105°C 5000h After applying rated working voltage)						
	Capacitance change	±30% of initially measured values					
	tan δ	≤300% of initially specified values					
	DC leakage current	≤ initially specified values					
Resistance to Soldering Heat	Capacitance change	±10% of initially measured values					
	tan δ	≤ initially specified values					
	DC leakage current	≤ initially specified values					

■ Marking

Example: 50V1μF (polarized)
Marking color: BLACK

W.V.code

Negative polarity marking(-)

Capacitance (μF)

Series identification

Lot number

W.V.code	V	6.3	10	16	25	35	50
Code		j	A	C	E	V	H

■ Dimensions in mm (not to scale)

Size code	D	L	A,B	H	I	W	P	K
B	4.0	5.8	4.3	5.5MAX	1.8	0.65±0.1	1.0	0.35-0.20 ~ +0.15
C	5.0	5.8	5.3	6.5MAX	2.2	0.65±0.1	1.5	0.35-0.20 ~ +0.15
D	6.3	5.8	6.6	7.8MAX	2.6	0.65±0.1	1.8	0.35-0.20 ~ +0.15
D8	6.3	7.7	6.6	7.8MAX	2.6	0.65±0.1	1.8	0.35-0.20 ~ +0.15
F	8.0	10.2	8.3	10.0MAX	3.4	0.90±0.2	3.1	0.70 ±0.2
G	10.0	10.2	10.3	12.0MAX	3.5	0.90±0.2	4.6	0.70 ±0.2

■ Case size

W.V.(V)	6.3	10	16	25	35	50
Cap. (μF)						
0.1						B
0.22						B
0.33						B
0.47						B
1						B
2.2						B
3.3						B
4.7					B	C
10			B		C	D
22	B		C		D	D8
33		C		D	D8	F
47	C		D	D8		F
100	D		D8	F		G
220	D8	F			G	
330	F			G		
470			G			
1000	G					

■ Standard Products

W.V. (V)	Cap. (±20%) (μF)	Case Size			Specification		Part No. (RoHS: compliant)	Reflow	Min. Packaging Qty
		Dia. (mm)	Length (mm)	Size code	Ripple current (120Hz) (+105°C) (mA)	tan δ (120Hz) (+20°C)			Taping (pcs)
6.3	22	4	5.8	B	26	0.30	EEEHC0J220R	(4)	2000
	47	5	5.8	C	46	0.30	EEEHC0J470R	(4)	1000
	100	6.3	5.8	D	71	0.30	EEEHC0J101P	(4)	1000
	220	6.3	7.7	D8	101	0.30	EEEHC0J221XP	(4)	900
	330	8	10.2	F	230	0.30	EEEHC0J331P	(5)	500
	1000	10	10.2	G	313	0.50	EEEHC0J102P	(5)	500
10	33	5	5.8	C	43	0.26	EEEHC1A330R	(4)	1000
	220	8	10.2	F	160	0.26	EEEHC1A221P	(5)	500
16	10	4	5.8	B	28	0.2	EEEHC1C100R	(4)	2000
	22	5	5.8	C	39	0.2	EEEHC1C220R	(4)	1000
	47	6.3	5.8	D	70	0.2	EEEHC1C470P	(4)	1000
	100	6.3	7.7	D8	81	0.2	EEEHC1C101XP	(4)	900
	470	10	10.2	G	340	0.2	EEEHC1C471P	(5)	500
25	33	6.3	5.8	D	65	0.16	EEEHC1E330P	(4)	1000
	47	6.3	7.7	D8	65	0.16	EEEHC1E470XP	(4)	900
	100	8	10.2	F	130	0.16	EEEHC1E101P	(5)	500
	330	10	10.2	G	238	0.16	EEEHC1E331P	(5)	500
35	4.7	4.0	5.8	B	15	0.14	EEEHC1V4R7R	(4)	2000
	10	5.0	5.8	C	28	0.14	EEEHC1V100R	(4)	1000
	22	6.3	5.8	D	55	0.14	EEEHC1V220P	(4)	1000
	33	6.3	7.7	D8	57	0.14	EEEHC1V330XP	(4)	900
	220	10	10.2	G	220	0.14	EEEHC1V221P	(5)	500
50	0.1	4	5.8	B	1	0.12	EEEHC1HR10R	(4)	2000
	0.22	4	5.8	B	2.6	0.12	EEEHC1HR22R	(4)	2000
	0.33	4	5.8	B	3.2	0.12	EEEHC1HR33R	(4)	2000
	0.47	4	5.8	B	5	0.12	EEEHC1HR47R	(4)	2000
	1	4	5.8	B	10	0.12	EEEHC1H1R0R	(4)	2000
	2.2	4	5.8	B	16	0.12	EEEHC1H2R2R	(4)	2000
	3.3	4	5.8	B	16	0.12	EEEHC1H3R3R	(4)	2000
	4.7	5	5.8	C	23	0.12	EEEHC1H4R7R	(4)	1000
	10	6.3	5.8	D	35	0.12	EEEHC1H100P	(4)	1000
	22	6.3	7.7	D8	49	0.12	EEEHC1H220XP	(4)	900
	33	8	10.2	F	91	0.12	EEEHC1H330P	(5)	500
	47	8	10.2	F	100	0.12	EEEHC1H470P	(5)	500
	100	10	10.2	G	160	0.12	EEEHC1H101P	(5)	500

An explanation of the taping dimensions can be found on page 84.

Reflow profiles can be found on page 86.

■ Frequency Correction Factor of Rated Ripple Current

	Frequency (Hz)			
	50,60	120	1k	10k ~
coefficient	0.70	1.0	1.3	1.7

■ Endurance

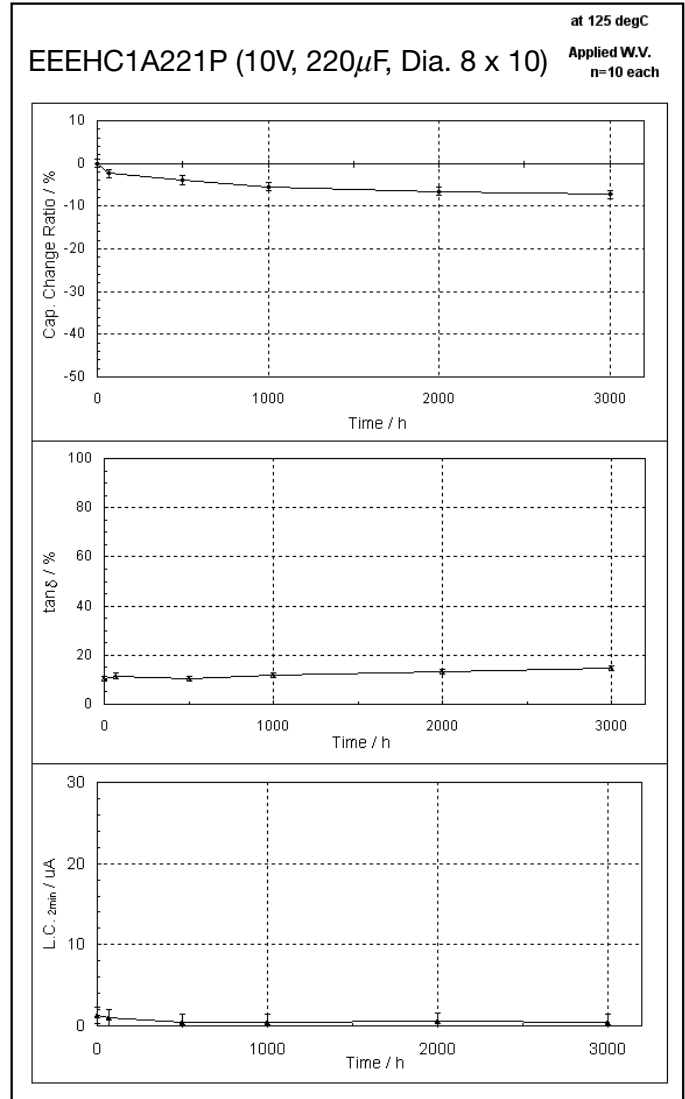
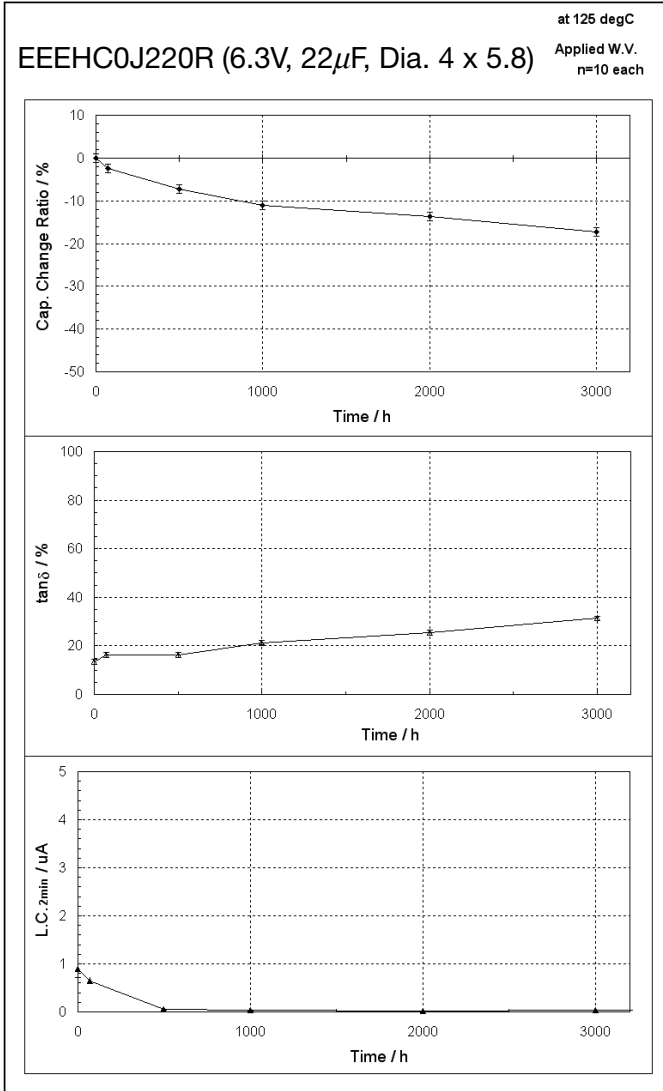

■ Temperature Characteristics

EEEHC0J220R (6.3V, 22 μ F, Dia. 4 x 5.8)

at 120Hz
n = 3

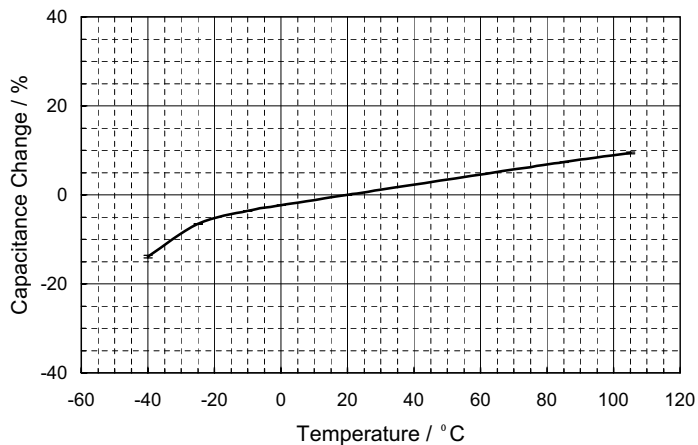

EEEHC1A221P (10V, 220 μ F, Dia. 8 x 10)

at 120Hz
n = 3

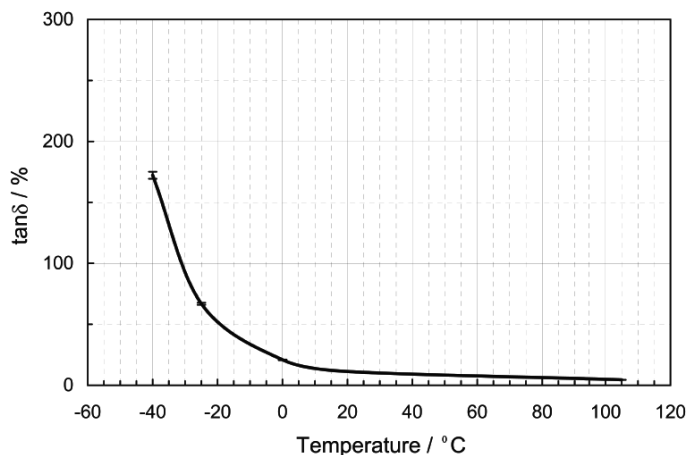
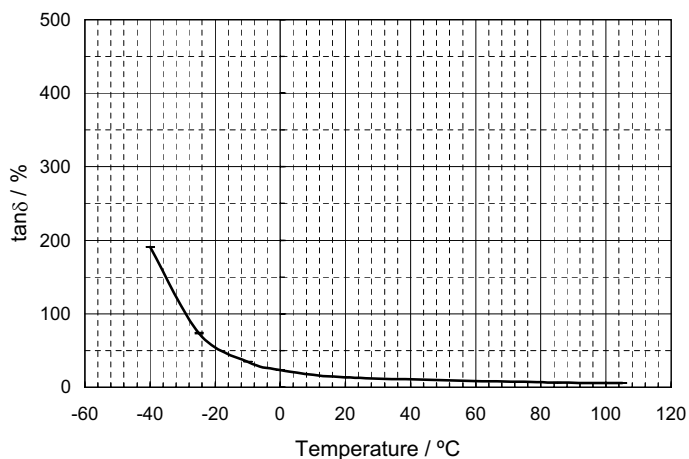
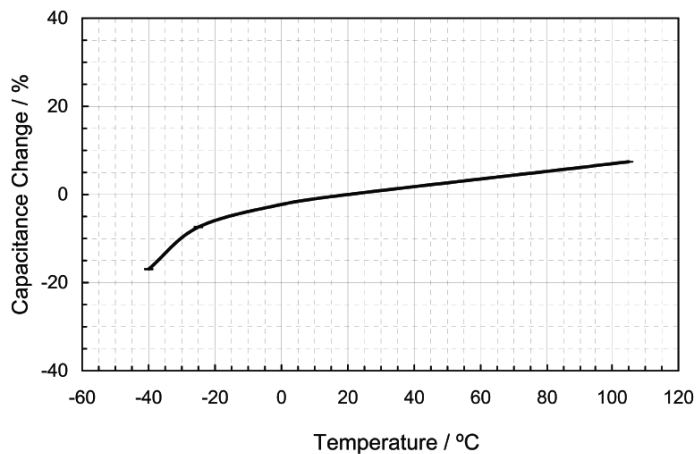

■ Frequency Characteristics

EEEHC0J220R (6.3V, 22 μ F, Dia. 4 x 5.8)

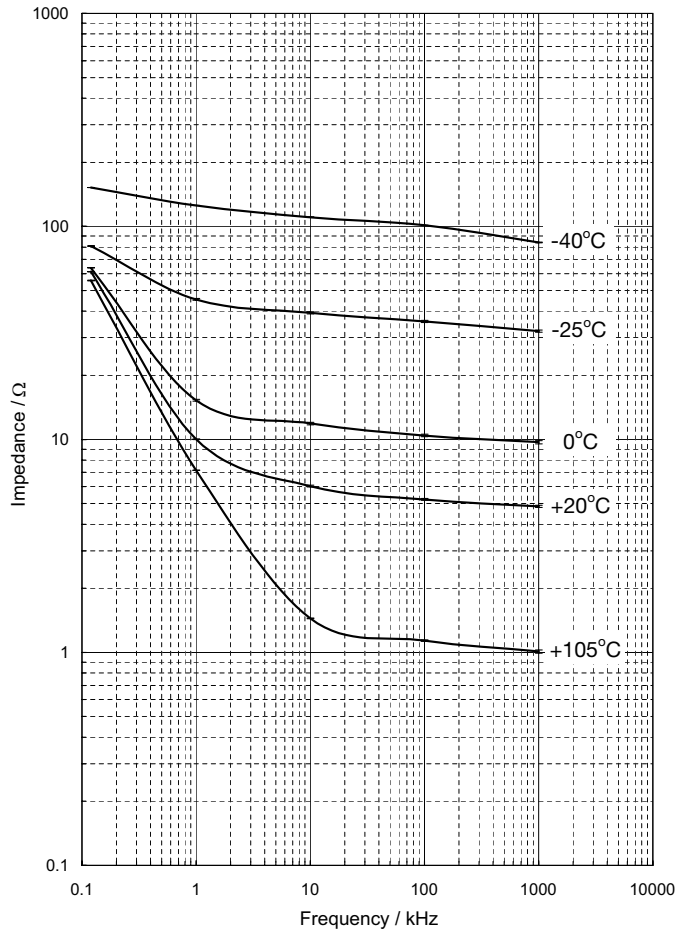

EEEHC1A221P (10V, 220 μ F, Dia. 8 x 10)

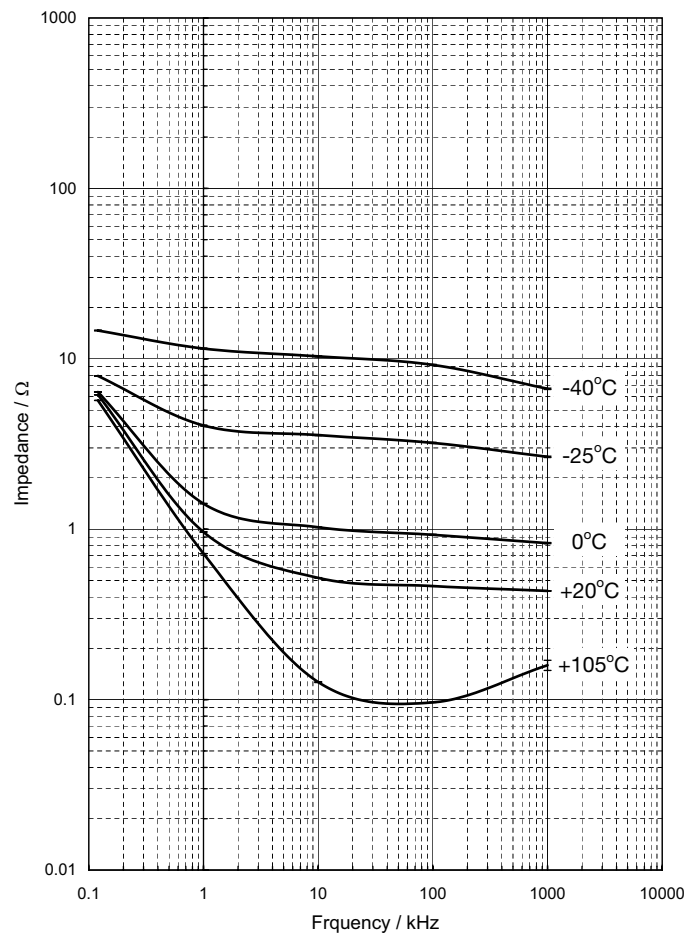

Surface Mount Type

Series: HD Type : V

- Features Endurance: 5000h at 105°C
Vibration-proof product is available upon request.(φ8 ≤)
RoHS directive not compliant



■ Specifications

Category temp. range	-40 to +105°C								
Rated W.V. Range	10 to 100V .DC								
Nominal Cap. Range	0.47 to 330 μF								
Capacitance Tolerance	±20 % (120Hz/+20°C)								
DC Leakage Current	I ≤ 0.01CV or 3(μA) After 2 minutes application of rated working voltage at +20°C. (Whichever is greater)								
tan δ	Please see the attached standard products list								
Characteristics at Low Temperature	W.V. (V)	10	16	25	35	50	63	100	(Impedance ratio at 120 Hz)
	Z(-25°C) / Z(+20°C)	8	5	4	3	3	3	3	
	Z(-40°C) / Z(+20°C)	14	12	10	8	8	8	8	
Endurance	After applying rated working voltage for 5000 hours at +105±2°C and then being stabilized at +20°C, capacitors shall meet the following limits.								
	Capacitance change	±30% of initial measured value							
	tan δ	≤ 300 % of initial specified value							
Shelf Life	After storage for 1000 hours at +105±2 °C with no voltage applied and then being stabilized at +20°C, capacitors shall meet the limits specified in Endurance (With voltage treatment)								
	Capacitance change	±20% of initial measured value							
	tan δ	≤ 200 % of initial specified value							
Resistance to Soldering Heat	After reflow soldering (Refer to page 86 for recommended temperature profile.) and then being stabilized at +20°C, capacitor shall meet the following limits.								
	Capacitance change	±10% of initial measured value							
	tan δ	≤ initial specified value							
DC leakage current	≤ initial specified value								

■ Marking

Example. 16V10μF

Marking color : BLACK

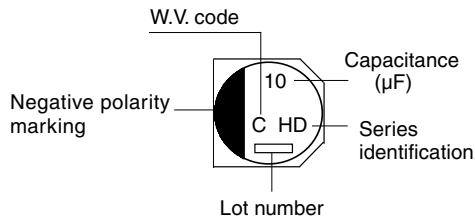

W.V. code

V	10	16	25	35
Code	A	C	E	V

V	50	63	100
Code	H	J	2A

■ Dimensions in mm (not to scale)

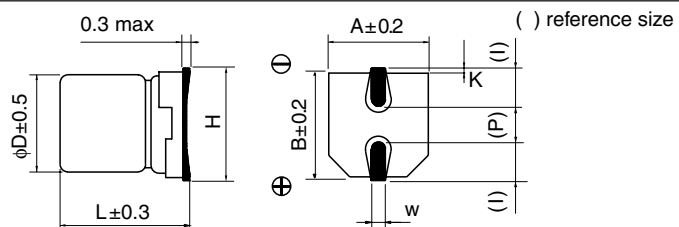

Size code	D	L	A,B	H max.	I	W	P	K
B	4.0	5.8	4.3	5.5	1.8	0.65±0.1	1.0	0.35 -0.20 to +0.15
C	5.0	5.8	5.3	6.5	2.2	0.65±0.1	1.5	0.35 -0.20 to +0.15
D	6.3	5.8	6.6	7.8	2.6	0.65±0.1	1.8	0.35 -0.20 to +0.15
E	8.0	6.2	8.3	9.5	3.4	0.65±0.1	2.2	0.35 -0.20 to +0.15
F	8.0	10.2	8.3	10.0	3.4	0.90±0.2	3.1	0.70 ±0.20
G	10.0	10.2	10.3	12.0	3.5	0.90±0.2	4.6	0.70 ±0.20

■ Case Size

Cap.(μF) \ W.V.	10(1A)	16(1C)	25(1E)	35(1V)	50(1H)	63(1J)	100(2A)
0.47					B		
1.0					B		
2.2					B		
3.3					B		E
4.7			B	B	C		F
10		B	C	C	D	E	F
22		C	D	D	E	F	G
33			D	E	F	G	
47		D	E	F	G		
100	E	F	F	G			
220	F	G		G			
330	G		G				

■ Standard Products

W.V. (V)	Cap. (±20%) (μF)	Case size			Specification			Part No. (RoHS: not compliant)	Min. Packaging Q'ty	
		Dia. (mm)	Length (mm)	Size Code	Ripple Current (120Hz) (+105°C) (mA)	Impedance (100kHz) (+20°C) (Ω)	tan δ (120Hz) (+20°C)		Reflow	Taping (pcs)
10	100	8	6.2	E	62	2.0	0.30	EEVHD1A101P	(2)	1000
	220	8	10.2	F	93	1.5	0.30	EEVHD1A221P	(2)	500
	330	10	10.2	G	118	0.8	0.30	EEVHD1A331P	(2)	500
16	10	4	5.8	B	20	12.0	0.20	EEVHD1C100R	(1)	2000
	22	5	5.8	C	33	7.2	0.20	EEVHD1C220R	(1)	1000
	47	6.3	5.8	D	55	4.0	0.20	EEVHD1C470P	(1)	1000
	100	8	10.2	F	89	1.5	0.23	EEVHD1C101P	(2)	500
25	220	10	10.2	G	113	0.8	0.23	EEVHD1C221P	(2)	500
	4.7	4	5.8	B	15	12.0	0.16	EEVHD1E4R7R	(1)	2000
	10	5	5.8	C	26	7.2	0.16	EEVHD1E100R	(1)	1000
	22	6.3	5.8	D	42	4.0	0.16	EEVHD1E220P	(1)	1000
	33	6.3	5.8	D	52	4.0	0.16	EEVHD1E330P	(1)	1000
	47	8	6.2	E	56	2.0	0.18	EEVHD1E470P	(2)	1000
	100	8	10.2	F	84	1.5	0.18	EEVHD1E101P	(2)	500
35	330	10	10.2	G	112	0.8	0.18	EEVHD1E331P	(2)	500
	4.7	4	5.8	B	17	12.0	0.13	EEVHD1V4R7R	(1)	2000
	10	5	5.8	C	28	7.2	0.13	EEVHD1V100R	(1)	1000
	22	6.3	5.8	D	47	4.0	0.13	EEVHD1V220P	(1)	1000
	33	8	6.2	E	53	2.0	0.16	EEVHD1V330P	(2)	1000
	47	8	10.2	F	79	1.5	0.16	EEVHD1V470P	(2)	500
	100	10	10.2	G	101	0.8	0.16	EEVHD1V101P	(2)	500
50	220	10	10.2	G	106	0.8	0.16	EEVHD1V221P	(2)	500
	0.47	4	5.8	B	5	12.0	0.12	EEVHD1HR47R	(1)	2000
	1.0	4	5.8	B	7	12.0	0.12	EEVHD1H1R0R	(1)	2000
	2.2	4	5.8	B	12	12.0	0.12	EEVHD1H2R2R	(1)	2000
	3.3	4	5.8	B	16	12.0	0.12	EEVHD1H3R3R	(1)	2000
	4.7	5	5.8	C	21	7.2	0.12	EEVHD1H4R7R	(1)	1000
	10	6.3	5.8	D	33	4.0	0.12	EEVHD1H100P	(1)	1000
	22	8	6.2	E	50	2.0	0.14	EEVHD1H220P	(2)	1000
	33	8	10.2	F	74	1.5	0.14	EEVHD1H330P	(2)	500
63	47	10	10.2	G	94	0.8	0.14	EEVHD1H470P	(2)	500
	10	8	6.2	E	45	2.0	0.18	EEVHD1J100P	(2)	1000
	22	8	10.2	F	65	1.5	0.18	EEVHD1J220P	(2)	500
100	33	10	10.2	G	80	0.8	0.18	EEVHD1J330P	(2)	500
	3.3	8	6.2	E	30	2.0	0.18	EEVHD2A3R3P	(2)	1000
	4.7	8	10.2	F	50	1.5	0.18	EEVHD2A4R7P	(2)	500
	10	8	10.2	F	55	1.5	0.18	EEVHD2A100P	(2)	500
	22	10	10.2	G	70	0.8	0.18	EEVHD2A220P	(2)	500

An explanation of the taping dimensions can be found on page 84.

Reflow profiles can be found on page 86.

Endurance: 105°C 5000h

■ Frequency Correction Factor of Rated Ripple Current

coefficient	Frequency (Hz)			
	50 ≤ f < 100	100 ≤ f < 1k	1k ≤ f < 10k	10k ≤ f
	0.70	1.0	1.3	1.7

■ Endurance

- EEVHD1V4R7R (35V4.7 μ F, ϕ 4x5.8)
- ◇ EEVHD1V220P (35V22 μ F, ϕ 6.3x5.8)
- △ EEVHD1V101P (35V100 μ F, ϕ 10x10.2)

at 105°C

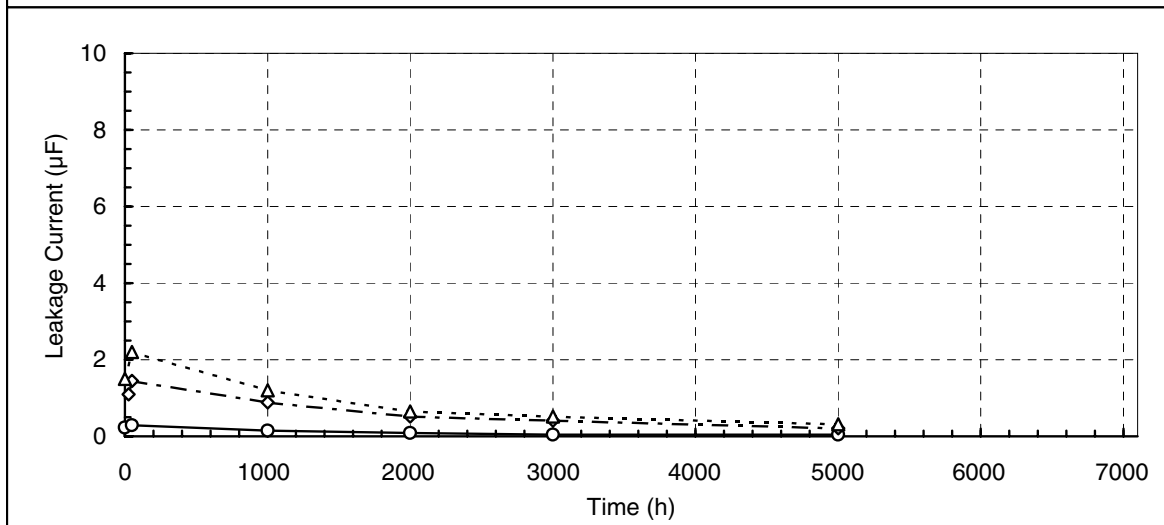
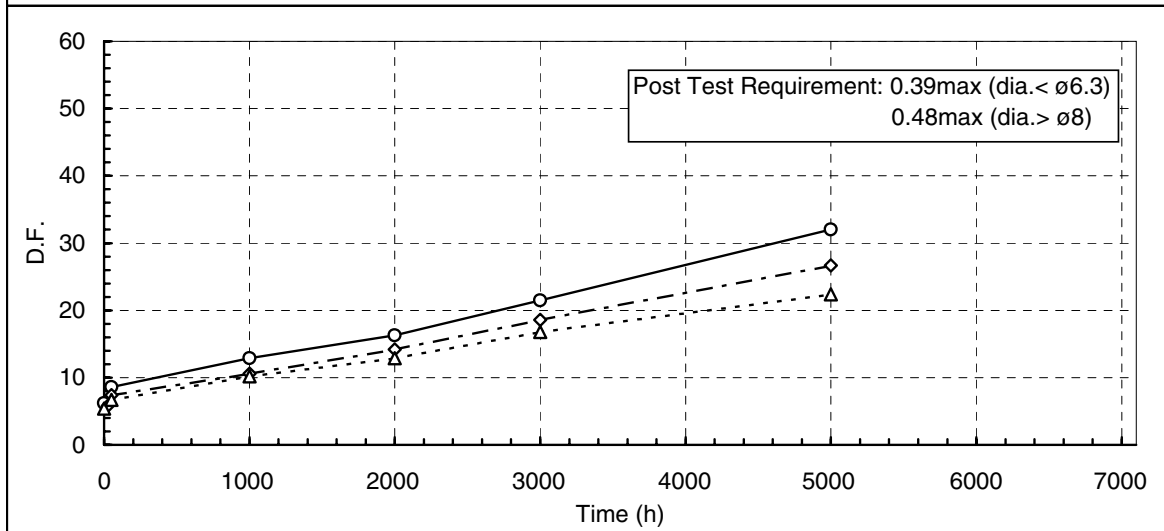
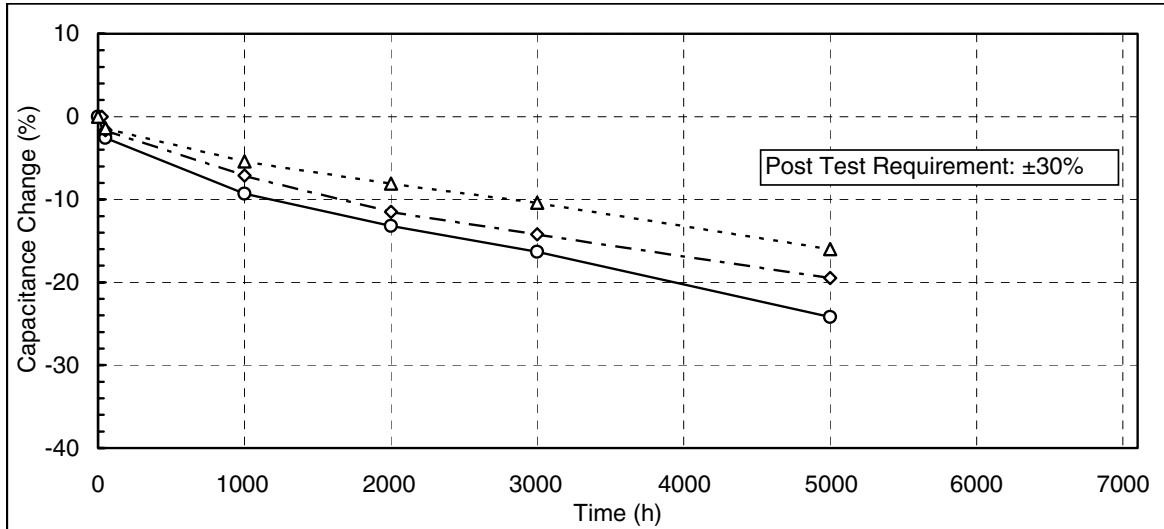

Temperature Characteristics

● Diameter $\phi 8 \times 6.2$

○ Capacitance

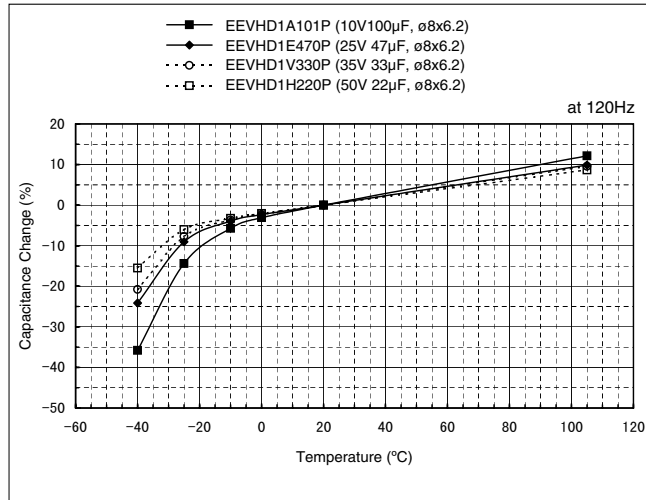

● Diameter $\phi 10 \times 10.2$

○ Capacitance

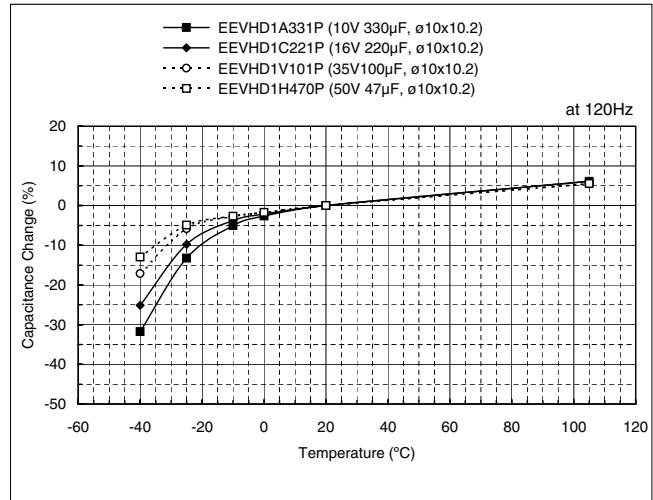

○ D.F.

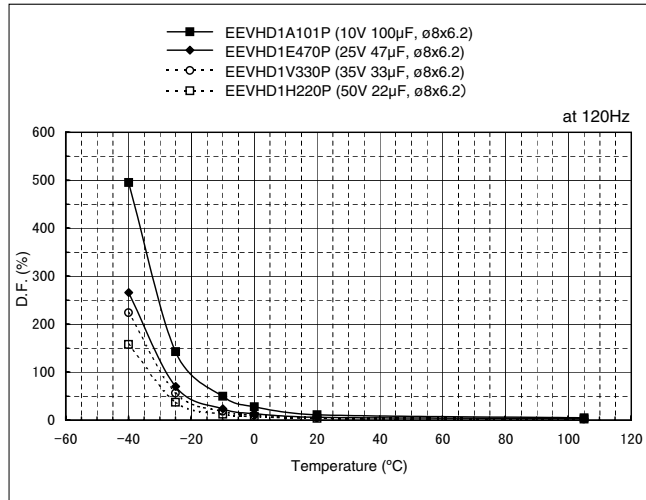

○ D.F.

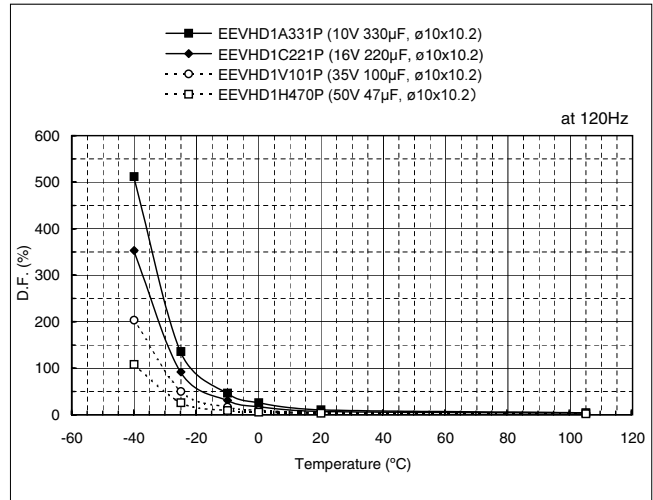

Temperature Characteristics – ESR

● 16V

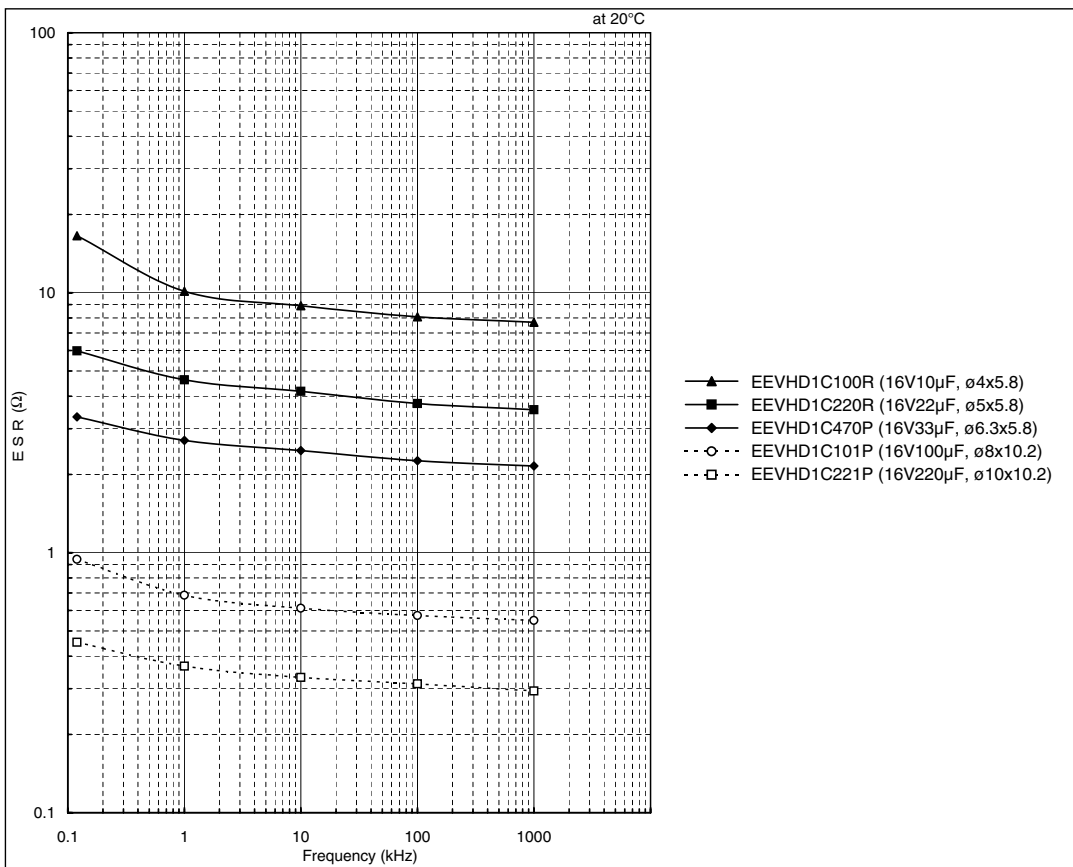

● 35V

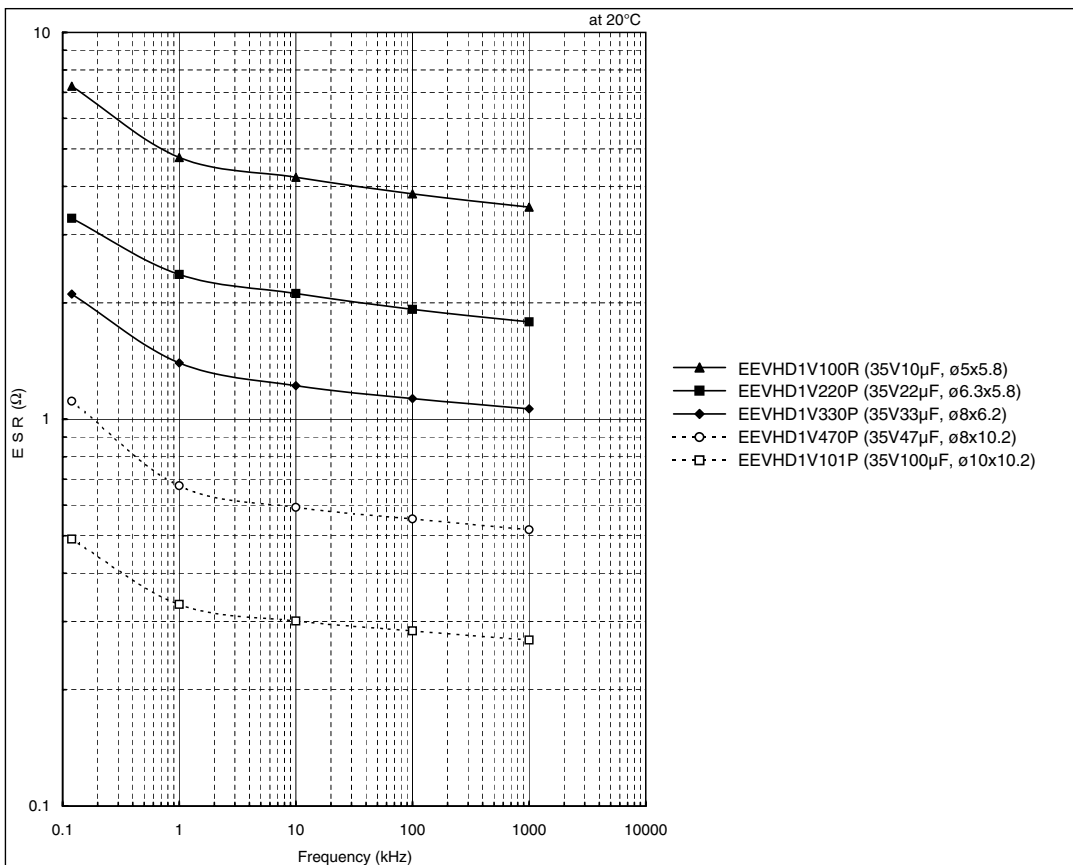

Temperature Characteristics

● EEVHD1V100R (35V 10 μ F, ϕ 5x5.8)

○ Impedance

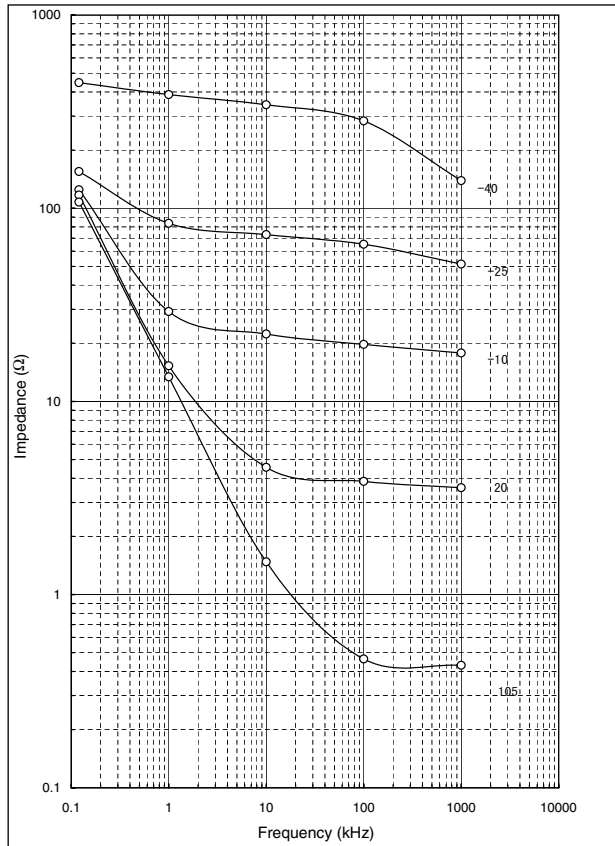

● EEVHD1V101P (35V 100 μ F, ϕ 10x10.2)

○ Impedance

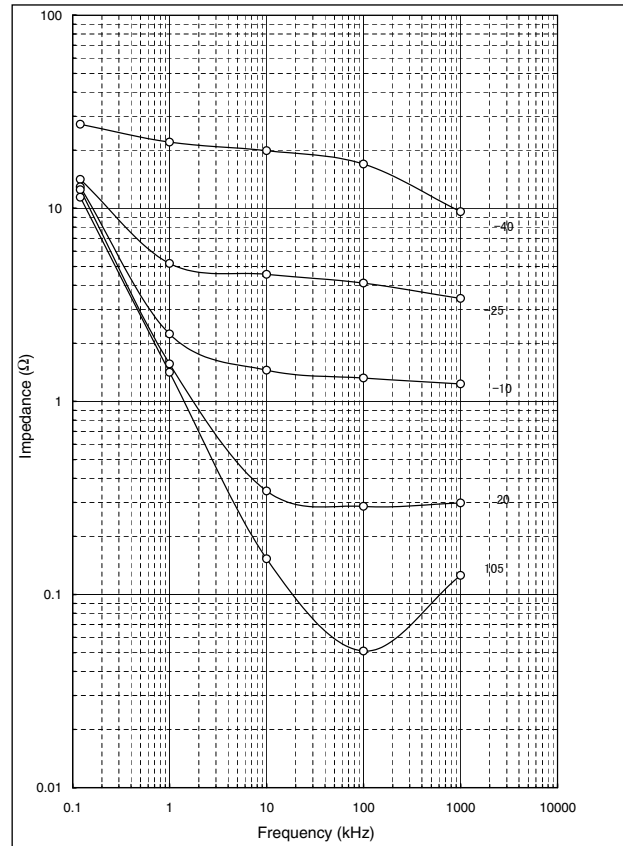

○ ESR

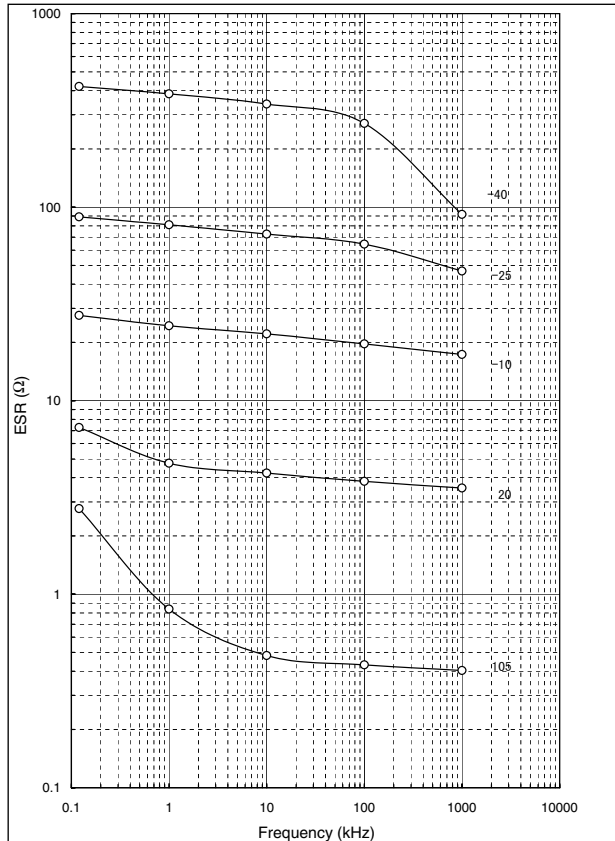

○ ESR

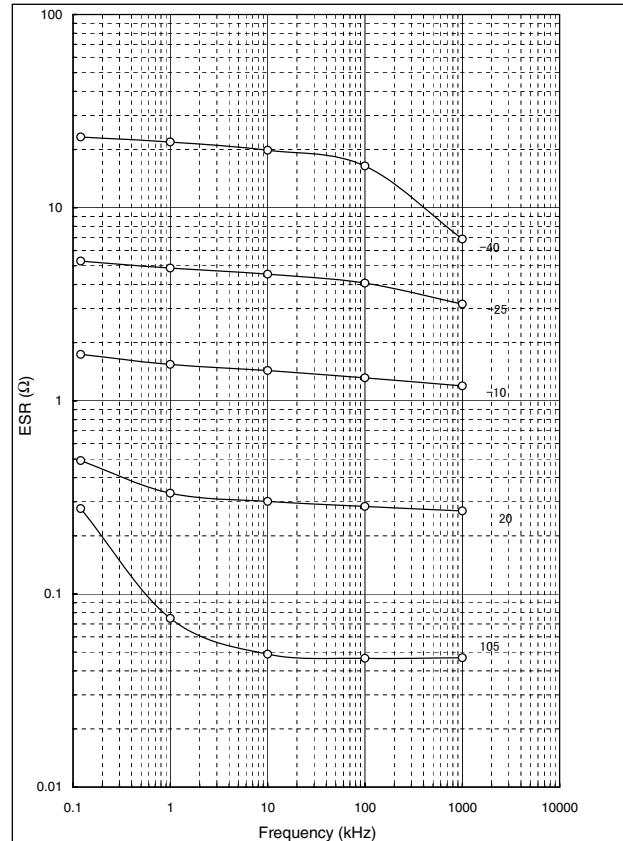

Surface Mount Type

Series: FC Type : V

- Features
 - Endurance : 105°C 1000 h
 - Low impedance (1/2 for HA series)
 - 5.4 mm height ($\leq \phi 6.3$)
 - Vibration-proof product is available upon request. ($\phi 8 \leq$)
 - RoHS directive compliant(Parts No:EEE*)



■ Specifications

Category temp. range	-40 to +105°C							
Rated W.V. Range	6.3 to 50 V .DC							
Nominal Cap. Range	1 to 1500 μ F							
Capacitance Tolerance	$\pm 20\%$ (120Hz/+20°C)							
DC Leakage Current	$I \leq 0.01 CV$ or $3(\mu A)$ after 2 minutes (Whichever is greater)							
tan δ	W.V. (V)	6.3	10	16	25	35	50	(120Hz/+20°C) (max.)
	tan δ	0.26	0.19	0.16	0.14	0.12	0.12	
Characteristics at Low Temperature	W.V. (V)	6.3	10	16	25	35	50	(Impedance ratio at 120 Hz)
	-25 / +20 °C	2	2	2	2	2	2	
	-40 / +20 °C	3	3	3	3	3	3	
Endurance	After applying rated working voltage for 1000 hours at +105 \pm 2°C and then being stabilized at +20°C, capacitors shall meet the following limits.							
	Capacitance change	$\pm 20\%$ of initial measured value						
	tan δ	$\leq 200\%$ of initial specified value						
	DC leakage current	\leq initial specified value						
Shelf Life	After storage for 1000 hours at +105 \pm 2°C with no voltage applied and then being stabilized at +20°C, capacitors shall meet the limits specified in Endurance.(With voltage treatment)							
	After reflow soldering (Refer to page 86 for recommended temperature profile), and then being stabilized at +20°C, capacitor shall meet the following limits.							
Resistance to Soldering Heat	After reflow soldering (Refer to page 86 for recommended temperature profile), and then being stabilized at +20°C, capacitor shall meet the following limits.							
	Capacitance change	$\pm 10\%$ of initial measured value						
	tan δ	\leq initial specified value						
	DC leakage current	\leq initial specified value						

■ Marking

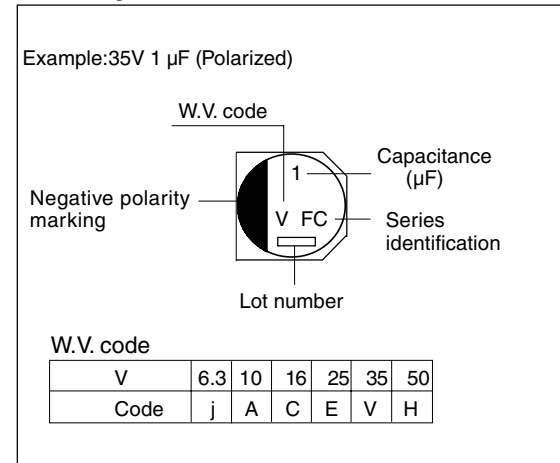

■ Dimensions in mm (not to scale)

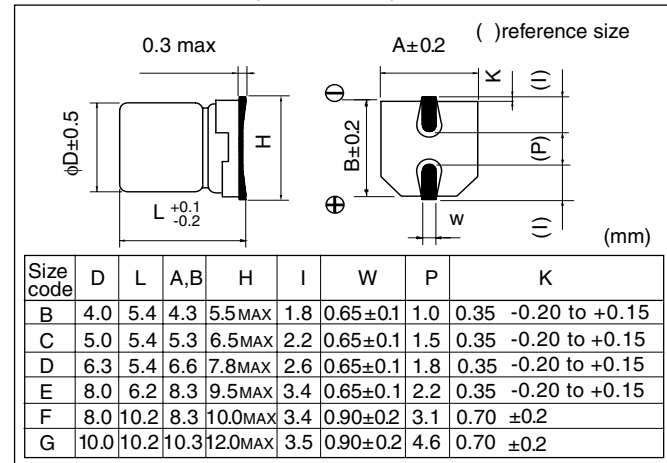

■ Case size

Cap. (μ F)	W.V.(V)	6.3 (0J)	10 (1A)	16 (1C)	25 (1E)	35 (1V)	50(1H)
1 to 3.3						B	B
4.7						B	C
6.8					B	C	
10				B		C	D
22	B		C	D		D	E
33		C		D		E	F
47	C		D	E		E	G
68	D		E	F			
100	D	E	E	F		G	G
150		E					
220	E	F	G	G		G	G
330	F		G	G		G	
470		G	G	G			
680			G				
1000	G	G					
1500	G						

■ Impedance (Ω) (100kHz/+20°C)

(6.3 to 35W.V)

Size Code	B	C	D	E	F	G
Impedance	3.0	1.8	1.0	0.4	0.3	0.15

(50W.V)

Size Code	B	C	D	E	F	G
Impedance	5.0	3.0	2.0	0.7	0.6	0.3

■ Standard Products

W.V. (V)	Cap. (±20%) (μF)	Case size			Specification		Part No. (RoHS: not compliant)		Part No. (RoHS: compliant)		Min. Packaging Q'ty Taping (pcs)
		Dia. (mm)	Length (mm)	Size Code	Ripple current (100kHz) (+105°C) (mA)	Impe- dance (100kHz) (+20°C) (Ω)	Reflow	Reflow			
6.3	22	4	5.4	B	60	3.00	EEVFC0J220R	(1)	EEEF0J220R	(4)	2000
	47	5	5.4	C	95	1.80	EEVFC0J470R	(1)	EEEF0J470R	(4)	1000
	68	6.3	5.4	D	140	1.00	EEVFC0J680P	(1)	EEEF0J680P	(4)	1000
	100	6.3	5.4	D	140	1.00	EEVFC0J101P	(1)	EEEF0J101P	(4)	1000
	220	8	6.2	E	230	0.40	EEVFC0J221P	(2)	EEEF0J221P	(5)	1000
	330	8	10.2	F	450	0.30	EEVFC0J331P	(2)	EEEF0J331P	(5)	500
	1000	10	10.2	G	670	0.15	EEVFC0J102P	(2)	EEEF0J102P	(5)	500
	1500	10	10.2	G	670	0.15	EEVFC0J152P	(2)	EEEF0J152P	(5)	500
10	33	5	5.4	C	95	1.80	EEVFC1A330R	(1)	EEEF1A330R	(4)	1000
	100	8	6.2	E	230	0.40	EEVFC1A101P	(2)	EEEF1A101P	(5)	1000
	150	8	6.2	E	230	0.40	EEVFC1A151P	(2)	EEEF1A151P	(5)	1000
	220	8	10.2	F	450	0.30	EEVFC1A221P	(2)	EEEF1A221P	(5)	500
	470	10	10.2	G	670	0.15	EEVFC1A471P	(2)	EEEF1A471P	(5)	500
	1000	10	10.2	G	670	0.15	EEVFC1A102P	(2)	EEEF1A102P	(5)	500
16	10	4	5.4	B	60	3.00	EEVFC1C100R	(1)	EEEF1C100R	(4)	2000
	22	5	5.4	C	95	1.80	EEVFC1C220R	(1)	EEEF1C220R	(4)	1000
	47	6.3	5.4	D	140	1.00	EEVFC1C470P	(1)	EEEF1C470P	(4)	1000
	68	8	6.2	E	230	0.40	EEVFC1C680P	(2)	EEEF1C680P	(5)	1000
	100	8	6.2	E	230	0.40	EEVFC1C101P	(2)	EEEF1C101P	(5)	1000
	220	10	10.2	G	670	0.15	EEVFC1C221P	(2)	EEEF1C221P	(5)	500
	330	10	10.2	G	670	0.15	EEVFC1C331P	(2)	EEEF1C331P	(5)	500
	470	10	10.2	G	670	0.15	EEVFC1C471P	(2)	EEEF1C471P	(5)	500
25	6.8	4	5.4	B	60	3.00	EEVFC1E6R8R	(1)	EEEF1E6R8R	(4)	2000
	22	6.3	5.4	D	140	1.00	EEVFC1E220P	(1)	EEEF1E220P	(4)	1000
	33	6.3	5.4	D	140	1.00	EEVFC1E330P	(1)	EEEF1E330P	(4)	1000
	47	8	6.2	E	230	0.40	EEVFC1E470P	(2)	EEEF1E470P	(5)	1000
	68	8	10.2	F	450	0.30	EEVFC1E680P	(2)	EEEF1E680P	(5)	500
	100	8	10.2	F	450	0.30	EEVFC1E101P	(2)	EEEF1E101P	(5)	500
	220	10	10.2	G	670	0.15	EEVFC1E221P	(2)	EEEF1E221P	(5)	500
	330	10	10.2	G	670	0.15	EEVFC1E331P	(2)	EEEF1E331P	(5)	500
35	470	10	10.2	G	670	0.15	EEVFC1E471P	(2)	EEEF1E471P	(5)	500
	1	4	5.4	B	60	3.00	EEVFC1V1R0R	(1)	EEEF1V1R0R	(4)	2000
	2.2	4	5.4	B	60	3.00	EEVFC1V2R2R	(1)	EEEF1V2R2R	(4)	2000
	3.3	4	5.4	B	60	3.00	EEVFC1V3R3R	(1)	EEEF1V3R3R	(4)	2000
	4.7	4	5.4	B	60	3.00	EEVFC1V4R7R	(1)	EEEF1V4R7R	(4)	2000
	6.8	5	5.4	C	95	1.80	EEVFC1V6R8R	(1)	EEEF1V6R8R	(4)	1000
	10	5	5.4	C	95	1.80	EEVFC1V100R	(1)	EEEF1V100R	(4)	1000
	22	6.3	5.4	D	140	1.00	EEVFC1V220P	(1)	EEEF1V220P	(4)	1000
	33	8	6.2	E	230	0.40	EEVFC1V330P	(2)	EEEF1V330P	(5)	1000
	47	8	6.2	E	230	0.40	EEVFC1V470P	(2)	EEEF1V470P	(5)	1000
100	10	10.2	G	670	0.15	EEVFC1V101P	(2)	EEEF1V101P	(5)	500	
220	10	10.2	G	670	0.15	EEVFC1V221P	(2)	EEEF1V221P	(5)	500	

An explanation of the taping dimensions can be found on page 84.

Reflow profiles can be found on page 86.

Endurance: 105°C 1000h

■ Standard Products

W.V. (V)	Cap. (±20%) (μF)	Case size			Specification		Part No. (RoHS: not compliant)	Reflow	Part No. (RoHS: compliant)	Reflow	Min. Packaging Q'ty Taping (pcs)
		Dia. (mm)	Length (mm)	Size Code	Ripple current (100kHz) (+105°C) (mA)	Impe- dance (100kHz) (+20°C) (Ω)					
35	330	10	10.2	G	670	0.15	EEVFC1V331P	(2)	EEEFC1V331P	(5)	500
50	1	4	5.4	B	30	5.00	EEVFC1H1R0R	(1)	EEEFC1H1R0R	(4)	2000
	2.2	4	5.4	B	30	5.00	EEVFC1H2R2R	(1)	EEEFC1H2R2R	(4)	2000
	3.3	4	5.4	B	30	5.00	EEVFC1H3R3R	(1)	EEEFC1H3R3R	(4)	2000
	4.7	5	5.4	C	50	3.00	EEVFC1H4R7R	(1)	EEEFC1H4R7R	(4)	1000
	10	6.3	5.4	D	70	2.00	EEVFC1H100P	(1)	EEEFC1H100P	(4)	1000
	22	8	6.2	E	120	0.70	EEVFC1H220P	(2)	EEEFC1H220P	(5)	1000
	33	8	10.2	F	300	0.60	EEVFC1H330P	(2)	EEEFC1H330P	(5)	500
	47	10	10.2	G	500	0.30	EEVFC1H470P	(2)	EEEFC1H470P	(5)	500
	100	10	10.2	G	500	0.30	EEVFC1H101P	(2)	EEEFC1H101P	(5)	500
	220	10	10.2	G	500	0.30	EEVFC1H221P	(2)	EEEFC1H221P	(5)	500

An explanation of the taping dimensions can be found on page 84.

Reflow profiles can be found on page 86.

Endurance: 105°C 1000h

■ Frequency Correction Factor of Rated Ripple Current

	Frequency (Hz)				
	50,60	120	1k	10k	100k~
coefficient	0.70	0.75	0.90	0.95	1.00

Temperature Characteristics

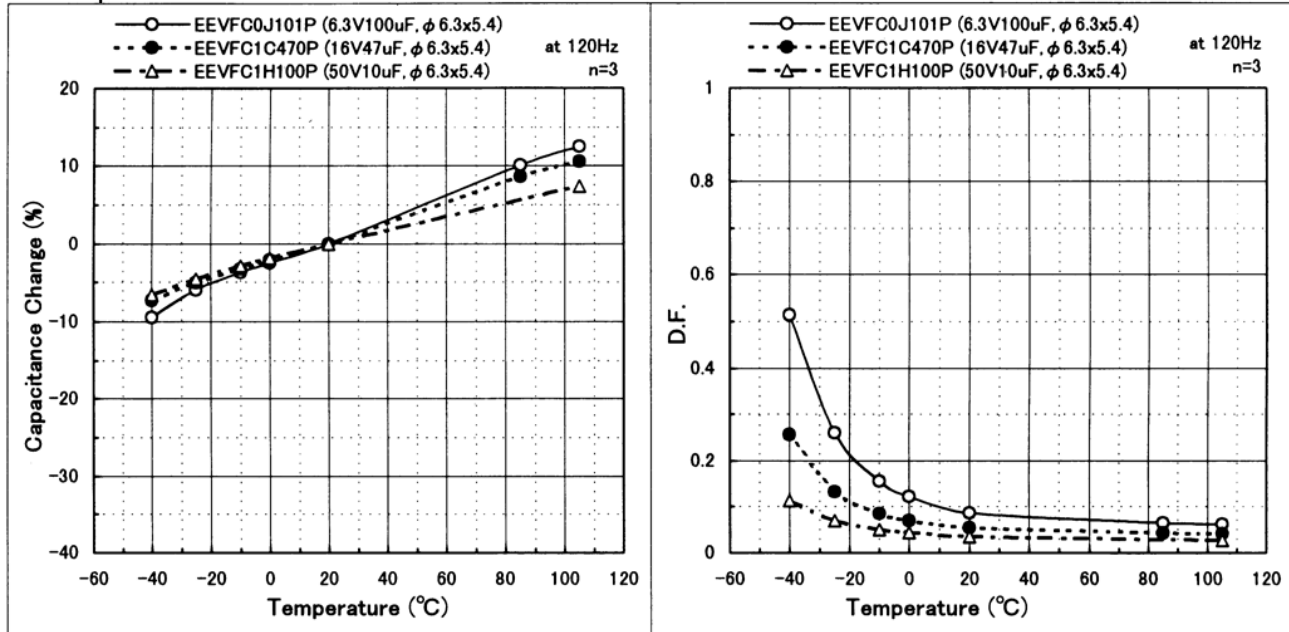

Endurance

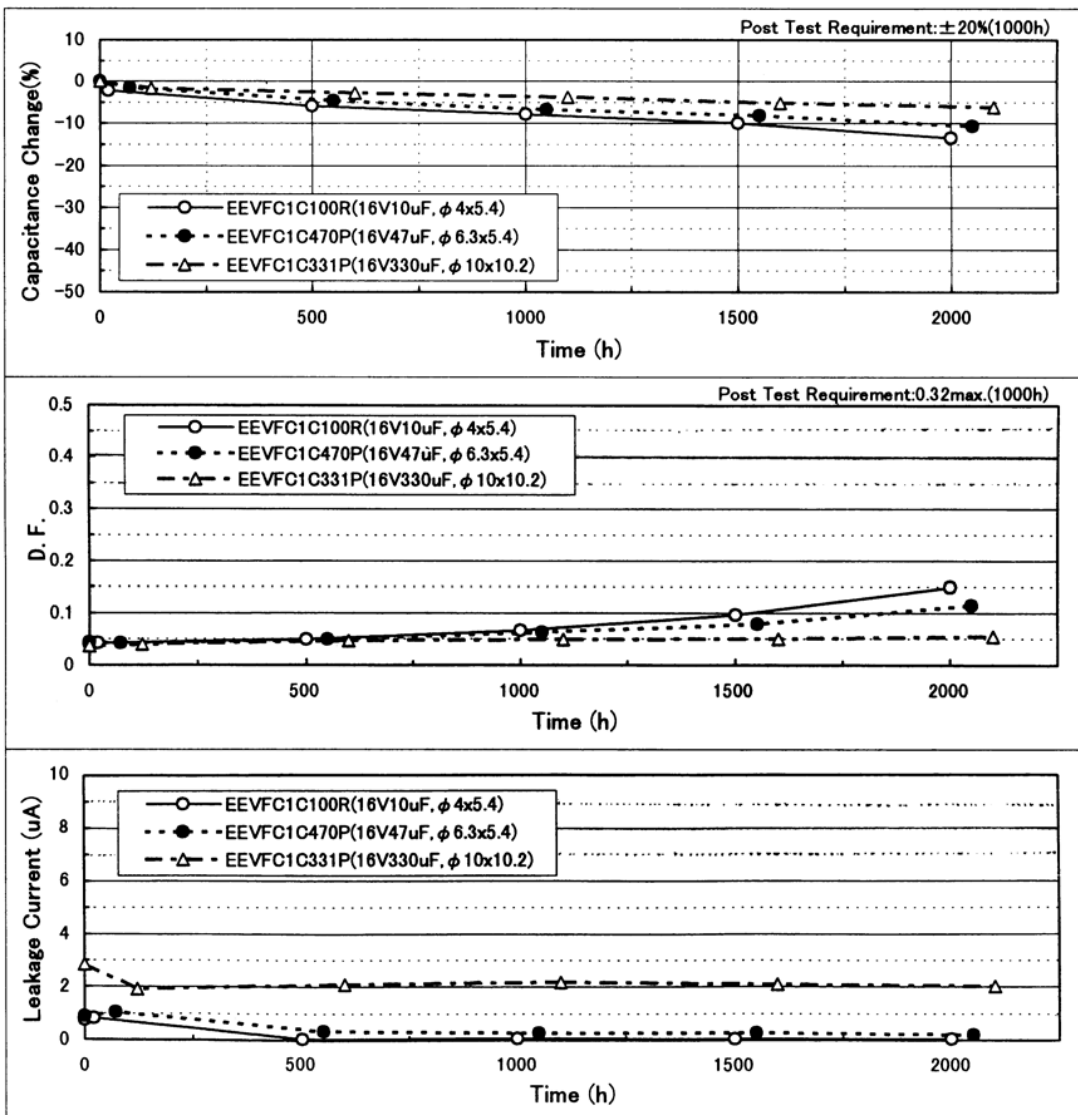

Frequency Characteristics

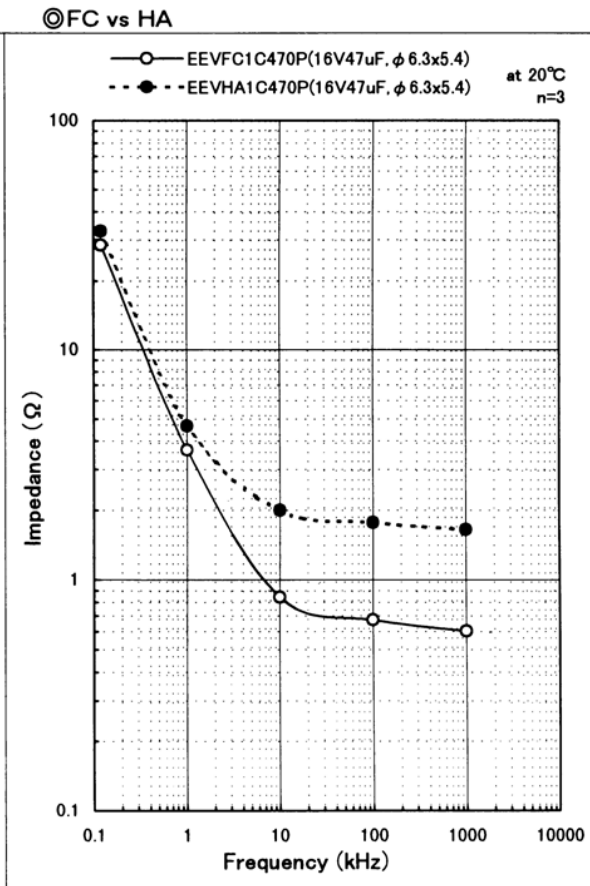
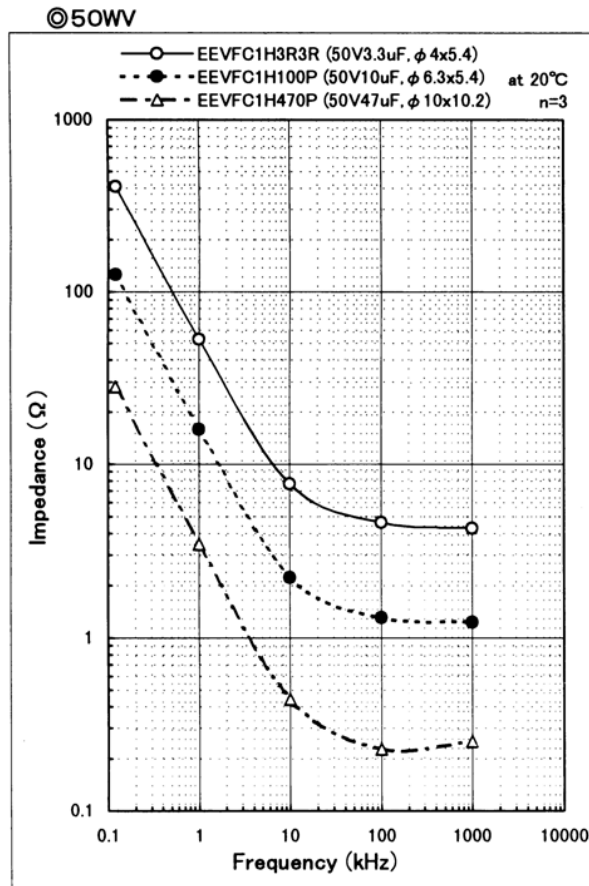
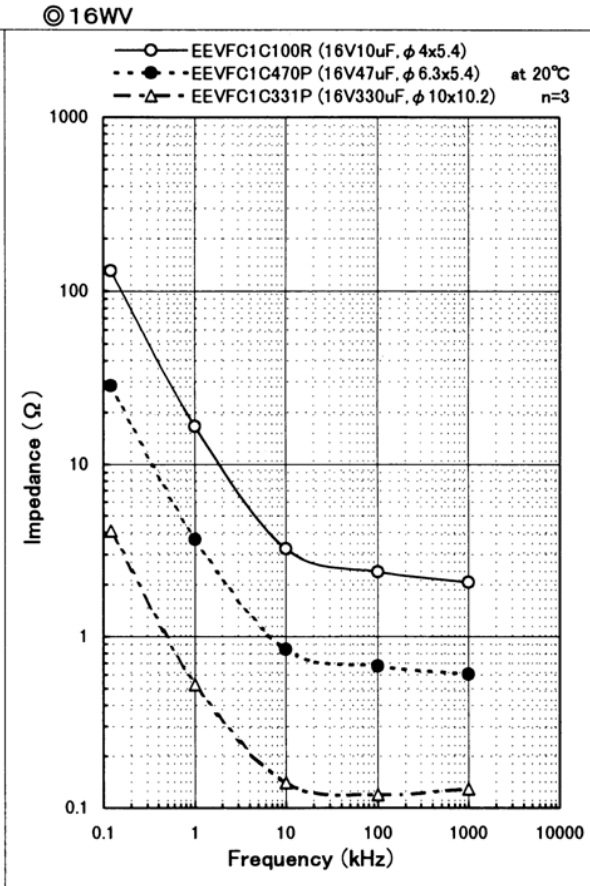
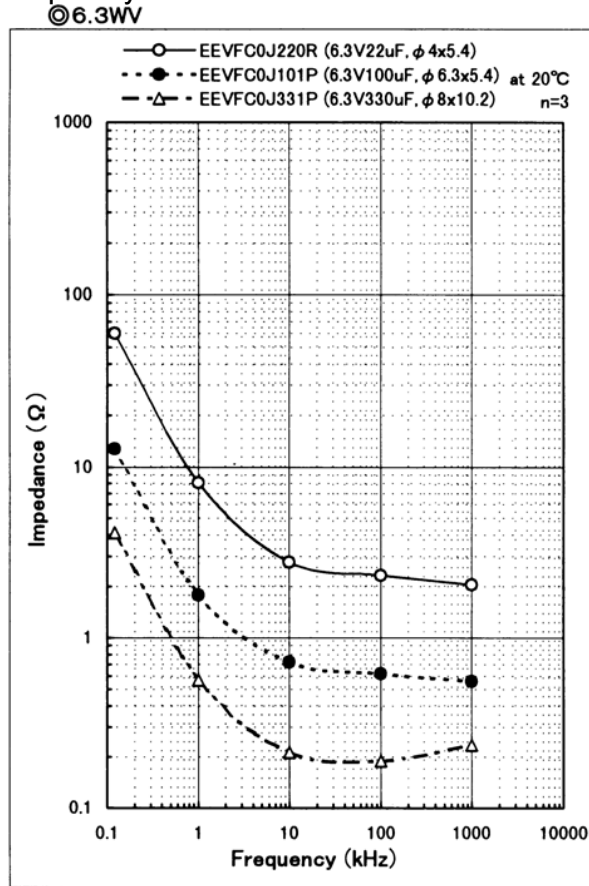

Temperature Characteristics

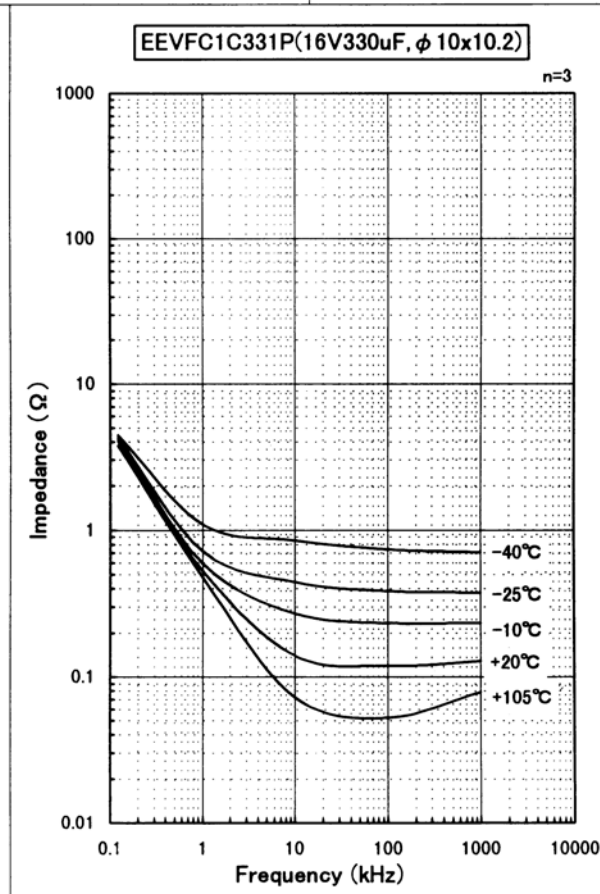
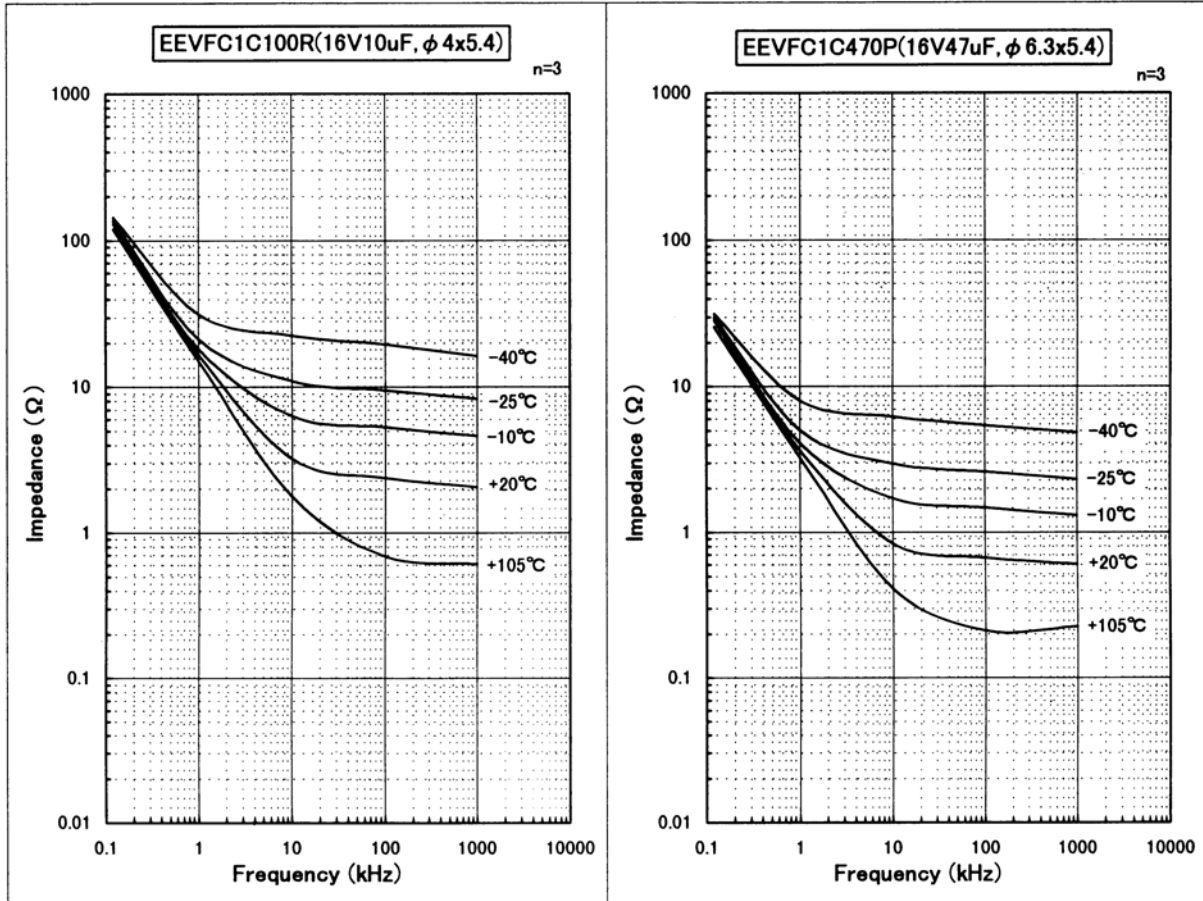

Surface Mount Type

Series: FK Type : V

- Features
 - Endurance: 2000 to 5000h at 105°C
 - Low impedance (40 to 60% less than FC series)
 - Miniaturized (30 to 50% less than FC series)
 - Vibration-proof product is available upon request. ($\phi 8 \leq$)
 - RoHS directive compliant (Parts No: EEV* $\phi 12.5 \leq$, EEE*)



■ Specifications

Category temp. range	-55 to +105°C										
Rated W.V. Range	6.3 to 100V .DC										
Nominal Cap. Range	3.3 to 6800 μ F										
Capacitance Tolerance	$\pm 20\%$ (120Hz/+20°C)										
DC Leakage Current	$I \leq 0.01 CV$ or $3(\mu A)$ After 2 minutes application of rated working voltage at +20°C. (Whichever is greater)										
tan δ	Please see the attached standard products list										
Characteristics at Low Temperature	W.V. (V)	6.3	10	16	25	35	50	63	80	100	(Impedance ratio at 120 Hz)
	Z(-25°C) / Z(+20°C)	2	2	2	2	2	2	2	2	2	
	Z(-40°C) / Z(+20°C)	3	3	3	3	3	3	3	3	3	
	Z(-55°C) / Z(+20°C)	4	4	4	3	3	3	3	3	3	
Endurance	After applying rated working voltage at +105 \pm 2°C for 2000 hours (\geq dia.12.5 and suffix "G" in dia.8 to 10 are 5000 hours) the capacitors shall meet the limits specified below. Post-test requirement at +20°C.										
	Capacitance change	$\pm 30\%$ of initial measured value (Suffix "G" is 35%)									
	tan δ	$\leq 200\%$ of initial specified value (Suffix "G" is 300%)									
	DC leakage current	\leq initial specified value									
Shelf Life	After storage for 1000 hours at +105 \pm 2°C with no voltage applied and then being stabilized at +20°C, capacitors shall meet the limits specified in Endurance (With voltage treatment)										
	After reflow soldering (Refer to page 86 for recommended temperature profile) and then being stabilized at +20°C, capacitor shall meet the following limits.										
Resistance to Soldering Heat	After reflow soldering (Refer to page 86 for recommended temperature profile) and then being stabilized at +20°C, capacitor shall meet the following limits.										
	Capacitance change	$\pm 10\%$ of initial measured value									
	tan δ	\leq initial specified value									
	DC leakage current	\leq initial specified value									

■ Marking

Example. 16V10 μ F
Marking color : BLACK

W.V. code

Negative polarity marking

Capacitance (μ F)

Series identification

Lot number

($\geq \phi 12.5$)

W.V. code

Negative polarity marking

Capacitance (μ F)

Series identification

Lot number

W.V. code

V	6.3	10	16	25	35
Code	j	A	C	E	V

V	50	63	80	100
Code	H	J	K	2A

■ Dimensions in mm (not to scale)

() reference size

Size code	D	L	A, B	H max.	I	W	P	K
B	4.0	5.8	4.3	5.5	1.8	0.65 \pm 0.1	1.0	0.35 -0.20 to +0.15
C	5.0	5.8	5.3	6.5	2.2	0.65 \pm 0.1	1.5	0.35 -0.20 to +0.15
D	6.3	5.8	6.6	7.8	2.6	0.65 \pm 0.1	1.8	0.35 -0.20 to +0.15
D8	6.3	7.7	6.6	7.8	2.6	0.65 \pm 0.1	1.8	0.35 -0.20 to +0.15
E	8.0	6.2	8.3	9.5	3.4	0.65 \pm 0.1	2.2	0.35 -0.20 to +0.15
F	8.0	10.2	8.3	10.0	3.4	0.90 \pm 0.2	3.1	0.70 \pm 0.20
G	10.0	10.2	10.3	12.0	3.5	0.90 \pm 0.2	4.6	0.70 \pm 0.20
H13	12.5	13.5	13.5	15.0	4.7	0.90 \pm 0.3	4.4	0.70 \pm 0.30
J16	16.0	16.5	17.0	19.0	5.5	1.20 \pm 0.3	6.7	0.70 \pm 0.30
K16	18.0	16.5	19.0	21.0	6.7	1.20 \pm 0.3	6.7	0.70 \pm 0.30

■ Case size VS Capacitance, Impedance and Ripple current

Impedance;(Ω /100kHz,+20°C),
Ripple current;(mA r.m.s./100kHz+105°C)

Capacitance (μ F)	W.V.	6.3			10			16		
		Size	Impedance	Ripple current	Size	Impedance	Ripple current	Size	Impedance	Ripple current
10							B	1.35	90	
22		B	1.35	90	B	1.35	90	C(B)	0.7(1.35)	160(90)
33					C(B)	0.7(1.35)	160(90)			
47		C(B)	0.7(1.35)	160(90)				D(C)	0.36(0.7)	240(160)
68							D	0.36	240	
100		D(C)	0.36(0.7)	240(160)			D	0.36	240	
150					D	0.36	240	D8	0.34	280
220		D	0.36	240	D8	0.34	280	D8	0.34	280
330		D8	0.34	280	E	0.26	300	E	0.26	300
		E	0.26	300	⊙F	0.16	600	⊙F	0.16	600
470		⊙F	0.16	600	⊙F	0.16	600	⊙F	0.16	600
680					⊙F	0.16	600	⊙G	0.08	850
1000		⊙F	0.16	600	⊙G	0.08	850			
1500		⊙G	0.08	850				H13	0.06	1100
2200					H13	0.06	1100			
3300		H13	0.06	1100				J16	0.035	1800
4700					J16	0.035	1800	K16	0.033	2060
6800		J16	0.035	1800	K16	0.033	2060			

Capacitance (μ F)	W.V.	25			35			50		
		Size	Impedance	Ripple current	Size	Impedance	Ripple current	Size	Impedance	Ripple current
4.7					B	1.35	90	B	2.9	60
10		B	1.35	90	C(B)	0.7(1.35)	160(90)	D(C)	0.88(1.52)	165(85)
22		C	0.7	160	C	0.7	160	D	0.88	165
33		D(C)	0.36(0.7)	240(160)	D	0.36	240	D8	0.68	195
								E	0.68	195
47		D	0.36	240	D	0.36	240	E(D8)	0.68	195
68		D	0.36	240	D8	0.34	280			
100		D8	0.34	280	D8	0.34	280	⊙F	0.34	350
		E	0.26	300	⊙F	0.16	600			
150		⊙F	0.16	600	⊙F	0.16	600	⊙G	0.18	670
220		⊙F	0.16	600	⊙F	0.16	600	⊙G	0.18	670
330		⊙F	0.16	600	⊙G	0.08	850	H13	0.12	900
390								H13	0.12	900
470		⊙G	0.08	850	H13	0.06	1100	J16	0.073	1610
680					H13	0.06	1100	J16	0.073	1610
1000		H13	0.06	1100	J16	0.035	1800	J16	0.073	1610
1500					J16	0.035	1800			
2200		J16	0.035	1800						
3300		K16	0.033	2060						

Capacitance (μ F)	W.V.	63			80			100		
		Size	Impedance	Ripple current	Size	Impedance	Ripple current	Size	Impedance	Ripple current
3.3					C	5	25			
4.7		C	3	50	D	3	40			
10		D	1.5	80	D8	2.4	60			
					E	2.4	60			
22		D8	1.2	120	F	1.3	130	F	1.3	130
		E	1.2	120	F	1.3	130			
33		F	0.65	250	F	1.3	130	G	0.7	200
47		F	0.65	250	G	0.7	200	H13	0.32	500
68		F	0.65	250	H13	0.32	500	H13	0.32	500
100		G	0.35	400	H13	0.32	500	J16	0.17	793
150		H13	0.16	800	H13	0.32	500	J16	0.17	793
220		H13	0.16	800				K16	0.153	917
330					J16	0.17	793	K16	0.153	917
470		J16	0.082	1410	K16	0.153	917			
680		K16	0.080	1690						

(); Miniaturization type ⊙ Life time 5000h available upon request(suffix : G)

Standard Products

W.V. (V)	Cap. (±20%) (μF)	Case size			Specification			Part No. (RoHS: not compliant)		Part No. (RoHS: compliant)		Min. Packaging Q'ty
		Dia. (mm)	Length (mm)	Size Code	Ripple current (100kHz) (+105°C) (mA)	Impe- dance (100kHz) (+20°C) (Ω)	tan δ (120Hz) (+20°C)		Reflow		Reflow	Taping (pcs)
6.3	22	4	5.8	B	90	1.35	0.26	EEVFK0J220R	(1)	EEEFK0J220R	(4)	2000
	47	4	5.8	B	90	1.35	0.26	EEVFK0J470UR	(1)	EEEFK0J470UR	(4)	2000
		5	5.8	C	160	0.70	0.26	EEVFK0J470R	(1)	EEEFK0J470R	(4)	1000
	100	5	5.8	C	160	0.70	0.26	EEVFK0J101UR	(1)	EEEFK0J101UR	(4)	1000
		6.3	5.8	D	240	0.36	0.26	EEVFK0J101P	(1)	EEEFK0J101P	(4)	1000
	220	6.3	5.8	D	240	0.36	0.26	EEVFK0J221P	(1)	EEEFK0J221P	(4)	1000
	330	6.3	7.7	D8	280	0.34	0.26	EEVFK0J331XP	(1)	EEEFK0J331XP	(4)	900
		8	6.2	E	300	0.26	0.26	EEVFK0J331P	(2)	EEEFK0J331P	(5)	1000
	470	8	10.2	F	600	0.16	0.26	EEVFK0J471P	(2)	EEEFK0J471P	(5)	500
	1000	8	10.2	F	600	0.16	0.26	EEVFK0J102P	(2)	EEEFK0J102P	(5)	500
	1500	10	10.2	G	850	0.08	0.26	EEVFK0J152P	(2)	EEEFK0J152P	(5)	500
3300	12.5	13.5	H13	1100	0.06	0.30			EEVFK0J332Q	(2)	200	
6800	16	16.5	J16	1800	0.035	0.36			EEVFK0J682M	(2)	125	
10	22	4	5.8	B	90	1.35	0.19	EEVFK1A220R	(1)	EEEFK1A220R	(4)	2000
	33	4	5.8	B	90	1.35	0.19	EEVFK1A330UR	(1)	EEEFK1A330UR	(4)	2000
		5	5.8	C	160	0.70	0.19	EEVFK1A330R	(1)	EEEFK1A330R	(4)	1000
	150	6.3	5.8	D	240	0.36	0.19	EEVFK1A151P	(1)	EEEFK1A151P	(4)	1000
	220	6.3	7.7	D8	280	0.34	0.19	EEVFK1A221XP	(1)	EEEFK1A221XP	(4)	900
		8	6.2	E	300	0.26	0.19	EEVFK1A221P	(2)	EEEFK1A221P	(5)	1000
	330	8	10.2	F	600	0.16	0.19	EEVFK1A331P	(2)	EEEFK1A331P	(5)	500
	470	8	10.2	F	600	0.16	0.19	EEVFK1A471P	(2)	EEEFK1A471P	(5)	500
	680	8	10.2	F	600	0.16	0.19	EEVFK1A681P	(2)	EEEFK1A681P	(5)	500
	1000	10	10.2	G	850	0.08	0.19	EEVFK1A102P	(2)	EEEFK1A102P	(5)	500
	2200	12.5	13.5	H13	1100	0.06	0.21			EEVFK1A222Q	(2)	200
4700	16	16.5	J16	1800	0.035	0.25			EEVFK1A472M	(2)	125	
6800	18	16.5	K16	2060	0.033	0.29			EEVFK1A682M	(2)	125	
16	10	4	5.8	B	90	1.35	0.16	EEVFK1C100R	(1)	EEEFK1C100R	(4)	2000
	22	4	5.8	B	90	1.35	0.16	EEVFK1C220UR	(1)	EEEFK1C220UR	(4)	2000
		5	5.8	C	160	0.70	0.16	EEVFK1C220R	(1)	EEEFK1C220R	(4)	1000
	47	5	5.8	C	160	0.70	0.16	EEVFK1C470UR	(1)	EEEFK1C470UR	(4)	1000
		6.3	5.8	D	240	0.36	0.16	EEVFK1C470P	(1)	EEEFK1C470P	(4)	1000
	68	6.3	5.8	D	240	0.36	0.16	EEVFK1C680P	(1)	EEEFK1C680P	(4)	1000
	100	6.3	5.8	D	240	0.36	0.16	EEVFK1C101P	(1)	EEEFK1C101P	(4)	1000
	150	6.3	7.7	D8	280	0.34	0.16	EEVFK1C151XP	(1)	EEEFK1C151XP	(4)	900
	220	6.3	7.7	D8	280	0.34	0.16	EEVFK1C221XP	(1)	EEEFK1C221XP	(4)	900
		8	6.2	E	300	0.26	0.16	EEVFK1C221P	(2)	EEEFK1C221P	(5)	1000
	330	8	10.2	F	600	0.16	0.16	EEVFK1C331P	(2)	EEEFK1C331P	(5)	500
	470	8	10.2	F	600	0.16	0.16	EEVFK1C471P	(2)	EEEFK1C471P	(5)	500
	680	10	10.2	G	850	0.08	0.16	EEVFK1C681P	(2)	EEEFK1C681P	(5)	500
	1500	12.5	13.5	H13	1100	0.06	0.16			EEVFK1C152Q	(2)	200
3300	16	16.5	J16	1800	0.035	0.20			EEVFK1C332M	(2)	125	
4700	18	16.5	K16	2060	0.033	0.22			EEVFK1C472M	(2)	125	
25	10	4	5.8	B	90	1.35	0.14	EEVFK1E100R	(1)	EEEFK1E100R	(4)	2000
	22	5	5.8	C	160	0.7	0.14	EEVFK1E220R	(1)	EEEFK1E220R	(4)	1000

An explanation of the taping dimensions can be found on page 84.

Reflow profiles can be found on page 86.

Endurance: 105°C 2000h - 5000h

■ Standard Products

W.V.	Cap. (±20%) (μF)	Case size			Specification			Part No. (RoHS: not compliant)	Reflow	Part No. (RoHS: compliant)	Reflow	Min. Packaging Qty	Taping (pcs)
		Dia. (mm)	Length (mm)	Size Code	Ripple current (100kHz) (+105°C) (mA)	Impe- dance (100kHz) (+20°C) (Ω)	tan δ (120Hz) (+20°C)						
25	33	5	5.8	C	160	0.7	0.14	EEVFK1E330UR	(1)	EEEFK1E330UR	(4)	1000	
		6.3	5.8	D	240	0.36	0.14	EEVFK1E330P	(1)	EEEFK1E330P	(4)	1000	
	47	6.3	5.8	D	240	0.36	0.14	EEVFK1E470P	(1)	EEEFK1E470P	(4)	1000	
	68	6.3	5.8	D	240	0.36	0.14	EEVFK1E680P	(1)	EEEFK1E680P	(4)	1000	
	100	6.3	7.7	D8	280	0.34	0.14	EEVFK1E101XP	(1)	EEEFK1E101XP	(4)	900	
		8	6.2	E	300	0.26	0.14	EEVFK1E101P	(2)	EEEFK1E101P	(5)	1000	
	150	8	10.2	F	600	0.16	0.14	EEVFK1E151P	(2)	EEEFK1E151P	(5)	500	
	220	8	10.2	F	600	0.16	0.14	EEVFK1E221P	(2)	EEEFK1E221P	(5)	500	
	330	8	10.2	F	600	0.16	0.14	EEVFK1E331P	(2)	EEEFK1E331P	(5)	500	
	470	10	10.2	G	850	0.08	0.14	EEVFK1E471P	(2)	EEEFK1E471P	(5)	500	
	1000	12.5	13.5	H13	1100	0.06	0.14		(2)	EEVFK1E102Q	(2)	200	
	2200	16	16.5	J16	1800	0.035	0.16		(2)	EEVFK1E222M	(2)	125	
3300	18	16.5	K16	2060	0.033	0.18		(2)	EEVFK1E332M	(2)	125		
35	4.7	4	5.8	B	90	1.35	0.12	EEVFK1V4R7R	(1)	EEEFK1V4R7R	(4)	2000	
	10	4	5.8	B	90	1.35	0.12	EEVFK1V100UR	(1)	EEEFK1V100UR	(4)	2000	
		5	5.8	C	160	0.70	0.12	EEVFK1V100R	(1)	EEEFK1V100R	(4)	1000	
	22	5	5.8	C	160	0.70	0.12	EEVFK1V220R	(1)	EEEFK1V220R	(4)	1000	
	33	6.3	5.8	D	240	0.36	0.12	EEVFK1V330P	(1)	EEEFK1V330P	(4)	1000	
	47	6.3	5.8	D	240	0.36	0.12	EEVFK1V470P	(1)	EEEFK1V470P	(4)	1000	
	68	6.3	7.7	D8	280	0.34	0.12	EEVFK1V680XP	(1)	EEEFK1V680XP	(4)	900	
	100	6.3	7.7	D8	280	0.34	0.12	EEVFK1V101XP	(1)	EEEFK1V101XP	(4)	900	
		8	10.2	F	600	0.16	0.12	EEVFK1V101P	(2)	EEEFK1V101P	(5)	500	
	150	8	10.2	F	600	0.16	0.12	EEVFK1V151P	(2)	EEEFK1V151P	(5)	500	
	220	8	10.2	F	600	0.16	0.12	EEVFK1V221P	(2)	EEEFK1V221P	(5)	500	
	330	10	10.2	G	850	0.08	0.12	EEVFK1V331P	(2)	EEEFK1V331P	(5)	500	
	470	12.5	13.5	H13	1100	0.06	0.12			EEVFK1V471Q	(2)	200	
	680	12.5	13.5	H13	1100	0.06	0.12			EEVFK1V681Q	(2)	200	
	1000	16	16.5	J16	1800	0.035	0.12			EEVFK1V102M	(2)	125	
1500	16	16.5	J16	1800	0.035	0.12			EEVFK1V152M	(2)	125		
50	4.7	4	5.8	B	60	2.9	0.10	EEVFK1H4R7R	(1)	EEEFK1H4R7R	(4)	2000	
	10	5	5.8	C	85	1.52	0.10	EEVFK1H100UR	(1)	EEEFK1H100UR	(4)	1000	
		6.3	5.8	D	165	0.88	0.10	EEVFK1H100P	(1)	EEEFK1H100P	(4)	1000	
	22	6.3	5.8	D	165	0.88	0.10	EEVFK1H220P	(1)	EEEFK1H220P	(4)	1000	
	33	6.3	7.7	D8	195	0.68	0.10	EEVFK1H330XP	(1)	EEEFK1H330XP	(4)	900	
		8	6.2	E	195	0.68	0.10	EEVFK1H330P	(2)	EEEFK1H330P	(5)	1000	
	47	6.3	7.7	D8	195	0.68	0.10	EEVFK1H470XP	(1)	EEEFK1H470XP	(4)	900	
		8	6.2	E	195	0.68	0.10	EEVFK1H470P	(2)	EEEFK1H470P	(5)	1000	
	100	8	10.2	F	350	0.34	0.10	EEVFK1H101P	(2)	EEEFK1H101P	(5)	500	
	150	10	10.2	G	670	0.18	0.10	EEVFK1H151P	(2)	EEEFK1H151P	(5)	500	
	220	10	10.2	G	670	0.18	0.10	EEVFK1H221P	(2)	EEEFK1H221P	(5)	500	
	330	12.5	13.5	H13	900	0.12	0.10			EEVFK1H331Q	(2)	200	
	390	12.5	13.5	H13	900	0.12	0.10			EEVFK1H391Q	(2)	200	
	470	16	16.5	J16	1610	0.073	0.10			EEVFK1H471M	(2)	125	
680	16	16.5	J16	1610	0.073	0.10			EEVFK1H681M	(2)	125		
1000	16	16.5	J16	1610	0.073	0.10			EEVFK1H102M	(2)	125		

An explanation of the taping dimensions can be found on page 84.

Reflow profiles can be found on page 86.

Endurance: 105°C 2000h - 5000h

Design and specifications are subject to change without notice. Ask factory for technical specifications before purchase and/or use.

Whenever a doubt about safety arises from this product, please contact us immediately for technical consultation.

Download from www.somahuals.com. All Manuals Search And Download.

Standard Products

W.V. (V)	Cap. (±20%) (μF)	Case size			Specification			Part No. (RoHS: not compliant)		Part No. (RoHS: compliant)		Min. Packaging Q'ty
		Dia. (mm)	Length (mm)	Size Code	Ripple current (100kHz) (+105°C) (mA)	Impe- dance (100kHz) (+20°C) (Ω)	tan δ (120Hz) (+20°C)		Reflow		Reflow	Taping (pcs)
63	4.7	5	5.8	C	50	3.0	0.08	EEVFK1J4R7R	(1)	EEEFK1J4R7R	(4)	1000
	10	6.3	5.8	D	80	1.5	0.08	EEVFK1J100P	(1)	EEEFK1J100P	(4)	1000
	22	6.3	7.7	D8	120	1.2	0.08	EEVFK1J220XP	(1)	EEEFK1J220XP	(4)	900
		8	6.2	E	120	1.2	0.08	EEVFK1J220P	(2)	EEEFK1J220P	(5)	1000
	33	8	10.2	F	250	0.65	0.08	EEVFK1J330P	(2)	EEEFK1J330P	(5)	500
	47	8	10.2	F	250	0.65	0.08	EEVFK1J470P	(2)	EEEFK1J470P	(5)	500
	68	8	10.2	F	250	0.65	0.08	EEVFK1J680UP	(2)	EEEFK1J680UP	(5)	500
	100	10	10.2	G	400	0.35	0.08	EEVFK1J101P	(2)	EEEFK1J101P	(5)	500
	150	12.5	13.5	H13	800	0.16	0.08			EEVFK1J151Q	(2)	200
	220	12.5	13.5	H13	800	0.16	0.08			EEVFK1J221Q	(2)	200
	470	16	16.5	J16	1410	0.082	0.08			EEVFK1J471M	(2)	125
680	18	16.5	K16	1690	0.08	0.08			EEVFK1J681M	(2)	125	
80	3.3	5	5.8	C	25	5.0	0.08	EEVFK1K3R3R	(1)	EEEFK1K3R3R	(4)	1000
	4.7	6.3	5.8	D	40	3.0	0.08	EEVFK1K4R7P	(1)	EEEFK1K4R7P	(4)	1000
	10	6.3	7.7	D8	60	2.4	0.08	EEVFK1K100XP	(1)	EEEFK1K100XP	(4)	900
		8	6.2	E	60	2.4	0.08	EEVFK1K100P	(2)	EEEFK1K100P	(5)	1000
	22	8	10.2	F	130	1.3	0.08	EEVFK1K220P	(2)	EEEFK1K220P	(5)	500
	33	8	10.2	F	130	1.3	0.08	EEVFK1K330P	(2)	EEEFK1K330P	(5)	500
	47	10	10.2	G	200	0.7	0.08	EEVFK1K470P	(2)	EEEFK1K470P	(5)	500
	68	12.5	13.5	H13	500	0.32	0.08			EEVFK1K680Q	(2)	200
	100	12.5	13.5	H13	500	0.32	0.08			EEVFK1K101Q	(2)	200
	150	12.5	13.5	H13	500	0.32	0.08			EEVFK1K151Q	(2)	200
	330	16	16.5	J16	793	0.17	0.08			EEVFK1K331M	(2)	125
470	18	16.5	K16	917	0.153	0.08			EEVFK1K471M	(2)	125	
100	22	8.0	10.2	F	130	1.3	0.07	EEVFK2A220P	(2)	EEEFK2A220P	(5)	500
	33	10	10.2	G	200	0.7	0.07	EEVFK2A330P	(2)	EEEFK2A330P	(5)	500
	47	12.5	13.5	H13	500	0.32	0.07			EEVFK2A470Q	(2)	200
	68	12.5	13.5	H13	500	0.32	0.07			EEVFK2A680Q	(2)	200
	100	16	16.5	J16	793	0.17	0.07			EEVFK2A101M	(2)	125
	150	16	16.5	J16	793	0.17	0.07			EEVFK2A151M	(2)	125
	220	18	16.5	K16	917	0.153	0.07			EEVFK2A221M	(2)	125
	330	18	16.5	K16	917	0.153	0.07			EEVFK2A331M	(2)	125

An explanation of the taping dimensions can be found on page 84.

Reflow profiles can be found on page 86.

Endurance: 105°C 2000h - 5000h

Frequency Correction Factor of Rated Ripple Current

coefficient	Frequency (Hz)				
	50,60	120	1k	10k	100k~
	0.70	0.75	0.90	0.95	1.00

■ Endurance

- EEVFK0J220R (6.3V22 μ F, ϕ 4x5.8)
- EEVFK0J101P (6.3V100 μ F, ϕ 6.3x5.8)
- △ EEVFK0J152P (6.3V1500 μ F, ϕ 10x10.2)

at 105°C

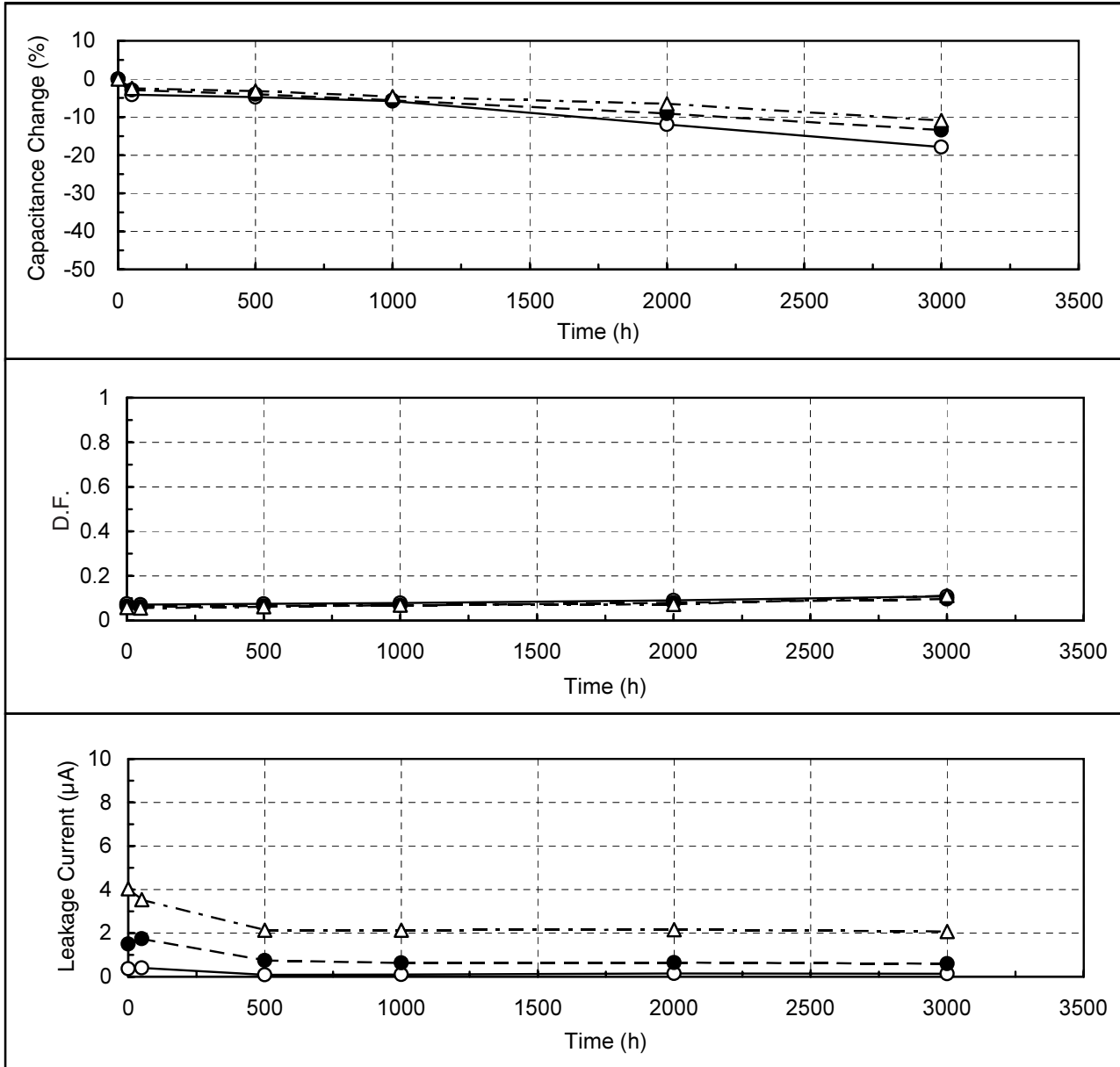

■ Frequency Characteristics (Impedance)

● 16VV

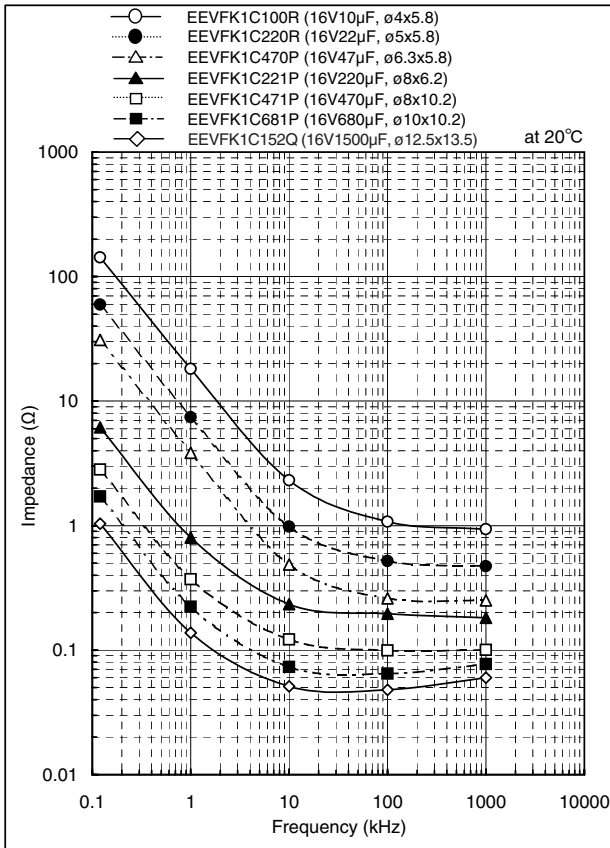

● 35VV

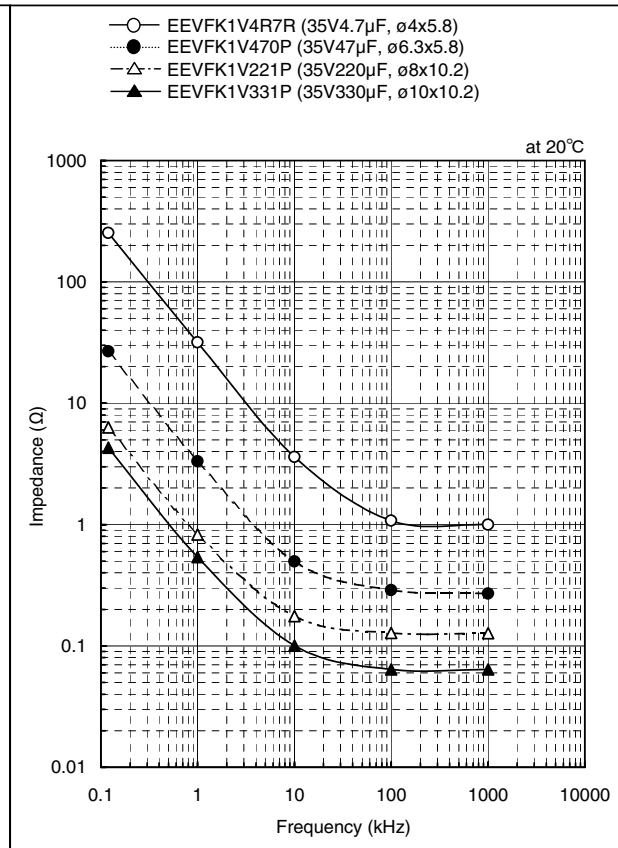

● 63VV

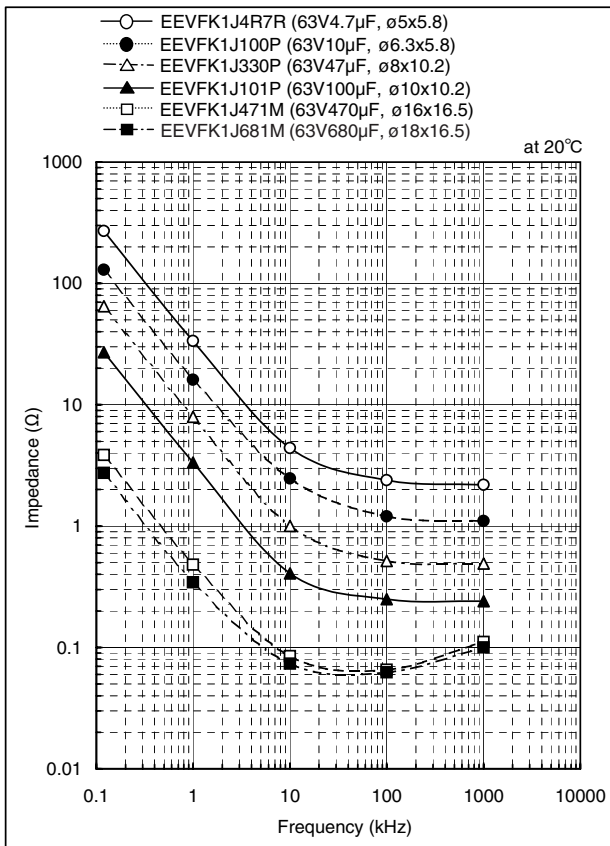

● 80VV

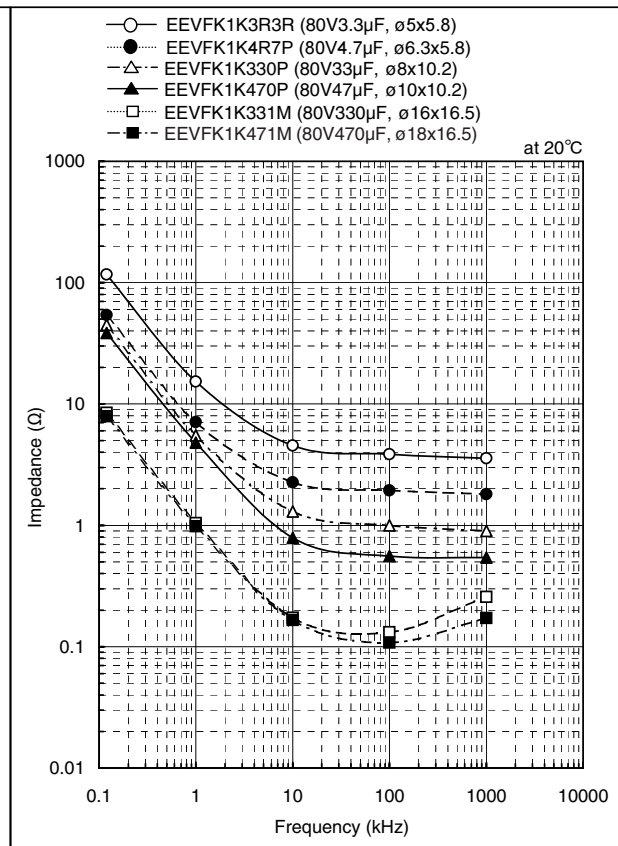

Frequency Characteristics (ESR)

● 16WV

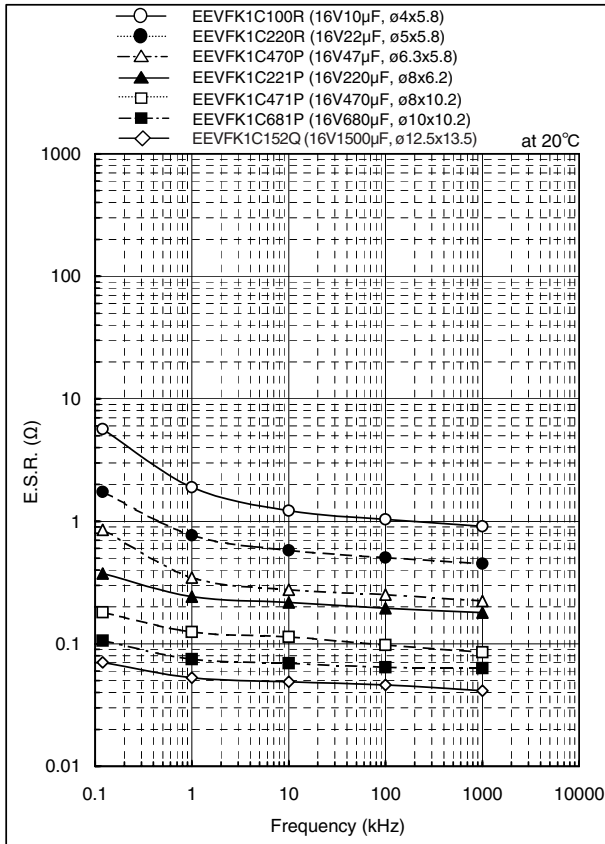

● 35WV

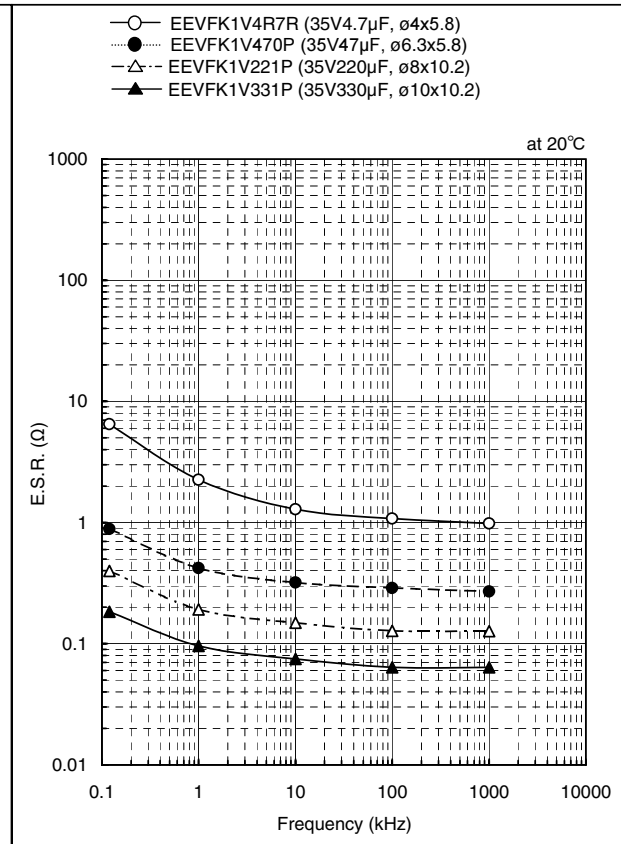

● 63WV

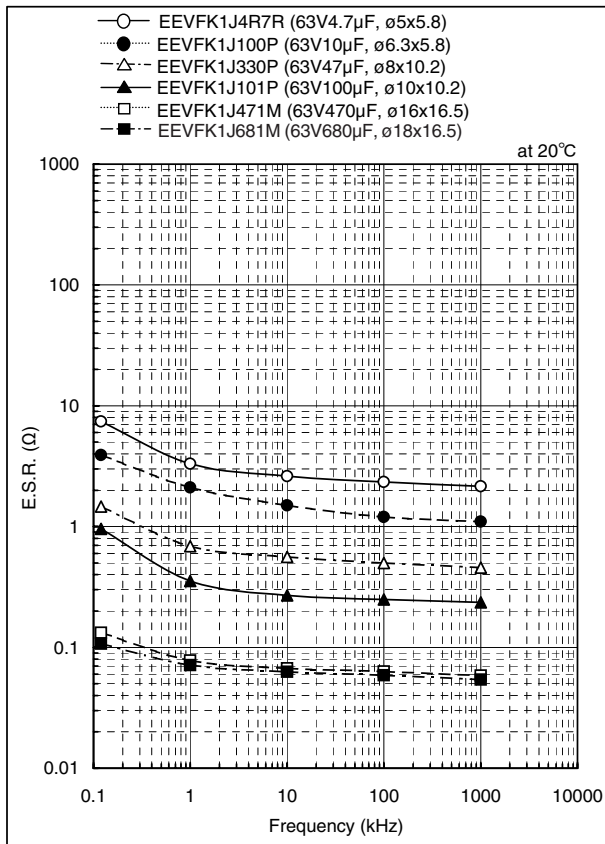

● 80WV

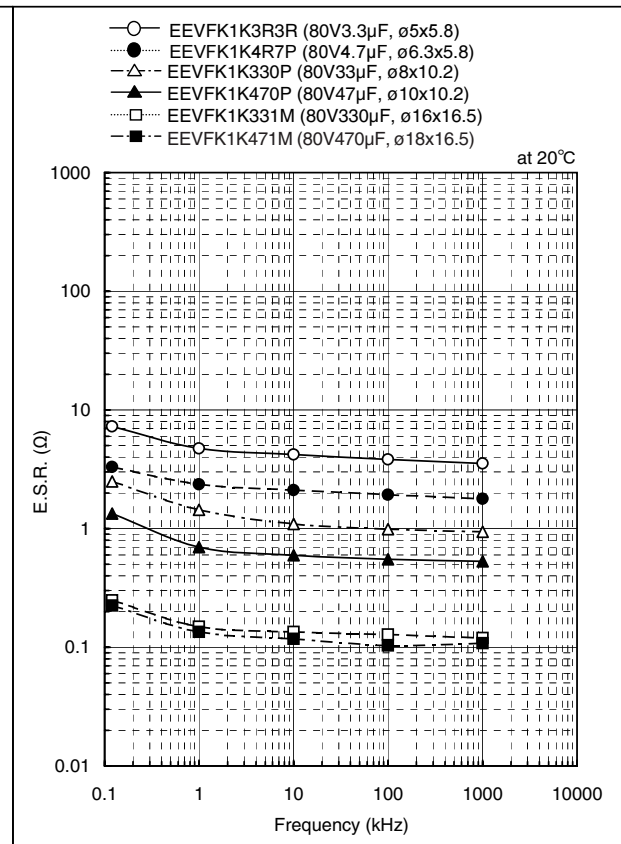

Temperature Characteristics

● $\phi 6.3 \times 5.8$

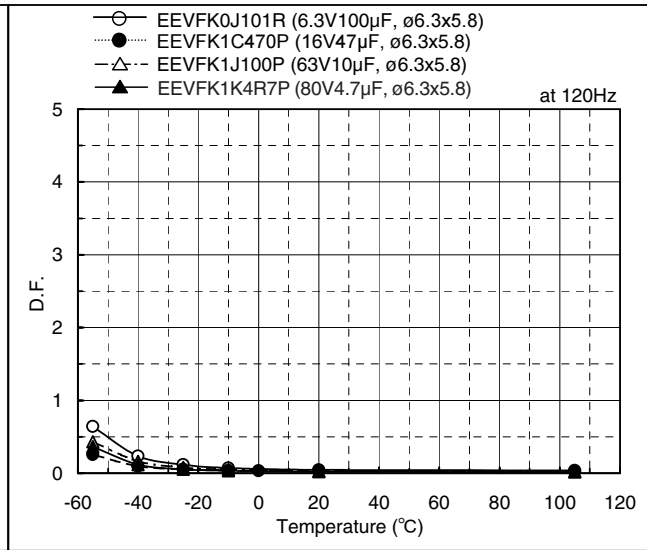
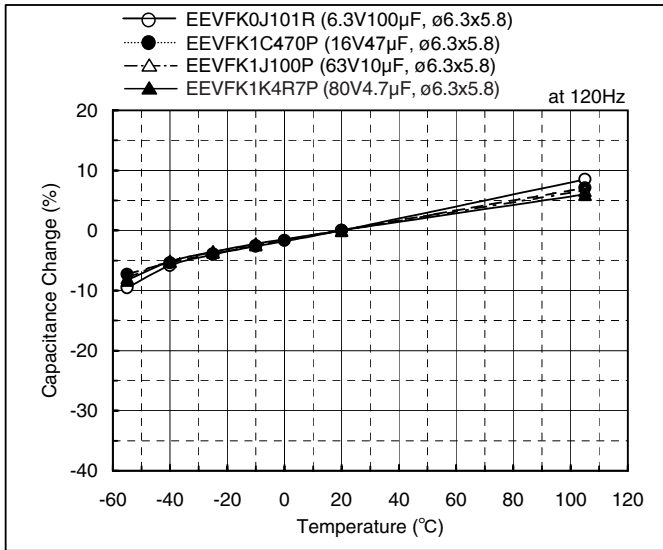

● $\phi 8 \times 10.2$

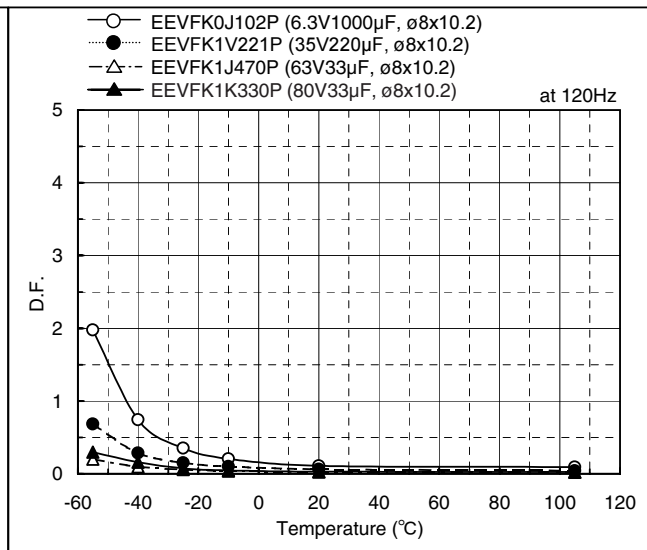
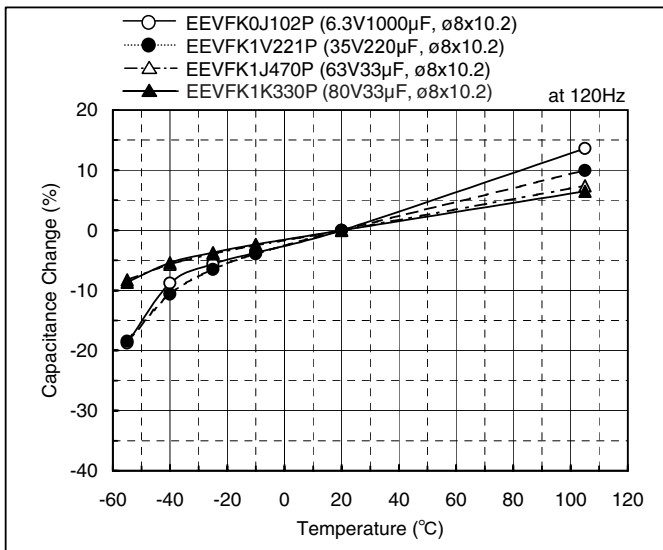

Surface Mount Type

Series: TA Type : V



- Features
 - Endurance: 125°C 1000 h
 - For use near car engines.
 - Good for electronically controlled units (ECU, ABS etc).
 - Vibration-proof product is available upon request. ($\phi 8 \leq$)
 - RoHS directive not compliant.
 - TG series is recommended for RoHS compliant.

■ Specifications

Category temp. range	-40 to +125°C						
Rated W.V. Range	10 to 50 V .DC						
Nominal Cap. Range	10 to 330 μ F						
Capacitance Tolerance	± 20 % (120Hz/+20°C)						
DC Leakage Current	$I \leq 0.01 CV$ or $3(\mu A)$ after 2 minutes (Whichever is greater)						
tan δ	Please see the attached standard products list						
Characteristics at Low Temperature	W.V. (V)	10	16	25	35	50	(Impedance ratio at 120Hz)
	-25 / +20 °C	8	5	4	3	3	
	-40 / +20 °C	14	12	10	8	8	
Endurance	After applying rated working voltage for 1000 hours at +125 \pm 2°C and then being stabilized at +20°C, capacitors shall meet the following limits.						
	Capacitance change	± 30 % of initial measured value					
	tan δ	≤ 300 % of initial specified value					
Shelf Life	After storage for 500 hours at +125 \pm 2°C with no voltage applied and then being stabilized at +20°C, capacitors shall meet the following limits. (With voltage treatment)						
	Capacitance change	± 20 % of initial measured value					
	tan δ	≤ 200 % of initial specified value					
Resistance to Soldering Heat	After reflow soldering (Refer to page 86 for recommended temperature profile) and then being stabilized at +20°C, capacitor shall meet the following limits.						
	Capacitance change	± 10 % of initial measured value					
	tan δ	\leq initial specified value					
	DC leakage current	\leq initial specified value					

■ Marking

Example: 16V 100 μ F (Polarized)

W.V. code

V	10	16	25	35	50
Code	A	C	E	V	H

■ Dimensions in mm (not to scale)

Size code	D	L	A, B	H	I	W	P	K
E	8.0	6.2	8.3	9.5MAX	3.4	0.65 \pm 0.1	2.2	0.35 -0.20 to +0.15
F	8.0	10.2	8.3	10.0MAX	3.4	0.90 \pm 0.2	3.1	0.70 \pm 0.2
G	10.0	10.2	10.3	12.0MAX	3.5	0.90 \pm 0.2	4.6	0.70 \pm 0.2

■ Case size

W.V.(V) Cap. (μ F)	10 (1A)	16 (1C)	25 (1E)	35 (1V)	50 (1H)
10					E
22					E
33				E	F
47			E	F	G
100	E	F	F	G	
220	F	G			
330	G				

■ Standard Products

W.V. (V)	Cap. (±20%) (μF)	Case size			Specification		Part No. (RoHS: not compliant)	Reflow	Min. Packaging Qty
		Dia. (mm)	Length (mm)	Size Code	Ripple current (100kHz) (+125°C) (mA)	tan δ (120Hz) (+20°C)			Taping (pcs)
10	100	8	6.2	E	62	0.32	EEVTA1A101P	(2)	1000
	220	8	10.2	F	93	0.32	EEVTA1A221P	(2)	500
	330	10	10.2	G	118	0.32	EEVTA1A331P	(2)	500
16	100	8	10.2	F	89	0.24	EEVTA1C101P	(2)	500
	220	10	10.2	G	113	0.24	EEVTA1C221P	(2)	500
25	47	8	6.2	E	56	0.21	EEVTA1E470P	(2)	1000
	100	8	10.2	F	84	0.21	EEVTA1E101P	(2)	500
35	33	8	6.2	E	53	0.18	EEVTA1V330P	(2)	1000
	47	8	10.2	F	79	0.18	EEVTA1V470P	(2)	500
	100	10	10.2	G	101	0.18	EEVTA1V101P	(2)	500
50	10	8	6.2	E	25	0.18	EEVTA1H100P	(2)	1000
	22	8	6.2	E	50	0.18	EEVTA1H220P	(2)	1000
	33	8	10.2	F	74	0.18	EEVTA1H330P	(2)	500
	47	10	10.2	G	94	0.18	EEVTA1H470P	(2)	500

An explanation of the taping dimensions can be found on page 84.

Reflow profiles can be found on page 86.

■ Frequency Correction Factor of Rated Ripple Current

	Frequency (Hz)			
	120	1k	10k	100k~
coefficient	0.65	0.85	0.95	1.00

Temperature Characteristics

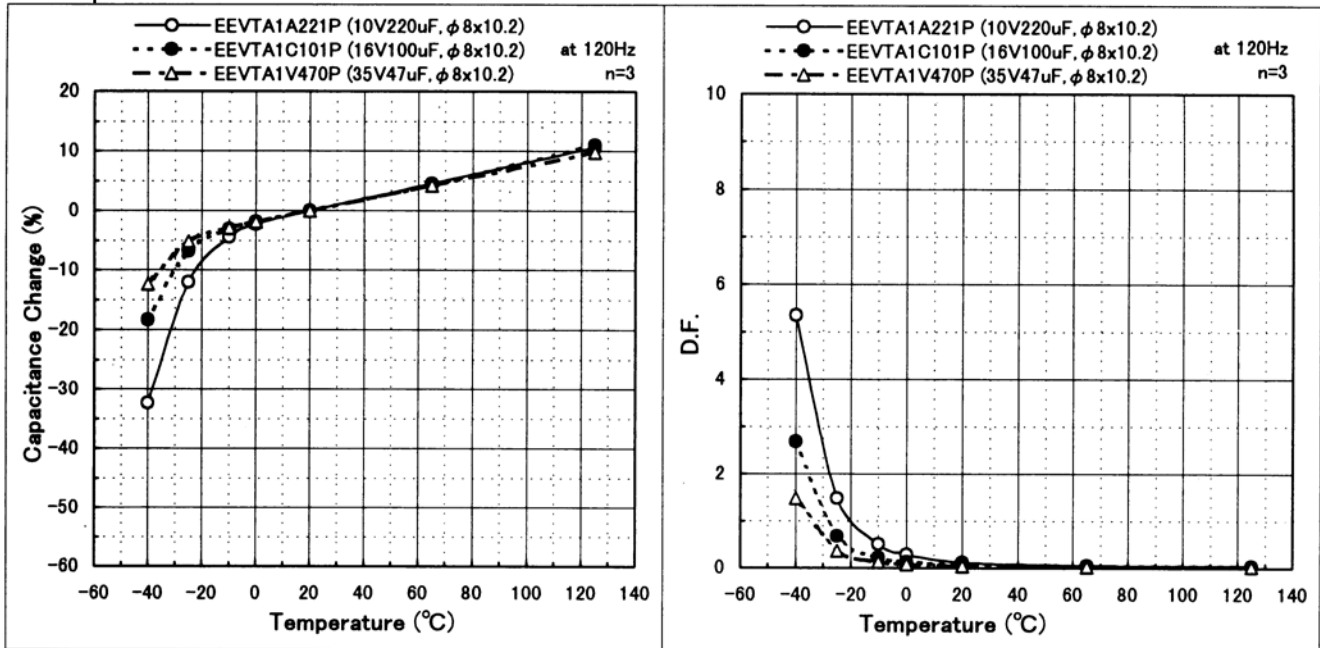

Endurance

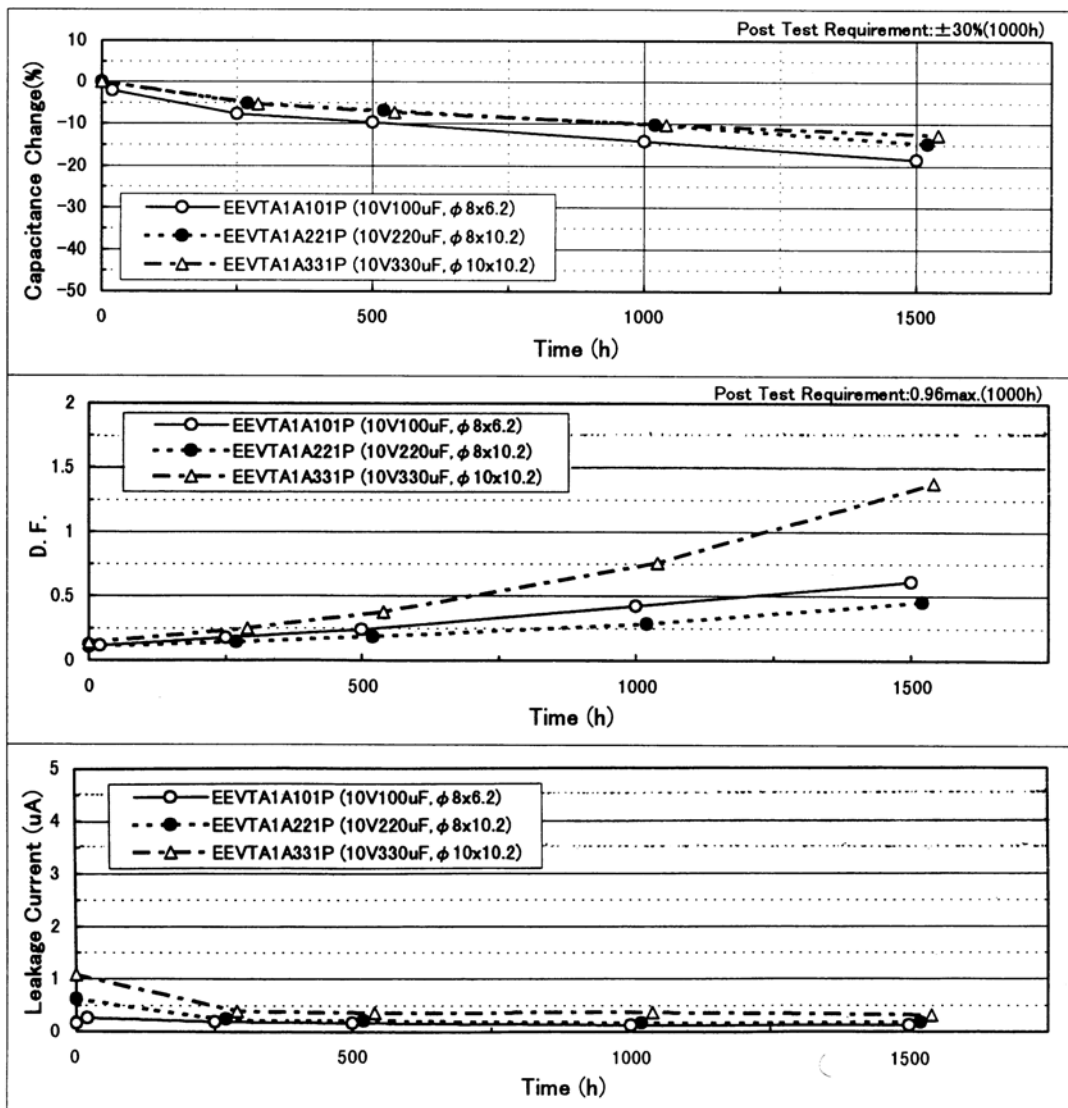

■ Frequency Characteristics

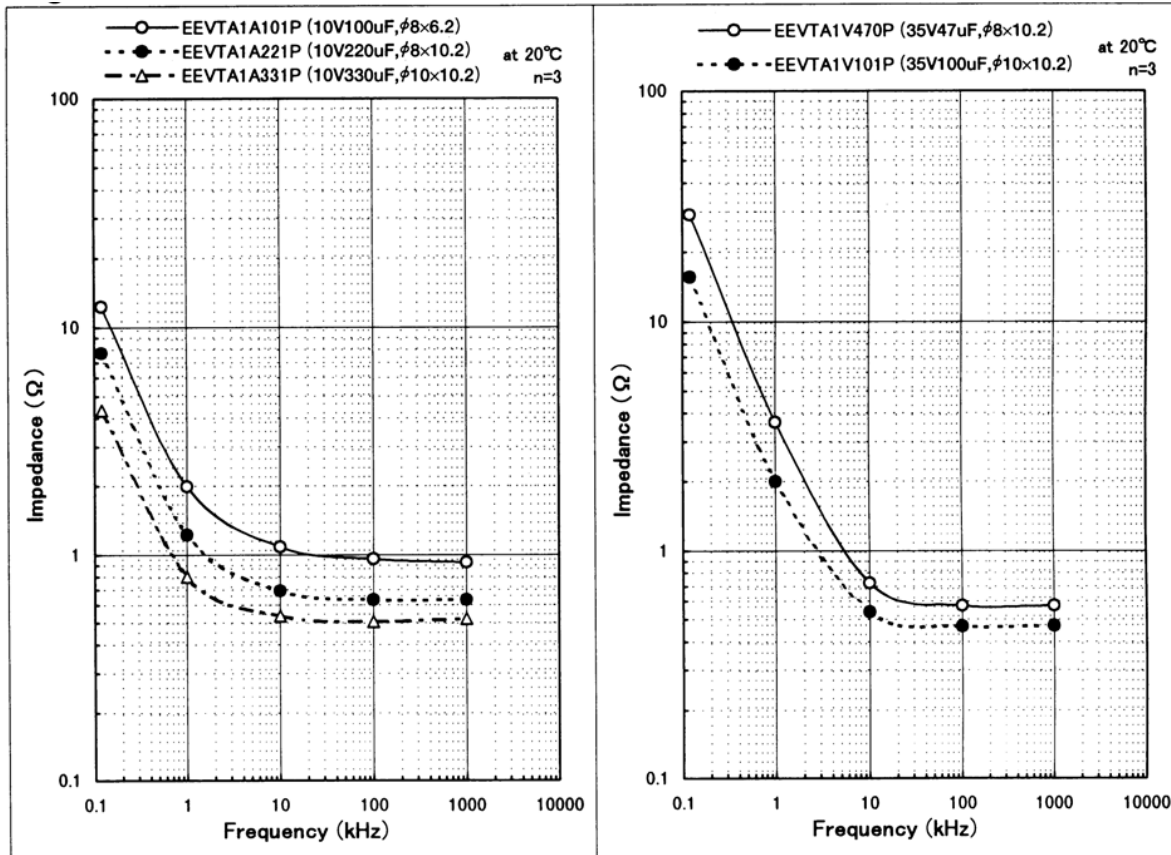

◎50WV

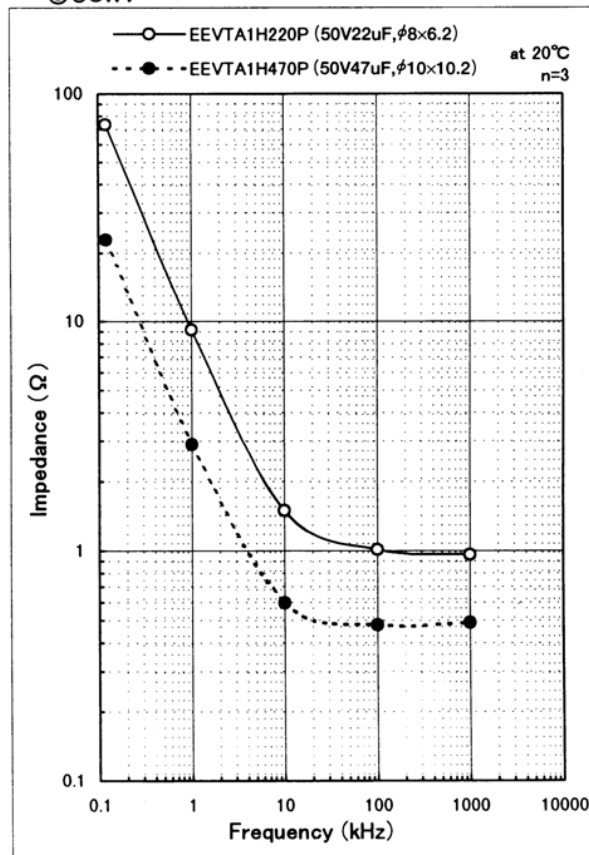

Temperature Characteristics

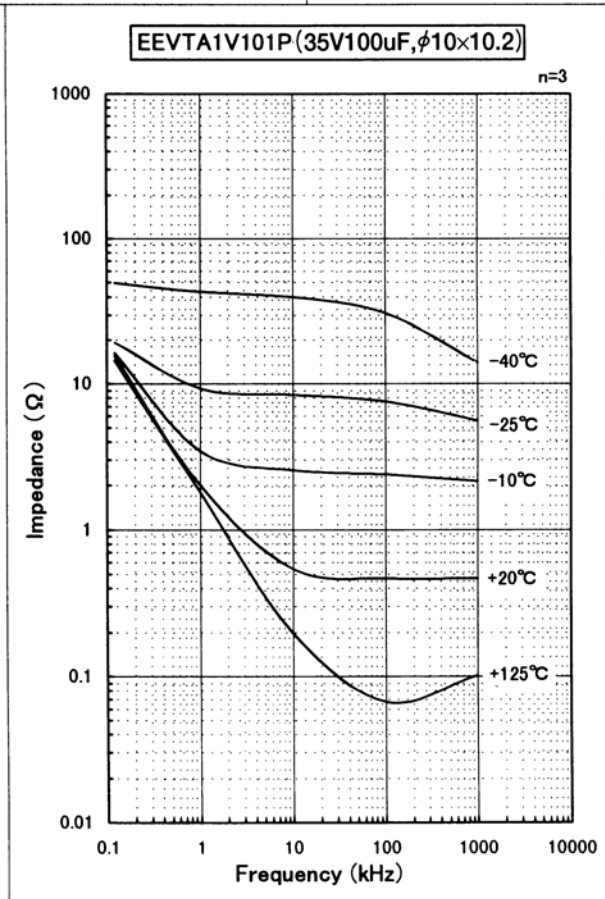
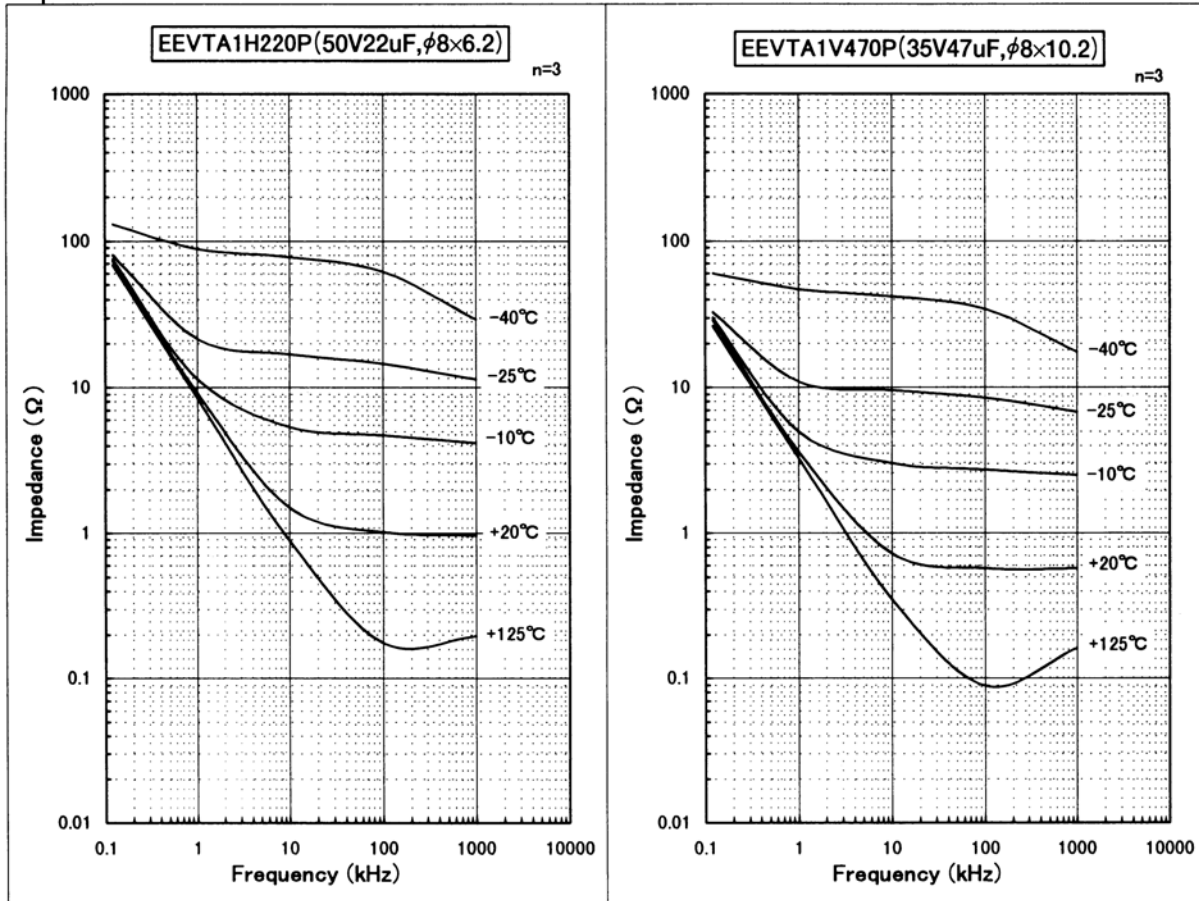

Surface Mount Type

Series: **TG** Type : **V**

- Features**
 - Endurance: 125°C 1000 to 2000 h
 - Miniaturization (40% less than TA Series)
 - Low ESR (Low temp)
 - Vibration-proof product is available upon request. ($\phi 8 \leq$)
 - RoHS directive compliant (Parts No: EEV* $\phi 12.5 \leq$, EEE*)



- Applications**
 - For use near car engines.
 - Good for electronically controlled units (ECU, ABS etc).

Specifications

Category temp. range	-40 to +125°C									
Rated W.V. Range	10 to 100 V .DC									
Nominal Cap. Range	10 to 4700 μ F									
Capacitance Tolerance	± 20 % (120Hz/+20°C)									
DC Leakage Current	$I \leq 0.01$ CV or 3(μ A) after 2 minutes (Whichever is greater)									
tan δ	Please see the attached standard products list									
Characteristics at Low Temperature	W.V. (V)	10	16	25	35	50	63	80	100	(Impedance ratio at 120Hz)
	-25 / +20 °C	3	2	2	2	2	2	2	2	
	-40 / +20 °C	6	4	4	3	3	3	3	3	
Endurance	After applying rated working voltage for 1000 hours ($\phi 8 \times 6.2$), 2000 hours ($8 \times 10.2 \leq$) at +125 ± 2 °C and then being stabilized at +20°C, capacitors shall meet the following limits.									
	Capacitance change	± 30 % of initial measured value (code U: ± 35 %)								
	tan δ	≤ 300 % of initial specified value (code U: 350%)								
Shelf Life	After storage for 1000 hours at +125 ± 2 °C with no voltage applied and then being stabilized at +20°C, capacitors shall meet the limits specified in Endurance. (With voltage treatment)									
	After reflow soldering (Refer to page 86 for recommended temperature profile) and then being stabilized at +20°C, capacitor shall meet the following limits.									
Resistance to Soldering Heat	After reflow soldering (Refer to page 86 for recommended temperature profile) and then being stabilized at +20°C, capacitor shall meet the following limits.									
	Capacitance change	± 10 % of initial measured value								
	tan δ	\leq initial specified value								
DC leakage current	\leq initial specified value									

Marking

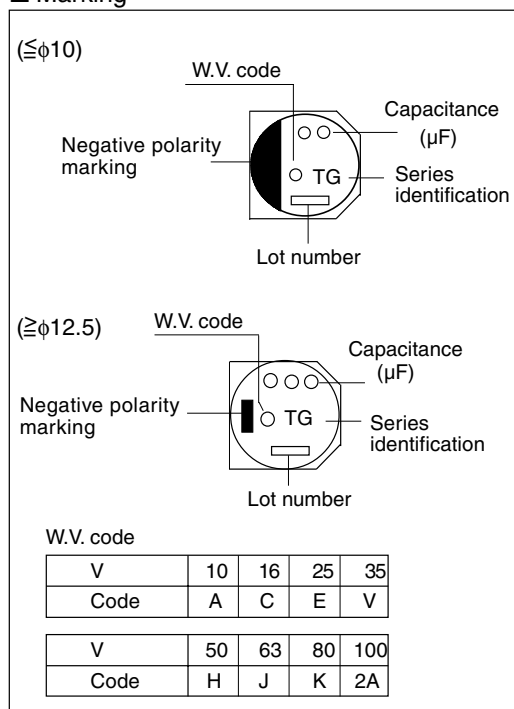

Dimensions in mm (not to scale)

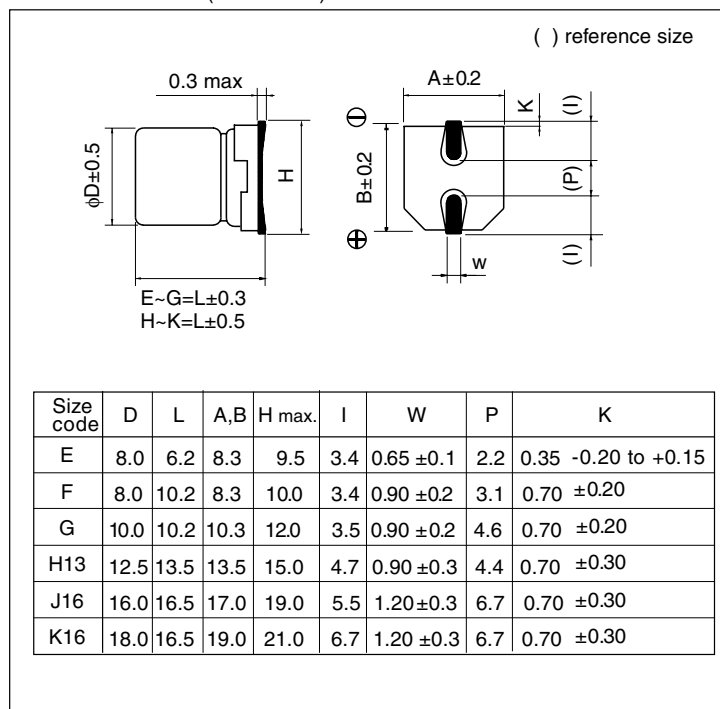

■ Case size VS Capacitance, ESR and Ripple current ESR;(Ω/100kHz,+20°C),Ripple current ;(mA r.m.s./100kHz+125°C)

Capacitance (μF)	W.V. (V)	10			16			25					
		size	ESR		Ripple current	size	ESR		Ripple current	size	ESR		Ripple current
			20°C	-40°C			20°C	-40°C			20°C	-40°C	
47									E	1.0	20	100	
100	E	1.0	20	100	F	0.5	10	197	(E)	(1.0)	(20)	(100)	
									F	0.5	10	197	
220	(E)	(1.0)	(20)	(100)	(F)	(0.5)	(10)	(197)	(F)	(0.5)	(10)	(197)	
	F	0.5	10	197	G	0.3	6.0	270	G	0.3	6.0	270	
330	(F)	(0.5)	(10)	(197)	(G)	(0.3)	(6.0)	(270)	(G)	(0.3)	(6.0)	(270)	
	G	0.3	6.0	270	H13	0.12	1.8	800	H13	0.12	1.8	800	
470	(G)	(0.3)	(6.0)	(270)	H13	0.12	1.8	800	H13	0.12	1.8	800	
680					H13	0.12	1.8	800	(H13)	(0.12)	(1.8)	(800)	
									J16	0.08	1.2	1100	
1000	H13	0.12	1.8	800	(H13)	(0.12)	(1.8)	(800)	(J16)	(0.08)	(1.2)	(1100)	
					J16	0.08	1.2	1100	K16	0.075	1.1	1300	
1500	(H13)	(0.12)	(1.8)	(800)									
2200	J16	0.08	1.2	1100	(J16)	(0.08)	(1.2)	(1100)	K16	0.075	1.1	1300	
					K16	0.075	1.1	1300					
3300	(J16)	(0.08)	(1.2)	(1100)	K16	0.075	1.1	1300					
	K16	0.075	1.1	1300									
4700	K16	0.075	1.1	1300									

Capacitance (μF)	W.V. (V)	35			50			63					
		size	ESR		Ripple current	size	ESR		Ripple current	size	ESR		Ripple current
			20°C	-40°C			20°C	-40°C			20°C	-40°C	
10					E	1.6	32	80	E	2.2	55	55	
22					E	1.6	32	80	F	1	25	100	
33	E	1.0	20	100	(E)	(1.6)	(32)	(80)	(F)	(1)	(25)	(100)	
					F	0.75	15	133	G	0.8	20	150	
47	(E)	(1.0)	(20)	(100)	(F)	(0.75)	(15)	(133)	(F)	(1)	(25)	(100)	
	F	0.5	10	197	G	0.5	10	221	G	0.8	20	150	
100	(F)	(0.5)	(10)	(197)					(G)	(0.8)	(20)	(150)	
	G	0.3	6.0	270	(G)	(0.5)	(10)	(221)	H13	0.26	5.2	350	
220	(G)	(0.3)	(6.0)	(270)	H13	0.23	3.4	600	H13	0.26	5.2	350	
330	H13	0.12	1.8	800	H13	0.23	3.4	600	J16	0.18	3.6	500	
470	(H13)	(0.12)	(1.8)	(800)	J16	0.15	2.2	900	J16	0.18	3.6	500	
	J16	0.08	1.2	1100									
680	(J16)	(0.08)	(1.2)	(1100)	(J16)	(0.15)	(2.2)	(900)					
	K16	0.075	1.1	1300	K16	0.14	2.1	950					
1000	K16	0.075	1.1	1300	K16	0.14	2.1	950					

Capacitance (μF)	W.V. (V)	80			100				
		size	ESR		Ripple current	size	ESR		Ripple current
			20°C	-40°C			20°C	-40°C	
10	F	1.3	32	70	F	1.3	32	70	
22	(F)	(1.3)	(32)	(70)	(F)	(1.3)	(32)	(70)	
	G	1.0	25	90	G	1.0	25	90	
33	(F)	(1.3)	(32)	(70)	G	1.0	25	90	
	G	1.0	25	90					
47	(G)	(1.0)	(25)	(90)	H13	0.42	8.4	250	
	H13	0.42	8.4	250					
100	(H13)	(0.42)	(8.4)	(250)	J16	0.3	6.0	350	
	J16	0.3	6.0	350					
220	(J16)	(0.3)	(6.0)	(350)	K16	0.28	5.6	400	
	K16	0.28	5.6	400					
330	(J16)	(0.3)	(6.0)	(350)	K16	0.28	5.6	400	
	K16	0.28	5.6	400					
470	K16	0.28	5.6	400					

() Shows miniaturized size
Suffix : U

■ Standard Products

W.V. (V)	Cap (±20%) (μF)	Case Size			Specification			Part No. (RoHS: not compliant)		Part No. (RoHS: compliant)		Min. Packaging Q'ty Taping (pcs)
		Dia. (mm)	Length (mm)	Size code	Ripple current (100kHz) (+125°C) (mA)	ESR (100kHz) (+20°C) (Ω)	tan δ (120Hz) (+20°C)		Reflow		Reflow	
10	100	8	6.2	E	100	1.0	0.30	EEVTG1A101P	(2)	EEETG1A101P	(5)	1000
	220	(8)	(6.2)	(E)	(100)	(1.0)	0.30	EEVTG1A221UP	(2)	EEETG1A221UP	(5)	1000
		8	10.2	F	197	0.5	0.30	EEVTG1A221P	(2)	EEETG1A221P	(5)	500
	330	(8)	(10.2)	(F)	(197)	(0.5)	0.30	EEVTG1A331UP	(2)	EEETG1A331UP	(5)	500
		10	10.2	G	270	0.3	0.30	EEVTG1A331P	(2)	EEETG1A331P	(5)	500
	470	(10)	(10.2)	(G)	(270)	(0.3)	0.30	EEVTG1A471UP	(2)	EEETG1A471UP	(5)	500
	1000	12.5	13.5	H13	800	0.12	0.30			EEVTG1A102Q	(2)	200
	1500	(12.5)	(13.5)	(H13)	(800)	(0.12)	0.30			EEVTG1A152UQ	(2)	200
	2200	16	16.5	J16	1100	0.08	0.32			EEVTG1A222M	(2)	125
	3300	(16)	(16.5)	(J16)	(1100)	(0.08)	0.34			EEVTG1A332UM	(2)	125
18		16.5	K16	1300	0.075	0.34			EEVTG1A332M	(2)	125	
4700	18	16.5	K16	1300	0.075	0.36			EEVTG1A472M	(2)	125	
16	100	8	10.2	F	197	0.5	0.23	EEVTG1C101P	(2)	EEETG1C101P	(5)	500
	220	(8)	(10.2)	(F)	(197)	(0.5)	0.23	EEVTG1C221UP	(2)	EEETG1C221UP	(5)	500
		10	10.2	G	270	0.3	0.23	EEVTG1C221P	(2)	EEETG1C221P	(5)	500
	330	(10)	(10.2)	(G)	(270)	(0.3)	0.23	EEVTG1C331UP	(2)	EEETG1C331UP	(5)	500
		12.5	13.5	H13	800	0.12	0.23			EEVTG1C331Q	(2)	200
	470	12.5	13.5	H13	800	0.12	0.23			EEVTG1C471Q	(2)	200
	680	12.5	13.5	H13	800	0.12	0.23			EEVTG1C681Q	(2)	200
	1000	(12.5)	(13.5)	(H13)	(800)	(0.12)	0.23			EEVTG1C102UQ	(2)	200
		16	16.5	J16	1100	0.08	0.23			EEVTG1C102M	(2)	125
	2200	(16)	(16.5)	(J16)	(1100)	(0.08)	0.25			EEVTG1C222UM	(2)	125
18		16.5	K16	1300	0.075	0.25			EEVTG1C222M	(2)	125	
3300	18	16.5	K16	1300	0.075	0.27			EEVTG1C332M	(2)	125	
25	47	8	6.2	E	100	1.0	0.18	EEVTG1E470P	(2)	EEETG1E470P	(5)	1000
	100	(8)	(6.2)	(E)	(100)	(1.0)	0.18	EEVTG1E101UP	(2)	EEETG1E101UP	(5)	1000
		8	10.2	F	197	0.5	0.18	EEVTG1E101P	(2)	EEETG1E101P	(5)	500
	220	(8)	(10.2)	(F)	(197)	(0.5)	0.18	EEVTG1E221UP	(2)	EEETG1E221UP	(5)	500
		10	10.2	G	270	0.3	0.18	EEVTG1E221P	(2)	EEETG1E221P	(5)	500
	330	(10)	(10.2)	(G)	(270)	(0.3)	0.18	EEVTG1E331UP	(2)	EEETG1E331UP	(5)	500
		12.5	13.5	H13	800	0.12	0.18			EEVTG1E331Q	(2)	200
	470	12.5	13.5	H13	800	0.12	0.18			EEVTG1E471Q	(2)	200
	680	(12.5)	(13.5)	(H13)	(800)	(0.12)	0.18			EEVTG1E681UQ	(2)	200
		16	16.5	J16	1100	0.08	0.18			EEVTG1E681M	(2)	125
1000	(16)	(16.5)	(J16)	(1100)	(0.08)	0.18			EEVTG1E102UM	(2)	125	
	18	16.5	K16	1300	0.075	0.18			EEVTG1E102M	(2)	125	
2200	18	16.5	K16	1300	0.075	0.20			EEVTG1E222M	(2)	125	
35	33	8	6.2	E	100	1.0	0.16	EEVTG1V330P	(2)	EEETG1V330P	(5)	1000
	47	(8)	(6.2)	(E)	(100)	(1.0)	0.16	EEVTG1V470UP	(2)	EEETG1V470UP	(5)	1000
		8	10.2	F	197	0.5	0.16	EEVTG1V470P	(2)	EEETG1V470P	(5)	500
	100	(8)	(10.2)	(F)	(197)	(0.5)	0.16	EEVTG1V101UP	(2)	EEETG1V101UP	(5)	500
		10	10.2	G	270	0.3	0.16	EEVTG1V101P	(2)	EEETG1V101P	(5)	500
	220	(10)	(10.2)	(G)	(270)	(0.3)	0.16	EEVTG1V221UP	(2)	EEETG1V221UP	(5)	500
330	12.5	13.5	H13	800	0.12	0.16			EEVTG1V331Q	(2)	1000	

An explanation of the taping dimensions can be found on page 84.

Reflow profiles can be found on page 86.

Endurance: 125°C 1000h - 2000h

■ Standard Products

W.V. (V)	Cap (±20%) (μF)	Case Size			Specification			Part No. (RoHS: not compliant)		Part No. (RoHS: compliant)		Min. Packaging Q'ty Taping (pcs)
		Dia. (mm)	Length (mm)	Size code	Ripple current (100kHz) (+125°C) (mA)	ESR (100kHz) (+20°C) (Ω)	tan δ (120Hz) (+20°C)		Reflow		Reflow	
35	470	12.5	13.5	(H13)	(800)	(0.12)	0.16			EEVTG1V471UQ	(2)	200
		16	16.5	J16	1100	0.08	0.16			EEVTG1V471M	(2)	125
	680	(16)	(16.5)	(J16)	(1100)	(0.08)	0.16			EEVTG1V681UM	(2)	125
		18	16.5	K16	1300	0.075	0.16			EEVTG1V681M	(2)	125
	1000	18	16.5	K16	1300	0.075	0.16			EEVTG1V102M	(2)	125
50	10	8	6.2	E	80	1.6	0.14	EEVTG1H100P	(2)	EEETG1H100P	(5)	1000
	22	8	6.2	E	80	1.6	0.14	EEVTG1H220P	(2)	EEETG1H220P	(5)	1000
	33	(8)	(6.2)	(E)	(80)	(1.6)	0.14	EEVTG1H330UP	(2)	EEETG1H330UP	(5)	1000
		8	10.2	F	133	0.75	0.14	EEVTG1H330P	(2)	EEETG1H330P	(5)	500
	47	(8)	(10.2)	(F)	(133)	(0.75)	0.14	EEVTG1H470UP	(2)	EEETG1H470UP	(5)	500
		10	10.2	G	221	0.5	0.14	EEVTG1H470P	(2)	EEETG1H470P	(5)	500
	100	(10)	(10.2)	(G)	(221)	(0.5)	0.14	EEVTG1H101UP	(2)	EEETG1H101UP	(5)	500
	220	12.5	13.5	H13	600	0.23	0.14			EEVTG1H221Q	(2)	200
	330	12.5	13.5	H13	600	0.23	0.14			EEVTG1H331Q	(2)	200
	470	16	16.5	J16	900	0.15	0.14			EEVTG1H471M	(2)	125
	680	(16)	(16.5)	(J16)	(900)	(0.15)	0.14			EEVTG1H681UM	(2)	125
		18	16.5	K16	950	0.14	0.14			EEVTG1H681M	(2)	125
	1000	18	16.5	K16	950	0.14	0.14			EEVTG1H102M	(2)	125
63	10	8	6.2	E	55	2.2	0.12	EEVTG1J100P	(2)	EEETG1J100P	(5)	1000
	22	8	10.2	F	100	1	0.12	EEVTG1J220P	(2)	EEETG1J220P	(5)	500
	33	(8)	(10.2)	(F)	(100)	(1)	0.12	EEVTG1J330UP	(2)	EEETG1J330UP	(5)	500
		10	10.2	G	150	0.8	0.12	EEVTG1J330P	(2)	EEETG1J330P	(5)	500
	47	(8)	(10.2)	(F)	(100)	(1)	0.12	EEVTG1J470UP	(2)	EEETG1J470UP	(5)	500
		10	10.2	G	150	0.8	0.12	EEVTG1J470P	(2)	EEETG1J470P	(5)	500
	100	(10)	(10.2)	(G)	(150)	(0.8)	0.12	EEVTG1J101UP	(2)	EEETG1J101UP	(5)	500
		12.5	13.5	H13	350	0.26	0.12			EEVTG1J101Q	(2)	200
	220	12.5	13.5	H13	350	0.26	0.12			EEVTG1J221Q	(2)	200
	330	16	16.5	J16	500	0.18	0.12			EEVTG1J331M	(2)	125
	470	16	16.5	J16	500	0.18	0.12			EEVTG1J471M	(2)	125
80	10	8	10.2	F	70	1.3	0.12	EEVTG1K100P	(2)	EEETG1K100P	(5)	500
	22	(8)	(10.2)	(F)	(70)	(1.3)	0.12	EEVTG1K220UP	(2)	EEETG1K220UP	(5)	500
		10	10.2	G	90	1.0	0.12	EEVTG1K220P	(2)	EEETG1K220P	(5)	500
	33	(8)	(10.2)	(F)	(70)	(1.3)	0.12	EEVTG1K330UP	(2)	EEETG1K330UP	(5)	500
		10	10.2	G	90	1.0	0.12	EEVTG1K330P	(2)	EEETG1K330P	(5)	500
	47	(10)	(10.2)	(G)	(90)	(1.0)	0.12	EEVTG1K470UP	(2)	EEETG1K470UP	(5)	500
		12.5	13.5	H13	250	0.42	0.12			EEVTG1K470Q	(2)	200
	100	(12.5)	(13.5)	(H13)	(250)	(0.42)	0.12			EEVTG1K101UQ	(2)	200
		16	16.5	J16	350	0.3	0.12			EEVTG1K101M	(2)	125
	220	(16)	(16.5)	(J16)	(350)	(0.3)	0.12			EEVTG1K221UM	(2)	125
		18	16.5	K16	400	0.28	0.12			EEVTG1K221M	(2)	125
	330	(16)	(16.5)	(J16)	(350)	(0.3)	0.12			EEVTG1K331UM	(2)	125
		18	16.5	K16	400	0.28	0.12			EEVTG1K331M	(2)	125
470	18	16.5	K16	400	0.28	0.12			EEVTG1K471M	(2)	125	

An explanation of the taping dimensions can be found on page 84.

Reflow profiles can be found on page 86.

Endurance: 125°C 1000h - 2000h

■ Standard Products

W.V. (V)	Cap (±20%) (μF)	Case Size			Specification			Part No. (RoHS: not compliant)		Part No. (RoHS: compliant)		Min. Packaging Q'ty
		Dia. (mm)	Length (mm)	Size code	Ripple current (100kHz) (+125°C) (mA)	ESR (100kHz) (+20°C) (Ω)	tan δ (120Hz) (+20°C)		Reflow	Reflow	Taping (pcs)	
100	10	8	10.2	F	70	1.3	0.1	EEVTG2A100P	(2)	EEETG2A100P	(5)	500
	22	(8)	(10.2)	(F)	(70)	(1.3)	0.1	EEVTG2A220UP	(2)	EEETG2A220UP	(5)	500
		10	10.2	G	90	1.0	0.1	EEVTG2A220P	(2)	EEETG2A220P	(5)	500
	33	10	10.2	G	90	1.0	0.1	EEVTG2A330P	(2)	EEETG2A330P	(5)	500
	47	12.5	13.5	H13	250	0.42	0.1			EEVTG2A470Q	(2)	200
	100	16	16.5	J16	350	0.3	0.1			EEVTG2A101M	(2)	125
	220	18	16.5	K16	400	0.28	0.1			EEVTG2A221M	(2)	125
	330	18	16.5	K16	400	0.28	0.1			EEVTG2A331M	(2)	125

An explanation of the taping dimensions can be found on page 84.

Reflow profiles can be found on page 86.

Endurance: 125°C 1000h - 2000h

■ Frequency Correction Factor of Rated Ripple Current

	Frequency (Hz)			
	120	1k	10k	100k~
coefficient	0.65	0.85	0.95	1.00

■ Endurance

EEETG1E221UP (25V220uF, Dia.8x10)

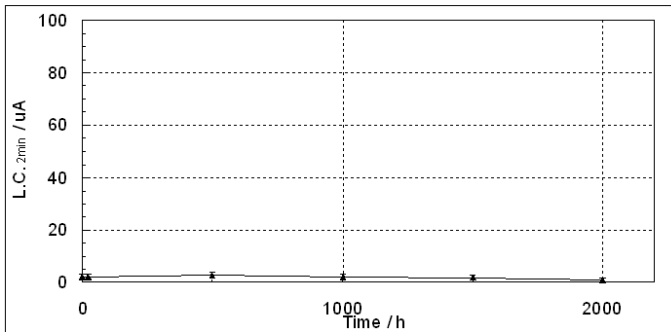
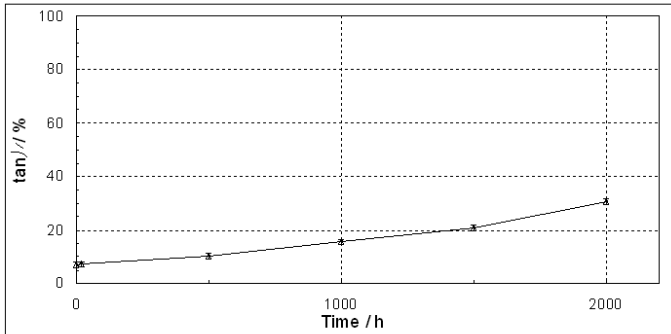
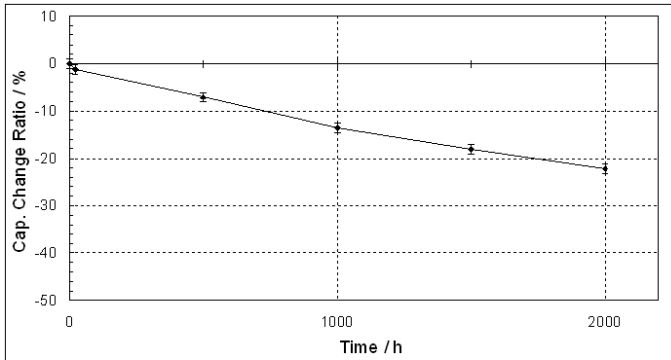

At 125C
Applied W.V.
n=10 each

EEVTG1V101P (35V100uF, Dia.10x10.2)

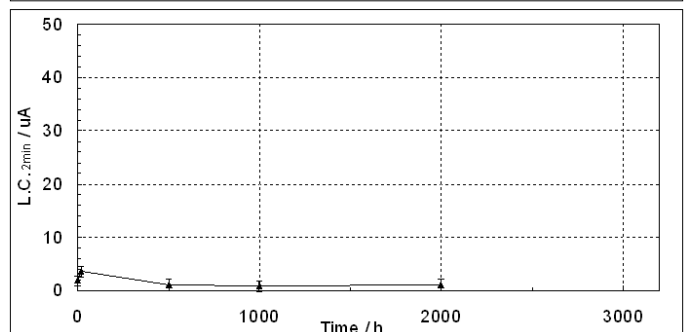
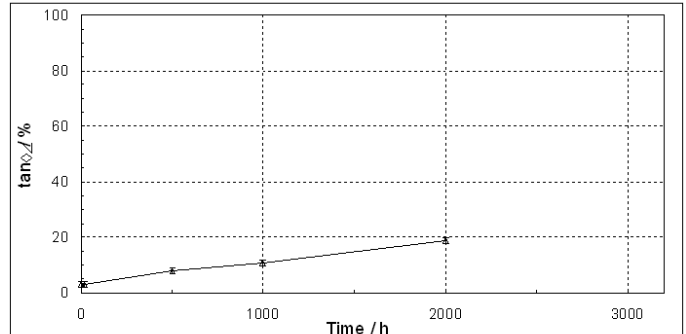
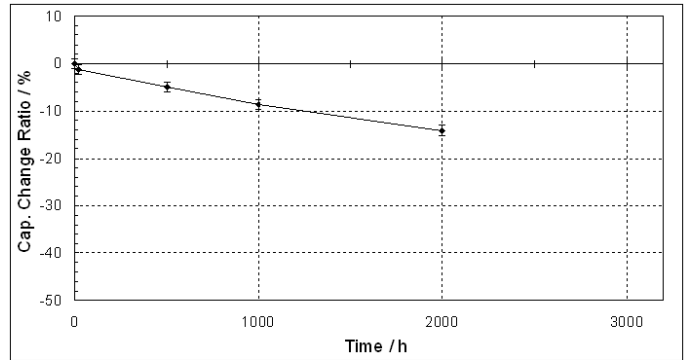

At 125C
Applied W.V.
n=10 each

Temperature Characteristics

EEVTG1A101P (10V, 100 μ F, Dia. 8 x 6.2) n = 3

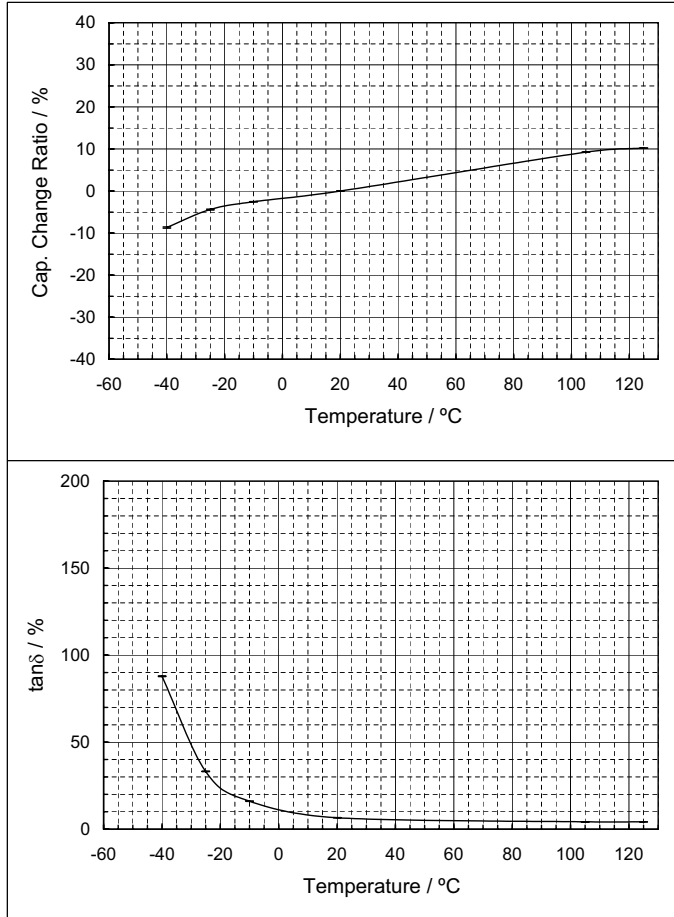

EEVTG1A471P (10V, 470 μ F, Dia. 10 x 10.2) n = 3

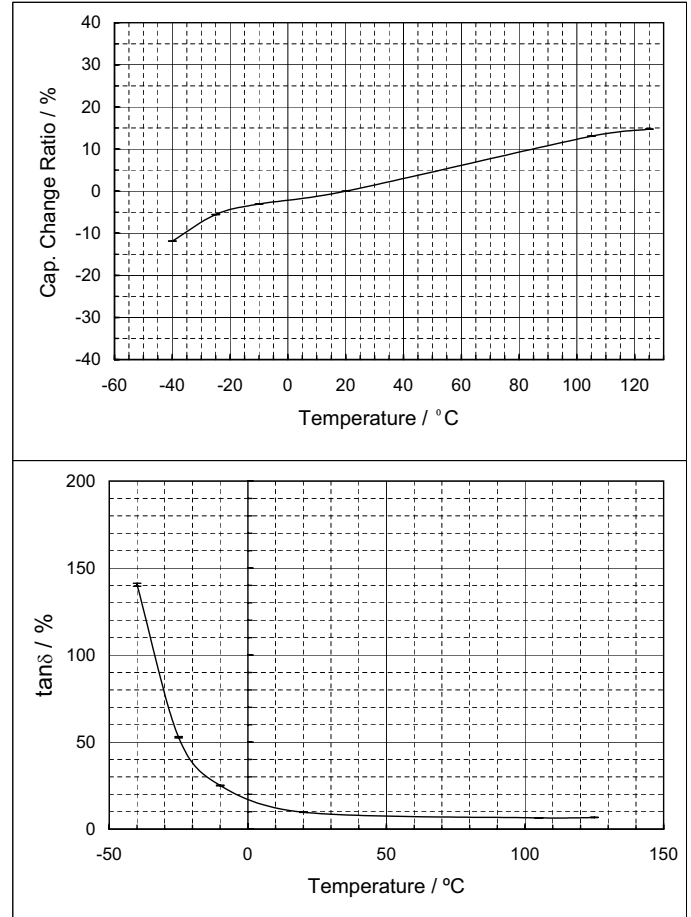

■ Temperature Characteristics

EEVTGK1A101P (10V, 100 μ F, Dia. 8 x 6.2) n=3

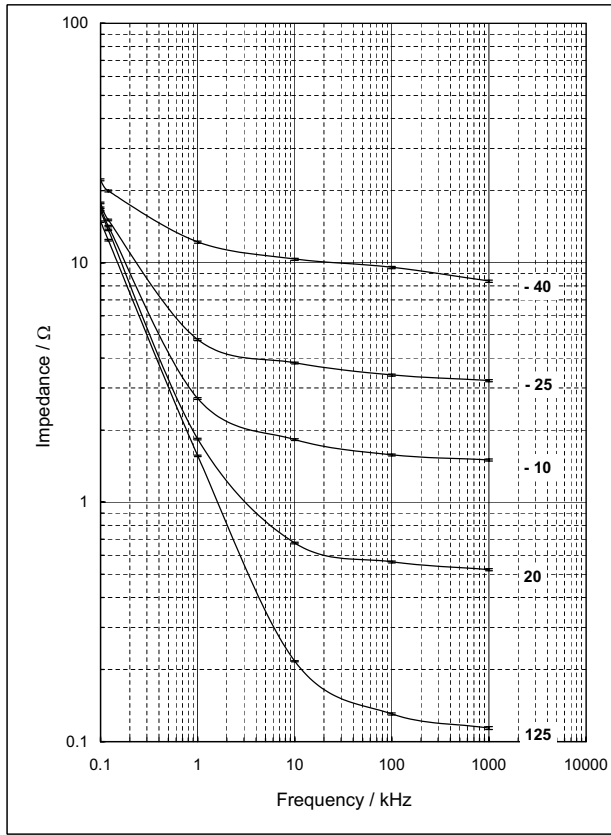

EEVTGK1A101P (10V, 100 μ F, Dia. 8 x 6.2) n=3

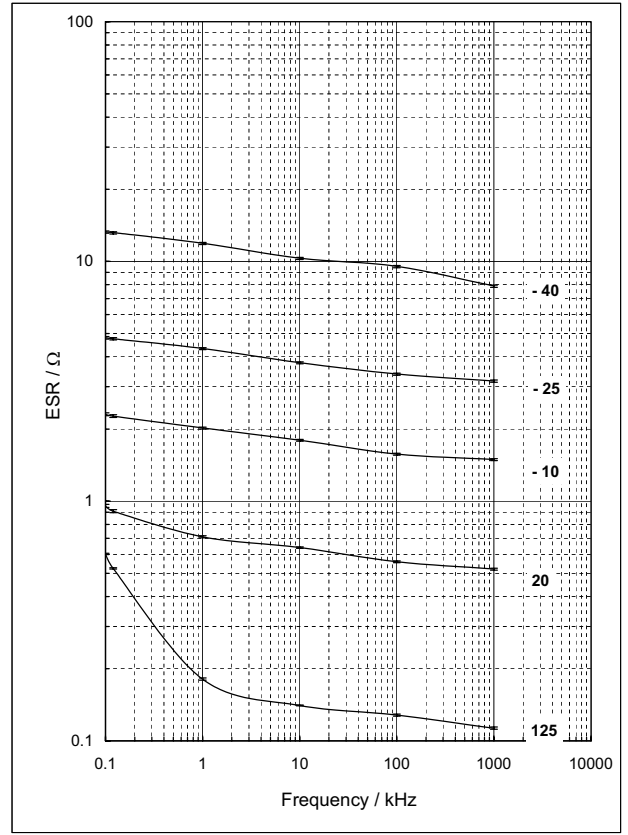

EEVTG1A101P (10V, 100 μ F, Dia. 8 x 6.2) n=3

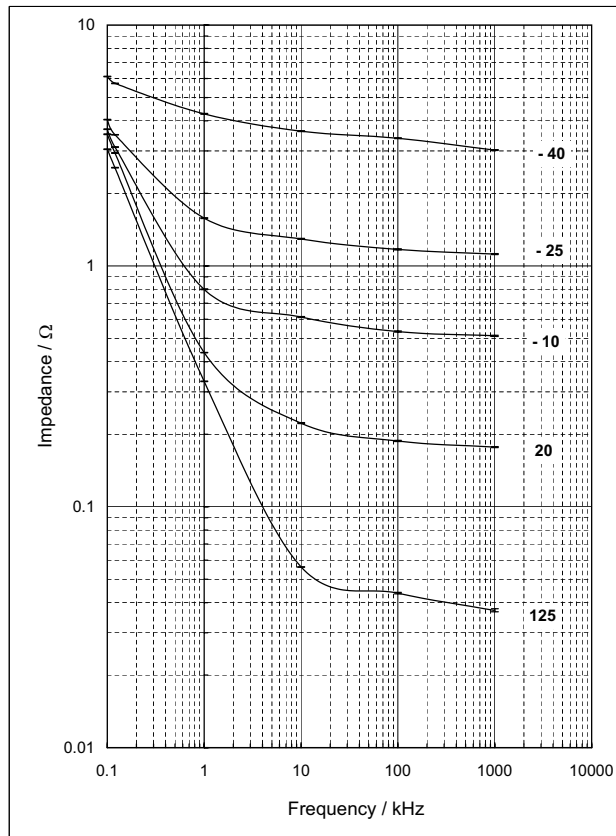

EEVTGK1A101P (10V, 100 μ F, Dia. 8 x 6.2) n=3

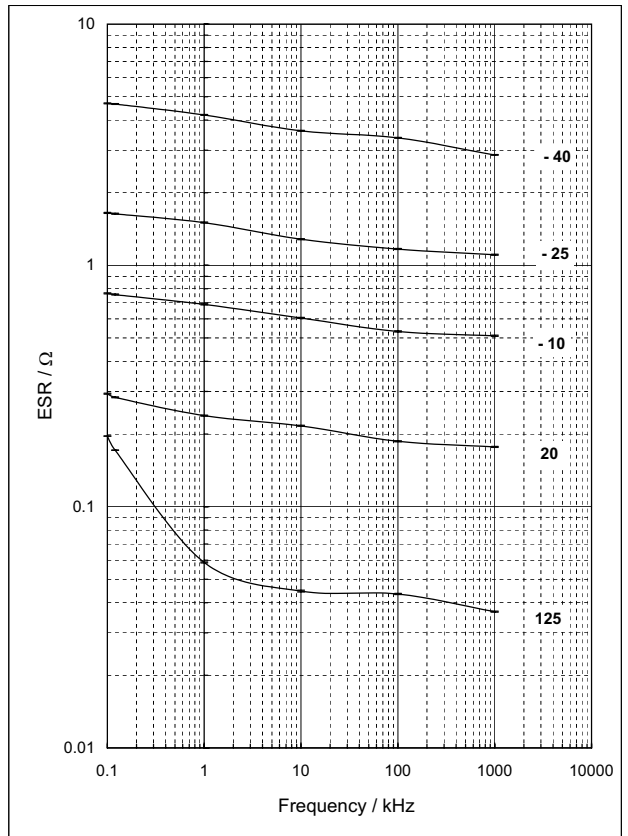

Surface Mount Type

Series: TK Type : V

- Features
 - Life Time: 3000 hours at 125°C
 - Low ESR at -40°C(50%lower than TG series)
 - Added ESR specification after the test
 - RoHS directive compliant



■ Specification

Category Temp.Range	-40 ~ +125°C					
Rated W.V.Range	10 ~ 35 V .DC					
Nominal Cap.Range	47 ~ 470 μ F					
Capacitance Tolerance	±20 % (120Hz/+20°C)					
Leakage Current	I ≤ 0.01 CV or 3(μ A) After 2 minutes application of rated working voltage at +20°C (Whichever is greater)					
tan δ	Please see the attached standard products list					
Characteristics at Low Temperature	W.V. (V)	10	16	25	35	(Impedance ratio at 120Hz)
	Z(-25°C) / Z(+20°C)	3	2	2	2	
	Z(-40°C) / Z(+20°C)	4	3	3	3	
Endurance	After the life test with DC rated working voltage at +125 ±2°C for 3000 hours, the capacitors shall meet the limits specified below. Post-test requirements at +20°C.					
	Capacitance change	±30% of initially measured values(code U:±35%)				
	tan δ	≤300% of initially specified values(code U:350%)				
	DC leakage current	≤initially specified values				
Shelf Life	After storage for 1000 hours at +125±2°C with no voltage applied and then being stabilized at +20°C, capacitors shall meet the limits specified in Endurance.					
ESR after the Life test	After the life test with DC rated working voltage at +125±2°C for 3000 hours, ESR value shall meet the specified below.					
	After 1000 hours	20°C	≤150% of the initially specified value.			
		-40°C	≤200% of the initially specified value.			
	After 2000 hours	20°C	≤300% of the initially specified value.			
		-40°C	≤400% of the initially specified value.			
	After 3000 hours	20°C	≤1000% of the initially specified value.			
		-40°C	≤1500% of the initially specified value.			

■ Marking

Example: 10V470μF(Polarized)

Marking color: BLACK

W.V.code

Negative polarity marking (-)

Capacitance (μF)

Series identification

Lot number

W.V.code				
@ @ V	10	16	25	35
@ Code	A	C	E	V

■ Dimensions in mm(not to scale)

() :reference size

(mm)

Size code	D	L	A,B	H max.	I	W	P	K
F	8.0	10.2	8.3	10.0	3.4	0.90 ±0.2	3.1	0.70 ±0.20
G	10.0	10.2	10.3	12.0	3.5	0.90 ±0.2	4.6	0.70 ±0.20

■ Case size VS Capacitance, ESR and Ripple current

ESR:($\Omega/100\text{kHz}$),

Ripple current (mA r.m.s./100kHz+125°C)

W.V Capacitance (μF)	10				16			
	size	ESR		Ripple current	size	ESR		Ripple current
		20°C	-40°C			20°C	-40°C	
100					F	0.3	5.0	197
220	F	0.3	5.0	197	G (F)	0.2 (0.3)	3.0 (5.0)	270 (197)
330	G (F)	0.2 (0.3)	3.0 (5.0)	270 (197)	(G)	(0.2)	(3.0)	(270)
470	(G)	(0.2)	(3.0)	(270)				

W.V Capacitance (μF)	25				35			
	size	ESR		Ripple current	size	ESR		Ripple current
		20°C	-40°C			20°C	-40°C	
47					F	0.3	5.0	197
100	F	0.3	5.0	197	G (F)	0.2 (0.3)	3.0 (5.0)	270 (197)
220	G (F)	0.2 (0.3)	3.0 (5.0)	270 (197)	(G)	(0.2)	(3.0)	(270)
330	(G)	(0.2)	(3.0)	(270)				

■ Standard Products

W.V. (V)	Cap. ($\pm 20\%$) (μF)	Case size			Specification			Part No. (RoHS: compliant)	Reflow	Min. Packaging Q'ty
		Dia. (mm)	Length (mm)	Size Code	Ripple current (100kHz) (+125°C) (mA)	ESR (100kHz) (+20°C) (Ω)	$\tan \delta$ (120Hz) (+20°C)			Taping (pcs)
10	220	8	10.2	F	197	0.3	0.30	EEETK1A221P	(5)	500
	330	10	10.2	G	270	0.2	0.30	EEETK1A331P	(5)	500
		(8)	(10.2)	(F)	(197)	(0.3)	0.30	EEETK1A331UP	(5)	500
	470	(10)	(10.2)	(G)	(270)	(0.2)	0.30	EEETK1A471UP	(5)	500
16	100	8	10.2	F	197	0.3	0.23	EEETK1C101P	(5)	500
	220	10	10.2	G	270	0.2	0.23	EEETK1C221P	(5)	500
		(8)	(10.2)	(F)	(197)	(0.3)	0.23	EEETK1C221UP	(5)	500
	330	(10)	(10.2)	(G)	(270)	(0.2)	0.23	EEETK1C331UP	(5)	500
25	100	8	10.2	F	270	0.3	0.18	EEETK1E101P	(5)	500
	220	10	10.2	G	270	0.2	0.18	EEETK1E221P	(5)	500
		(8)	(10.2)	(F)	(197)	(0.3)	0.18	EEETK1E221UP	(5)	500
	330	(10)	(10.2)	(G)	(270)	(0.2)	0.18	EEETK1E331UP	(5)	500
35	47	8	10.2	F	197	0.3	0.16	EEETK1V470P	(5)	500
	100	10	10.2	G	270	0.2	0.16	EEETK1V101P	(5)	500
		(8)	(10.2)	(F)	(197)	(0.3)	0.16	EEETK1V101UP	(5)	500
	220	(10)	(10.2)	(G)	(270)	(0.2)	0.16	EEETK1V221UP	(5)	500

Reflow profiles can be found on page 86.

(): Miniaturization type (suffix: U)

■ Endurance

EEETK1C101P (16V100 μ F, Dia.8x10)

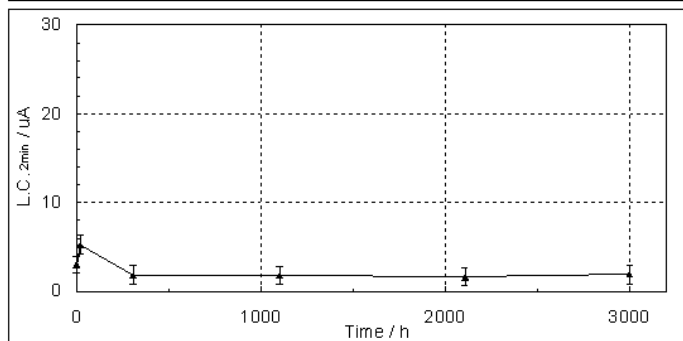
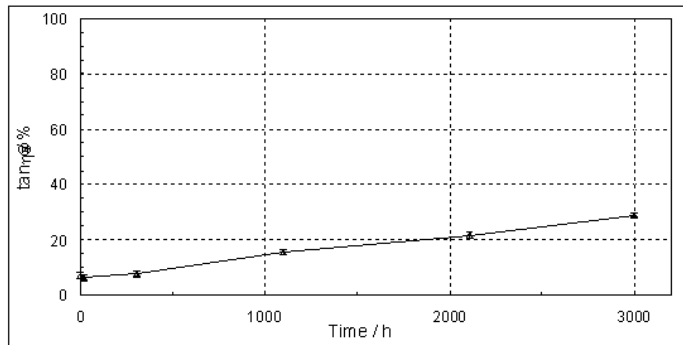
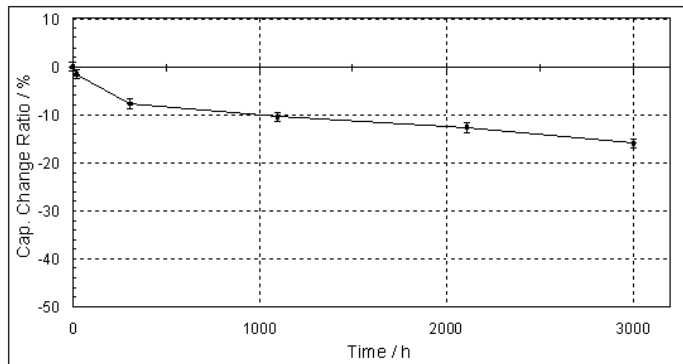

At 125C
Applied W.V.
n=10 each

EEETK1V101P (35V, 100 μ F, Dia.10x10.2)

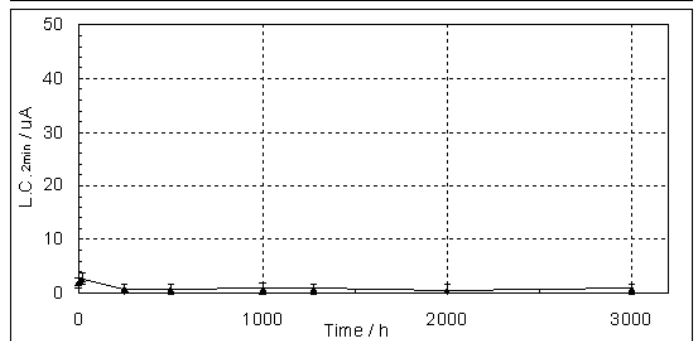
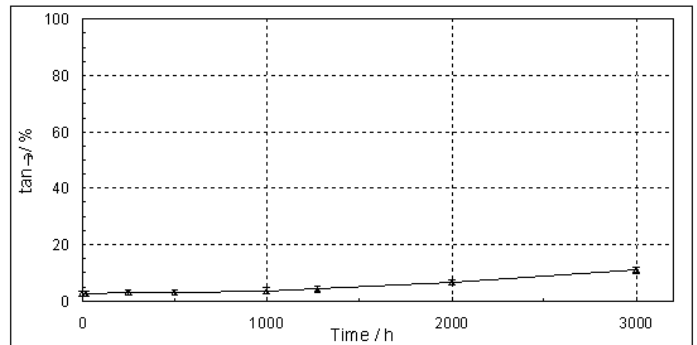
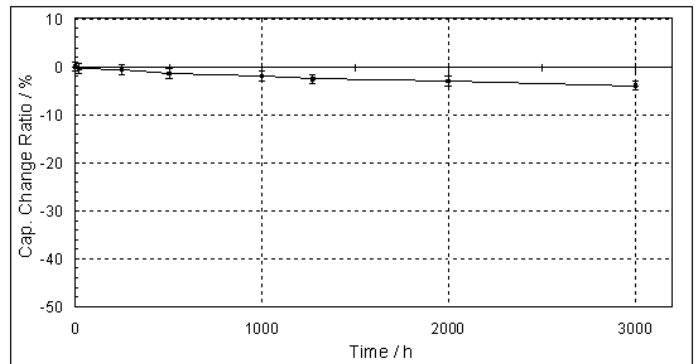

At 125C
Applied W.V.
n=10 each

Temperature Characteristics

EEETK1V101P (35V, 100 μ F, Dia. 8 x 10.2) n=3

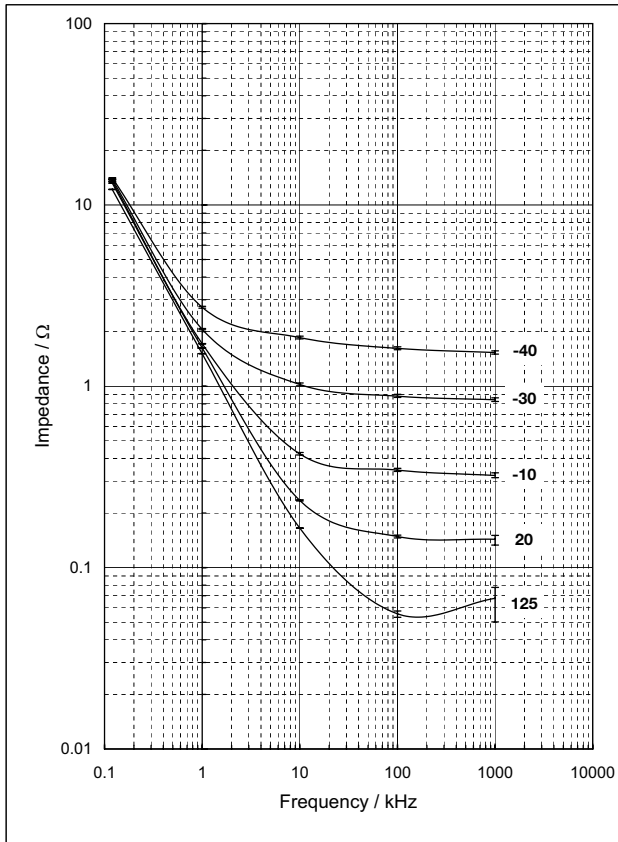

EEETK1V101P (35V, 100 μ F, Dia. 8 x 10.2) n=3

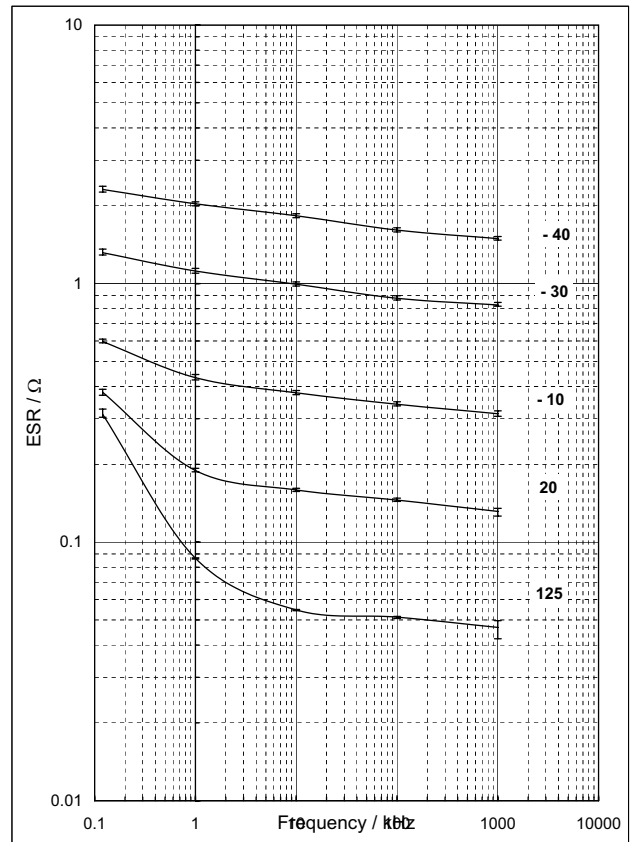

EEETK1V221P (35V, 220 μ F, Dia. 10 x 10.2) n=3

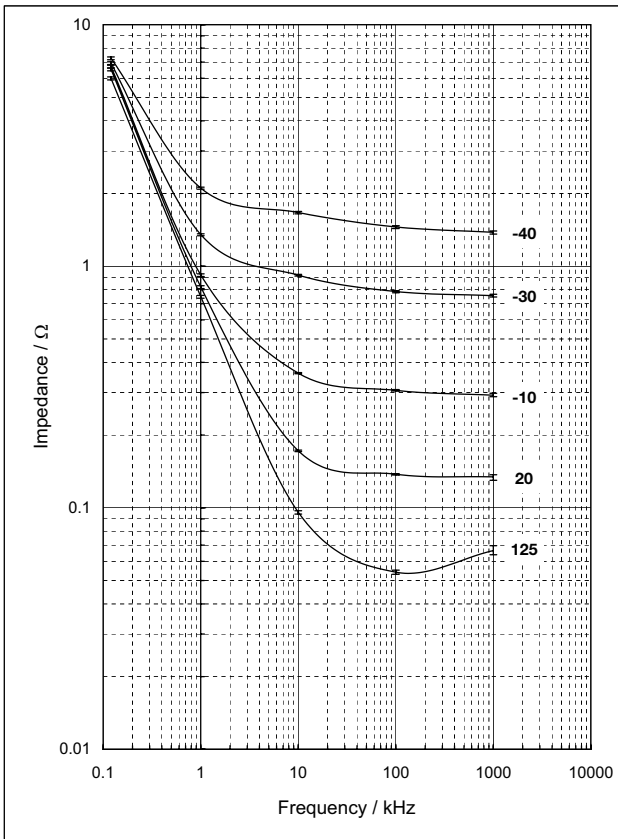

EEETK1V221P (35V, 220 μ F, Dia. 10 x 10.2) n=3

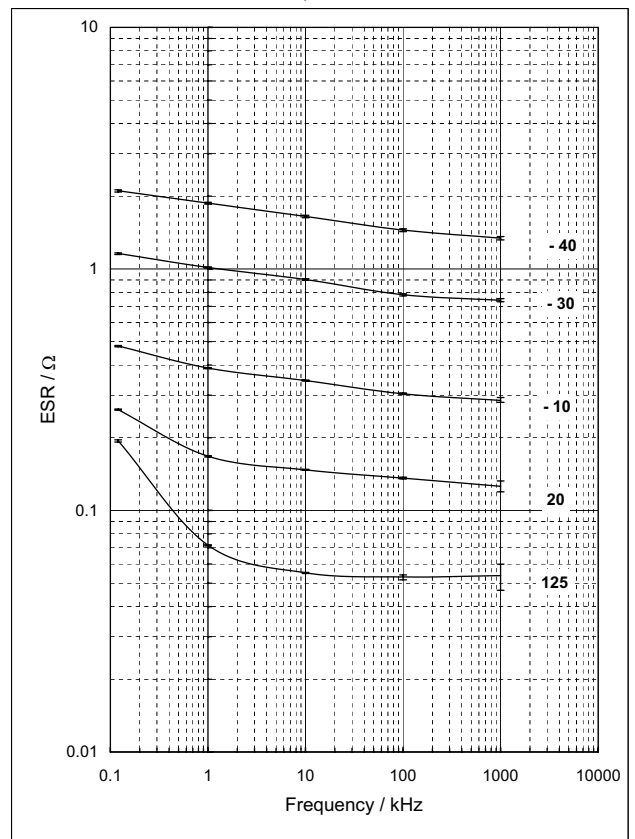

■ Temperature Characteristics

EEVTK1V101P (35V, 100 μ F, Dia. 8 x 10.2) at 120Hz
n = 3

EEVTK1V221UP (35V, 220 μ F, Dia. 10 x 10.2) at 120Hz
n = 3

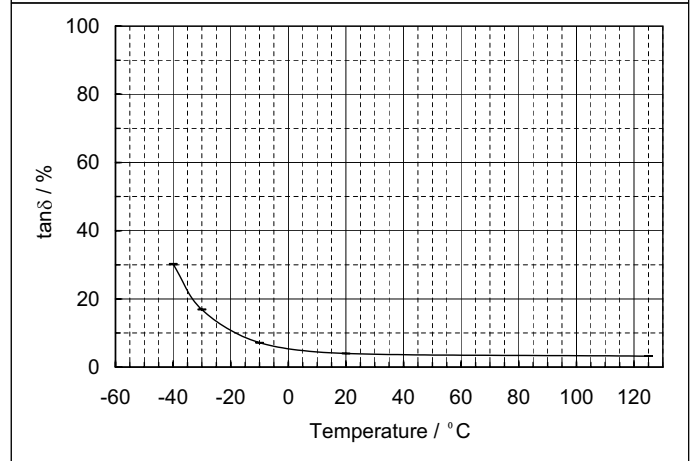
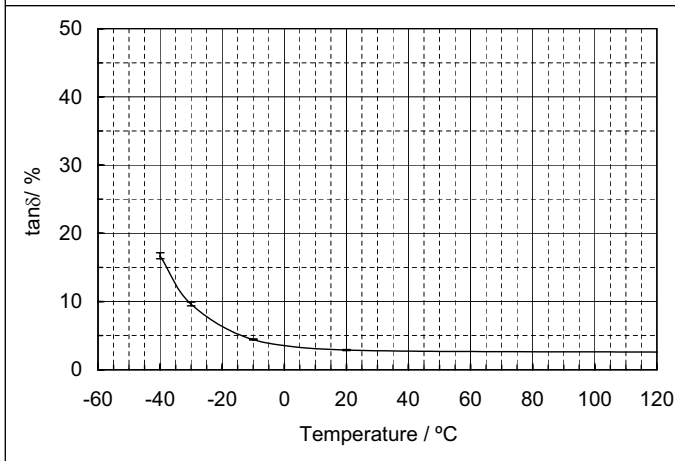
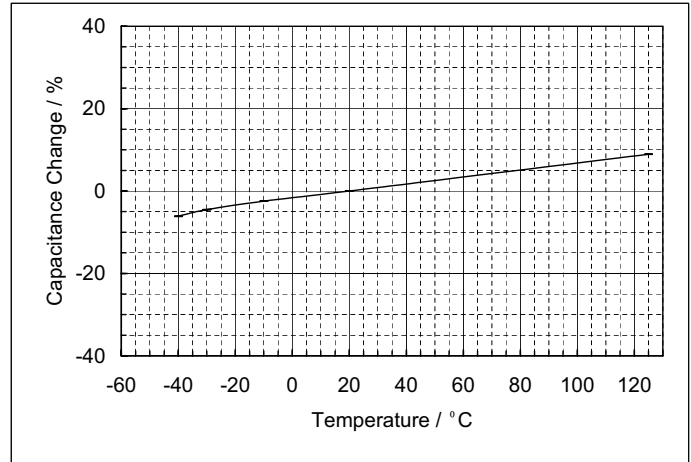
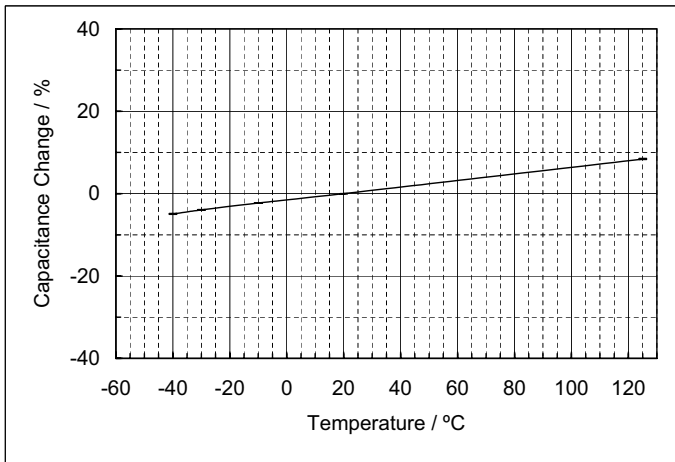

Surface Mount Type

Series: EB(Large Can Size) Type : V

- Features Endurance : 105°C 3000 to 5000 h
Case size : $\phi 10 \times 13.5$ to $\phi 18 \times 21.5$
RoHS directive compliant



■ Specifications

Category temp. range	-25 to +105°C							
Rated W.V. Range	160 to 450 V .DC							
Nominal Cap. Range	2.2 to 100 μ F							
Capacitance Tolerance	$\pm 20\%$ (120Hz/+20°C)							
DC Leakage Current	$I \leq 0.06 CV + 10(\mu A)$ after 2 minutes							
tan δ	Please see the attached standard products list							
Characteristics at Low Temperature	W.V. (V)	160	200	250	350	400	450	(Impedance ratio at 120Hz)
	Z(-25°C)/Z(+20°C)	2	2	3	5	6	6	
Endurance	After following test with DC voltage and +105 \pm 2°C ripple current value applied (The sum of DC and ripple peak voltage shall not exceed the rated working voltage), for 5000 hours, the capacitors shall meet the limits specified below. (Size G13: 3000 h, G17: 4000 h)							
	Capacitance change	$\pm 20\%$ of initial measured value						
	tan δ	$\leq 200\%$ of initial specified value						
	DC leakage current	\leq initial specified value						
Shelf Life	After storage for 1000 hours at +105 \pm 2°C with no voltage applied and then being stabilized at +20°C, capacitors shall meet the limits specified in Endurance.(With voltage treatment)							
Resistance to Soldering Heat	After reflow soldering (Refer to page 86 for recommended temperature profile) and then being stabilized at +20°C, capacitor shall meet the following limits.							
	Capacitance change	$\pm 10\%$ of initial measured value						
	tan δ	\leq initial specified value						
	DC leakage current	\leq initial specified value						

■ Marking

Marking color : BLACK

W.V. code

Negative polarity marking

Capacitance (μ F)

Series identification

W.V. code

Lot number

V	160	200	250	350	400	450
Code	2C	2D	2E	2V	2G	2W

■ Dimensions in mm (not to scale)

():reference size

0.3 max

$\phi D \pm 0.5$

L ± 0.5

A ± 0.2

B ± 0.2

H

I

W

P

K

w

(mm)

■ Case size

W.V.(V) Cap.(μ F)	160(2C)	200(2D)	250(2E)	350(2V)	400(2G)	450(2W)
2.2						G13
3.3				G13	G13	G17
4.7				G17	G17	H16
10	G13	G17	G17	J16	J16	K16
22		H16	J16	K16	J21	K21
33	H16	J16	K16	J21	K21	
47	J16	K16	J21	K21		
68	J21 K16	J21	K21			
100	K21	K21				

Size code	D	L	A,B	H max.	I	W	P	K
G13	10	13.5	10.3	12.0	3.5	0.9 \pm 0.2	4.6	0.7 \pm 0.20
G17	10	16.5	10.3	12.0	3.5	0.9 \pm 0.2	4.6	0.7 \pm 0.20
H16	12.5	16.5	13.5	15.0	4.7	0.9 \pm 0.3	4.4	0.7 \pm 0.30
J16	16	16.5	17.0	19.0	5.5	1.2 \pm 0.3	6.7	0.7 \pm 0.30
J21	16	21.5	17.0	19.0	5.5	1.2 \pm 0.3	6.7	0.7 \pm 0.30
K16	18	16.5	19.0	21.0	6.7	1.2 \pm 0.3	6.7	0.7 \pm 0.30
K21	18	21.5	19.0	21.0	6.7	1.2 \pm 0.3	6.7	0.7 \pm 0.30

■ Standard Products

W.V. (V)	Cap. (±20%) (μF)	Case size			Specification			Part No. (RoHS: compliant)	Reflow	Min. Packaging Q'ty
		Dia. (mm)	Length (mm)	Size Code	Ripple current (100kHz) (+105°C) (mA)	tan δ (120Hz) (+20°C)	Endur- ance (+105°C) (hours)			Taping (pcs)
160	10	10	13.5	G13	70	0.15	3000	EEVEB2C100Q	(3)	250
	33	12.5	16.5	H16	470	0.15	5000	EEVEB2C330SQ	(3)	150
	47	16	16.5	J16	600	0.15	5000	EEVEB2C470SM	(3)	125
	68	16	21.5	J21	750	0.15	5000	EEVEB2C680M	(3)	75
	18	16.5	K16	750	0.15	5000	EEVEB2C680SM	(3)	125	
100	18	21.5	K21	1060	0.15	5000	EEVEB2C101M	(3)	75	
200	10	10	16.5	G17	80	0.15	4000	EEVEB2D100Q	(3)	200
	22	12.5	16.5	H16	470	0.15	5000	EEVEB2D220SQ	(3)	150
	33	16	16.5	J16	600	0.15	5000	EEVEB2D330SM	(3)	125
	47	18	16.5	K16	600	0.15	5000	EEVEB2D470SM	(3)	125
	68	16	21.5	J21	750	0.15	5000	EEVEB2D680M	(3)	75
	100	18	21.5	K21	1060	0.15	5000	EEVEB2D101M	(3)	75
250	10	10	16.5	G17	88	0.15	4000	EEVEB2E100Q	(3)	200
	22	16	16.5	J16	560	0.15	5000	EEVEB2E220SM	(3)	125
	33	18	16.5	K16	560	0.15	5000	EEVEB2E330SM	(3)	125
	47	16	21.5	J21	710	0.15	5000	EEVEB2E470M	(3)	75
	68	18	21.5	K21	990	0.15	5000	EEVEB2E680M	(3)	75
350	3.3	10	13.5	G13	38	0.20	3000	EEVEB2V3R3Q	(3)	250
	4.7	10	16.5	G17	50	0.20	4000	EEVEB2V4R7Q	(3)	200
	10	16	16.5	J16	270	0.20	5000	EEVEB2V100SM	(3)	125
	22	18	16.5	K16	350	0.20	5000	EEVEB2V220SM	(3)	125
	33	16	21.5	J21	480	0.20	5000	EEVEB2V330M	(3)	75
	47	18	21.5	K21	670	0.20	5000	EEVEB2V470M	(3)	75
400	3.3	10	13.5	G13	40	0.24	3000	EEVEB2G3R3Q	(3)	250
	4.7	10	16.5	G17	50	0.24	4000	EEVEB2G4R7Q	(3)	200
	10	16	16.5	J16	250	0.24	5000	EEVEB2G100SM	(3)	125
	22	16	21.5	J21	410	0.24	5000	EEVEB2G220M	(3)	75
	33	18	21.5	K21	600	0.24	5000	EEVEB2G330M	(3)	75
450	2.2	10	13.5	G13	29	0.24	3000	EEVEB2W2R2Q	(3)	250
	3.3	10	16.5	G17	41	0.24	4000	EEVEB2W3R3Q	(3)	200
	4.7	12.5	16.5	H16	49	0.24	5000	EEVEB2W4R7SQ	(3)	150
	10	18	16.5	K16	310	0.24	5000	EEVEB2W100SM	(3)	125
	22	18	21.5	K21	560	0.24	5000	EEVEB2W220M	(3)	75

An explanation of the taping dimensions can be found on page 84.

Reflow profiles can be found on page 86.

■ Frequency Correction Factor of Rated Ripple Current

(V.DC)	Frequency (Hz)			
	120	1k	10k~30k	30k~100k
160 to 250V	0.55	0.85	0.90	1.00
350 to 450V	0.50	0.80	0.90	1.00

■ Endurance

EEUEB2G100 (400V10 μ F, ϕ 16x16.5L)

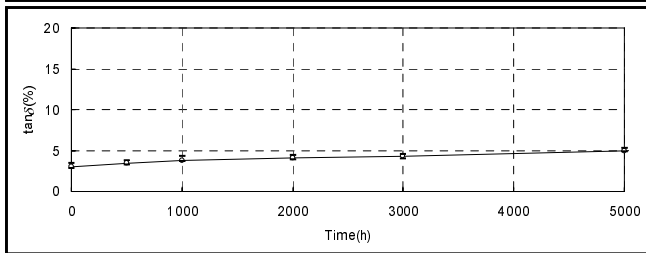
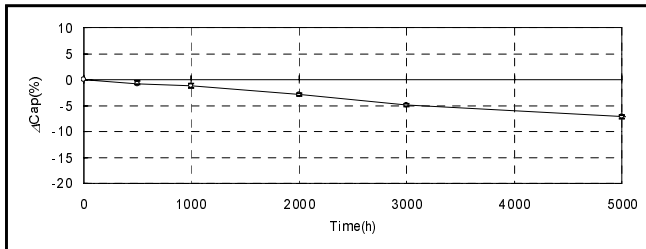

EEVEB2E470 (250V47 μ F, ϕ 16x21.5L)

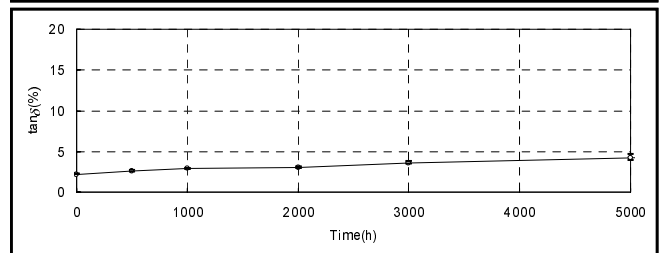
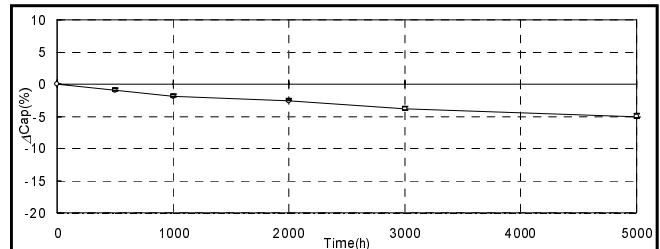

■ Temperature Characteristics

EEUEB2G100 (400V10 μ F, ϕ 16x16.5L)

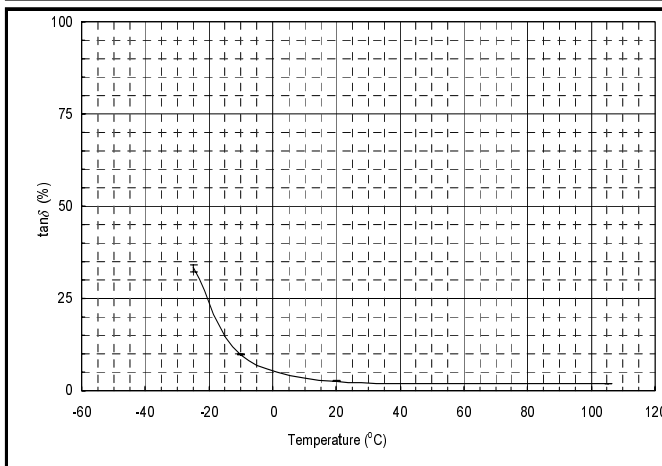
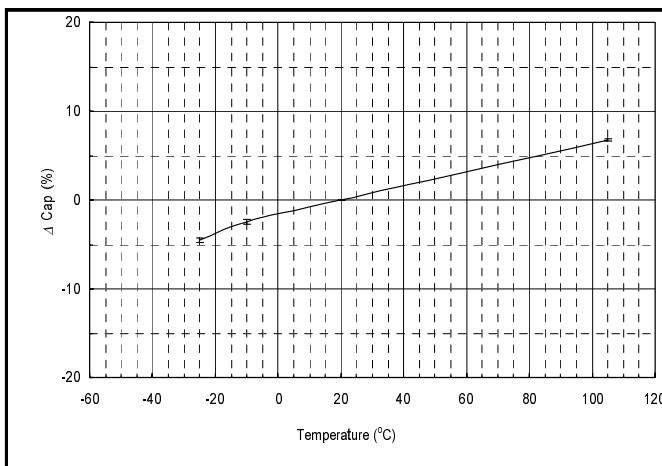

EEVEB2E470 (250V47 μ F, ϕ 16x21.5L)

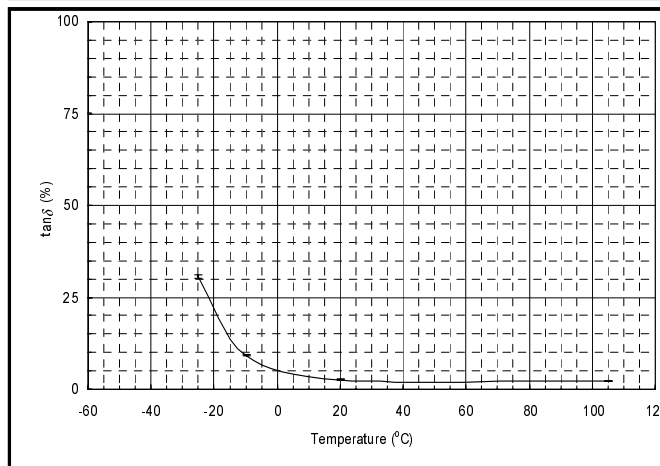
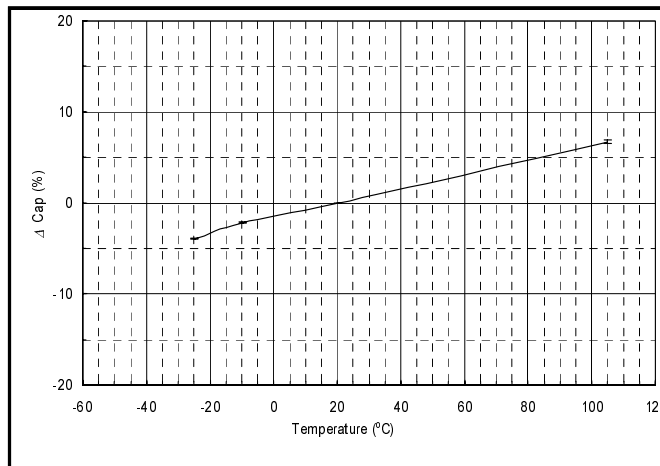

■ Frequency Characteristics

EEVEB2G100 (400V10 μ F, ϕ 16x16.5L)

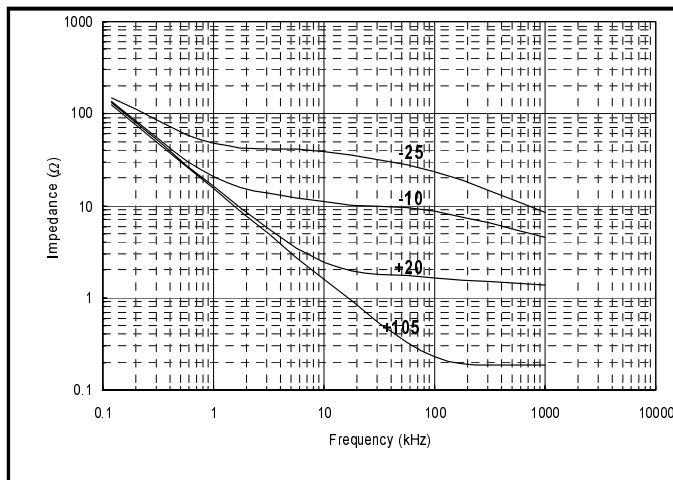

EEVEB2E470 (250V47 μ F, ϕ 16x21.5L)

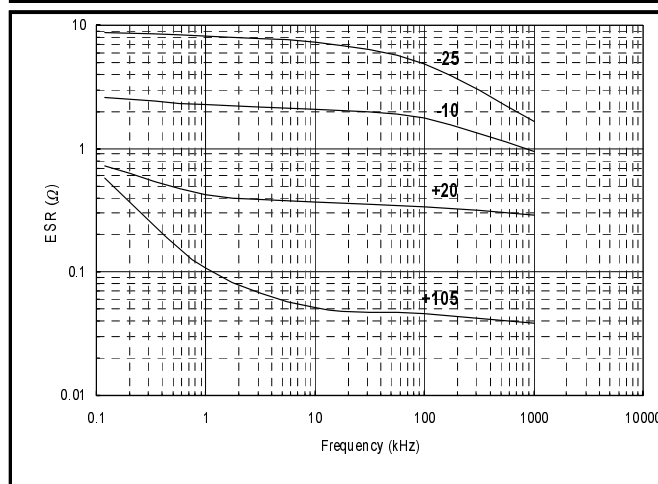
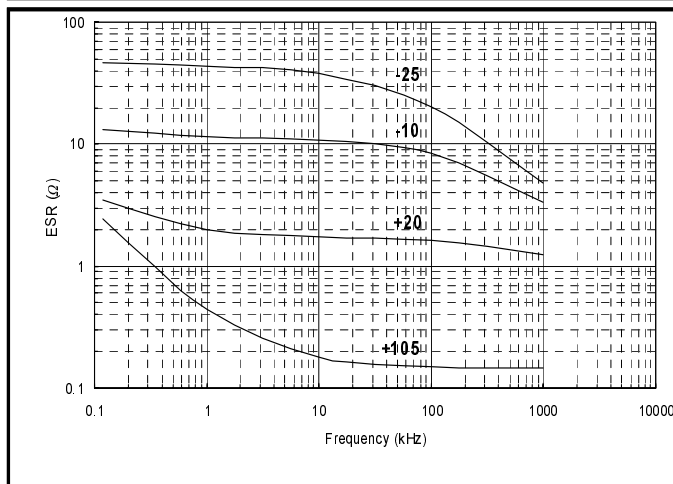
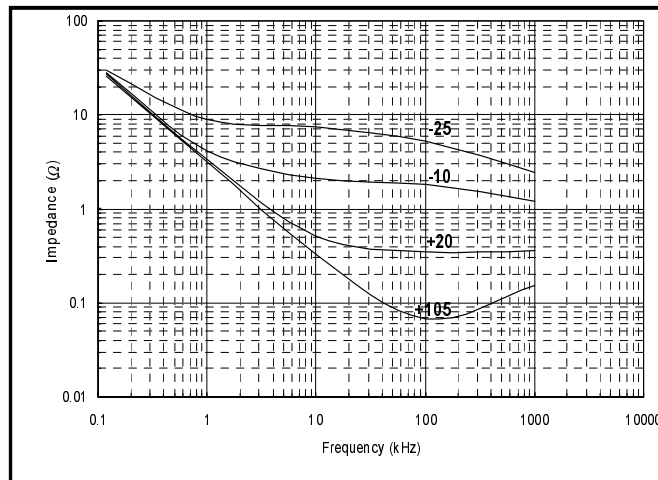

■ ISO/QS Certified

(1) Quality Approval

Factory	Applicable Standard	Item	Organization Certificate Number	Acquisition Year
Panasonic Electronic Devices Co. Capacitor Business Unit	ISO 9001	1.Aluminum Electrolytic Capacitors 2.Specialty Polymer Aluminum Electrolytic Capacitors 3.Electric Double Layer Capacitors	JQA JQA-2524	Jul./'98
	QS - 9000	Aluminum Electrolytic Capacitors for Automobile		
Panasonic Electronic Devices Yamaguchi Co.	ISO 9001	Aluminum Electrolytic Capacitors		
	QS - 9000	Aluminum Electrolytic Capacitors for Automobile		
Panasonic Electronic Devices Corporation of America	ISO 9002	1.Aluminum Electrolytic Capacitors 2.Formed Aluminum Anode Foil for Electrolytic Applications	JQA JQA-2498	Jul./'98
			BSI FM24947	Jul./'93
MEDEM Matsushita Electronic Devices (Malaysia) Sdn.Bhd.	ISO 9002	Aluminum Electrolytic Capacitors	SIRIM AR1681	Jul./'94
	QS-9000	Miniature Aluminum Electrolytic Capacitors	SIRIM AR1681	Apr./'99
Panasonic Manufacturing Xiamen	ISO 9001 TS16949	Aluminum Electrolytic Capacitors	CQC 3502	Jul./'03

(2) Environment Approval

Factory	Applicable Standard	Scope of Registration	Organization Certificate Number	Acquisition Year
Panasonic Electronic Devices Co. Capacitor Business Unit	ISO14001	1.Aluminum Electrolytic Capacitors 2.Electric Double Layer Capacitors 3.Aluminum Electrode Foils. The development, design, and manufacturing of the above-mentioned	JQA JQA-EM1015	Dec./'96
Panasonic Electronic Devices Yamaguchi Co.	ISO 14001	The development, design, and manufacturing of Aluminum Electrolytic Capacitors	JQA JQA-EM1015	Dec./'97
Panasonic Electronic Devices Corporation of America	ISO 14001	1.Aluminum Electrolytic Capacitors 2.Aluminum Electrode Foil The manufacturing of the above-mentioned	AWM 00012	Feb./'98
MEDEM Matsushita Electronic Devices (Malaysia) Sdn.Bhd.	ISO 14001	The manufacturing of Aluminum Electrolytic Capacitors	SIRIM M014101108	Oct./'98

⚠ Application Guidelines

1. Circuit Design

Ensure that operational and mounting conditions follow the specified conditions detailed in the catalog and specification sheets.

1.1 Operating Temperature and Frequency

Electrolytic capacitor electrical parameters are normally specified at 20°C temperature and 120Hz frequency. These parameters vary with changes in temperature and frequency. Circuit designers should take these changes into consideration.

- (1) Effects of operating temperature on electrical parameters
 - a) At higher temperatures, leakage current and capacitance increase while equivalent series resistance (ESR) decreases.
 - b) At lower temperatures, leakage current and capacitance decrease while equivalent series resistance (ESR) increases.
- (2) Effects of frequency on electrical parameters
 - a) At higher frequencies, capacitance and impedance decrease while $\tan \delta$ increases.
 - b) At lower frequencies, ripple current generated heat will rise due to an increase in equivalent

series resistance (ESR).

1.2 Operating Temperature and Life Expectancy

- (1) Expected life is affected by operating temperature. Generally, each 10°C reduction in temperature will double the expected life. Use capacitors at the lowest possible temperature below the maximum guaranteed temperature.

- (2) If operating conditions exceed the maximum guaranteed limit, rapid electrical parameter deterioration will occur, and irreversible damage will result.

Check for maximum capacitor operating temperatures including ambient temperature, internal capacitor temperature rise caused by ripple current, and the effects of radiated heat from power transistors, IC's or resistors.

Avoid placing components which could conduct heat to the capacitor from the back side of the circuit board.

- (3) The formula for calculating expected life at lower operating temperatures is as follows;

$$L_2 = L_1 \times 2^{\frac{T_1 - T_2}{10}} \text{ where,}$$

L1: Guaranteed life (h) at temperature, T1 °C

L2: Expected life (h) at temperature, T2 °C

T1: Maximum operating temperature (°C)

T2: Actual operating temperature, ambient temperature + temperature rise due to ripple current heating (°C)

A quick reference capacitor guide for estimating expected life is included for your reference.

■ Expected Life Estimate Quick Reference Guide

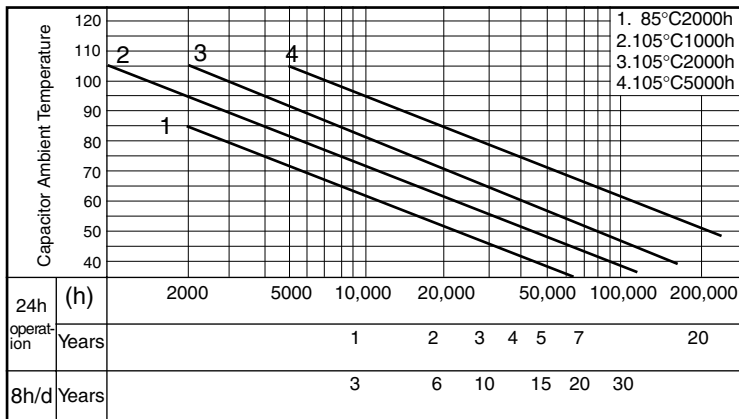

■ Failure rate curve

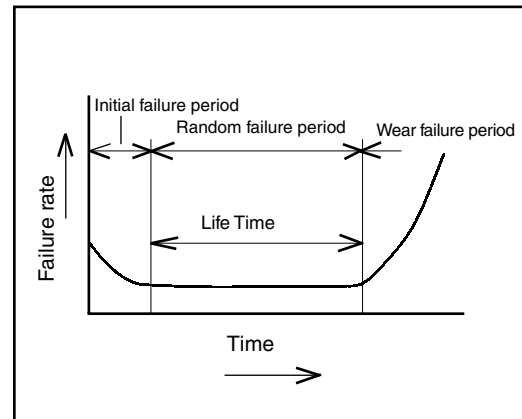

■ Typical failure modes and their factors

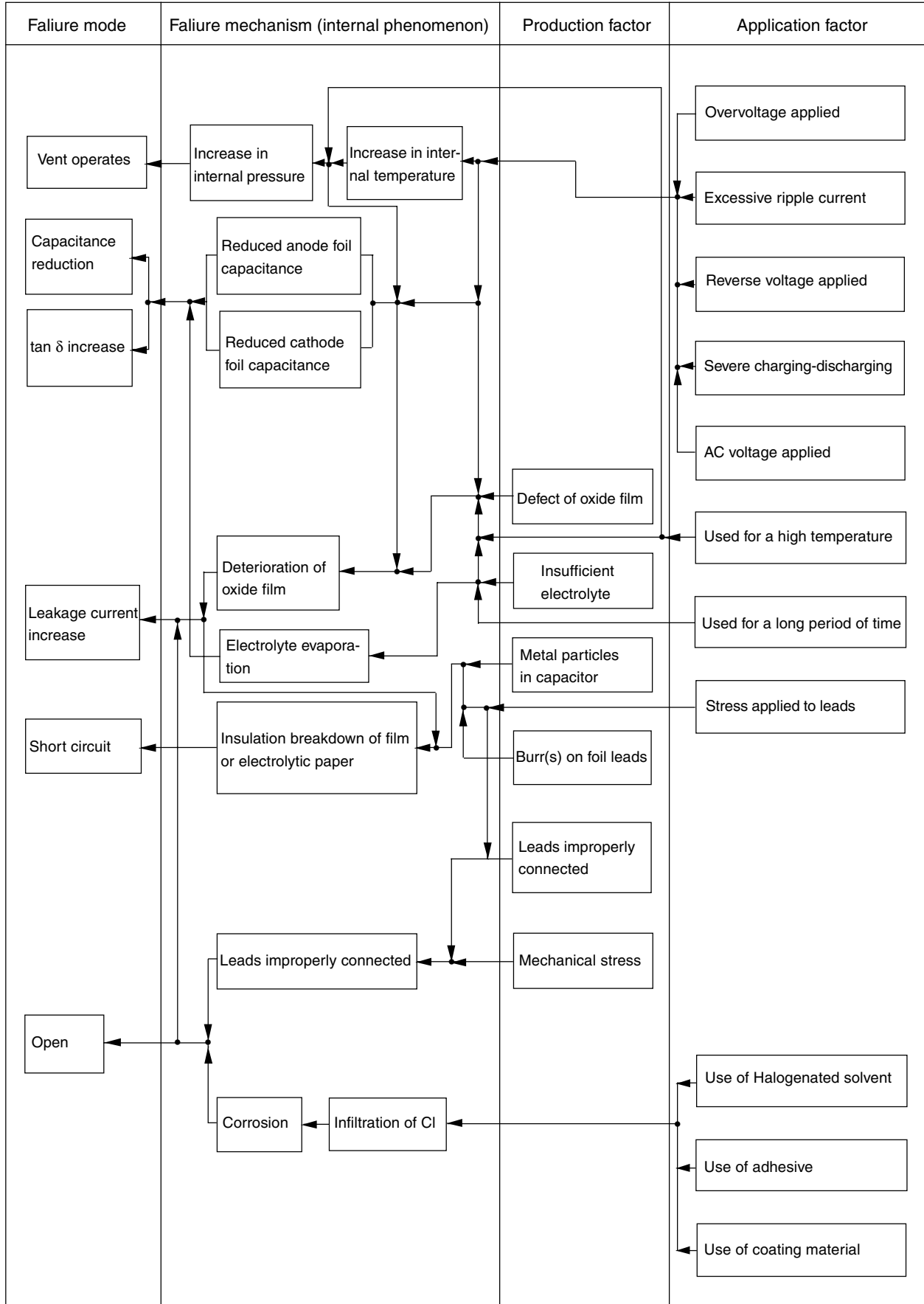

1.3 Common Application Conditions to Avoid

The following misapplication load conditions will cause rapid deterioration to capacitor electrical parameters. In addition, rapid heating and gas generation within the capacitor can occur causing the pressure relief vent to operate and resultant leakage of electrolyte. Under extreme conditions, explosion and fire could result. Leaking electrolyte is combustible and electrically conductive.

(1) Reverse Voltage

DC capacitors have polarity. Verify correct polarity before insertion. For circuits with changing or uncertain polarity, use DC bipolar capacitors. DC bipolar capacitors are not suitable for use in AC circuits.

(2) Charge/Discharge Applications

Standard capacitors are not suitable for use in repeating charge/discharge applications. For charge/discharge applications consult us and advise actual conditions.

(3) Overvoltage

Do not apply voltages exceeding the maximum specified rated voltages. Voltage up to the surge voltage rating are acceptable for short periods of time. Ensure that the sum of the DC voltage and the superimposed AC ripple voltage does not exceed the rated voltage.

(4) Ripple Current

Do not apply ripple currents exceeding the maximum specified value. For high ripple current applications, use a capacitor designed for high ripple currents or contact us with your requirements.

Ensure that allowable ripple currents superimposed on low DC bias voltages do not cause reverse voltage conditions.

1.4 Using Two or More Capacitors in Series or Parallel

(1) Capacitors Connected in Parallel

The circuit resistance can closely approximate the series resistance of the capacitor causing an imbalance of ripple current loads within the capacitors. Careful design of wiring methods can minimize the possibility of excessive ripple currents applied to a capacitor.

(2) Capacitors Connected in Series

Normal DC leakage current differences among capacitors can cause voltage imbalances. The use of voltage divider shunt resistors with consideration to leakage currents, can prevent capacitor voltage imbalances.

1.5 Capacitor Mounting Considerations

(1) Double - Sided Circuit Boards

Avoid wiring pattern runs which pass between the mounted capacitor and the circuit board. When dipping into a solder bath, excess solder may collect under the capacitor by capillary action and shortcircuit the anode and cathode terminals.

(2) Circuit Board Hole Positioning

The vinyl sleeve of the capacitor can be damaged if solder passes through a lead hole for subsequently processed parts. Special care when locating hole positions in proximity to capacitors is recommended.

(3) Circuit Board Hole Spacing

The circuit board holes spacing should match the capacitor lead wire spacing within the specified tolerances. Incorrect spacing can cause excessive lead wire stress during the insertion process. This may result in premature capacitor failure due to short or open circuit, increased leakage current, or electrolyte leakage.

(4) Land/Pad Pattern

The circuit board land/pad pattern size for chip capacitors is specified in the following table.

[Table of Board Land Size vs. Capacitor Size]

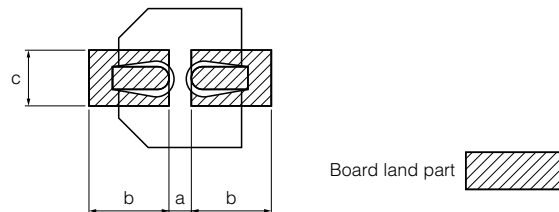

(mm)

Size	a	b	c
A($\phi 3$)	0.6	2.2	1.5
B($\phi 4$)	1.0	2.5	1.6
C($\phi 5$)	1.5	2.8	1.6
D($\phi 6.3$)	1.8	3.2	1.6
E($\phi 8 \times 6.2L$)	2.2	4.0	1.6
F($\phi 8 \times 10.2L$)	3.1	4.0	2.0
G($\phi 10 \times 10.2L$)	4.6	4.1	2.0
H($\phi 12.5$)	4.0	5.7	2.0
J($\phi 16$)	6.0	6.5	2.5
K($\phi 18$)	6.0	7.5	2.5

When size a is wide, back fillet can not be made, decreasing fitting strength.

※Take mounting conditions, solderability and fitting strength into consideration when selecting parts for your company's design.

(5) Clearance for Case Mounted Pressure Relief Vents

Capacitors with case mounted pressure relief vents require sufficient clearance to allow for proper vent operation. The minimum clearances are dependent on capacitor diameters as follows.

- φ6.3 to φ16 mm : 2 mm minimum,
- φ18 to φ35 mm : 3 mm minimum.
- φ40 mm or greater: 5 mm minimum

(6) Clearance for Seal Mounted Pressure Relief Vents

A hole in the circuit board directly under the seal vent location is required to allow proper release of pressure.

(7) Wiring Near the Pressure Relief Vent

Avoid locating high voltage or high current wiring or circuit board paths above the pressure relief vent. Flammable, high temperature gas exceeding 100°C may be released which could dissolve the wire insulation and ignite.

(8) Circuit Board Patterns Under the Capacitor

Avoid circuit board runs under the capacitor as electrolyte leakage could cause an electrical short.

1.6 Electrical Isolation of the Capacitor

Completely isolate the capacitor as follows.

- Between the cathode and the case (except for axially leaded B types) and between the anode terminal and other circuit paths.
- Between the extra mounting terminals (on T types) and the anode terminal, cathode terminal, and other circuit paths.
- Be careful of sympathetic vibration after mounting on the board, mechanical stress will adversely affect the mounting strength and electrical characteristics .
Use reinforcements like adhesive for large size products when the capacitor is mounted horizontally on a vertically positioned circuit board.

1.7 Capacitor Sleeve

The vinyl sleeve or laminate coating is intended for marking and identification purposes and is not meant to electrically insulate the capacitor.

The sleeving may split or crack if immersed into solvents such as toluene or xylene, and then exposed to high temperatures.

Always consider safety when designing equipment and circuits. Plan for worst case failure modes such as short circuits and open circuits which could occur during use.

- (1) Provide protection circuits and protection devices to allow safe failure modes.
- (2) Design redundant or secondary circuits where possible to assure continued operation in case of main circuit failure.

2. Capacitor Handling Techniques

2.1 Considerations Before Using

- (1) Capacitors have a finite life. Do not reuse or recycle capacitors from used equipment.
- (2) Transient recovery voltage may be generated in the capacitor due to dielectric absorption. If required, this voltage can be discharged with a resistor with a value of about 1 kΩ.
- (3) Capacitors stored for long periods of time may exhibit an increase in leakage current. This can be corrected by gradually applying rated voltage in series with a resistor of approximately 1 kΩ.
- (4) If capacitors are dropped, they can be damaged mechanically or electrically. Avoid using dropped capacitors.
- (5) Dented or crushed capacitors should not be used. The seal integrity can be compromised and loss of electrolyte/shortened life can result.

2.2 Capacitor Insertion

- (1) Verify the correct capacitance and rated voltage of the capacitor.
- (2) Verify the correct polarity of the capacitor before inserting.
- (3) Verify the correct hole spacing before insertion (land pattern size on chip type) to avoid stress on the terminals.
- (4) Ensure that the auto insertion equipment lead clinching operation does not stress the capacitor leads where they enter the seal of the capacitor. For chip type capacitors, excessive mounting pressure can cause high leakage current, short circuit, or disconnection.

2.3 Manual Soldering

- (1) Observe temperature and time soldering specifications or do not exceed temperatures of 350°C for 3 seconds or less.
- (2) If lead wires must be formed to meet terminal board hole spacing, avoid stress on the leadwire where it enters the capacitor seal.
- (3) If a soldered capacitor must be removed and reinserted, avoid excessive stress to the capacitor leads.
- (4) Avoid touching the tip of the soldering iron to the capacitor, to prevent melting of the vinyl sleeve.

2.4 Flow Soldering

- (1) Do not immerse the capacitor body into the solder bath as excessive internal pressure could result.
- (2) Observe proper soldering conditions, (temperature, time, etc.).
Do not exceed the specified limits.
- (3) Do not allow other parts or components to touch the capacitor during soldering.

2.5 Reflow Soldering for Chip Capacitors

- (1) For reflow, use a thermal conduction system such as infrared radiation (IR) or hot blast. Vapor heat transfer systems (VPS) are not recommended.

- (2) Observe proper soldering conditions (temperature, time, etc.). Do not exceed the specified limits.
- (3) Reflow should be performed one time. Consult us for additional reflow restrictions.

2.6 Other Soldering Considerations

Rapid temperature rises during the preheat operation and resin bonding operation can cause cracking of the capacitor vinyl sleeve. For heat curing, do not exceed 150°C for a maximum time of 2 minutes.

2.7 Capacitor Handling after Soldering

- (1) Avoid movement of the capacitor after soldering to prevent excessive stress on the leadwires where they enter the seal.
- (2) Do not use the capacitor as a handle when moving the circuit board assembly.
- (3) Avoid striking the capacitor after assembly to prevent failure due to excessive shock.

2.8 Circuit Board Cleaning

- (1) Circuit boards can be immersed or ultrasonically cleaned using suitable cleaning solvents for up to 5 minutes and up to 60°C maximum temperatures. The boards should be thoroughly rinsed and dried.

Recommended cleaning solvents include Pine Alpha ST-100S, Sunelec B-12, DK Beclear CW-5790, Aqua Cleaner 210SEP, Cold Cleaner P3-375, Telpen Cleaner EC-7R, Clean-thru 750H, Clean-thru 750L, Clean thru 710M, Techno Cleaner 219, Techno Care FRW-17, Techno Care FRW-1, Techno Care FRV-1, IPA (isopropyl alcohol)

- * The use of ozone depleting cleaning agents are not recommended in the interest of protecting the environment.
- (2) Avoid using the following solvent groups unless specifically allowed for in the specification;
 - Halogenated cleaning solvents: except for solvent resistant capacitor types, halogenated solvents can permeate the seal and cause internal capacitor corrosion and failure. For solvent resistant capacitors, carefully follow the temperature and time requirements of the specification. 1-1-1 trichloroethane should never be used on any aluminium electrolytic capacitor.
 - Alkali solvents: could attack and dissolve the aluminum case.
 - Petroleum based solvents: deterioration of the rubber seal could result.
 - Xylene: deterioration of the rubber seal could result.
 - Acetone: removal of the ink markings on the vinyl sleeve could result.

- (3) A thorough drying after cleaning is required to remove residual cleaning solvents which may be trapped between the capacitor and the circuit board. Avoid drying temperatures which exceed the maximum rated temperature of the capacitor.
- (4) Monitor the contamination levels of the cleaning solvents during use by electrical conductivity, pH, specific gravity, or water content. Chlorine levels can rise with contamination and adversely affect the performance of the capacitor.

* Please contact us for additional information about acceptable cleaning solvents or cleaning methods.

Type	Series	Cleaning permitted
Surface mount type	V(Except EB Series)	O
Lead type	Bi-polar SU	O
	M	O(to 100V)
	KA	O
	Bi-polar KA	O
	FK	O
	FC	O
	GA	O
	NHG	O(to 100V)
	EB	O(to 100V)
	TA	O
Snap-in type	TS UP ,UQ	O(to 100V)
	TS HA ,HC	O(to 100V)

2.9 Mounting Adhesives and Coating Agents

When using mounting adhesives or coating agents to control humidity, avoid using materials containing halogenated solvents. Also, avoid the use of chloroprene based polymers.

- * After applying adhesives or coatings, dry thoroughly to prevent residual solvents from being trapped between the capacitor and the circuit board.

3. Precautions for using capacitors

3.1 Environmental Conditions

Capacitors should not be used in the following environments.

- (1) Temperature exposure above the maximum rated or below the minimum rated temperature of the capacitor.

- (2) Direct contact with water, salt water, or oil.
- (3) High humidity conditions where water could condense on the capacitor.
- (4) Exposure to toxic gases such as hydrogen sulfide, sulfuric acid, nitric acid, chlorine, or ammonia.
- (5) Exposure to ozone, radiation, or ultraviolet rays.
- (6) Vibration and shock conditions exceeding specified requirements.

3.2 Electrical Precautions

- (1) Avoid touching the terminals of the capacitor as possible electric shock could result. The exposed aluminium case is not insulated and could also cause electric shock if touched.
- (2) Avoid short circuiting the area between the capacitor terminals with conductive materials including liquids such as acids or alkaline solutions.

4. Emergency Procedures

- (1) If the pressure relief vent of the capacitor operates, immediately turn off the equipment and disconnect from the power source. This will minimize additional damage caused by the vaporizing electrolyte.
- (2) Avoid contact with the escaping electrolyte gas which can exceed 100°C temperatures.
If electrolyte or gas enters the eye, immediately flush the eye with large amounts of water.
If electrolyte or gas is ingested by mouth, gargle with water. If electrolyte contacts the skin, wash with soap and water.

5. Long Term Storage

Leakage current of a capacitor increases with long storage times. The aluminium oxide film deteriorates as a function of temperature and time. If used without reconditioning, an abnormally high current will be required to restore the oxide film. This current surge could cause the circuit or the capacitor to fail. Capacitor should be reconditioned by applying rated voltage in series with a 1000 Ω, current limiting resistor for a time period of 30 minutes.

5.1 Environmental Conditions (Storage)

Capacitors should not be stored in the following environments.

- (1) Temperature exposure above 35°C or below 15 °C.
- (2) Direct contact with water, salt water, or oil.
- (3) High humidity conditions where water could condense on the capacitor.
- (4) Exposure to toxic gases such as hydrogen sulfide, sulfuric acid, nitric acid, chlorine, or ammonia.
- (5) Exposure to ozone, radiation, or ultraviolet rays.
- (6) Vibration and shock conditions exceeding specified requirements.

6. Capacitor Disposal

When disposing of capacitors, use one of the following methods.

- Incinerate after crushing the capacitor or puncturing the can wall (to prevent explosion due to internal pressure rise). Capacitors should be incinerated at high temperatures to prevent the release of toxic gases such as chlorine from the polyvinyl chloride sleeve, etc.
- Dispose of as solid waste.
- Local laws may have specific disposal requirements which must be followed.

The application guidelines above are taken from:

Technical Report EIAJ RCR-2367 issued by the Japan Electronic Industry Association, Inc. -
Guideline of notabilia for aluminium electrolytic capacitors with non-solid electrolytic for use in electronic equipment.

Refer to this Technical Report for additional details.

Surface Mount Type

■ Packaging Specifications

● Reel Dimensions in mm (not to scale)

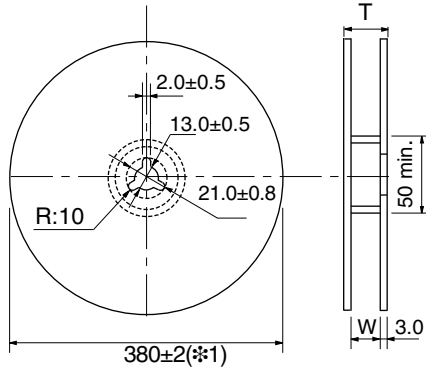

Size	W
A, B, C	14±1
D, E, D8	18±1
F, G	26±1

Size	W	mm
G13 to G21	34±1	
H13 to H21		
J16 to J21	46±1	
K16 to K21		

(※1)330mm(13 inch)reel is available on request.(code:A)

Size code	Height	Min.Packing Quantity pcs	
		380mm reel	330mm reel
A, B	L=5.4mm	2000	1500
	L=5.8mm	2000	1200
C, D	L=5.4mm	1000	1000
	L=5.8mm	1000	800
E	-	1000	800
D8	-	900	500
F, G	-	500	300
B, C	L=4.5mm	2000	1500
D	L=4.5mm	1000	1000

Size code	Min Packing Quantity pcs
	330mm reel
G13	250
G17, H13	200
G21, H16	150
H21, J16, K16	125
J21, K21	75

● Taping Dimensions in mm(size A to G)

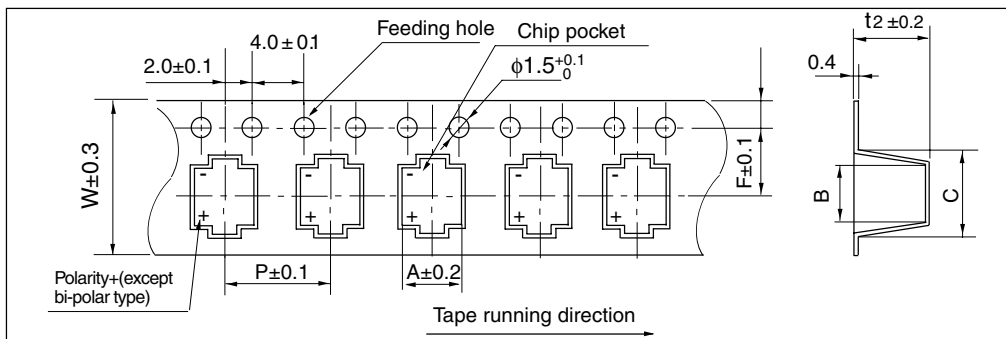

Ask factory for technical specifications.

Size code	W	A	B	C	P	F	t 2		
							Height		
							L=4.5mm	L=5.4mm	L=5.8mm
A	12.0	3.4	3.5±0.2	6.0±0.3	8.0	5.5	-	5.8	-
B	12.0	4.7	4.6±0.2	6.5±0.3	8.0	5.5	4.9	5.8	6.2
C(※2)	12.0	5.7	5.7±0.3	8.0±0.5	12.0	5.5	4.9	5.8	6.4
D	16.0	7.0	7.0±0.3	9.0±0.5	12.0	7.5	4.9	5.8	6.4
D8	16.0	7.0	7.0±0.3	9.0±0.5	12.0	7.5	8.4		
E	16.0	8.7	8.7±0.3	11.4±0.5	12.0	7.5	6.8		
F	24.0	8.7	8.7±0.3	12.5±0.5	16.0	11.5	11.0		
G	24.0	10.7	10.7±0.3	14.5±0.5	16.0	11.5	11.0		

(※2) Height L=4.5mm P=8.0

● Taping Dimensions in mm(size G13 to K21)

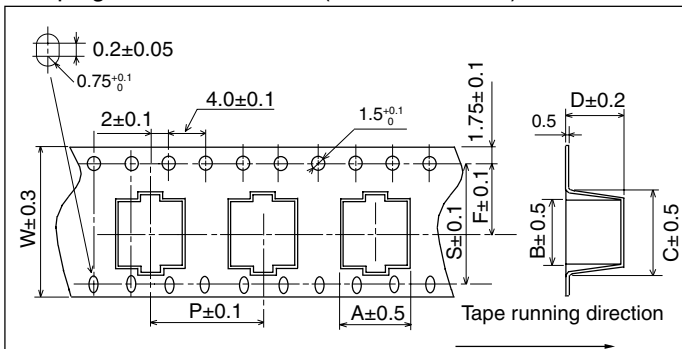

Ask factory for technical specifications.

Size	Taping Size							
	A	B	C	D	F	P	S	W
G13	10.7	10.7	14.5	14.5	14.2	20.0	28.4	32.0
G17	10.7	10.7	14.5	17.5	14.2	20.0	28.4	32.0
H13	14.0	14.0	18.0	17.5	14.2	24.0	28.4	32.0
H16	14.0	14.0	18.0	17.5	14.2	24.0	28.4	32.0
J16	17.5	17.5	23.0	17.5	20.2	28.0	40.4	44.0
J21	17.5	17.5	23.0	22.5	20.2	28.0	40.4	44.0
K16	19.5	19.5	26.0	17.5	20.2	32.0	40.4	44.0
K21	19.5	19.5	26.0	22.5	20.2	32.0	40.4	44.0

■ Environmental Management(Pb-free,PVC-free)

We are reducing environmentally harmful substances to do our part in global environmental conservation activities. We are moving ahead with products compatible with Pb-free soldering, products with Pb-free terminals and products with non-PVC encasing materials.

● Aluminum Electrolytic Capacitor

Body shape	Series/Type	P / N (standard)	Lead-free Solder Compatible P / N	Lead-free Terminal	Non-PVC Sleeve
Surface Mount Type (V Type)	S	ECEV - - S - - - S -	EEE - - S - - - S -	available	available as standard
		ECEV - - A - - - S -	EEE - - A - - - S -		
		ECEV - - A - - - - -	EEE - - A - - - - -		
		ECEV - - S - - - W -	EEE - - S - - - W -		
		ECEV - - A - - - W -	EEE - - A - - - W -		
		ECEV - - A - - - U -	EEE - - A - - - U -		
		ECEV - - A - - - N -	EEE - - A - - - N -		
	HA	EEVHA - - - - - -	EEEHA - - - - - -	not available	
	HB	EEVHB - - - - - -	EEEHB - - - - - -		
		EEVHP - - - - - -	EEEHP - - - - - -		
	HD	EEVHD - - - - - -			
	FC	EEVFC - - - - - -	EEEFC - - - - - -	available	
	FK($\phi 10 \geq$)	EEVFK - - - - - -	EEEFK - - - - - -		
	FK($\phi 12.5 \leq$)	EEVFK - - - - - -			
	TA	EEVTA - - - - - -		not available	
	TG($\phi 10 \geq$)	EEVTG - - - - - -	EEETG - - - - - -	available	
TG($\phi 12.5 \leq$)		EEVTG - - - - - -			
EB	EEVEB - - - - - -				

Pre-fix	Suffix	Case Diameter	RoHS Compliant	Terminal Finish	Reflow Condition		Reflow Chart
					Peak Temperature	Time above 200	
ECE-V	R	3mm to 5mm	No	Sn-Pb	240 for 5 seconds	20 seconds	(1) Fig.1
	P	6mm	No	Sn-Pb	240 for 5 seconds	20 seconds	(1) Fig.1
	P	8mm to 10mm	No	Sn-Pb	230 for 5 seconds	20 seconds	(2) Fig.2
EEV-	R	4mm to 5mm	No	Sn-Pb	240 for 5 seconds	20 seconds	(1) Fig.1
	P	6mm	No	Sn-Pb	240 for 5 seconds	20 seconds	(1) Fig.1
	P	8mm to 10mm	No	Sn-Pb	230 for 5 seconds	20 seconds	(2) Fig.2
	Q	12.5mm	Yes	Sn	230 for 5 seconds	20 seconds	(2) Fig.2 (Except for EB series) (3) Fig.3 (EB series only)
	M	16mm to 18mm	Yes	Sn	230 for 5 seconds	20 seconds	(2) Fig.2 (Except for EB series) (3) Fig.3 (EB series only)
EEE-	R	3mm to 5mm	Yes	Sn-Bi	250 for 5 seconds	60 seconds	(4) Fig.4
	P	6mm	Yes	Sn-Bi	250 for 5 seconds	60 seconds	(4) Fig.4
	P	8mm to 10mm	Yes	Sn-Bi	235 for 5 seconds	60 seconds	(5) Fig.5

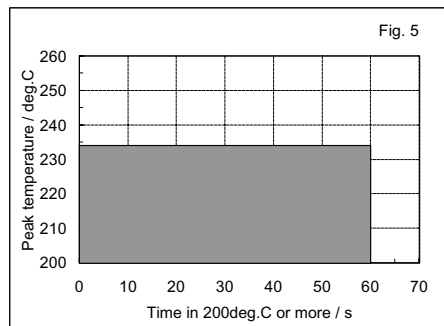
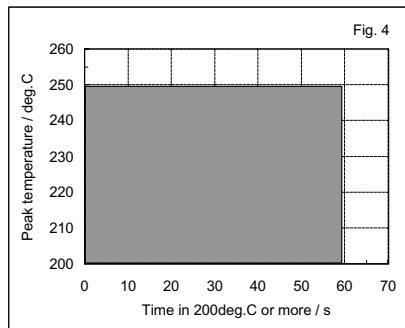
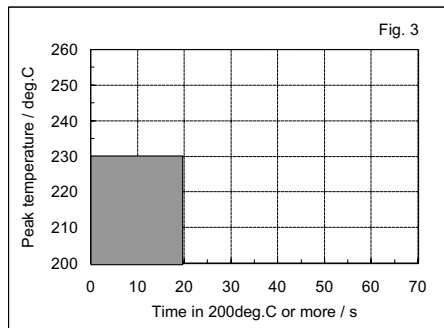
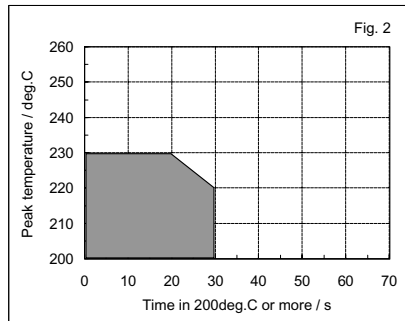
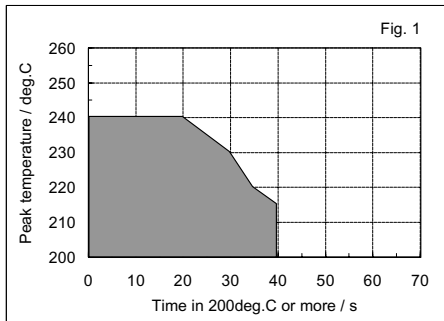

Panasonic Industrial Company

R E G I O N A L S A L E S O F F I C E S



WESTERN REGION:

Panasonic Industrial Co.
6550 Katella Ave.
Cypress, CA 90630

WESTERN REGION:

Panasonic Industrial Co.
9444 Balboa Ave.
Suite 185
San Diego, CA 92123

CENTRAL REGION:

Panasonic Industrial Co.
1707 North Randall Rd.
Elgin, IL 60123-7847

EASTERN REGION:

Panasonic Industrial Co.
Two Panasonic Way
Secaucus, NJ 07094

Panasonic Industrial Company ● Two Panasonic Way ● Secaucus, NJ 07094 ● 1-800-344-2112

<http://www.panasonic.com/industrial/components/>

Free Manuals Download Website

<http://myh66.com>

<http://usermanuals.us>

<http://www.somanuals.com>

<http://www.4manuals.cc>

<http://www.manual-lib.com>

<http://www.404manual.com>

<http://www.luxmanual.com>

<http://aubethermostatmanual.com>

Golf course search by state

<http://golfingnear.com>

Email search by domain

<http://emailbydomain.com>

Auto manuals search

<http://auto.somanuals.com>

TV manuals search

<http://tv.somanuals.com>