



ACCULINK 3166 DSU/CSU

USER'S GUIDE

Document No. 3166-A2-GB20-10

November 1998

PARADYNE™

Copyright © 1998 Paradyne Corporation.
All rights reserved.
Printed in U.S.A.

Notice

This publication is protected by federal copyright law. No part of this publication may be copied or distributed, transmitted, transcribed, stored in a retrieval system, or translated into any human or computer language in any form or by any means, electronic, mechanical, magnetic, manual or otherwise, or disclosed to third parties without the express written permission of Paradyne Corporation, 8545 126th Ave. N., Largo, FL 33773.

Paradyne Corporation makes no representation or warranties with respect to the contents hereof and specifically disclaims any implied warranties of merchantability or fitness for a particular purpose. Further, Paradyne Corporation reserves the right to revise this publication and to make changes from time to time in the contents hereof without obligation of Paradyne Corporation to notify any person of such revision or changes.

Changes and enhancements to the product and to the information herein will be documented and issued as a new release to this manual.

Warranty, Sales, and Service Information

Contact your local sales representative, service representative, or distributor directly for any help needed. For additional information concerning warranty, sales, service, repair, installation, documentation, training, distributor locations, or Paradyne worldwide office locations, use one of the following methods:

- **Via the Internet:** Visit the Paradyne World Wide Web site at <http://www.paradyne.com>
- **Via Telephone:** Call our automated call system to receive current information via fax or to speak with a company representative.
 - Within the U.S.A., call 1-800-870-2221
 - Outside the U.S.A., call 1-727-530-2340

Document Feedback

We welcome your comments and suggestions about this document. Please mail them to Technical Publications, Paradyne Corporation, 8545 126th Ave. N., Largo, FL 33773, or send e-mail to userdoc@eng.paradyne.com. Include the number and title of this document in your correspondence. Please include your name and phone number if you are willing to provide additional clarification.

Trademarks

All products and services mentioned herein are the trademarks, service marks, registered trademarks or registered service marks of their respective owners.



Printed on recycled paper

Important Safety Instructions

1. Read and follow all warning notices and instructions marked on the product or included in the manual.
2. Slots and openings in the cabinet are provided for ventilation. To ensure reliable operation of the product and to protect it from overheating, these slots and openings must not be blocked or covered.
3. Do not allow anything to rest on the power cord and do not locate the product where persons will walk on the power cord.
4. Do not attempt to service this product yourself, as opening or removing covers may expose you to dangerous high voltage points or other risks. Refer all servicing to qualified service personnel.
5. General purpose cables are provided with this product. Special cables, which may be required by the regulatory inspection authority for the installation site, are the responsibility of the customer.
6. When installed in the final configuration, the product must comply with the applicable Safety Standards and regulatory requirements of the country in which it is installed. If necessary, consult with the appropriate regulatory agencies and inspection authorities to ensure compliance.
7. A rare phenomenon can create a voltage potential between the earth grounds of two or more buildings. If products installed in separate buildings are **interconnected**, the voltage potential may cause a hazardous condition. Consult a qualified electrical consultant to determine whether or not this phenomenon exists and, if necessary, implement corrective action prior to interconnecting the products.
8. Input power to the ac voltage configuration of this product must be provided by a UL-listed or CSA-certified power source with a Class 2 or Limited Power Source (LPS) output. Input power to the dc voltage configurations of this product must be provided by a National Electric Code (NEC) or a Canadian Electric Code (CEC) Class 2 circuit.
9. This product contains a coin cell lithium battery that is only to be replaced at the factory. **Caution:** There is a danger of explosion if the battery is incorrectly replaced. Replace only with the same type. Dispose of used batteries according to the battery manufacturer's instructions. **Attention:** Il y a danger d'explosion s'il y a remplacement incorrect de la batterie. Remplacer uniquement avec une batterie du même type. Mettre au rebut les batteries usagées conformément aux instructions du fabricant.
10. In addition, if the equipment is to be used with telecommunications circuits, take the following precautions:
 - Never install telephone wiring during a lightning storm.
 - Never install telephone jacks in wet locations unless the jack is specifically designed for wet locations.
 - Never touch uninsulated telephone wires or terminals unless the telephone line has been disconnected at the network interface.
 - Use caution when installing or modifying telephone lines.
 - Avoid using a telephone (other than a cordless type) during an electrical storm. There may be a remote risk of electric shock from lightning.
 - Do not use the telephone to report a gas leak in the vicinity of the leak.

EMI Warnings

WARNING:

This equipment has been tested and found to comply with the limits for a Class A digital device, pursuant to Part 15 of the FCC rules. These limits are designed to provide reasonable protection against harmful interference when the equipment is operated in a commercial environment. This equipment generates, uses, and can radiate radio frequency energy and, if not installed and used in accordance with the instruction manual, may cause harmful interference to radio communications. Operation of this equipment in a residential area is likely to cause harmful interference in which case the user will be required to correct the interference at his own expense.

The authority to operate this equipment is conditioned by the requirements that no modifications will be made to the equipment unless the changes or modifications are expressly approved by Paradyne Corporation.

WARNING:

To Users of Digital Apparatus in Canada:

This Class A digital apparatus meets all requirements of the Canadian interference-causing equipment regulations.

Cet appareil numérique de la classe A respecte toutes les exigences du règlement sur le matériel brouilleur du Canada.

Government Requirements and Equipment Return

Certain governments require that instructions pertaining to CSU connection to the telephone network be included in the installation and operation manual. Specific instructions are listed in the following sections.

United States

NOTICE TO USERS OF THE UNITED STATES TELEPHONE NETWORK

1. This equipment complies with Part 68 of the FCC rules. On the equipment is a label that contains, among other information, the FCC registration number for this equipment. The label is on the 3166 DSU/CSU's circuit card. If requested, this information must be provided to the telephone company.
2. The T1 network connection should be made using a Universal Service Order Code (USOC) type RJ48C jack. The Service Order Code 6.0F should be specified to the telephone company when ordering the T1 line. In addition, the proper Facility Interface Code must be specified to the Telephone Company. The DSU/CSU can be configured to support any of the following framing format and line signaling techniques. The DSU/CSU's configuration must correspond to the T1 line's parameters.

3166 DSU/CSU Facility Interface Codes

| Code | Description |
|-----------|--|
| 04DU9-BN | 1.544 Mbps superframe format (SF) without line power |
| 04DU9-DN | 1.544 Mbps SF and B8ZS without line power |
| 04DU9-1KN | 1.544 Mbps ANSI ESF without line power |
| 04DU-1SN | 1.544 Mbps ANSI ESF and B8ZS without line power |

3. If the 3166 DSU/CSU causes harm to the telephone network, the telephone company will notify you in advance that temporary discontinuance of service may be required. But if advance notice is not practical, the telephone company will notify the customer as soon as possible. Also, you will be advised of your right to file a complaint with the FCC if you believe it is necessary.
4. The telephone company may make changes in its facilities, equipment, operations, or procedures that could affect the operation of the equipment. If this happens, the telephone company will provide advance notice in order for you to make the necessary modifications in order to maintain uninterrupted service.
5. If you experience trouble with this equipment, please contact your sales or service representative (as appropriate) for repair or warranty information. If the product needs to be returned to the company service center for repair, contact them directly for return instructions using one of the following methods:

- **Via the Internet:** Visit the Paradyne World Wide Web site at <http://www.paradyne.com>
- **Via Telephone:** Call our automated call system to receive current information via fax or to speak with a company representative.
 - Within the U.S.A., call 1-800-870-2221
 - Outside the U.S.A., call 1-727-530-2340

If the trouble is causing harm to the telephone network, the telephone company may request that you remove the equipment from the network until the problem is resolved.

6. FCC compliant telephone line cords with modular plugs are provided with this equipment. This equipment is designed to be connected to the telephone network or premises wiring using a compatible modular jack which is Part 68 compliant.

Canada

NOTICE TO USERS OF THE CANADIAN TELEPHONE NETWORK

The Industry Canada label identifies certified equipment. This certification means that the equipment meets telecommunications network protective, operational and safety requirements as prescribed in the appropriate Terminal Equipment Technical Requirements document(s). The Department does not guarantee the equipment will operate to the user's satisfaction.

Before installing this equipment, users should ensure that it is permissible to be connected to the facilities of the local telecommunications company. The equipment must also be installed using an acceptable method of connection. The customer should be aware that compliance with the above conditions may not prevent degradation of service in some situations.

Repairs to certified equipment should be coordinated by a representative designated by the supplier. Any repairs or alterations made by the user to this equipment, or equipment malfunctions, may give the telecommunications company cause to request to disconnect the equipment.

Users should ensure for their own protection that the electrical ground connections of the power utility, telephone lines and internal metallic water pipe system, if present, are connected together. This precaution may be particularly important in rural areas.

CAUTION:

Users should not attempt to make such connections themselves, but should contact the appropriate electric inspection authority, or electrician, as appropriate.

The Ringer Equivalence Number (REN) assigned to each terminal device provides an indication of the maximum number of terminals allowed to be connected to a telephone interface. The termination on an interface may consist of any combination of devices subject only to the requirement that the sum of the Ringer Equivalence Numbers of all the devices does not exceed 5.

If your equipment is in need of repair, refer to *Warranty, Sales, and Service Information* on page A.

Contents

About This Guide

- Document Purpose and Intended Audience vii
- Document Summary vii
- Product-Related Documents viii
- Reference Documents ix

1 Introduction

- Overview 1-1
- Features 1-1
 - Alarm Message Capability 1-2
 - Front Panel Emulation 1-2
 - Asynchronous Terminal Interface (ATI) Support 1-2
 - Telnet Access 1-2
 - SNMP Management Support 1-2
- Physical Description 1-3

2 Installation

- Important Instructions 2-1
- Installation 2-2

3 SDCP Operation

- Overview 3-1
- Using the SDCP 3-1
 - LCD 3-2
 - Keypad 3-2
 - Test Jacks 3-3
 - LEDs 3-4
- Displaying Unit Identity 3-7
- Setting Customer Identification 3-9
- Displaying LED Conditions 3-10
- Changing Configuration Options 3-11
 - Displaying/Editing Configuration Options 3-13
 - Saving Edit Changes 3-15
- Enabling the Communication Port 3-16
- Configuring the DSU/CSU for SNMP or Telnet Access 3-19
 - Selecting the Port 3-20
 - Setting the IP Address 3-21
 - Selecting the Link Layer Protocol 3-23
 - Specifying the Community Name(s) and Access Type(s) 3-24
- Configuring SNMP Traps 3-26
 - Enabling SNMP Trap Messages 3-26
 - Selecting the Number of Trap Managers 3-27
 - Configuring a Destination for SNMP Traps 3-28
 - Allocating Data Ports 3-29
 - Block or ACAMI Assignment Method 3-31
 - Individual Channel Assignment Method 3-32
 - Clearing DS0 Channel Allocation 3-33
- Selecting the Timing Source 3-34
 - Configuring for Network Timing 3-34
- Establishing Access Security on the COM Port 3-35
- Setting a Password 3-36
- Entering a Password to Gain Access 3-37
- Acquiring/Releasing the User Interface 3-38
 - Acquiring the Active User Interface 3-38
 - Releasing the Active User Interface 3-39
- Resetting the DSU/CSU 3-40

4 Monitoring and Testing

| | |
|---|------|
| ■ Overview | 4-1 |
| ■ Self-Test Health | 4-1 |
| ■ Device Health and Status | 4-3 |
| ■ Performance Reports | 4-5 |
| Resetting Performance Registers | 4-10 |
| ■ Alarms | 4-11 |
| ■ SNMP Traps | 4-12 |
| ■ Troubleshooting | 4-14 |
| ■ Test Jacks | 4-15 |
| ■ Test Commands | 4-15 |
| ■ Remote Loopback Tests | 4-16 |
| Sending a Line Loopback Up or Down | 4-17 |
| Sending a V.54/ANSI FT1 Activation/Deactivation | 4-18 |
| ■ Local Loopback Tests | 4-19 |
| Starting a Line Loopback | 4-20 |
| Starting a Payload Loopback | 4-21 |
| Starting a Repeater Loopback | 4-22 |
| Starting a Data Channel Loopback | 4-23 |
| Starting a Data Terminal Loopback | 4-24 |
| Aborting Loopbacks | 4-25 |
| ■ Test Patterns | 4-26 |
| Sending Test Patterns | 4-26 |
| Monitoring Test Patterns | 4-27 |
| Aborting Test Patterns | 4-28 |
| ■ Lamp Test | 4-30 |
| Starting a Lamp Test | 4-30 |
| Aborting a Lamp Test | 4-31 |
| ■ Displaying DSU/CSU Test Status | 4-32 |

A SDCP Menu

B Technical Specifications

- Overview B-1

C Configuration Options

- Overview C-1
- Port Configuration Options C-2
- Network Interface Configuration Options C-7
- General Configuration Options C-9
- User Interface Configuration Options C-10
- Alarm Configuration Options C-16
- Management Configuration Options C-19

D Pin Assignments

- Overview D-1
- T1 Network Interface D-1
- EIA-530-A Port Interface Connector D-3
- EIA-530-A-to-RS449 Cable Interface D-4
- EIA-530-A-to-V.35 Cable Interface D-6
- EIA-530-A-to-X.21 Cable Interface D-8
- COM Port Interface D-9
- COM Port to Modem Cable D-11

E SNMP MIB Objects

| | |
|--|------|
| ■ Overview | E-1 |
| ■ MIB II (RFC 1213) | E-2 |
| System Group, MIB II | E-2 |
| Interface Group, MIB II | E-3 |
| IP Group, MIB II | E-6 |
| ICMP Group, MIB II | E-9 |
| TCP Group, MIB II | E-9 |
| UDP Group, MIB II | E-9 |
| Transmission Group, MIB II | E-10 |
| SNMP Group, MIB II | E-10 |
| ■ DS1/E1 MIB (RFC 1406) | E-10 |
| Near End Group, DS1/E1 MIB | E-11 |
| Far End Group, DS1/E1 MIB | E-14 |
| DS1 Fractional Group, DS1/E1 MIB | E-15 |
| ■ RS-232-like MIB (RFC 1317) | E-15 |
| General Port Table, RS-232-like MIB | E-15 |
| Asynchronous Port Table, RS-232-like MIB | E-16 |
| Synchronous Port Table, RS-232-like MIB | E-17 |
| Input Signal Table, RS-232-like MIB | E-18 |
| Output Signal Table, RS-232-like MIB | E-18 |
| ■ Generic-Interface MIB Extensions (RFC 1229) | E-19 |
| Generic Interface Test Table, Generic Interface MIB | E-19 |
| ■ Enterprise MIB | E-21 |
| ■ Correlation between Menu Commands and SNMP Objects | E-22 |

F IP Networking Address Scenario

| | |
|--------------------|-----|
| ■ Overview | F-1 |
| ■ Scenario 1 | F-2 |
| ■ Scenario 2 | F-3 |
| ■ Scenario 3 | F-4 |
| ■ Scenario 4 | F-5 |
| ■ Scenario 5 | F-6 |

G Front Panel Emulation

- Overview G-1
- Installing Front Panel Emulation Software G-1
- Starting Front Panel Emulation G-3

H Asynchronous Terminal Interface Operation

- Overview H-1
- Before Using the ATI H-1
- Resetting the ATI H-1
- Initiating an ATI Session H-2
- Ending an ATI Session H-2
- Menu Organization H-3
- Using ATI Screens H-4
- Setting Customer Identification H-6
- Displaying LED Conditions H-7
- Changing Configuration Options H-8
 - Displaying or Editing Configuration Options H-8
 - Saving Edit Changes H-10
- Establishing Access Security on a Port H-11
- Setting a Password H-12
- Entering a Password to Gain Access H-13

I Equipment List

Glossary

Index

About This Guide

Document Purpose and Intended Audience

This operator's guide contains installation, operation, and maintenance information for the ACCULINK 3166 Data Service Unit (DSU)/Channel Service Unit (CSU).

It is assumed that you are familiar with the operation of digital data communication equipment. You should also be familiar with Simple Network Management Protocol (SNMP) if you want your DSU/CSU to be managed by an SNMP manager.

Document Summary

| Section | Description |
|------------|--|
| Chapter 1 | <i>Introduction.</i> Describes the features of the DSU/CSU. |
| Chapter 2 | <i>Installation.</i> Explains how to install the DSU/CSU. |
| Chapter 3 | <i>SDCP Operation.</i> Explains the use of the optional Shared Diagnostic Control Panel (SDCP), including using the SDCP to configure SNMP parameters and security. |
| Chapter 4 | <i>Monitoring and Testing.</i> Explains how to obtain information about the status and performance of the DSU/CSU, how to troubleshoot problems, and how to run tests. |
| Appendix A | <i>SDCP Menu.</i> Contains a menu tree showing the main branches of the Shared Diagnostic Control Panel (SDCP) interface. |
| Appendix B | <i>Technical Specifications.</i> Contains a table with the specifications of the DSU/CSU. |
| Appendix C | <i>Configuration Options.</i> Lists and explains the configuration options. |
| Appendix D | <i>Pin Assignments.</i> Describes the pin assignments for connectors used with the DSU/CSU. |

| Section | Description |
|----------------|---|
| Appendix E | <i>SNMP MIB Objects</i> . Lists and describes the MIB support provided by the DSU/CSU. |
| Appendix F | <i>IP Network Addressing Scenarios</i> . Shows the use of IP addressing in sample networks. |
| Appendix G | <i>Front Panel Emulation</i> . Explains the use of the optional front panel emulation software. |
| Appendix H | <i>Asynchronous Terminal Interface Operation</i> . Describes the function and use of the Asynchronous Terminal Interface (ATI). |
| Appendix I | <i>Equipment List</i> . Lists feature numbers for equipment related to the DSU/CSU. |
| Glossary | Explains terms and abbreviations used in the text. |
| Index | Lists major topics in the text. |

Product-Related Documents

| Document Number | Document Title |
|------------------------|---|
| 3000-A2-GA31 | <i>COMSPHERE 3000 Series Carrier Installation Manual</i> |
| 3000-A2-GB41 | <i>COMSPHERE –48 VDC Central Office Power Unit Installation Guide</i> |

Contact your sales or service representative to order additional product documentation.

Paradyne documents are also available on the World Wide Web at:

<http://www.paradyne.com>

Select *Service & Support* → *Technical Manuals*

Reference Documents

- AT&T Technical Reference 54016
- AT&T Technical Reference 62411
- ANSI T1.403-1989
- Industry Canada CS-03
- CSA-22.2 No. 950
- Industry Canada (ICES)-003
- FCC Part 15
- FCC Part 68
- UL 1950
- *Management Information Base for Network Management of TCP/IP-Based Internets: MIBII*. RFC 1213, March 1991
- *Definitions of Managed Objects for the DS1 and E1 Interface Types*. RFC 1406, January 1993
- *Definitions of Managed Objects for RS-232-like Hardware Devices*. RFC 1317, April 1992
- *Extensions to the Generic-Interface MIB*. RFC 1229, May 1991

Introduction

1

Overview

The ACCULINK® 3166 DSU/CSU acts as an interface between the T1 digital network and the customer premises equipment, converting signals received from the DTE (Data Terminal Equipment) to bipolar signals that can be transmitted over T1 lines. Typical applications include shared access to network-based services, Local Area Network (LAN)/Wide Area Network (WAN) interconnection, and fractional T1 network applications.

The Model 3166 is designed to fit into the COMSPHERE 3000 Series Carrier. For more information about the carrier, refer to the *COMSPHERE 3000 Series Carrier Installation Manual*.

Features

The DSU/CSU optimizes network performance with a wide range of features such as the following:

- Software configuration menu displayed via an optional liquid crystal display (LCD) to permit quick and easy operation, and elimination of complicated hardware strapping.
- Local or remote configuration and operation flexibility.
- Several loopback capabilities and test pattern generators.
- Alarm message display/print capability.
- Front panel emulation via Windows-based Front Panel Emulation software.
- Asynchronous (async) terminal interface support.
- Telnet access for remote async terminal operations.
- Network management provided through industry-standard Simple Network Management Protocol (SNMP).

Alarm Message Capability

The DSU/CSU can be attached, either locally or remotely, to an ASCII terminal or printer to display or print alarm messages. Alarms can also be displayed on a PC that is using a terminal emulation package.

Front Panel Emulation

The DSU/CSU offers functionality through Front Panel Emulation software that is similar to that provided by the optional Shared Diagnostic Control Panel (SDCP). The functionality of the SDCP is available by clicking on the function keys with the mouse rather than by pressing keys on the SDCP.

Asynchronous Terminal Interface (ATI) Support

The DSU/CSU can be configured and managed from an asynchronous terminal. The asynchronous terminal's full screen display uses a menu hierarchy similar to the DSU/CSU's front panel. You can perform device management and configuration operations as if you are using the SDCP, but you do not have the limitation of the 2-line, 16-character LCD.

Telnet Access

Remote asynchronous terminal operations can be performed using Telnet access. Telnet is a Transmission Control Protocol/Internet Protocol (TCP/IP) service that supports a virtual terminal interface.

SNMP Management Support

SNMP is a network management protocol that is used to monitor network performance and status, and to report alarms (i.e., traps). To function, SNMP requires a manager consisting of a software program housed within a workstation or PC; an agent consisting of a software program housed within a device (e.g., the DSU/CSU); and a Management Information Base (MIB) consisting of a database of managed objects. The DSU/CSU can be managed by any industry-standard SNMP manager.

Two link layer protocols, Point-to-Point Protocol (PPP) and Serial Line Internet Protocol (SLIP), are supported for connection to an external SNMP manager or network device (e.g., a router).

The SNMP manager, LAN adapter, or network device can be directly connected to the communications (COM) port.

The SNMP management system can communicate to the DSU/CSU remotely through the Facility Data Link (FDL) or the synchronous data port's Embedded Data Link (EDL).

Physical Description

The Model 3166 DSU/CSU consists of a circuit card with front panel, and a rear connector module. It is designed to be mounted in the 3000 Series Carrier.

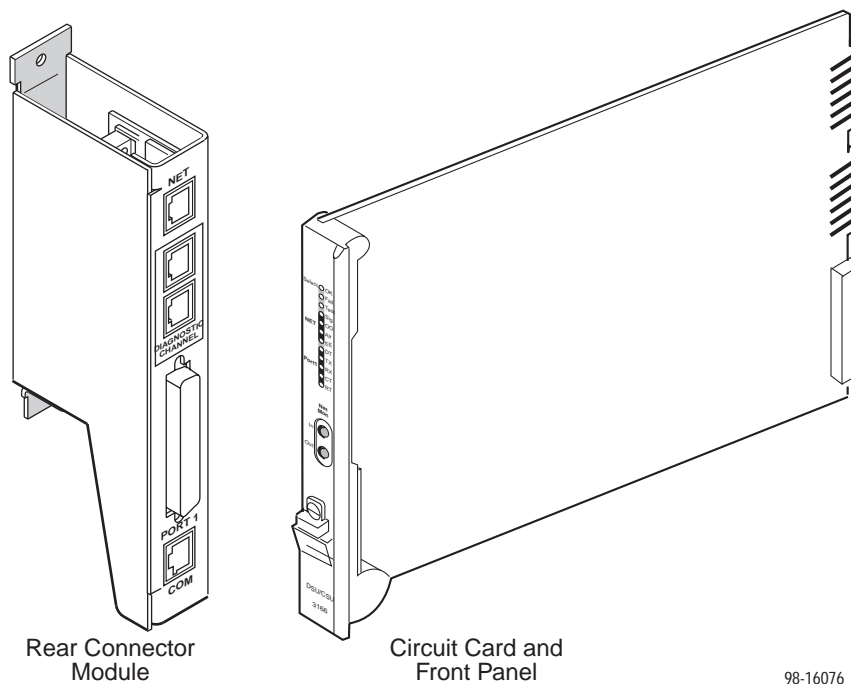

Table 1-1. 3166 DSU/CSU Rear Connector Module Connectors

| Name | Function |
|--------------------|---|
| NET | Network interface. Provides access to the T1 network. |
| DIAGNOSTIC CHANNEL | Provides diagnostic connectivity to other 3166 DSU/CSUs or a T1 auxiliary backplane. |
| PORT 1 | DTE port. Used to connect the customer's synchronous data DTE to the DSU/CSU. |
| COM | Communications port. Provides access to a locally connected PC, ASCII terminal or printer, or SNMP management link. |

Installation

2

Important Instructions

Read and follow all warning notices and instructions marked on the DSU/CSU or included in this guide.

For a complete listing of the safety instructions, see *Important Safety Instructions* at the beginning of this guide.

⚠ HANDLING PRECAUTIONS FOR STATIC-SENSITIVE DEVICES



This product is designed to protect sensitive components from damage due to electrostatic discharge (ESD) during normal operation. When performing installation procedures, however, take proper static control precautions to prevent damage to equipment. If you are not sure of the proper static control precautions, contact your nearest sales or service representative.

Installation

► Procedure

To install the DSU and rear connector module:

1. At the rear of the carrier, set the tab on the rear connector module into one of the slotted grooves on the carrier's backplane. Loosely fasten the screws. Make sure the rear connector module uses the same slot position intended for the DSU.

NOTE:

If an auxiliary backplane for Models 3151 or 3161 DSUs is installed in the same carrier, verify that it is mounted over slots 9–16. Slot 9 is rendered inaccessible if the auxiliary backplane is mounted over slots 1–8.

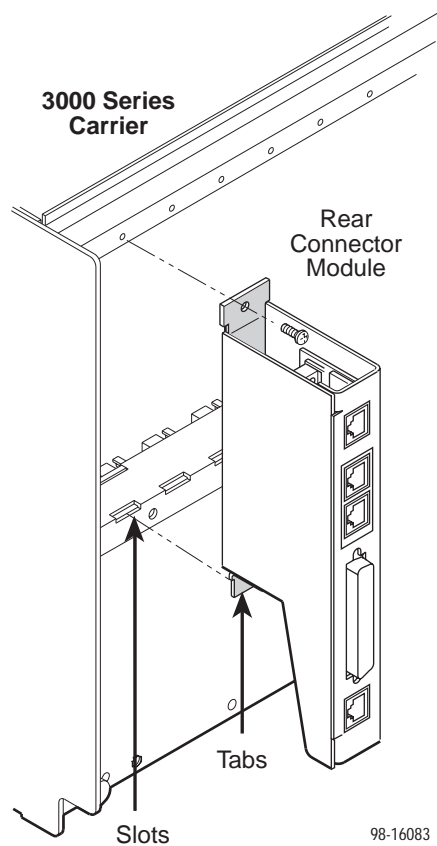

2. Loosely fasten the screw attached to the rear connector plate, allowing for slight adjustment that may be needed when installing the DSU.

- Using a Phillips screwdriver, loosen the screw holding the circuit pack lock and rotate the lock to the open position. Open the latch.

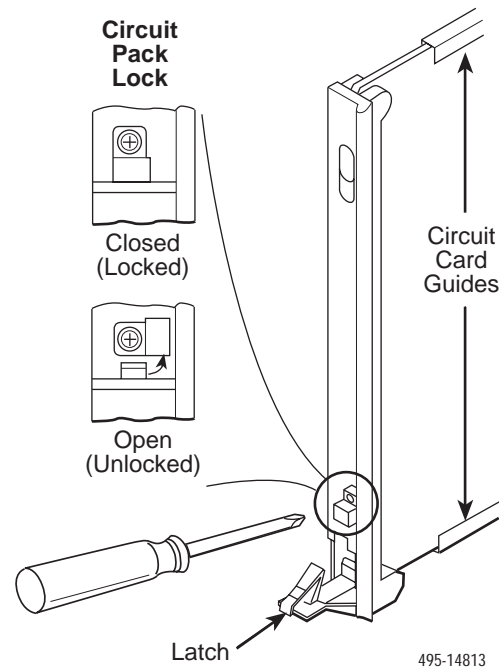

- At the front of the carrier, hold the DSU vertically with the latch on its faceplate in the open position. Then, insert the circuit card into the top and bottom circuit card guides for the slot that contains the rear connector module.
- Slide the DSU/CSU into the slot, aligning the circuit card with the rear connector module, until the connectors seat firmly into the back of the carrier. Press the faceplate latch to secure the DSU/CSU into the carrier, rotate the circuit pack lock into the closed position, and tighten the screw.
- Return to the rear of the carrier and tighten the rear connector module screw.

7. Attach a modular cable (not included) to the COM connector of the rear connector module. (See Appendix D, *Pin Assignments*, for detailed cable and connector information.) Connect the other end to a terminal or PC.

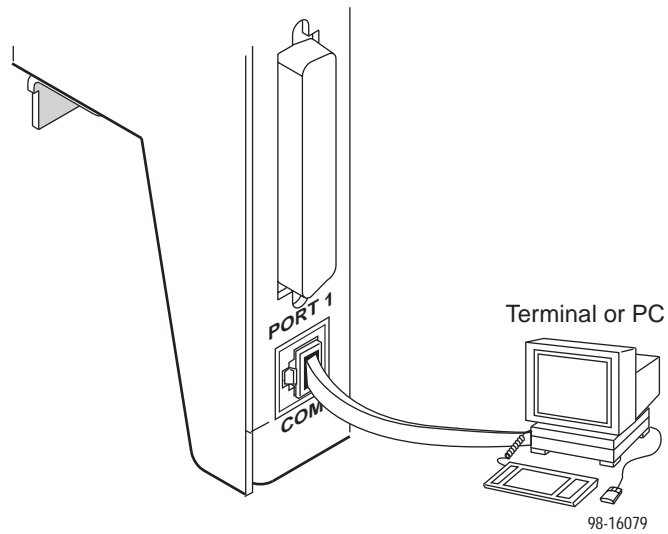

8. Attach the DB25 port cable to the PORT 1 connector on the rear connector module. Connect the other end of the cable to the customer premises equipment.

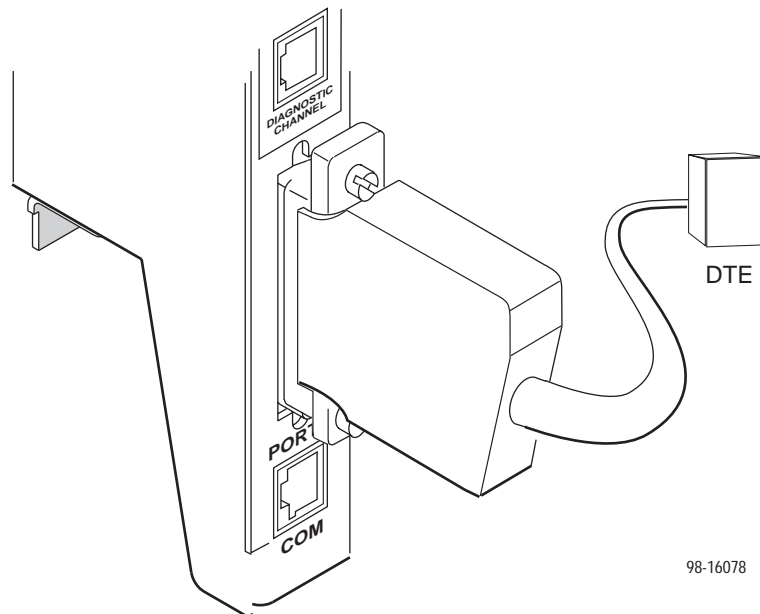

9. Attach the network cable to the NET connector on the rear connector module. Connect the other end of the network cable to the connection provided by the telephone company.

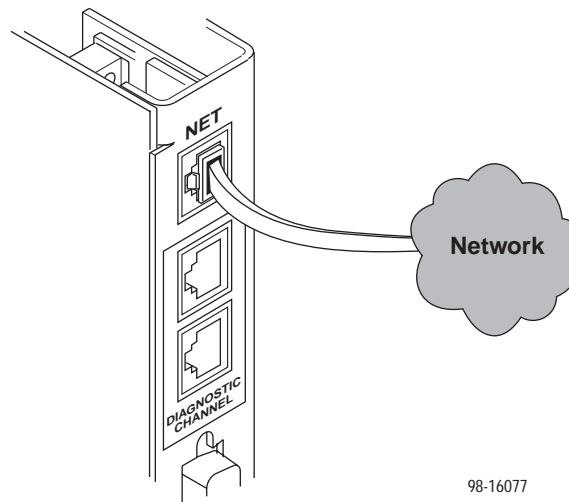

10. To daisy-chain the diagnostic channel with that of other 3166 DSU/CSUs or a T1 auxiliary backplane, insert one end of the short diagnostic channel extension cable into either DIAGNOSTIC CHANNEL connector on the rear connector module. Insert the other end into either DIAGNOSTIC CHANNEL connector of a neighboring 3166 rear connector module, or the diagnostic channel connector of a T1 auxiliary backplane.

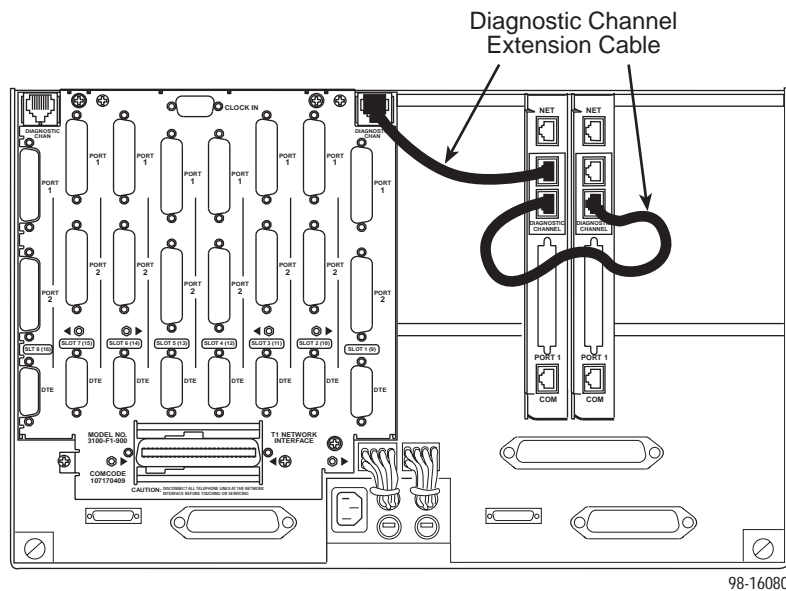

The power-up self-test begins when power is applied. During the power-up self-test, the **Fail** LED flashes, then all LEDs blink twice. When the test is complete, verify that the DSU/CSU is functional by observing that the **OK** and **NET Sig** LEDs are lit.

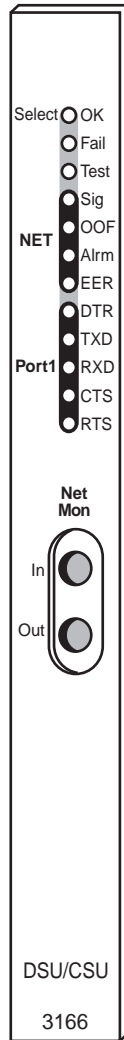

98-16081

SDCP Operation

3

Overview

This chapter contains information for operating your DSU/CSU using the optional Shared Diagnostic Control Panel of the 3000 Series Carrier. It includes a description of the SDCP and sample procedures for configuring the DSU/CSU.

For more information about the SDCP, refer to the *COMSPHERE 3000 Series Carrier Installation Manual*.

Using the SDCP

The SDCP (Figure 3-1) contains a Liquid Crystal Display (LCD) and a keypad.

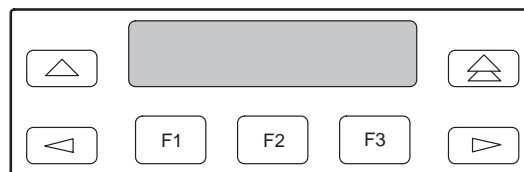

Figure 3-1. SDCP

NOTE:

You can display a graphical representation of the DSU/CSU front panel on an attached PC (see Appendix G, *Front Panel Emulation*).

LCD

The LCD is used to display two types of data:

- Messages such as alarms, command/test completion, and action in progress
- SDCP menu tree information (see Appendix A, *SDCP Menu*)

The LCD displays status messages as requested via the Device Health and Status branch of the SDCP menu (see *Device Health and Status* in Chapter 4, *Monitoring and Testing*). In addition, the highest level status message appears on the front panel automatically if no front panel action has occurred at the DSU/CSU for the past five minutes.



The LCD also lists commands, configuration options, and test results. In most cases, the top line shows the command or option name and default value, while the second line displays options and responses. When a response is required, select from the options displayed directly above the Function keys (F1, F2, F3); make your choice by pressing the corresponding Function key.

Keypad

The 7-button keypad enables you to navigate through the menu tree and select choices presented on the second line of the LCD.

Use the  key to move up the menu.



Use the  key to exit any part of the menu in which you may be operating. You immediately return to the top-level menu screen (see Appendix A, *SDCP Menu*), unless you are editing configuration options. If there are unsaved changes, the  key invokes the Save Edit screen.



Use the Function (F1, F2, F3) keys to make selections from the choices presented on the second line of the LCD. When this line presents choices, it is generally divided into three sections, each displayed directly above one of the Function keys. When your choice appears above one of the Function keys, press that key to select that choice.

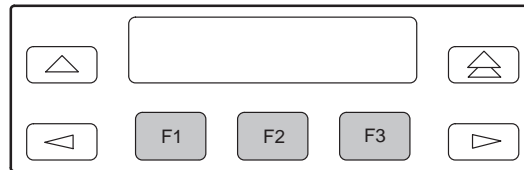

The scroll keys (◀ and ▶) serve one of two functions, depending on whether a menu screen or a data entry screen appears on the front panel.

For data entry screens, the ◀ key scrolls one character to the left while the ▶ key scrolls one character to the right.

For menu screens, the ◀ key scrolls to the previous menu choice while the ▶ key scrolls to the next menu choice.

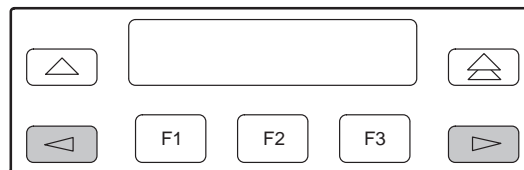

If a choice is available to the left of the screen, the character ← appears on the top line. If a choice is available to the right of the screen, the → character appears on the top line. If choices are available to both the right and the left of the screen, two arrows appear (↔). The arrows indicate that you must use the scroll keys to bring the additional options onto the screen.

Test Jacks

Test jacks are located on the DSU/CSU front panel (Figure 3-2). These are described in *Test Jacks* in Chapter 4, *Monitoring and Testing*.

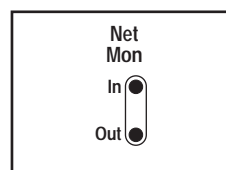

98-15942

Figure 3-2. Test Jacks

LEDs

There are twelve LEDs on the 3166 DSU/CSU front panel.

A green LED indicates normal operation. A yellow LED indicates activity. Conditions are sampled every tenth of a second.

The twelve front panel LEDs are grouped into three sections to indicate the status of the:

- **System** (Table 3-1)
- **Network Interface** (Table 3-2)
- **Data Port** (Table 3-3)

Table 3-1. System LEDs

| Name | Color | Meaning |
|--------------------|--------|--|
| OK (Select) | Green | Indicates the current operational state of the DSU/CSU. <i>ON</i> : The DSU/CSU is operational and has power. <i>OFF</i> : The DSU/CSU is performing a power-up self-test or a system failure has occurred. <i>BLINKING</i> : A software download is in progress. <i>FAST BLINK</i> : The DSU/CSU is currently selected by the SDCP. |
| Fail | Yellow | Indicates a system failure or a self-test. <i>ON</i> : A device error/fault is detected or a reset has just occurred. <i>OFF</i> : No system failures are detected. <i>BLINKING</i> : A self-test is in progress. |
| Test | Yellow | A system test is in progress. <i>ON</i> : A loopback or pattern test has been initiated either locally, by the network, or externally. <i>OFF</i> : No tests are active. |

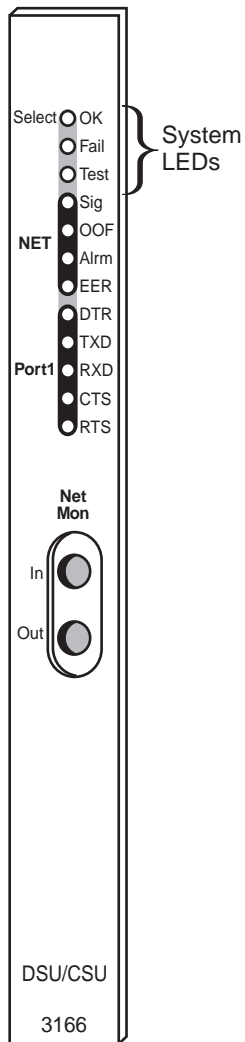

98-16081b

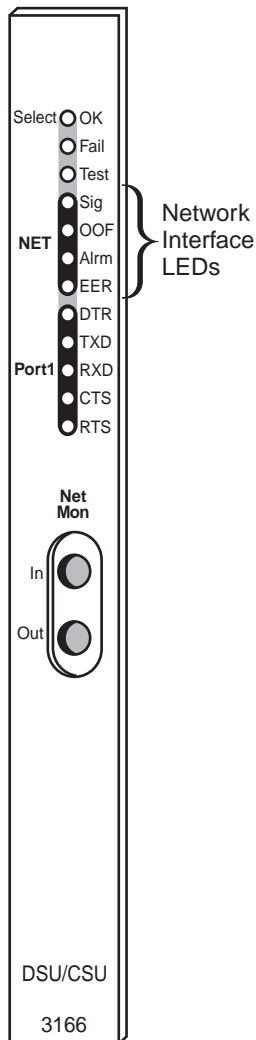

98-16081c

Table 3-2. Network Interface (NET) LEDs

| Name | Color | Meaning |
|-------------|--------|--|
| Sig | Green | Monitors the signal being received from the network. <i>ON:</i> A recoverable signal is being received from the network. <i>OFF:</i> The signal cannot be recovered from the network (a Loss of Signal condition exists). |
| OOF | Yellow | Monitors Out Of Frame (OOF) conditions on the received network signal. <i>ON:</i> At least one OOF was detected on the signal during the sampling period. <i>OFF:</i> No OOFs were detected on the signal during the sampling period. |
| Alrm | Yellow | Indicates whether an alarm condition exists on the received network signal. <i>ON:</i> An alarm condition (LOS, LOF, EER, Yellow, AIS) exists on the received network signal. Use the Device Health and Status command to determine the alarm type. <i>OFF:</i> No alarm condition exists on the network interface signal. |
| EER | Yellow | Indicates the Excessive Error Rate (EER) has been exceeded on the network interface. NOTE: This LED is only valid when ESF framing is being used. <i>ON:</i> The EER has been exceeded on the network interface. <i>OFF:</i> The EER has not been exceeded on the network interface. |

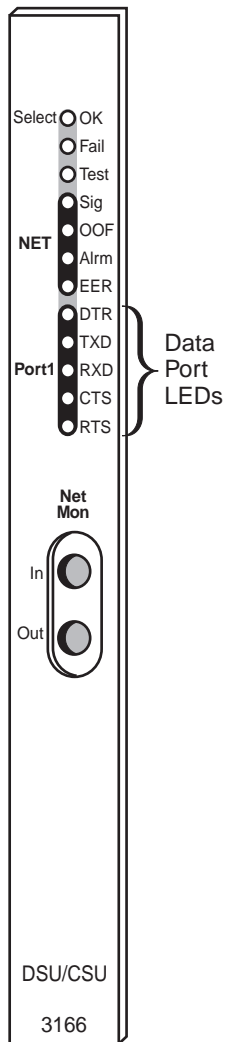

98-16081a

Table 3-3. Data Port (Port1) LEDs

| Name | Color | Meaning |
|------------|-------|---|
| DTR | Green | Monitors the state of interchange circuit CD (CCITT 108/1, /2) – Data Terminal Ready received from the synchronous data DTE. <i>ON:</i> DTR is being asserted by the synchronous data DTE. <i>OFF:</i> DTR is not being asserted. |
| TXD | Green | Monitors activity on interchange circuit BA (CCITT 103) – Transmitted Data. This is the data sent from the synchronous data DTE to the data port on the DSU/CSU. <i>ON:</i> Ones are being received from the synchronous data DTE. <i>OFF:</i> Zeros are being received from the synchronous data DTE. <i>CYCLING:</i> Both ones and zeros are being received from the synchronous data DTE. |
| RXD | Green | Monitors activity on interchange circuit BB (CCITT 104) – Received Data. This is data sent to the synchronous data DTE from the data port on the DSU/CSU. <i>ON:</i> Ones are being sent to the synchronous data DTE. <i>OFF:</i> Zeros are being sent to the synchronous data DTE. <i>CYCLING:</i> Both ones and zeros are being sent to the synchronous data DTE. |
| CTS | Green | Monitors the state of interchange circuit CB (CCITT 106) – Clear-to-Send sent to the synchronous data DTE. <i>ON:</i> CTS is being asserted by the DSU/CSU. <i>OFF:</i> CTS is not being asserted. |
| RTS | Green | Monitors the state of interchange circuit CA (CCITT 105) – Request-to-Send received from the synchronous data DTE. <i>ON:</i> RTS is being asserted by the synchronous data DTE. <i>OFF:</i> RTS is not being asserted. |

Displaying Unit Identity

The identity of the DSU/CSU (serial number, model number, software revision level, hardware revision level, and customer identification) is available through the Status branch of the SDCP menu (see Appendix A, *SDCP Menu*).

The customer identification is the only identity number you can change.

► Procedure

To display the DSU/CSU's identity (ID):

1. From the top-level menu screen, select Stat.

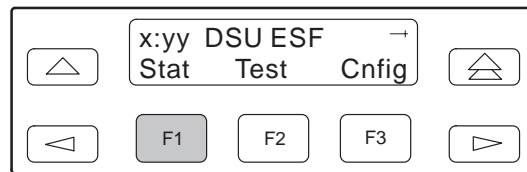

2. From the Status screen, press the \triangleright key until the ID selection appears on the screen.

3. Select ID.

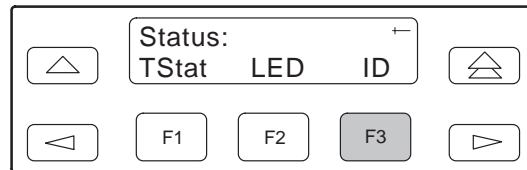

4. The following screens appear in the order listed each time you press the \triangleright key.

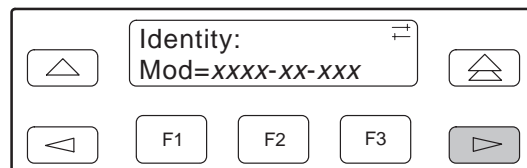
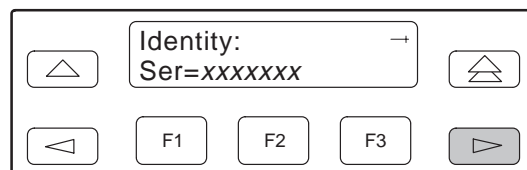

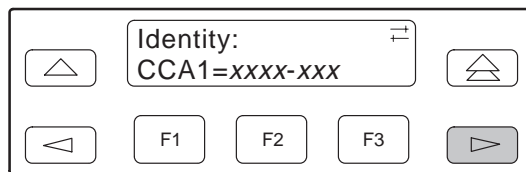
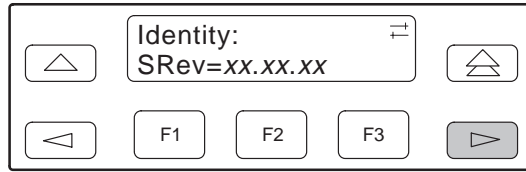
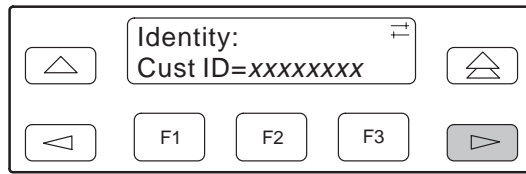

Setting Customer Identification

The customer identification is the only identity number you can change. It is used to uniquely identify the DSU/CSU.

► Procedure

To change the customer identification (CID):

1. From the top-level menu, press the \triangleright key until the Ctrl selection appears on the screen.
2. Select Ctrl.
3. From the Control screen, press the \triangleright key until the CID selection appears on the screen.
4. Select CID.

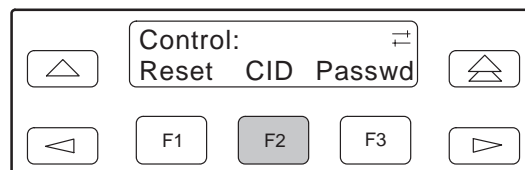

5. Use the \triangleleft and \triangleright keys to position the cursor under the desired character. You must enter a character before the \triangleright moves the cursor to the next space to the right.



6. Enter the desired ID. Press F1 (Up) and F2 (Down) to scroll up and down through the valid characters/numbers for the customer ID. Valid characters are **0** through **9**, **#**, **-**, **.**, **/**, **A** to **Z**, and blank space. Press F3 (Save) to save the ID.

Displaying LED Conditions

The same conditions monitored by the front panel LEDs can also be monitored by the LED command. This command is most useful when the DSU/CSU is being accessed remotely (see Appendix G, *Front Panel Emulation*). When using Front Panel Emulation, no LEDs are shown on the PC's screen; you must use the Stat command procedure described below to get LED information.

► Procedure

To display LED conditions on the front panel screen:

1. From the top-level menu screen, select Stat.
2. From the Status screen, press the \triangleright key until the LED selection appears on the screen.
3. From the Status screen, select LED.

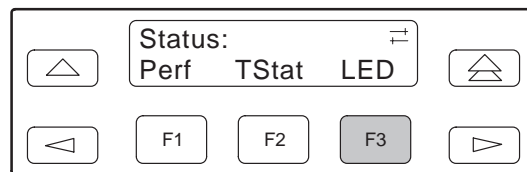

4. From the Select LEDs screen, press the Function key that corresponds to the interface for which you want to display LEDs.

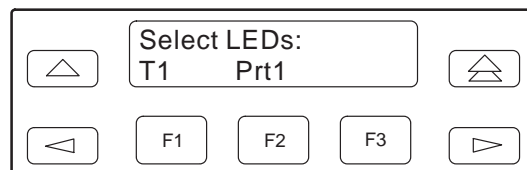

If you chose T1, the LED Display screen lists the LED signals, two at a time, on the second line. A vertical bar at the left of the LED name indicates the condition is ON, while an underscore indicates the condition is Off.

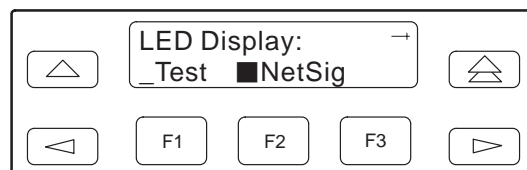

If you chose Prt1, the Port 1 LEDs screen lists the LED signals, two at a time, on the second line. A vertical bar at the left of the LED name indicates the condition is ON, while an underscore indicates the condition is Off.

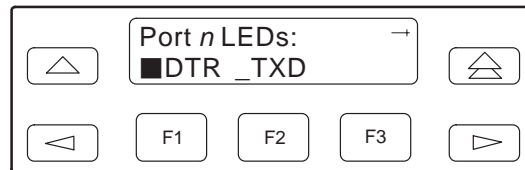

5. Use the \triangleright and \triangleleft keys to scroll LED names onto the screen.

Changing Configuration Options

The DSU/CSU is an intelligent device that displays only valid options for the current configuration. Therefore, you are only presented with menu choices that are consistent with the current configuration and operational state of the DSU/CSU; invalid combinations of configuration options do not appear. Be aware that although all options are shown in this guide, what you see on your DSU/CSU varies with your configuration.

The DSU/CSU offers configuration options located in the following memory areas:

- **Active (Activ)** – This is the configuration option set currently active for the DSU/CSU. Before a configuration option set becomes active for the DSU/CSU, you must save the set to the Active area. When the DSU/CSU is shipped from the factory, the Active configuration option set is identical to the Factory set. This area can be written to and controls the current operation of the device.
- **Customer 1 (Cust1)** – This is the first of two sets of customer-defined configuration options. This area can be written to.
- **Customer 2 (Cust2)** – This is the second of two sets of customer-defined configuration options. This area can be written to.
- **Factory 1 (Fact1)** – This is a set of configuration options preset at the factory. This set is determined by what is considered to be the most common configuration used in the DSU/CSU market. Factory 1 options are read-only.
- **Factory 2 (Fact2)** – This is a set of configuration options preset at the factory. This set is determined by what is considered to be the second most common configuration used in the DSU/CSU market. Factory 2 options are read-only.

The configuration options are divided into functional groups. [Appendix C](#) contains a list of the configuration options and defaults. These groups are:

- Port Interface
- Network Interface
- Channel
- General
- User Interface
- Alarm
- General Management
- Management Trap

The DSU/CSU arrives with two preset factory default configuration settings. These settings are based on the following:

- **Factory 1** – ESF framing format with B8ZS line coding format for the network interface. Data ports are unassigned.
- **Factory 2** – D4 framing format with AMI line coding format for the network interface. Data ports are unassigned.

If neither of the factory default settings support your network's configuration, you can customize the configuration options to better suit your application.

Use the Configuration (Cnfig) branch of the SDCP menu tree to display or change DSU/CSU configuration options (see [Appendix C](#), *Configuration Options*).

Displaying/Editing Configuration Options

► Procedure

To display/edit configuration options:

1. From the top-level menu screen, select Cnfig.

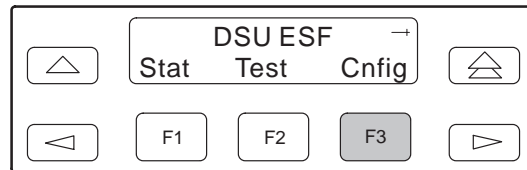

2. Select the configuration option set to be copied into the Edit area by using the appropriate Function key. Use the scroll keys, if necessary.



3. Select Edit.

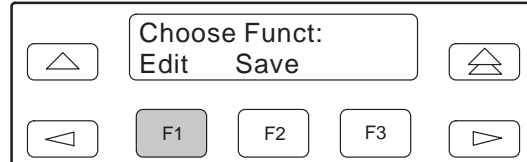

4. From the Edit screen, select the functional group you want to edit by pressing the appropriate Function key. Use the scroll keys, if necessary. (The NET selection is shown as an example only.)

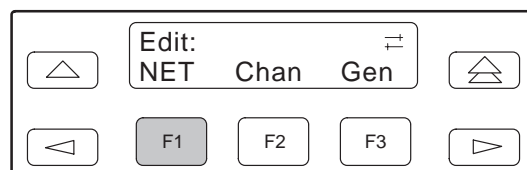

The configuration options for the selected functional group appear on the SDCP one option at a time. The option name appears on Line 1 with the current value next to it. To reach other options, use the Next and Previous selections to scroll forward and backward through the group of options.

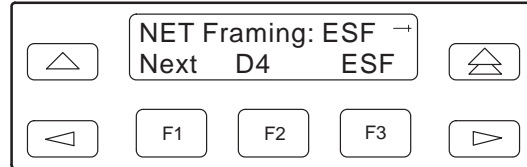

5. Press the appropriate Function key to choose another value. Use the scroll keys, if necessary.
6. Use the Save procedure to save your changes to the Active or Customer area.

Saving Edit Changes

Save edit changes to the Active area when you want those changes to take effect immediately. Save edit changes to the Customer area when you want to overwrite the existing Customer configuration options and store these changes for future use.

NOTE:

If you attempt to exit the Edit function after making changes without performing a Save, the DSU/CSU prompts you with **Save Options?** Choose **Yes** or **No**.

► Procedure

To save edit changes:

1. From the Choose Funct screen (one level above the Edit screen, two levels below the top-level menu screen), select Save.

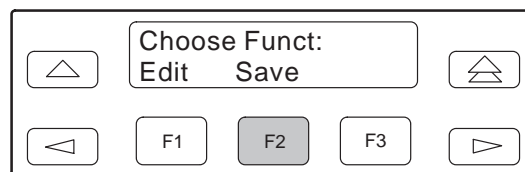

2. Choose whether you want to save to the Active, Customer 1, or Customer 2 area. Use the scroll keys, if necessary.

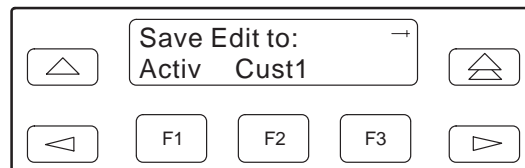

Enabling the Communication Port

Communication between the 3166 DSU/CSU and an external PC, ASCII device, SNMP manager, or async terminal interface (attached either locally or through an external modem) occurs through a communication (COM) port. Once the COM port is enabled, other COM port configuration options can be selected.

► Procedure

To enable the COM port:

1. From the top-level menu screen, select Cnfig.
2. Select the configuration option set to be copied into the Edit area by using the appropriate Function key. Use the scroll keys, if necessary.
3. Select Edit.
4. From the Edit screen, press the \triangleright key until the User selection appears on the screen.
5. Select User.

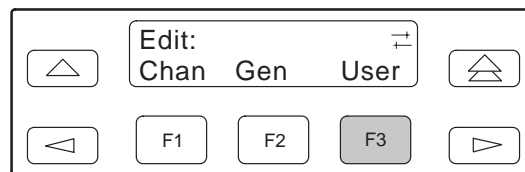

6. Press F1 (Next) until the Com Port configuration option appears.
7. Select Enab to enable the COM port.

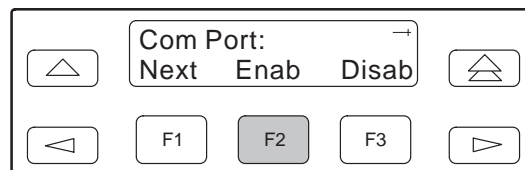

The carrier COM port provides the following functionality:

- If configured for ASCII, only one ASCII device may be used for the carrier. (If two COM ports are configured for ASCII, neither will work.)
- If configured for Mgmt, each device in the carrier can support a Mgmt COM port; however, each Mgmt COM port must be connected to a different subnet. To facilitate IP data routing, the device with the closest link to the SNMP manager or Telnet client should be configured as the IP Bus Master.
- If configured for either ASCII or Mgmt, the carrier COM port may be configured to control an external device (e.g., modem, x.25 PAD) through the use of AT or user-specified commands.

The set of valid characters for control of the carrier external COM port device is as follows:

- The numbers: 0–9
- The lowercase letters: a–z
- The uppercase letters: A–Z
- The space (“ ”) character
- The ASCII symbols (in ascending order, based on the ASCII code)
- The End Of Line (EOL) symbol: ←
- The caret (“^”) control character is used to select non-printable ASCII characters. The caret “^” must be followed by one character which together form the control sequence. [Table 3-4](#) defines all of the available control sequences.

Table 3-4. Control Sequence

| Sequence | ASCII | HEX |
|-----------------|--------------|------------|
| ^A or ^a | SOH | 0x01 |
| ^B or ^b | STX | 0x02 |
| ^C or ^c | ETX | 0x03 |
| ^D or ^d | EOT | 0x04 |
| ^E or ^e | ENQ | 0x05 |
| ^F or ^f | ACK | 0x06 |
| ^G or ^g | BEL | 0x07 |
| ^H or ^h | BS | 0x08 |
| ^I or ^i | HT | 0x09 |
| ^J or ^j | LF or NL | 0x0A |
| ^K or ^k | VT | 0x0B |
| ^L or ^l | FF or NP | 0x0C |
| ^M or ^m | CR | 0x0D |
| ^N or ^n | SO | 0x0E |
| ^O or ^o | SI | 0x0F |
| ^P or ^p | DLE | 0x10 |
| ^Q or ^q | DC1 | 0x11 |
| ^R or ^r | DC2 | 0x12 |
| ^S or ^s | DC3 | 0x13 |
| ^T or ^t | DC4 | 0x14 |
| ^U or ^u | NAK | 0x15 |
| ^V or ^v | SYN | 0x16 |
| ^W or ^w | ETB | 0x17 |
| ^X or ^x | CAN | 0x18 |
| ^Y or ^y | EM | 0x19 |
| ^Z or ^z | SUB | 0x1A |
| ^{ | ESC | 0x1B |
| ^\ ^} | FS | 0x1C |
| ^} | GS | 0x1D |
| ^^ | RS | 0x1E |
| ^_ ^_ | US | 0x1F |

Configuring the DSU/CSU for SNMP or Telnet Access

To configure the DSU/CSU for SNMP or Telnet access:

- Enable the SNMP agent or Telnet server within the DSU/CSU (see Appendix C, *Configuration Options*).
- Select and configure the port that provides the link to the SNMP or Telnet system.
- Set the Internet Protocol (IP) address and subnet mask needed to access the DSU/CSU (see Appendix F, *IP Network Addressing Scenarios*).
- Select the link layer protocol (PPP or SLIP) for the port that provides the link to the SNMP or Telnet system.
- For SNMP links, specify the two community names (and their access levels) that are allowed to access the device's Management Information Base (MIB).
- For SNMP links, configure the device to send traps to the SNMP manager, if desired.
- Specify the Telnet password or SNMP validation options, if desired (see Appendix C, *Configuration Options*).

Selecting the Port

The SNMP manager, Telnet device, external LAN adapter, or network device (e.g., a router) can be directly connected to the communications (COM) port.

The COM port can support either synchronous or asynchronous PPP, or asynchronous SLIP at data rates of up to 19,200 bps.

The example below shows how to select the COM port as the link to the SNMP or Telnet system.

► Procedure

To select the COM port as the SNMP or Telnet link:

1. From the top-level menu screen, select Cnfig.
2. Select the configuration option set to be copied into the Edit area by using the appropriate Function key. Use the scroll keys, if necessary.
3. Select Edit.
4. From the Edit screen, press the \triangleright key until the User selection appears on the screen.
5. Select User.

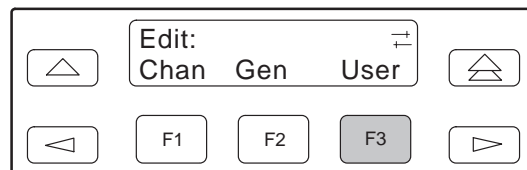

6. Press F1 (Next) until the Com Use configuration option appears.
7. Select Mgmt to configure the COM port as the SNMP or Telnet link.

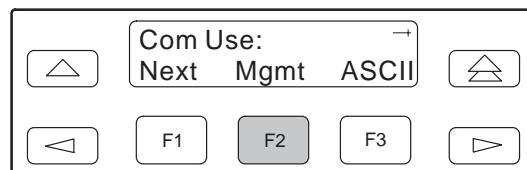

Setting the IP Address

The IP address is the address used by the SNMP or Telnet system to access the DSU/CSU (see Appendix F, *IP Network Addressing Scenarios*). For DSU/CSUs using PPP, the IP address can be negotiated if the network device (e.g., router or SNMP manager) supports such negotiation. The IP address is composed of four fields with three digits per field (*xxx.xxx.xxx.xxx*).

The example below assumes that an IP address of 010.155.111.222 is being set for the COM port. You can use the same principles to assign any value (between 000 and 255 for each digit field).

► Procedure

To assign an IP address to the COM port:

1. From the top-level menu screen, select Cnfig.
2. Select the configuration option set to be copied into the Edit area by using the appropriate Function key. Use the scroll keys, if necessary.
3. Select Edit.
4. From the Edit screen, press the \triangleright key until the Mgmt selection appears on the screen.
5. Select Mgmt.

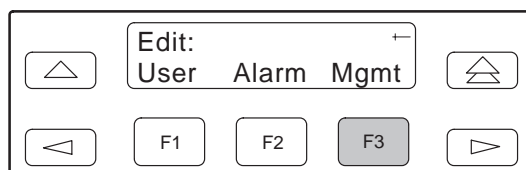

6. From the Mgmt Config screen, select Gen.

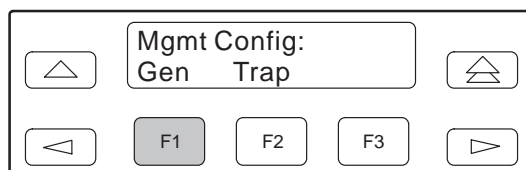

7. Press F1 (Next) until the Com IP Adr configuration option appears.

NOTE:

Steps 8 and 9 describe the process for entering an IP address. This process applies to any IP address.

8. Press F2 (Edit) to edit the IP address. You have the option of using F3 (Clear) to reset the IP address to the factory default *000.000.000.000*.

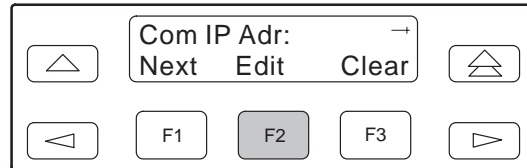

9. Use the \leftarrow and \rightarrow keys to position the cursor under the digit you want to change. Press F1 (Up) to increment the digit or F2 (Down) to decrement the digit. In this example, you would press \rightarrow once to place the cursor under the middle digit in the first digit field, then press F1 (Up) once to change the 0 to a 1. Continue in this manner to change the other digits.

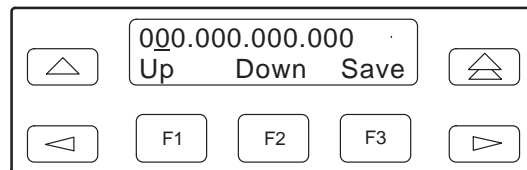

10. When you are through changing the IP address, you **must** press F3 (Save) to save the value. Otherwise, the original value will be retained.

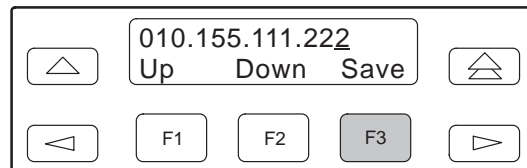

Selecting the Link Layer Protocol

Two link layer protocols, Point-to-Point Protocol (PPP) and Serial Line Internet Protocol (SLIP), are supported for connection to an external SNMP manager, Telnet device, or network device (e.g., a router). PPP can be used for synchronous or asynchronous operation. SLIP can be used for asynchronous operation only.

The Model 3166 DSU/CSU implementation of PPP supports the following:

- Full negotiation of PPP's Link Control Protocol (LCP).
- Active negotiation of LCP when the connection is established.
- Maximum Request Unit (MRU) sizes up to 1500 bytes, but the DSU/CSU will attempt to negotiate down to 500 bytes.
- The DSU/CSU provides a unique LCP magic number derived from the unit serial number and the elapsed time.
- Full negotiation of escape characters.

The Model 3166 DSU/CSU implementation of PPP does not support Link Quality Reports (LQR), compression, encryption, Password Authentication Protocol (PAP) or Challenge Handshake Authentication Protocol (CHAP).

The Model 3166 DSU/CSU implementation of SLIP supports a fixed MRU size of 1006 bytes.

Before selecting the protocol, you must first select the port to be used as the communications link. Refer to *Selecting the Port* on page 3-20. This example assumes that the COM port is being used as the communications link.

► Procedure

To select the link layer protocol:

1. From the top-level menu screen, select Cnfig.
2. Select the configuration option set to be copied into the Edit area by using the appropriate Function key. Use the scroll keys, if necessary.
3. Select Edit.
4. From the Edit screen, press the \triangleright key until the Mgmt selection appears on the screen.

5. Select Mgmt.

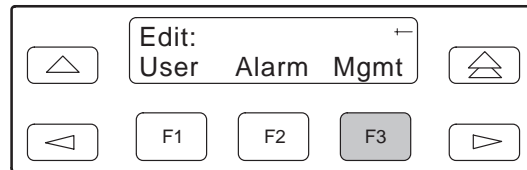

6. From the Mgmt Config screen, select Gen.

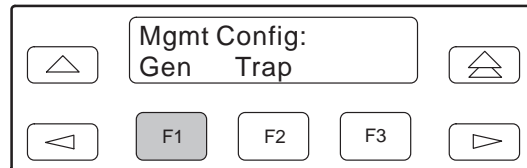

7. Press F1 (Next) until the Com Link configuration option appears.

8. Press F2 (PPP) or F3 (SLIP).

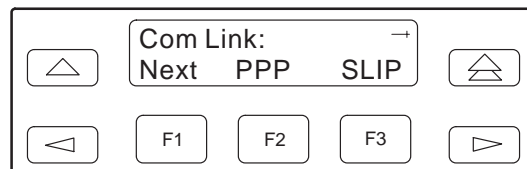

Specifying the Community Name(s) and Access Type(s)

You have the capability of specifying up to two community names (community name 1 and community name 2) to be used by external SNMP managers when trying to access objects in the DSU/CSU's MIB. Once you specify the community name(s), you must then specify the type of access to the MIB that SNMP managers in the community are permitted to have.

► Procedure

To specify the community name 1 and its access type:

1. From the top-level menu screen, select Cnfig.
2. Select the configuration option set to be copied into the Edit area by using the appropriate Function key. Use the scroll keys, if necessary.
3. Select Edit.
4. From the Edit screen, press the \triangleright key until the Mgmt selection appears on the screen.

5. Select Mgmt.

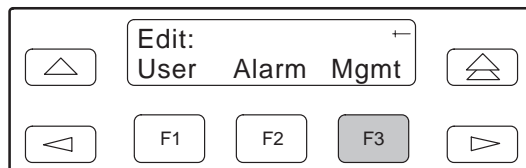

6. From the Mgmt Config screen, select Gen.

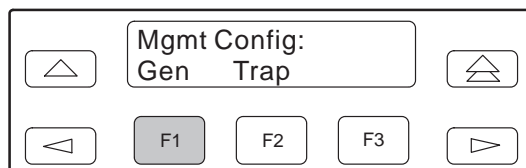

7. Press F1 (Next) until the CommunityName1 configuration option appears.
 8. Press F2 (Edit) to edit the community name.

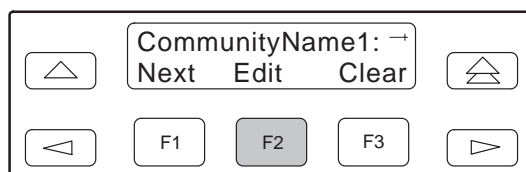

NOTE:

Steps 9 and 10 describe the process for entering text strings for Mgmt configuration options. This process applies to entering any text strings into Mgmt configuration options.

9. Use the \leftarrow and \rightarrow keys to position the cursor under the character you want to change. Press F1 (Up) or F2 (Down) to scroll through the valid numbers/characters for the text string.

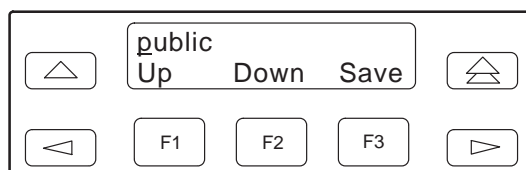

The F1 (Up) key scrolls through the ASCII character set in the following order: numbers (0–9), lowercase letters (a–z), uppercase letters (A–Z), space character, ASCII symbols (ascending order, based on ASCII code), and the End of Line symbol (\leftarrow). The \leftarrow erases all characters to the right of the cursor.

10. When you are through changing the community name, you **must** press F3 (Save) to save the value. Otherwise, the original value will be retained.
 11. Press F1 (Next) until the Access 1 configuration option appears.

12. Press F2 (Read) or F3 (R/W).

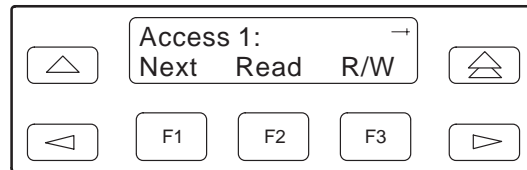

The Read selection allows read-only access (SNMP “Get”) to the accessible objects in the MIB when community name 1 is used. The R/W selection allows Read/Write access (SNMP “Get” and “Set”) to the objects in the MIB. Write access is allowed for all objects specified as read/write in the MIB. Read access is allowed for all objects specified as read-only or read/write.

Configuring SNMP Traps

A trap is an unsolicited message that is sent from the DSU/CSU to an SNMP manager when the DSU/CSU detects certain pre-specified conditions. These traps enable the SNMP manager to monitor the state of the network.

The SNMP Trap configuration option must be enabled for trap messages to be sent over the communications link. You must specify the number of SNMP managers that are to receive traps from this DSU/CSU, an IP address for each SNMP manager specified, and the type of traps to be sent from this DSU/CSU. For more information, refer to Appendix C, *Configuration Options*, and *SNMP Traps* in Chapter 4, *Monitoring and Testing*.

Enabling SNMP Trap Messages

► Procedure

To enable SNMP trap messages from this DSU/CSU:

1. From the top-level menu screen, select Cnfig.
2. Select the configuration option set to be copied into the Edit area by using the appropriate Function key. Use the scroll keys, if necessary.
3. Select Edit.
4. From the Edit screen, press the \triangleright key until the Alarm selection appears on the screen.
5. Select Alarm.

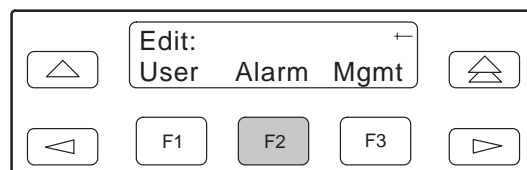

6. Press F1 (Next) until the SNMP Trap configuration option appears.

7. Press F2 (Enab) to enable trap messages over the SNMP management link.

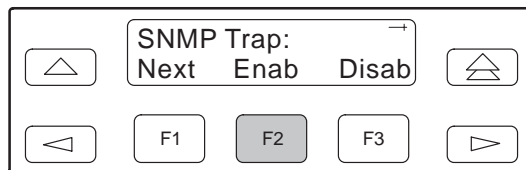

Selecting the Number of Trap Managers

If you intend to issue traps to an SNMP manager(s) from this device, you must specify the number of SNMP managers that are to receive the traps.

► Procedure

To specify the number of SNMP managers to receive traps from this device:

1. From the top-level menu screen, select Cnfig.
2. Select the configuration option set to be copied into the Edit area by using the appropriate Function key. Use the scroll keys, if necessary.
3. Select Edit.
4. From the Edit screen, press the \triangleright key until the Mgmt selection appears on the screen.
5. Select Mgmt.

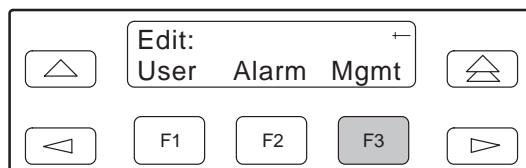

6. From the Mgmt Config screen, select Trap.

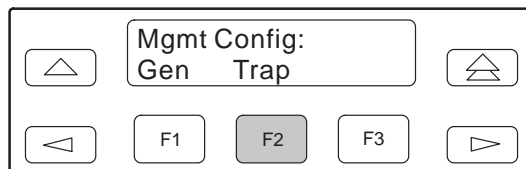

7. Select the number of SNMP managers to receive traps (from 1 through 6) by using the appropriate Function key. Use the scroll keys, if necessary.

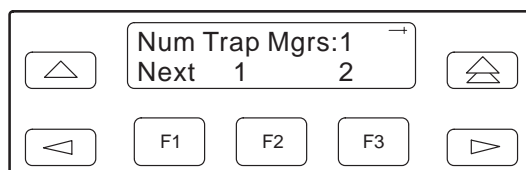

Configuring a Destination for SNMP Traps

A destination must be configured for each SNMP trap manager specified. This configuration option is displayed for the number of trap managers specified by the Number of Trap Managers configuration option.

► Procedure

To configure an IP address for the SNMP trap manager:

1. From the top-level menu screen, select Cnfig.
2. Select the configuration option set to be copied into the Edit area by using the appropriate Function key. Use the scroll keys, if necessary.
3. Select Edit.
4. From the Edit screen, press the \triangleright key until the Mgmt selection appears on the screen.
5. Select Mgmt.

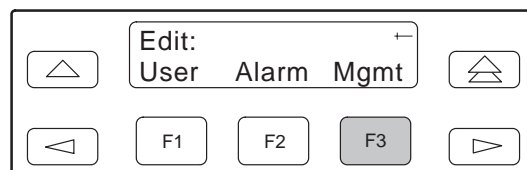

6. From the Mgmt Config screen, select Trap.

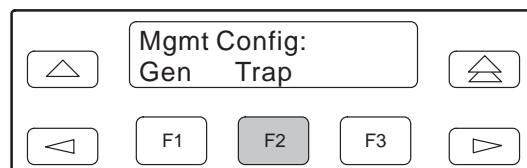

7. Press F1 (Next) until the Trap n IP Address configuration option appears.
8. Press F2 (Edit) to edit the IP address. You have the option of using F3 (Clear) to reset the IP address to the factory default *000.000.000.000*. Refer to [Setting the IP Address](#) on page 3-21 for more information on setting an IP address.
9. Press F1 (Next) until the Trap n Destination configuration appears, and select the destination for the SNMP trap by using the appropriate Function key. Use the scroll keys, if necessary.

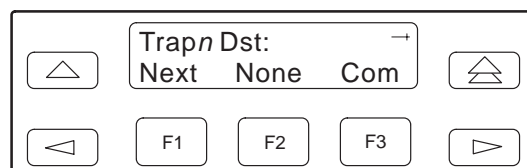

Allocating Data Ports

By using the configuration options, assign a specific port to DS0 channels on the network interface. The following methods are available to assign DS0 channels to the port:

- **Block** – Allows a block of contiguous channels to be assigned by specifying a data port rate and an initial DS0 channel (the first DS0 channel in a block of DS0 channels). The number of channels assigned is determined by the port rate. Only those initial DS0 channel numbers that provide enough bandwidth (based on the port's data rate) are displayed on the screen. These channels are automatically assigned to the destination T1 interface when the initial DS0 channel is selected.
- **ACAMI (Alternate Channel Alternate Mark Inversion)** – Allows a block of contiguous channels to be assigned by specifying a data port rate and an initial DS0 channel (the first DS0 channel in a block of DS0 channels). However, with ACAMI, the number of channels assigned is twice the number needed for the port rate. This is because with ACAMI, every alternate DS0 channel (starting with the $n+1$ DS0 channel), does not carry data from the port, but instead always transmits and receives all ones.
- **Chan (Channel)** – Individually selects the DS0 channels to allocate to the data port. The data port rate is automatically determined based on the number of channels selected.

Once a port is selected, you have access to the configuration options to complete the port allocation procedure. These configuration options enable you to:

- Assign the selected port to the desired interface.
- Select the desired method for channel allocation.
- Select the port rate and starting channel (if the allocation method is block or ACAMI).
- Select the specific channels (if the allocation method is by individual channel).

► Procedure

To select the data port:

1. From the top-level menu screen, select Cnfig.
2. Select the configuration option set to be copied into the Edit area by using the appropriate Function key. Use the scroll keys, if necessary.
3. Select Edit.
4. Select Chan.

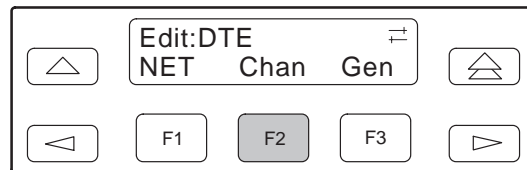

5. From the Channel Config screen, press the \triangleright key to scroll the ports onto the screen.
6. Select Prt1.

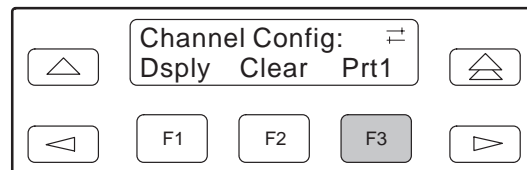

7. Press F1 (Next) to display the appropriate configuration options on the screen. Use one of the following examples, depending on whether you are assigning by block, ACAMI, or individual channel.

Block or ACAMI Assignment Method

The Assign By configuration option screen appears after you select a port.

► Procedure

To assign by the block or ACAMI method:

1. Press F2 for Block or F3 for ACAMI.

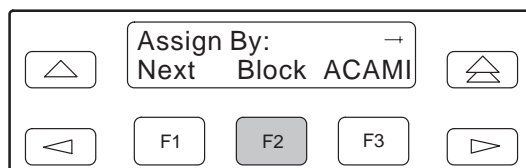

or

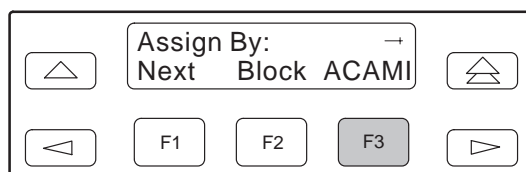

2. Press F1 (Next) to display the next configuration option (Port Rate).
3. Use the ◀ or ▶ key to scroll the desired port rate onto the screen. Rates scroll in groups of three. Available selections depend on the current base rate selected for the port. Press the corresponding Function key to select the port rate. Then, select Next to display the Start At configuration option on the screen.

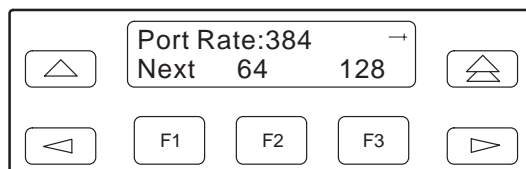

4. The Start At screen displays the configuration option used to select the starting DS0 channel. The network channels appear on the screen.

The following screen shows an example for the network interface. Use the \triangleleft or \triangleright key to scroll the desired channel onto the screen. Use the Function keys to select the starting channel. Only those DS0 channel numbers that provide enough bandwidth (based on the configured data rate) to be used as a starting channel number are displayed. Channel allocation for this port can only be cleared by selecting Clear.

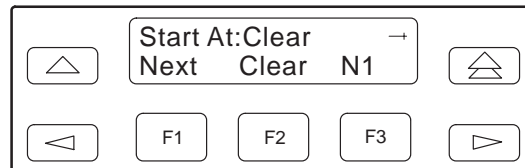

Individual Channel Assignment Method

The Assign By configuration option screen appears after you select a port.

► Procedure

To assign by the individual channel method:

1. Press the \triangleright key once to bring the Chan selection onto the screen.

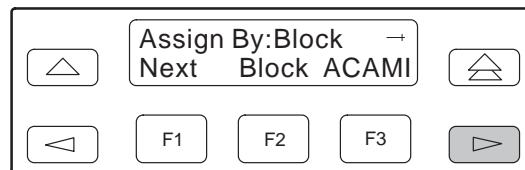

2. Press F3 (Chan).

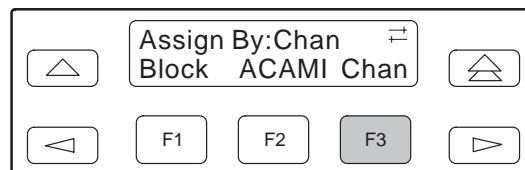

3. Press F1 (Next) to display the next configuration option (channel allocation).

4. Line 1 displays the 24 channels for the network interface. Line 2 displays what is allocated to the DS0 channel shown in Line 1. Pressing the ◀ or ▶ key scrolls the channels onto the screen in groups of three. Select the channel by pressing the Function key under the desired number. Port n appears. The port is assigned to that channel. To deallocate a port, press the Function key under that port number. Pressing the Function key under channels assigned to other ports has no effect.

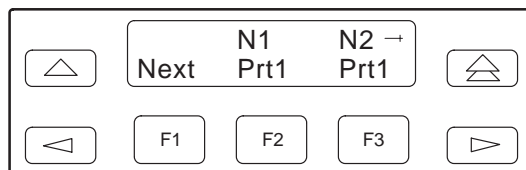

Clearing DS0 Channel Allocation

You can clear (deallocate) all the DS0 channels currently allocated to either the network interface or the synchronous data ports.

► Procedure

To clear DS0 channel allocation:

1. From the top-level menu screen, select Cnfig.
2. Select the configuration option set to be copied into the Edit area by using the appropriate Function key. Use the scroll keys, if necessary.
3. Select Edit.
4. From the Edit screen, press the ▶ key until the Chan selection appears on the screen.
5. Select Chan.

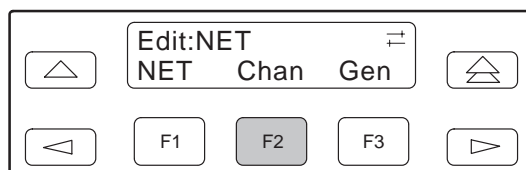

6. From the Channel Config screen, select Clear.

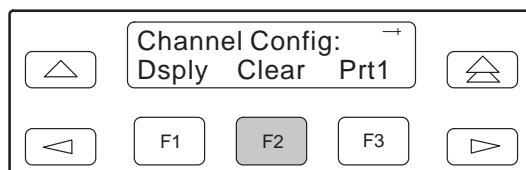

Selecting the Timing Source

The DSU/CSU provides the ability to select a master clock (timing) source that is used to synchronize all of the T1 and data port interfaces on the DSU/CSU. The clock for each interface is at the appropriate rate for that interface (e.g., 1.544 Mbps for the T1 interface, the configured port rate for the data ports), and it is independent of the master clock rate. This means that the master clock rate and the DSU/CSU interface rates may be different.

The clock source configuration options enable you to select either the network interface, a synchronous data port, or the internal clock.

Configuring for Network Timing

► Procedure

To configure for network timing:

1. From the top-level menu screen, select Cnfig.
2. Select the configuration option set to be copied into the Edit area by using the appropriate Function key. Use the scroll keys, if necessary.
3. Select Edit.
4. From the Edit screen, press the \triangleright key until the Gen selection appears on the screen.
5. Select Gen.

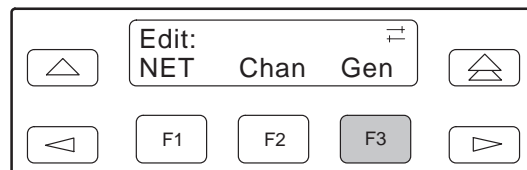

6. Press F1 (Next) to display the next configuration option (Clock Src).
7. Select the master clock source. For network, press F2 (note that network is also the default).

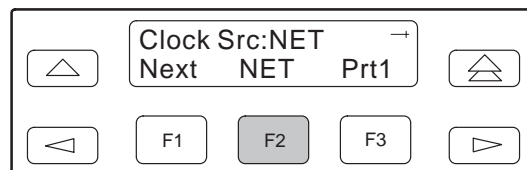

Establishing Access Security on the COM Port

Although the password feature is available, it is not required as a factory default. If used, it ensures access security before device control is passed to a device connected to the COM port. The default is **None**. The password itself is set separately (refer to the following section, *Setting a Password*).

► Procedure

To establish access security on a port:

1. From the top-level menu screen, select Cnfig.
2. Select the configuration option set to be copied into the Edit area by using the appropriate Function key. Use the scroll keys, if necessary.
3. Select Edit.
4. From the Edit screen, press the \triangleright key until the User selection appears on the screen.
5. Select User.

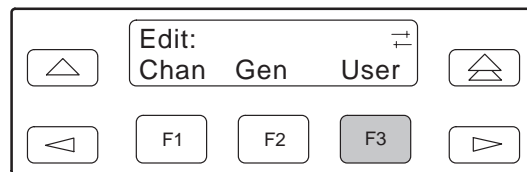

6. Press F1 (Next) until the Password configuration option appears.
7. Select Com if it to receive password control.

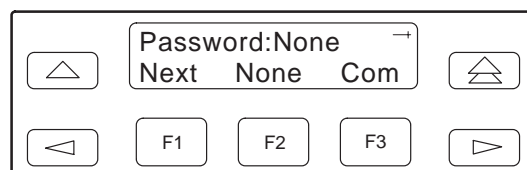

Setting a Password

In addition to establishing access security on a port (refer to the previous section, *Establishing Access Security on the COM Port*) the password itself is set. Unless you specify otherwise, the password is null.

► Procedure

To set a password:

1. From the top-level menu screen, press the \triangleright key until the Ctrl selection appears on the screen.
2. Select Ctrl.
3. From the Control screen, press the \triangleright key until the Passwd selection appears on the screen.
4. Select Passwd.

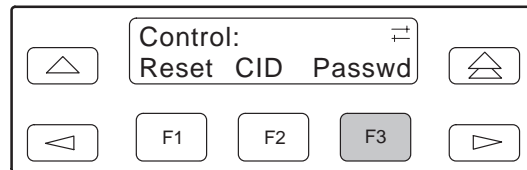

5. Use the \triangleleft and \triangleright keys to position the cursor under the desired character. You must enter a character before the \triangleright moves the cursor to the next space to the right.

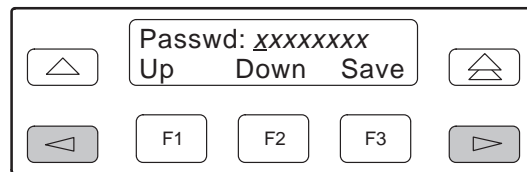

6. Enter the desired password. Press F1 (Up) and F2 (Down) to scroll up and down through the valid characters/numbers for the password. Valid password characters are **0-9**, **a-z**, **A-Z**, **#**, **-**, **.**, and **/**. Press F3 (Save) to save the password.



Entering a Password to Gain Access

You are prompted to enter a password (up to 8 characters) when you are accessing a port whose Password configuration option is set (refer to the previous section, *Setting a Password*).

Valid password characters are **0–9, a–z, A–Z, #, -, ., and /**. The existing password is not shown on the screen. An underscore in the first position shows where to enter the first character. If the password is set to all null characters (default value), press F3 (Done) when the password screen first appears.

The following screen appears when you access a DSU/CSU that has a password enabled.

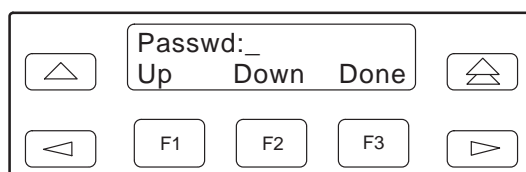

► Procedure

To enter a password:

1. Use the \leftarrow and \rightarrow keys to position the cursor under the desired character. You must enter a character before the \rightarrow key moves the cursor to the next space to the right. The \leftarrow key is not destructive.

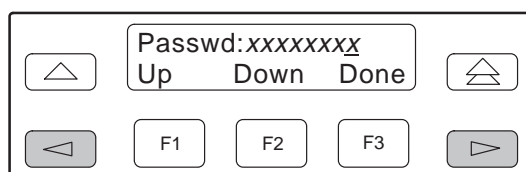

2. Enter the required password. Press F1 (Up) and F2 (Down) to scroll up and down through the valid characters/numbers for the password. You have five minutes to enter the correct password before the DSU/CSU ends the session.
3. Press F3 (Done) to indicate you are done entering the password. If you enter an invalid password, the message **Invalid Password** appears.

Acquiring/Releasing the User Interface

You can access the user interface from either the the COM port or the SDCP. The DSU/CSU allows only one user interface to be active at a time. The COM port is the default user interface at power-up or after a reset. It is also the default during a software download or when a failure occurs at either the local or remote PC interface.

You can switch an inactive user interface to active if:

- The current active user interface has had no activity (no key was pressed) for at least five minutes.
- The active user interface has been released with the Release command of the Control branch.
- The active interface connection is broken. This includes the termination of the front panel emulation program on a locally attached PC (if the PC supports DTR) or the termination of the Asynchronous Terminal Interface on a remote or locally attached terminal.

Acquiring the Active User Interface

To acquire the active user interface, press any key. If you are using the PC interface, use the mouse to click on the desired Function key. The top-level menu screen appears on the active user interface, regardless of what screen was displayed at the previous active user interface.

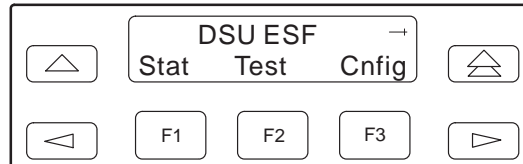

The inactive interface displays an interface active message when a Function key is pressed or a connection is made on the inactive user interface and control cannot be switched because the currently active interface is in use. On the screen, either Com Port or SDCP is shown as active. For example:

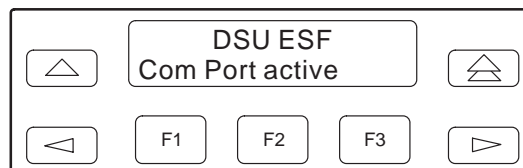

The inactive interface displays an interface idle message after control has been released from the previously active interface and another interface has not become active.

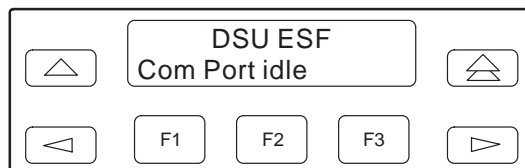

Releasing the Active User Interface

To release the current active user interface, either allow five minutes to elapse without pressing any key or use the Release command.

► Procedure

To use the Release command:

1. From the top-level menu screen, press the \triangleright key until the Ctrl selection appears on the screen.
2. Select Ctrl.
3. From the Control screen, select Rel (Release).

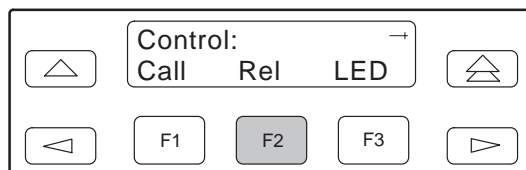

The active user interface is released. The message **Released** appears. No user interface is active until input is received from a user interface.

Resetting the DSU/CSU

Use the Reset command to perform a power-on reset of the DSU/CSU.

► Procedure

To reset the DSU/CSU:

1. From the top-level menu screen, press the \triangleright key until the Ctrl selection appears on the screen.
2. Select Ctrl.
3. From the Control screen, press the \triangleright key until the Reset selection appears on the screen.
4. Select Reset.

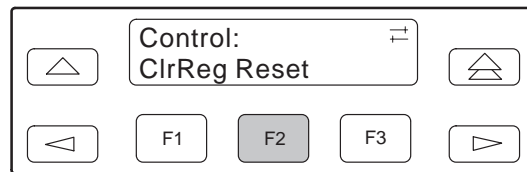

5. From the Device Reset screen, press F1 to initiate a reset of the DSU/CSU (the power-up sequence screen appears). Press F2 instead to return to the Control screen without initiating a reset.

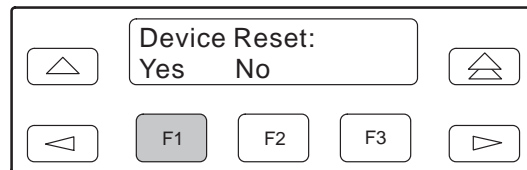

Monitoring and Testing

4

Overview

The 3166 DSU/CSU can detect and report faults, and perform diagnostic tests. These features ensure that your DSU/CSU is giving you optimum performance in your network.

Self-Test Health

Use the Self-Test Health command to display the results of the power-up self-test. Possible messages are listed in [Table 4-1](#). See Chapter 2, *Installation*, for more information about power-up self-test.

► Procedure

To display power-up self-test results:

1. From the top-level menu screen, select Stat.

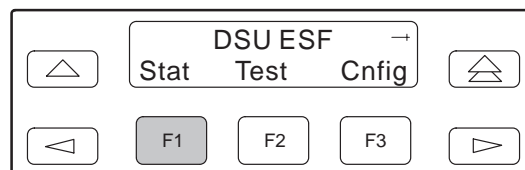

2. From the Status screen, select STest.

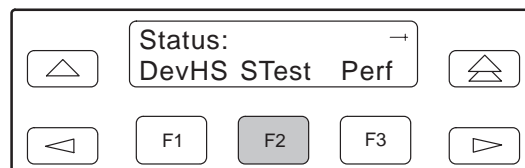

- View the results of the last power-up self-test. If no problems were found during power-up, the following message appears.

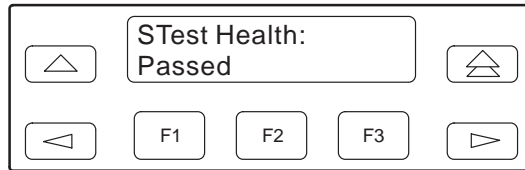

Table 4-1. Self-Test Health Messages

| Message | Description |
|------------------|--|
| Passed | No problems were found during power-up. |
| CPU fail | The central processing unit failed internal testing. |
| Device fail | One or more of the unit's integrated circuit chips failed to pass internal device level testing. |
| B8ZS/LOS fail | The unit failed to encode data properly or to detect Loss Of Signal. |
| Alarm fail | The unit failed to transmit AIS or to detect an Yellow alarm. |
| Memory fail | The unit failed program checksum verification. |
| NET T1 fail | The unit failed to internally loop data on the network T1 circuit. |
| DSU fail | The unit failed to internally loop data on the DSU. |
| DSU Port1 fail | Port's integrated circuitry failed to pass device internal testing. |
| Unknown Exp Dev | The unit is not able to recognize the expansion device connected to the main circuit card. |
| Failure xxxxxxxx | An 8-digit hexadecimal failure code is provided for service personnel. |

Device Health and Status

Use the Device Health and Status branch to view the current health and status messages for the DSU/CSU. Table 4-2 lists these messages in priority order.

► **Procedure**

To display device health and status:

- 1. From the top-level menu screen, select Stat.
- 2. From the Status screen, select DevHS.

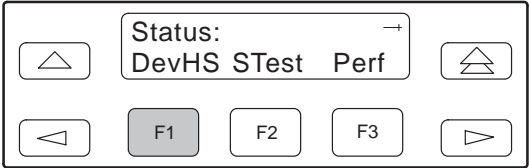

Alarm/status messages appear on Line 2 of the LCD in priority order (highest to lowest). The DSU/CSU is polled for current status every ten seconds. If the status has changed from the last poll, the Health and Status screen is updated and the highest priority message is displayed.

- 3. Use the scroll keys, if necessary, to scroll additional device health and status messages onto the LCD.

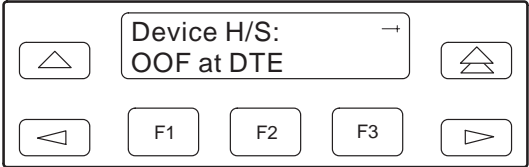

The Auto Device Health and Status screen appears when there is no activity (no keys pressed) on the active physical interface for five minutes. Only the highest priority message appears on Line 2 of the LCD.

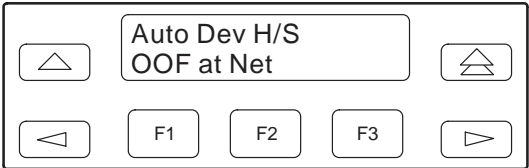

Table 4-2. Device Health and Status Messages

| Message | Description |
|------------------|--|
| LOS at Net | A Loss Of Signal condition (175 consecutive zeros) has been detected on the network interface. The condition is cleared when the density of ones to zeros received is 12.5%. |
| OOF at Net | An Out Of Frame condition (2 out of 4 frame synchronization bits in error) has been detected on the network interface. The condition is cleared when a reframe occurs. |
| AIS at Net | An Alarm Indication Signal (unframed all ones signal) is being received by the network interface. |
| EER at Net | An Excessive Error Rate condition has been detected on the network interface (the bit error rate has exceeded the configured threshold for ESF framing). The condition is cleared when the error rate falls below the threshold value. |
| Yellow at Net | A Yellow Alarm signal is being received by the network interface. |
| Master Clk fail | The master clock has failed. Timing for the DSU/CSU is provided by the internal clock. |
| OOF at Prt1 | An Out Of Frame condition has been detected on data port Port1. This condition only occurs if the synchronous data port's Embedded Data Link (EDL) is enabled. |
| EER at Prt1 | The error rate of the received signal has exceeded the configured threshold for data port Port1. This condition only occurs if the synchronous data port's Embedded Data Link (EDL) is enabled. The condition is cleared when the error rate falls below the synchronous data port's configured threshold value. |
| COM IP Down | The IP management link is in a down state for the COM port. This condition occurs if the COM port is configured for Mgmt, and communication between the management system and the DSU/CSU is not currently possible for this port. |
| Selftest failed | A failure was detected during the power-on self-test. Select STest (in the Stat branch) to display more information about the failure. |
| DevFail xxxxxxxx | An internal error has been detected by the operating software. An 8-digit code appears for use by service personnel. Clear the condition by using the Clear function under the Status branch, or by resetting the device. |
| Download failed | A download attempt was interrupted and failed to complete. The condition is cleared by resetting the device. |
| Test in progress | A test is currently active. Select Tstat (in the Stat branch) to display more test information. |
| DSU Operational | This message only appears if there are no valid alarm or status messages. |

Performance Reports

When the network interface is configured for ESF operation, network performance is continuously monitored and maintained in two sets of aggregate registers: Carrier Network Interface Registers (Telco) and User Network Interface Registers (User). The User registers contain an extra status register (Status Event).

Registers shown on the front panel LCD are listed in [Table 4-3](#). These registers are status registers that collect performance data for the previous 24-hour period. Performance data is updated in 15-minute intervals. After 15 minutes, the current interval is rolled over into a set of accumulator registers that represent the previous 96 15-minute intervals for the register. An interval total of how many of the 96 registers contain valid data is also kept, as well as a 24-hour total for each accumulator register.

Port performance is continuously monitored and maintained in memory registers when the port is configured to use EDL. The DSU/CSU maintains two sets of port registers for each synchronous data port: far-end port registers and near-end port registers. These registers are status registers that collect performance data for the previous 8-hour period. Port data is updated in 15-minute intervals. After 15 minutes, the current interval is rolled over into a set of accumulator registers that represent the previous 32 15-minute intervals for the register. An interval total of how many of the 32 registers contain valid data is also kept, as well as a 8-hour total for each accumulator register.

► Procedure

To display User Network Interface (User) performance:

1. From the top-level menu screen, select Stat.
2. From the Status screen, select Perf.

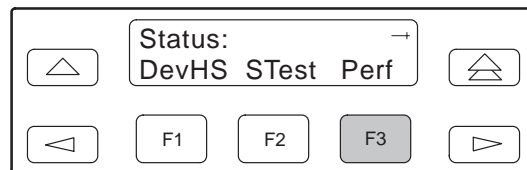

3. Select User registers.

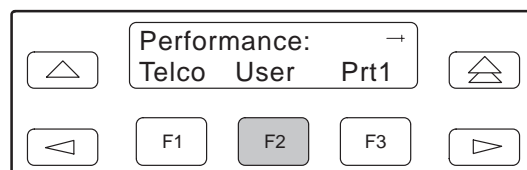

4. From the User Registers screen:

- Press F1 to view current registers (go to Step 5)
- Press F2 to view 24-Hour Totals (go to Step 6)
- Press F3 to view 15-Minute Interval Registers (go to Step 7)

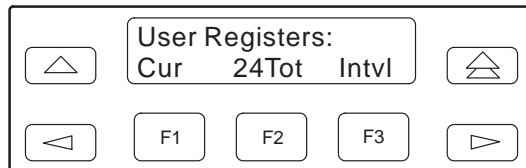

5. When you press F1 from the User Registers screen, the User registers for the current 15-minute interval appear.

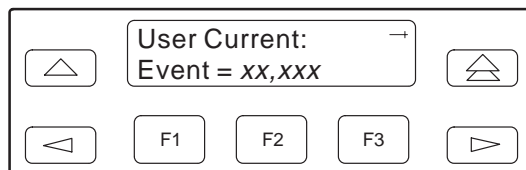

6. When you press F2 from the User Registers screen, the User registers for the 24-hour total interval appear.

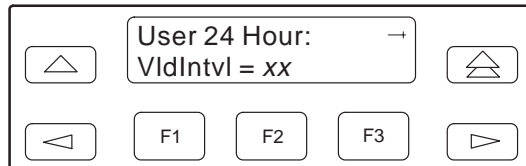

7. When you press F3 from the User Registers screen, the interval screen appears. Use this screen to choose the specific 15-minute interval.

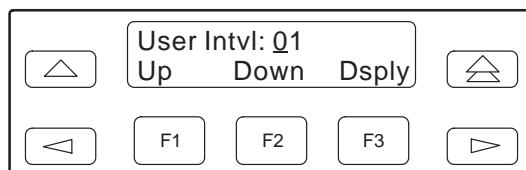

8. Use the < and > keys to position the cursor under the first or second digit in the interval number displayed, then use the F1 (Up) and F2 (Down) keys to increment and decrement the number.

9. When you have selected the number of the interval you want to display, press F3 (Dsply) to display the registers for the interval selected. Use the scroll keys to view additional register information.

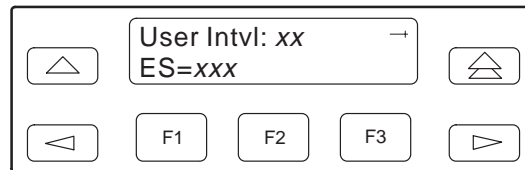

Table 4-3. Performance Registers (1 of 3)

| Register | Interval Description | Totals Description |
|-----------------|--|---|
| Event | ESF error events counter. An error event is an ESF frame with either a Cyclic Redundancy Check (CRC) error or an Out Of Frame (OOF) event. The maximum count is 65,535. This register is only reset as a result of a reset command from the network. This register is valid for the current interval only. | N/A |
| CurTimer | Current interval timer. This register records the number of seconds in the current 15-minute interval. The maximum is 900 seconds. This register is valid for the current interval only. | N/A |
| VldIntvl | N/A | Valid interval total. Records the number of valid 15-minute intervals in the previous x hours, where x is 24 hours for aggregate performance and 8 hours for port performance. This register is not valid for the current interval. |
| ES | The number of errored seconds for the current interval. An errored second is any second with one or more ESF error events. The maximum is 900 seconds. | The total number of errored seconds for the previous x hours, where x is 24 hours for aggregate performance and 8 hours for port performance. |
| UAS | The number of unavailable seconds for the current interval. An unavailable second is any one second interval when service is unavailable. (Detection occurs with 10 consecutive unavailable seconds.) The maximum is 900 seconds. | The total number of unavailable seconds for the previous x hours, where x is 24 hours for aggregate performance and 8 hours for port performance. |

Table 4-3. Performance Registers (2 of 3)

| Register | Interval Description | Totals Description |
|---|--|--|
| SES | The number of severely errored seconds for the current interval. A severely errored second is any second with 320 or more CRC errors, or any second with one or more OOF events. The maximum is 900 seconds. | The total number of severely errored seconds for the previous x hours, where x is 24 hours for aggregate performance and 8 hours for port performance. |
| BES | The number of bursty errored seconds for the current interval. A bursty errored second is any second with more than one, but less than 320, CRC errors. The maximum is 900 seconds. | The total number of bursty errored seconds for the previous x hours, where x is 24 hours for aggregate performance and 8 hours for port performance. |
| LOFC | The loss of frame count for the current interval. This is a count of the number of times that an LOF is declared. The maximum count is 255. | The total loss of frame count for the previous x hours, where x is 24 hours for aggregate performance and 8 hours for port performance. |
| CSS (Not valid for Port registers.) | The number of controlled slip seconds for the current interval. | The total number of controlled slip seconds for the previous x hours, where x is 24 hours for aggregate performance and 8 hours for port performance. |

Table 4-3. Performance Registers (3 of 3)

| Register | Interval Description | Totals Description |
|---|---|--------------------|
| StEvt (Only valid for User registers.) | The status events register records whether one or more of the following events have occurred at least once during the interval. The event is identified by a letter as follows: Y – A Yellow Alarm signal has been received on the network interface. L – Loss Of Signal has occurred on the DTE Drop/Insert (DSX-1) interface. E – The Excessive Error Rate threshold has been exceeded. F – A Frame Synchronization Bit Error has been detected. If none of these events occurred during the interval, StEvt=none will be displayed. | N/A |
| Complete (Only valid for far-end port registers.) | Bad line conditions or loopback tests may prevent far-end port statistics from reaching the DSU/CSU. This field indicates whether the 15-minute interval contains 900 seconds of statistics. If one or more seconds of far-end statistics are missing, this field will display Complete=No, otherwise it will display Complete=Yes. This field is only displayed when Far is selected from the Prt1 screen. | N/A |

Resetting Performance Registers

You can reset the performance registers via the ClrReg command in the Control branch of the front panel menu.

► Procedure

To clear the performance registers:

1. From the top-level menu screen, press the \triangleright key until the Ctrl selection appears on the screen.
2. Select Ctrl.
3. From the Control screen, press the \triangleright key until the ClrReg selection appears on the screen.
4. Select ClrReg.

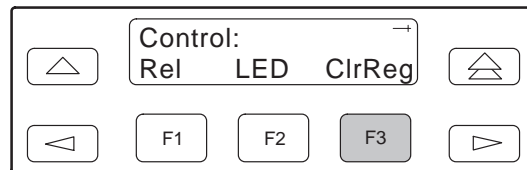

5. From the Clear Prf Regs screen, press F1 to clear the User registers.

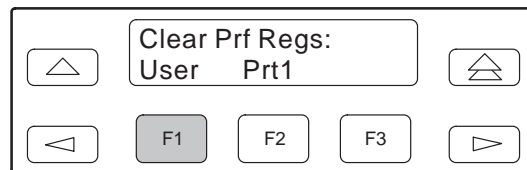

If you selected User, the User performance registers are cleared, all accumulators are reset to zero, and all status registers are cleared. The current interval timer, the number of valid intervals count, and the total 24-hour counts are reset to zero. The **Command Complete** message then appears.

Alarms

The DSU/CSU can be attached, either locally or remotely, to an ASCII terminal or printer to display or print alarm messages. Alarms can also be displayed on a PC that is using a terminal emulation package.

You can route these alarms to the COM port or dial them out using an external device.

Each alarm message contains a customer identification to indicate which remote DSU/CSU is reporting an alarm. For information about customer identification, refer to *Displaying Unit Identity* in Chapter 3, *SDCP Operation*.

Possible alarm messages are as follows:

- **Continuous Loss Of Signal detected at the Network Interface.**
- **Alarm Cleared. Loss Of Signal condition at the Network Interface.**
- **Continuous Out Of Frame condition detected at the Network Interface.**
- **Alarm Cleared. Out Of Frame condition at the Network Interface.**
- **Alarm Indication Signal received at the Network Interface.**
- **Alarm Cleared. Alarm Indication Signal at the Network Interface.**
- **An Excessive Error Rate has been detected at the Network Interface.**
- **Alarm Cleared. An Excessive Error Rate at the Network Interface.**
- **Yellow Alarm signal received at the Network Interface.**
- **Alarm Cleared. Yellow Alarm signal at the Network Interface.**
- **Continuous Out Of Frame condition detected at synchronous data port 1.**
- **Alarm Cleared. Out Of Frame condition at synchronous data port 1.**
- **An Excessive Error Rate has been detected at synchronous data port 1.**
- **Alarm Cleared. An Excessive Error Rate at synchronous data port 1.**

If two alarm conditions are detected at once, the higher priority alarm is reported. However, if an even higher priority alarm is detected before the first alarm is cleared, the later alarm is not reported. (The alarms listed above are in priority order with the highest priority listed first.)

Alarms remain active until the alarm condition is cleared. Also, an alarm clear message is only sent when there are no other alarms active.

For information about alarm configuration options, refer to *Alarm Configuration Options* in Appendix C, *Configuration Options*.

For troubleshooting information, refer to *Troubleshooting* on page 4-14.

SNMP Traps

SNMP traps are unsolicited messages that are sent from the DSU/CSU to an SNMP manager when the DSU/CSU detects certain pre-specified conditions. These traps enable the SNMP manager to monitor the state of the network.

The SNMP Trap configuration option must be enabled for trap messages to be sent over the communications link. You must specify the number of SNMP managers that are to receive traps from this DSU/CSU, an IP address for each SNMP manager specified, and the type of traps to be sent from this DSU/CSU. For more information, refer to Appendix C, *Configuration Options*, and *Configuring SNMP Traps* in Chapter 3, *SDCP Operation*.

Trap types consist of the following:

- **General traps** – Include warmStart and authenticationFailure. The DSU/CSU sends a warmStart trap after it has been reset to indicate that it has just reinitialized itself. The DSU/CSU sends an authenticationFailure trap when it has received an SNMP protocol message that has not been properly authenticated. These traps are set by the Gen Trap configuration option.
- **Enterprise Specific traps** – Signify that the DSU/CSU has recognized an enterprise-specific event. See [Table 4-4](#) for enterprise-specific traps. These traps are set by the Entp Trap configuration option.
- **Link Traps** – Identify the condition of the communications interface, either linkDown (one of the communications interfaces has failed) or linkUp (one of the communications interfaces has just come up). These traps are set by the Link Trap configuration option. The communications interfaces for which these traps can be generated are specified by the Trap I/F configuration option. [Table 4-5](#) defines traps for each interface.

Table 4-4. Enterprise-Specific Trap Definitions

| Trap Value | Event |
|---------------------------|---|
| enterpriseClockFail(1) | The currently configured master clock source has failed. |
| enterpriseSelfTestFail(2) | A DSU/CSU hardware failure is detected at self-test. This trap is generated after DSU/CSU initialization. |
| enterpriseDeviceFail(3) | An internal DSU/CSU failure is detected by the operating software. |
| enterpriseTestStart(5) | A test is initiated. |
| enterpriseConfigChange(6) | A configuration option is changed. |
| enterpriseTestClear(105) | A test is concluded. |

Table 4-5. SNMP Trap per Interface

| Interface | Trap Meaning |
|-----------------------|--|
| T1 Network | Up = No alarm or test conditions. Down = Alarm or test conditions. |
| Synchronous Data Port | Up = No test conditions, the port is assigned to a network interface, and both CTS and DSR are ON. Down = Test conditions, the port is unassigned, or either CTS or DSR is off. |

Troubleshooting

The DSU/CSU is designed to provide you with trouble-free service. However, [Table 4-6](#) gives you some direction if a problem occurs.

For problems other than those listed in the table, please contact your service representative.

Table 4-6. Troubleshooting (1 of 2)

| Symptom | Possible Cause | Solutions |
|--------------------------------------|--|--|
| No power | <ol style="list-style-type: none"> 1. The power module is not securely attached. 2. The wall receptacle has no power. | <ol style="list-style-type: none"> 1. Check the power module attachment. 2. Check the wall receptacle power by plugging in some equipment that is known to be working. |
| Power-Up Self-Test fails | The DSU/CSU has detected an internal hardware failure. | Contact your service representative. |
| Message LOS at NET appears | <ol style="list-style-type: none"> 1. Network cable problem. 2. No signal is being transmitted at the far-end. 3. Facility problem. | <ol style="list-style-type: none"> 1. Check that the network cable is securely attached at both ends. 2. Check the far-end status. 3. Contact your facility provider. |
| Message OOF at Net appears | <ol style="list-style-type: none"> 1. Incompatible framing format between the network and the DSU/CSU. 2. Network cabling problem. 3. Facility problem. | <ol style="list-style-type: none"> 1. Check that the framing format for the network interface is correct. 2. Check that the network cable is securely attached at both ends. 3. Contact your facility provider. |
| Message Yellow at Net appears | <ol style="list-style-type: none"> 1. Network cable problem. 2. Far-end device has lost framing sync on the line. 3. Facility problem. | <ol style="list-style-type: none"> 1. Check that your network cable is securely attached at both ends. 2. Check the status of the far-end device. 3. Contact your facility provider. |
| Message AIS at Net appears | <ol style="list-style-type: none"> 1. Upstream device is transmitting an AIS. 2. The network is transmitting an AIS. | <ol style="list-style-type: none"> 1. Check the status of the upstream device(s). 2. Contact your facility provider. |
| Message EER at Net appears | Facility problem. | Contact your facility provider. |

Table 4-6. Troubleshooting (2 of 2)

| Symptom | Possible Cause | Solutions |
|---|--|--|
| A failure message appears followed by an 8-digit code (x x x x x x x x) | Internal DSU/CSU problem. | Record the 8-digit code, then contact your service representative. |
| Mgmt link is down | <ol style="list-style-type: none"> 1. The manager configuration is mismatched with the DSU/CSU configuration. 2. The manager's link layer protocol is not running. | <ol style="list-style-type: none"> 1. Check that the configurations are matched. 2. Start the link layer protocol. |

Test Jacks

Two test jacks are located on the front panel: Net Mon (Network Monitor) In, and Net Mon Out.

Net Mon In nonintrusively monitors the signal going into the network.

Net Mon Out nonintrusively monitors the signal coming from the network.

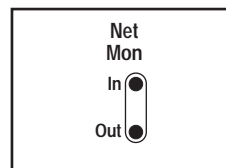

98-15942

Test Commands

The test commands enable you to run loopbacks and test patterns on the DSU/CSU, and to test the front panel LEDs. These tests can help you isolate areas of trouble if you are having problems with your DSU/CSU.

To access all Test commands from the Test branch, press F2 to select Test from the top-level menu screen.

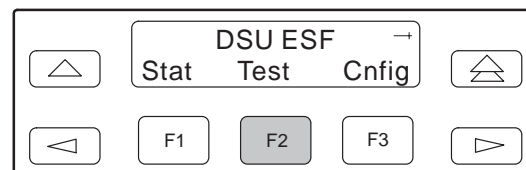

Remote Loopback Tests

The Remote Loopback tests enable you to troubleshoot your circuit by sending the following to a far-end device:

For Networks

- Line loopback up activation sequence for 10 seconds (LLBUP)
- Line loopback down activation sequence for 10 seconds (LLBDN)

For Channels

- V.54 activation sequence to initiate a V.54 Loop 2 (54UP)
- V.54 deactivation sequence to terminate a V.54 Loop (54DN)
- ANSI T1.403 (Annex B) activation sequence to initiate a DCLB on the remote device (FT1UP)
- ANSI T1.403 (Annex B) deactivation sequence to terminate a DCLB on the remote device (FT1DN)

You cannot perform remote loopbacks if any of the local loopbacks are active. If you attempt to do so, the error message **Invlid Test Combo** (Invalid Test Combination) appears.

Sending a Line Loopback Up or Down

► Procedure

To send a Line Loopback Up or Down sequence on the network to a far-end DSU/CSU:

1. From the top-level menu screen, select Test.
2. From the Test screen, select Rlpbk.

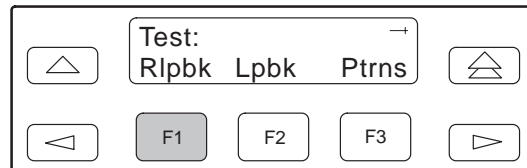

3. From the Rem Loopback screen, press F1 to select LLBUP (Line Loopback Up), or press F2 to select LLBDN (Line Loopback Down).

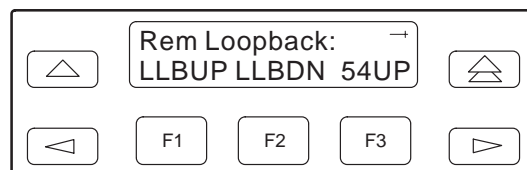

The Line Loopback sequence is sent up or downstream to the far-end DSU/CSU for 10 seconds. During this time, **Sending** appears on Line 2 of the LCD, followed by **Command Complete** when 10 seconds have elapsed.

You can press any function key to restore the Rem Loopback screen without affecting transmission of the loopback code.

Sending a V.54/ANSI FT1 Activation/Deactivation

► Procedure

To send a V.54 or ANSI FT1 Activation or Deactivation loopback sequence to the far-end DSU/CSU:

1. From the top-level menu screen, select Test.
2. From the Test screen, select Rlpbk.

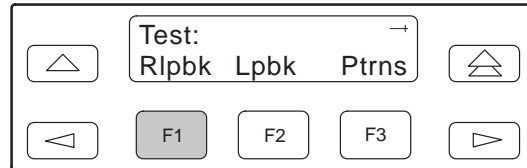

3. From the Rem Loopback screen, press the function key that corresponds to the specific loopback test you want to perform. Use the scroll keys, if necessary.

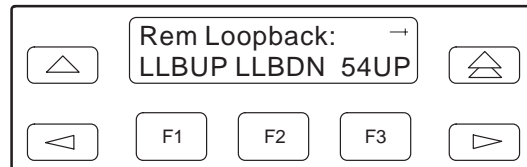

The 54UP, 54DN, FT1UP, and FT1DN commands send the requested sequence out the network interface on the DS0 channels allocated to Port 1.

4. From the Rem Loop screen, press the desired function key to select the specific port. Use the scroll keys, if necessary.

After you select a port, the sequence is sent to the far-end DSU/CSU. During this time, **Sending** appears on Line 2 of the LCD, followed by **Command Complete** when the sequence is complete.

During the **Sending** message, you can press the \triangle and \triangleleft keys without affecting transmission of the loopback sequence.

Local Loopback Tests

The Local Loopback tests enable you to conduct circuit testing and fault isolation for the digital line. The supported local loopback tests are:

- Line Loopback (LLB)
- Payload Loopback (PLB)
- Repeater Loopback (RLB)
- Data Channel Loopback (DCLB)
- Data Terminal Loopback (DTLB)

The Line Loopback command can be activated and deactivated in response to commands received over the network interface. The Network Interface configuration option NET LLB controls whether the DSU/CSU responds to the commands transmitted on the network interface to initiate LLBs (see Appendix C, *Configuration Options*).

The data port configuration option NET DCLB controls whether the DSU/CSU responds to inband V.54 commands to initiate DCLB for that port (see Appendix C, *Configuration Options*).

Local loopback tests can be aborted (Abort Command) at any time.

Local loopback tests cannot be run if send pattern or remote loopback tests are active. In most cases local loopbacks cannot run with each other. Table 4-7 shows valid combinations of local loopbacks.

Table 4-7. Valid Loopback Combinations

| | LLB | PLB | RLB | DCLB | DTLB |
|-------------|------------|------------|------------|-------------|-------------|
| LLB | NO | NO | YES | NO | YES |
| PLB | NO | NO | NO | NO | YES |
| RLB | YES | NO | NO | NO | YES |
| DCLB | NO | NO | NO | NO | NO |
| DTLB | YES | YES | YES | NO | NO |

Starting a Line Loopback

The Line Loopback command (LLB) loops the received signal on the network interface back to the network without change.

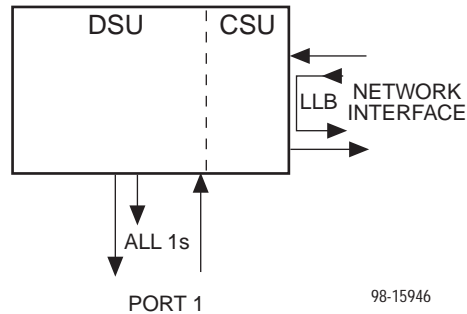

► Procedure

To perform a Line loopback:

1. From the top-level menu screen, select Test.
2. From the Test screen, select Lpbk.

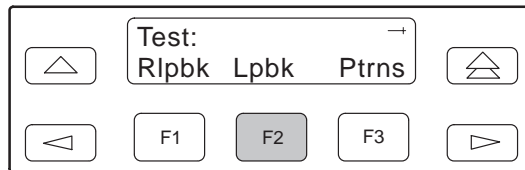

3. From the Loopback screen, select LLB.

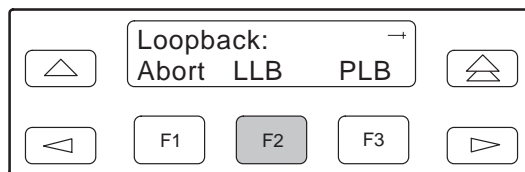

Test Started appears on Line 2. If a Line loopback is already in progress, the **Already Active** message appears. If an invalid combination of loopbacks is in progress, the error message **Invid Test Combo** appears (see [Table 4-7](#) for valid loopback test combinations).

Starting a Payload Loopback

The Payload Loopback command (PLB) loops the received signal on the network interface back to the network after it has passed through the framing circuitry of the DSU/CSU. Framing CRCs and BPVs are corrected.

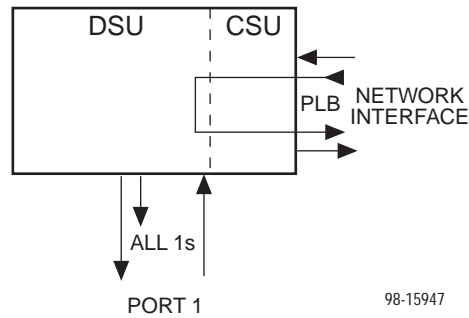

► Procedure

To perform a Payload loopback:

1. From the top-level menu screen, select Test.
2. From the Test screen, select Lpbk.

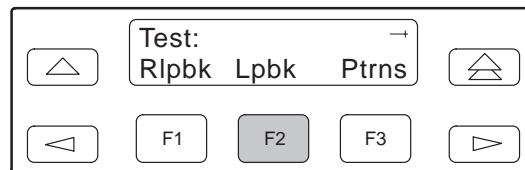

3. From the Loopback screen, select PLB.

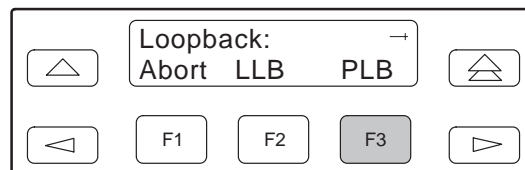

Test Started appears on Line 2. If a Payload loopback is already in progress, the **Already Active** message appears. If an invalid combination of loopbacks is in progress, the error message **Invalid Test Combo** appears (see [Table 4-7](#) for valid loopback test combinations).

Starting a Repeater Loopback

The Repeater Loopback command (RLB) loops the signal being sent to the network back to the data port. The signal is looped back as close to the network interface as possible (after it has passed through the framing circuitry of the DSU/CSU). Framing CRCs and BPVs are corrected.

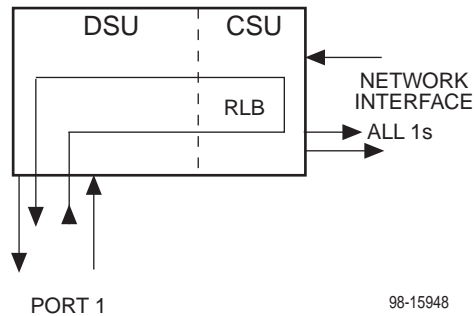

► Procedure

To perform a Repeater loopback:

1. From the top-level menu screen, select Test.
2. From the Test screen, select Lpbk.

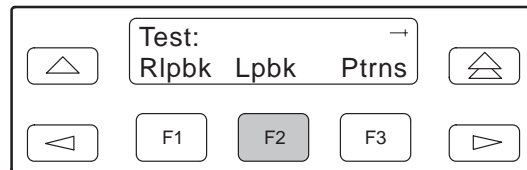

3. From the Loopback screen, press the \triangleright key until the RLB selection appears on the screen.
4. Select RLB.

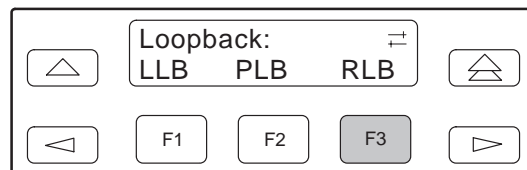

Test Started appears on Line 2. If a Repeater loopback is already in progress, the **Already Active** message appears. If an invalid combination of loopbacks is in progress, the error message **Invid Test Combo** appears (see [Table 4-7](#) for valid loopback test combinations).

Starting a Data Channel Loopback

The Data Channel Loopback command (DCLB) loops the data received from the network interface, for all DS0 channels allocated to Port 1, back to the network. The loopback occurs after the data passes through the port circuitry but before it is sent out the data port.

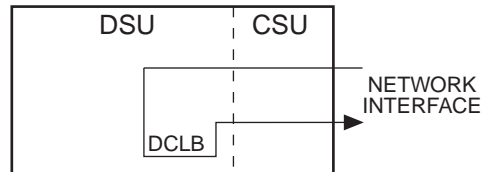

98-16103

► Procedure

To perform a Data Channel loopback:

1. From the top-level menu screen, select Test.
2. From the Test screen, select Lpbk.

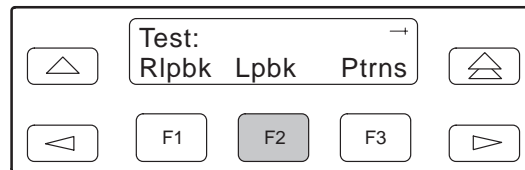

3. From the Loopback screen, press the ▷ key until the DCLB selection appears on the screen.
4. Select DCLB.

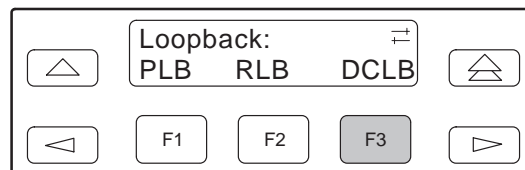

Test Started appears on Line 2. If a Data Channel loopback is already in progress, the **Already Active** message appears. If an invalid combination of loopbacks is in progress, the error message **Invlid Test Combo** appears (see [Table 4-7](#) for valid loopback test combinations).

Starting a Data Terminal Loopback

The Data Terminal Loopback command (DTLB) loops the data received from Port 1, for all DS0 channels allocated to the port, back out of the port. This loopback occurs after the data passes through the port circuitry but before it reaches the T1 framer.

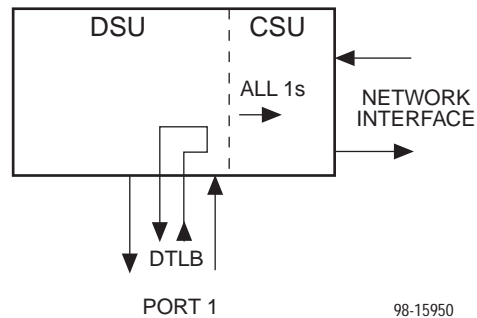

► Procedure

To perform a Data Terminal loopback:

1. From the top-level menu screen, select Test.
2. From the Test screen, select Lpbk.

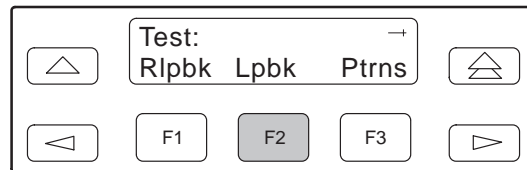

3. From the Loopback screen, press the \triangleright key until the DTLB selection appears on the screen.
4. Select DTLB.

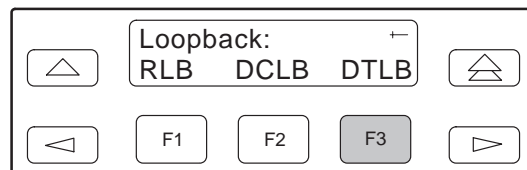

Test Started appears on Line 2. If a Data Terminal loopback is already in progress, the **Already Active** message appears. If an invalid combination of loopbacks is in progress, the error message **Invid Test Combo** appears (see [Table 4-7](#) for valid loopback test combinations).

Aborting Loopbacks

The Abort Loopback command stops all loopback tests or any selected loopback test currently active on the DSU/CSU.

► Procedure

To abort one or more loopback tests:

1. From the top-level menu screen, select Test.
2. From the Test screen, select Lpbk.

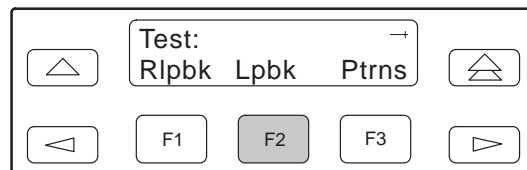

3. From the Loopback screen, select Abort.

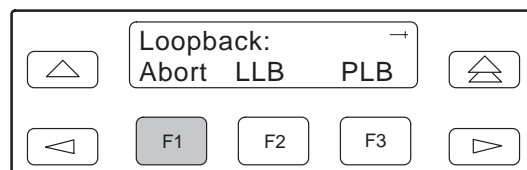

4. From the Loopback Abort screen, press the desired Function key to abort All or one specific loopback test. Use the scroll keys, if necessary.

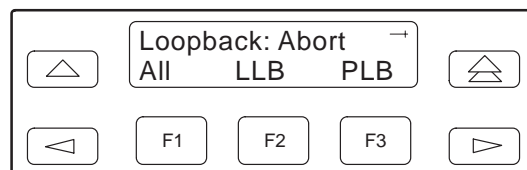

When abort is complete, the message **Command Complete** appears on the Abort screen.

NOTE:

If you mistakenly choose to abort a loopback test that is not currently running, a **Command Complete** message will still display and the loopback that is currently active will still be running. Use the TStat branch to view the test status to determine if the abort was successful.

Test Patterns

Use the Test Pattern commands to send, monitor, and abort test patterns. Available test patterns are:

- **QRSS** – A quasi-random signal source approximating live data that can be monitored for logic errors (on the network and the data ports).
- **1-in-8** – A test pattern consisting of a one (1) followed by seven zeros (on the network only).
- **511** – A pseudo-random bit sequence (PRBS) that is 511 bits long (on the data ports only). This is a PRBS 2^9-1 test.

Sending Test Patterns

Use the Send command to start transmission of a test pattern.

Only one test pattern can be active at a time.

► Procedure

To send a test pattern:

1. From the top-level menu screen, select Test.
2. From the Test screen, select Ptrns.

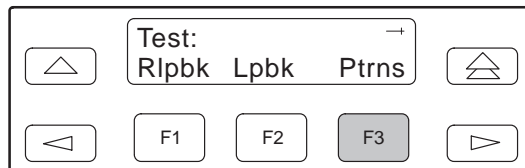

3. From the Patterns screen, select Send.

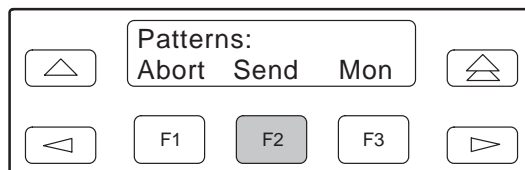

4. From the Patterns Send screen, press F1 to send a QRSS pattern, F2 to send a 1-in-8 pattern, F3 to send a 511 pattern.

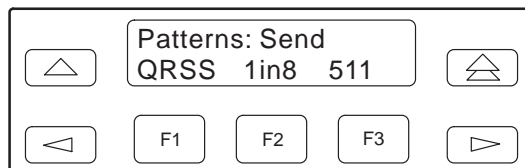

If you send a 1-in-8 pattern, skip Step 5.

5. From the Send screen, press the Function key that corresponds to the interface for which you want to send a test pattern. (NET does not appear for the 511 pattern.)

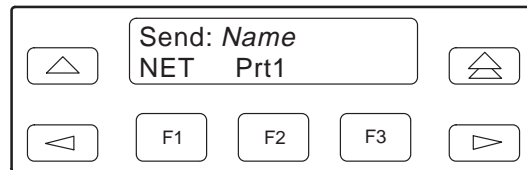

The Test Started screen appears.

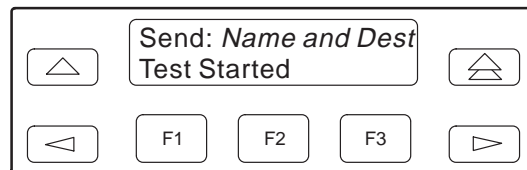

If the DSU/CSU is already sending the test pattern you selected, the message **Already active** appears. If you select a different pattern than one the DSU/CSU is already sending, the message **Invid Test Combo** appears.

Monitoring Test Patterns

Use the Monitor command to monitor a QRSS test pattern over all the channels on the network interface, or to monitor QRSS or 511 test patterns on the channels allocated to an individual port.

This command provides the number of errors detected in the test pattern (5 digits, maximum 99999).

► Procedure

To monitor a QRSS or 511 test pattern:

1. From the top-level menu screen, select Test.
2. From the Test screen, select Ptrns.

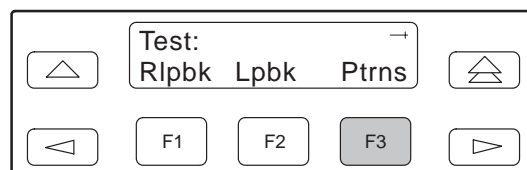

3. From the Patterns screen, select Mon.

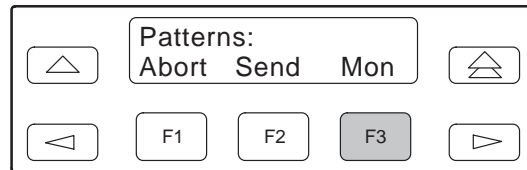

4. From the Patterns Mon screen, press F1 for QRSS or F2 for 511.

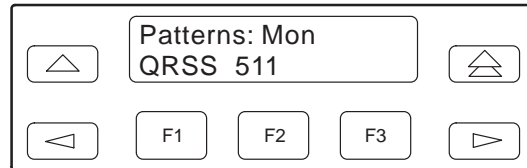

5. From the Monitor screen, press the Function key that corresponds to the interface for which you want to send a test pattern. (NET does not appear for the 511 pattern.)

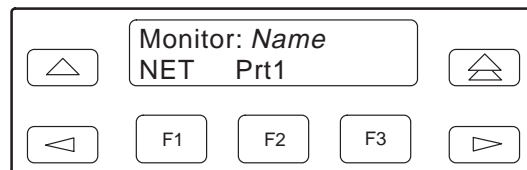

The Monitor screen appears with the error count. If the maximum of 99999 is exceeded, **OvrFlw** appears instead of the count. If the receiver loses synchronization while the monitor is active, **No Sync** appears.

Aborting Test Patterns

Use the Abort command to stop all test patterns or any selected test pattern active on the DSU/CSU.

► Procedure

To abort test patterns:

1. From the top-level menu screen, select Test.
2. From the Test screen, select Ptrns.

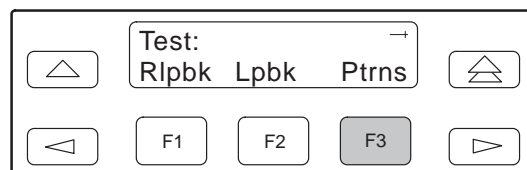

3. From the Patterns screen, select Abort.

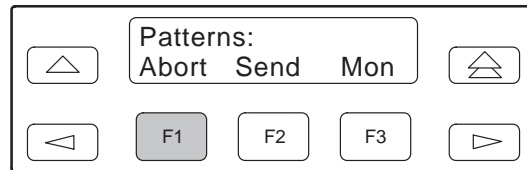

4. From the Patterns Abort screen, press the desired Function key to abort either All active test patterns, active Send test patterns, or the active Monitor (Mon) test pattern.

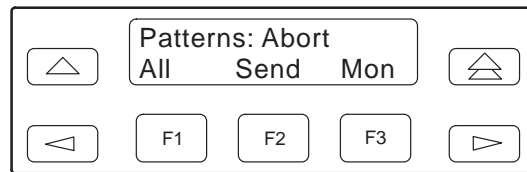

If you select All, the DSU/CSU terminates all active test patterns and displays the message **Command Complete**. Skip Step 5.

NOTE:

If you mistakenly choose to abort a test pattern that is not currently running, a **Command Complete** message still displays and the test pattern currently active still runs. Use the TStat branch to view the test status to determine if the abort was successful.

5. From the Abort screen, press the Function key that corresponds to the interface for which you want to abort a test pattern. Use the scroll keys, if necessary.

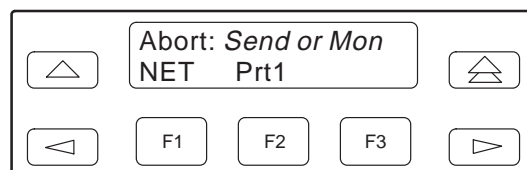

The DSU/CSU terminates the selected test pattern and displays the message **Command Complete**.

Lamp Test

Use the Lamp Test commands to start and stop a test of the DSU/CSU front panel LCD and LEDs.

Starting a Lamp Test

► Procedure

To start a Lamp test:

1. From the top-level menu screen, select Test.
2. From the Test screen, press the \triangleright key until the Lamp selection appears on the screen.
3. From the Test screen, select Lamp.

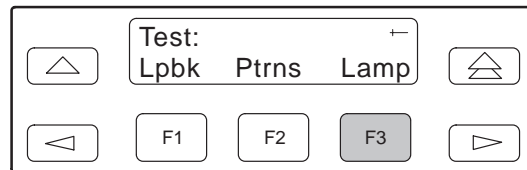

4. From the Lamp Test screen, select Start.

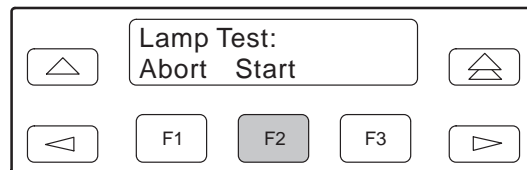

5. The following screens alternately appear on the LCD until you press a Function key to return to the Lamp Test screen. In addition, all LEDs blink.

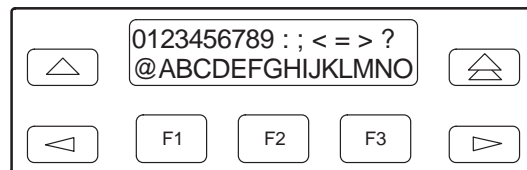
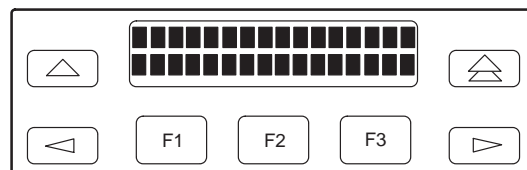

- When you are satisfied that all LEDs are lighting and the LCD is functioning properly, abort the Lamp test from the Lamp Test screen. If there is no activity on the DSU/CSU front panel for five minutes, the Device Health and Status screen appears automatically. However, the Lamp test remains active until it is aborted.

Aborting a Lamp Test

► Procedure

To abort the Lamp test:

- Display the Lamp Test screen. To do this when the LCD is alternating the Lamp test screens, press any Function key. Otherwise, follow Steps 1 through 3 of *Starting a Lamp Test* on page 4-30.

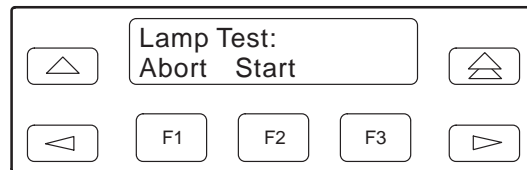

- From the Lamp Test screen, select Abort.

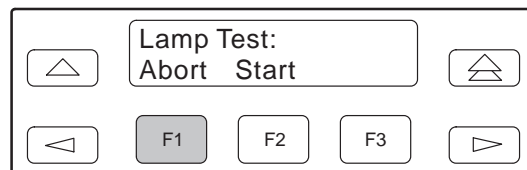

Displaying DSU/CSU Test Status

Use the Test Status command to display the active tests for the DSU/CSU. Status messages that can display on the front panel LCD are listed in [Table 4-8](#).

► Procedure

To display test status:

1. From the top-level menu screen, select Stat.
2. From the Status screen, press the \triangleright key until the TStat selection appears on the screen.
3. Select TStat.

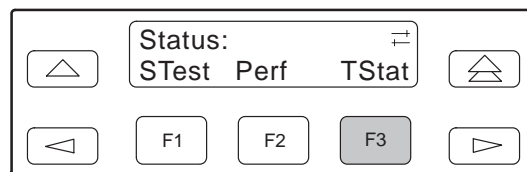

The Test Status screen appears showing you what tests are active for the DSU/CSU.

Table 4-8. Test Status Message

| Message | Description |
|------------------|---|
| No Test Active | No tests are currently active. |
| LLB Test Active | The network interface is in Line loopback. |
| PLB Test Active | The network interface is in Payload loopback. |
| RLB Test Active | Port 1 is in Repeater loopback. |
| DCLB on Port 1 | Port 1 is in a Data Channel loopback. |
| DTLB on Port 1 | Port 1 is in a Data Terminal loopback. |
| QRSS on Net | A QRSS test pattern is being sent on the network interface. |
| 1-8 Test Active | A 1-in-8 test pattern is being sent on the network interface. |
| QRSS on Port 1 | A QRSS test pattern is being sent to the network on the channels allocated to Port 1. |
| 511 on Port 1 | A 511 test pattern is being sent to the network on the channels allocated to Port 1. |
| Mon QRSS, Net | A QRSS test pattern is being monitored on the network interface. |
| Mon QRSS, Port 1 | A QRSS test pattern is being monitored on the channels allocated to Port 1. |
| Mon 511, Port 1 | A 511 test pattern is being monitored on the channels allocated to Port 1. |
| Lamp Test Active | The Lamp test is currently active. |

SDCP Menu

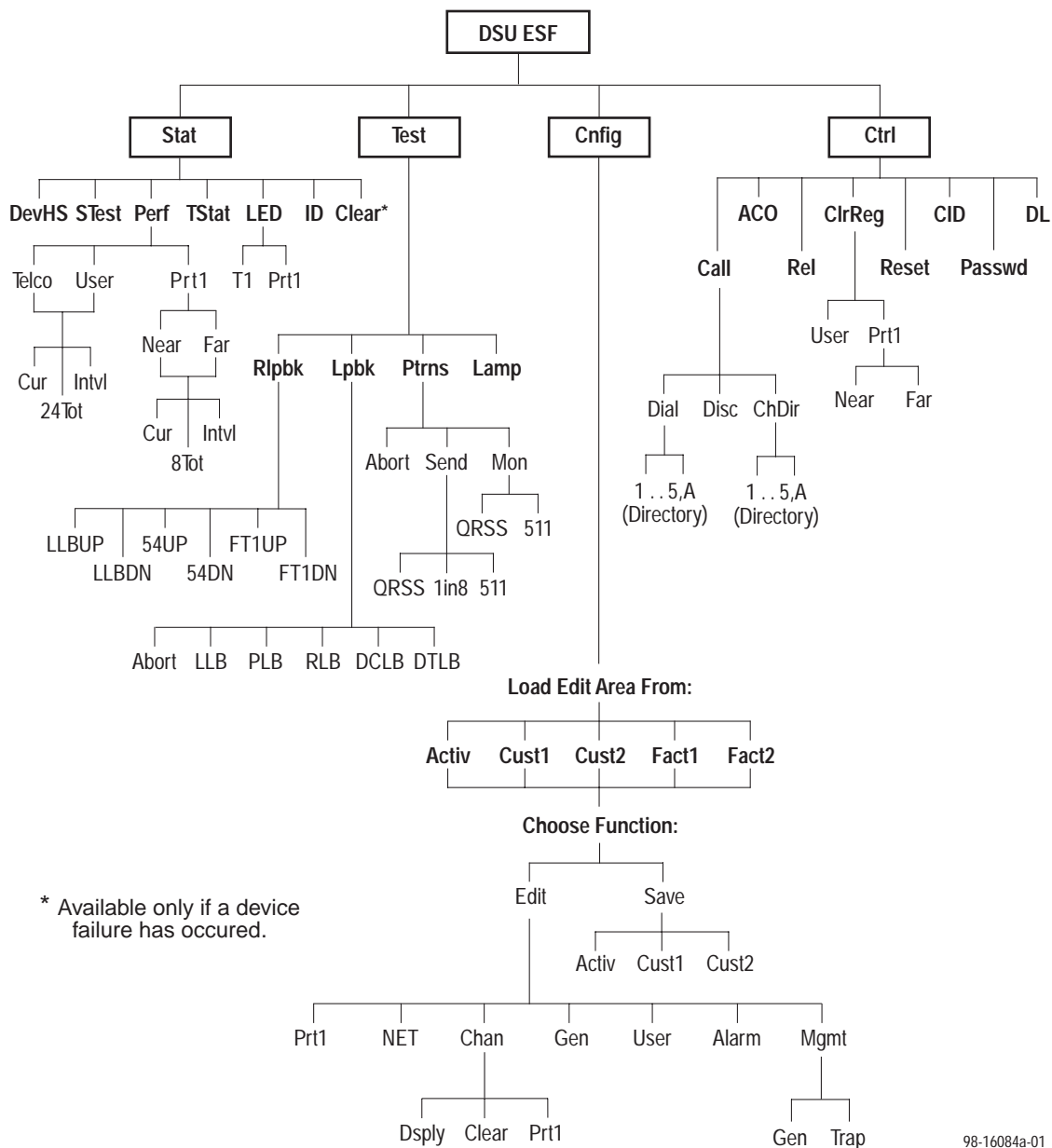

Technical Specifications

B

Overview

The technical specifications for the 3166 DSU/CSU are listed in Table B-1. The fan module cooling requirements for the 3000 Series Carrier are provided in the *COMSPHERE 3000 Series Carrier Installation Manual*.

Table B-1. ACCULINK Model 3166 DSU/CSU Technical Specifications (1 of 2)

| Specifications | Criteria |
|--|---|
| POWER REQUIREMENTS Sixteen 3166 DSU/CSUs with SDU, SDCP, and fan module: 115 Vac power supply -48 Vdc power supply | 90 to 132 Vac, 60 Hz \pm 3 (2.4 amp, 215 watts at 115 Vac) -60 to -40 Vdc (4.7 amps maximum) |
| POWER CONSUMPTION | 6.5 watts per circuit card |
| NETWORK T1 INTERFACE Physical Interface (USA) Physical Interface (Canada) Framing Format Coding Format Line Build-Out (LBO) ANSI PRM Bit Stuffing Yellow Alarm Generation | RJ48C CA81A (T1 with adapter cable) D4, ESF AMI, B8ZS 0.0 dB, -7.5 dB, -15 dB, -22.5 dB Selectable FCC Part 68, AT&T TR 62411 Selectable |
| LOOPBACKS Standard Additional | AT&T TR 54016, AT&T TR 62411, ANSI T1.403.1989 RLB (Repeater Loopback), V.54 Loop 2 and Loop 3, ANSI T1.403 Annex B Fractional T1 Loopback |

Table B-1. ACCULINK Model 3166 DSU/CSU Technical Specifications (2 of 2)

| Specifications | Criteria |
|--|---|
| PORT INTERFACE Standards Rates | EIA-530-A, V.35, RS-449, V.11 Nx64 – 64-1.536 Mb Nx56 – 56-1.344 Mb |
| CLOCKING SOURCES | T1 network interface, Port 1, internal clock, or external clock |
| APPROVALS | Refer to the product labeling |
| PHYSICAL DIMENSIONS Height Width Depth | 7.1 inches (18.0 cm) 1.0 inches (2.5 cm) 14.2 inches (36.1 cm) |
| WEIGHT Circuit Card Rear Connector Module | 13.8 oz (0.4 kg) 4.7 oz (0.1 kg) |
| ENVIRONMENT Operating Temperature Storage Temperature Relative Humidity Shock and Vibration | 32°F to 122°F (0°C to 50°C) –4°F to 158°F (–20°C to 70°C) 5%—95% (noncondensing) Withstands normal shipping and handling |

Configuration Options

C

Overview

The DSU/CSU configuration option tables contain a list of all configuration options and their available selections. The configuration options are arranged into functional groups:

- **Port Configuration Options**

The Port configuration options configure the synchronous data port on the DSU/CSU (Table C-1).

- **Network Interface Configuration Options**

The Network Interface configuration options configure the network interface on the DSU/CSU (Table C-2).

- **General Configuration Options**

The General configuration options configure alarms and clocks on the DSU/CSU (Table C-3).

- **User Interface Configuration Options**

The User Interface configuration options configure and control the DSU/CSU user interfaces (Table C-4).

- **Alarm Configuration Options**

The Alarm configuration options specify how alarm conditions are handled by the DSU/CSU (Table C-5).

- **Management Configuration Options**

The Management configuration options configure the DSU/CSU for SNMP or Telnet access (Tables C-6 and C-7).

The configuration tables include a description of each configuration function and its available selections. In the tables, **the top line of each configuration option entry indicates the factory default setting.**

Port Configuration Options

Table C-1. Port Configuration Options (1 of 5)

| Port Type: E530 (Factory 1) V.35 (Factory 2) | | | | | |
|---|--------------|-------------|--------------|-------------|-------------|
| Next | E530 | V.35 | RS449 | X.21 | Prev |
| <p>Data Port Type. Allows selection of the data port interface type.</p> <p>E530 – Configures the port as an EIA-530-A compatible interface. EIA-530-A DTEs can be directly connected to the Port1 connector.</p> <p>V.35 – Configures the port as a V.35 compatible interface. V.35 DTEs can be connected to the Port1 connector using an EIA-530-A-to-V.35 adapter cable.</p> <p>RS449 – Configures the port as an RS449 compatible interface. RS449 DTEs can be connected to the Port1 connector using an EIA-530-A-to-RS449 adapter cable.</p> <p>X.21 – Configures the port as an X.21 compatible interface. X.21 DTEs can be connected to the Port1 connector using an EIA-530-A-to-X.21 adapter cable.</p> <p>NOTE: If this configuration option is set to X.21, set the All Ones configuration option to RTS or Disab.</p> | | | | | |
| Base Rate: Nx64 | | | | | |
| Next | Nx64 | Nx56 | Prev | | |
| <p>Data Port Base Rate. Allows selection of the base rate for the data port. The data rate for the port is a multiple (from 1 to 24) of the base rate specified with this configuration option.</p> <p>Nx64 – Sets the base rate for this port to 64 kbps. The data rate is Nx64 kbps, where N is a number from 1 to 24.</p> <p>Nx56 – Sets the base rate for this port to 56 kbps. The data rate is Nx56 kbps, where N is a number from 1 to 24.</p> | | | | | |
| Net DCLB: Disab (Factory 1) Both (Factory 2) | | | | | |
| Next | Disab | V.54 | FT1 | Both | Prev |
| <p>Network Initiated DCLB. Allows the initiation and termination of a Data Channel Loopback (V.54 loop 2) by the receipt of a V.54 DCLB-actuate sequence or DCLB-release sequence from the network or far-end device. The sequences may be either V.54 or FT1 (ANSI) compliant sequences.</p> <p>Disab – Ignores the DCLB-actuate and DCLB-release sequences for this port.</p> <p>V.54 – Enables DCLB-actuate and DCLB-release sequences that comply with the V.54 standard for “Inter-DCE signaling for point to point circuits.”</p> <p>FT1 – Enables DCLB-actuate and DCLB-release sequences that comply with the ANSI T1.403, Annex B standard for “In-band signaling for fractional-T1 (FT1) channel loopbacks.”</p> <p>Both – Enables DCLB-actuate and DCLB-release sequences that comply with either the ANSI or V.54 standard. The type of actuate and release sequences do not have to match.</p> | | | | | |

Table C-1. Port Configuration Options (2 of 5)

| Port LB: Disab (Factory 1) Both (Factory 2) | | | | | |
|--|--------------|-------------|-------------|-------------|-------------|
| Next | Disab | DTLB | DCLB | Both | Prev |
| <p>Port (DTE) Initiated Loopbacks. Allows the initiation and termination of a local Data Terminal Loopback (DTLB) or remote Data Channel Loopback (DCLB) by the DTE connected to this port. (DTLB is equivalent to a V.54 loop 3, and DCLB is equivalent to a V.54 loop 2.) Control of these loopbacks is through the DTE interchange circuits as specified by the V.54 standard.</p> <p>Disab – Disables control of local DTLBs and remote DCLBs by the DTE connected to this port.</p> <p>DTLB – Gives control of the local DTLBs for this port to the DTE attached to this port. This loopback is controlled by the Local Loopback interchange circuit LL (CCITT 141).</p> <p>DCLB – Gives control of the remote DCLBs for the far-end port connected to this port to the DTE attached to this port. This loopback is controlled by the Remote Loopback interchange circuit RL (CCITT 140). The far-end equipment must support in-band V.54 loopbacks.</p> <p>Both – Gives control of local DTLBs and remote DCLBs to the DTE connected to this port.</p> | | | | | |
| All Ones: Both | | | | | |
| Next | Disab | DTR | RTS | Both | Prev |
| <p>Send All Ones on Data Port Not Ready. Specifies the conditions on the data port that determine when valid data is not being sent from the DTE. When this condition is detected, all ones are sent to the network on the DS0 channels allocated to the port.</p> <p>Disab – Disables the monitoring of interchange circuits from the DTE connected to this port.</p> <p>DTR – Monitors the DTE Ready interchange circuit CD (CCITT 108/1/2). When DTR is interrupted, all ones are sent to the network.</p> <p>RTS – Monitors the Request-to-Send interchange circuit CA (CCITT 105). When RTS is interrupted, all ones are sent to the network.</p> <p>Both – Monitors both DTR and RTS. If either is interrupted, all ones are sent to the network.</p> <p>NOTE: If the Port Type configuration option is set to X.21, set this configuration option to RTS or Disab.</p> | | | | | |
| Rcv Yellow: Halt | | | | | |
| Next | None | Halt | Prev | | |
| <p>Action on Network Yellow Alarm. Specifies the action taken on this port when a Yellow Alarm is received on the network interface.</p> <p>None – Makes the data port unaffected by Yellow Alarms received on the network interface.</p> <p>Halt – Stops the transmission of data on the port and disables the data port when Yellow Alarms are received on the network interface. When Yellow Alarms are received, all ones are sent on the Received Data interchange circuit BB (CCITT 104). The Clear-to-Send interchange circuit CB (CCITT 106) is interrupted.</p> | | | | | |

Table C-1. Port Configuration Options (3 of 5)

| Tx Clock: Int | | | | |
|---|-------------|--------------|-------------|--|
| Next | Int | Ext | Prev | |
| <p>Data Port Transmit Clock. Specifies whether the transmitted data for the port is clocked using an internal clock provided by the DSU/CSU (synchronized to the clock source specified by the clock source configuration option in the General configuration option group) or an external clock provided by the DTE connected to the port. When an external clock is used, it must be synchronized to the same clock source as the DSU/CSU.</p> <p>Int – Indicates the clock is provided internally by the DSU/CSU on the TXC interchange circuit DB (CCITT 114).</p> <p>Ext – Indicates the clock is provided externally by the DTE on the XTXC interchange circuit DA (CCITT 113). Use this selection when the clock source is set to this data port.</p> | | | | |
| InvertTxC: Disab | | | | |
| Next | Enab | Disab | Prev | |
| <p>Invert Transmit Clock. Specifies whether the clock supplied by the DSU/CSU on the TXC interchange circuit DB (CCITT 114) is phase inverted with respect to the Transmitted Data interchange circuit BA (CCITT 103). This configuration option is useful when long cable lengths between the DSU/CSU and the DTE are causing data errors.</p> <p>Enab – Indicates TXC supplied by the DSU/CSU on this port is phase inverted.</p> <p>Disab – Indicates TXC supplied by the DSU/CSU on this port is not phase inverted.</p> | | | | |
| InvertData: Disab | | | | |
| Next | Enab | Disab | Prev | |
| <p>Invert Transmitted and Received Data. Specifies whether the port's transmitted data and received data are logically inverted before being transmitted or received. This configuration option is useful for applications where HDLC data is being transported. Inverting the data ensures that the density requirements for the network interface are met.</p> <p>Enab – Indicates the transmitted data and received data for this port are inverted.</p> <p>Disab – Indicates the transmitted data and received data for this port are not inverted.</p> | | | | |
| EDL: Disab | | | | |
| Next | Enab | Disab | Prev | |
| <p>Embedded Data Link. Specifies whether Embedded Data Link (EDL) is enabled for Port1. If EDL is enabled, then 8 kbps of the total bandwidth allocated for this port is not available to the synchronous data port. For example, if the port rate is 256 kbps (4 DS0 channels allocated) and EDL is enabled, then only 248 kbps is available to the port. EDL provides the following: detection of frame synchronization, CRC of the data stream (excluding the 8 kbps EDL), and an in-band data link (4 kbps) between the local and remote units. The 4 kbps in-band data link can be used for performance report messages and as an IP link for SNMP or Telnet sessions.</p> <p>Enab – Indicates the port's EDL is enabled.</p> <p>Disab – Indicates the port's EDL is disabled.</p> <p>NOTES: – If the local DSU/CSU's EDL is enabled, then the remote DSU/CSU's EDL must also be enabled.</p> <p>– EDL is not recommended for networks in which data is examined for routing purposes (e.g., frame relay, X.25).</p> | | | | |

Table C-1. Port Configuration Options (4 of 5)

| Err Rate: 10E-4 | | | | | | | |
|---|--------------|--------------|--------------|--------------|--------------|--------------|-------------|
| Next | 10E-4 | 10E-5 | 10E-6 | 10E-7 | 10E-8 | 10E-9 | Prev |
| <p>Port Excessive Error Rate Threshold. Sets the error rate threshold that determines when an Excessive Error Rate (EER) condition is declared for a particular port. The error rate selected by this configuration option is determined by the ratio of the number of CRC5 errors to the total number of bits received over a set period of time.</p> <p>10E-4 – 10E-4 Threshold. For example, at 1536 kbps, EER is declared if more than 1,535 CRC5 errors are detected in a 10-second period. It is cleared with less than 1,536 errors in 10 seconds.</p> <p>10E-5 – 10E-5 Threshold. For example, at 1536 kbps, EER is declared if more than 921 CRC5 errors are detected in a 60-second period. It is cleared with less than 922 errors in 60 seconds.</p> <p>10E-6 – 10E-6 Threshold. For example, at 1536 kbps, EER is declared if more than 92 CRC5 errors are detected in a 60-second period. It is cleared with less than 93 errors in 60 seconds.</p> <p>10E-7 – 10E-7 Threshold. For example, at 1536 kbps, EER is declared if more than 9 CRC5 errors are detected in a 60-second period. It is cleared with less than 10 errors in 60 seconds.</p> <p>10E-8 – 10E-8 Threshold. For example, at 1536 kbps, EER is declared if more than 41 CRC5 errors are detected in three 15-minute intervals. It is cleared with less than 42 errors in three 15-minute intervals.</p> <p>10E-9 – 10E-9 Threshold. For example, at 1536 kbps, EER is declared if more than 4 CRC5 errors are detected in three 15-minute intervals. It is cleared with less than 5 errors in three 15-minute intervals.</p> <p>NOTE: This configuration option is not available if EDL is disabled.</p> | | | | | | | |
| Near-end: Disab | | | | | | | |
| Next | Disab | Maint | Send | Both | Prev | | |
| <p>Near-End Performance Statistics. Specifies whether the DSU/CSU maintains near-end performance statistics and sends performance report messages (PRMs) for Port1.</p> <p>Disab – Disables near-end performance statistics and does not send PRMs.</p> <p>Maint – Maintains near-end performance statistics for this port.</p> <p>Send – Sends PRMs over the port's EDL every second. Each PRM contains the performance statistics for the previous 4 seconds.</p> <p>Both – Maintains near-end performance statistics and sends PRMs over the port's EDL.</p> <p>NOTES: – This configuration option is not available if EDL is disabled.</p> <p>– If the local DSU/CSU is configured to send near-end performance statistics, then the remote device must be configured to maintain far-end performance statistics.</p> | | | | | | | |

Table C-1. Port Configuration Options (5 of 5)

| Far-end: Disab | | | |
|--|--------------|--------------|-------------|
| Next | Disab | Maint | Prev |
| <p>Far-End Performance Statistics. Specifies whether to monitor for far-end performance report messages (PRMs) and maintain far-end performance registers for a particular port.</p> <p>Disab – Disables far-end performance statistics.</p> <p>Maint – Monitors the port's EDL for PRMs and maintains far-end performance statistics.</p> <p>NOTES: – This configuration option is not available if EDL is disabled.</p> <p>– If the local DSU/CSU is configured to maintain far-end performance statistics, then the remote device must be configured to send near-end performance statistics.</p> | | | |
| Mgmt Link: Disab | | | |
| Next | Enab | Disab | Prev |
| <p>EDL Management Link. Specifies whether the EDL management link is enabled for a particular port. Selecting Enab allows SNMP or Telnet traffic to flow over the 4 kbps in-band data link provided by EDL.</p> <p>Enab – Enables the port's EDL management link.</p> <p>Disab – Disables the port's EDL management link.</p> <p>NOTES: – This configuration option is not available if EDL is disabled.</p> <p>– If the local DSU/CSU's EDL is enabled, then the remote device's EDL must also be enabled.</p> | | | |

Network Interface Configuration Options

Table C-2. Network Interface Configuration Options (1 of 3)

| | | | | | |
|---|--|--|--|--|--|
| NET Framing: ESF (Factory 1) D4 (Factory 2) Next D4 ESF Prev | | | | | |
| <p>Network Line Framing Format. The framing format to be used on the network interface.</p> <p>D4 – Configures for the D4 framing format.</p> <p>ESF – Configures for the Extended Superframe format.</p> | | | | | |
| NET Coding: B8ZS (Factory 1) AMI (Factory 2) Next AMI B8ZS Prev | | | | | |
| <p>Network Line Coding Format. The line coding format to be used on the network interface.</p> <p>AMI – Configures for the Alternate Mark Inversion coding format.</p> <p>B8ZS – Configures for the Bipolar 8 Zero Suppression coding format.</p> | | | | | |
| LBO: 0.0 Next 0.0 -7.5 -15 -22.5 Prev | | | | | |
| <p>Line Build Out. The line build out (LBO) for the signal transmitted to the network (0.0 dB is the factory default).</p> | | | | | |
| ANSI PRM: Disab Next Enab Disab Prev | | | | | |
| <p>Generate ANSI Performance Report Messages. Specifies whether ANSI T1.403 compliant performance report messages (PRMs) are generated.</p> <p>Enab – Generates and sends ANSI PRMs over the Facility Data Link (FDL) every second.</p> <p>Disab – Prevents the DSU/CSU from generating ANSI PRMs.</p> <p>NOTE: This configuration option is only available if the framing format is set to ESF.</p> | | | | | |
| Mgmt Link: Disab Next Enab Disab Prev | | | | | |
| <p>FDL Management Link. Specifies whether Facility Data Link (FDL) is enabled. Selecting Enab allows SNMP or Telnet traffic to flow over the 4 kbps data link provided by FDL. Running SNMP or Telnet over FDL requires an end-to-end FDL connection and cannot be terminated within the network.</p> <p>Enab – Enables the FDL management link for SNMP or Telnet.</p> <p>Disab – Disables the FDL management link.</p> <p>NOTES: – This configuration option is only available if the framing format is set to ESF.</p> <p>– This configuration option is not available if EDL is enabled.</p> <p>– If the local DSU/CSU's FDL is enabled, the remote DSU/CSU's FDL must also be enabled.</p> | | | | | |

Table C-2. Network Interface Configuration Options (2 of 3)

| | | | | |
|---|--------------|---------------|--------------|-------------|
| NET LLB: Enab | | | | |
| Next | Enab | Disab | Prev | |
| <p>Network Initiated Line Loopback (LLB). Allows initiation and termination of the LLB to be controlled by the receipt of LLB-Actuate and LLB-Release commands from the network (or remote DSU/CSU).</p> <p>Enab – Causes the DSU/CSU to enter an LLB (if the DSU/CSU can perform an LLB in its current state) and to cause an LLB-Release command to terminate the LLB.</p> <p>Disab – Causes the DSU/CSU to ignore LLB-Actuate and LLB-Release commands (the DSU/CSU is not in compliance with ANSI T1.403 and AT&T TR 62411).</p> <p>NOTES: – When this configuration option is enabled, the DSU/CSU recognizes the in-band LLB-Actuate and LLB-Release codes specified by AT&T as well as the bit-oriented FDL messages specified by ANSI (for ESF only).</p> | | | | |
| NET PLB: Enab | | | | |
| Next | Enab | Disab | Prev | |
| <p>Network Initiated Payload Loopback (PLB). Allows initiation and termination of the PLB to be controlled by the receipt of PLB-Actuate and PLB-Release commands from the network (or remote DSU/CSU).</p> <p>Enab – Causes the DSU/CSU to enter a PLB (if the DSU/CSU can perform a PLB in its current state) and to cause a PLB-Release command to terminate the PLB.</p> <p>Disab – Causes the DSU/CSU to ignore PLB-Actuate and PLB-Release commands (the DSU/CSU is not in compliance with ANSI T1.403 and AT&T TR 54016).</p> <p>NOTES: – When this configuration option is enabled, the DSU/CSU recognizes the in-band PLB-Actuate and PLB-Release codes specified by AT&T as well as the bit-oriented FDL messages specified by ANSI.</p> <p>– This configuration option is only available when the network interface framing is set to ESF.</p> | | | | |
| Bit Stuff: 62411 | | | | |
| Next | 62411 | Part68 | Disab | Prev |
| <p>Bit Stuffing. Determines when bit stuffing is performed to meet the ones density requirements for data transmission on the network. You must choose the maximum number of consecutive zeros the DSU/CSU can receive before it inserts a one.</p> <p>62411 – Specifies that a one be inserted in the data stream after 15 consecutive zeros or when the density of ones falls below 12.5% (complies with AT&T TR 62411).</p> <p>Part68 – Specifies that a one be inserted in the data stream after 80 consecutive zeros (complies with FCC Part 68).</p> <p>Disab – Disables bit stuffing so that ones density is not enforced.</p> <p>NOTES: – To comply with Canadian DOC CS-03 regulations, equipment installed in Canada must be configured to select 62411.</p> <p>– To comply with USA Part 68 regulations, equipment installed in the USA must be configured to select Part 68.</p> <p>– This configuration option is only available if the network interface line coding format is set to AMI.</p> | | | | |

Table C-2. Network Interface Configuration Options (3 of 3)

| Circuit Ident: | | | |
|---|-------------|--------------|-------------|
| Next | Edit | Clear | Prev |
| <p>Network Circuit Identifier. Specifies the transmission vendor's circuit identifier for the purpose of facilitating troubleshooting. The network circuit identifier is an ASCII text string that may be up to 255 characters in length.</p> <p>Edit – Allows you to edit and/or display the network circuit identifier using the generic text string entry screen.</p> <p>Clear – Allows you to clear the network circuit identifier. The network circuit identifier is set to a null string.</p> | | | |

General Configuration Options

Table C-3. General Configuration Options (1 of 2)

| Clock Src: NET | | | | |
|--|-------------|--------------|-------------|-------------|
| Next | NET | Prt1 | Int | Prev |
| <p>DSU/CSU Clock Source. Specifies the master clock source for the DSU/CSU. This selection synchronizes all internal timing and external interface clocks. The clock rate(s) for the external timing interfaces are independent of the input rate for the master clock. Failure of the clock specified by the Clock Source selection results in automatic fallback to internal clock.</p> <p>NET – Configures the network interface as the master clock source.</p> <p>Prt1 – Configures the data port as the master clock source. If you enable EDL if for the data port and the DSU/CSU Clock Source is set to Prt1, the external device must provide clocking of 8 kbps less than the expected data port rate. For example, if you select 64 kbps, the external clock must supply a 56 kbps clock signal.</p> <p>Int – Configures the internal clock as the master clock source.</p> | | | | |
| TstTimeout: Enab | | | | |
| Next | Enab | Disab | Prev | |
| <p>Test Timeout. Specifies whether user-initiated loopback and pattern tests have durations that are specified by the Tst Duration configuration option.</p> <p>Enab – Loopback and pattern tests initiated on the DSU/CSU have specified durations.</p> <p>Disab – Disables test timeout. The tests are terminated manually.</p> <p>NOTE: For DSU/CSUs that are remotely managed through an inband data stream such as EDL or FDL, the recommended setting is Enab. If tests are inadvertently left in the active state, the Enab setting will allow the test to timeout (terminate) after a specified time.</p> | | | | |

Table C-3. General Configuration Options (2 of 2)

| TstDuration: 10 |
|--|
| Next Up Down Save Prev |
| <p>Test Duration. Specifies the duration (1 to 120 minutes) of user-initiated loopback and pattern tests. (The Tst Timeout configuration option must be set to Enab.) Use the left or right arrow key to position the cursor on the digit you want to change. Use the Function keys (Up or Down) to increment or decrement the digit.</p> <p>Up – Increments the test duration.</p> <p>Down – Decrements the test duration.</p> <p>Save – Stores the test duration.</p> |

User Interface Configuration Options

Table C-4. User Interface Configuration Options (1 of 6)

| |
|---|
| <p>Self-Test: Enab</p> <p>Next Enab Disab Prev</p> <p>Initial Self-Test. Specifies whether the DSU/CSU performs a device self-test at power-up and after a device reset.</p> <p>Enab – Enables a self-test.</p> <p>Disab – Disables the self-test.</p> |
| <p>Dial-In: Enab</p> <p>Next Enab Disab Prev</p> <p>Dial-in Access. Allows dial-in access to the DSU/CSU. For standalone DSU/CSUs, dial-in access is through the modem port. For carrier-mounted DSU/CSUs, dial-in access is through an external device that is connected to the communication port.</p> <p>Enab – Allows dial-in access to the DSU/CSU.</p> <p>Disab – Prevents dial-in access. Incoming calls to the DSU/CSU are not answered.</p> <p>NOTE: To enable Dial-In for carrier-mounted DSU/CSUs, the external device must be configured for automatic answer and the ComExtDev configuration option must be enabled.</p> |
| <p>Password: None</p> <p>Next None Com Prev</p> <p>Password Mode. Activates a password prompt that prevents access until a password is entered.</p> <p>None – Does not require a password.</p> <p>Com – Prompts the communications port user to enter a password.</p> |
| <p>Com Port: Disab</p> <p>Next Enab Disab Prev</p> <p>Communication Port. Enables the use of the communication port.</p> <p>Enab – This communication port is enabled.</p> <p>Disab – The communication port is disabled.</p> |

Table C-4. User Interface Configuration Options (2 of 6)

| Com Use: ASCII | | | | |
|---|--------------|--------------|--------------|-------------|
| Next | Mgmt | ASCII | Term | Prev |
| <p>Communication Port Use. Specifies how the communication port is used.</p> <p>Mgmt – Configures the communication port as the link to an SNMP or Telnet system.</p> <p>ASCII – Configures the communication port as a proprietary ASCII port supporting Front Panel Emulation software and ASCII alarm messages. Only one ASCII communication port is allowed per 3000 Series carrier.</p> <p>Term – Configures the communication port as the interface to an asynchronous terminal.</p> <p>NOTE: For shared access from other 316x devices using Front Panel Emulation or the asynchronous terminal interface, Com Use must be set to Mgmt.</p> | | | | |
| ComExtDev: Disab | | | | |
| Next | Disab | AT | Other | Prev |
| <p>Carrier Communication Port's External Device Commands. Specifies the communication port's external device commands. When this configuration option is disabled, no commands are sent out the communication port. Select AT to have standard attention (AT) commands sent out the communication port to control the external device. Select Other to configure the connect prefix, the connect indication string, the escape sequence, the escape sequence delay, and the disconnect string.</p> <p>Disab – Allows no commands to be sent out the communication port.</p> <p>AT – Allows standard AT commands to be sent out the communication port.</p> <p>Other – Allows user configurable commands to be sent out the communication port.</p> <p>NOTES: – This configuration option is not available if the communications port is disabled.</p> <p>– Carrier Detect (CD) is used to detect that the external device's connection is lost. Therefore, do not allow the CD lead to be forced on by the external device.</p> <p>– The external device should be strapped to ignore Data Terminal Ready (DTR).</p> | | | | |
| ComConnPrefix: | | | | |
| Next | Edit | Clear | Prev | |
| <p>Carrier Communication Port Connect Prefix. Specifies the connect prefix to the dial directory phone number. When you make a connection or the DSU/CSU automatically makes a connection (dial-out alarms or traps) through the communication port, the connect prefix and the dial directory phone number are used to establish the connection. The connect prefix is an ASCII text string and may be up to 20 characters in length. If the connect prefix is NULL, then no connect prefix is used.</p> <p>Edit – Allows you to edit and/or display the connect prefix using the generic text string entry screen.</p> <p>Clear – Allows you to clear the connect prefix. The connect prefix is set to a null string.</p> <p>NOTES: – This configuration option is not available if the ComExtDev configuration option is set to AT or the communication port is disabled.</p> <p>– If ComExtDev is configured for Other and the external device requires characters after the dial phone number, you must append the characters to the phone number.</p> | | | | |

Table C-4. User Interface Configuration Options (3 of 6)

| | | | | | | | |
|---|--|--|--|--|--|--|--|
| <p>ComConnected: Next Edit Clear Prev</p> | | | | | | | |
| <p>Carrier Communication Port Connect Indication String. Specifies the communication port's connect indication string. When you make a connection or the DSU/CSU automatically makes a connection (dial-out alarms or traps) through the communication port, this string determines that the connection has been established. The connect indication string is an ASCII text string and may be up to 20 characters in length. If the connect indication string is not received within 1 minute, it will time-out the connection. If the connect indication string is NULL, the communication port's receive data stream is not searched and a transition in the Carrier Detect (CD) lead is used to determine that a connection has been established.</p> <p>Edit – Allows you to edit and/or display the case-sensitive connect indication string using the generic text string entry screen.</p> <p>Clear – Allows you to clear the connect indication string. The connect indication string is set to a null string.</p> <p>NOTE: This configuration option is not available if the ComExtDev configuration option is set to AT or the communication port is disabled.</p> | | | | | | | |
| <p>ComEscapeSeq: Next Edit Clear Prev</p> | | | | | | | |
| <p>Carrier Communication Port Escape Sequence. Specifies the communication port's escape sequence. Once the external device connection has been established, either you or the DSU/CSU can command the external device to disconnect. Before doing so, you may need to send the escape sequence out to switch the external device into command mode. The escape sequence is an ASCII text string and may be up to 20 characters in length. If the escape sequence is NULL, no escape sequence is sent out.</p> <p>Edit – Allows you to edit and/or display the escape sequence using the generic text string entry screen.</p> <p>Clear – Allows you to clear the escape sequence. The escape sequence is set to a null string.</p> <p>NOTE: This configuration option is not available if the ComExtDev configuration option is set to AT or the communication port is disabled.</p> | | | | | | | |
| <p>ComEscDel: None Next None 0.2s 0.4s 0.6s 0.8s 1.0s Prev</p> | | | | | | | |
| <p>Carrier Communication Port Escape Sequence Delay. Specifies the delay used while sending the communication port escape sequence. Use the communication port escape delay to specify the delay before sending the first character of the escape sequence and the delay after the last character of the escape sequence. During the delay, no data is sent out the communication port.</p> <p>None – No communication port escape sequence delay.</p> <p>X.Xs – The delay used during the communication port escape sequence (where X.X is 0.2, 0.4, 0.6, 0.8, or 1.0 seconds).</p> <p>NOTES: – ComEscDel must be configured for a delay greater than or equal to the escape guard time required by the external device.</p> <p>– This configuration option is not available if the ComExtDev configuration option is set to AT or the communication port is disabled.</p> | | | | | | | |

Table C-4. User Interface Configuration Options (4 of 6)

| | | | | | | | |
|---|-------------|--------------|-------------|-------------|-------------|-------------|-------------|
| ComDisconnect: | | | | | | | |
| Next | Edit | Clear | Prev | | | | |
| Carrier Communication Port Disconnect String. Specifies the communication port's disconnect string. The communication port's disconnect string is sent to the external device if either you or the DSU/CSU wants to command the external device to disconnect. The external device must be in command mode before this command can be sent, so the escape sequence will always be sent before the disconnect string. The disconnect string is an ASCII text string and may be up to 20 characters in length. If the disconnect string is NULL, then no disconnect string is sent out. | | | | | | | |
| Edit – Allows you to edit and/or display the disconnect string using the generic text string entry screen. | | | | | | | |
| Clear – Allows you to clear the disconnect string. The disconnect string is set to a null string. | | | | | | | |
| NOTE: This configuration option is not available if the ComExtDev configuration option is set to AT or the communication port is disabled. | | | | | | | |
| Com Rate: 9.6 | | | | | | | |
| Next | 1.2 | 2.4 | 4.8 | 9.6 | 14.4 | 19.2 | Prev |
| Communication Port Rate. Configures the bit rate for the communication port. | | | | | | | |
| 1.2 – Sets the bit rate to 1200 bps. | | | | | | | |
| 2.4 – Sets the bit rate to 2400 bps. | | | | | | | |
| 4.8 – Sets the bit rate to 4800 bps. | | | | | | | |
| 9.6 – Sets the bit rate to 9600 bps. | | | | | | | |
| 14.4 – Sets the bit rate to 14,400 bps. | | | | | | | |
| 19.2 – Sets the bit rate to 19,200 bps. | | | | | | | |
| Char Length: 8 | | | | | | | |
| Next | 7 | 8 | Prev | | | | |
| Communication Port Character Length. Configures the character length (7 or 8 bits) for the communication port. | | | | | | | |
| NOTES: – This configuration option must be set to 8 if the communication port is used as the network communication link. | | | | | | | |
| CParity: None | | | | | | | |
| Next | None | Even | Odd | Prev | | | |
| Communication Port Parity. Configures the parity (none, even, or odd) for the communication port. | | | | | | | |
| NOTE: This configuration option is not available if the communication port is configured for synchronous operation. | | | | | | | |
| CStop Bits: 1 | | | | | | | |
| Next | 1 | 1.5 | 2 | Prev | | | |
| Communication Port Stop Bits. Configures the number of stop bits (1, 1.5, or 2) for the communication port. | | | | | | | |
| NOTE: This configuration option is not available if the communication port is configured for synchronous operation. | | | | | | | |

Table C-4. User Interface Configuration Options (5 of 6)

| |
|---|
| <p>Ignore DTR: No Next Yes No Prev</p> <p>Communication Port Ignore DTR State. Specifies whether the DSU/CSU ignores the state of the Data Terminal Ready (DTR) input to the communication port.</p> <p>Yes – DTR is ignored.</p> <p>No – DTR is not ignored.</p> |
| <p>CmInActTm: Disab Next Enab Disab Prev</p> <p>Communication Port Inactivity Timeout. Specifies whether the communication port disconnects after a period of inactivity specified by the CmDiscTm configuration option.</p> <p>Enab – The communication port disconnects after the period of inactivity specified by the CmDiscTm configuration option.</p> <p>Disab – The communication port does not disconnect due to inactivity.</p> |
| <p>CmDiscTm: 5 Next Up Down Save Prev</p> <p>Communication Port Disconnect Time. Specifies the period of time (1 to 60 minutes) before the communication port disconnects due to inactivity. (The CmInActTm configuration option must be set to Enab.) Use the left or right arrow key to position the cursor on the digit you want to change. Use the Function keys (Up or Down) to increment or decrement the digit.</p> <p>Up – Increments the time delay.</p> <p>Down – Decrements the time delay.</p> <p>Save – Stores the time delay for use with inactivity disconnects.</p> |
| <p>TnSession: Disab Next Enab Disab Prev</p> <p>Telnet Session Enable. Specifies whether the DSU/CSU responds to Telnet session requests.</p> <p>Enab – The DSU/CSU responds to Telnet session requests.</p> <p>Disab – The DSU/CSU does not respond to Telnet session requests.</p> |
| <p>TnPaswd: Disab Next Enab Disab Prev</p> <p>Telnet Password Mode. Specifies whether a password is required for Telnet access.</p> <p>Enab – A password is required for Telnet access.</p> <p>Disab – A password is not required for Telnet access.</p> |
| <p>TnInActTm: Disab Next Enab Disab Prev</p> <p>Telnet Inactivity Timeout. Specifies whether the Telnet session disconnects after a period of inactivity specified by the TnDiscTm configuration option.</p> <p>Enab – The Telnet session disconnects after the period of inactivity specified by the TnDiscTm configuration option.</p> <p>Disab – The Telnet session does not disconnect due to inactivity.</p> |

Table C-4. User Interface Configuration Options (6 of 6)

| TnDiscTm: 5 | | | | |
|---|-----------|-------------|-------------|-------------|
| Next | Up | Down | Save | Prev |
| Telnet Disconnect Time. Specifies the period of time (1 to 60 minutes) before the Telnet session disconnects due to inactivity. (The TnInActTm configuration option must be set to Enab.) Use the left or right arrow key to position the cursor on the digit you want to change. Use the Function keys (Up or Down) to increment or decrement the digit. | | | | |
| Up – Increments the time delay. | | | | |
| Down – Decrements the time delay. | | | | |
| Save – Stores the time delay for use with inactivity disconnects. | | | | |

Alarm Configuration Options

Table C-5. Alarm Configuration Options (1 of 3)

| | | | |
|---|--------------|--------------|-------------|
| Alrm Msg: Disab | | | |
| Next | Disab | Com | Prev |
| <p>Alarm Messages. Controls the generation of alarm messages, which are routed to an ASCII terminal or printer attached to the communication port and/or the modem port.</p> <p>Disab – Prevents an alarm message for any alarm conditions.</p> <p>Com – Enables alarm messages routed to the communication port.</p> <p>NOTE: Alarm messages are only sent to the communication port if the Com Use configuration option is set to ASCII, otherwise the alarm messages are discarded.</p> | | | |
| SNMP Trap: Disab | | | |
| Next | Enab | Disab | Prev |
| <p>SNMP Trap Enable. Specifies whether SNMP trap messages are sent over the SNMP management link.</p> <p>Enab – Enables sending SNMP trap messages from this unit over any SNMP management link.</p> <p>Disab – Disables sending SNMP trap messages from this unit over any SNMP management link.</p> | | | |
| Trap Disc: Enab | | | |
| Next | Enab | Disab | Prev |
| <p>SNMP Trap Disconnect. Specifies whether the modem connection or carrier external communication port device connection is disconnected after sending a trap message. This configuration option applies only to modem connections or carrier external communication port device connections initiated as a result of the trap message being sent.</p> <p>Enab – Specifies that the modem call or carrier external communication port device call is disconnected after a trap message is sent.</p> <p>Disab – Specifies that the modem call or carrier external communication port device call is not disconnected after a trap message is sent. The line is held until it is manually disconnected or disconnected by the remote modem.</p> <p>NOTE: This configuration option is only available if SNMP traps are enabled and the carrier external communication port device is enabled and configured as an SNMP management link.</p> | | | |

Table C-5. Alarm Configuration Options (2 of 3)

| | | | | | | | | | | | |
|---|-------------|--------------|-------------|----------|----------|----------|-------------|----------|----------|-----------|-------------|
| DialOut: Disab | | | | | | | | | | | |
| Next | Enab | Disab | Prev | | | | | | | | |
| <p>Alarm and Trap Dial Out. Controls whether generated alarm or trap messages initiate a call if the external communication port device connection has not already been established. When enabled, a call is placed to the phone number contained in the alarm directory (directory A). If the call cannot be completed and the retry option is enabled, the alarm or trap message is held until the call is completed or the maximum (five) retry count has been exceeded. If more than one alarm message is received while waiting for a call retry, only the highest priority alarm message received is held; all previous messages are discarded. When the COM port is configured as the SNMP management link, up to 10 SNMP trap messages can be queued at the interface.</p> <p>Enab – Enables automatic call initiation (dial out) if an alarm or trap message needs to be sent.</p> <p>Disab – Disables automatic call initiation. Trap messages sent to the external communication port device are queued (held) if a carrier external communication port device connection has not been previously established. Alarm messages are not queued.</p> | | | | | | | | | | | |
| Call Retry: Disab | | | | | | | | | | | |
| Next | Enab | Disab | Prev | | | | | | | | |
| <p>Call Retry on Alarm or Trap. Determines whether a call that cannot complete (busy, no answer, etc.) is retried. This affects calls that are initiated in attempting to send an alarm or trap message to the carrier external communication port device. If call retry is specified, the DSU/CSU attempts to complete the call after a configurable delay.</p> <p>Enab – Enables call retry. If enabled the call is retried up to a maximum of five times per alarm or trap message. A delay as specified by the dial-out delay time is imposed between call attempts. If an alternate dial-out directory is specified, both the alarm directory as well as the alternate directory are retried up to five times.</p> <p>Disab – Disables call retry. If a call setup cannot be completed it is not retried.</p> | | | | | | | | | | | |
| Dial Delay: 5 | | | | | | | | | | | |
| Next | 1 | 2 | 3 | 4 | 5 | 6 | 7 | 8 | 9 | 10 | Prev |
| <p>Dial Out Delay Time on Alarm or Trap. Specifies the number of minutes to wait between successive dial-out alarms or traps and between retry attempts after failed alarm dial-outs. The factory default is 5 minutes.</p> | | | | | | | | | | | |
| AltDialDir: None | | | | | | | | | | | |
| Next | None | 1 | 2 | 3 | 4 | 5 | Prev | | | | |
| <p>Alternate Dial-Out Directory for Alarm or Trap. Specifies whether a call that cannot be completed (busy, no answer, etc.) is retried using an alternate phone number. This affects calls that are initiated in an attempt to send an alarm or trap message to the carrier external communication port device. The alternate phone number to try is contained in one of the five call directories. If call retry is enabled, the initial call is retried at the original number five times before a call attempt to the alternate number is tried. If the call does not complete at the alternate number, it is also retried up to the five-retry maximum. The alternate dial-out option applies to each alarm/trap event. Once a call for an alarm/trap message either completes or fails all retry attempts, the next alarm/trap attempts to establish a call to the phone number contained in the alarm directory.</p> <p>None – Specifies that alternate alarm dial-out is not performed if a call cannot be completed to the telephone number contained in the alarm directory.</p> <p>1–5 – Specifies the call directory that contains the phone number to call if a call cannot be completed to the telephone number contained in the alarm directory.</p> | | | | | | | | | | | |

Table C-5. Alarm Configuration Options (3 of 3)

| Err Rate: 10E-4 | | | | | | | |
|--|--------------|--------------|--------------|--------------|--------------|--------------|-------------|
| Next | 10E-4 | 10E-5 | 10E-6 | 10E-7 | 10E-8 | 10E-9 | Prev |
| <p>Excessive Error Rate Threshold. Sets the error rate threshold that determines if an Excessive Error Rate (EER) condition is declared. This rate is determined by the ratio of the number of CRC6 errors to the total number of bits received over a set period of time.</p> <p>Select from the following:</p> <p>10E-4 – EER is declared if more than 1,535 CRC6 errors are detected within 10 seconds (factory default).</p> <p>10E-5 – EER is declared if more than 921 CRC6 errors are detected within 60 seconds.</p> <p>10E-6 – EER is declared if more than 92 CRC6 errors are detected within 60 seconds.</p> <p>10E-7 – EER is declared if more than 9 CRC6 errors are detected within 60 seconds.</p> <p>10E-8 – EER is declared if more than 41 CRC6 errors are detected in three 15-minute intervals.</p> <p>10E-9 – EER is declared if more than 4 CRC6 errors are detected in three 15-minute intervals.</p> | | | | | | | |
| AlrmRelay: Disab | | | | | | | |
| Next | Enab | Disab | Prev | | | | |
| <p>Alarm Relay. Specifies whether an alarm condition for this circuit card activates the shared alarm relay on the 3000 Series Carrier. The alarm deactivates if the condition(s) causing it is corrected. An Alarm Cut-Off issued from the SDCP (or PC Emulation program) for a particular carrier-mounted DSU/CSU also deactivates the alarm. The carrier-mounted DSU/CSU does not reactivate the alarm relay until all alarm conditions for the unit are cleared.</p> <p>The following alarm conditions activate the alarm relay if this configuration option is enabled:</p> <ul style="list-style-type: none"> ■ Excessive Error Rate (EER) detected at the network interface. ■ Continuous Loss of Signal (LOS) or Out of Frame (OOF) at the network interface. ■ Alarm Indication Signal (AIS) received at the network interface. ■ Yellow alarm signal received at the network interface. | | | | | | | |

Management Configuration Options

The Management configuration options are divided into two tables as follows:

- General Management Configuration Options (Table C-6)
- Management Trap Configuration Options (Table C-7)

Table C-6. General Management Configuration Options (1 of 4)

| | | | | | | | | | | | |
|---|-------------|--------------|-------------|----------|----------|----------|----------|----------|----------|-----------|-------------|
| SNMP Mgt: Disab | | | | | | | | | | | |
| Next | Enab | Disab | Prev | | | | | | | | |
| SNMP Management Enable. Specifies whether the DSU/CSU responds to SNMP session requests. | | | | | | | | | | | |
| Enab – The DSU/CSU responds to SNMP session requests. | | | | | | | | | | | |
| Disab – The DSU/CSU does not respond to SNMP session requests. | | | | | | | | | | | |
| NMS Valid: Disab | | | | | | | | | | | |
| Next | Enab | Disab | Prev | | | | | | | | |
| NMS IP Validation. Specifies whether the DSU/CSU validates (for security reasons) the IP address of an SNMP manager attempting to access the DSU/CSU. Allowable addresses are specified using the NMS <i>n</i> IP Adr configuration option. | | | | | | | | | | | |
| Enab – The DSU/CSU validates the IP address of SNMP management systems attempting to access the DSU/CSU. | | | | | | | | | | | |
| Disab – The DSU/CSU does not validate the IP address of SNMP management systems. | | | | | | | | | | | |
| Num Sec Mgrs: 1 | | | | | | | | | | | |
| Next | 1 | 2 | 3 | 4 | 5 | 6 | 7 | 8 | 9 | 10 | Prev |
| Number of Security Managers. Specifies the number of SNMP managers that are allowed to access the DSU/CSU. | | | | | | | | | | | |
| NOTE: You must configure an IP address for each SNMP manager that is allowed access to the DSU/CSU. Allowable addresses are specified using the NMS <i>n</i> IP Adr configuration option. | | | | | | | | | | | |
| NMS <i>n</i> IP Adr: | | | | | | | | | | | |
| Next | Edit | Clear | Prev | | | | | | | | |
| NMS Manager <i>n</i> IP Address. Specifies the allowable IP address of an SNMP manager attempting to access the DSU/CSU. The manager number (<i>n</i>) is specified by the Num Sec Mgrs configuration option. | | | | | | | | | | | |
| Edit – Allows you to edit and/or display the allowable IP address for the SNMP manager. | | | | | | | | | | | |
| Clear – Allows you to clear the allowable IP address for the SNMP manager. The IP address is set to 000.000.000.000. | | | | | | | | | | | |

Table C-6. General Management Configuration Options (2 of 4)

| | | | |
|--|-------------|--------------|-------------|
| NMS <i>n</i> Acs: Read | | | |
| Next | Read | R/W | Prev |
| <p>NMS Manager <i>n</i> Access Type. Specifies the allowable type of access for an SNMP manager attempting to access the DSU/CSU's MIB using community name 1. The manager number (<i>n</i>) is specified by the Num Sec Mgrs configuration option.</p> <p>Read – Allows read-only access (SNMP Get) to the accessible objects in the MIB for this device when community name 1 is used. This includes all objects specified as either read-only or read/write in the MIB RFCs.</p> <p>R/W – Allows read and write access (SNMP Get and Set) to the objects in the MIB for this device when community name 1 is used. Write access is allowed for all objects specified as read/write in the MIB RFCs. Read access is allowed for all objects specified as either read-only or read/write.</p> | | | |
| System Name: | | | |
| Next | Edit | Clear | Prev |
| <p>System Name. Specifies the system name for this unit. This is the name of this SNMP-managed node.</p> <p>Edit – Allows you to edit or display the system name.</p> <p>Clear – Allows you to clear the system name.</p> | | | |
| System Location: | | | |
| Next | Edit | Clear | Prev |
| <p>System Location. Specifies the system location for this unit. This is the physical location of this SNMP-managed node.</p> <p>Edit – Allows you to edit or display the system location.</p> <p>Clear – Allows you to clear the system location.</p> | | | |
| System Contact: | | | |
| Next | Edit | Clear | Prev |
| <p>System Contact. Specifies the system contact person for this unit, and how to contact this person.</p> <p>Edit – Allows you to edit or display the system contact.</p> <p>Clear – Allows you to clear the system contact.</p> | | | |
| CommunityName1: | | | |
| Next | Edit | Clear | Prev |
| <p>Community Name 1. Specifies the first of two community names that are allowed to access this unit's Management Information Base (MIB). External SNMP managers must supply this name to access an object in the MIB.</p> <p>Edit – Allows you to edit or display the first community name.</p> <p>Clear – Allows you to clear the first community name.</p> | | | |

Table C-6. General Management Configuration Options (3 of 4)

| | | | |
|--|-------------|--------------|-------------|
| Access 1: Read | | | |
| Next | Read | R/W | Prev |
| Access 1. Specifies the type of access allowed for Community Name 1. This is the type of access allowed for external SNMP managers accessing objects in the MIB using Community Name 1. | | | |
| Read – Allows read-only access (SNMP Get) to the accessible objects in the MIB for this device when community name 1 is used. This includes all objects specified as either read-only or read/write in the MIB RFCs. | | | |
| R/W – Allows read and write access (SNMP Get and Set) to the objects in the MIB for this device when community name 1 is used. Write access is allowed for all objects specified as read/write in the MIB RFCs. Read access is allowed for all objects specified as either read-only or read/write. | | | |
| CommunityName2: | | | |
| Next | Edit | Clear | Prev |
| Community Name 2. Specifies the second of two community names that are allowed to access this unit's Management Information Base (MIB). External SNMP managers must supply this name to access an object in the MIB. | | | |
| Edit – Allows you to edit or display the second community name. | | | |
| Clear – Allows you to clear the second community name. | | | |
| Access 2: Read | | | |
| Next | Read | R/W | Prev |
| Access 2. Specifies the type of access allowed for Community Name 2. This is the type of access allowed for external SNMP managers accessing objects in the MIB using Community Name 2. | | | |
| Read – Allows read-only access (SNMP Get) to the accessible objects in the MIB for this device when community name 2 is used. This includes all objects specified as either read-only or read/write in the MIB RFCs. | | | |
| R/W – Allows read and write access (SNMP Get and Set) to the objects in the MIB for this device when community name 2 is used. Write access is allowed for all objects specified as read/write in the MIB RFCs. Read access is allowed for all objects specified as either read-only or read/write. | | | |
| Com IP Adr: | | | |
| Next | Edit | Clear | Prev |
| Com Port IP Address. Specifies the IP address for the communication port if the Com Use configuration option is set to Mgmt. | | | |
| Edit – Allows you to edit or display the IP address for the communication port. | | | |
| Clear – Allows you to clear the IP address for the communication port. The IP address is set to 000.000.000.000. | | | |
| NOTE: This configuration option is not available if the communication port is disabled. | | | |

Table C-6. General Management Configuration Options (4 of 4)

| | | | |
|---|--|--|--|
| <p>Com NetMask: Next Edit Clear Prev</p> | | | |
| <p>Subnet Mask for the Communication Port. Specifies the subnet mask for the communication port if the Com Use configuration option is set to Mgmt.</p> <p>Edit – Allows you to edit and/or display the subnet mask for the communication port.</p> <p>Clear – Allows you to clear the subnet mask for the communication port. The subnet mask is set to 000.000.000.000. If the subnet mask is 000.000.000.000, the IP protocol creates a default subnet mask based on the class of the IP address (Class A: 255.000.000.000, Class B: 255.255.000.000, or Class C: 255.255.255.000).</p> <p>NOTE: This configuration option is not available if the communication port is disabled.</p> | | | |
| <p>Com Link: PPP Next PPP SLIP Prev</p> | | | |
| <p>Com Port Link Layer Protocol. Specifies the link layer protocol for the communication port if the Com Use configuration option is set to Mgmt.</p> <p>PPP – Specifies PPP as the link layer protocol for the IP management link on the communication port.</p> <p>SLIP – Specifies SLIP as the link layer protocol for the IP management link on the communication port. The communication port must be configured for asynchronous operation to support SLIP.</p> <p>NOTE: This configuration option is not available if the communication port is disabled.</p> | | | |

Table C-7. Management Trap Configuration Options (1 of 2)

| | | | | | | | |
|---|--------------|--------------|-------------|-------------|-------------|----------|-------------|
| Num Trap Mgrs: 1 | | | | | | | |
| Next | 1 | 2 | 3 | 4 | 5 | 6 | Prev |
| Number of Trap Managers. Specifies the number of SNMP trap managers that are to receive traps for this unit. | | | | | | | |
| NOTE: You must configure an IP address for each trap manager that is to receive trap messages. | | | | | | | |
| Trap <i>n</i> IP Adr: | | | | | | | |
| Next | Edit | Clear | Prev | | | | |
| Trap <i>n</i> IP Address. Specifies the IP address for each trap manager. This configuration option is repeated for all trap managers supported by the unit. | | | | | | | |
| Edit – Allows you to edit or display the IP address for Trap Manager <i>n</i> . | | | | | | | |
| Clear – Allows you to clear the IP address for Trap Manager <i>n</i> . The IP address is set to 000.000.000.000. | | | | | | | |
| Trap <i>n</i> Dst: None | | | | | | | |
| Next | None | Com | FDL | EDL1 | Prev | | |
| Trap Manager <i>n</i> Destination. Specifies the network destination for Trap Manager <i>n</i> . This configuration option is displayed for the number of trap managers (<i>n</i>) specified by the Number of Trap Managers configuration option. | | | | | | | |
| None – No Trap Manager <i>n</i> network destination. Traps are discarded. | | | | | | | |
| Com – The Trap Manager <i>n</i> network destination is the communication port. This selection only appears if the Com Use configuration option is set to Mgmt. | | | | | | | |
| FDL – The Trap Manager <i>n</i> network destination is the FDL management link. This selection only appears if the FDL management link is enabled. | | | | | | | |
| EDL1 – The Trap Manager <i>n</i> network destination is the EDL1 port. This selection only appears if the synchronous data port's EDL management link is enabled. | | | | | | | |
| NOTE: If the chosen destination link is disabled or down, the traps are discarded. Return to this menu and choose another destination. | | | | | | | |
| Gen Trap: Both | | | | | | | |
| Next | Disab | Warm | Auth | Both | Prev | | |
| General Trap Types. Specifies the general trap types to enable. | | | | | | | |
| Disab – Disables the sending of trap messages for warmStart and authenticationFailure events. | | | | | | | |
| Warm – Sends trap messages for warmStart events to the currently configured trap manager(s). | | | | | | | |
| Auth – Sends trap messages for authenticationFailure events to the currently configured trap manager(s). | | | | | | | |
| Both – Sends trap messages for warmStart and authenticationFailure events to the currently configured trap manager(s). | | | | | | | |
| NOTE: This configuration option is not available if the SNMP Trap configuration option (in the <i>Alarm Configuration Options</i> section on page C-16) is disabled. | | | | | | | |

Table C-7. Management Trap Configuration Options (2 of 2)

| | | | | | |
|--|--|--|--|--|--|
| Entp Trap: Enab Next Enab Disab Prev | | | | | |
| <p>Enterprise Specific Traps. Specifies whether enterpriseSpecific traps are enabled.</p> <p>Enab – Sends trap messages for enterpriseSpecific events to the currently configured trap manager(s).</p> <p>Disab – Disables the sending of trap messages for enterpriseSpecific events.</p> <p>NOTE: This configuration option is not available if the SNMP Trap configuration option (in the <i>Alarm Configuration Options</i> section on page C-16) is disabled.</p> | | | | | |
| Link Trap: Both Next Disab Up Down Both Prev | | | | | |
| <p>Link Trap Type. Specifies the link trap type to enable. Interfaces monitored for linkUp and linkDown traps are specified with the Trap I/F configuration option.</p> <p>Disab – Disables the sending of trap messages for linkDown or linkUp events.</p> <p>Up – Sends trap messages for linkUp events to the currently configured trap manager(s).</p> <p>Down – Sends trap messages for linkDown events to the currently configured trap manager(s).</p> <p>Both – Sends trap messages for linkUp and linkDown events to the currently configured trap manager(s).</p> <p>NOTE: This configuration option is not available if the SNMP Trap configuration option (in the <i>Alarm Configuration Options</i> section on page C-16) is disabled.</p> | | | | | |
| Trap I/F: Both Next NET Prt1 Both Prev | | | | | |
| <p>Link Trap Interfaces. Specifies which interfaces generate linkUp and linkDown trap messages.</p> <p>NET – Sends trap messages for linkUp and linkDown events occurring on the network interface.</p> <p>Prt1 – Sends trap messages for linkUp and linkDown events occurring on the synchronous data port.</p> <p>Both – Sends trap messages for linkUp and linkDown events occurring on the network interface or the synchronous data port.</p> <p>NOTE: This configuration option is not available if the Link Trap configuration option is not configured to generate trap messages for linkUp or linkDown events.</p> | | | | | |

Pin Assignments

D

Overview

The DSU/CSU is shipped with a power module and a VF cable. Various other interconnecting cables are available. For cable feature numbers, refer to Appendix I, *Equipment List*. This appendix describes connector pin assignments and cables.

T1 Network Interface

The T1 network interface connector is an RJ48C, 8-position, unkeyed modular jack (Table D-1).

The T1 line interface cable is a 20-foot, 24 AWG solid, 2-twisted pair cable that is either RJ48C-to-RJ48C (Figure D-1) or RJ48C-to-DA15P (Figure D-2).

Table D-1. T1 Network Interface Connector

| Signal | Pin Number |
|---------------|------------|
| Receive Ring | 1 |
| Receive Tip | 2 |
| Transmit Ring | 4 |
| Transmit Tip | 5 |

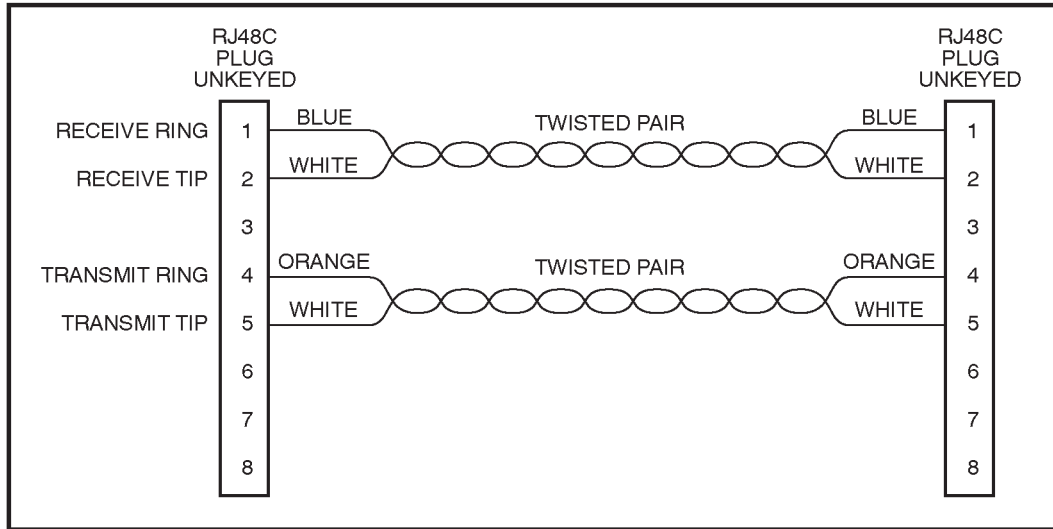

493-14156-01

Figure D-1. T1 Line Interface Cable, RJ48C-to-RJ48C

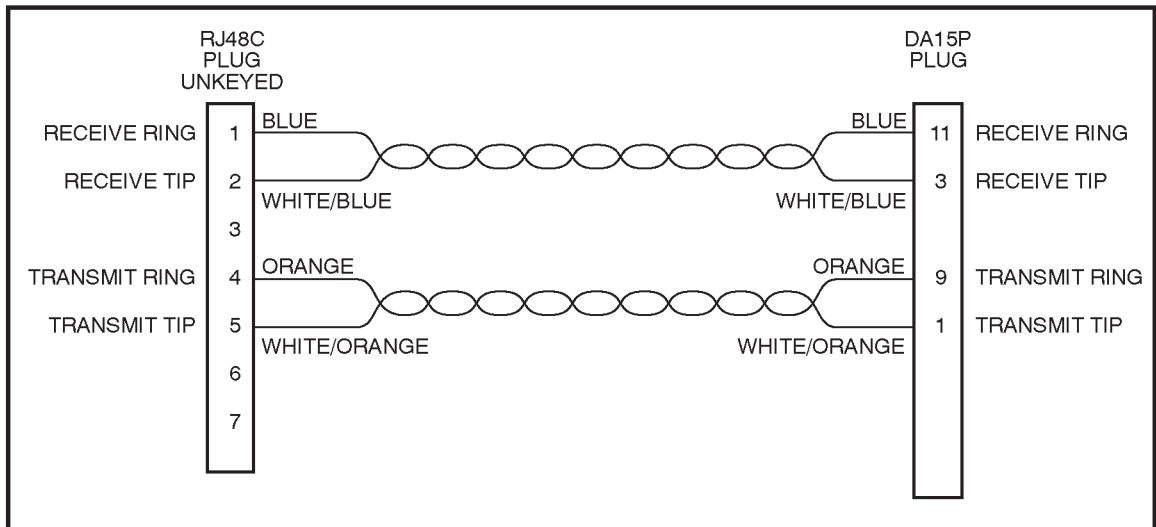

493-14342

Figure D-2. T1 Line Interface Cable, RJ48C-to-DA15P

EIA-530-A Port Interface Connector

The EIA-530-A Port interface connector information is shown in [Table D-2](#).

Table D-2. EIA-530-A Port Interface Connector

| Signal | Circuit Mnemonic | CCITT Number | Direction | Pin |
|---|------------------|--------------|--------------|------------------|
| Shield | — | — | — | 1 |
| Signal Common | AB | 102A | — | 7 |
| Signal Common | AC | 102B | — | 23 |
| Transmitted Data | BA | 103 | To DSU/CSU | 2 (A) 14 (B) |
| Received Data | BB | 104 | From DSU/CSU | 3 (A) 16 (B) |
| Request-to-Send | CA | 105 | To DSU/CSU | 4 (A) 19 (B) |
| Clear-to-Send | CB | 106 | From DSU/CSU | 5 (A) 13 (B) |
| Received Line Signal Detector | CF | 109 | From DSU/CSU | 8 (A) 10 (B) |
| DCE Ready | CC | 107 | From DSU/CSU | 6 |
| DTE Ready | CD | 108/1, /2 | To DSU/CSU | 20 |
| Transmit Signal Element Timing (DTE Source) | DA | 113 | To DSU/CSU | 11 (B) 24 (A) |
| Transmit Signal Element Timing (DCE Source) | DB | 114 | From DSU/CSU | 12 (B) 15 (A) |
| Receiver Signal Element Timing (DCE Source) | DD | 115 | From DSU/CSU | 17 (A) 9 (B) |
| Local Loopback | LL | 141 | To DSU/CSU | 18 |
| Remote Loopback | RL | 140 | To DSU/CSU | 21 |
| Test Mode | TM | 142 | From DSU/CSU | 25 |

EIA-530-A-to-RS449 Cable Interface

The EIA-530-A-to-RS449 adapter cable (Figure D-3) provides the RS449 interface shown in Table D-3.

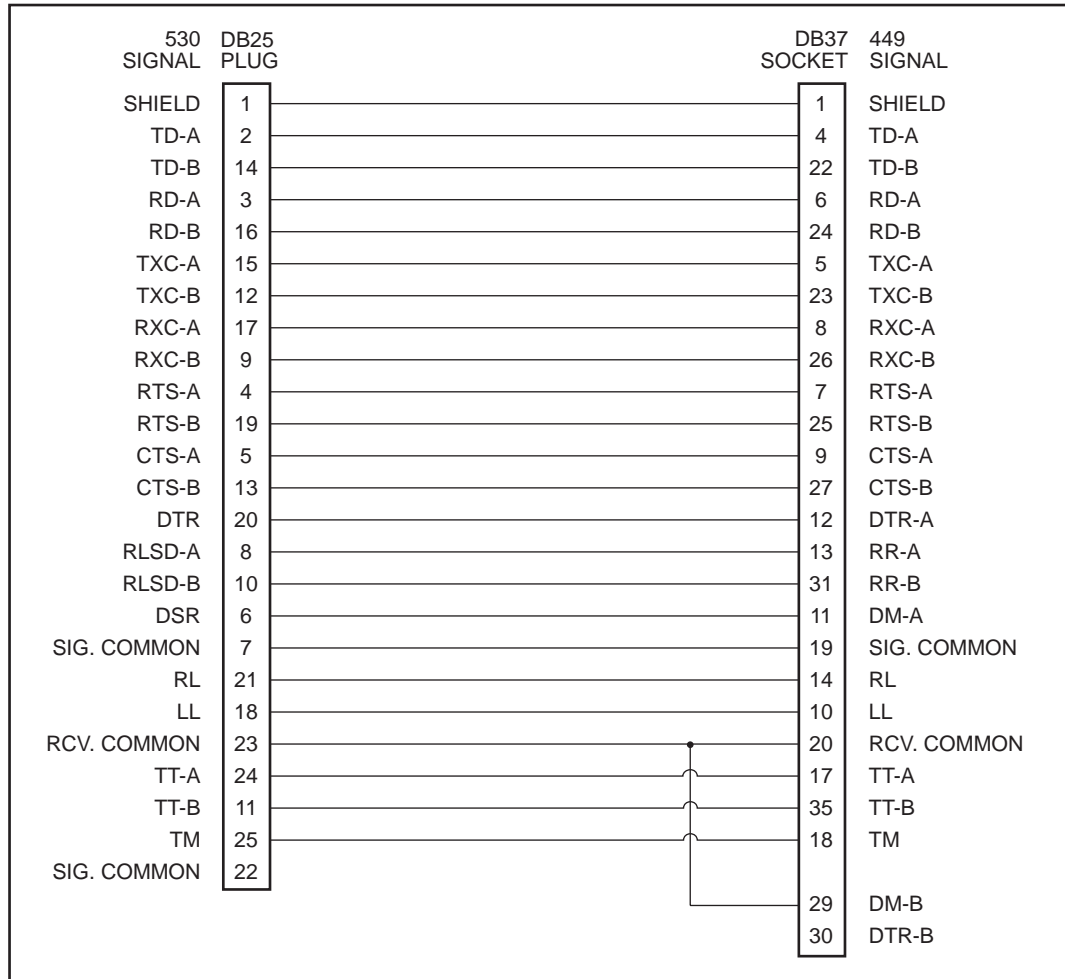

495-14323-01

Figure D-3. EIA-530-A-to-RS449 Cable

Table D-3. RS449 Cable Interface

| Signal | Circuit Mnemonic | CCITT Number | Direction | Pin |
|-----------------|-------------------------|---------------------|------------------|------------------|
| Shield | — | — | — | 1 |
| Signal Ground | SG | 102A | — | 19 |
| Receive Ground | RC | 102B | — | 20 |
| Send Common | SC | — | — | 37 |
| Send Data | SD | 103 | To DSU/CSU | 4 (A) 22 (B) |
| Receive Data | RD | 104 | From DSU/CSU | 6 (A) 24 (B) |
| Request-to-Send | RS | 105 | To DSU/CSU | 7 (A) 25 (B) |
| Clear-to-Send | CS | 106 | From DSU/CSU | 9 (A) 27 (B) |
| Receiver Ready | RR | 109 | From DSU/CSU | 13 (A) 31 (B) |
| Data Mode | DM | 107 | From DSU/CSU | 11 (A) 29 (B) |
| Terminal Ready | TR | 108/1, /2 | To DSU/CSU | 12 (A) 30 (B) |
| Terminal Timing | TT | 113 | To DSU/CSU | 17 (A) 35 (B) |
| Send Timing | ST | 114 | From DSU/CSU | 5 (A) 23 (B) |
| Receive Timing | RT | 115 | From DSU/CSU | 8 (A) 26 (B) |
| Local Loopback | LL | 141 | To DSU/CSU | 10 |
| Remote Loopback | RL | 140 | To DSU/CSU | 14 |
| Test Mode | TM | 142 | From DSU/CSU | 18 |

EIA-530-A-to-V.35 Cable Interface

The EIA-530-A-to-V.35 adapter cable (Figure D-4) provides the V.35 interface shown in Table D-4.

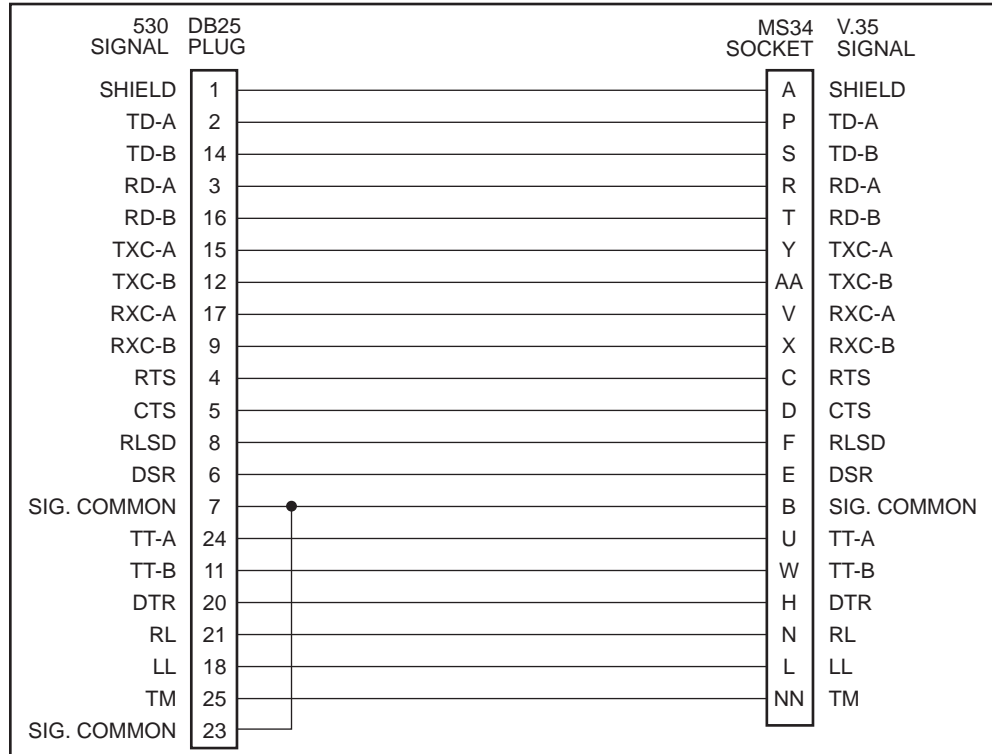

497-15233

Figure D-4. EIA-530-A-to-V.35 Cable

Table D-4. V.35 Cable Interface

| Signal | CCITT Number | Direction | Pin |
|---|--------------|--------------|-----------------|
| Shield | — | — | A |
| Signal Common | 102 | — | B |
| Transmitted Data | 103 | To DSU/CSU | P (A) S (B) |
| Received Data | 104 | From DSU/CSU | R (A) T (B) |
| Request to Send | 105 | To DSU/CSU | C |
| Clear to Send | 106 | From DSU/CSU | D |
| Data Channel Received Line Signal Detector | 109 | From DSU/CSU | F |
| Data Set Ready | 107 | From DSU/CSU | E |
| Data Terminal Ready | 108/1, /2 | To DSU/CSU | H |
| Transmit Signal Element Timing (DTE Source) | 113 | To DSU/CSU | U (A) W (B) |
| Transmit Signal Element Timing (DCE Source) | 114 | From DSU/CSU | Y (A) AA (B) |
| Receiver Signal Element Timing (DCE Source) | 115 | From DSU/CSU | V (A) X (B) |
| Local Loopback | 141 | To DSU/CSU | L |
| Loopback/Maintenance | 140 | To DSU/CSU | N |
| Test Indicator | 142 | From DSU/CSU | NN |

EIA-530-A-to-X.21 Cable Interface

The EIA-530-A-to-X.21 adapter cable (Figure D-5) provides the X.21 interface shown in Table D-5.

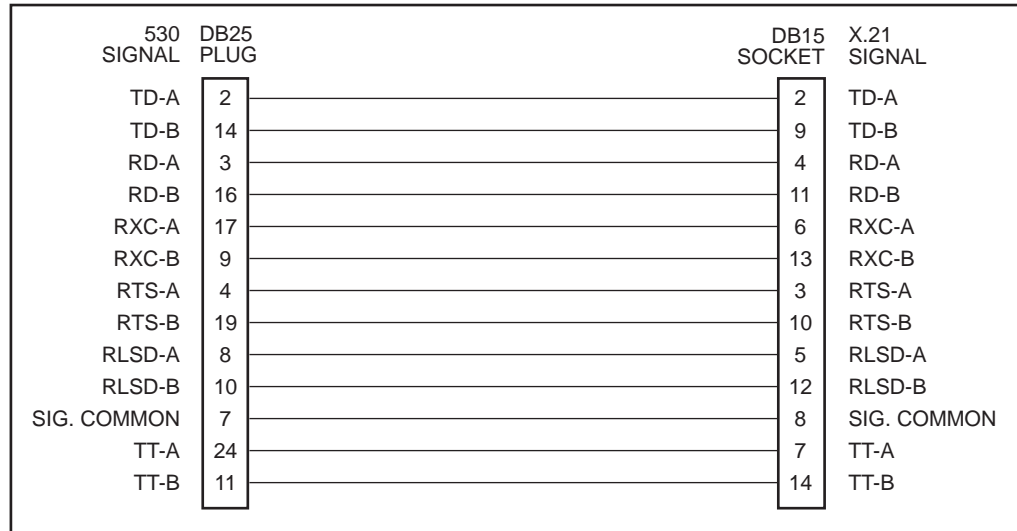

495-14787

Figure D-5. EIA-530-A-to-X.21 Cable

Table D-5. X.21 Cable Interface

| Signal | CCITT Number | Direction | Pin |
|---|--------------|--------------|-----------------|
| Signal Common | 102 | — | 8 |
| Transmitted Data | 103 | To DSU/CSU | 2 (A) 9 (B) |
| Received Data | 104 | From DSU/CSU | 4 (A) 11 (B) |
| Request-to-Send | 105 | To DSU/CSU | 3 (A) 10 (B) |
| Data Channel Received Line Signal Detector | 109 | From DSU/CSU | 5 (A) 12 (B) |
| Transmit Signal Element Timing (DTE Source) | 113 | To DSU/CSU | 7 (A) 14 (B) |
| Receiver Signal Element Timing (DCE Source) | 115 | From DSU/CSU | 6 (A) 13 (B) |

COM Port Interface

The COM port connects to a PC for front panel emulation, to an ASCII terminal or printer for alarms, to an asynchronous terminal, to a network device (e.g., a router) for SNMP or Telnet applications, or to a LAN Adapter for SNMP or Telnet applications. (The SNMP LAN Adapter includes the cable that is needed to attach it to the DSU/CSU.) The COM port connector is an 8-position unkeyed modular connector (Table D-6). The data signals on this port are referenced to a DTE interface.

The COM port-to-PC cable is shown in Figure D-6 and the COM port-to-terminal/printer cable is shown in Figure D-7.

Table D-6. COM Port Connector

| Signal | Direction | Pin Number |
|-------------------------|--------------|------------|
| DCE Transmit Clock | From DSU/CSU | 1 |
| DCE Receive Data | From DSU/CSU | 2 |
| Signal Ground | — | 3 |
| DCE Transmit Data | To DSU/CSU | 4 |
| DCE Data Terminal Ready | To DSU/CSU | 5 |
| DCE Carrier Detect | From DSU/CSU | 6 |
| DCE Request-to-Send | To DSU/CSU | 7 |
| DCE Receive Clock | From DSU/CSU | 8 |

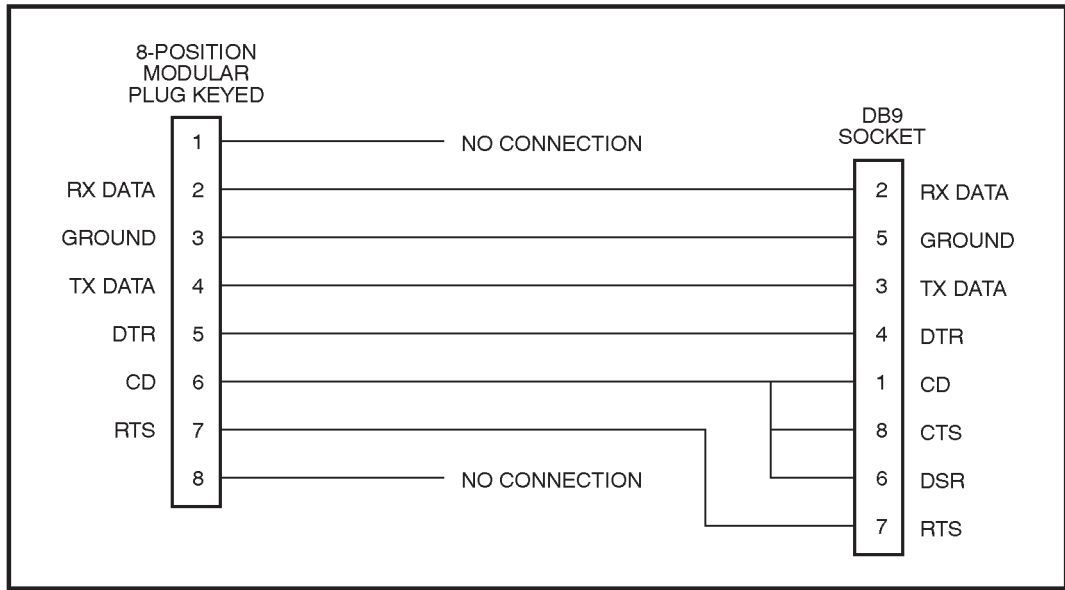

Figure D-6. COM Port-to-PC Cable

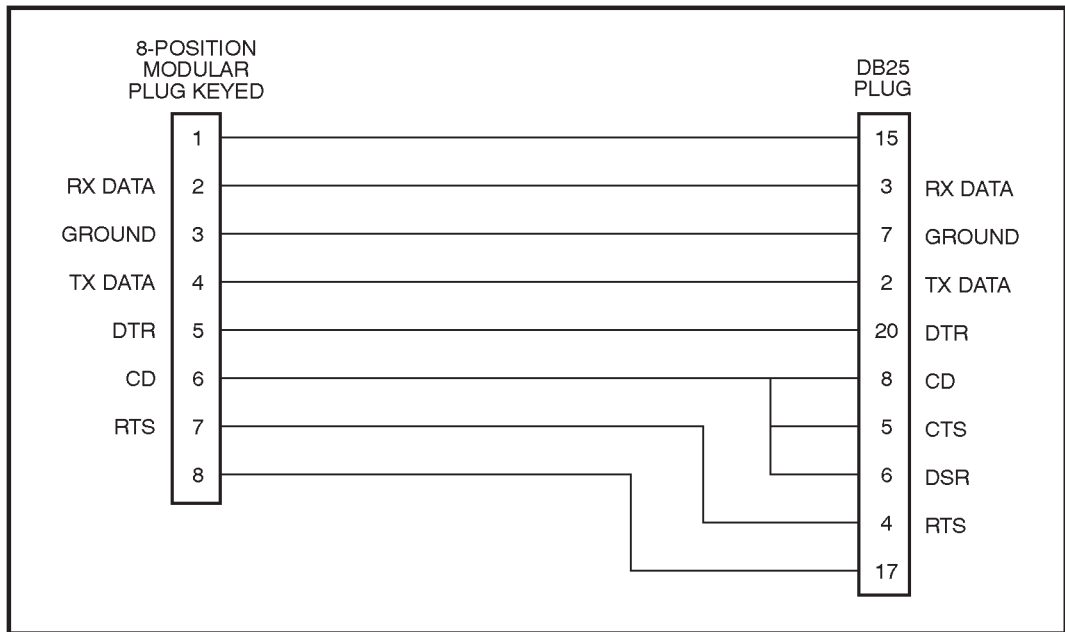
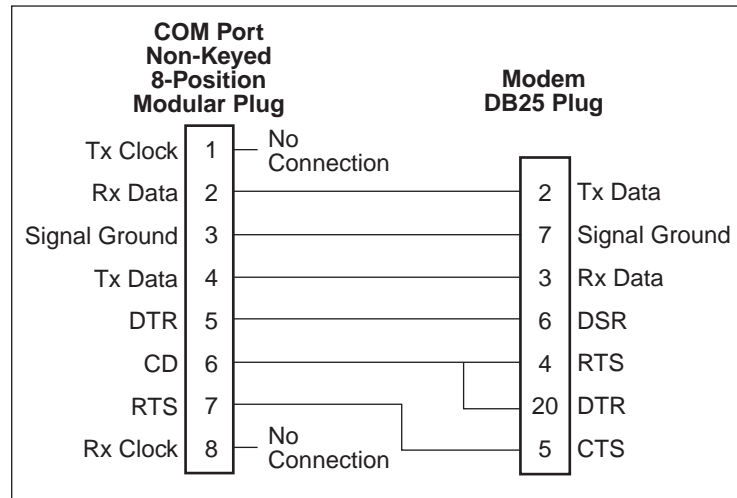

Figure D-7. COM Port-to-Terminal/Printer Cable

COM Port to Modem Cable

Use a serial crossover cable when connecting the COM port to a modem or other external device. The following shows the pin assignments from the COM port to the external device.



97-15669

Figure D-8. Com Port to Modem Cable

SNMP MIB Objects

E

Overview

This appendix describes the Management Information Base (MIB) objects that are supported by the DSU/CSU and provides a correlation between front panel commands and MIB objects (Table E-1).

The DSU/CSU supports the following MIBs:

- **MIB II** – Defines the general objects for use in Transmission Control Protocol/Internet Protocol (TCP/IP) internets and provides general information about the DSU/CSU.
- **RS-232-like MIB** – Defines objects for managing RS-232-type interfaces and supports synchronous data port and COM port on the DSU/CSU.
- **Generic-Interface Extension MIB** – An extension to MIB II that defines additional objects for control of generic interfaces in MIB II. It supports control of tests on synchronous data interface that are not supported by other MIBs.
- **Enterprise MIB** – Defines objects that are unique to devices such as Model 3166 DSU/CSUs.

MIB II (RFC 1213)

The objects defined by MIB II are organized into 10 different groups. The DSU/CSU implements only those groups where the semantics of the group are applicable to the implementation of a DSU/CSU. The MIB II object groups supported or not supported by the 3100 Series devices are as follows:

| | |
|----------------------------------|--|
| System Group | Supported. |
| Interface Group | Supported for the network interface, the synchronous data port, and the COM port. Interface statistics (counters) apply to the port defined as the SNMP management link. |
| Address Translation Group | Not supported since this group is not supported in MIB II. |
| IP Group | Supported. |
| ICMP Group | Supported. |
| TCP Group | Supported. |
| UDP Group | Supported. |
| EGP Group | Not supported since the EGP protocol is not supported by the DSU/CSU. |
| Transmission Group | Supported on the synchronous data port using the RS-232-like MIB. Supported on the COM port using the RS-232-like MIB. |
| SNMP Group | Supported. |

System Group, MIB II

The System Group objects are fully supported by the DSU/CSU. The following sections provide clarification for objects contained in the System Group where it is not otherwise clear how the object definition in MIB II is related to the DSU/CSU. Objects not mentioned are supported as stated in the MIB.

System Group – “sysDescr” Object (system 1)

This object provides the full name and version identification for the system hardware and software. This object displays the following string:

[*Company Name*] T1 DSU/CSU; model xxxx-xx-xxx; S/W Release: yy.yy.yy; H/W CCA1: zzzz-zzz; H/W CCA2: zzzz-zzz; Serial number: ssssssss.

Where: xxxx-xx-xxx represents the full model number of the unit.
yy.yy.yy represents the software revision number of the unit.
zzzz-zzz represents the hardware revision number of the unit.
sssssss represents the serial number of the unit.

System Group – “sysObjectID” Object (system 2)

This object provides the authoritative identification of the network management subsystem contained in the unit.

This object displays the following object identifier:

3166 [Company OID].1.14.2.2.8

System group –”sysContact” Object (system 4)

This object provides a textual identification of the contact person for this managed node.

System Group – “sysName” Object (system 5)

This object provides an administratively-assigned name for this managed node.

System Group – “sysLocation” Object (system 6)

This object provides the physical location of this node.

System Group – “sysServices” Object (system 7)

This object provides a value which indicates the set of services that are potentially offered by the DSU/CSU. Only the following values are supported.

- physical(1) – Layer 1 functionality for all interfaces.
- datalink/subnetwork(2) – Layer 2 functionality (SLIP, PPP) for the COM, AUX, and MODEM ports.
- internet(4) – Layer 3 functionality (IP) for all management links.
- end-to-end(8) – Layer 4 functionality (UDP) for all management links.

Therefore, set this object to 15 (the sum of 1 + 2 + 4 + 8).

Interface Group, MIB II

The Interfaces Group consists of an object indicating the number of interfaces supported by the unit and an interface table containing an entry for each interface. The DSU/CSU provides an entry in the interface table for the network interface, the synchronous data port, and the COM port. The following sections provide clarification for objects contained in the Interface Group where it is not clear how the object definition in MIB II is related to the DSU/CSU.

Interface Group – “ifNumber” Object (interfaces 1)

This variable contains the maximum number of MIB II supported interfaces possible across the 31xx Series product line (9). This is different from the MIB description, which is defined as the number of interfaces on the particular device. This change allows the use of the same ifIndexes across all 31xx Series models.

Interface Group – “ifIndex” Object (ifEntry 1)

This object provides the index into the ifTable and typically into tables in other MIBs also. The values of the ifIndex object do not vary between models even though not all indexes are supported for a particular model. When an unsupported index is accessed, “noSuchName” is returned.

The following are the values of the ifIndexes for the Model 3166 DSU/CSU:

- 1 – Net T1
- 3 – COM port
- 6 – DCE port 1

Interface Group – “ifDescr” Object (ifEntry 2)

This object provides information about the interface. Each interface displays a text string as shown below:

Network T1: “**Network T1.** [*Company Name*] **T1 DSU/CSU, Hardware Version:** [CCA number for the CSU board]”.

COM: “**COM port.** [*Company Name*] **T1 DSU/CSU, Hardware Version:** [CCA number for the CSU board for the standalone, or the CCA number for the DSU board for the carrier]”.

Data Port: “**Data Port 1.** [*Company Name*] **T1 DSU/CSU, Hardware Version:** [CCA number for the DSU board]”
(where *n* is 1 to 4).

Interface Group – “ifType” Object (ifEntry 3)

This object identifies the type of the interface based on the physical/link protocol(s) immediately below the network layer. Only the following values are supported by the DSU/CSU:

- ds1 – Used for the network interface.
- propPointToPointSerial(22) – Used for the synchronous data port. Used for the COM port when the port is not configured as the SNMP management interface.
- ppp(23) – Used for the COM port when the port is configured for PPP.
- slip(28) – Used for the COM port when the port is configured for SLIP.

Interface Group – “ifMtu” Object (ifEntry 4)

This object identifies the largest datagram that can be sent or received on the interface. It is applicable only to the interface configured as the SNMP management link. This object is zero for all other interfaces.

Interface Group – “ifSpeed” Object (ifEntry 5)

This object provides the interface’s current bandwidth in bits per second. The value of this object for each interface is specified as follows:

- T1 Interfaces: 1,544,000 bps.
- COM: The currently configured data rate for the port.
- Data Port: The currently configured data rate for the port when the port is allocated to one of the T1 interfaces. If the port is not allocated the data rate is defined as zero.

Interface Group – “ifAdminStatus” Object (ifEntry 7)

This object specifies the desired state (configuration) of the interface. This object is supported only for the COM port. It provides the ability to switch between using the port for SNMP or ASCII operations (dial-out, front panel emulation). The value of this object will not affect the state of any of the interfaces on the DSU/CSU other than the COM port. Only the following values are supported by the DSU/CSU:

- up(1) – The SNMP management link is active on the COM port.
- testing(3) – The SNMP management link is inactive on the COM port. These ports can be used for proprietary ASCII functions.

Interface Group – “ifOperStatus” Object (ifEntry 8)

This object specifies the current operational state of the interface. The value of this object for each interface is defined as follows:

- Network T1: The interface is up(1) when no alarm conditions exist.
The interface is down(2) when an alarm condition is active.
The interface is testing(3) when a test is active on the interface.
- COM Port: When configured as an SNMP management link, up and down are based on the current state of the link layer protocol.
Otherwise, the interface is always up(1).
The interface is never in the testing(3) state.
- Data Port: The interface is up(1) when the port is assigned to a T1 interface, and both CTS and DSR are ON.
The interface is down(2) when the port is unassigned, or either CTS or DSR is OFF.
The interface is testing(3) when a test is active on the interface.

Interface Group – “ifLastChange” Object (ifEntry 9)

This object contains the value of “sysUpTime” at the time the interface entered its current operational state.

Interface Group – Input Counters (objects ifEntry 10 to ifEntry 15)

These objects collect statistics on the data received by the COM port when it is configured as an SNMP management link. For an interface that is not configured as an SNMP management link, these statistics are not provided and an error status is returned if access is attempted. The objects used to collect input statistics are listed below:

- ifInOctets (ifEntry 10)
- ifInUcastPkts (ifEntry 11)
- ifInNUcastPkts (ifEntry 12)
- ifInDiscards (ifEntry 13)
- ifInErrors (ifEntry 14)
- ifInUnknownProtos (ifEntry 15)

Interface Group – Output Counters (objects ifEntry 16 to ifEntry 21)

These objects collect statistics on the data received by the COM port when it is configured as an SNMP management link. For an interface that is not configured as an SNMP management link, these statistics are not provided and an error status is returned if access is attempted. The objects used to collect output statistics are listed below:

- ifOutOctets (ifEntry 16)
- ifOutUcastPkts (ifEntry 17)
- ifOutNUcastPkts (ifEntry 18)
- ifOutDiscards (ifEntry 19)
- ifOutErrors (ifEntry 20)
- ifOutQLen (ifEntry 21)

IP Group, MIB II

The IP Group objects are supported by the DSU/CSU for all data paths which currently are configured to carry IP data to or from the DSU/CSU, including the COM, carrier SNMP bus, and FDL. All of the objects in the IP Group other than the IP Address Translation table are fully supported. The IP Address Translation table (ipNetToMediaTable) does not apply to the DSU/CSU and will be empty (i.e., have zero entries). The following sections provide clarification for objects contained in the IP Group when it is not clear how the object definition in MIB II is related to the DSU/CSU.

IP Group – “ipForwarding” Object (ip 1)

This object specifies whether the unit is acting as an IP gateway in respect to the forwarding of a datagram received by, but not addressed to, this unit. Only the following value is supported by the DSU/CSU.

- forwarding(1) – The unit is acting as a gateway.

IP Group – “ipAddrTable” Object (ip 20)

The address table is supported by the DSU/CSU.

IP Group – “ipAdEntAddr” Object (ipAddrEntry 1)

The ipAdEntAddr object is an IP address supported by the device and serves as the index to the address table. Since indexes for tables must be unique, only one ifIndex may be displayed for each IP address supported by the device. If you have configured the same IP address for multiple interfaces or for default IP addresses, you will not see all interfaces that support a particular IP address upon display of the ipAddrTable.

IP Group – “ipAdEntIfIndex” Object (ipAddrEntry 2)

For some address table entries, the ipAdEntIfIndex object may have a value greater than ifNumber. In these cases, the ipAdEntIfIndex refers to a proprietary interface which is not currently implemented by the interface group of MIB II.

IP Group – “ipRouteTable” Object (ip 21)

The routing table used by the DSU/CSU is supported as a read/write table. Entries in this table may be added, deleted, or changed. You should exercise great caution when adding or modifying routes in the ipRoutingTable. In general, it should not be necessary to add or modify routes in the DSU/CSU. In those cases where it is deemed necessary, the routes should only be added to the connected device (i.e., the device closest to the destination). Internal routing mechanisms will propagate the route to the other devices.

An existing route may be effectively deleted by setting the ipRouteType object to “invalid” for the entry to be deleted. An existing route may be modified by changing fields in the desired entry (indexed by ipRouteDest) of the routing table. A new route may be added by specifying values for a table entry for which the index (“ipRouteDest”) does not already exist.

To add a route using an SNMP set, you must specify a group of minimal objects. These variable bindings must be contained in a single Protocol Data Unit (PDU). The objects are described in more detail in the following sections. The minimal set consists of:

- ipRouteDest
- ipRouteIfIndex

The following objects are defaulted if not specified in the set PDU used to add a route.

- ipRouteMetric1 – Defaulted to 1 hop.
- ipRouteMetric2 – Defaulted to current slot for carrier devices and –1 for standalone devices.
- ipRouteType – Defaulted to indirect.
- ipRouteMask – Defaulted as specified in the MIB description.

The following objects are unused in the DSU/CSU and setting them will have no effect on the operation of the IP implementation.

- ipRouteMetric3, ipRouteMetric4, ipRouteMetric5 – Defaulted to –1 as specified in the MIB.
- ipRouteNextHop – Defaulted to 0.0.0.0.

The following read-only objects must not be specified in the set PDU used to add a route.

- ipRouteProto – Set to netmgmt(3) by software.
- ipRouteAge – Defaulted to 999.
- ipRouteInfo – Set to OBJECT IDENTIFIER {0, 0} since it is unused.

IP Group – “ipRouteDest” Object (ipRouteEntry 1)

The ipRouteDest object serves as the index to the routing table. Since indexes for tables must be unique, only one route per destination may appear in the table. To ensure that no duplicate destinations appear in the routing table, the ipRouteDest object of the ipRouteTable will be treated as described in RFC 1354 (IP Forwarding Table MIB):

“The destination IP address of this route. An entry with a value of 0.0.0.0 is considered a default route. This object may not take a Multicast (Class D) address value. Any assignment (implicit or otherwise) of an instance of this object to a value x must be rejected if the bitwise logical-AND of x with the value of the corresponding instance of the ipForwardMask object is not equal to x .”

IP Group – “ipRoutelIndex” Object (ipRouteEntry 1)

When the routing table is displayed, the ipRoutelIndex object for some entries may have a value greater than ifNumber. In these cases, the ipRoutelIndex refers to a proprietary interface which is not currently implemented by the interface group of MIB II. Route entries with an unrecognized ipRoutelIndex value should not be deleted.

When setting this object via SNMP, the ipRoutelIndex value can only assume an appropriate value of ifIndex defined for the particular device type.

IP Group – “ipRouteMetric2” Object (ipRouteEntry 4)

The following values are displayed for the ipRouteMetric2 object. For a carrier device designated as the IP Bus Master, ipRouteMetric2 is used to designate the slot number of the next hop associated with this route if the destination is not connected to the device. For carrier devices not designated as the IP Bus Master or IP Bus Master devices in which the destination is connected to the device, ipRouteMetric2 contains the slot number (0–15) of the carrier device. For standalone devices, ipRouteMetric2 is not used and contains –1.

When adding a route to the routing table using SNMP, do not specify a value for ipRouteMetric2.

IP Group – “ipRouteProto” Object (ipRouteEntry 9)

This object is a read-only object and may have the following values in the DSU/CSU.

- other(1) – Temporary route added by IP.
- local(2) – Route added or modified as a result of user configuration via the front panel.
- netmgmt(3) – Route added or modified by means of an SNMP set.
- icmp(4) – Route added or modified by Internet Control Management Protocol (ICMP).
- rip(8) – Route added or modified by Routing Information Protocol (RIP) (or similar proprietary protocol).

IP Group – “ipRouteAge” Object (ipRouteEntry 10)

This object is implemented as a read-only object in the DSU/CSU. In the DSU/CSU, it reflects the value of the route’s time-to-live (in seconds). When displays, a value of 999 represents a route that is retained permanently. For temporary routes, the ipRouteAge object decrements over time. All routes added via an SNMP set of the ipRouteTable are considered permanent routes. These routes do not age, but will remain unless deleted via SNMP.

ICMP Group, MIB II

The ICMP Group objects are fully supported by the DSU/CSU.

TCP Group, MIB II

The TCP Group objects are fully supported by the DSU/CSU, with the exception of the tcpConnState object, which will be read-only.

UDP Group, MIB II

The User Datagram Protocol (UDP) Group objects are fully supported by the DSU/CSU.

Transmission Group, MIB II

Objects in the transmission group are supported on the network interface, the COM port, and the synchronous data port. The objects in the transmission group are not defined within MIB II, but rather through other Internet standard MIB definitions. The following two transmission group objects are supported by the DSU/CSU.

- ds1 (transmission 18) – The transmission object supported on the T1 interfaces.
- rs232 (transmission 33) – The transmission object supported on the synchronous data port and the COM port port.

The “ds1” transmission object is defined by the DS1/E1 MIB. The rs232 transmission object is defined by the RS-232-like MIB.

SNMP Group, MIB II

The SNMP Group objects that apply to a management agent are fully supported by the DSU/CSU. The following objects apply only to an NMS and return a zero value if accessed.

- snmpInTooBigs (snmp 8)
- snmpInNoSuchNames (snmp 9)
- snmpInBadValues (snmp 10)
- snmpInReadOnlys (snmp 11)
- snmpInGenErrs (snmp 12)
- snmpInGetResponses (snmp 18)
- snmpInTraps (snmp19)
- snmpOutGetRequests (snmp 25)
- snmpOutGetNexts (snmp 26)
- snmpOutSetRequests (snmp 27)

DS1/E1 MIB (RFC 1406)

The “ds1” object defined by RFC 1406 is supported for the network interface. The DS1 Far End Group is not supported.

Near End Group, DS1/E1 MIB

The DS1 Near End Group consists of the following four tables:

- DS1 Configuration
- DS1 Current
- DS1 Interval
- DS1 Total

Near End Group – “dsx1LineType” Object (dsx1ConfigEntry 5)

This object corresponds to the NET Framing/DTE Framing configuration options for the T1 interface on the DSU/CSU. Only the following values are supported by the DSU/CSU.

- dsx1ESF(2) – Indicates ESF framing.
- dsx1D4(2) – Indicates D4 framing.

Near End Group – “dsx1LineCoding” Object (dsx1ConfigEntry 6)

This object corresponds to the NET Coding/DTE Coding configuration options for the T1 interface on the DSU/CSU. Only the following values are supported by the DSU/CSU.

- dsx1B8ZS(2) – Indicates B8ZS line coding.
- dsx1AMI(5) – Indicates AMI line coding.

Near End Group – “dsx1SendCode” Object (dsx1ConfigEntry 7)

This object specifies the test patterns/codes being sent over the network interface. Only the following values are supported by the DSU/CSU.

- dsx1SendNoCode(1) – Specifies that the interface is sending normal or looped data. Setting the interface to this value stops an active “send pattern” test on the interface.
- dsx1SendLineCode(2) – Specifies that the network interface is sending a Remote Loopback (Rlpbk) LLBUP code. The code is sent for 10 seconds.
- dsx1SendResetCode(4) – Specifies that the network interface is sending Remote Loopback (Rlpbk) LLBDN code. The code is sent for 10 seconds.
- dsx1SendQRS(5) – Specifies that the network interface is sending a QRSS test pattern. The pattern is sent until the test is halted (i.e., setting to dsx1SendNoCode).
- dsx1SendOtherTestPattern(8) – Specifies that the network interface is sending a 1-in-8 test pattern. The pattern is sent until the test is halted (i.e., setting to dsx1SendNoCode).

Near End Group – “dsx1LoopbackConfig” Object (dsx1ConfigEntry 9)

This object specifies the loopback state of the T1 interface. Only the following values are supported by the DSU/CSU.

- dsx1NoLoop(1) – The T1 interface is not in a loopback state.
- dsx1PayloadLoop(2) – Specifies that a Payload Loopback (PLB) is active for the network interface or a Repeater Loopback (RLB) is active for the DTE Drop/Insert (DSX-1) interface.
- dsx1LineLoop(3) – Specifies that a Line Loopback (LLB) is active for the network interface or a DTE Loopback (DLB) is active for the DTE Drop/Insert (DSX-1) interface.

Near End Group – “dsx1LineStatus” Object (dsx1ConfigEntry 10)

This object specifies the line (alarm) status of the T1 interfaces. Only the following values are supported by the DSU/CSU. More than one value may be active at a time.

- dsx1NoAlarm(1) – No alarm present.
- dsx1RcvFarEndLOF(2) – A yellow alarm signal is being received.
- dsx1RcvAIS(8) – An Alarm Indication Signal (AIS) is being received.
- dsx1LossOfFrame(32) – An Out Of Frame condition has persisted for more than 2.5 seconds (i.e., Red Alarm).
- dsx1LossOfSignal(64) – A Loss of Signal condition has persisted for more than 2.5 seconds (i.e., Red Alarm).
- dsx1LoopbackState(128) – The near end of the T1 interface is in a loopback state.
- dsx1Other Failure(4096) – An Excessive Error Rate (EER) has been detected on the network interface.

Near End Group – “dsx1SignalMode” Object (dsx1ConfigEntry 11)

This object specifies whether Robbed Bit Signaling (RBS) is being used. This object differs from the MIB definition in that it is “read-only” (not read/write) for DSU/CSUs. Only the following values are supported by the DSU/CSU.

- none(1) – No signaling is being used on this interface.
- robbedBit(2) – Robbed Bit Signaling is being used on at least one DS0 on this T1 interface.

Near End Group – “dsx1TransmitClockSource” Object (dsx1ConfigEntry 12)

This object specifies the timing source for the transmit clock for this T1 interface. This object differs from the MIB definition in that it is “read-only” (not read/write) for DSU/CSUs. Only the following values are supported by the DSU/CSU.

- loopTiming(1) – The recovered receive clock is being used as the transmit clock.
- localTiming(2) – The DSU/CSU's internal clock is used being as the transmit clock.
- ThroughTiming(3) – The recovered receive clock from another interface (e.g., T1, Port, or External) is being used as the transmit clock.

Near End Group – “dsx1Fdl” Object (dsx1ConfigEntry 13)

This object specifies how Facility Data Link is being used. Only the following values are supported by the DSU/CSU. More than one value may be active at a time.

- dsx1other(1) – SNMP data is being sent over FDL.
- dsx1Ansi-T1-403(2) – ANSI PRMs are supported on the network interface as specified by ANSI T1.403.
- dsx1Att-54016(4) – FDL supports the requirements specified by AT&T publication TR54016.
- dsx1Fdl-none(8) – Indicates that the device does not use FDL.

Near End Group – The DS1 Current Table Objects (dsx1CurrentEntry)

The following DS1 current table objects are provided for the network interface. Objects in the table that are not listed are not supported and will return an error status if access is attempted.

- dsx1CurrentIndex – The index that identifies the T1 interface.
- dsx1CurrentESs – Errored Seconds for the current interval.
- dsx1Current SESs – Severely Errored Seconds for the current interval.
- dsx1CurrentUASs – Unavailable Seconds for the current interval.
- dsx1CurrentCSSs – Controlled Slip Seconds for the current interval.
- dsx1CurrentBESs – Bursty Errored Seconds for the current interval.

Near End Group – The DS1 Interval Table Objects (dsx1IntervalEntry)

The following DS1 interval table objects are provided for the network interface only. Objects in the table that are not listed are not supported and will return an error status if access is attempted.

- dsx1IntervallIndex – The index that identifies the T1 interface.
- dsx1IntervalNumber – The interval number (1 to 96).
- dsx1IntervalESs – Errored Seconds for the interval.
- dsx1Interval SESs – Severely Errored Seconds for the interval.
- dsx1IntervalUASs – Unavailable Seconds for the interval.
- dsx1IntervalCSSs – Controlled Slip Seconds for the interval.
- dsx1Interval BESs – Bursty Errored Seconds for the interval.

Near End Group – The DS1 Total Table Objects (dsx1TotalEntry)

The following DS1 total table objects are provided for the network interface only. Objects in the table that are not listed are not supported and will return an error status if access is attempted.

- dsx1TotalIndex – The index that identifies the T1 interface.
- dsx1TotalESs – The 24-hour total Errored Seconds.
- dsx1Total SESs – The 24-hour total Severely Errored Seconds.
- dsx1TotalUASs – The 24-hour total Unavailable Seconds.
- dsx1TotalCSSs – The 24-hour total Controlled Slip Seconds.
- dsx1TotalBESs – The 24-hour total Bursty Errored Seconds.

Far End Group, DS1/E1 MIB

The DS1 Far End Group consists of the following three tables:

- DS1 Far End Current
- DS1 Far End Interval
- DS1 Far End Total

These tables are not supported.

DS1 Fractional Group, DS1/E1 MIB

The DS1 Fractional Group consists of the DS1 fractional table. This table (dsx1FracTable) is fully supported by the DSU/CSU and allows channel (time slots) to be mapped between the T1 interface and data port.

RS-232-like MIB (RFC 1317)

The "rs232" object defined by RFC 1317 is supported for the synchronous data port. The RS-232-like MIB consists of one object and five tables, as follows:

- Number of RS-232-like ports
- The General Port Table
- The Asynchronous Port Table
- The Synchronous Port Table
- The Input Signal Table
- The Output Signal Table

The Asynchronous Port table is not supported by the DSU/CSU for the synchronous data port. The following sections provide clarification for objects contained in the RS-232-like MIB when it is not clear how the object definition in MIB is related to the DSU/CSU.

Number of Ports – "rs232Number" Object (rs232 1)

This object contains the number of ports in the RS-232-like general port table. This number is 1 for the Model 3166.

General Port Table, RS-232-like MIB

The general port table contains general configuration objects for the RS-232-like interfaces.

General Port Table – "rs232PortIndex" Object (rs232PortEntry 1)

This object contains a unique value for each port and is used as an index into the general port table (rs232PortTable). The values of the rs232PortIndex object vary between models and are listed below.

The value of rs232PortIndex for the Model 3166 DSU/CSU is:

- 1 – DCE port 1

General Port Table – “rs232PortType” Object (rs232PortEntry 2)

This object is used to identify the port’s hardware type. Only the following values are supported by the DSU/CSU.

- rs422(3) – Used to identify a synchronous data port that is configured as EIA-530A or RS-449.
- V35(5) – Used to identify a synchronous data port that is configured as V.35.

General Port Table – “rs232PortInSigNumber” Object (rs232PortEntry 3)

This object contains the number of input signals contained in the input signal table. This is the number of signals that can be detected. This number is 2 for the synchronous data port.

General Port Table – “rs232PortOutSigNumber” Object (rs232PortEntry 4)

This object contains the number of output signals contained in the output signal table. This is the number of signals that can be asserted. This number is 2 for the synchronous data port.

General Port Table – “rs232PortInSpeed” Object (rs232PortEntry 5)

This object contains the port’s input speed in bits per second. For the DSU/CSU, the rs232PortInSpeed object has the same value as the rs232PortOutSpeed object. The input speed of the synchronous data port is determined by the channel configuration and cannot be changed through this object. Thus, for the synchronous data ports, this object is read-only.

General Port Table – “rs232PortOutSpeed” Object (rs232PortEntry 6)

This object contains the port’s output speed in bits per second. For the DSU/CSU, the rs232PortInSpeed object has the same value as the rs232PortOutSpeed object. The input speed of a synchronous data port is determined by the channel configuration and cannot be changed through this object. Thus, for the synchronous data port, this object is read-only.

Asynchronous Port Table, RS-232-like MIB

The asynchronous port table contains an entry for the COM port when the port is configured for asynchronous operation. For the DSU/CSU, the entries in the table that are counters (rs232AsyncPortEntry 6–8) are used to collect statistics and are not supported.

Asynchronous Port Table, “rs232AsyncPortBits” (rs232AsyncPortEntry 2)

This object specifies the number of bits in a character. Only the following values are supported by the DSU/CSU.

- 7 – 7-bit characters.
- 8 – 8-bit characters.

**Asynchronous Port Table, “rs232AsyncPortStopBits”
(rs232AsyncPortEntry 3)**

This object specifies the number of stop bits supported. Only the following values are supported by the DSU/CSU.

- one(1) – One stop bit.
- two(2) – Two stop bits.
- one-and-half(3) – One and a half stop bits.

Asynchronous Port Table, “rs232AsyncPortParity” (rs232AsyncPortEntry 4)

This object specifies the parity used by the port. Only the following values are supported by the DSU/CSU.

- none(1) – No parity bit.
- odd(2) – Odd parity.
- even(3) – Even parity.

**Asynchronous Port Table, “rs232AsyncPortAutoBaud”
(rs232AsyncPortEntry 5)**

This object specifies the ability to automatically sense the input speed of the port. Only the following value is supported by the DSU/CSU.

- disabled(2) – Autobaud is not supported.

Synchronous Port Table, RS-232-like MIB

The synchronous port table contains an entry for the synchronous data port. For the DSU/CSU, the entries in the table that are counters (rs232SyncPortEntry 3–7) are used to collect statistics and are not supported.

**Synchronous Port Table – “rs232SyncPortClockSource”
(rs232SyncPortEntry 2)**

This object specifies the clock source for the port. Only the following values are supported by the DSU/CSU.

- internal(1) – The port uses an internal clock.
- external(2) – The port uses an external clock.

Input Signal Table, RS-232-like MIB

This table contains entries for the input signals that can be detected by the unit for each of the synchronous data ports.

Input Signal Table – “rs232InSigName” (rs232InSigEntry 2)

This object contains the identification of a hardware input signal. Only the following values are supported by the DSU/CSU.

- rts(1) – Request-To-Send.
- dtr(4) – Data Terminal Ready.

Input Signal Table – “rs232InSigState” (rs232InSigEntry 3)

This object contains the current signal state. Only the following values are supported by the DSU/CSU.

- on(2) – The signal is asserted.
- off(3) – The signal is not asserted.

Input Signal Table – “rs232InSigChanges” (rs232InSigEntry 4)

This object is not supported by the DSU/CSU.

Output Signal Table, RS-232-like MIB

This object contains entries for the output signals that can be asserted by the unit for each of the synchronous data ports.

Output Signal Table – “rs232OutSigName” (rs232OutSigEntry 2)

This object contains the identification of a hardware output signal. Only the following values are supported by the DSU/CSU.

- cts(1) – Clear-To-Send.
- dsr(4) – Data Set Ready.

Output Signal Table – “rs232OutSigState” (rs232OutSigEntry 3)

This object contains the current signal state. Only the following values are supported by the DSU/CSU.

- on(2) – The signal is asserted.
- off(3) – The signal is not asserted.

Output Signal Table – “rs232OutSigChanges” (rs232OutSigEntry 4)

This object is not supported by the DSU/CSU.

Generic-Interface MIB Extensions (RFC 1229)

This generic-interface MIB is an experimental MIB that provides extensions to the generic interface group defined in MIB II. This MIB describes three tables:

- Generic Interface Extension Table
- Generic Interface Test Table
- Generic Receive Address Table

Only the generic interface test table is supported by the DSU/CSU. This table is supported for the network interface only.

Generic Interface Test Table, Generic Interface MIB

The test table provides access to additional tests (loopbacks and pattern tests) that are not in the interface group of MIB II.

Generic Interface Test Table – “ifExtnsTestType” Object (ifExtnsTestEntry 4)

This object is a control variable used to start and stop operator-initiated tests on the interface. It provides the capability to:

- Start/stop the Monitor QRSS test pattern on the network interface.
- Start/stop the Send QRSS/511 test pattern on a synchronous data port.
- Start sending a V.54/FT1 UP/DOWN code to the remote unit for a synchronous data port.
- Start/stop the Monitor QRSS/511 test pattern on a synchronous data port.
- Start/stop the DCLB/DTLB loopback test on a synchronous data port.

The following object identifiers are used to control the tests on the interface.

- noTest – Stops the test in progress on the interface.
- testFullDuplexLoopBack – Initiates a DCLB on the interface. Only supported for the data ports.
- testLoopDTLB – Initiates a DTLB on the interface. Only supported for the data ports.
- testMonQRSS – Initiates a Monitor QRSS test on the interface. Supported for the data ports and the network interface.
- testMon511 – Initiates a Monitor 511 test on the interface. Only supported for the data ports.
- testSendQRSS – Initiates a Send QRSS test on the interface. Only supported for the data ports.
- testSend511 – Initiates a send 511 test on the interface. Only supported for the data ports.

- testSendV54Up – Sends a V54 up code to the remote unit. Only supported for the data ports.
- testSendV54Down – Sends a V54 down code to the remote unit. Only supported for the data ports.
- testSendFT1Up – Sends a FT1 up code to the remote unit. Only supported for the data ports.
- testSendFT1Down – Sends a FT1 down code to the remote unit. Only supported for the data ports.

Where these object identifiers are defined as follows:

- testLoopDTLB – OBJECT IDENTIFIER ::= [wellKnownTests 2]
- testMonQRSS – OBJECT IDENTIFIER ::= [wellKnownTests 3]
- testMon511 – OBJECT IDENTIFIER ::= [wellKnownTests 4]
- testSendQRSS – OBJECT IDENTIFIER ::= [wellKnownTests 5]
- testSend511 – OBJECT IDENTIFIER ::= [wellKnownTests 6]
- testSendV54Up – OBJECT IDENTIFIER ::= [wellKnownTests 7]
- testSendV54Down – OBJECT IDENTIFIER ::= [wellKnownTests 8]
- testSendFT1Up – OBJECT IDENTIFIER ::= [wellKnownTests 9]
- testSendFT1Down – OBJECT IDENTIFIER ::= [wellKnownTests 10]

**Generic Interface Test Table – “ifExtnsTestResult” Object
(ifExtnsTestEntry 5)**

This object contains the result of the most recently requested test. Only the following values are supported by the DSU/CSU.

- none(1) – No test currently active.
- inProgress(3) – A test is currently in progress.
- notSupported(4) – The requested test is not supported.
- unableToRun(5) – The requested test cannot run due to the state of the unit.

**Generic Interface Test Table – “ifExtnsTestCode” Object
(ifExtnsTestEntry 6)**

This object contains a code that contains more specific information on the test result. This object is defined as an object identifier. Only the following values are supported by the DSU/CSU.

- none – No further information is available. Used for the send pattern/code and loopback tests.
- inSyncNoBitErrors – A monitor pattern (QRSS or 511) test has synchronized on the pattern and has not detected any bit errors.
- inSyncWithBitErrors – A monitor pattern (QRSS or 511) test has synchronized on the pattern and has detected bit errors.
- notInSync – A monitor pattern (QRSS or 511) test has not synchronized on the requested pattern.

Where these object identifiers are defined as follows:

- wellKnownCodes – OBJECT IDENTIFIER ::= [ifExtensions 5]
- none – OBJECT IDENTIFIER ::= [wellKnownCodes 1]
- inSyncNoBitErrors – OBJECT IDENTIFIER ::= [wellKnownCodes 2]
- inSyncWithBitErrors – OBJECT IDENTIFIER ::= [wellKnownCodes 3]
- notInSync – OBJECT IDENTIFIER ::= [wellKnownCodes 4]

Enterprise MIB

The variable devConfigAreaCopy under the devConfigAreaCopy group in the common area of the Enterprise MIB is fully supported. This variable allows the entire contents of one configuration area to be copied into another configuration area.

Correlation between Menu Commands and SNMP Objects

Table E-1 provides a correlation between how a function is performed or status is displayed on the front panel and how the same function is accomplished using access to the SNMP database. **SNMP objects** are displayed in bold type while *values* for SNMP objects are displayed in italics.

Table E-1. SNMP MIB to Front Panel Command Cross-Reference (1 of 4)

| Front Panel Command | SNMP MIB Object |
|--|--|
| Stat->DevHS: LOS at NET OOF at NET Yellow at NET AIS at NET EER at NET | Read the dsx1LineStatus object for NET T1 <i>dsx1LossOfSignal</i> <i>dsx1LossOfFrame</i> <i>dsx1RcvFarEnd</i> <i>dsx1RcvAIS</i> <i>dsx1OtherFailure</i> |
| Stat->Perf->Telco->Cur: CurTimer ES UAS SES BES CSS | Read the value in the following objects for NET T1 dsx1TimeElapsed dsx1CurrentES dsx1CurrentUAS dsx1CurrentSES dsx1CurrentBES dsx1CurrentCSS |
| Stat->Perf->Telco->Intvl->Dsply: ES UAS SES BES CSS VldIntvl | Select the interval number with dsx1IntervalNumber . Read the value in the following objects for NET T1 dsx1IntervalES dsx1IntervalUAS dsx1IntervalSES dsx1IntervalBES dsx1IntervalCSS dsx1ValidIntervals |
| Stat->Perf->Telco->24Tot: VldIntvl ES UAS SES BES CSS | Read the value in the following objects for NET T1 dsx1ValidIntervals dsx1TotalES dsx1TotalUAS dsx1TotalSES dsx1TotalBES dsx1TotalCSS |

Table E-1. SNMP MIB to Front Panel Command Cross-Reference (2 of 4)

| Front Panel Command | SNMP MIB Object |
|--|--|
| Stat→Tstat LLB Test Active PLB Test Active RLB Test Active DCLB on Port1 DTLB on Port1 1–8 Test Active QRSS Test Active QRSS on Port1 511 on Port1 Monitoring QRSS Mon QRSS, Port1 Mon511, Port1 | Read: <i>dsx1LineLoop</i> from dsx1LoopbackConfig for Net T1 <i>dsx1PayloadLoop</i> from dsx1LoopbackConfig for Net T1 <i>dsx1PayloadLoop</i> from dsx1LoopbackConfig for Port1 <i>testFullDuplexLoopback</i> from IfExtnsTestType for Port1 <i>testLoopDTLB</i> from IfExtnsTestType for Port 1 <i>dsx1SendOtherTestPattern</i> from dsx1SendCode for Net T1 <i>dsx1SendQRS</i> from dsx1SendCode for Net T1 <i>testSendQRSS</i> from IfExtnsTestType for Port 1 <i>testSend511</i> from IfExtnsTestType for Port 1 <i>testMonQRSS</i> from ifExtnsTestType for Net T1 <i>testMonQRSS</i> from ifExtnsTestType for Port 1 <i>testMon511</i> from ifExtnsTestType for Port 1 |
| Stat→LED→Prtn: DTR CTS RTS | Read: <i>rs232InSigState</i> from rs232InSigName == dtr <i>rs232outSigState</i> from rs232OutSigName == ctr <i>rs232InSigState</i> from rs232InSigName == rts |
| Stat→ID: Ser Mod SRev HRevCCA1 HRevCCA2 | Read the sysDescr object from the System Group |
| Test→Rlpbk→LLBUP | Set dsx1SendCode to <i>dsx1SendLineCode</i> |
| Test→Rlpbk→LLBDN | Set dsx1SendCode to <i>dsx1SendResetCode</i> |
| Test→Rlpbk→54UP→Prt1 | Set IfExtnsTestType for Port 1 to <i>testSendV54Up</i> |
| Test→Rlpbk→54DN→Prt1 | Set IfExtnsTestType for Port 1 to <i>testSendV54Down</i> |
| Test→Rlpbk→FT1UP→Prt1 | Set IfExtnsTestType for Port 1 to <i>testSendFT1UP</i> |
| Test→Rlpbk→FT1DN→Prt1 | Set IfExtnsTestType for Port 1 to <i>testSendFT1Down</i> |
| Test→Lpbk→LLB Test→Lpbk→Abort→LLB | Set dsx1LoopbackConfig for Net T1 to <i>dsx1LineLoop</i> Set dsx1LoopbackConfig for Net T1 to <i>dsx1NoLoop</i> |
| Test→Lpbk→PLB Test→Lpbk→Abort→PLB | Set dsx1LoopbackConfig for Net T1 to <i>dsx1PayloadLoop</i> Set dsx1LoopbackConfig for Net T1 to <i>dsx1NoLoop</i> |
| Test→Lpbk→RLB Test→Lpbk→Abort→RLB | Set dsx1LoopbackConfig for Port1 to <i>dsx1PayloadLoop</i> Set dsx1LoopbackConfig for Port1 to <i>dsx1NoLoop</i> |

Table E-1. SNMP MIB to Front Panel Command Cross-Reference (3 of 4)

| Front Panel Command | SNMP MIB Object |
|---|--|
| Test→Lpbk→DCLB→Prtn Test→Lpbk→Abort→DCLB→Prt1 | Set IfExtnsTestType for Port 1 to <i>testFullDuplexLoopBack</i> Set dsx1LoopbackConfig for Port 1 to <i>noTest</i> |
| Test→Lpbk→DTLB→Prtn Test→Lpbk→Abort→DTLB→Prt1 | Set IfExtnsTestType for Port 1 to <i>testLoopDTLB</i> Set dsx1LoopbackConfig for Port 1 to <i>noTest</i> |
| Test→Ptrns→Send→QRSS→NET Test→Ptrns→Abort→Send→NET | Set dsx1SendCode for Net T1 to <i>dsx1SendQRSS</i> Set dsx1SendCode for Net T1 to <i>dsx1SendNoCode</i> |
| Test→Ptrns→Send→QRSS→Prt1 Test→Ptrns→Abort→Send→Prt1 | Set IfExtnsTestType for Port 1 to <i>testSendQRS</i> Set IfExtnsTestType for Port 1 to <i>noTest</i> |
| Test→Ptrns→Send→1in8 Test→Ptrns→Abort→Send→NET | Set dsx1SendCode for Net T1 to <i>dsx1SendOtherTestPattern</i> Set dsx1SendCode for Net T1 to <i>dsx1SendNoCode</i> |
| Test→Ptrns→Send→511→Prt1 Test→Ptrns→Abort→Send→Prt1 | Set IfExtnsTestType for Port 1 to <i>testSend511</i> Set IfExtnsTestType for Port 1 to <i>noTest</i> |
| Test→Ptrns→Mon→QRSS→NET Test→Ptrns→Abort→Mon→NET | Set ifExtnsTestType for Net T1 to <i>testMonQRSS</i> Set ifExtnsTestType for Net T1 to <i>noTest</i> |
| Test→Ptrns→Mon→QRSS→Prt1 Test→Ptrns→Abort→Mon→Prt1 | Set ifExtnsTestType for Port 1 to <i>testMonQRSS</i> Set ifExtnsTestType for Port 1 to <i>noTest</i> |
| Test→Ptrns→Mon→511→Prt1 Test→Ptrns→Abort→Mon→Prt1 | Set ifExtnsTestType for Port 1 to <i>testMon511</i> Set ifExtnsTestType for Port 1 to <i>noTest</i> |
| Cnfig→Load Cnfig→Save | Set devConfigAreaCopy to the desired choice (Active to Customer1, etc.) |
| Cnfig→Activ→Edit→Port→Prt1→Port Type | Display rs232PortType for Port 1 to <i>rs422</i> or <i>v35</i> |
| Cnfig→Activ→Edit→Port→Prt1→TxClock | Set/Display rs232SyncPortClockSource for Port 1 to <i>internal</i> or <i>external</i> |
| Cnfig→Activ→Edit→NET→NET Framing | Set/Display dsx1LineType for NET T1 to <i>dsx1ESF</i> or <i>dsx1D4</i> |
| Cnfig→Activ→Edit→NET→NET Coding | Set/Display dsx1LineCoding for NET T1 to <i>dsx1B8ZS</i> or <i>dsx1AMI</i> |
| Cnfig→Activ→Edit→NET→ANSI PRM Cnfig→Activ→Edit→NET→Mgmt Link | Set/Display dsx1Fdl for NET T1 to <i>dsx1Ansi-T1-403</i> or <i>dsx1Att-54016</i> or <i>dsx1other</i> |
| Cnfig→Activ→Edit→Chan→Prt1→Assign To Cnfig→Activ→Edit→Chan→Display | Set/Display dsx1FracNumber and dsx1Fracindex for Net T1 |
| Cnfig→Activ→Edit→Chan→Prt1→Port Rate | Display rs232PortInSpeed or rs232PortOutSpeed for Port 1 |
| Cnfig→Activ→Edit→Gen→Clock Src | Display dsx1TransmitClockSource for NET T1 |

Table E-1. SNMP MIB to Front Panel Command Cross-Reference (4 of 4)

| Front Panel Command | SNMP MIB Object |
|--|--|
| Cnfig->Activ->Edit->User->Com Rate | Set/Display rs232PortInSpeed or rs232PortOutSpeed for COM port |
| Cnfig->Activ->Edit->User->Char Length Cnfig->Activ->Edit->User->MChar Len | Set/Display rs232AyncPortBits for COM port |
| Cnfig->Activ->Edit->User->CParity | Set/Display rs232AyncPortParity for COM port |
| Cnfig->Activ->Edit->User->CStop Bits | Set/Display rs232AyncPortStopBits for COM port |

IP Networking Address Scenario



Overview

This appendix describes a means of configuring 31xx Series devices in an Internet Protocol (IP) network to provide SNMP or Telnet connectivity. Since there are many possible network addressing schemes, this appendix describes an addressing scheme for typical customer network management system (NMS) scenarios. This appendix is not intended to be an IP addressing or routing tutorial, and a basic understanding of IP and 31xx Series devices is assumed.

The following notes apply to these scenarios:

- 31xx devices besides the Model 3166 include:
 - Model 3160 (2-port standalone)
 - Model 3161 (carrier-mounted card used with auxiliary backplane)
 - Model 3162 (2-port standalone)
 - Model 3164 (4-port standalone)
 - Model 3165 (1-port standalone)
- Connections to remote devices may be via EDL (for the Model 3166 and 2-port and 4-port DSU/CSUs) or FDL; however, the FDL is only available on full T1 links (not fractional T1s). Check with the service provider to be sure that the FDL is end-to-end (i.e., not terminated at an intermediate point within the network).
- Interconnected 31xx Series devices automatically pass routing information between them; however, a static route to the subnet(s) must be set in the routing table of the NMS host. This route uses the 31xx Series device connected to the LAN (via the LAN Adapter), or the NMS (via a direct PPP or SLIP connection) as a gateway to the subnet(s). In all instances, the addressing scheme presented works for both the LAN and the direct connections.
- Although routing table entries are maintained automatically by 31xx Series devices, without the need for user configuration, only a maximum of 100 routes is supported for a given device.

- The choice of a host address within a given subnet is completely arbitrary. Choose any legal host address for a given subnet, without regard to the local or remote devices.
- Although the default route (to the NMS) is configurable for all devices, only devices that have a direct external connection to an NMS (via the COM or AUX ports) need a default route set. In the following examples, the default port (COM or AUX) is set in the device connected to the LAN Adapter.

Scenario 1

The first scenario (Figure F-1) is a series of standalone 31xx Series devices daisy-chained together, with remotes connected via the FDL. In this scenario, all 31xx Series devices are on the same subnet (135.18.1.0). The subnet mask for each device is FF.FF.FF.00. A static route is set in the NMS host to subnet 135.18.1.0.

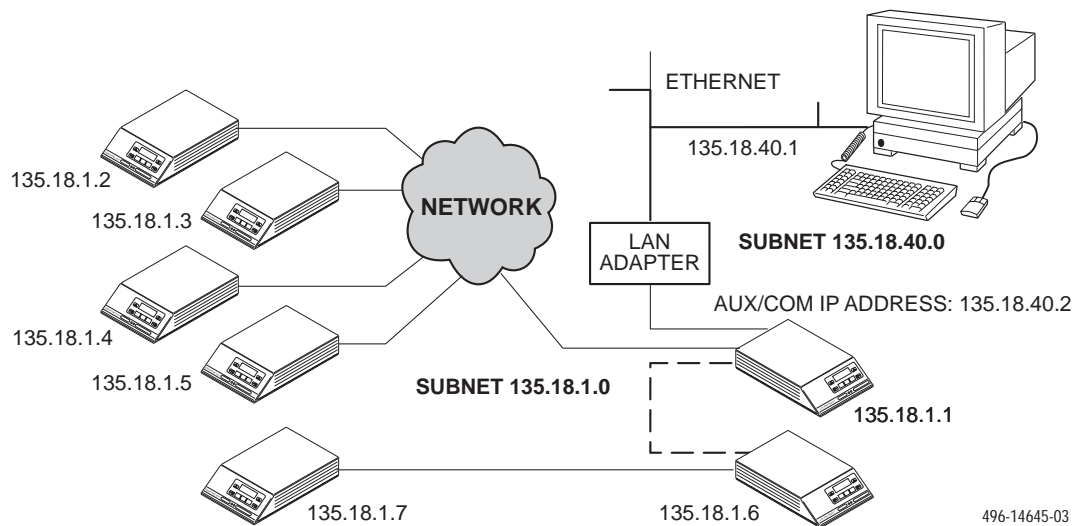

Figure F-1. Daisy-Chained Standalone at the Central Site

Scenario 2

The second scenario (Figure F-2) is a carrier communicating with standalone remotes. This scenario is similar to the previous one, treating the carrier devices as the daisy-chained devices. All devices are still on the same subnet, and the subnet mask is FF.FF.FF.00. A static route still must be set in the NMS host to subnet 135.18.2.0.

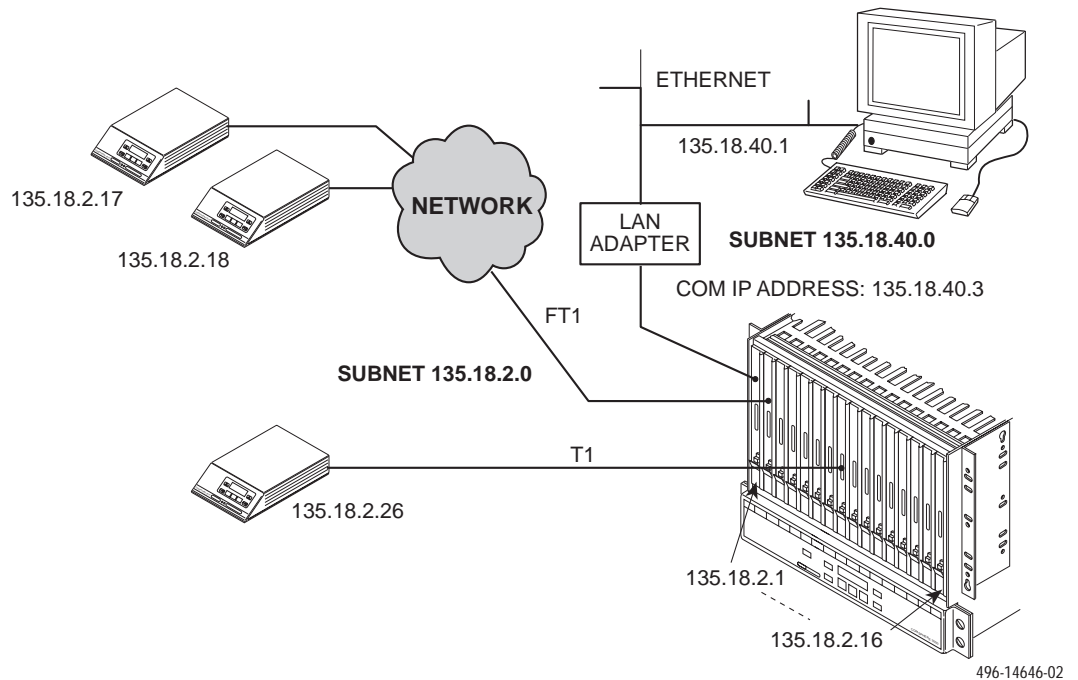

Figure F-2. Local Carrier with Remote Standalone

Scenario 3

This third scenario (Figure F-3) shows a local carrier connected to remote carriers that have remote standalones. Each carrier must be on a separate subnet but, as in the previous scenario, the carrier-remote combination can share a common subnet. Once again, the subnet mask is FF.FF.FF.00 for all devices. A static route must be set up in the NMS host for each subnet: 135.18.4.0, 135.18.6.0, 135.18.20.0.

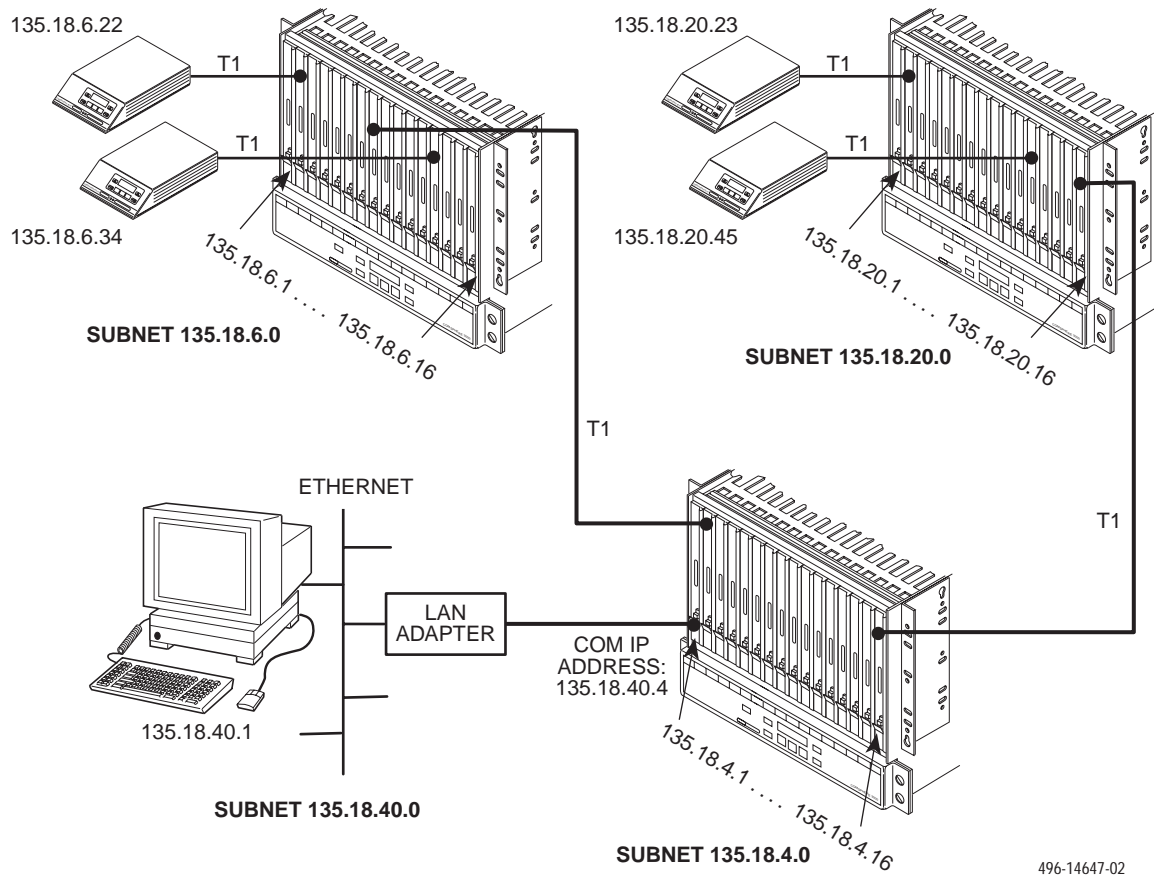
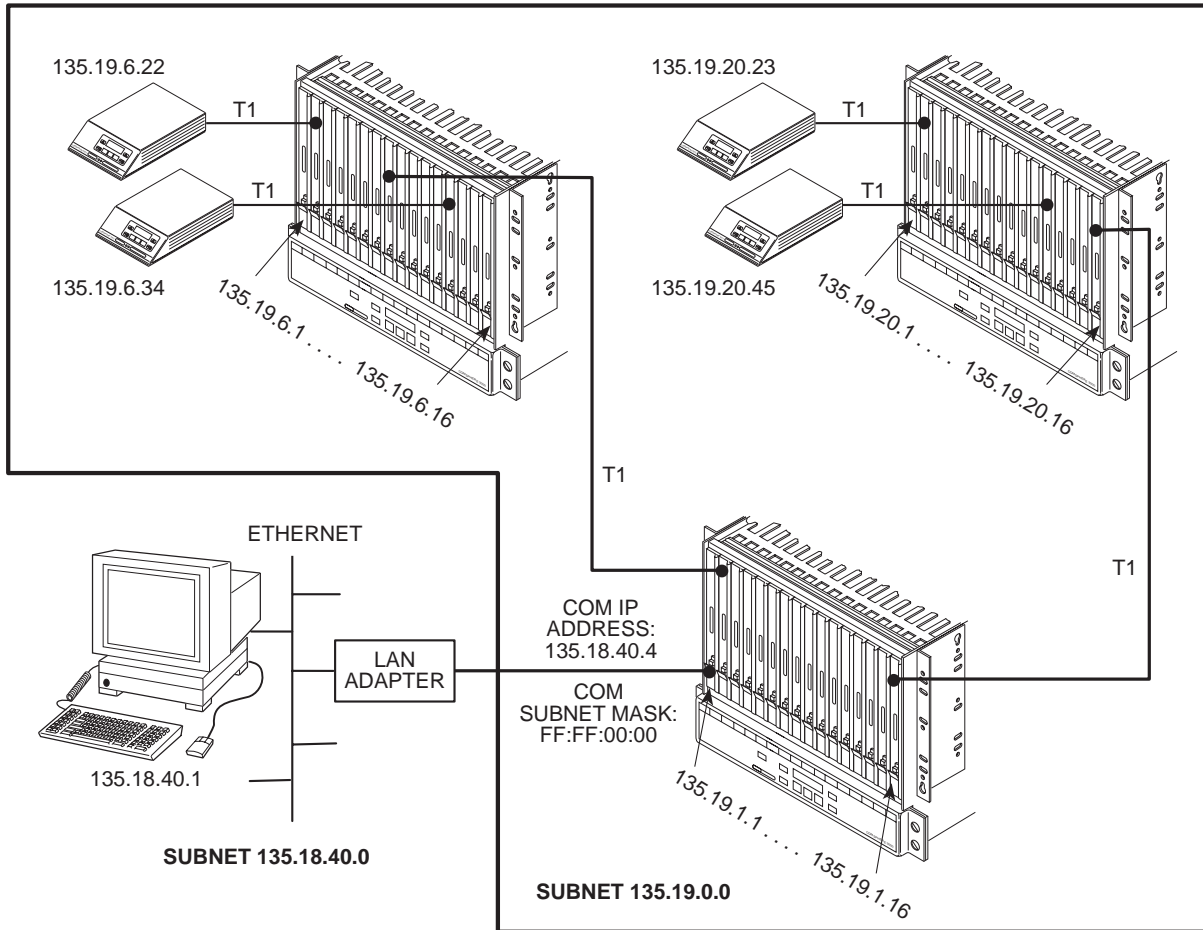

Figure F-3. Local Carrier Connection to Remote Carriers

Scenario 4

An alternative addressing scheme, for the network is shown in **Figure F-4**. This example uses a subnet mask of FF:FF:00:00 for the COM port in the central-site carrier (only), with all of the remaining subnet masks set to FF:FF:FF:00. The advantage to this scheme is that only one route must be added to the NMS host (135.18.0.0).



496-14648-02

Figure F-4. Local Carrier Connected to Remote Carriers – an Alternative

Scenario 5

Figure F-5 illustrates multiple COM ports on the same carrier connected to different NMSs. This might be used in service-provider applications, where some of the carrier's circuit cards (and their remotes) are managed by one NMS and other cards are managed by a different NMS. In this example, each card and remote is on a separate subnet. Also, note that each LAN Adapter connection is on a different subnet. The subnet mask is FF.FF.FF.00. The NMS hosts would only need routes added for the subnets that they are to manage.

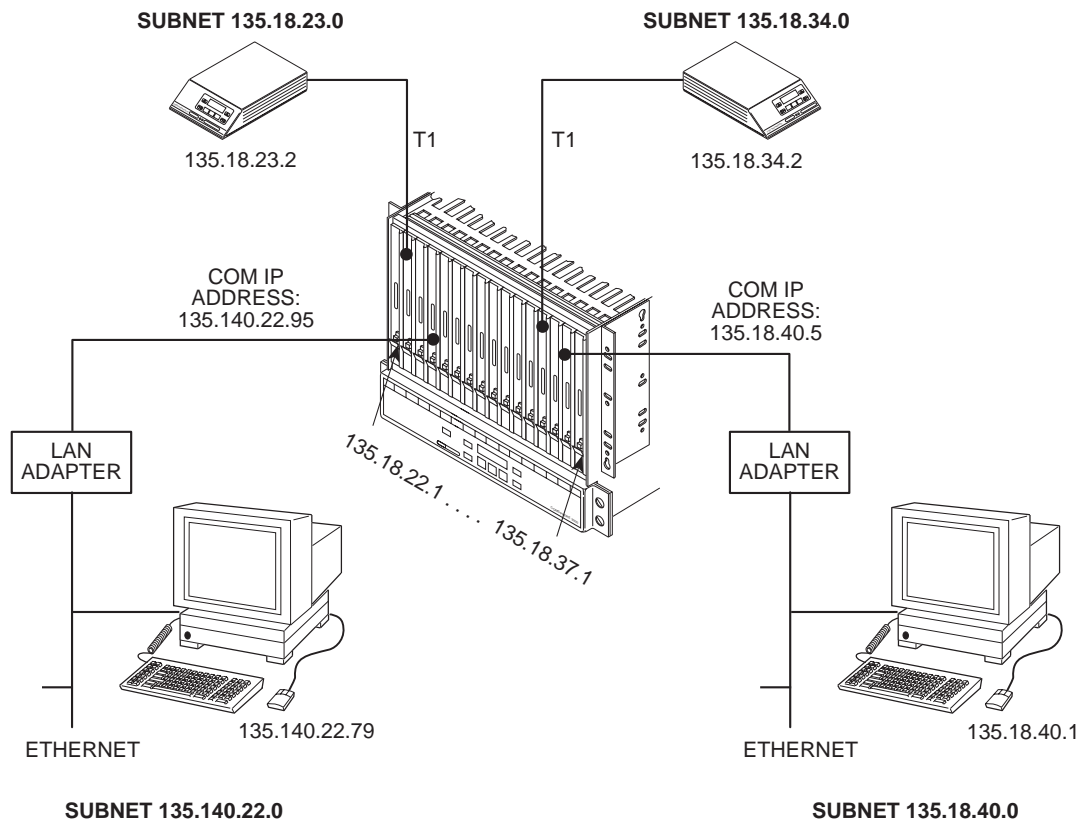

496-14649-02

Figure F-5. Multiple COM Ports Connected to Different NMSs

Front Panel Emulation



Overview

The 3166 DSU/CSU offers functionality through Front Panel Emulation software that is similar to that provided by the SDCP or the front panel of standalone 31xx DSU/CSUs. The 3166 DSU/CSU can either be locally or remotely attached to a 386 or higher PC that has at least 4 MB of RAM. A copy of the 31xx DSU/CSU front panel appears on the PC. The functionality of the front panel is available by clicking on the Function keys with the mouse rather than by pressing keys from the actual front panel.

Installing Front Panel Emulation Software

The Front Panel Emulation software is supplied on a 3.5-inch diskette.

This software must be installed on a 386 or higher PC with Microsoft Windows Release 3.1 or higher, MS-DOS 3.3 or higher, and at least 4 MB of RAM. A VGA color monitor with VGA adapter (or higher resolution) is required. A mouse is also required. The following procedures must be performed in the Windows environment.

► Procedure

To install Front Panel Emulation software:

1. Insert the diskette into the appropriate drive.
2. Select File→ Run from Program Manager menu (Windows 3.x) or Run... from the Start menu (Windows 95 or above)
3. Type **A:INSTALL** and click OK.

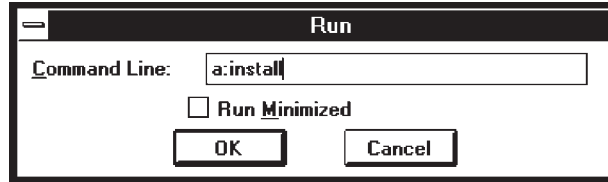

4. An Information screen appears. Choose Continue to continue the installation.
5. Type the letter of the destination drive, followed by a colon (default is C:), then the appropriate directory name (default is C:\FRONTPAN).
If the selected directory already exists, the following message appears: **The specified directory already exists. Do you want to overwrite the directory?**
If the selected directory is new, the following message appears: **The specified directory does not exist. Do you want to create the directory?**
6. Select Yes. A confirmation screen appears. Select Install to continue the installation.
7. A Setup Completed screen appears. Select Continue. The Program Manager or desktop screen appears with the Front Panel icon.

Starting Front Panel Emulation

If the DSU/CSU selected is not locally attached to the PC, you must first dial to the remote DSU/CSU before starting front panel emulation. The modem attached to the PC must support AT commands for the Front Panel Emulation software to successfully place the call.

► Procedure

To start front panel emulation:

1. From the PC, open Program Manager from Windows.
2. Double-click on the Front Panel icon that appears after the Front Panel Emulation program is installed on the PC. The Front Panel window opens.

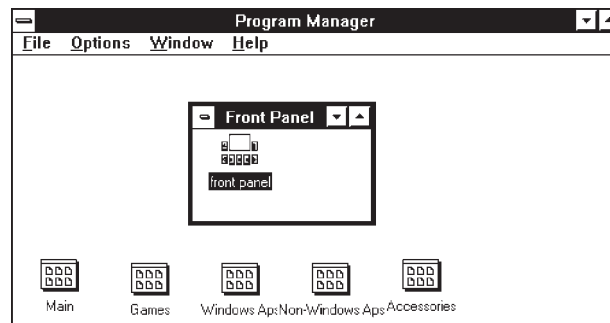

3. Double-click on the Front Panel icon that appears in the Front Panel window. The Front Panel Emulation screen appears.
4. Enter the Com Port and Speed from the drop-down selection list boxes.

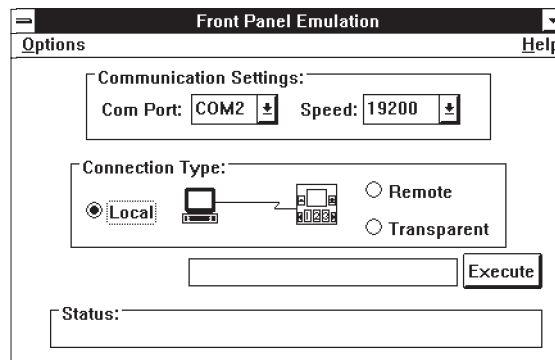

The **Com Port** field needs to contain the actual communications port name as recorded in the Windows information file (INI).

The **Speed** field needs to contain one of the following communications speeds: 1200, 2400, 4800, 9600, 14400, or 19200 and should match the DSU/CSU's COM port configuration.

5. Choose either a Local (for near-end DSU/CSU) or Remote (for far-end DSU/CSU) destination.

6. If you chose a Local destination, click on the **Execute** button. If you chose a Remote destination, enter the telephone number of the far-end DSU/CSU in the **Phone Number** field, then click on the **Dial** button.
7. The front panel of the selected DSU/CSU appears on the PC.

NOTE:

When using Front Panel Emulation, no LEDs are shown on the PC's screen; you must use the Stat command procedure to get LED information (see *Displaying LED Conditions* in Chapter 3, *Operation*).

Asynchronous Terminal Interface Operation



Overview

You can configure and manage the 3166 DSU/CSU from an asynchronous terminal that is configured for **9.6 kbps, 8 characters, no parity, and 1 stop bit**.

This appendix provides operational examples to help you become familiar with the use of the Asynchronous Terminal Interface (ATI) for DSU/CSU control.

Before Using the ATI

You can connect an asynchronous terminal directly to the COM port of the DSU/CSU, or you can establish a remote connection using dial-in (via the integral modem) or Telnet access.

Before using the ATI, you may use the SDCP to set certain configuration options for ATI operation. Use the Configuration (Cnfig) branch of the SDCP menu and edit the User Interface (User) configuration options for ATI operation. Refer to *Changing Configuration Options* in Chapter 3, *Operation*, and Appendix C, *Configuration Options*.

To connect the ATI to the DSU/CSU using Telnet access, refer to *Configuring the DSU/CSU for SNMP or Telnet Access* in Chapter 3, *Operation*.

Resetting the ATI

If the DSU/CSU is misconfigured, leaving it in a state that does not support asynchronous terminal operation, the recovery procedure consists of power cycling the DSU/CSU, waiting for the completion of the power-up self-test, and then pressing the asynchronous terminal's Enter key five times in succession. (Begin pressing the Enter key within two seconds after the completion of power-up self-test, and do not wait longer than one second between each successive key press.) This procedure allows you to use the System Paused screen to reset the COM port configuration options or to reload all factory default configuration options.

Initiating an ATI Session

Once the appropriate configuration option changes have been made and access is established, the Main Menu screen appears (unless a password is required).

Figure H-1 shows the Main Menu screen.

The DSU/CSU shows the 3000 Series carrier slot number under the Customer ID. The slot number field (e.g., **Slot: 1**) is changed to access specific DSU/CSUs in the carrier. For Telnet or SNMP access to the carrier, specify the IP address of the applicable communication port (see Appendix F, *IP Network Addressing Scenarios*).

If a password is required, the Login screen displays the prompt for password input. (Refer to *Entering a Password to Gain Access* on page H-13.)

To move between the Screen area and the Screen Function Keys area (Figure H-1), press Ctrl-a (control key and a).

From the Screen area, you may select the **Status, Test, Configuration, or Control** branches.

Ending an ATI Session

To end the ATI session from any screen, press Ctrl-a to move from the Screen area to the Screen Function Keys area (Figure H-1), and then select **Exit**.

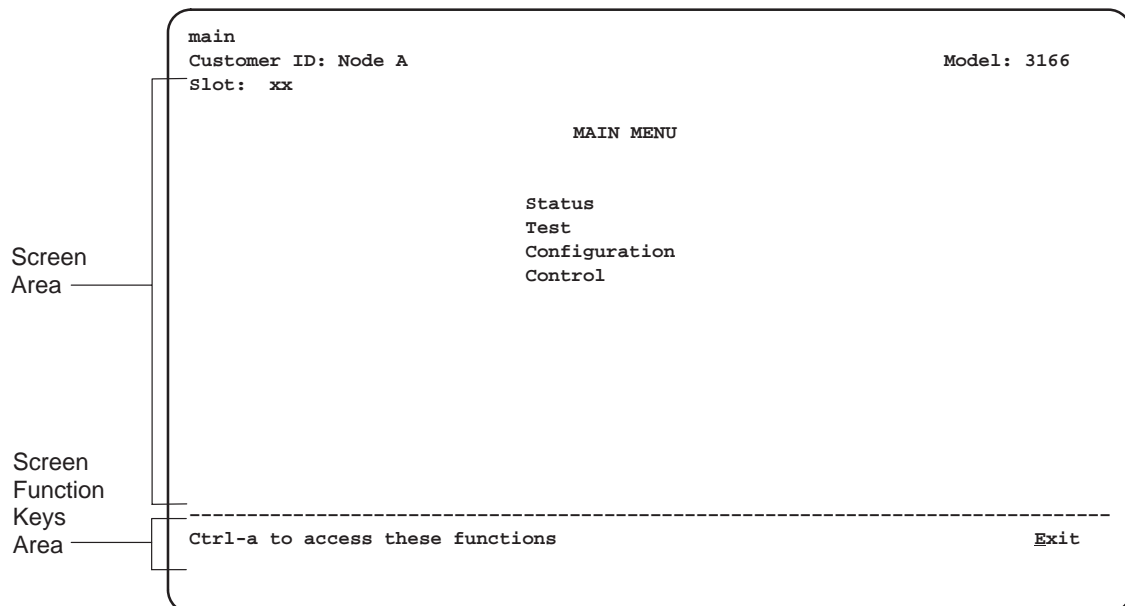
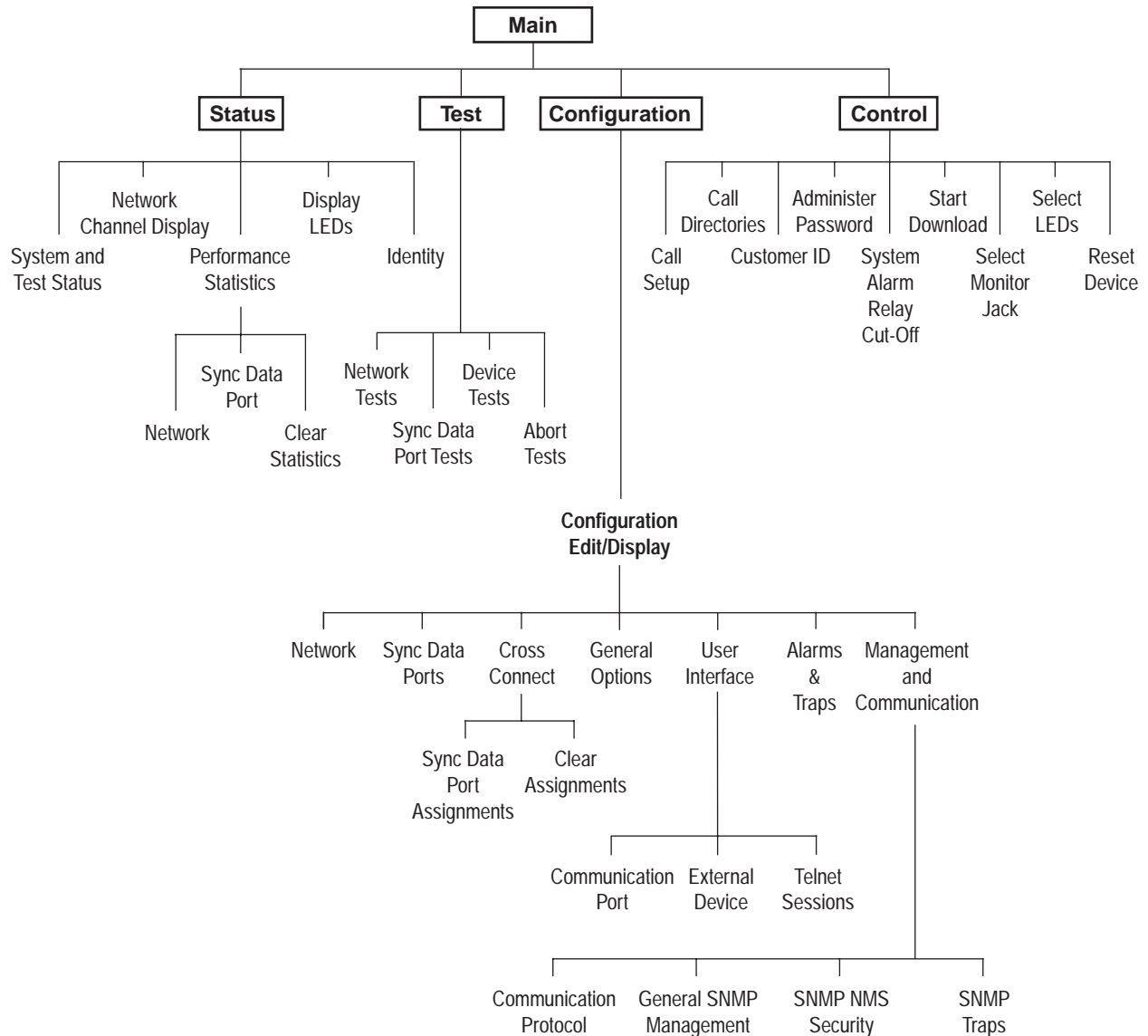

Figure H-1. Main Menu Screen

Menu Organization

ATI menus differ from SDCP menus in that they typically do not use abbreviations and, in some cases, provide a more direct access to an option or function.

Figure H-2 shows the organization of the ATI menu tree.



98-16097

Figure H-2. Menu Organization

Using ATI Screens

- There are three types of ATI screens.
- Menu screens list selections available through the menu system.
- Input screens allow you to edit or change information on a screen using screen function keys (Table H-1) or keyboard keys (Table H-2).
- Display screens show the results from a data collection operation or they display device-specific information.

The ATI supports character matching for entering values in fields. For example, if the values for a field can be **NET** or **PORT** and you enter a 'P' and press Return (Enter), then the value **PORT** automatically appears in the field.

Once an operation is initiated, status messages appear in the last row of the screen. These include **Please Wait** (when a command takes longer than five seconds) and **Command Complete**.

Table H-1. Screen Function Keys

| Screen Function Key | Usage |
|----------------------------|---|
| M (<u>M</u> ainMenu) | Returns to the Main Menu screen. |
| E (<u>E</u> xit) | Terminates the ATI session. |
| R (<u>R</u> efresh) | Updates the screen with the current information. |
| U (P <u>g</u> U <u>p</u>) | Pages up to the previously displayed page of information. |
| D (P <u>g</u> D <u>n</u>) | Pages down to the previously displayed page of information. |
| S (<u>S</u> ave) | Stores changes in nonvolatile memory. |

Table H-2. Keyboard Keys

| Keyboard Key | Usage |
|----------------------------|---|
| Ctrl-a | Moves the cursor between the Screen area and the Screen Function Keys area. |
| Esc | Returns to the previous screen. |
| Tab | Moves the cursor to the next field. |
| Back (Shift) Tab or Ctrl-k | Moves the cursor to the previous field. |
| Backspace | Moves the cursor one position to the left or to the last character of the previous field. |
| Spacebar | Selects the next valid value for the field. |
| Delete | Deletes the character that the cursor is on. |
| Up Arrow key or Ctrl-u | Moves the cursor up one field within a column on the same screen. |
| Down Arrow key or Ctrl-d | Moves the cursor down one field within a column on the same screen. |
| Right Arrow key or Ctrl-f | Moves the cursor back one character to the right. |
| Left Arrow key or Ctrl-b | Moves the cursor back one character to the left. |
| Ctrl-l | Redraws the screen display. |
| Return (Enter) | Accepts entry. |

NOTES:

- Some Telnet applications may require the use of Ctrl-u, Ctrl-d, Ctrl-f, and Ctrl-b as an alternative to the use of the Up, Down, Right, and Left Arrow keys.
- The following procedures are examples only. This appendix uses examples to help you become familiar with the use of the ATI for DSU/CSU control.

Setting Customer Identification

The customer identification is used to uniquely identify the DSU/CSU.

► Procedure

To change the customer identification (Customer ID):

1. From the Main Menu screen, select Control.
The Control screen appears.
2. From the Control screen, select Customer ID.
The Customer ID screen appears (Figure H-3).
3. Use the Customer ID field to set the customer identification.
The customer identification may be up to 8 characters long.
Select Clear to remove all the characters in the associated field.
4. Select Save to store the information in nonvolatile memory.

In addition to the customer identification, you may also enter a system name, system location, and system contact. Although only 40 characters are displayed for these fields, you may enter up to 255 characters. The fields scroll as the additional characters are added.

Customer Identification Field

```

main/control/customer id
Customer ID: Node A
Slot: xx
Model: 3166

CUSTOMER ID

Customer ID: _____ Clear
System Name: _____ Clear
System Location: _____ Clear
System Contact: _____ Clear

-----
Ctrl-a to access these functions, ESC for previous menu
Save MainMenu Exit

```

Figure H-3. Customer Identification Screen

Displaying LED Conditions

The same conditions monitored by the front panel LEDs can also be monitored by the Display LEDs screen. This screen is most useful when the DSU/CSU is being accessed remotely.

► Procedure

To display LED conditions:

1. From the Main Menu screen, select Status.
The Status screen appears.
2. From the Status screen, select Display LEDs.
The Display LEDs screen appears (Figure H-4).

The screen shows a snapshot of the LEDs every 5 seconds. LEDs that are illuminated are displayed by inverse video.

Select Refresh to update the screen.

```

main/status/leds
Customer ID: Node A
Slot: xx
Model: 3166

                DISPLAY LEDs

                GENERAL      NETWORK      PORT 1

                OK           Sig          DTR
                Fail         OOF          TXD
                Test         Alm          RXD
                               EER          CTS
                               RT          RTS

-----
Ctrl-a to access these functions, ESC for previous menu
Refresh                               MainMenu Exit

```

Figure H-4. Example of Display LEDs Screen

Changing Configuration Options

Use the Configuration branch of the main menu to display or change DSU/CSU configuration options. Refer to *Changing Configuration Options* in Chapter 3, *Operation*, and Appendix C, *Configuration Options*.

If the access level is not Level 1, the message **Access level is 2, Configuration is read-only** is displayed on line 24.

Displaying or Editing Configuration Options

► Procedure

To display or edit configuration options:

1. From the Main Menu screen, select Configuration.
The Load Configuration From screen appears (Figure H-5).

```
main/config
Customer ID: Node A
Slot: xx
Model: 3166

LOAD CONFIGURATION FROM:

Current Configuration
Customer Configuration 1
Customer Configuration 2
Default Factory Configuration 1
Default Factory Configuration 2

-----
Ctrl-a to access these functions, ESC for previous menu      MainMenu  Exit
```

Figure H-5. Configuration Load Screen

2. From the Load Configuration From screen, select a configuration option set to load (**Current**, **Customer 1**, **Customer 2**, **Default Factory 1**, or **Default Factory 2**). You cannot edit the Default Factory configuration options, but you can display them.

After selecting the set of configuration options to load, the Configuration Edit/Display screen appears (Figure H-6).

```
main/config/edit
Customer ID: Node A
Slot: xx
Model: 3166

CONFIGURATION EDIT/DISPLAY

Network
Sync Data Port
Cross Connect
General Options
User Interface
Alarms & Traps
Management and Communication

-----
Ctrl-a to access these functions, ESC for previous menu
Save
MainMenu Exit
```

Figure H-6. Configuration Edit/Display Screen

3. Select a functional group to display or edit.

NOTE:

Screen displays may vary depending on the model and configuration of the DSU/CSU. For example, DTE and Copy Ports are not displayed for the single-port DSU/CSU.

Saving Edit Changes

► Procedure

To save edit changes:

1. From the last edit screen, select Save.
The Save Configuration To screen appears (Figure H-7).
2. From the Save Configuration To screen, select a configuration option set (**C**urrent, **C**ustomer 1, or **C**ustomer 2).

Save edit changes to the Current area when you want those changes to take effect immediately. Save edit changes to the Customer area when you want to overwrite the existing Customer configuration options and store these changes for future use.

To protect you from accidentally exiting an edit session before saving your changes, the system displays the **Save Changes?** field if you select either **M**ainMenu or **E**xit from an edit screen. If you respond **N**o, the system exits without saving the changes. If you respond **Y**es, you are prompted to specify where the changes should be saved.

```
main/config/save
Customer ID: Node A                               Model: 3166
Slot: xx

                                SAVE CONFIGURATION TO:

                                Current Configuration
                                Customer Configuration 1
                                Customer Configuration 2

-----
Ctrl-a to access these functions, ESC for previous menu      MainMenu  Exit
```

Figure H-7. Configuration Save Screen

Establishing Access Security on a Port

Although the password feature is available, it is not required. If used, it ensures access security before control is passed to a device connected to a port. The following procedure is an example only. It shows how to enable the password for the communication port. Passwords can also be enabled for the internal modem and for Telnet sessions.

► Procedure

To establish access security on the communication port:

1. From the Main Menu screen, select Configuration.
The Load Configuration From screen appears.
2. From the Load Configuration From screen, select Current.
The Configuration Edit/Display screen appears.
3. From the Configuration Edit/Display screen, select User Interface.
The User Interface Options screen appears.
4. From the User Interface Options screen, select Communication Port.
The Communication Port Options screen appears.
5. In the **Password Required** field, enter **Enable** (Figure H-8).
6. Select Save to store this setting in nonvolatile memory.
The Save Configuration To screen appears.
7. From the Save Configuration To screen, select Current.

The password itself is set separately. Refer to the following section, *Setting a Password*.

```

main/config/user/com
Customer ID: Node A                               Model: 3166
Slot: xx

                                COMMUNICATION PORT OPTIONS

Port Use:                               Terminal
Port Type:                               Asynchronous
Data Rate (Kbps):                        9.6
Character Length:                         8
Parity:                                   None
Stop Bits:                                1
Ignore Control Leads:                     Disable

Password Required:                         Enable
Inactivity Timeout:                        Enable
Disconnect Time (Minutes):                 5

-----
Ctrl-a to access these functions, ESC for previous menu   MainMenu Exit
Save
  
```

Enable Password

Figure H-8. Enabling a Password

Setting a Password

In addition to establishing access security on a port (refer to the previous section, *Establishing Access Security on a Port*), the password itself is set. Unless you specify otherwise, the password is null.

► Procedure

To set a password:

1. From the Main Menu screen, select Control.
The Control screen appears.
2. From the Control screen, select Administer Password.
The Password Entry screen appears (Figure H-9).
This screen is used to add a new password or modify an existing password.
3. Enter a new password in the **Password** field.
The password may be 1 to 8 characters long and may contain the characters **0** through **9**, **a** through **z**, and/or **A** through **Z**.
4. Use the **Re-Enter Password** field to verify the new password.
5. Select Save.

Once a password is saved, the **Login Records Saved** message appears at the bottom of the screen.

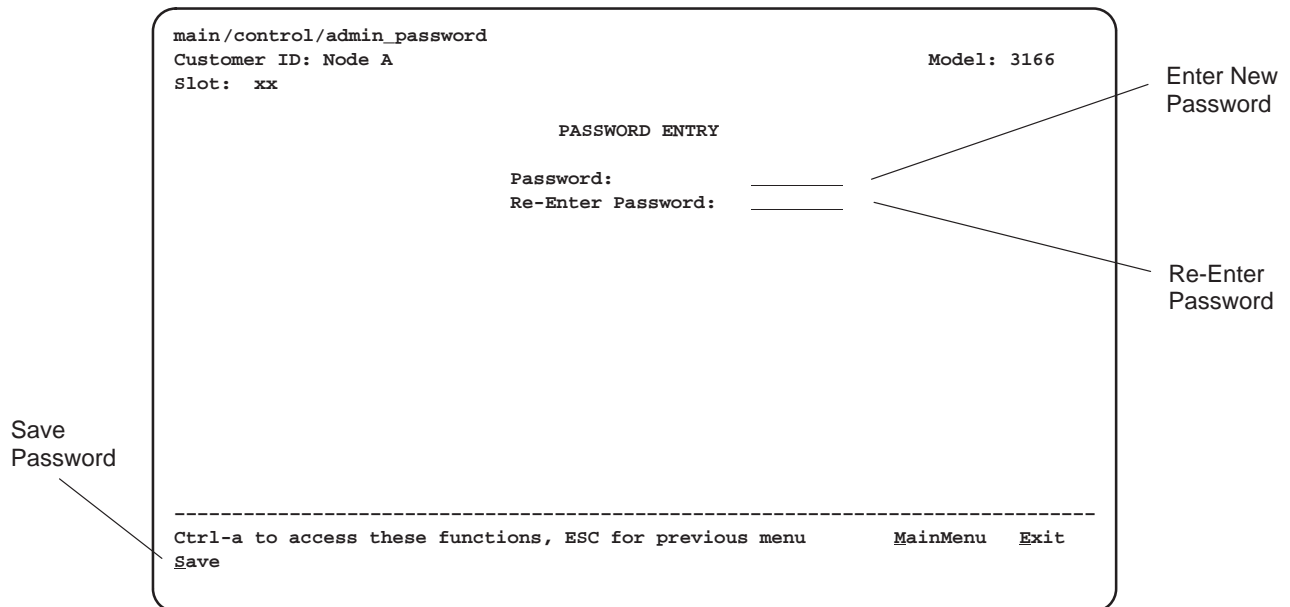

Figure H-9. Setting a Password

Entering a Password to Gain Access

When access security is required, the Login screen (Figure H-10) appears before you can access the Main Menu screen. The password must be entered.

- *If the password is valid*, the DSU/CSU's top-level menu appears.
- *If the password is invalid*, an invalid password message appears and the screen reappears and waits for password entry.
- *If an invalid password is entered three consecutive times*, the message **User Interface Idle** appears, Telnet sessions are closed, dial-in connections are disconnected, and an SNMP trap is generated.

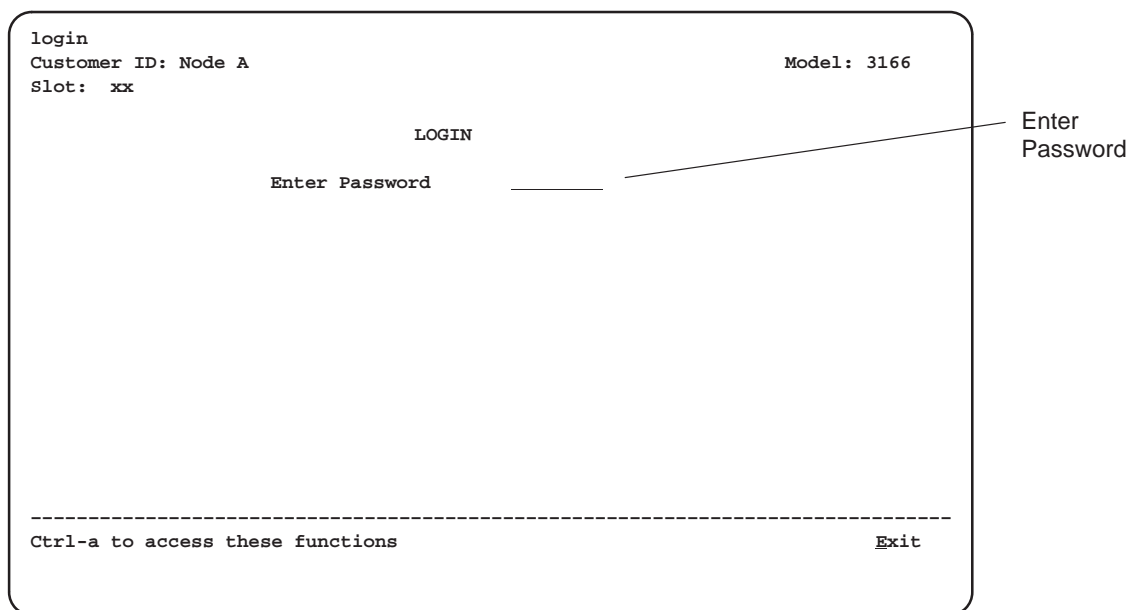

Figure H-10. Entering a Password

Equipment List



| Equipment | Feature Number |
|--|-----------------------|
| Model 3166 DSU/CSU | 3166-B3-010 |
| Front Panel Emulation Software | 3100-C1-010 |
| T1 Line Interface Cable, RJ48C-to-RJ48C (20 ft) | 3100-F1-500 |
| T1 Line Interface Cable, RJ48C-to-DA15P (Canada) (15 m) | 3100-F1-510 |
| COM Port-to-Terminal/Printer Cable, 8-pin modular to DB25P (14 ft) | 3100-F1-540 |
| COM Port-to-PC Cable, 8-pin modular to DB9S (14 ft) | 3100-F1-550 |
| EIA-530-A-to-V.35 Adapter | 3100-F1-570 |
| EIA-530-A-to-X.21 Adapter Cable | 3100-F1-571 |
| EIA-530-A-to-RS449/422 Adapter | 3100-F1-580 |
| Diagnostic Channel Extension Cable (1 ft) | 3100-F1-910 |
| COM Port-to-Modem Cable | 9008-F1-550 |

Glossary

| | |
|-----------------------------------|---|
| 1in8 Test | A test pattern consisting of a one (1) followed by seven zeros (on the network only). |
| 3000 Series Carrier | A rack-mounted device containing 17 slots in which to place circuit cards. |
| ACAMI allocation method | Alternate Channel Alternate Mark Inversion. A method of allocating DS0 channels as a group, so that every alternate DS0 channel does not carry data, but instead transmits and receives all ones. |
| ACCULINK | A product family and a registered trademark of Paradyne. |
| ACO | Alarm Cut-off command. A command for carrier-mounted DSU/CSUs that forces a deactivation of the alarm relay on the 3000 Series Carrier. |
| Activ | Active configuration area. The configuration option set that is currently active for the device. Before a configuration option set becomes active, you must save the set to the Active configuration area. |
| adapter | Hardware that provides some transitional function between two or more devices. |
| address | A symbol (usually numeric) that identifies the interface attached to a network. |
| agent (SNMP) | A software program housed within a device to provide SNMP functionality. Each agent stores management information and responds to the manager's request for this information. |
| aggregate | A single bit stream that combines two or more bit streams. |
| AIS | Alarm Indication Signal. An all ones signal transmitted to maintain transmission continuity and to indicate to the receiving terminal that a transmission fault exists at either the transmitting terminal or upstream of the transmitting signal. Sometimes referred to as Blue Alarm. |
| AMI | Alternate Mark Inversion. A line coding technique used to accommodate the ones density requirements of E1 or T1 lines. |
| ANSI | American National Standards Institute. A member of ISO, ANSI accredits and implements standards. |
| application | The use to which a device is put. |
| ASCII | American Standard Code for Information Interchange. The standard for data transmission over telephone lines. A 7-bit code establishes compatibility between data services. The ASCII code consists of 32 control characters (nondisplayed) and 96 displayed characters. |
| ASCII terminal/printer | A device that can be attached, either locally or remotely, to a DSU/CSU to display or print alarm messages. |
| asynchronous data | Data that is formatted so it is synchronized by a transmission start bit at the beginning of a character and one or more stop bits at the end. |
| authenticationFailure trap | An SNMP trap that indicates that the device has received an SNMP protocol message that has not been properly authenticated. |
| AUX port | The auxiliary communications port on the DSU/CSU. |

| | |
|--------------------------------|---|
| Auxiliary Backplane | An 8-slot backplane that fit over one half of the open section of the 3000 Series Carrier. This is a passive assembly that provides interconnection capability between 3151 CSUs and 3161 DSU/CSUs and provides all interface connectors. |
| AWG | American Wire Gauge. An indication of wire size. The heavier the gauge, the lower the AWG number, and the lower the impedance. |
| B8ZS | Bipolar 8 Zero Substitution. Encoding scheme for transmitting clear channel signals over a T1 line. |
| backup capability | The ability to reconfigure the DSU/CSU and restore data circuits through an external backup device. |
| bandwidth | The range of frequencies that can be passed by a transmission medium, or the range of electrical frequencies a device is capable of handling. |
| BES | Bursty Error Seconds. A second in which more than one but less than 320 CRC6 error events have occurred. |
| bipolar signal | A signal in which successive ones (marks, pulses) are of alternating positive and negative polarity, and in which a zero (space, no pulse) is of zero amplitude. |
| bit | Binary digit. The smallest unit of information, representing a choice between a one or a zero (sometimes called mark or space). |
| bit stuffing | The insertion of ones into the outgoing bit stream to enforce ones density requirements. |
| block allocation method | A method of allocating digital signal level 0 (DS0) channels as a group rather than individually. |
| bps | Bits per second. Indicates the speed at which bits are transmitted across a data connection. |
| BPV | Bipolar Violation. In a bipolar signal, a one (mark, pulse) which has the same polarity as its predecessor. |
| byte | A sequence of successive bits (usually eight) handled as a unit in data transmission. |
| CCITT | Consultative Committee on International Telegraphy and Telephony. An advisory committee established by the United Nations to recommend communications standards and policies. It was renamed ITU in March 1993. |
| CD | Carrier Detect. The received line signal detector. V.24 circuit 109. |
| channel | A bidirectional DS0, voice, or data path, for electrical transmission between two or more points. Also called a circuit, line, link, path, or facility. |
| channel allocation | Assigning specific DS0 channels in the device to specific interfaces (Network, DTE Drop/Insert, etc.). |
| CHAP | Challenge Handshake Authentication Protocol. A security technique that allows a user password to be encrypted for transmission. |
| character | A letter, figure, number, punctuation, or other symbol. |
| CID branch | Customer Identification branch or the DSU/CSU menu tree. |
| client | A device that receives a specific service, such as database management, from a server. |
| CLOCK IN interface | The external clock interface on the DSU/CSU. |
| ClrReg branch | Clear Performance Registers branch of the DSU/CSU menu tree. |
| Cnfig branch | Configuration branch of the DSU/CSU menu tree. |
| coding | A technique used to accommodate the ones density requirements of E1 lines. |

| | |
|-----------------------------|--|
| COM port | Communications port. A computer's serial communications port used to transmit to and receive data from a modem. The modem connects directly to this port. |
| community name | An identification used by an SNMP manager to grant an SNMP server access rights to a MIB. |
| COMSPHERE | A proprietary product family name and a registered trademark of Paradyne. |
| configuration | The arrangement of a system or network as defined by the characteristics of its functional units. |
| configuration option | Device software that sets specific operating parameters for the device. Sometimes referred to as straps. |
| CPU fail | Central Processing Unit failure. A Self-Test Health message indicating a failure in the device's central processing unit. |
| CRC | Cyclic Redundancy Check. A mathematical method of confirming the integrity of received digital data. |
| CRC6 | CRC using six check bits. |
| CSA | Canadian Standards Association. |
| CSU | Channel Service Unit. A device that connects service user equipment such as a DSU to the local digital telephone loop, protects the line from damage, and regenerates the signal. |
| Ctrl branch | Control branch of the DSU/CSU menu tree. |
| CTS | Clear To Send. A signal indicating that the device is ready for the DTE to transmit data. Usually occurs in response to Request To Send (RTS). |
| Cust1 | Customer 1 configuration area. The first of two sets of customer-defined configuration options. |
| Cust2 | Customer 2 configuration area. The second of two sets of customer-defined configuration options. |
| daisy chaining | Connecting the COM port of one device to the AUX port of another device to provide SNMP connectivity. |
| data port | The electrical interface between the device and the synchronous data terminal equipment. |
| database | An organized compilation of computerized data. |
| DB15 connector | A 15-position connector used on cables or devices. |
| DB25 connector | A 25-position connector used on cables or devices. |
| DCE | Data Communications Equipment. The equipment that provides the functions required to establish, maintain, and end a connection. It also provides the signal conversion required for communication between the DTE and the network. |
| DCLB | Data Channel LoopBack. Loops the data received from the network interface, for all DS0 channels allocated to the selected port, back to the network. |
| default | A factory-preset value that is assumed to be correct unless changed by the user. |
| DevFail | Device Failure. A message that indicates that an internal failure has been detected by the operating firmware. An 8-digit code appears for use by service personnel. |
| DevHS branch | Device Health and Status branch of the DSU/CSU menu tree. |
| device | A mechanical, electrical, or electronic unit with a special purpose. |
| digital signal | A signal composed of only two discrete values, representing the binary digits 0 and 1. |

| | |
|---------------------------------|--|
| diskette | A thin, flexible magnetic disk enclosed in a protective jacket. |
| DL branch | Download branch of the DSU/CSU menu tree. |
| download | A process that transfers device firmware and software from a locally-attached PC to a device, or allows the duplication of firmware and software from a local device to a remote device. |
| downstream device | A device that is connected farther from the host computer. |
| DSR | Data Set Ready. A signal from the modem to the DTE that indicates the modem is turned ON and connected to the DTE. |
| DSU | Data Service Unit. Data communications equipment that provides timing, signal regeneration, and an interface to data terminal equipment. A subrate DSU/CSU is normally referred to as a DSU. |
| DSX-1 | Digital Signal Cross Connect level 1. An interconnection point for terminals, multiplexers and transmission facilities. |
| DS0 | Digital Signal Level 0. A 64 kbps standard signal or channel. |
| DS0 channel allocation | Assigning specific DS0 channels in the DSU/CSU to specific interfaces (network, DTE Drop/Insert, etc.). |
| DS1 | Digital Signal level 1. A signal of 1.544 Mbps in North America. |
| DS1/E1 MIB | Defines objects for managing the network and DTE Drop/Insert interfaces on the DSU/CSU. |
| DTE | Data Terminal Equipment. The equipment, such as a computer or terminal, that provides data in the form of digital signals for transmission. |
| DTLB | Data Terminal Loopback. Loopback mode that loops the data for a particular synchronous data port back to the port just before it is combined with the rest of the T1 data stream. |
| DTMF | Dual-Tone Multi-Frequency. A signaling method using two voice frequencies to designate the tones used for touch-tone dialing, as distinguished from pulse dialing. |
| DTR | Data Terminal Ready. A signal from the DTE to the modem, sent via Pin 20 of the EIA-232 interface (V.24 circuit 108/1, /2), that indicates the DTE is turned ON and connected to the modem. |
| D4 | The transmission standard that specifies 12 frames as a superframe that is used for frame synchronization and to locate signaling bits. |
| E1 | A wideband digital interface operating at 2.048 Mbps, defined by ITU recommendations G.703 and G.704. It is used primarily outside North America. |
| EDL | Embedded Data Link. The 8 kbps in-band performance channel that provides 4 kbps of user bandwidth for the support of an SNMP management link. |
| EER | Excessive Error Rate. An error rate that is greater than the threshold that has been configured in the device. |
| EIA | Electronic Industries Association. This organization provides standards for the data communications industry to ensure uniformity of interface between DTEs and DCEs. |
| EIA-530-A | An Electronic Industries Association standard for a high-speed, 25-position, DCE/DTE interface. |
| Enterprise MIB | MIB objects unique to a specific company's devices. |
| enterprise-specific trap | A trap unique to a specific company's devices. |

| | |
|--|---|
| EON | End of Number. |
| error | A discrepancy between a measured or computed value or condition and the true or specified value or condition. |
| ES | Errored Seconds. A second with one or more ESF error events (one or more CRC6 error events or OOFs). |
| ESD | ElectroStatic Discharge. An undesirable discharge of static electricity that can damage equipment and degrade electrical circuitry. |
| ESF | Extended SuperFrame. The T1 transmission standard that specifies 24 frames as an extended superframe to be used for frame synchronization and to locate signaling bits. |
| Fact1 | Factory 1 configuration area. The first of two configuration option sets that are preset at the factory (read-only options). |
| Fact2 | Factory 2 configuration area. The second of two configuration option sets that are preset at the factory (read-only options). |
| failure | An uncorrected hardware error. |
| fault | An accidental condition that causes a functional unit to fail to perform its required function. |
| FCC | Federal Communications Commission. The Board of Commissioners that regulates all electrical communications that originate in the United States. |
| FDL | Facility Data Link. The selected framing bits in the ESF format used in a wide-area link that are used for control, monitoring, and testing. |
| fractional E1 | Individual DS0 channels that may be sold separately or in groups to provide bandwidth that is some fraction of the total E1 capability. |
| frame | One identifiable group of bits that includes a sequence of bits for control, framing, etc. |
| frame relay | A high-speed connection-oriented packet switching WAN protocol using variable-length frames. |
| framing | A technique that separates bits into identifiable groups. |
| Generic-Interface Extension MIB | An extension to MIB II that defines additional objects for control of generic interfaces in MIB II. |
| Get command (SNMP) | A command providing read-only access to SNMP MIB objects. |
| ground | A physical connection to earth or other reference point. |
| HDLC | High-Level Data Link Control. A communications protocol defined by the International Standards Organization (ISO). |
| host | A computer attached to a network that shares its information and devices with the rest of the network. |
| Hz | Hertz. A unit of frequency that equals one cycle per second. |
| ICMP | Internet Control Management Protocol. Internet protocol that allows for the generation of error messages, tests packets, and information messages related to IP. |
| ID branch | Identity branch of the DSU/CSU menu tree. |
| interface | A shared boundary between functional units. |
| Internet | The worldwide internetwork, which predominantly uses the TCP/IP protocol. |
| internetwork | An interconnected collection of networks (also called an internet). |

| | |
|----------------------------|--|
| IP address | Internet Protocol address. The address assigned to an internet host. |
| ISO | International Standards Organization. |
| ITU | International Telecommunications Union. The telecommunications agency of the United Nations, established to provide standardized communications procedures and practices. Before March 1993 it was called CCITT. |
| kbps | Kilobits per second. One kilobit is usually taken to be 1,024 bits. |
| LAN | Local Area Network. A privately owned and administered data communications network limited to a small geographic area. |
| LBO | Line Build-Out. The amount of attenuation of the transmitted signal that is used to compensate for the length of wire between the transmitter and the receiver. |
| LCD | Liquid Crystal Display. Thin glass plates containing liquid crystal material. When voltage is applied, the amount of light able to pass through the glass plates is altered so that messages can be displayed. |
| LCP | Link Control Protocol. |
| LED | Light Emitting Diode. A light or status indicator that glows in response to the presence of a certain condition (e.g., an alarm). |
| link layer protocol | The protocol that regulates the communication between two network nodes. |
| link trap | A trap that identifies the condition of the communications interface (linkDown or linkUp traps). |
| LLB | Line LoopBack. A test in which the received signal on the network interface is looped back to the network without change. |
| LOF | Loss of Frame. Occurs when a DS1 terminal is unable to synchronize on the DS1 signal for some interval. |
| LOFC | Loss Of Frame Count. The number of LOFs declared. |
| loopback test | A test that verifies a device's operation by connecting the device's output to the device's input. |
| LOS | Loss of Signal. The T1 line condition where there are no pulses. |
| Lpbk branch | Local Loopback branch of the DSU/CSU menu tree. |
| LQR | Link Quality Reports. |
| manager (SNMP) | The device that queries agents for management information, or receives unsolicited messages (traps) indicating the occurrence of specific events. |
| master clock | The master timing source used to synchronize all of the T1 and data port interfaces on the DSU/CSU. |
| MB | Megabyte or megabytes. A unit of memory measurement equal to approximately one million bytes (typically 1,048,576 bytes). |
| Mbps | Megabits per second. One megabit is 1,048,576 (1024 ²) bits. |
| menu tree | The structure containing the menu hierarchy starting at a Top-Level menu and extending down to various device functions. |
| MIB | Management Information Base. A database of managed objects used by SNMP to provide network management information and device control. |
| MIB II | MIB Release 2. The current Internet-standard MIB, defined by RFC 1213. |

| | |
|-----------------------------|---|
| module | A compact assembly functioning as a component in a larger system or unit. |
| MRU | Maximum Request Unit. |
| network | A configuration of data processing devices used for information exchange. |
| network interface | The T1 network interface connector on the rear panel of the DSU/CSU. |
| NMS | Network Management System. A computer system used for monitoring and controlling network devices. |
| node | A connection or switching point on the network. |
| object (SNMP) | A specific item within a Management Information Base (MIB). |
| OOF | Out Of Frame. An error condition in which frame synchronization bits are in error. |
| option | A hardware or software function that can be selected or enabled as part of a configuration process. |
| PAP | Password Authentication Protocol. A security technique that requires a user password for access to a system. |
| parity | A way of checking data accuracy by counting the number of bits that have a value of one. |
| PBX | Private Branch Exchange. Telephone switching equipment dedicated to one customer. A PBX connects private telephones to each other and to the public dial network. |
| PC | Personal Computer. |
| PDU | Protocol Data Unit. A message containing protocol-specific information. |
| PDV | Pulse Density Violation. The number of ones (marks, pulses) is not adequate for the line requirement. |
| Perf branch | Performance Report branch of the DSU/CSU menu tree. |
| PLB | Payload Loopback. Loopback mode that loops the information received on the T1 network interface back to the network after it has passed through receive and transmit framing section. |
| PORT (1–4) interface | The synchronous data port interface on the DSU/CSU. |
| POWER connector | The power input connector on the DSU/CSU. |
| power-on self-test | A test that checks most hardware components when power is applied to the device or a reset is initiated. |
| PPP | Point-to-Point Protocol. A protocol for packet transmission over serial links, specified by Internet RFC 1661. |
| PRBS | Pseudo-Random Bit Sequence. A test pattern containing any possible combination of digital ones and zeros for a given string length. |
| PRM | Performance Report Messages. Messages indicating the current state of a T1 line as specified by ANSI-T1-403. |
| protocol | A set of rules that determines the behavior of devices in achieving and maintaining communication. |
| PSTN | Public Switched Telephone Network. A network shared among many users who can use telephones to establish connections between two points. Also known as dial network. |
| Ptrns branch | Test Patterns branch of the DSU/CSU menu tree. |

| | |
|---------------------------|--|
| pulse density | A measure of the number of ones (marks, pulses) in relation to the total number of bits transmitted. |
| QRSS | Quasi-Random Signal Source. A test pattern simulating a random pattern of digital ones and zeros used to simulate normal transmission. |
| RAM | Random-Access Memory. Read/write memory that is volatile and loses its contents when power is removed. |
| register | A part of the device's memory that holds stored values. |
| Rel branch | Release branch of the DSU/CSU menu tree. |
| reset | An initialization of the device that occurs at power-up or in response to a reset command. |
| RFC | Request for Comments. One of the documents published by the Internet Engineering Task Force that describe Internet protocols and policies. |
| RIP | Routing Information Protocol. A protocol for exchanging routing information. |
| RJ48C | An 8-position modular connector. |
| RLB | Repeater LoopBack. Loops the signal being sent to the network back to the DTE Drop/Insert and data ports after it has passed through the framing circuitry of the device. |
| Rlpbk branch | Remote Loopback branch of the DSU/CSU menu tree. |
| router | A device that connects LANs by dynamically routing data according to destination and available routes. |
| RS-232 | An Electronic Industries Association's standard for a low-speed, 25-position, DCE/DTE interface. |
| RS-232-like MIB | RFC 1659, which defines objects for managing RS-232-type interfaces (e.g., RS-422, RS-423, etc.) and supports synchronous data ports and management communication ports on the device. |
| RS-449 | An Electronic Industries Association's standard for a general-purpose, 37-position, DCE/DTE interface. |
| RTS | Request to Send. A signal from the DTE to the device, indicating that the DTE has data to send. V.24 circuit 105. |
| RX | Receive. To obtain transmitted signals. |
| RXC | Receive Clock. V.24 circuit 115. |
| RXD | Received Data. Pin 3 of the EIA-232 interface that is used by the DTE to receive data from the modem. Conversely, the modem uses Pin 3 to transmit data to the DTE. |
| SDCP | Shared Diagnostic Control Panel. A feature that allows carrier-mounted devices to share the same diagnostic control panel. |
| self-test | A test that checks most hardware components when power is applied to the device or a reset is initiated. |
| server | A device that offers a specific service, such as database management, to a client. |
| SES | Severely Errored Seconds. Usually defined as a second during which a specific number of CRC errors was exceeded, or an OOF or other critical error occurred. |
| Set Command (SNMP) | A command providing write access to SNMP MIB objects. |
| SF | Superframe. Also known as D4 framing, the T1 transmission standard that specifies 12 frames to be used for frame synchronization and to locate signaling bits. |

| | |
|-------------------------|--|
| SLIP | Serial Line Internet Protocol. Protocol for serial operation on an internet. |
| SNMP | Simple Network Management Protocol. Protocol for open networking management. |
| Stat branch | Status branch of the DSU/CSU menu tree. |
| StEvt | Status Event Register. Records the occurrence of certain alarm conditions. |
| subnet | A portion of a network, which may be a physically independent network segment, that shares a network address with other portions of the network and is distinguished by a subnet number. A subnet is to a network what a network is to an internet. |
| subnet mask | A number that identifies the subnet portion of a network address. The subnet mask is a 32-bit Internet address written in dotted-decimal notation with all the 1s in the network and subnet portions of the address. |
| synchronous data | Data transmission that is synchronized by timing signals. Characters are sent at a fixed rate. |
| T1 | A term for a digital carrier facility used to transmit a DS1 formatted digital signal at 1.544 Mbps. It is used primarily in North America. |
| TCP/IP | Transmission Control Protocol/Internet Protocol. The dominant protocol suite in the worldwide Internet, TCP allows a process on one machine to send data to a process on another machine using the IP. TCP can be used as a full-duplex or one-way simplex connection. |
| Telnet | Virtual terminal protocol in the Internet suite of protocols. Allows the user of one host computer to log into a remote host computer and interact as a normal terminal user of the remote host. |
| time slot | One of the ways in which bandwidth can be specified for multiplexer channel groups. Time slots are specified by any number from one to twenty-four, with each time slot equal to 64 kbps. |
| trap (SNMP) | A notification message to the SNMP manager when an unusual event occurs on a network device, such as a reinitialization. |
| TStat branch | Test Status branch of the DSU/CSU menu tree. |
| TX | Transmit. To send signals from a device. |
| TXC | Transmit Clock. V.24 circuit 114. |
| TXD | Transmit Data. Pin 2 of the EIA-232 interface that is used by the DTE to transmit data to the modem. Conversely, the modem uses Pin 2 to receive data from the DTE. |
| UAS | Unavailable Seconds. A count of one-second intervals when service is unavailable. |
| UDP | User Datagram Protocol. A TCP/IP protocol describing how messages reach application programs within a destination computer. |
| UL | Underwriter's Laboratories, Inc. An organization which promotes product safety. |
| V.24 | An ITU-T standard for a low-speed, 25-position, DCE/DTE interface. |
| V.35 | An ITU-T standard for a high-speed, 34-position, DCE/DTE interface. |
| V.54 | An ITU-T standard for local and remote diagnostic loopback tests. |
| V.54 Loop 2 | An ITU-T standard for a data channel loopback (DCLB). |
| V.54 Loop 3 | An ITU-T standard for a data terminal loopback (DTLB). |
| Vac | Volts alternating current. |

| | |
|-----------------------|---|
| Vdc | Volts direct current. |
| VF | Voice Frequency. The part of the audio frequency range used to transmit voice sound (usually 300 Hz to 3400 Hz). This band is used by the modem for its modulated signal. |
| WAN | Wide Area Network. A network that spans a large geographic area. |
| warmStart trap | An SNMP trap that indicates that the device has reinitialized itself. |
| XTXC | External Transmit Clock. V.24 circuit 113. |
| Yellow Alarm | An outgoing signal transmitted when a DS1 terminal has determined that it has lost the incoming signal. |

Index

A

abort
 lamp test, 4-31
 loopback, 4-25
 test patterns, 4-28

ACAMI method of channel allocation, 3-31

Access, Community Name, C-21

Activ (Active) configuration area, functional description, 3-11

addressing. *See* IP (Internet Protocol) addressing

agent, SNMP, 1-2

AIS (Alarm Indication Signal) condition
 ASCII terminal/printer message, 4-11
 Device Health and Status message, 4-4
 front panel LED indication, 3-5
 troubleshooting, 4-14

Alarm Configuration branch
 example of use, 3-26
 option table, C-16

Alarm Messages, configuration option, C-16

alarm messages. *See* messages, alarm

Alarm Relay, C-18

All Ones configuration option, C-3

Alternate Dial-Out Directory, C-17

ANSI Performance Report Messages, C-7

ASCII terminal/printer, used for alarm messages, 1-2

authenticationFailure trap, 4-12

AUX Port, used with SNMP system, F-2

B

B8ZS (Bipolar Eight Zero Substitution) coding
 configuration option, C-7
 Self-Test Health message, 4-2

Base Rate, C-2

BES (Bursty Errored Seconds) report, 4-8

Bit Stuffing, configuration option, C-8

block method of channel allocation, 3-31

C

cabling, pin assignments, D-1

Call Retry on Alarm or Trap, C-17

CID (Customer Identification) branch, example of use, 3-9

Circuit Identifier configuration option, C-9

Clear, Status branch function, 4-4

clocking
 configuration options, C-9
 principles of operation, 3-34

ClrReg (Clear Performance Registers) branch, example of use, 4-10

Cnfig (Configuration) branch, C-1

COM Port
 acquiring/releasing the user interface, 3-38
 Char Length configuration option, C-13
 COM Rate configuration option, C-13
 COM Use configuration option, C-11
 configuration option, C-11
 CParity configuration option, C-13
 CStop Bits configuration option, C-13
 Disconnect Time configuration option, C-14
 functional description, 1-3
 Inactivity Timeout configuration option, C-14
 IP Address, C-21
 Link Layer Protocol, C-22
 pin assignments, D-9
 resetting, H-1
 Subnet Mask, C-22
 used with SNMP system, 1-2, 3-20, F-2

COM port to modem cable, D-11

Community Name, C-20

community name
 configuration option, C-20
 procedure for configuring, 3-24

- configuration options
 - procedure for changing, 3-11
 - tables
 - Alarm, C-16
 - General, C-9
 - Network Interface, C-7
 - Port, C-2
 - SNMP, C-19
 - User Interface, C-10
- connectors, rear panel
 - functional description, 1-3
 - pin assignments, D-1
- CPU failure message, 4-2
- crossover cable, D-11
- CSS (Controlled Slip Seconds) report, 4-8
- Ctrl (Control) branch, examples of use, 3-9, 3-36, 3-39, 3-40, 4-10
- Cust1 (Customer 1) configuration area, functional description, 3-11
- Cust2 (Customer 2) configuration area, functional description, 3-11
- cyclic redundancy check (CRC), error indication, 4-7

D

- data channel loopback (DCLB), 4-23, C-3
- data port, RS-232-like MIB, E-1
- data terminal loopback (DTLB), 4-24, C-3
- database, SNMP, 1-2
- default configuration options, C-1
- DevFail (Device Failure) message, 4-4
 - how to clear, 4-4
- DevHS (Device Health and Status) branch, example of use, 4-3
- Device fail, self-test message, 4-2
- Dial Out Delay Time, C-17
- Dial-in Access, C-10
- Download failed, Device Health and Status message, 4-4
- DSU Operational, Device Health and Status message, 4-4
- DTR, Ignore DTR configuration option, C-14

E

- EDL, 1-2
 - configuration option, C-4
 - Mgmt Link configuration option, C-6
- EER (Excessive Error Rate) condition
 - ASCII terminal/printer message, 4-11
 - Device Health and Status message, 4-4
 - front panel LED indication, 3-5
 - Performance Report message, 4-9
 - troubleshooting, 4-14
- EER at Prt1, Device Health and Status message, 4-4
- EIA-530-A interface, D-3
- Embedded Data Link (EDL), 1-2
 - configuration option, C-4, C-6
 - used with SNMP system, F-1
- enterprise-specific trap, enabling and disabling, C-24
- enterprise-specific traps
 - description, 4-12
 - list of supported, 4-13
- Err Rate, configuration option, C-5
- ES (Errored Seconds) report, 4-7
- Excessive Error Rate Threshold, C-18
- external modem interface, D-11

F

- Facility Data Link (FDL), 1-2
 - configuration option, C-7
 - used with SNMP system, 1-2, F-2
- Fact1 (Factory 1) configuration area, functional description, 3-11
- Fact2 (Factory 2) configuration area, functional description, 3-11
- failure analysis, 4-14
- failure message
 - during power-up self-test, 4-4
 - troubleshooting, 4-15
- Far-End Performance Statistics, C-6
- features, 1-1– 1-4
- framing configuration option, C-7
- Front Panel Emulation
 - functional description, 1-2, 3-1, G-1
 - installation and operation, G-1

G

Gen (General) Configuration branch
 example of use, 3-34
 option table, C-9

I

ID (Identity) branch, example of use, 3-7
 indicators, 3-4
 Invert Data, C-4
 Invert Tx Clock, C-4
 IP (Internet Protocol) addressing
 configuration option, C-21
 example of use, F-1– F-6
 procedure for configuring, 3-21, 3-28

K

keypad, operation, 3-2

L

lamp test, 4-30
 LAN Adapter, F-1
 LED Status branch, example of use, 3-10
 LEDs, front panel
 functional description, 3-4
 lamp test, 4-30
 Line Build Out, C-7
 line loopback (LLB), 4-20
 link layer protocol, 3-19, 3-23
 link trap, 4-12
 Link Trap Interfaces, C-24
 Link Trap Type, C-24
 LOF (Loss Of Frame) condition, front panel LED
 indication, 3-5
 LOFC (Loss Of Frame Count) report, 4-8
 loopback
 front panel LED indication, 3-4
 local, 4-19
 abort, 4-25
 data channel loopback (DCLB), 4-23
 data terminal loopback (DTLB), 4-24
 line loopback (LLB), 4-20
 payload loopback (PLB), 4-21
 repeater loopback (RLB), 4-22
 remote, 4-16

LOS (Loss Of Signal) condition
 ASCII terminal/printer message, 4-11
 Device Health and Status message, 4-4
 front panel LED indication, 3-5
 Performance Report message, 4-9
 Self-Test Health message, 4-2
 troubleshooting, 4-14
 Lpbk (Local Loopback) branch, example of use, 4-19

M

maintenance
 device health and status, 4-3
 performance reporting, 4-5
 power-up self-test, 4-1
 manager, SNMP, 1-2
 Master Clk fail, Device Health and Status message,
 4-4
 master clock
 functional description, 3-34
 procedure for configuring, 3-34
 messages
 alarm
 Performance Report, 4-7
 Self-Test Health, 4-2
 troubleshooting, 4-14
 with ASCII terminal/printer, 1-2– 1-4, 4-11
 status
 Performance Report, 4-7
 Self-Test Health, 4-2
 Test Status, 4-32
 Mgmt Link, configuration option, C-6
 MIBs, SNMP, E-1

N

Near-End Performance Statistics, C-5
 NET (Network) Configuration branch
 example of use, 3-13
 option table, C-7
 Net DCLB, C-2
 Network Circuit Identifier, C-9
 Network Initiated Line Loopback, configuration option,
 C-8
 Network Initiated Payload Loopback, configuration
 option, C-8

- network interface
 - configuration options, C-7
 - failure message, 4-2
 - front panel LED indications, 3-5
 - functional description, 1-3
 - pin assignments, D-1
 - troubleshooting, 4-14
 - Network Line Coding Format, C-7
 - Network Line Framing, C-7
 - NMS
 - IP Validation, C-19
 - Manager Access Type, C-20
 - Manager IP Address, C-19
 - Number of Security Managers, C-19
- O**
- objects, SNMP, 1-2, E-1
 - OOF (Out Of Frame) condition
 - ASCII terminal/printer message, 4-11
 - front panel LED indication, 3-5
 - Performance Report message, 4-7
 - troubleshooting, 4-14
 - OOF at Prt1, Device Health and Status message, 4-4
 - options, strap, C-1
- P**
- Password Mode, C-10
 - pattern tests, 4-26
 - payload loopback (PLB), 4-21
 - Perf (Performance Report) branch, example of use, 4-5
 - performance registers
 - description, 4-5
 - resetting, 4-10
 - performance reporting, 4-5, C-5, C-6
 - physical description of DSU/CSU, 1-3– 1-5
 - pin assignments, D-1
 - Point-to-Point Protocol (PPP)
 - procedure for configuring, 3-23
 - used with SNMP system, 1-2, 3-20, F-1
 - Port, functional description, 1-3
 - PORT 1 interface
 - configuration options, C-2
 - failure message, 4-2
 - front panel LED indications, 3-6
 - pin assignments, D-3
 - Port Configuration branch, option table, C-2
 - Port LB, C-3
 - Port Type, C-2
 - power input, troubleshooting, 4-14
 - power-up self-test, LED behavior, 2-6
 - power-up self-test
 - displaying results, 4-1
 - front panel indications, 3-4
 - troubleshooting, 4-14
 - problem determination, 4-14
 - protocol, link layer, 3-19, 3-23
 - Ptrns (Test Patterns) branch, example of use, 4-26
- Q**
- QRSS Test, 4-26
- R**
- rate, communications port, C-13
 - rear panel, connectors. *See* connectors, rear panel
 - Rel (Release) branch, example of use, 3-39
 - remote loopback, 4-16
 - repeater loopback (RLB), 4-22
 - reset
 - async terminal operation, H-1
 - procedure, 3-40
 - Reset branch, example of use, 3-40
 - Rlpbk (Remote Loopback) branch, example of use, 4-16
 - RS-449 interface, D-5
- S**
- self-test, enabling and disabling, C-10
 - self-test
 - displaying results, 4-1
 - front panel indications, 3-4
 - troubleshooting, 4-14
 - Send Ones configuration option, C-3
 - serial crossover cable, D-11
 - Serial Line Internet Protocol (SLIP)
 - procedure for configuring, 3-23
 - used with SNMP system, 1-2, 3-20, F-1
 - SES (Severely Errored Seconds) report, 4-8

Shared Diagnostic Control Panel (SDCP),
acquiring/releasing the user interface, 3-38

SNMP (Simple Network Management Protocol)

- agent, 1-2
- configuration options
 - examples of use, 3-19, 3-26
 - option table, C-19
- connection examples, F-1– F-6
- database, 1-2
- IP addressing, F-1– F-6
- manager, 1-2
- MIBs
 - functional description, E-1
 - list of objects, E-1
 - procedure for configuring access, 3-24
- objects, 1-2
- principles of operation, 1-2
- SNMP Down message, 4-4, 4-15
- traps
 - functional description, 1-2, 4-12
 - procedure for configuring, 3-26

SNMP Management

- enabling and disabling, C-19
- Number of Security Managers, C-19
- Number of Trap Managers, C-23
- System Contact, C-20
- System Location, C-20
- System Name, C-20

SNMP Traps, 4-12

- Alarm and Trap Dial Out, C-17
- enabling and disabling, C-16, C-23, C-24
- enterprise-specific, 4-13
- Number of Trap Managers, C-23
- Trap Disconnect, C-16
- Trap Manager Destination, C-23
- Trap Manager IP Address, C-23

Stat (Status) branch, examples of use, 3-7, 3-10, 4-1, 4-3, 4-5, 4-32

STest (Self-Test Health) branch, example of use, 4-1

StEvt (Status Event) report, 4-9

straps, C-1

subnet, 3-19, C-22, F-2

synchronous data port, RS-232-like-MIB, E-1

System Contact, C-20

System Location, C-20

System Name, C-20

T

Telnet session

- Disconnect Time, C-15
- enabling and disabling, C-14
- Inactivity Timeout, C-14
- Password Mode, C-14

Test branch, example of use, 4-15

test commands, 4-15

- front panel LED indications, 3-4
- lamp test, 4-30
- local loopback, 4-19
 - abort, 4-25
 - data channel loopback (DCLB), 4-23
 - data terminal loopback (DTLB), 4-24
 - line loopback (LLB), 4-20
 - payload loopback (PLB), 4-21
 - repeater loopback (RLB), 4-22
- remote loopback, 4-16
- test messages, 4-32
- test patterns, 4-26

Test Duration, C-10

Test in progress, Device Health and Status message, 4-4

test jacks

- functional description, 4-15
- physical description, 3-3

Test Timeout, C-9

timing, 3-34

traps, SNMP. *See* SNMP traps

troubleshooting

- device health, 4-3
- diagnostic table, 4-14
- performance, 4-5
- power-up self-test, 4-1

TStat (Test Status) branch, example of use, 4-32

Tx Clock, C-4

U

UAS (Unavailable Seconds) report, 4-7

User Configuration branch

- example of use, 3-16– 3-40
- option table, C-10

user interface, acquiring/releasing, 3-38

V

V.35 interface, D-7

V.54 Loop 2. *See* data channel loopback (DCLB)

V.54 Loop 3. *See* data terminal loopback (DTLB)

W

warmStart trap, 4-12

X

X.21 interface, D-8

Y

Yellow Alarm, Rcv Yellow configuration option, C-3

Yellow Alarm condition

ASCII terminal/printer message, 4-11

Device Health and Status message, 4-4

front panel LED indication, 3-5

Performance Report message, 4-9

troubleshooting, 4-14

Free Manuals Download Website

<http://myh66.com>

<http://usermanuals.us>

<http://www.somanuals.com>

<http://www.4manuals.cc>

<http://www.manual-lib.com>

<http://www.404manual.com>

<http://www.luxmanual.com>

<http://aubethermostatmanual.com>

Golf course search by state

<http://golfingnear.com>

Email search by domain

<http://emailbydomain.com>

Auto manuals search

<http://auto.somanuals.com>

TV manuals search

<http://tv.somanuals.com>