



SHERATON

Gas cooker

Owners handbook
and
Installation Instructions

Introduction

This gas cooker has been designed and manufactured to all the necessary British Standards. It also carries the C.E. mark. The cooker complies with European Council Directive 90/396/EEC.

It is important that you understand how to use and care for the cooker properly before you use it for the first time.

We have written this booklet with your safety in mind. Read the booklet thoroughly before you use the cooker. Keep the booklet in a safe place so that anyone who uses the cooker can read it. Pass the booklet on with the cooker if you give or sell it to someone else.

For your safety

This cooker is designed for domestic use to cook food. You must not use it for any other purpose. It is not designed for commercial use.

Keep children, babies and toddlers away from the cooker at all times.

The installation instructions tell you how and where it can be fitted. If the cooker is already installed you must make sure that all instructions have been followed. If you are in any doubt ask a registered person. More details on installation on page 25.

We have included several drawings to show the right and wrong way of doing things.

The right way will have a smiling face by it.



A sad face shows something is wrong.



Important: Make sure you remove the sales stickers before you use this cooker.

| Contents | Page |
|---------------------------------|------|
| Lighting the cooker | 4 |
| The grill | 7 |
| The hotplate | 9 |
| The oven | 12 |
| Blank page | 14 |
| Oven cooking chart | 15 |
| Slow cooking | 18 |
| Care and cleaning | 20 |
| Installing the cooker | 25 |
| General information | 27 |
| What is wrong and why? | 29 |
| Servicing | 30 |
| Installation instructions | 31 |
| Technical data | 32 |
| Safety requirements/ventilation | 33 |
| Location of appliance | 34 |
| Testing | 37 |

Lighting the cooker

The ignition system works by means of a battery. Details on how to replace the battery are given on page 27.

Hotplate

To light

- 1 Lift up the lid. You cannot use the hotplate when the lid is down.
- 2 Push in the control knob and turn to the large flame symbol (highest setting), and press the ignition button immediately. When the burner has lit release the button.

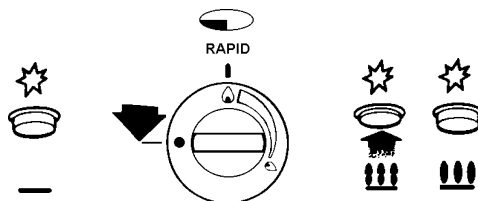

Warning: If the ignition button is not pressed immediately a build up of gas may cause the flame to spread.

For your safety

If you close the lid of the cooker while any of the hotplate burners are lit the gas will go out. This is because it would be dangerous if the burners stayed on when the lid was closed.

Always use the control to turn off a burner. Do not use the lid cut-off device. This will only cut off the gas when the lid is closed.

Grill

To light:

- 1 Push in the control knob and turn it to the large flame symbol (highest setting), and press the ignition button. When the burner has lit release the button.

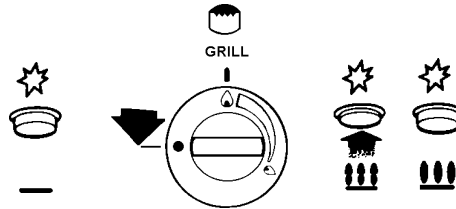

- 2 Adjust setting as required.

Warning: If the ignition button is not pressed immediately a build up of gas may cause the flame to spread.

Oven

To light:

- 1 Open the oven door.
- 2 Push in the control knob and turn it to gas mark 9. Press the ignition button. When the burner has lit release the button. There will only be small flames at first.

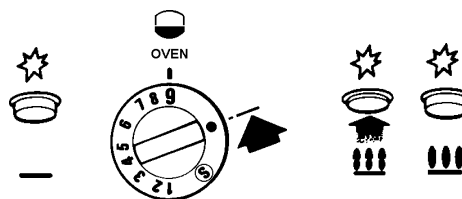

- 3 Now turn the control knob to the gas mark you want.
- 4 Wait until the burner is showing large flames.
- 5 Close the oven door.



To turn off any burner

- 1 Push in the control knob and turn it to the off position. This is shown by a large dot.

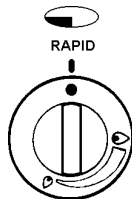
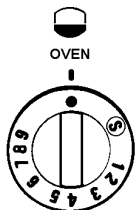

For your safety

When you are lighting any burner check that it has lit before you leave the cooker.

When you are turning off a burner, do not leave the cooker until the flame has gone out.

The grill

The grill is a high-speed grill. The instructions below tell you how to vary the heat setting and how to change the height of the trivet to suit the food you are cooking. You should remember to turn the food regularly.

You should not use the grill to keep food warm as it will continue to cook the food.

For your safety

You must keep the grill door open when the grill burner is lit.

Accessible parts may be hot when the grill is used. Young children should be kept away.

Heat control

The grill control has two heat settings.

The control knob turns to the left from 'OFF' to 'HIGH' and then to 'LOW'. Use the high setting for fast cooking such as toast. Use the low setting to cook thicker food such as chicken after you have browned it on the high setting.

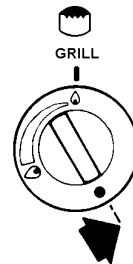

Cooking positions

When using the grill, the shelf must be placed in the lower of the two positions.

Most food should be cooked on the trivet in the grill pan. You can turn the trivet over to suit different thicknesses of food.

You can place some dishes straight on to the grill shelf. This is useful when you are browning the top of food such as cauliflower cheese.

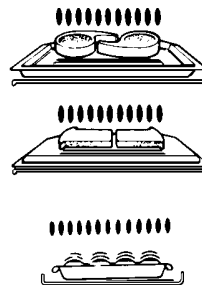

General

When storing the grill pan the shelf needs to be placed in the top position.

Store the grill pan on the base of the grill compartment. Turn the grill burner off before you store the pan. Remember that the pan will get hot when you are using the oven.

You can use the grill compartment to warm plates when you are using the oven.

Preheating

You don't usually need to preheat the grill. You may wish to preheat it for a couple of minutes when you are cooking steak or when browning food.

Positioning food on the trivet

Place food such as toast, tea-cakes and muffins towards the centre of the trivet.

Place food which needs a more gentle heat, such as tomatoes and mushrooms towards the edge of the trivet.

Arrange meat, meat products and fish to suit their thickness and how you like them cooked.

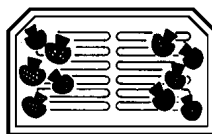
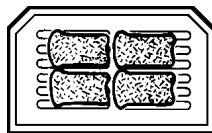

The hotplate

You can only use the hotplate when the lid is open. If you have any trouble lighting a hotplate burner turn all hotplate control knobs off and make sure the hotplate burner parts have been replaced correctly. See page 21 for more information.

Heat control

The hotplate control knobs turn to the left from 'OFF' to 'HIGH' and then to 'LOW'. You can adjust the heat by turning the control between the highest and lowest settings. These are shown as a large and a small flame symbol.

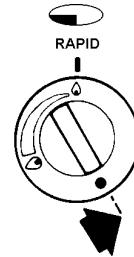

Burner sizes

The hotplate has three burner sizes to suit different types of cooking:

Largest burner (Rapid) - use a large pan for food such as chips.

Medium burners (Normal) - use for everyday cooking.

Small burner (Simmer) - use for simmering food such as soups and stews.

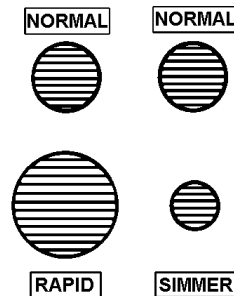

The largest pan which you should use on any burner is 230mm (9"). The base of the smallest pan should not measure less than 100mm (4").



For your safety



- 1 Take care to avoid burns and scalds when you are reaching across the hotplate.

- 2 Use pans with flat bases. They are more stable than pans which are warped.

- 3 Do not use pans with very heavy handles which cause the pan to tip.

- 4 Put pans on the centre of the burners.

- 5 Position pan handles so they cannot be accidentally knocked.

- 6 Take extra care when you are deep fat frying. Do not cover the pan with a lid.

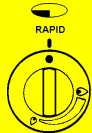

Do not leave a pan unattended. If the pan catches fire, leave it where it is and turn off all controls.



Place a damp cloth or a fitting lid over the pan to smother the flames.

Never put water on the fire.











Leave the pan to cool for 30 minutes.

- 7 If you are using a Wok we recommend it has a flat base as it will stand stable on the pan supports. If you use a round based Wok with a collar support, the collar must be of the open wire work type. A closed collar will affect the performance of the burner. Before you use the Wok make sure that the collar is stable on the pan supports. Always follow the instructions that come with the Wok.

- 8 Do not use the lid as a work surface or chopping board. This could damage the glass and reduce its strength.

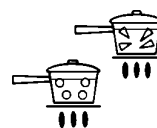

Helpful hints

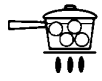
- 1  Keep flames under the base of the pans. If the flames lick round the sides of the pans you are wasting gas. 
- 2  Only heat the amount of liquid you need. Do not overfill pans. 
- 3  Cover pans with a lid whenever possible. The food will heat up more quickly and there will be less steam in the kitchen. 
- 4  Try cooking more than one vegetable in the same pan, for example potatoes and carrots. 
- 5  Cut vegetables into smaller pieces. This way they will cook more quickly. 
- 6 A pressure cooker will save time and energy.

The oven

Before you use the oven you should wipe it out with a damp cloth to remove any dust.

Heat zones

There are zones of heat within the oven. The temperature in the middle is the gas mark you have chosen. The top of the oven is slightly hotter and the lower shelf slightly cooler. The base of the oven is quite a lot cooler. You can make use of these heat zones when you are cooking foods that need different temperatures all at the same time.

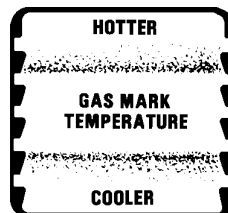

If you are cooking more than one tray of similar items, for example cakes or biscuits, swap the trays around during cooking. Or you can remove the top tray when the food is cooked and move the lower tray to the higher shelf to finish cooking.

Preheating

You do not need to preheat the oven when casseroles and so on.

Preheat the oven for baking or when you are cooking sensitive food such as Yorkshire puddings, soufflés and yeast mixtures.

When you are cooking or reheating frozen or chilled food read the instructions on the packing.

When you need to preheat the oven, we recommend you do so for 20 minutes.

Oven shelves

You can slot the oven shelves into any of five positions. Positions are counted from the top downwards.

For safety the shelf will only pull out so far. If you want to remove a shelf completely pull it forward as far as it will go, raise the front edge and lift it out. To put the shelf into a different position keep the front edge raised, slot the shelf on to the runner, lower the front edge and slide the shelf in.

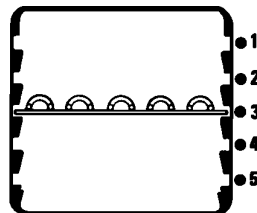

Baking trays and dishes



For your safety

Never place cooking dishes, trays and so on over the oven burner. This will damage the cooker as well as the ovenware and possibly the floor covering underneath the cooker.









Leave a gap of 13mm (½") between all dishes and the sides of the oven so the heat can circulate properly.

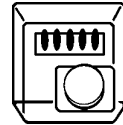

Do not push dishes too far back as food will burn if it overhangs the burner flames.

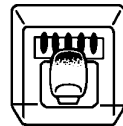

For the best results we recommend that you use a baking tray which is 310mm (12") square. If you use a tray or tin which is larger than this, you may need to turn the food around during cooking.

Place single dishes on the centre of the shelf. You may need to turn large items around during cooking.

Condensation

Condensation may form on the cooker. This is quite normal and nothing to worry about. The condensation forms when heat and moisture are present, for example during cooking. Whenever possible try to make sure that food which contains a lot of moisture, for example casseroles, are covered. If you do notice any condensation, wipe it up straight away.

This page has been intentionally left blank.

Oven cooking chart

These instructions are for cooking in the oven after it has been pre-heated for 20 minutes.

If you are cooking more than one tray of similar items, for example cakes or biscuits, swap the trays around during cooking. Or you can take the top tray out of the oven when the food is cooked and move the lower tray to the higher shelf to finish cooking.

Always leave at least one shelf position between shelves to allow heat to circulate.

The recommended shelf positions give the best results.

Put the dishes in the centre of the shelf.

You can change the gas marks and cooking times to suit your own tastes.

It is important to check that food is piping hot before serving.

| Food | | Gas mark | Shelf position | Approximate cooking time | |
|----------------|---------------|----------|----------------|--------------------------|-------------------------------------|
| Roasting meat: | Beef | 5 | 4 | Rare: | 20 mins. per ½kg (1lb) and 30 mins. |
| | | | | Medium: | 25 mins. per ½kg (1lb) and 25 mins. |
| | | | | Well Done: | 30 mins. per ½kg (1lb) and 30 mins. |
| | Lamb | 5 | 4 | Medium: | 25 mins. per ½kg (1lb) and 25 mins. |
| | | | | Well Done: | 30 mins. per ½kg (1lb) and 30 mins. |
| | Pork and Veal | 5 | 4 | Medium: | 30 mins. per ½kg (1lb) and 30 mins. |
| | | | | Well Done: | 35 mins. per ½kg (1lb) and 35 mins. |

Thaw frozen joints thoroughly before cooking them.

| Food | Gas mark | Shelf position | Approximate cooking time |
|---|--|----------------|-------------------------------------|
| Poultry: | | | |
| Chicken | 5 | 4 | 20 mins. per ½kg (1lb) and 20 mins. |
| Turkey below 4.5kg (10lbs) | 4 | 4 | 25 mins. per ½kg (1lb) and 25 mins. |
| over 4.5kg (10lbs) | 4 | 4 or 5 | 15 mins. per ½kg (1lb) and 15 mins. |
| Duck and duckling | 5 | 4 | 25 mins. per ½kg (1lb) |
| Stuffed poultry | Cook as above but calculate weight including stuffing. | | |
| Thoroughly thaw frozen joints before cooking them. | | | |
| The times given above are for open roasting. If you cover with foil or a lid allow an extra 5 minutes cooking time for each ½kg (1lb) | | | |
| Yorkshire pudding | | | |
| - large | 7 | 2 | 25-30 mins. |
| - individual | 7 | 2 | 15-25 mins. |
| Cakes: | | | |
| Christmas cake (8") | 2 | 4 | 4 - 5 hours |
| Rich fruit, 180mm (7") | 2 | 4 | 2¼-2½ hours |
| 205mm (8") | 2 | 4 | 2½-2¾ hours |
| Madeira, 180mm (7") | 4 | 4 | 1 hour |
| Small cakes | 5 | 2 & 4 | 15-25 mins. |
| Scones | 7 | 2 & 4 | 10-20 mins. |
| Victoria sandwich | | | |
| 180mm (7") | 4 | 2 & 4 | 20-30 mins. |
| 205mm (8") | 4 | 2 & 4 | 20-35 mins. |

| Food | | Gas mark | Shelf position | Approximate cooking time | |
|-----------------|---------------------------|----------|----------------|--------------------------|--|
| Pastries: | Plate tart (shortcrust) | 6 | 2 | 25 -35 mins. | To help pastry brown on the underside cook on a metal plate, or if plates are flat and have no rim underneath, place on baking tray. |
| | Fruit pie (shortcrust) | 6 | 2 | 25-35 mins. | |
| | Mince pies (flan pastry) | 5 | 2 & 4 | 15-25 mins. | |
| Puddings: | Milk pudding | 2 | 3 | 2 hrs. | |
| | Baked sponge pudding | 4 | 4 | 45-60 mins. | |
| | Baked custard | 3 | 4 | 50-60 mins. | |
| Yeast mixtures: | Bread 0.45kg (1lb loaves) | 8* | 3 | 30-40 mins. | |
| | 0.90kg (2lb loaves) | 8* | 3 | 30-40 mins. | |
| | Rolls and buns | 8* | 2 | 10-20 mins. | |

* Note: When baking bread cook at gas mark 8 for 10 minutes before reducing to Gas mark 6 for remainder of cook time.

Note: You must soak dried beans then boil them in an open pan for 15 minutes before you add them to any dish.

Slow cooking

The slow cook setting gives a very low heat in the oven. It is particularly useful when cooking soups, stews and casseroles because the long slow cooking will make cheaper, tougher cuts of meat more tender.

You need to cook food at gas mark 6 for 30 minutes before you turn the oven down to a slow cook setting. This makes sure that the temperature of the food gets hot enough to start the food cooking.

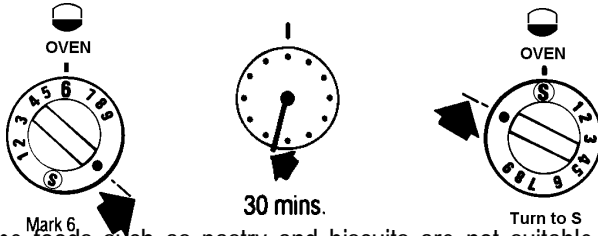

Some foods such as pastry and biscuits are not suitable for slow cooking because the temperature is too low.

Cover all food during cooking to prevent it from drying out. You can uncover food for the last half hour if it is normally served golden brown.

Food preparation-slow cooking

Joints of meat and poultry

- Do not cook meat joints over 2.7kg (6lb).
- Do not cook poultry over 2kg (4lb 8oz).
- Cook on the middle shelf of the oven or above.
- Cook stuffing separately.
- Cook for a minimum of 6 hours.
- Joints of pork must only be cooked if you can make sure, by using a meat thermometer, that an internal temperature of at least 88°C has been reached .
- For good air circulation always stand joints on a rack in the roasting tin or casserole.
- Thaw all frozen meat and poultry before cooking.
- Prime cuts of meat do not benefit from slow cooking.
- Remove excess fat and skin unless browned first.
- Cook for 30 minutes at gas mark 6, then reduce to the slow cook setting.

Soups, casseroles and stews

- Do not cook casseroles over 3kg (6lb).
- Bring to the boil on the hotplate then cook on slow cook.
- Cook in the middle of the oven or above.

Vegetables

- Cut into small pieces.
- Dried beans must be pre-soaked then boiled in an open pan for 15 minutes before adding to any dish.
- Place vegetables under meat in casseroles.
- Cook for 30 minutes at gas mark 6, then reduce to the slow cook setting.

Milk puddings

- Cover the cereal with boiling water and allow to stand for 30 minutes.
- Drain and make the pudding in the usual way.
- Cook for 30 minutes at gas mark 6, then reduce to the slow cook setting.

General points for slow cooking

Frozen foods

Thaw thoroughly before cooking.

Thickening

Toss meat in flour for casseroles. Blend cornflour with water and add it at the end of cooking.

Flavouring

Flavours are retained because there is little evaporation. Adjust at the end of the cooking time.

Liquid

Reduce normal liquid quantities slightly as there is little evaporation during cooking.

Milk and milk products, for example cream

Add towards the end of the cooking to prevent curdling.

Reheating

Left over food should be cooled quickly and refrigerated.

Food should not be reheated using the slow cook setting. Reheat conventionally or in a microwave. Food must only be reheated once.

Care and cleaning

For your safety

For hygiene and safety reasons you must keep this gas cooker clean. A build up of fat or other foodstuff could cause a fire.

Try to mop up spills and splashes as soon as they happen. But be careful as parts of the cooker will be hot.

Do not use any polishes, caustic cleaners, abrasives, washing soda or soap except those recommended.

Please note: If we recommend you use hot soapy water we mean hot water with washing up liquid in it and not any other cleaning product.

If you own a dishwasher please read the operating instructions for the machine before you wash any part of your cooker.

Clean your cooker regularly using a cloth that has been wrung out in hot soapy water. Rinse and polish it dry using a soft cloth.

When you remove parts of your cooker for cleaning do not plunge them into water whilst they are very hot as this may damage the finish of the parts.

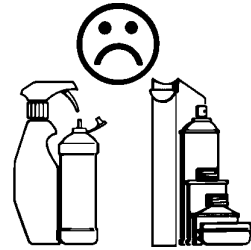

The hotplate

Clean the hotplate top using a mild abrasive such as 'Jif'. Take care not to damage the spark electrodes. If the spark electrodes are damaged the burners will not light.

You can remove the pan supports, burner caps and burner crowns to clean them. Again take care not to damage the spark electrodes.

If any food spills during cooking you can place the pan on another burner to finish cooking. Then you can remove the dirty parts and clean them before the spill 'burns on'.

You can wash the removable parts in very hot soapy water. You may use mild abrasives. Make sure that the electrode and the hole and slots in the crown are not blocked with food or cleaning materials.

Clean the burner crowns by soaking them in very hot soapy water. You can remove any stubborn stains by scouring with a soap filled pad such as 'Brillo'. If you look after the burner crowns in this way they will stay reasonably clean. However the surface will dull with time. Aluminium based saucepans can leave shiny metal marks on the pan supports. Clean the pan supports regularly to remove the marks using a mild abrasive like 'Jif' with a soft scourer. For more stubborn marks you can use a soap-filled pad such as 'Brillo'.

After cleaning the cooker parts, dry them thoroughly before you put them back.



When replacing hotplate burner parts

1. Crown to body (Do not try to force the crown on to the body).

Make sure that the hole in the crown is over the electrode. Check that the two longer location pegs sit in the slots in the body. When the crown is in this position let it fall freely on to the body. Check that the crown can be moved slightly from side to side.

2. Cap to crown
Place cap centrally on the top of the crown (enamel side up). Move sideways and front to back to check the cap is properly fitted.

3. Check for ignition
If a burner will not light then you need to check the crown and cap positions.

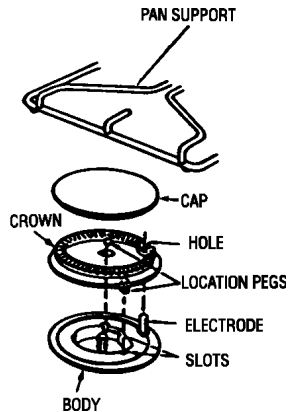

The grill

Clean the grill compartment frequently using hot soapy water.

After use you can soak the grill pan for a few minutes and then clean it using mild abrasives or a soap filled pad such as 'Brillo'.









Clean the shelf using hot soapy water. Mild abrasives can be used if necessary.

The oven

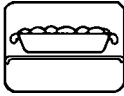
The top, sides and back of your oven are coated in a special material which helps to keep itself clean.

Follow these simple rules to maintain the appearance of the special finish.

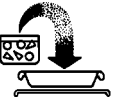

- 1  Do not overfill dishes or they will boil over. 
- 2  Do not put dishes too high in the oven. If you do they may stick to the oven roof. 
- 3  Cover your roasting tins with foil. This will prevent fat splashing. 
- 4  Use a roasting tin which is just large enough for the meat and potatoes. This will help to reduce fat splashing. 
- 5  Dry any vegetables that you are going to roast. If they are wet there will be more fat splashing. 
- 6 Follow the oven cleaning cycle regularly.

Oven cleaning cycle

You need to follow the cycle to keep the inside of the oven in good condition. The type of cooking you do will affect how often you need to follow the cycle.

If you do a lot of roasting and very little other baking you should follow the cleaning cycle once a week. If you do very little roasting you will only need to follow the cleaning cycle every 2-3 weeks.

To carry out a cleaning cycle:

1. Remove the oven shelves.
2. Set the oven to mark 5 for at least 30 minutes.
3. Turn the temperature up to mark 7 for 2 hours or until the oven is presentably clean. Some staining will remain.

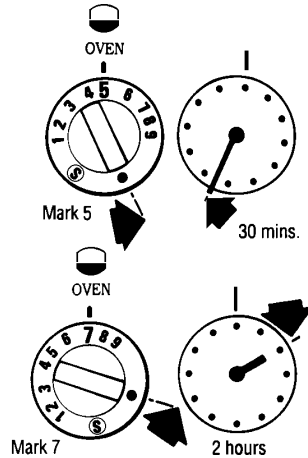

Do not use any cleaning agents or scrapers on the inside of the oven. Do not wash the special finish.



You can replace the oven roof if you need to. You may order this from your supplier. When you are ordering quote part number 359001004.

General

Clean the base of the oven, the oven shelves, the meat tin and the oven door while they are still slightly warm. This way you can easily remove any splashes and spills. Wipe the base with a cloth that has been wrung out in hot soapy water. You may use mild abrasives.

Cleaning between the outer and inner door glass

You can remove the glass from the oven door if you need to.

To remove the outer glass

- 1 Open the oven door so you can get at the two cross head screws on the top of the oven door.
- 2 Loosen these two screws using a pozidrive screwdriver.
- 3 You should hold the door glass securely in place with one hand, whilst removing the screws completely, with the other hand. If you do not do this, the door glass could fall forward.
- 4 Using both hands, gently tilt the top of the door glass towards you. Lift it slightly to disengage the locators at the bottom of the door.

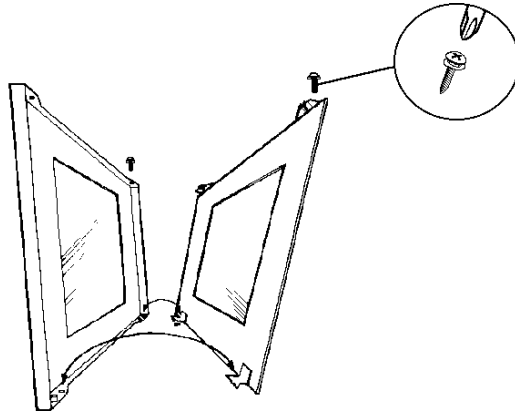

- 5 Clean the outer and inner glass using hot soapy water and mild abrasives such as 'Jif'. DO NOT try to clean the aluminium foil which is inside the door. The foil is there to help keep the door cool, if it is damaged it will not work.
- 6 Replace the glass by holding it in both hands and gently placing the locators into the holes of the brackets at the bottom of the door. Push the top of the glass towards the oven door, and make sure the screw location holes line up.
- 7 Hold the glass in place with one hand and replace the cross head screws into the location holes, with the other hand. Give the screws one turn to make sure the glass is held in place.
- 8 Tighten the screws using a pozidrive screwdriver. Close the door.

Installing the cooker

For your safety

This cooker must be installed and serviced by a competent person as stated in the Gas Safety (Installation & Use) regulations current editions.

It is important that the cooker is suitable for your gas supply. Your installer should check the data badge.

Ensure that a stability bracket is fitted.

Location

For your safety

The use of a gas cooking appliance results in the production of heat and moisture in the room in which it is installed. Ensure that the kitchen is well ventilated: keep natural ventilation holes open or install a mechanical ventilation device (mechanical extractor hood).

Prolonged intensive use of the appliance may call for additional ventilation, for example opening of a window, or more effective ventilation, for example increasing the level of mechanical ventilation where present.

For further details see page 33.

Positioning

The diagram shows how close to the cooker cupboards, shelves, curtains and so on can be fitted. Check the diagram and carefully read the instructions to make sure your cooker is fitted safely. If you are in doubt your installer will give you advice.

- Do not fit any materials which may catch fire for example wood or curtains behind the cooker.

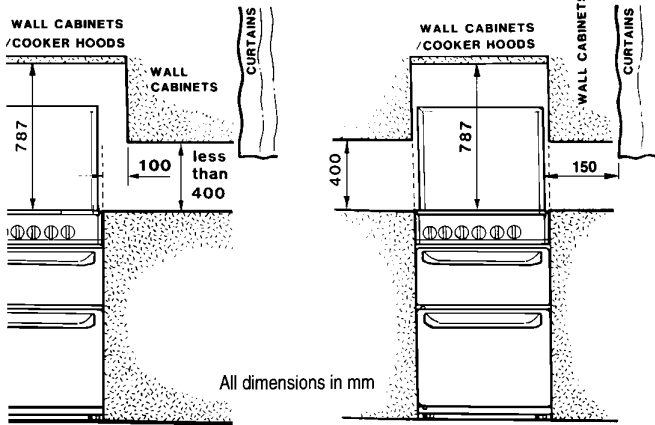

- Base units which are higher than the hotplate must be 100mm away.
- If a cooker hood is fitted read the cooker hood installation instructions.
- We recommend that cabinets fitted next to or above the cooker meet British Standards. Your installer will give you advice if you are not sure.

Cooker dimensions

| | |
|------------------|--|
| Overall Height : | 898mm-920mm (adjusted by two screw feet and two wheels) |
| Width: | 594mm |
| Depth: | 600mm (to front of door panel) |

General information

For your safety

Do not block any of the cooker vents.

Never line any part of the cooker with aluminium foil.

Don't let items which can catch fire or electric mains leads such as kettle flexes trail over any part of the cooker.

Moving your cooker

You may damage some soft or badly fitted floor coverings when you move the cooker. The floor covering under the cooker should be securely fixed so it does not ruck up when you move the cooker across it. Alternatively you could remove the floor covering.

To move the cooker open the grill door. Raise the cooker off its front feet by lifting it from inside the grill. Pull the cooker forward. When you replace the cooker push it back to the stop and make sure there is the same gap at each rear corner.

The battery

The battery for the ignition will usually last for many months. If the ignition system doesn't work, you probably need to replace the battery.

The battery is at the base of the cooker on the left-hand side of the front. You can see it through the slots in the plinth below the oven.

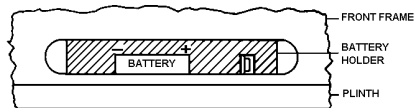

The battery is at the base of the cooker on the left-hand side of the front. You can see it through the slots in the plinth below the oven.

When you need to replace the battery, pull the cooker forward and tilt it back slightly. You should support the cooker with something, a telephone directory would be ideal. The battery you need is AA size.

If you have difficulty removing the battery from the holder you can push it out using something blunt like a spoon handle.

When you fit the new battery, make sure the positive end (marked with a + sign) is on the right-hand side as the picture shows.

When the battery is in place, gently lower the cooker and push it back into position.

You can light the burners with a match until you have time to change the battery.

For your safety

Do not try to disconnect the cooker from the gas supply if the supply pipe does not have a bayonet connection, as described in the installation instruction. If this is the case contact the person who installed the cooker.

What is wrong and why?

We strongly recommend that you carry out the following checks on your cooker before calling a Service Engineer.

Problem

The oven, grill or hotplate will not light.

Check

- If only the hotplate burners will not light make sure that the burner parts have been placed correctly. See instructions on page 21.
- If you cannot hear any sparking or the sparking is slow when you press the ignition button the battery probably needs replacing. For instructions on how to do this see page 27. You can light the burners with a match until you have time to change the battery.
- Check that there is not a problem with your gas supply. You can do this by making sure that other gas appliances such as your central heating or gas fire are working.

Problem

Food is cooking too quickly or too slowly.

Check

- Check that you are using the recommended gas marks and shelf positions. See page 15. Be prepared to adjust the gas mark up or down to achieve the results you want.

Problem

The oven is not cooking evenly.

Check

- Check that the cooker is installed properly and is level.
- Check that the oven roof is pushed back into position.
- Check that you are using the recommended temperatures and shelf positions.
- If you are using a tin or tray which is larger than the one we recommend, be prepared to turn it around during cooking.

Problem

Having difficulty cleaning any part of the cooker.

Check

- Check that the instructions for care and cleaning, beginning on page 20 are being followed.

Servicing

For your safety

Maintenance work must only be done by a competent person. Do not try to repair the cooker yourself. This could be dangerous. It is dangerous to alter or modify the product in any way.

We recommend that your cooker has an annual gas safety check carried out by our approved service organisation.

Before you call a service engineer check through the 'What is wrong and why?' information on page 29. If you still feel there is a problem you should contact Parkinson Cowan on 0990 929929. Your telephone call will be charged at local rate. Parkinson Cowan will arrange for the cooker to be serviced.

Customers in Ireland should telephone (10) 4565666.

You can get service and spares from Parkinson Cowan. If you don't use manufacturers original spares the product approval of your cooker may not be valid.

When you report a problem try to describe the nature of the fault. Always give your cookers full name and serial number which you can see when the main oven door is opened.

Make a note of this information in this space:

Name:

Serial Number:

The Gas Consumers' Council

The Gas Consumers' Council (GCC) is an independent organisation which protects the interests of gas users. If you need advice, you will find the telephone number in your local telephone directory under Gas.

SHERATON

INSTALLATION INSTRUCTIONS

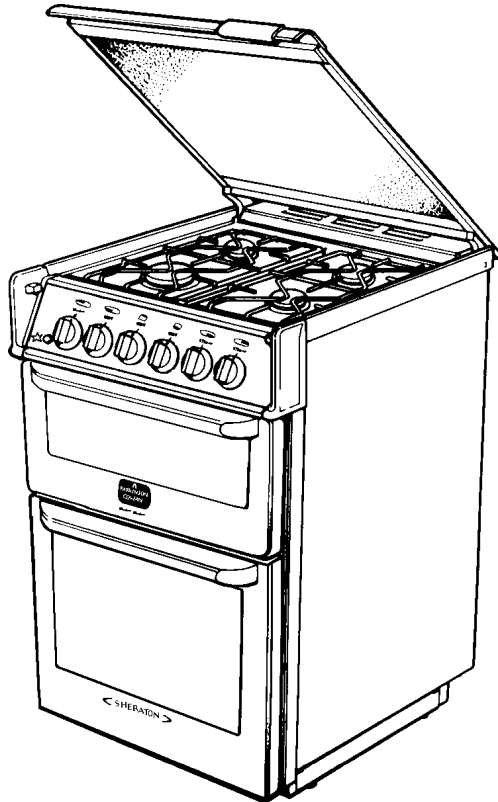

Serial number at front. Data badge on top rear of panel.

For your safety

Check that this model is suitable for the type of supply available. In the interest of safety this appliance must be installed and/or serviced by a competent person, as stated in the Gas Safety (Installation and Use) Regulations Current Editions.

TECHNICAL DATA**DIMENSIONS**

| | | | |
|--------------------|-----------------|-----------------|-----------------------------------|
| | <i>Height</i> | <i>Width</i> | <i>Depth</i> |
| Height to hotplate | 900mm (nominal) | 600mm (nominal) | 600mm (to front of door panel) |

| | |
|---------------------------------------|--|
| Space for fixing at hotplate level | 2mm minimum clearance |
| Space for fixing above hotplate level | See important note 'Location of Appliance' page 34. |
| Minimum space above hotplate | 787mm (If a cooker hood is fitted refer to the cooker hood installation instructions). |
| Weight of appliance | 64.5kg. |
| Minimum distance from rear wall | 5mm (spacer given by pressed spacer on vent panel). |

CONNECTIONS

| | |
|----------|--|
| Gas | Rear left hand side of appliance at hotplate level. Rc½ (½" B.S.P. female). |
| Electric | None |

IGNITION

| | |
|-----------------|------------------|
| Spark generator | APCO 6BG 6893 |
| Battery | 1.5 Volt AA size |

GRILL

| | |
|------------------|---|
| Heat Input | <i>Natural Gas</i> 3.3kW (11263 Btu/h) |
| Injector Marking | 138 |

HOTPLATE

| | | | | |
|------------------|-----------------------|-----------------------|-----------------------|-----------------------|
| | <i>Natural Gas</i> | | | |
| | R.H.F. | R.H.R. | L.H.R. | L.H.F. |
| Heat Input | 1.0kW (3412 Btu/h) | 2.0kW (6824 Btu/h) | 2.0kW (6824 Btu/h) | 2.8kW (9554 Btu/h) |
| Injector Marking | 079 | 104 | 104 | 130 |

MAIN OVEN

| | |
|--------------------------|-----------------------|
| | <i>Natural Gas</i> |
| Heat Input | 2.4kW (8189Btu/h) |
| Injector Marking | 108 |
| Flame Supervision Device | Diamond'H' GSD 100/28 |
| Thermostat | Diamond'H' 1100-93/B2 |
| Marking | 69 |

GENERAL

| | |
|-----------|-------------|
| Ignition | H. T. Spark |
| Spark Gap | 3-4mm |

IMPORTANT - SAFETY REQUIREMENTS

This appliance must be installed in accordance with the Gas Safety (Installation and Use) Regulations Current Editions and the I.E.E. Wiring Regulations. Detailed recommendations are contained in the following British Standard Codes of Practice - BS.6172, BS.5440: Part 2 and B.S.6891. All British Standards must be 'Current Editions'.

PROVISION FOR VENTILATION

This appliance is not connected to a combustion products evacuation device. It shall be installed and connected in accordance with the current installation regulations. Particular attention shall be given to the relevant requirements regarding ventilation.

The room containing the appliance should have an air supply in accordance with BS. 5440: Part 2 Current Edition. All rooms require an openable window or equivalent and some rooms will require a permanent vent as well. For room volumes up to 5m³ an air vent of 100cm² is required: for room volumes between 5m³ and 10m³ an air vent of 50cm² is required. If the room has a door that opens directly to the outside, no air vent is required. For room volumes that exceed 11m³ no air vent is required. If there are other fuel burning appliances in the same room, BS.5440: Part 2 Current Edition should be consulted to determine the requisite air vent requirements.

Prolonged intensive use of the appliance may call for additional ventilation, for example opening a window, or more effective ventilation, for example increasing the level of mechanical ventilation where present.

LOCATION OF APPLIANCE

This appliance must not be installed in a bed-sitting room of volume less than 20m³ or in a bathroom or shower room. It is essential that the appliance is positioned as stated below (see Fig. 1a) i.e. shelves, wall cabinets and cooker hoods must be fitted a minimum of 787mm directly above the top of hotplate and 400mm above the hotplate when fitted in line with the outside of the appliance. If the units are intended to be fitted adjacent to the appliance but less than 400mm above the hotplate, then a minimum space of 100mm must be maintained between the sides of the unit and the appliance (see Fig.1b). Curtains must not be fitted immediately behind the appliance or within 150mm of the sides of the hotplate. If fitted next to or between two base units a minimum space of 1mm must be left between each unit and the sides of the appliance. The levelling feet fitted to the appliance will achieve a nominal height to hotplate trims of 900mm - 2mm +20mm.

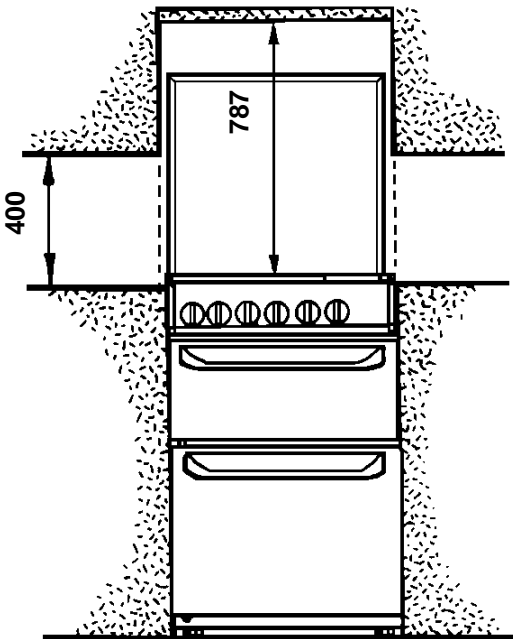

Fig.1a

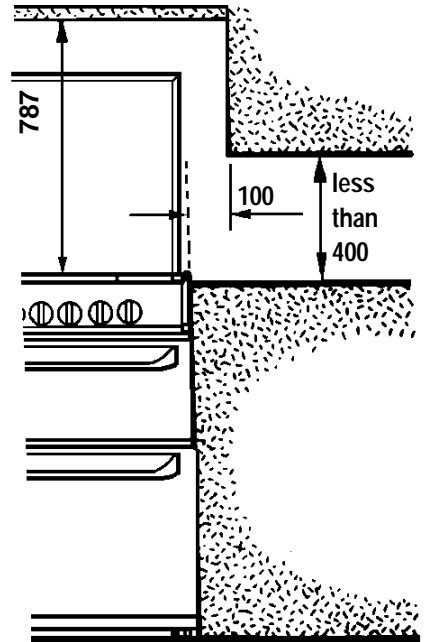

Fig.1b

All dimensions in mm

INSTALLATION

1. PARTS REQUIRED

The loose hotplate parts and battery are packed in the polystyrene fitment on top of the hotplate.

2. LEVELLING THE APPLIANCE

If the appliance requires levelling or its height adjusting (from the hotplate to any working surface), the procedure below must be followed:

1. Loosen the lock nuts securing the rear wheels, using a 13mm spanner. Access to these lock nuts can be gained through a slot in the rear of the plinth, as shown in Fig.1c.
2. Adjustment to suit floor conditions or height is obtained by rotating clockwise or anticlockwise the hexagonal feet/wheels, at the front and rear of the appliance.

NOTE: The rear wheels must only be rotated through half or whole turns.

3. A spirit level should be placed on one of the oven shelves to confirm the appliance is correctly levelled.
4. Once the appliance is at the correct height and levelled, the rear wheel should be locked into position by means of the lock nuts, having first made sure the wheels are once again parallel to the side of the appliance.

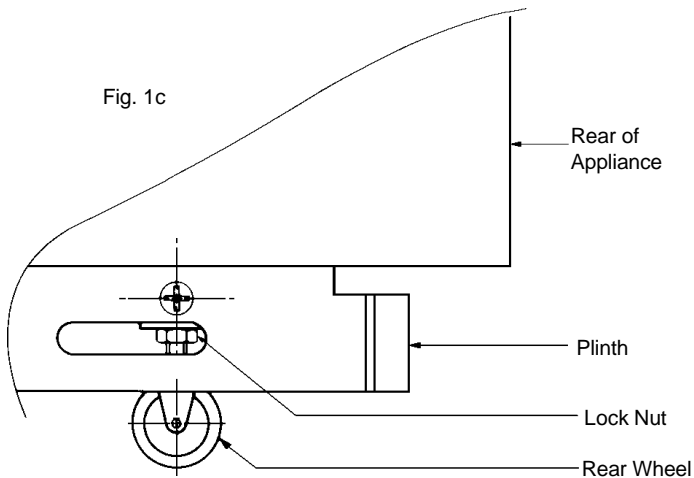

3. FITTING THE STABILITY BRACKET

SHERATON

It is recommended that if the appliance is to be installed with a flexible supply pipe a stability bracket (SK.4729.A) is fitted and is available from your supplier (see Important Safety Requirements, Page 33). These instructions should be read in conjunction with the leaflet packed with the stability bracket.

1. Place the appliance in its intended position and level appliance.
2. Mark off 250mm from the left hand side of the appliance as shown in dimension 'A', Fig 2a. This is the centre line of the fixing bracket.
3. Draw a line 100mm from the front edge of the levelling feet (see Fig 2a) and remove appliance from its position. Mark off dimension 'B' (see Fig 2a) back from this line on the centre line of the bracket to locate the front edge of the lower bracket. Fix lower bracket (with two fixing holes) to the floor then measure the height from floor level to engagement edge on back of appliance, dimension 'C' of Fig. 2b.
4. Assemble upper bracket to lower bracket so that underside of bracket is dimension 'C' +3mm above floor level. (see Fig. 2b).

Reposition appliance and check that top bracket engages into appliance back as shown in Fig. 2b.

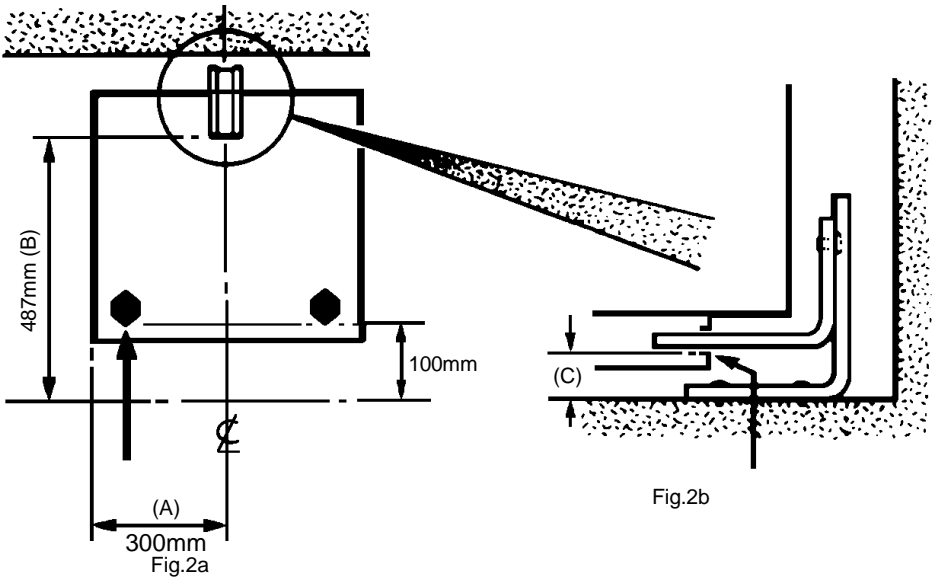

4. CONNECTING TO GAS

This appliance



is designed to

SHERATON

be installed with an appliance flexible connection only. Supply piping should not be less than R³/₈. Connection is made to the Rc ½ (½" B.S.P.) female threaded entry pipe located just below the hotplate level on the rear left hand side of the appliance. **NOTE: ONLY LIQUID SEALANTS TO BE USED WHEN INLET GAS PIPE IS FITTED TO RESET VALVE I.E.: DO NOT USE P.T.F.E. SEALANT TAPE.**

Check for gas soundness after connecting the gas supply.

The gas bayonet connector must be fitted in the shaded area indicated in Fig. 3. Take into account that it must be possible to pull the appliance forward sufficiently. The hose must not get caught on the stability bracket.

IMPORTANT: FLEXIBLE TUBING USED MUST COMPLY WITH BS. 669 CURRENT EDITION. L.P.G. FLEXIBLE CONNECTIONS MUST BE OF A TYPE SUITABLE FOR L.P.G. AND CAPABLE OF OPERATION UP TO 50 mbar AND TO CARRY A RED STRIPE, BAND OR LABEL.

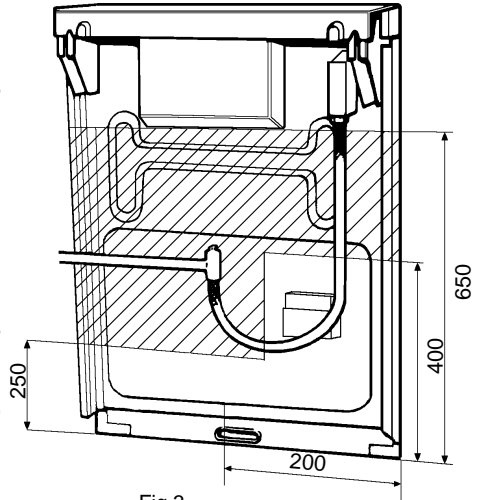

Fig.3

5. FITTING THE BATTERY

1. The battery is located on the left hand side of the front plinth and can be viewed through a slot in the bottom left hand corner of the front frame(Fig 4.)
2. To gain access to the battery, pull the appliance forward, raise and support the front by a few (2-3) centimetres).
3. Fit the battery AA size ensuring the positive + terminal is on the right hand side as shown in the diagram. The battery may be pushed out of the holder by using a blunt implement, such as a spoon handle through the slot in the front frame if necessary.
4. Lower the appliance and push it back into place.

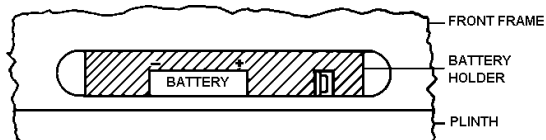

Fig.4

6. PRESSURE TESTING

- 1 The oven injector is used as a pressure test point. _____

SHERATON

Remove the oven furniture. Remove oven burner box retaining clips (one spring clip from each side) and remove box front cover. Replace one clip back into the right hand side of the burner box.

Remove oven burner by removing the spring clip from the right hand side of the oven burner and slide burner off injector, whilst easing it forward and taking care not to strain the F.S.D. phial.

2. Connect the pressure gauge to the oven injector.
3. Check the supply pressure by turning the thermostat on and one hotplate tap full on and light the appropriate burner. The pressure should be 20mbar
4. Turn off the taps, disconnect the pressure gauge and replace oven burner and cover, ensuring that the F.S.D. phial is correctly located into the bracket on the burner.
5. Check operation of oven.

7. CHECKING THE GRILL

Place the grill pan containing the grid into the grill compartment. Light the grill burner by turning the grill tap full on and pressing the ignition button on the fascia panel. As soon as the burner is lit the button can be released.

8. CHECKING THE HOTPLATE

Lift the lid. Fit the burner crowns and caps ensuring that they are correctly seated. Fit the pan supports. Check each of the hotplate burners in turn by turning the hotplate tap to it's full on position and pressing the ignition button. As soon as the burners are lit the button can be released.

9. CHECKING LID CUT-OFF DEVICE

1. Lift the lid.
2. Turn one hotplate burner tap to its full on position and push the ignition button.
3. Close lid. There should now be no gas supply to the hotplate and the burner will go out.
4. Turn off the hotplate tap and lift the lid. The gas supply should now be restored to the hotplate when the tap is turned on.

10. CHECKING THE MAIN OVEN

1. Turn the oven thermostat knob to Mk 9 and press the ignition button. As soon as the burner is alight the button can be released.
2. There should now be a low gas rate to the burner, which is the F.S.D. by pass rate.
3. When the F.S.D. phial has heated up it opens the F.S.D. valve which allows the main gas supply to the oven burner.
4. Set the oven control to Mk 2, close the oven door and check that after about 10 minutes the flame size has reduced.
5. Turn off the control and check that the oven flames go out.

GENERAL NOTE

Instruct the user on how to use the appliance and its ignition system. Refer the user to the wording in the inside cover of the Users Instructions which gives advice on the safe operation of the appliance.

Contents Check List

The loose contents of this pack include:-

| No. OFF | DESCRIPTION |
|---------|-------------------------------|
| 2 | Oven shelves |
| 1 | P.C. Guarantee card |
| 1 | Consumer questionnaire |
| 1 | Hotplate operation card |
| 1 | Grill pan trivet (small wire) |
| 1 | Grill pan (fixed handle) |
| 1 | Meat tin (enamel) |
| 1 | Grill shelf |
| 4 | Burner crowns |
| 4 | Burner caps |
| 2 | Pan supports |
| 1 | Battery |

This handbook was correct on the date it was printed. But this handbook will be replaced if the specification or appearance change as the cooker is improved.

| <i>Description</i> | <i>No. Off</i> | <i>Maker's Part Number</i> |
|-----------------------------|--------------------|--------------------------------|
| Burner Cap - Rapid | 1 | 354000610 |
| Burner Cap - Normal | 2 | 354000609 |
| Burner Cap - Simmer | 1 | 354000608 |
| Burner Crown - Rapid - N.G. | 1 | 359039100 |
| Burner Crown - Normal | 2 | 337000402 |
| Burner Crown - Simmer | 1 | 337000502 |
| Pan Support | 2 | 359033302 |

NOTE : Failure to use manufacturers original spares could negate normal BSI approval of the product

Parkinson Cowan
Customer Care
P.O. Box 47, Newbury, Berkshire RG14 5XL
Telephone: 01635 525521
Fax: 01635 42970

Drawing No. 311423401



Free Manuals Download Website

<http://myh66.com>

<http://usermanuals.us>

<http://www.somanuals.com>

<http://www.4manuals.cc>

<http://www.manual-lib.com>

<http://www.404manual.com>

<http://www.luxmanual.com>

<http://aubethermostatmanual.com>

Golf course search by state

<http://golfingnear.com>

Email search by domain

<http://emailbydomain.com>

Auto manuals search

<http://auto.somanuals.com>

TV manuals search

<http://tv.somanuals.com>