



PPHSS 730 SE

PARKSIDE

GB IE CY

JIGSAW

Operation and Safety Notes

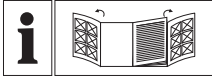

GB IE CY

Before reading, unfold both pages containing illustrations and familiarise yourself with all functions of the device.

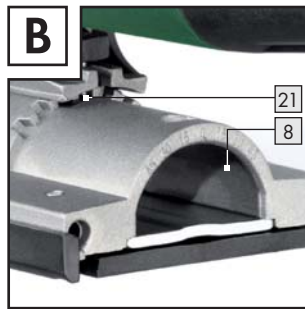
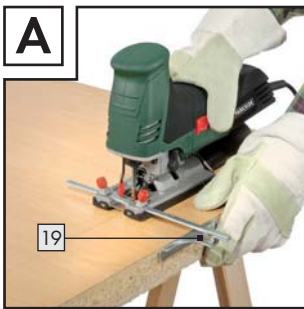

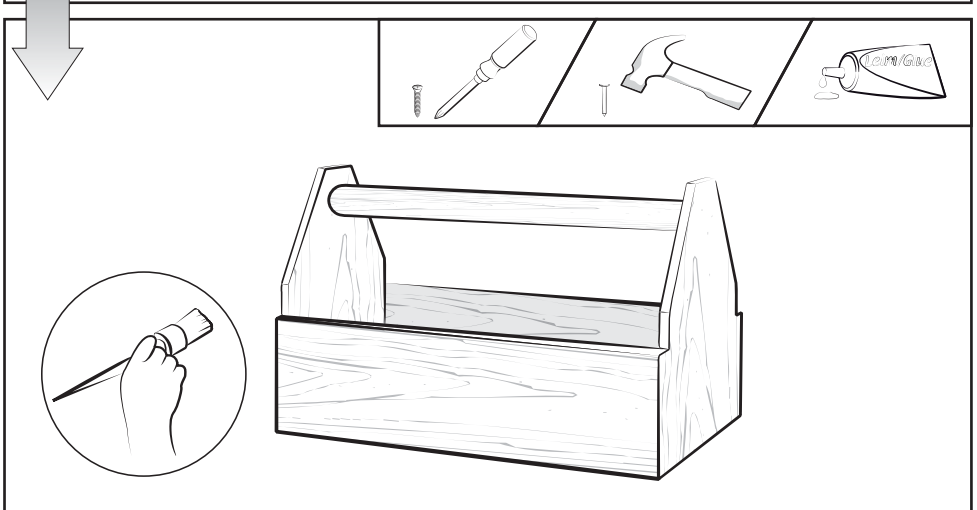
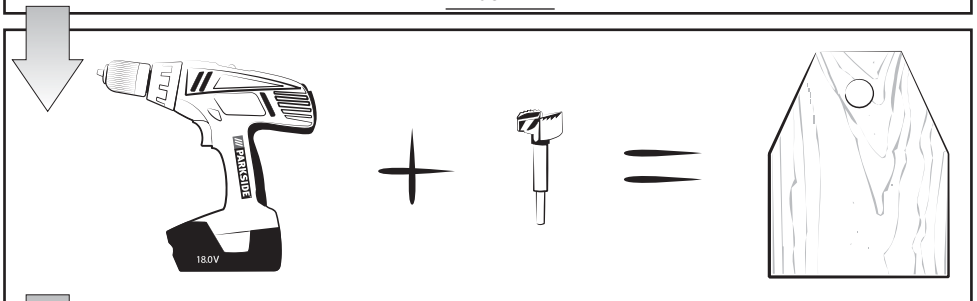
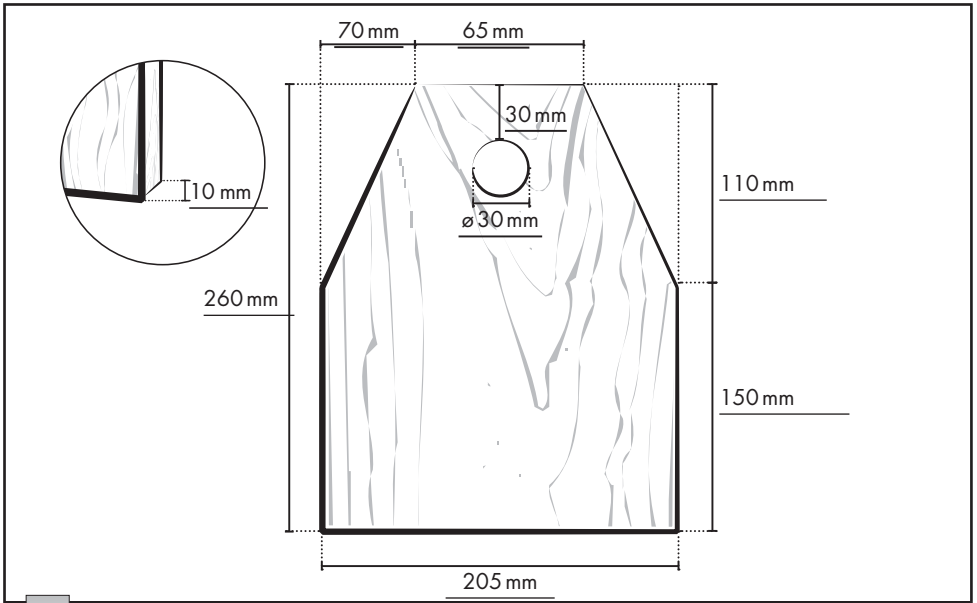

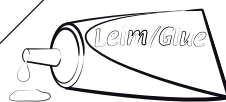
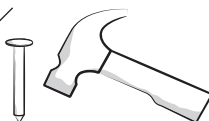
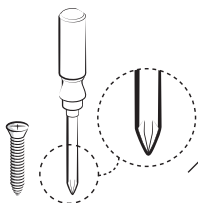
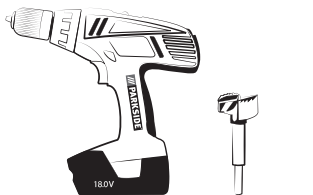
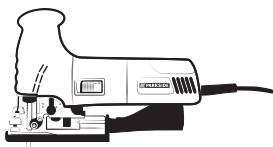

You need:

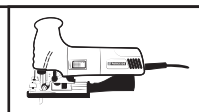

3

2

1

2

3

4

1 x 395 mm x 185 mm x 10 mm

2 x 395 mm x 120 mm x 10 mm

2 x 260 mm x 205 mm x 10 mm

1 x \varnothing 30 mm x 400 mm

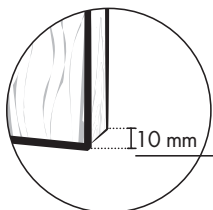

Introduction

Proper use	Page 6
Features and equipment	Page 6
Included items	Page 7
Technical information	Page 7

General safety advice for electrical power tools

1. Workplace safety	Page 7
2. Electrical safety	Page 8
3. Personal safety	Page 8
4. Careful handling and use of electrical power tools	Page 8
Safety advice relating specifically to this device	Page 9
Original accessories / attachments	Page 10

Preparing for use

Information about saw blades	Page 10
Mounting / replacing saw blades	Page 10
Attaching the chip guard	Page 10
Attaching the guide fence	Page 11
Connecting the vacuum sawdust extraction device	Page 11

Operation

Setting the cutting angle	Page 11
Setting the speed	Page 11
Setting the pendulum action	Page 11
Switching On / Off	Page 11

Maintenance and cleaning

Maintenance	Page 11
Cleaning	Page 11













Service centrePage 12

WarrantyPage 12

DisposalPage 12

Declaration of Conformity / ManufacturerPage 13

The following pictograms are used in these operating instructions / on the device:

	Read instruction manual!		Safety class II
	Observe caution and safety notes!		Wear hearing protection, dust protection mask, protective glasses and protective gloves.
	Caution – electric shock! Danger to life!		Keep children away from electrical power tools!
	Explosive material!		For indoor use only!
	Volt (AC)		Risk of loss of life by electric shock from damaged mains lead or mains plug!
	Watts (Effective power)		Dispose packaging and appliance in an environmentally-friendly way!

Jigsaw PPHSS 730 SE**● Introduction**

Please make sure you familiarise yourself fully with the way the device works before you use it for the first time and

that you understand how to handle electrical power tools correctly. To help you do this please read the accompanying operating instructions. Keep these instructions in a safe place. If you pass the device on to anyone else, please ensure that you also pass on all the documentation.

● Proper use

The device is suitable for making straight, curved and bevel cuts in blocks or sheets of plastic, wood and metal. The device is designed to be used in dry rooms and for domestic purposes only. Observe the advice about saw blade types. Any other use or modification to the device shall be considered as improper use and could give rise to considerable dangers. The manufacturer will not accept liability for loss or damage arising from improper use.

● Features and equipment

- 1 Pommel grip
- 2 ON/OFF switch (with stop)
- 3 Housing
- 4 Oscillation speed setting wheel
- 5 Mains connection lead
- 6 Ventilation grill
- 7 Dust extraction spout
- 8 Vacuum extraction duct (see Fig. B)
- 9 Base plate, light metal
- 10 Runner (removable)
- 11 Clamp screw
- 12 Pendulum action switch
- 13 Guide roller
- 14 Saw blade
- 15 Guide fence openings (with locking screws)
- 16 Chip guard
- 17 Contact guard
- 18 Quick-release chuck
- 19 Guide fence
- 20 Allen key
- 21 Stop pin (see Fig. B)

● Included items

- 1 Jigsaw including
 - Dust extraction spout
 - Allen key
 - Chip guard
- 1 Guide fence
- 1 Operating instructions



- 2 Saw blades for wood
- 1 Saw blade for metal

● Technical information

Jigsaw: Parkside PPHSS 730 SE

Rated voltage:	230V ~ 50Hz
Power consumption:	730W
No-load speed:	max. n_0 600-2900 min ⁻¹
Cutting depth:	max. 110 mm
Pendulum action:	3 speeds and a fine cutting setting
Inclined cut:	0-45° left/right
Protection class:	II /

Noise and vibration data:

Values determined in accordance with EN 60745. The sound pressure level (A-weighted) of the device is typically 90 dB (A). Uncertainty K = 3 dB. The sound level while working can exceed 101 dB (A).



Wear ear protection!

Evaluated acceleration, typical:

Hand/arm vibration a_{Hv} = 6,268 m/s²
 Uncertainty K = 1,5 m/s²

⚠ WARNING! The vibration level given in these instructions has been measured in accordance with a standardised measurement procedure specified in EN 60745 and can be used to compare devices. Different uses of the device give rise to different vibration levels and in many cases they may exceed the

values given in these instructions. It is easy to underestimate the vibration load if the electrical power tool is used regularly in particular circumstances.

Note: If you wish to make an accurate assessment of the vibration loads experienced during a particular period of working, you should also take into account the intervening periods of time when the device is switched off or is running but is not actually in use. This can result in a much lower vibration load over the whole of the period of working.





General safety advice for electrical power tools

⚠ WARNING! Read all the safety advice and instructions! Failure to observe the safety advice and instructions may result in electric shock, fire and/or serious injury.

KEEP ALL THE SAFETY ADVICE AND INSTRUCTIONS IN A SAFE PLACE FOR FUTURE REFERENCE! THE TERM "ELECTRICAL TOOL" USED IN THE SAFETY ADVICE REFERS TO ELECTRICAL TOOLS POWERED BY MAINS ELECTRICITY (BY MEANS OF A MAINS LEAD) AND ELECTRICAL TOOLS POWERED BY RECHARGEABLE BATTERIES (WITHOUT A MAINS LEAD).

1. Workplace safety

- a) **Keep your working area clean and well lit.** Untidy or poorly lit working areas can lead to accidents.
- b)  **Do not work with the device in potentially explosive environments in which there are inflammable liquids, gases or dusts.** Electrical power tools create sparks, which can ignite dusts or fumes.
- c)  **Keep children and other people away while you are operating the electrical tool.** Distractions can cause you to lose control of the device.

2. Electrical safety



To avoid danger to life from electric shock:

- a) **The mains plug on the device must match the mains socket. The plug must not be modified in any way. Do not use an adapter plug with devices fitted with a protective earth.** Unmodified plugs and matching sockets reduce the risk of electric shock.
- b) **Avoid touching earthed surfaces such as pipes, radiators, ovens and refrigerators with any part of your body.** There is an increased risk of electric shock if your body is earthed.
- c) **Keep the device away from rain or moisture.** Water entering an electrical device increases the risk of electric shock.
- d)  **Do not use the mains lead for any purpose for which it was not intended, e.g. to carry the device, to hang up the device or to pull the mains plug out of the mains socket. Keep the mains lead away from heat, oil, sharp edges or moving parts of the device.** Damaged or tangled mains leads increase the risk of electric shock.
- e) **When working outdoors with an electrical power tool always use extension cables that are also approved for use outdoors.** The use of an extension cable suitable for outdoor use reduces the risk of electric shock.
- f) **Use a residual current device (RCD) for protection if operating the electrical power tool in a moist environment is unavoidable.** The use of an RCD reduces the risk of electric shock.

3. Personal safety

- a) **Remain alert at all times, watch what you are doing and always proceed with caution. Do not use the device if you are tired or under the influence of**

drugs, alcohol or medication. One moment of carelessness when using the device can lead to serious injury.

- b)  **Wear personal protective equipment and always wear safety glasses.** The wearing of personal protective equipment such as dust masks, non-slip safety shoes, safety helmets or ear protectors, appropriate to the type of electrical power tool used and work undertaken, reduces the risk of injury.
- c) **Avoid unintentional operation of the device. Check that the electrical power tool is switched off before you connect it to the mains, pick it up or carry it.** Accidents can happen if you carry the device with your finger on the ON/OFF switch or with the device switched on.
- d) **Remove any setting tools or spanners before you switch the device on.** A tool or spanner left attached to a rotating part of a device can lead to injury.
- e) **Avoid placing your body in an unnatural position. Keep proper footing and balance at all times.** By doing this you will be in a better position to control the device in unforeseen circumstances.
- f) **Wear suitable clothing. Do not wear loose clothing or jewellery. Keep your hair, clothing and gloves clear of moving parts.** Loose clothing, jewellery or long hair can become trapped in moving parts.
- g) **If vacuum dust extraction and collection devices are fitted do not forget to check that they are properly connected and correctly used.** The use of these devices reduces the hazard presented by dust.

4. Careful handling and use of electrical power tools

- a) **Do not overload the device. Always use an electrical power tool that is intended for the task you are undertaking.** By using the right electrical power tool for the job you will work more safely and achieve a better result.

- b) **Do not use an electrical power tool if its switch is defective.** An electrical power tool that can no longer be switched on and off is dangerous and must be repaired.
- c) **Pull the mains plug out of the socket before you make any adjustments to the device, change accessories or when the device is put away.** This precaution is intended to prevent you from unintentionally starting the device.
- d) **When not in use always ensure that electrical power tools are kept out of reach of children. Do not let anyone use the device if he or she is not familiar with it or has not read the instructions and advice.** Electrical power tools are dangerous when they are used by inexperienced people.
- e) **Look after the device carefully. Check that moving parts are working properly and move freely. Check for any parts that are broken or damaged enough to detrimentally affect the functioning of the device. Have damaged parts repaired before you use the device.** Many accidents have their origins in poorly maintained electrical power tools.
- f) **Keep cutting tools clean and sharp.** Carefully maintained cutting tools with sharp cutting edges are less likely to jam and are easier to control.
- g) **Use the electrical power tool, accessories, inserted tools etc. in accordance with these instructions and advice, and the stipulations drawn up for this particular type of device. In doing this, take into account the working conditions and the task in hand.** The use of electrical power tools for purposes other than those intended can lead to dangerous situations.



Safety advice relating specifically to this device

Avoiding the danger of injury, fire and damage to your health:

- Securely support the workpiece. Use clamps or a vice to grip the workpiece firmly. This is much safer than holding it in your hand.
- Always switch on the electrical power tool before placing it against the workpiece. There is also the risk of kickback.
- Keep your hands away from the area of the saw blade. Do not grip the underside of the workpiece. Contact with the saw blade **14** may result in the risk of injury.
- Make sure that the base plate **9** lies on the workpiece when sawing.
- If a dangerous situation arises, pull the mains plug immediately out of the mains socket.
- Always work with the mains lead leading away from the rear of the device.

⚠ WARNING! NOXIOUS FUMES! Working with harmful / noxious dusts represents a risk to the health of the person operating the device and to anyone near the work area.



Wear protective glasses and a dust mask!

- Do not saw materials containing substances harmful to health.
- Do not saw materials containing asbestos. Asbestos is a known carcinogen.
- When sawing wood and in particular when working on materials that give rise to dusts that are hazardous to health, the device must be connected to a suitable dust extraction device.
- Make sure you have adequate ventilation.
- Do not work on moistened materials or damp surfaces.
- Switch off the electrical power tool after completing each stage of work but do not withdraw the saw blade **14** from the cut until after it has come to a standstill.
- After switching off do not brake the saw blade **14** by pressing it sideways against an object. It could cause the saw blade **14** to be damaged, break or initiate a kickback.

General safety advice for electrical power tools / Preparing for use

- Use only undamaged, defect-free saw blades. Distorted or blunt saw blades can break or cause a kickback.
- Always keep the device clean, dry and free of oil or grease.

● Original accessories / attachments

- Use only the accessories and attachments detailed in the operating instructions. The use of inserted tools or accessories other than those recommended in the operating instructions could lead to you suffering an injury.

● Preparing for use

● Information about saw blades

The Parkside equipment supplied as standard with your tool includes saw blades intended mainly for sawing wood and metal.



1 blade (wood) for quick cutting in softwood (green arrow marking)



1 blade (wood) for clean cutting in softwood (orange arrow marking)



1 blade (special) for metal up to 3 mm thick (black arrow marking)

Note: Use a suitable coolant, e.g. cutting oil. This improves the endurance and increases the service life of the metal saw blade.

Saw blades are available which have been optimally designed for particular tasks. You can use

any of these saw blades provided they have the correct shank fitting (single lug shank).

● Mounting / replacing saw blades

Saw blade type	
Suitable for PPHSS 730 SE	Unsuitable

- ▲ **WARNING!** Pull the mains plug out of the socket before you carry out any task on the device, otherwise there may be risk of injury.
- Turn the quick-release chuck **18** and hold it in the turned position.
- Press the selected saw blade **14** up to the stop in the quick-release chuck **18**. The saw blade **14** should then engage.
- The saw blade **14** must lie in the guide roller **13**.
- Release the quick-release chuck **18**. The chuck must then return to its original position. The saw blade **14** is then locked in place.

● Attaching the chip guard

- Pull the runner **10** off the base plate **9**.
- Insert the chip guard **16** from below into the base plate **9** and slide it into the slots provided. The chip guard can help prevent breaking out of the surface.

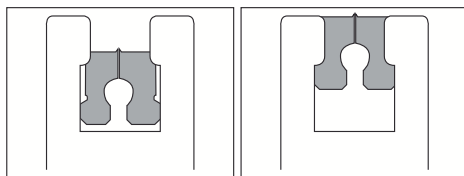

● Attaching the guide fence

The guide fence [19] can be attached on the left or right side of the device (see Fig. A).

- Release the two locking screws of the fence guide openings [15].
- Slide the guide fence [19] into the fence guide openings [15].
- Retighten the two locking screws.

● Connecting the vacuum sawdust extraction device

- Insert the dust extraction spout [7] into the vacuum extraction duct [8] until it engages.
- Connect a vacuum device approved for the extraction of sawdust and splinters to the dust extraction spout [7] (see Fig. C).

● Operation

● Setting the cutting angle

- Release the clamp screw [11] using the Allen key [20].
- Set the cutting angle 0° / 15° / 30° / 45° (left / right) on the base plate [9]. The embossed marking for each recessed line indicates the cutting angle setting. The housing has a stop pin [21] (see Fig. B) which must engage in the appropriate recessed line.
- Tighten the clamp screw [11] using the Allen key [20].

● Setting the speed



- Set the desired speed using the oscillation speed setting wheel [4].
- If possible always determine the optimum setting beforehand by carrying out a practical test.

● Setting the pendulum action

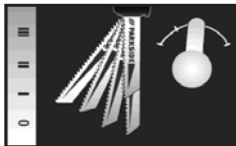

You can set the pendulum movement of the saw blade [14] using the pendulum action switch [12]. By having no pendulum action (setting "0") you can produce fine, clean cut edges. Turn off the pendulum action for thin workpieces.

With the pendulum action activated (settings 1 – 3) you can cut through the workpiece at increasingly quicker rates.

- If possible always determine the optimum setting beforehand using a practical test.

● Switching On/Off

⚠ DANGER! Before connecting to the mains plug check that the mains circuit supplies 230V ~ 50Hz and is fitted with a 16 A fuse or cut-out in accordance with the regulations!

Switching on:

- Push the ON/OFF switch [2] into position "I" and ensure it engages.

Switching off:

- Press the rear part of the ON/OFF switch [2].

● Maintenance and cleaning

● Maintenance

- Replace the saw blade [14] as soon as its teeth become blunt and it starts to produce defective saw cuts.

● Cleaning

- Carry out that cleaning of the device when you have finished sawing.

- Remove dirt (e.g. caused by sawdust or splinters).
Use a dry cloth.

● Service centre

- **⚠ WARNING!** Have your device repaired only by qualified specialist personnel using original manufacturer parts only. This will ensure that your device remains safe to use.
- **⚠ WARNING!** If the plug or mains lead needs to be replaced, always have the replacement carried out by the manufacturer or its service centre. This will ensure that your device remains safe to use.

● Warranty

This appliance is guaranteed for 3 years from the date of purchase. It has been carefully produced and meti-culously checked before delivery. Please keep your receipt as proof of purchase. Contact your service centre by telephone in case of questions pertaining to the warranty. Your goods can be transmitted free of cost only in this manner. This warranty applies only to the initial purchaser and is non-transferable.

The warranty covers only material or manufacturing faults, not normal wear or damage to fragile parts such as switches or rechargeable batteries. The appliance is intended solely for private, not commercial, use.

If this product has been subjected to improper or inappropriate handling, abuse, or interventions not carried out by one of our authorised sales and service outlets, the warranty will be considered void. This warranty does not affect your statutory rights.

GB

DES UK LTD

Tel.: 0871 5000 700 (£ 0,10 / minute)

e-mail: support.uk@kompernass.com

IE

Kompernaß Service Ireland

Tel.: 1850 930 412 (0,082 €/Min.)

* Standard call rates apply.

Mobile operators may vary.

e-mail: support.ie@kompernass.com

● Disposal



The packaging is wholly composed of environmentally-friendly materials that can be disposed of at a local recycling centre.



Do not dispose of electrical power tools with the household rubbish!

In accordance with European Directive 2002/96/EC (covering waste electrical and electronic equipment) and its transposition into national legislation, worn out electrical power tools must be collected separately and taken for environmentally compatible recycling.

Contact your local refuse disposal authority for more details of how to dispose of your worn out electrical devices.

● **Declaration of Conformity /
Manufacturer $\text{C}\ \text{E}$**

We, Kompernaß GmbH, Burgstr. 21,
D-44867 Bochum, Germany, declare that this
product complies with the following EU directives:

**Machinery Directive (89 / 392 / EC),
(91 / 368 / EC), (93 / 44 / EC)**

**EU Low Voltage Directive
(2006 / 95 / EC)**

**Electromagnetic Compatibility
(89 / 336 / EC, 92 / 31 / EC)**

Type / Device description:

Jigsaw PPHSS 730 SE

Bochum, 31.10.2009



Hans Kompernaß
- Managing Director -

We reserve the right to make technical modifica-
tions in the course of product development.

IAN 37833

KOMPERNASS GMBH

Burgstraße 21

D-44867 Bochum

© by ORFGEN Marketing

Last Information Update: 10/2009

Ident.-No.: PPHSS730SE102009-6



Free Manuals Download Website

<http://myh66.com>

<http://usermanuals.us>

<http://www.somanuals.com>

<http://www.4manuals.cc>

<http://www.manual-lib.com>

<http://www.404manual.com>

<http://www.luxmanual.com>

<http://aubethermostatmanual.com>

Golf course search by state

<http://golfingnear.com>

Email search by domain

<http://emailbydomain.com>

Auto manuals search

<http://auto.somanuals.com>

TV manuals search

<http://tv.somanuals.com>