

USER MANUAL

MODEL 1020
and 1020S
**Synchronous Short
Range Modem with
Transformer Isolation**



PATTON
Electronics Co.



*An ISO-9001
Certified Company*

Part #07M1020-C
Doc. #041011UC
Revised 4/20/98

SALES OFFICE
(301) 975-1000
TECHNICAL SUPPORT
(301) 975-1007
<http://www.patton.com>

1.0 WARRANTY INFORMATION

Patton Electronics warrants all Model 1020 components to be free from defects, and will—at our option—repair or replace the product should it fail within one year from the first date of shipment.

This warranty is limited to defects in workmanship or materials, and does not cover customer damage, abuse or unauthorized modification. If this product fails or does not perform as warranted, your sole recourse shall be repair or replacement as described above. Under no condition shall **Patton Electronics** be liable for any damages incurred by the use of this product. These damages include, but are not limited to, the following: lost profits, lost savings and incidental or consequential damages arising from the use of or inability to use this product. **Patton Electronics** specifically disclaims all other warranties, expressed or implied, and the installation or use of this product shall be deemed an acceptance of these terms by the user.

1.1 RADIO AND TV INTERFERENCE

The Model 1020 generates and uses radio frequency energy, and if not installed and used properly—that is, in strict accordance with the manufacturer's instructions—may cause interference to radio and television reception. The Model 1020 has been tested and found to comply with the limits for a Class A computing device in accordance with the specifications in Subpart J of Part 15 of FCC rules, which are designed to provide reasonable protection from such interference in a commercial installation. However, there is no guarantee that interference will not occur in a particular installation. If the Model 1020 does cause interference to radio or television reception, which can be determined by disconnecting the RS-232 interface, the user is encouraged to try to correct the interference by one or more of the following measures: moving the computing equipment away from the receiver, re-orienting the receiving antenna and/or plugging the receiving equipment into a different AC outlet (such that the computing equipment and receiver are on different branches).

1.2 CE NOTICE

The CE symbol on your Patton Electronics equipment indicates that it is in compliance with the Electromagnetic Compatibility (EMC) directive and the Low Voltage Directive (LVD) of the Union European (EU). A Certificate of Compliance is available by contacting Technical Services.

1.3 SERVICE

All warranty and nonwarranty repairs must be returned freight prepaid and insured to Patton Electronics. All returns must have a Return Materials Authorization number on the outside of the shipping container. This number may be obtained from Patton Electronics Technical Services at:

telephone: **(301) 975-1007**
email: **support@patton.com**
web address: **http://www.patton.com**

NOTE: Packages received without an RMA number will not be accepted.

Patton Electronics' technical staff is also available to answer any questions that might arise concerning the installation or use of your Patton Model 1020. Technical Service hours: **8AM to 5PM EST, Monday through Friday.**

2.0 GENERAL INFORMATION

Thank you for your purchase of this Patton Electronics product. This product has been thoroughly inspected and tested and is warranted for One Year parts and labor. If any questions or problems arise during installation or use of this product, please do not hesitate to contact Patton Electronics Technical Support at (301) 975-1007.

2.1 FEATURES

- Supports point-to-point data rates from 1.2 to 19.2 Kbps
- Internal, crystal controlled clock
- Transformer isolation guards against ground looping
- Range to 11 miles
- Full duplex operation
- Custom VLSI chip with separate filter for each data rate
- No AC power or batteries required
- Miniature size
- High speed surge protection (Model 1020S only)

2.2 DESCRIPTION

The **Patton Electronics Model 1020** miniature, synchronous short range modem uses the latest in VLSI technology to combine high-quality data transmission with compact size. The Model 1020 does not require any AC power or batteries to operate, and communicates up to 11 miles in point-to-point environments.

Supporting full duplex transmission over two twisted pairs, the Model 1020 has a crystal controlled internal clock. Data rates are switch selectable from 1200 to 19,200 bps. The Model 1020's custom VLSI chip uses a separate filter for each data rate, rather than a single "compromise" filter. Transformer isolation allows the Model 1020 to operate between buildings without data disruption due to ground potential differences.

The Model 1020S is a surge protected version of the Model 1020, incorporating Silicon Avalanche Diodes that provide 600 watts of protection per wire.

3.0 CONFIGURATION

The Model 1020 provides four configuration switches which allow selection of RTS/CTS delay and data rates. This section describes switch locations and explains all possible switch configurations.

3.1 SWITCH LOCATIONS

For your convenience, all configuration switches are located on a SIP (single in-line package) mounted on the PC board. Figure 1 shows the location of the SIP with respect to other PC board components. For instructions on opening the Model 1020 case, see Section 4.1.2.

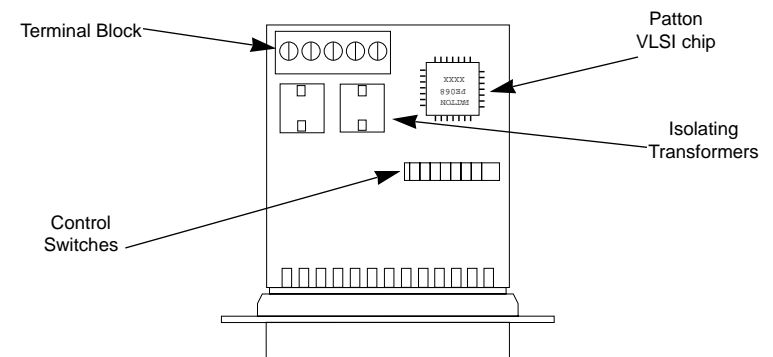

Figure 1. Model 1020 PC board showing switches

Figure 2 shows the orientation of the configuration switches, including the ON/OFF position.

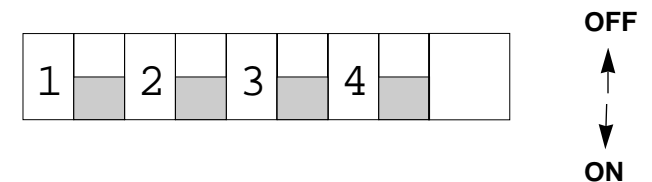

Figure 2. Close-up of configuration switches

3.2 SWITCH SETTINGS

All possible settings for the Model 1020's configuration switches are presented in the summary table and descriptions below. If you have additional questions regarding configuration, contact Patton Technical Support at (301) 975-1007.

SWITCH SUMMARY TABLE		
Position	Function	Factory Default
Switch 1	RTS/CTS delay	On 7 mSec delay
Switch 2	Data Rate	On
Switch 3	Data Rate	Off
Switch 4	Data Rate	Off

Switch 1: RTS/CTS Delay

After request to send (RTS) is raised by the host terminal, the 1020/1020S raises CTS after a slight delay in order to give the remote terminal time to receive an incoming signal. Depending on the type of environment, either a 7mS or 53mS delay can be selected.

Switch 1	Setting
On	7 mS
Off	53 mS

Switches 2, 3 and 4: Data Rate

Switches 2 thru 4 are set in combination to allow the Model 1020 to be used at data rates from 1.2 Kbps up to 19.2 Kbps.

Switch 2	Switch 3	Switch 4	Setting
On	On	On	1.2 Kbps
On	On	Off	2.4 Kbps
On	Off	On	4.8 Kbps
Off	On	On	7.2 Kbps
On	Off	Off	9.6 Kbps
Off	On	Off	14.4 Kbps
Off	Off	On	19.2 Kbps
Off	Off	Off	19.2 Kbps

Once the Model 1020 is properly configured, it is ready to connect to your system. This section tells you how to properly connect the Model 1020 to the twisted pair and RS-232 interfaces, and how to operate the Model 1020.

4.1 CONNECTION TO THE TWISTED PAIR INTERFACE

The Model 1020 supports data-only communication between two RS-232 devices at distances to 11 miles and data rates to 19.2 Kbps. There are two essential requirements for installing the Model 1020:

1. These units work in **pairs**. Therefore, you must have one Model 1020 at each end of a two twisted pair interface.
2. To function properly, the Model 1020 needs two twisted pairs of metallic wire. These pairs must be **unconditioned**, dry, metallic wire, between 19 and 26 AWG (the higher number gauges may limit distance somewhat). Standard dial-up telephone circuits, or leased circuits that run through signal equalization equipment, are **not acceptable**.

For your convenience, the Model 1020 is available with three different twisted pair interfaces: RJ-11 jack, RJ-45 jack and terminal blocks with strain relief.

4.1.1 TWISTED PAIR CONNECTION USING RJ-11 OR RJ-45

The RJ-11 and RJ-45 connectors on the Model 1020's twisted pair interface are pre-wired for a standard TELCO wiring environment. The signal/pin relationships are shown below:

RJ-11	SIGNAL	RJ-45	SIGNAL
1.....	GND [†]	1	N/C
2.....	RCV [‡]	2	GND [†]
3.....	XMT	3	RCV [‡]
4.....	XMT	4	XMT
5.....	RCV	5	XMT
6.....	GND	6	RCV
		7	GND
		8	N/C

[†]Connection to ground is optional

[‡]The Model 1020 is not polarity sensitive

When connecting two Model 1020s it is necessary to use a "crossover" cable. The diagram below shows how a crossover cable should be constructed for an environment where both Model 1020s use a 6-wire RJ-11 connector. Similar logic should be followed when using RJ-45 connectors or a combination of the two.

SIGNAL	PIN#	COLOR	COLOR	PIN#	SIGNAL
GND [†]	1	Blue [°]	White	6	GND
RCV [‡]	2	Yellow	Red	4	XMT
XMT	3	Green.....	Black	5	RCV
XMT	4	Red	Yellow	2	RCV
RCV	5	Black.....	Green	3	XMT
GND	6	White	Blue	1	GND

[†]Connection to ground is optional
[°]Standard color codes—yours may be different
[‡]The Model 1020 is not sensitive to polarity

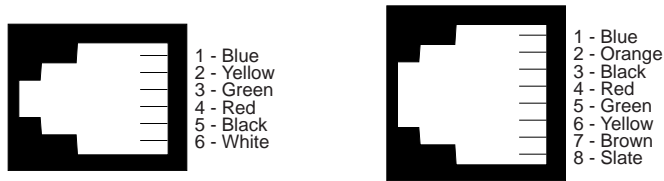

Standard AT&T color codes

4.1.2 TWISTED PAIR CONNECTION USING TERMINAL BLOCKS

If your application requires you to connect two pairs of bare wires to the Model 1020, you will need to open the case to access the terminal blocks. The instructions on the following pages will tell you how to open the case, connect the bare wires to the terminal blocks, and fasten the strain relief collar in place so that the wires won't pull loose.

1. Open the unit by gently inserting a screw driver between the DB-25 connector and the lip of the plastic case (see below). You don't have to worry about breaking the plastic, but be careful not to bend the D-sub connector.

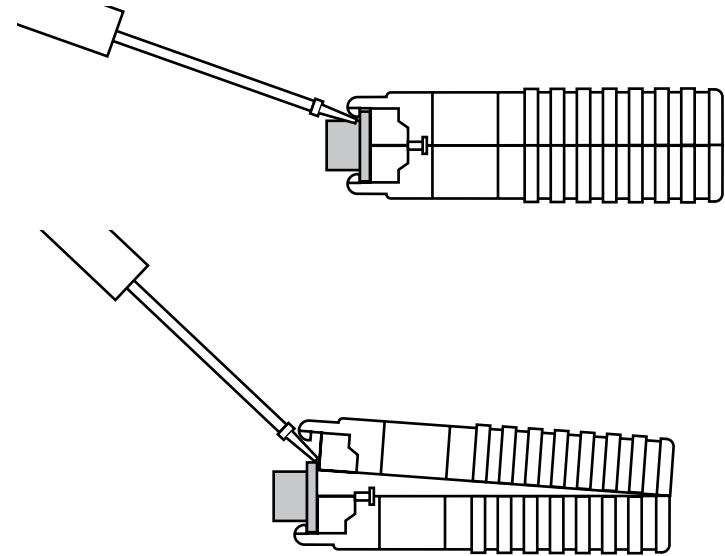

Once the unit has been opened, you will be able to see the terminal blocks located at the rear of the PC board.

2. Strip the outer insulation from the twisted pairs about one inch from the end.

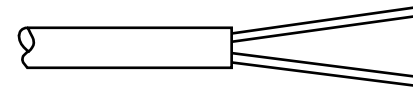

3. Strip back the insulation on each of the 2 twisted pair wires about .25".

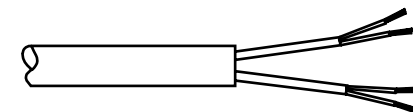

4. Connect *one pair* of wires to the two XMT (transmit) poles on the terminal block, making careful note of which colors you use. The Model 1020 is not polarity sensitive, so either wire may connect to either pole.
5. Connect the *other pair* of wires to the two RCV (receive) poles on the terminal block, making careful note of which colors you use. The Model 1020 is not polarity sensitive, so either wire may connect to either pole.

Ultimately, you will want to construct a two pair crossover cable that makes a connection with the two Model 1020s as shown below:

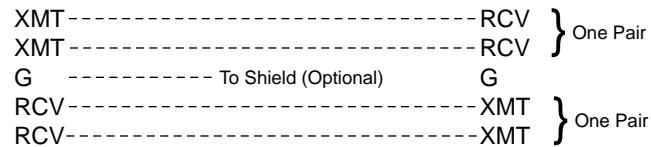

6. If there is a shield around the telephone cable, it may be connected to "G" on the terminal block. To avoid ground loops, we recommend connecting the shield at the computer end only. A ground wire is *not necessary* for proper operation of the Model 1020.
7. When you finish connecting the wires to the terminal block, the assembly should resemble the diagram below:

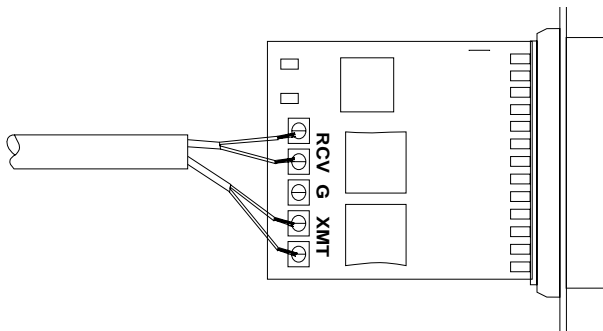

8. Place the 2 halves of the strain relief assembly on either side of the telephone wire and press together very lightly. Slide the assembly so that it is about 2 inches from the terminal posts and press together firmly. If your cable diameter is too small or too large for our strain relief, please contact our technical support. We have strain relief assemblies to accommodate most cable diameters.

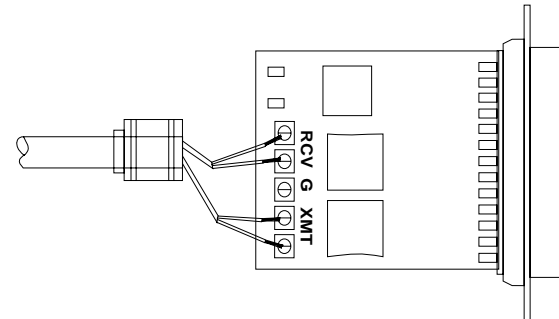

9. Insert the strain relief assembly with the wire going through it into the slot in the bottom half of the modem case and set it into the recess in the case.

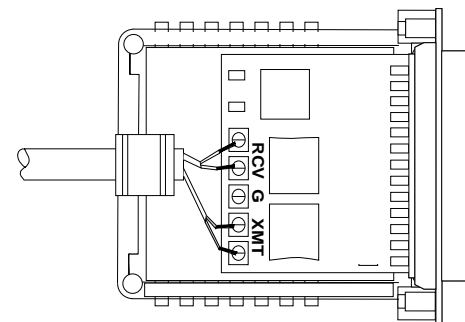

10. BEND the top half of the case as necessary to place it over the strain relief assembly. Do not snap the case together yet.

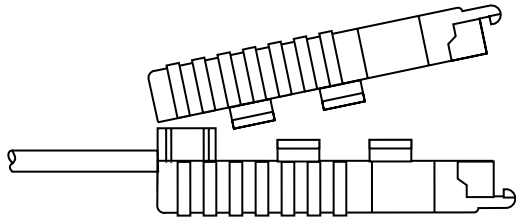

11. Insert one captive screw through a saddle washer and then insert the entire piece through the hole in the DB-25 end of the case. Snap that side of the case closed. Repeat the process for the other side. This completes cable installation.

4.2 CONNECTION TO THE RS-232 INTERFACE

Once you have connected the twisted pair wires correctly, simply plug the Model 1020 directly into the DB-25 port of the RS-232 device. After doing so, remember to insert and tighten the two captive connector screws.

(Note: If you must use a cable to connect the Model 1020 to the RS-232 device, make sure it is a *straight through* cable of the shortest possible length—we recommend 6 feet or less).

4.3 OPERATING THE MODEL 1020

Once the Model 1020 is properly configured and installed, it should operate transparently—as if it were a standard cable connection. Operating power is derived from the RS-232 data and control signals; there is no “ON/OFF” switch. All data signals from the RS-232 interface are passed straight through. All control signals from the RS-232 interface are looped back.

NOTE: If your system requires *hardware* flow control, you will need the Patton Model 1030 or Model 1070 Short Range Modem. Call Patton Customer Service at 301-975-1007 for more information.

APPENDIX A SPECIFICATIONS

Transmission Format: Synchronous, full duplex

Transmission Line: Two unconditioned twisted pair 19 - 26 AWG

Range: (See table below)

Interfaces: EIA RS-232, CCITT V.24

Data Rates: 1200 - 19.2 Kbps

Isolation: Minimum 1500 V RMS via custom transformers

Surge Protection: 600W Surge Protection (10x1000µs waveform)
(Model 1020S)

Control Signals: CTS turns on 7 or 53 mS (switch selectable)
after the terminal raises RTS; DSR and DCD are constantly on

Connectors: DB-25 male or female on RS-232 side;
RJ-11, RJ-45 or terminal block with strain relief on line side

Power Supply: None required; uses power from EIA data and
control signals

Temperature Range: 0-60°C (32-140°F)

Altitude: 0-15,000 feet

Humidity: Up to 95% non-condensing

Weight: 2 oz.

Dimensions: 2.66" x 2.10" x 0.73"

Model 1020 Distance Table (miles)			
Data Rate	Wire Gauge		
	19	24	26
19,200	7.5	3.5	2.5
9,600	10.0	3.5	2.5
4,800	10.0	7.0	4.0
2,400	10.0	8.5	5.0
1,200	11.0	8.5	6.0

**APPENDIX B
RS-232 PIN CONFIGURATIONS**

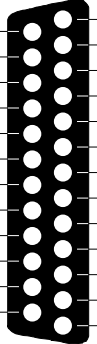
DIRECTION	"DCE" STANDARD SETTING	DIRECTION
To Model 1020	Transmitter Timing - 15 	To Model 1020
To Model 1020	Receiver Timing - 17	From Model 1020 To Model 1020
To Model 1020	Data Term. Ready (DTR) - 20	From Model 1020 From Model 1020 From Model 1020

Free Manuals Download Website

<http://myh66.com>

<http://usermanuals.us>

<http://www.somanuals.com>

<http://www.4manuals.cc>

<http://www.manual-lib.com>

<http://www.404manual.com>

<http://www.luxmanual.com>

<http://aubethermostatmanual.com>

Golf course search by state

<http://golfingnear.com>

Email search by domain

<http://emailbydomain.com>

Auto manuals search

<http://auto.somanuals.com>

TV manuals search

<http://tv.somanuals.com>