

# USER MANUAL

---

MODEL 1025  
and 1025S  
**Synchronous Short  
Range Modem with  
Clocking Options**



**PT PATTON**  
**IE Electronics Co.**



*An ISO-9001  
Certified Company*

Part #07M1025-C  
Doc. #041012UC  
Revised 4/20/98

SALES OFFICE  
(301) 975-1000  
TECHNICAL SUPPORT  
(301) 975-1007  
<http://www.patton.com>

## 1.0 WARRANTY INFORMATION

**Patton Electronics** warrants all Model 1025 components to be free from defects, and will—at our option—repair or replace the product should it fail within one year from the first date of shipment.

This warranty is limited to defects in workmanship or materials, and does not cover customer damage, abuse or unauthorized modification. If this product fails or does not perform as warranted, your sole recourse shall be repair or replacement as described above. Under no condition shall **Patton Electronics** be liable for any damages incurred by the use of this product. These damages include, but are not limited to, the following: lost profits, lost savings and incidental or consequential damages arising from the use of or inability to use this product.

**Patton Electronics** specifically disclaims all other warranties, expressed or implied, and the installation or use of this product shall be deemed an acceptance of these terms by the user.

### 1.1 RADIO AND TV INTERFERENCE

The Model 1025 generates and uses radio frequency energy, and if not installed and used properly—that is, in strict accordance with the manufacturer's instructions—may cause interference to radio and television reception. The Model 1025 has been tested and found to comply with the limits for a Class A computing device in accordance with the specifications in Subpart J of Part 15 of FCC rules, which are designed to provide reasonable protection from such interference in a commercial installation. However, there is no guarantee that interference will not occur in a particular installation. If the Model 1025 does cause interference to radio or television reception, which can be determined by disconnecting the RS-232 interface, the user is encouraged to try to correct the interference by one or more of the following measures: moving the computing equipment away from the receiver, re-orienting the receiving antenna and/or plugging the receiving equipment into a different AC outlet (such that the computing equipment and receiver are on different branches).

### 1.2 CE NOTICE

The CE symbol on your Patton Electronics equipment indicates that it is in compliance with the Electromagnetic Compatibility (EMC) directive and the Low Voltage Directive (LVD) of the Union European (EU). A Certificate of Compliance is available by contacting Technical Services.

## 1.3 SERVICE

All warranty and nonwarranty repairs must be returned freight prepaid and insured to Patton Electronics. All returns must have a Return Materials Authorization number on the outside of the shipping container. This number may be obtained from Patton Electronics Technical Services at:

telephone: **(301) 975-1007**  
email: **support@patton.com**  
web address: **http://www.patton.com**

**NOTE:** Packages received without an RMA number will not be accepted.

Patton Electronics' technical staff is also available to answer any questions that might arise concerning the installation or use of your Patton Model 1025. Technical Service hours: **8AM to 5PM EST, Monday through Friday.**

## 2.0 GENERAL INFORMATION

Thank you for your purchase of this Patton Electronics product. This product has been thoroughly inspected and tested and is warranted for One Year parts and labor. If any questions or problems arise during installation or use of this product, please do not hesitate to contact Patton Electronics Technical Support at (301) 975-1007.

### 2.1 FEATURES

- Supports data rates to 19.2 Kbps
- Internal, external or receive loopback clocking
- Transformer isolation guards against ground looping
- Range to 11 miles
- Operates full duplex over two unconditioned twisted pair
- Customized VLSI chip with separate filter for each data rate
- No AC power or batteries required
- Miniature size
- Silicon Avalanche Diode surge protection (Model 1025S)

### 2.2 DESCRIPTION

The Patton Electronics Model 1025 miniature, synchronous short range modem uses the latest in VLSI technology to combine high-quality data transmission with compact size. The Model 1025 does not require any AC power or batteries to operate, and communicates up to 11 miles in point-to-point environments. For maximum flexibility, the Model 1025 supports three clocking options: internal, external or receive loopback.

Providing full duplex transmission over two twisted pair, the Model 1025 accommodates seven switch selectable data rates from 1200 to 19,200 bps. The Model 1025's custom VLSI chip uses a separate filter for each data rate, rather than a single "compromise" filter. Transformer isolation allows the Model 1025 to operate between buildings without data disruption due to ground potential differences.

The Model 1025S is a surge protected version of the Model 1025, incorporating Silicon Avalanche Diodes that provide 600 watts of protection per wire.

## 3.0 CONFIGURATION

The Model 1025 provides six configuration switches which allow selection of clocking method, RTS/CTS delay and data rate. This section describes switch locations and explains all possible switch configurations.

### 3.1 SWITCH LOCATIONS

For your convenience, all configuration switches are located on a SIP (single in-line package) mounted on the PC board. Figure 1 shows the location of the SIP with respect to other PC board components. For instructions on opening the Model 1025 case, see Section 4.1.2.

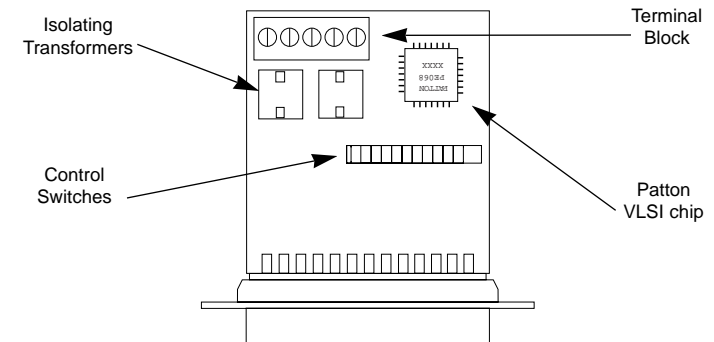

Figure 1. Model 1025 PC board showing switches

Figure 2 shows the orientation of the configuration switches, including ON/OFF position.

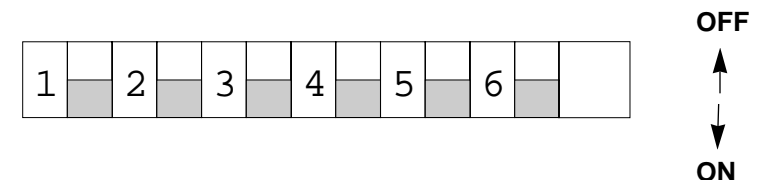

Figure 2. Close-up of configuration switches

### 3.2 SWITCH SETTINGS

All possible settings for the Model 1025's configuration switches are presented in the summary table and descriptions below. If you have additional questions regarding configuration, contact Patton Technical Support at (301) 975-1007.

SWITCH SUMMARY TABLE		
Position	Function	Factory Default
Switch 1	Transmit Clock	Off
Switch 2	Transmit Clock	On
Switch 3	RTS/CTS delay	On 7 mSec delay
Switch 4	Data Rate	On
Switch 5	Data Rate	Off
Switch 6	Data Rate	Off

#### Switches 1 and 2: Transmit Clock

Switches 1 and 2 are used together to specify the clocking method. The Model 1025 can provide an internal clock (Pin 15), receive an external clock (from Pin 24), or loopback a received clock.

Switch 1	Switch 2	Setting
On	On	External Clock
On	Off	External Clock
Off	On	Internal Clock (Default)
Off	Off	Receive Loopback

#### Switch 3: RTS/CTS Delay

After request to send (RTS) is raised by the host terminal, the Model 1025 raises CTS after a delay in order to give the remote terminal time to receive an incoming signal. Depending on the type of environment, either a 7mS or 53mS delay can be selected.

Switch 3	Setting
On	7 mS (Default)
Off	53 mS

#### Switches 4, 5 and 6: Data Rate

Switches 4 thru 6 are set in combination to allow the Model 1025 to be used at data rates from 1.2 to 19.2 Kbps.

Switch 4	Switch 5	Switch 6	Setting
On	On	On	1.2 Kbps
On	On	Off	2.4 Kbps
On	Off	On	4.8 Kbps
Off	On	On	7.2 Kbps
On	Off	Off	9.6 Kbps (Default)
Off	On	Off	14.4 Kbps
Off	Off	On	19.2 Kbps
Off	Off	Off	19.2 Kbps

## 4.0 INSTALLATION

Once the Model 1025 is properly configured, it is ready to connect to your system. This section tells you how to properly connect the Model 1025 to the twisted pair and RS-232 interfaces, and how to operate the Model 1025.

### 4.1 CONNECTION TO THE TWISTED PAIR INTERFACE

The Model 1025 supports data-only communication between two RS-232 devices at distances to 11 miles and data rates to 19.2 Kbps. There are two essential requirements for installing the Model 1025:

1. These units work in **pairs**. Therefore, you must have one Model 1025 at each end of a two twisted pair interface.
2. To function properly, the Model 1025 needs two twisted pairs of metallic wire. These pairs must be **unconditioned**, dry metallic wire, between 19 and 26 AWG (the higher number gauges may limit distance somewhat). Standard dial-up telephone circuits, or leased circuits that run through signal equalization equipment, are *not acceptable*.

For your convenience, the Model 1025 is available with three different twisted pair interfaces: RJ-11 jack, RJ-45 jack and terminal blocks with strain relief.

#### 4.1.1 TWISTED PAIR CONNECTION USING RJ-11 OR RJ-45

The RJ-11 and RJ-45 connectors on the Model 1025's twisted pair interface are pre-wired for a standard TELCO wiring environment. The signal/pin relationships are shown below:

<u>RJ-11</u>	<u>SIGNAL</u>	<u>RJ-45</u>	<u>SIGNAL</u>
1.....	GND <sup>†</sup>	1.....	N/C
2.....	RCV <sup>†</sup>	2.....	GND <sup>†</sup>
3.....	XMT	3.....	RCV <sup>†</sup>
4.....	XMT	4.....	XMT
5.....	RCV	5.....	XMT
6.....	GND	6.....	RCV
		7.....	GND
		8.....	N/C

<sup>†</sup>Connection to ground is optional

<sup>†</sup>The Model 1025 is not polarity sensitive

When connecting two Model 1025s, it is necessary to use a "crossover" cable. The diagram below shows how a crossover cable should be constructed for an environment where both Model 1025s use a 6-wire RJ-11 connector. Similar logic should be followed when using RJ-45 connectors or a combination of the two.

<u>SIGNAL</u>	<u>PIN#</u>	<u>COLOR</u>	<u>COLOR</u>	<u>PIN#</u>	<u>SIGNAL</u>
GND <sup>†</sup>	1	Blue <sup>†</sup> .....	White	6	GND
RCV <sup>†</sup>	2	Yellow .....	Red	4	XMT
XMT	3	Green.....	Black	5	RCV
XMT	4	Red .....	Yellow	2	RCV
RCV	5	Black.....	Green	3	XMT
GND	6	White .....	Blue	1	GND

<sup>†</sup>Connection to ground is optional

<sup>†</sup>Standard color codes—yours may be different

<sup>†</sup>The Model 1025 is not sensitive to polarity

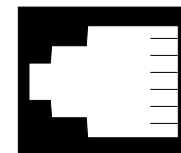

1 - Blue  
2 - Yellow  
3 - Green  
4 - Red  
5 - Black  
6 - White

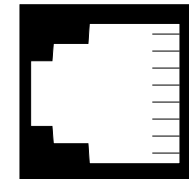

1 - Blue  
2 - Orange  
3 - Black  
4 - Red  
5 - Green  
6 - Yellow  
7 - Brown  
8 - Slate

Standard AT&T color codes

#### 4.1.2 TWISTED PAIR CONNECTION USING TERMINAL BLOCKS

If your application requires you to connect two pairs of bare wires to the Model 1025, you will need to open the case to access the terminal blocks. The instructions on the following pages will tell you how to open the case, connect the bare wires to the terminal blocks, and fasten the strain relief collar in place so that the wires won't pull loose.

1. Open the unit by gently inserting a screwdriver between the DB-25 connector and the lip of the plastic case (see below). You don't have to worry about breaking the plastic, but be careful not to bend the D-sub connector.

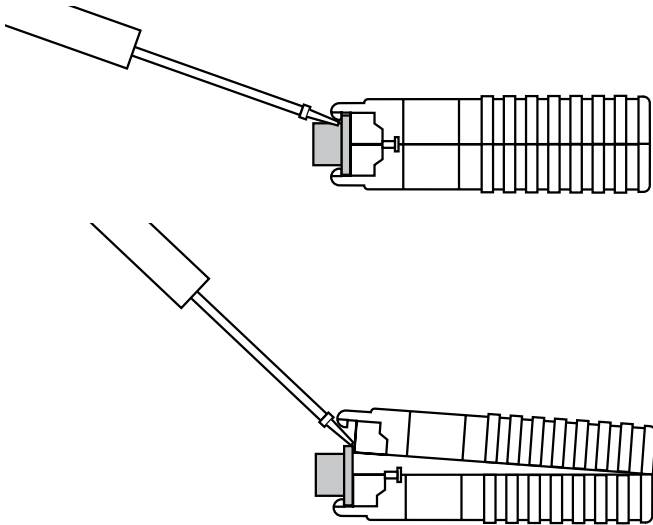

Once the unit has been opened, you will be able to see the terminal blocks located at the rear of the PC board.

2. Strip the outer insulation from the twisted pairs about one inch from the end.

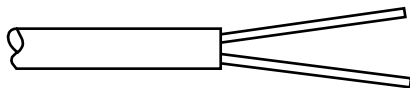

3. Strip back the insulation on each of the 2 twisted pair wires about .25".

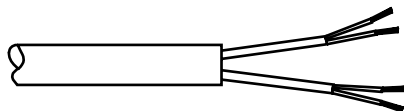

a

4. Connect *one pair* of wires to the two XMT (transmit) poles on the terminal block. The Model 1025 is not polarity sensitive, so either wire may connect to either pole.
5. Connect the *other pair* of wires to the two RCV (receive) poles on the terminal block. The Model 1025 is not polarity sensitive, so either wire may connect to either pole.

Ultimately, you will want to construct a two pair crossover cable that makes a connection with the two Model 1025s as shown below:

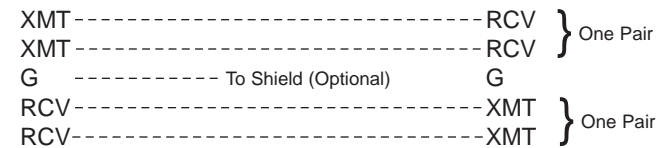

6. If there is a shield around the telephone cable it may be connected to "G" on the terminal block. To avoid ground loops, we recommend connecting the shield at the computer end only. A ground wire is *not necessary* for proper operation of the Model 1025.
7. When you finish connecting the wires to the terminal block, the assembly should resemble the diagram below:

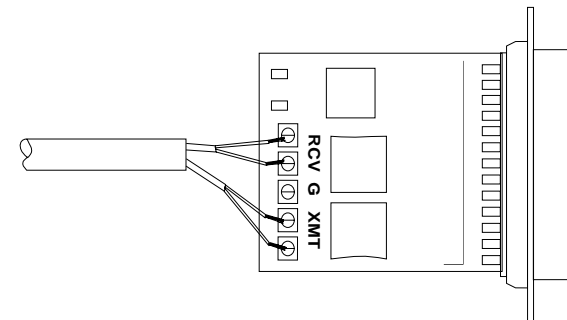

10

8. Place the 2 halves of the strain relief assembly on either side of the telephone wire and press together very lightly. Slide the assembly so that it is about 2 inches from the terminal posts and press together firmly. If your cable diameter is too small or too large for our strain relief, please contact our technical support. We have strain relief assemblies to accommodate most cable diameters.

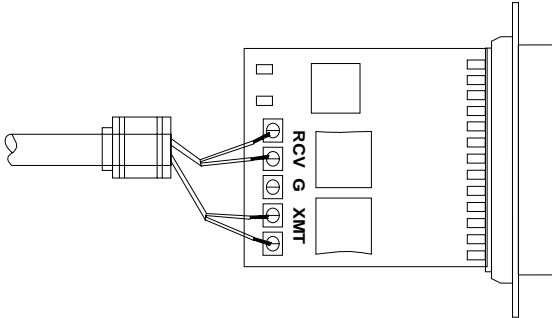

9. Insert the strain relief assembly and wire going into the slot in the bottom half of the modem case and set it into the recess in the case.

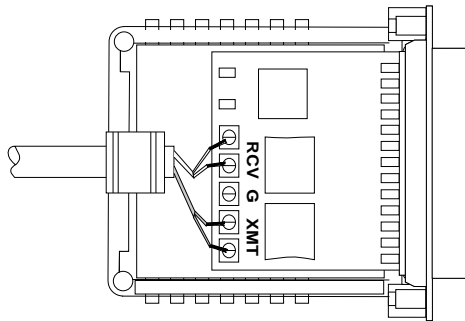

10. Place the top half of the case as necessary to slide it over the strain relief assembly. Do not snap the case together yet.

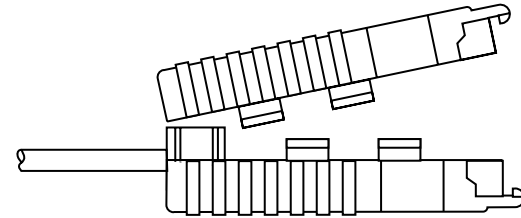

11. Insert one captive screw through a saddle washer. Then insert the entire piece through the hole in the DB-25 end of the case. Snap that side of the case closed. Repeat the process for the other side. This completes cable installation.

## 4.2 CONNECTION TO THE RS-232 INTERFACE

Once you have connected the twisted pair wires correctly, simply plug the Model 1025 directly into the DB-25 port of the RS-232 device. After doing so, remember to insert and tighten the two captive connector screws.

### 4.2.1 CONNECTION TO A "DTE" DEVICE

The Model 1025 is wired as a DCE, and therefore wants to plug into a DTE such as a terminal, PC or host. Because the Model 1025 is interface powered, a direct connection to the RS-232 DTE port is most desirable. If you must use a cable to connect the Model 1025 to the DTE port, make sure it is a *straight through* cable of the shortest possible length—we recommend 6 feet or less.

APPENDIX A  
SPECIFICATIONS

4.2.2 CONNECTION TO A “DCE” DEVICE

Since the Model 1025 is wired as a DCE, you cannot connect it directly to another DCE such as a modem, multiplexer or printer. If you need to connect the Model 1025 to another DCE device, you must use a *null modem cable* wired according to diagram below. We recommend that the cable is as short as possible, preferably 6 feet or less.

Connection to Model 1025 <sup>†</sup> DB-25 Pin No.	Connection to DCE Device DB-25 Pin No.
1.....	1
2.....	3
3.....	2
4.....	8
8.....	4
6.....	20
20.....	6
17.....	24
24.....	17
7.....	7

<sup>†</sup>Note: When connecting to another DCE device, the Model 1025 should be configured for “external clock” (see Section 3.2).

4.3 OPERATING THE MODEL 1025

Once the Model 1025 is properly configured and installed, it should operate transparently—as if it were a standard cable connection. Operating power is derived from the RS-232 data and control signals; there is no “ON/OFF” switch. All data signals from the RS-232 interface are passed straight through. All control signals from the RS-232 interface are looped back.

Note: If your system requires *hardware* flow control, you will need the Patton Model 1030 or Model 1070 Short Range Modem. Call Patton Customer Service at (301) 975-1007 for more information.

**Transmission Format:** Synchronous, full duplex

**Transmission Line:** Two unconditioned twisted pair 19 - 26 AWG

**Clocking:** Internal, external or receive loopback

**Range:** (See table below)

**Interfaces:** EIA RS-232, CCITT V.24

**Data Rates:** 1.2 - 19.2 Kbps

**Isolation:** Minimum 1500 V RMS via custom transformers

**Surge Protection:** 600W Surge Protection (10x1000µs waveform) (Model 1025S)

**Control Signals:** CTS turns on 8 or 53 mS (switch selectable) after the terminal raises RTS; DSR and DCD are constantly on

**Connectors:** DB-25 male or female on RS-232 side; RJ-11, RJ-45 or terminal block with strain relief on line side

**Power Supply:** No external power required; uses power from EIA data and control signals

**Temperature Range:** 0-60°C (32-140°F)

**Altitude:** 0-15,000 feet

**Humidity:** Up to 95% non-condensing

**Dimensions:** 2.66” x 2.10” x 0.73”

**Weight:** 2 oz.

Model 1025 Distance Table (miles)			
Data Rate	Wire Gauge		
	19	24	26
19,200	7.5	3.5	2.5
9,600	10.0	3.5	2.5
4,800	10.0	7.0	4.0
2,400	10.0	8.5	5.0
1,200	11.0	8.5	6.0



APPENDIX B  
RS-232 PIN CONFIGURATIONS

DIRECTION	"DCE" STANDARD SETTING	DIRECTION
From Model 1025	Transmitting Timing - 15	To Model 1025
From Model 1025	Receiver Timing - 17	From Model 1025
To Model 1025	Data Term. Ready (DTR) - 20	To Model 1025
To Model 1025	Transmitting Timing (LXC) - 24	From Model 1025

## Free Manuals Download Website

<http://myh66.com>

<http://usermanuals.us>

<http://www.somanuals.com>

<http://www.4manuals.cc>

<http://www.manual-lib.com>

<http://www.404manual.com>

<http://www.luxmanual.com>

<http://aubethermostatmanual.com>

Golf course search by state

<http://golfingnear.com>

Email search by domain

<http://emailbydomain.com>

Auto manuals search

<http://auto.somanuals.com>

TV manuals search

<http://tv.somanuals.com>