

USER MANUAL

MODEL 2085 High Speed RS-232 to RS-485 Interface Converter



PA PATTON
Electronics Co.



*An ISO-9001
Certified Company*

Part# 07M2085-D
Doc# 047033U,
Rev. E
Revised 1/22/08

SALES OFFICE
(301) 975-1000
TECHNICAL SUPPORT
(301) 975-1007
<http://www.patton.com>

1.0 WARRANTY INFORMATION

Patton Electronics warrants all Model 2085 components to be free from defects, and will—at our option—repair or replace the product should it fail within one year from the first date of shipment.

This warranty is limited to defects in workmanship or materials, and does not cover customer damage, abuse or unauthorized modification. If this product fails or does not perform as warranted, your sole recourse shall be repair or replacement as described above. Under no condition shall **Patton Electronics** be liable for any damages incurred by the use of this product. These damages include, but are not limited to, the following: lost profits, lost savings and incidental or consequential damages arising from the use of or inability to use this product. **Patton Electronics** specifically disclaims all other warranties, expressed or implied, and the installation or use of this product shall be deemed an acceptance of these terms by the user.

1.1 RADIO AND TV INTERFERENCE

The Model 2085 generates and uses radio frequency energy, and if not installed and used properly—that is, in strict accordance with the manufacturer's instructions—may cause interference to radio and television reception. The Model 2085 has been tested and found to comply with the limits for a Class A computing device in accordance with the specifications in Subpart J of Part 15 of FCC rules, which are designed to provide reasonable protection from such interference in a commercial installation. However, there is no guarantee that interference will not occur in a particular installation. If the Model 2085 does cause interference to radio or television reception, which can be determined by disconnecting the RS-232 interface, the user is encouraged to try to correct the interference by one or more of the following measures: moving the computing equipment away from the receiver, re-orienting the receiving antenna and/or plugging the receiving equipment into a different AC outlet (such that the computing equipment and receiver are on different branches).

1.2 CE NOTICE

The CE symbol on your Patton Electronics equipment indicates that it is in compliance with the Electromagnetic Compatibility (EMC) directive and the Low Voltage Directive (LVD) of the Union European (EU). A Certificate of Compliance is available by contacting Technical Support.

1.3 SERVICE

All warranty and non-warranty repairs must be returned freight prepaid and insured to Patton Electronics. All returns must have a Return Materials Authorization number on the outside of the shipping container. This number may be obtained from Patton Electronics Technical Service: **(301) 975-1007, <http://www.patton.com>; support@patton.com**. *Packages received without an RMA number will not be accepted.*

Patton Electronics' technical staff is also available to answer any questions that might arise concerning the installation or use of your Model 2085. Technical Service hours: **8AM to 5PM EST, Monday through Friday.**

2.0 GENERAL INFORMATION

Thank you for your purchase of this Patton Electronics product. This product has been thoroughly inspected and tested and is warranted for One Year parts and labor. If any questions or problems arise during installation or use of this product, please do not hesitate to contact Patton Electronics Technical Support at (301) 975-1007.

2.1 FEATURES

- Operates asynchronously, point to point or multipoint, over 2 or 4 wires
- Up to 50 multipoint device drops in a polling environment
- Data rates to 115.2 Kbps
- Passes transmit & receive data, one control signal each direction
- No AC power or batteries are required
- Variable high/low impedance settings
- Able to operate with or without “echo”
- Carrier can be set as “constantly on” or “controlled by RTS”
- Compact size (2.66” x 2.10” x 0.73”)
- Twisted pair connection via strain relief, RJ-11 or RJ-45
- Silicon Avalanche Diode surge protection

2.2 DESCRIPTION

The Model 2085 High Speed RS-232 to RS-485 Interface Converter provides exceptional versatility in a compact package. Requiring no AC power or batteries for operation, the Model 2085 supports asynchronous RS-232 data rates to 115.2 Kbps over one or two unconditioned twisted pair.

The Model 2085 passes one control signal in each direction and can handle up to 50 terminal drops in a multipoint polling environment. The Model 2085 may be configured for high or low impedance operation, carrier may be set to “constantly on” or “controlled by RTS”, and the unit can operate with or without “echo”. RTS/CTS delay may be set for “no delay” or 8 mS.

The Model 2085 is equipped with either male or female DB-25 for RS-232 connection. Options for twisted pair connection include terminal blocks with strain relief, RJ-11, RJ-45 and DB-25 male or female. Silicon Avalanche Diodes provide 600 watts per wire of protection against harmful data line transient surges.

3.0 CONFIGURATION

The Model 2085 is configured using an eight position DIP switch and a DCE/DTE switch. Figure 1 (below) shows the location of the DCE/DTE switch (externally accessible) on the PC board, as well as the power supply daughter board and terminal block.

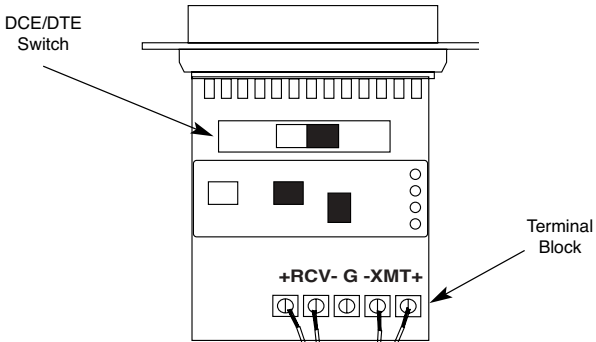

Figure 1. Top view of Model 2085 board, showing DCE/DTE switch.

Figure 2 (below) shows the location of the eight position DIP switch on the underside of the Model 2085 PC board. Figure 3 (following page) shows the orientation of the eight position DIP switch, with respect to ON/OFF positions.

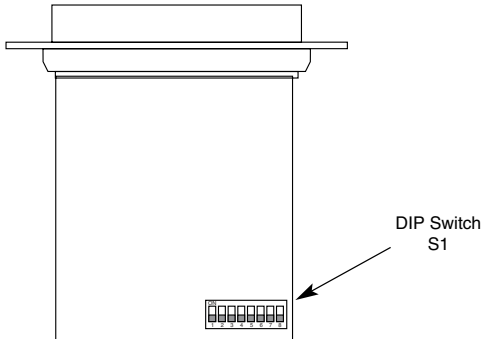

Figure 2. Bottom view of Model 2085 board, showing (internal) DIP switch.

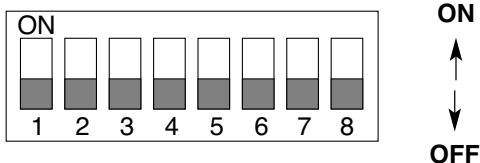

Figure 3. Close-up of DIP switch showing "ON" and "OFF" positions

3.1 SETTING THE DCE/DTE SWITCH

For your convenience, the Model 2085 has an externally accessible DCE/DTE switch. If the device connected to the Model 2085 is a modem or multiplexer (or is wired like one), set the switch to "DTE". This setting causes the Model 2085 to behave like Data Terminal Equipment and transmit data on pin 2. If the device connected to the Model 2085 is a PC, terminal or host computer (or is wired like one), set the switch to "DCE". This setting causes the Model 2085 to behave like Data Communications Equipment and transmit data on pin 3.

3.2 DIP SWITCH CONFIGURATION

The eight switches on switch set S1 (see Figure 3, above) configure the Model 2085 for echo mode, carrier control method, RTS/CTS delay, "transmit off" impedance, receive impedance, and 2-wire/4-wire operation. These switches are located *internally* on the Model 2085's PC board. To access switch set S1, use a small flat blade screwdriver to pop open the Model 2085's case as shown in Figure 4, below.

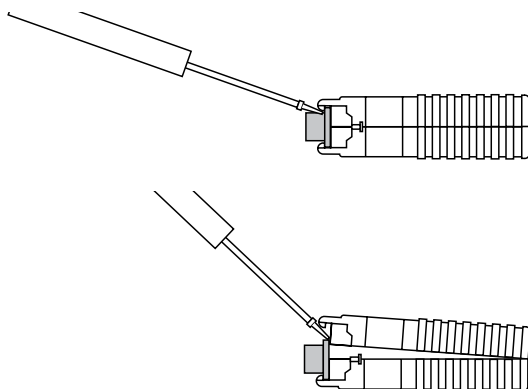

Figure 4. Opening the Model 2085's plastic case with a small screwdriver

3.3 DIP SWITCH SETTINGS

All possible settings for the Model 2085's configuration switches are presented in Figure 5 (below). Following Figure 5 is a detailed description of each switch function. If you have additional questions,

S1 SUMMARY TABLE			
Position	Function	Factory Default	
S1-1*	"Transmit Off" Impedance	Off	} High Z
S1-2*	"Transmit Off" Impedance	Off	
S1-3	RTS/CTS Delay	On	8 msec
S1-4	"ECHO" Mode	Off	Echo Off
S1-5	Carrier Control	On	RTS Cont.
S1-6	Receive Impedance	On	120 Ohm
S1-7*	2-Wire/4-Wire	On	} 2-Wire
S1-8*	2-Wire/4-Wire	On	

Figure 5. Summary of DIP switch default settings for set S1
contact Technical Support at (301) 975-1000.

***Note:** Switches S1-1 & S1-2 should be switched simultaneously.
Switches S1-7 & S1-8 should also be switched simultaneously.

S1-1 and S1-2: "Transmit Off" Impedance

Switches S1-1 and S1-2 are set together to determine whether the receiving device "sees" the impedance of the Model 2085's transmitter as being "high" or "intermediate" when the transmitter is turned off. The "intermediate" setting is useful in half-duplex environments where the receiving device does not respond well to the "high" setting.

<u>S1-1</u>	<u>S1-2</u>	<u>Setting</u>
On	On	Intermediate Impedance
Off	Off	High Impedance

S1-3: RTS/CTS Delay

The setting for switch S1-3 determines the amount of delay between the time the Model 2085 "sees" RTS and when it sends CTS.
Note: RTS/CTS Delay setting should be based upon transmission timing.

<u>S1-3</u>	<u>Setting</u>
On	8 mSec
Off	no delay

S1-4: Echo Mode

The setting for switch S1-4 determines whether the Model 2085 echoes data back to the transmitting device (half-duplex mode only).

<u>S1-4</u>	<u>Setting</u>
On	Echo On
Off	Echo Off

S1-5: Carrier Control Method

The setting for switch S1-5 determines whether the carrier is “Constantly On” or “Controlled by RTS”. This setting allows for operation in switched carrier, multipoint and/or hardware handshaking applications.

<u>S1-5</u>	<u>Setting</u>
On	Controlled by RTS
Off	Constantly On

S1-6: Receive Impedance

The setting for switch S1-6 selects the impedance of the input receiver. You may select either a “low” impedance of 120 Ohms or a “high” impedance of 16 kOhms. By selecting the proper impedance for each drop, there may be up to 50 receivers in one application.

<u>S1-6</u>	<u>Setting</u>
On	Low (120 Ohm)
Off	High (16 kOhm typical)

S1-7 and S1-8: 2-Wire/4-Wire Modes

Switches S1-7 and S1-8 are set together to determine whether the Model 2085 is in 2-wire or 4-wire operating mode. **Note:** 2-wire mode is half-duplex only.

<u>S1-7</u>	<u>S1-8</u>	<u>Setting</u>
On	On	2-wire mode
Off	Off	4-wire mode

3.4 CONFIGURATION SWITCH APPLICATIONS

The switch settings *generally* needed to configure the Model 2085 for various applications are shown in the table below. **Note:** Do not change switch settings until you have *carefully* read **Section 3.3**.

TYPICAL MODEL 2085 APPLICATIONS					
Switch Settings	Point-to-Point			Multi-point	
	4W	4W HDX	2W	4W	2W
S1-1: "Xmt Off" Imp.	OFF	OFF	OFF	OFF	OFF
S1-2: "Xmt Off" Imp.	OFF	OFF	OFF	OFF	OFF
S1-3: RTS/CTS Delay	ON	ON	ON	OFF	ON
S1-4: Echo	OFF	OFF	OFF	OFF	OFF
S1-5: Carrier Control	OFF	ON	ON	Master-OFF Slaves-ON	ON
S1-6: Rcv Impedance	ON	ON	ON	Master - ON Slaves - OFF Last Slave - ON	
S1-7: 2-wire/4-wire	OFF	OFF	ON	OFF	ON
S1-8: 2-wire/4-wire	OFF	OFF	ON	OFF	ON

4.0 INSTALLATION

Once you have properly set the configuration switches, you are ready to connect the Model 2085 to your system. This section tells you how to properly connect the Model 2085 to the RS-485 and RS-232 interfaces, and how to operate the Model 2085.

4.1 CONNECTION TO THE RS-485 INTERFACE

To function properly, the Model 2085 *must* have one or two twisted pairs of metallic wire. These pairs must be "dry" (unconditioned) metallic wire, between 19 and 26 AWG (the higher number gauges may limit distance somewhat).

For your convenience, the Model 2085 is available with several different physical interfaces on the RS-485 side: DB-25 (following the RS-520 standard), RJ-11 jack, RJ-45 jack, and terminal blocks with strain relief.

4.1.1 4-WIRE CONNECTION USING THE DB-25

The DB-25 connector on the Model 2085's RS-485 side conforms to the RS-530 interface standard. When connecting to an RS-485 device that also conforms to the RS-530 standard, your cable should be "crossed over" in the manner shown below:

MODEL 2085		RS-485 (530) DEVICE	
<u>SIGNAL</u>	<u>DB-25 PIN</u>	<u>DB-25 PIN</u>	<u>SIGNAL</u>
XMT+	2.....	3	RCV+
XMT-	14.....	16	RCV-
RCV+	3.....	2	XMT+
RCV-	16.....	14	XMT-

NOTE: It is not necessary that the RS-485 device adhere to the RS-530 standard. However, you must make sure that the signals, polarities, and pairing of your connection conform to the above diagram.

4.1.2 4-WIRE CONNECTION USING RJ-11 OR RJ-45

The RJ-11 and RJ-45 connectors on the Model 2085's RS-485 side are pre-wired for a standard TELCO wiring environment. The signal/pin relationships are shown below:

<u>RJ-11</u>	<u>SIGNAL</u>	<u>RJ-45</u>	<u>SIGNAL</u>
1.....	GND*	1	N/C
2.....	RCV-	2	GND*
3.....	XMT+	3	RCV-
4.....	XMT-	4	XMT+
5.....	RCV+	5	XMT-
6.....	GND	6	RCV+
		7	GND
		8	N/C

*Connection to ground is optional

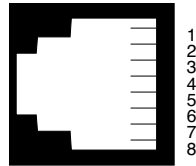
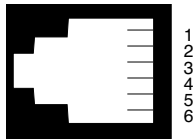

In most modular RS-485 applications it is necessary to use a "cross over" cable. The diagram below shows how a cross over cable should be constructed for an environment where both the Model 2085 and the RS-485 device use a 6-wire RJ-11 connector. Similar logic should be followed when using RJ-45 connectors or a combination of the two.

MODEL 2085		RS-485 DEVICE	
<u>SIGNAL</u>	<u>PIN#</u>	<u>PIN#</u>	<u>RS-422 SIGNAL</u>
GND†	1	N/C	
RCV-	2	4	XMT-
XMT+	3	5	RCV+
XMT-	4	2	RCV-
RCV+	5	3	XMT+
GND†	6	N/C	

4.1.3 4-WIRE CONNECTION USING TERMINAL BLOCKS

If your RS-485 application requires you to connect two pairs of bare wires to the Model 2085, you will need to open the case to access the terminal blocks. The following instructions will tell you how to open the case, connect the bare wires to the terminal blocks, and fasten the strain relief collar in place so that the wires won't pull loose.

1. You should already have the case open for the configuration procedure. If not, open the case according to the diagram in Section 3.2.
2. Strip the outer insulation from the twisted pairs about one inch from the end.

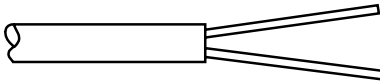

3. Strip back the insulation on each of the 2 twisted pair wires about .25".

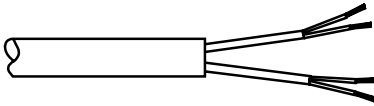

4. Connect *one pair* of wires to XMT+ and XMT- (transmit positive and negative) on the terminal block, making careful note of which color is positive, and which color is negative.
5. Connect the *other pair* of wires to RCV+ and RCV- (receive positive and negative) on the terminal block, again making careful note of which color is positive, and which color is negative.

Ultimately, you will want to construct a two pair cross over cable that makes a connection with the RS-485 device as shown below:

<u>Model 2085</u>	<u>RS-485 Device</u>
XMT+.....	RCV+
XMT-.....	RCV-
RCV+.....	XMT+
RCV-.....	XMT-

6. If there is a shield around the telephone cable, it may be connected to "G" on the terminal block. We recommend connecting the shield at the computer end only to avoid ground loops. A ground wire is *not necessary* for proper operation of the Model 2085.

7. When you finish connecting the wires to the terminal block, the assembly should resemble the diagram below:

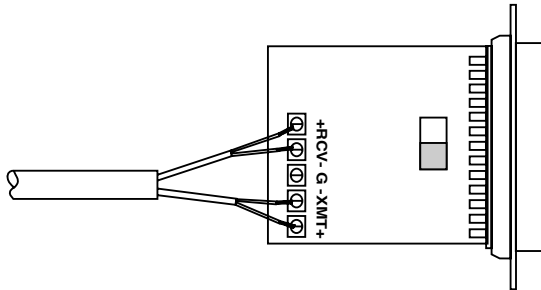

8. Place the 2 halves of the strain relief assembly on either side of the telephone wire and press together very lightly. Slide the assembly so that it is about 2 inches from the terminal posts and press together firmly. If your cable diameter is too small or too large for our strain relief, please contact our technical support. We have strain relief assemblies to accommodate most cable diameters.

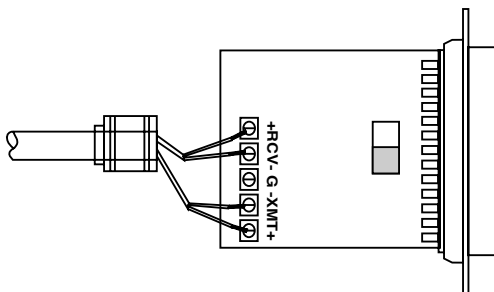

(continued)

9. Insert the strain relief assembly with the wire going through it into the slot in the bottom half of the modem case and set it into the recess in the case.

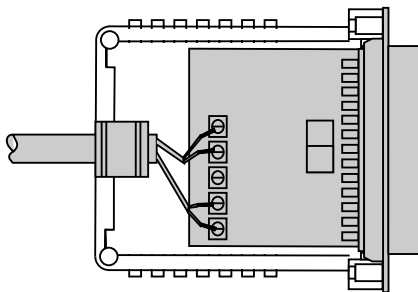

10. BEND the top half of the case as necessary to place it over the strain relief assembly. Do not snap the case together yet.

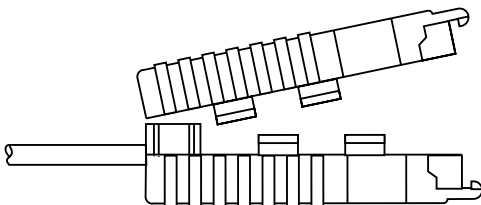

11. Insert one captive screw through a saddle washer and then insert the captive screw with the washer on it, through the hole in the DB-25 end of the case. Snap that side of the case closed. Repeat the process for the other side. This completes the cable installation process.

4.1.4 2-WIRE CONNECTION

Most RS-485 devices employ a two-wire, half duplex configuration. When using this configuration, be sure to first set the Model 2085 to "two wire" mode—then use *only the transmit (XMT) pair* as shown on the following page.

2085 SIGNAL	RS-485 SIGNAL
XMT+.....+	XMT+.....+
XMT-.....-	XMT-.....-

The above wiring pattern applies regardless of whether you are making the RS-485 connection via DB-25, RJ-11, RJ-45 or terminal blocks. For specific wiring instructions, please refer to the previous pages of Section 4.

4.2 WIRING FOR MULTIPOINT CIRCUITS

The Model 2085 supports multi-point applications using either a star or daisy chain topology. Both topologies require special wiring, as well as specific DIP switch settings for master and slave units. **Note:** Refer to **Section 3.2.2** for multipoint DIP switch settings.

4.2.1 STAR TOPOLOGY

Using a star topology, you may connect several Model 2085s together in a master/slave arrangement. Maximum distance between the units will vary based upon the number of drops, data rate, wire gauge, etc. Call Technical Support for specific distance estimates.

Figure 7 (below) shows how to wire the two-pair cables properly for a Model 2085 star topology. Note that the ground connection is not needed.

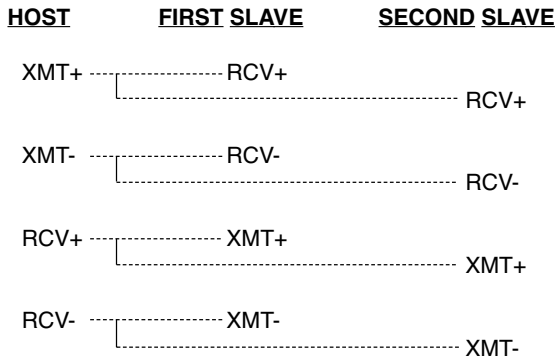

Figure 7. Star wiring for Model 2085 host and slaves

4.2.2 DAISY CHAIN TOPOLOGY

Using a daisy chain topology, you may connect several Model 2085s together in a master/slave arrangement. Maximum distance between the units will vary based upon the number of drops, data rate, wire gauge, etc. Call Technical Support for specific distance estimates.

Figure 8 (below) shows how to wire the two-pair cables properly for a Model 2085 daisy chain topology. Note that the ground connection is not needed.

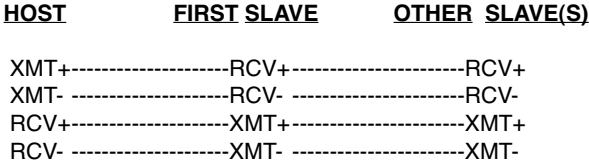

Figure 8. Daisy chain wiring for Model 2085 host and slaves

4.3 CONNECTION TO THE RS-232 INTERFACE

Once you have properly configured the Model 2085 and connected the twisted pair wires correctly, simply plug the Model 2085 directly into the DB-25 port of the RS-232 device. Remember to insert and tighten the two captive connector screws.

(Note: If you must use a cable to connect the Model 2085 to the RS-232 device, make sure it is a *straight through* cable of the shortest possible length—we recommend 6 feet or less).

4.4 OPERATING THE MODEL 2085

Once the Model 2085 is properly installed, it should operate transparently—as if it were a standard cable connection. Operating power is derived from the RS-232 data and control signals; there is no “ON/OFF” switch. All data signals from the RS-232 and RS-485 interfaces are passed straight through. Additionally, one hardware flow control signal is passed *in each direction*.

APPENDIX A

PATTON MODEL 2085 SPECIFICATIONS

Transmission	
Format:	Asynchronous
Data Rate:	Up to 115,200 bps
Range:	Up to 9 miles
RS-232 Interface:	DB-25, male or female (DCE/DTE switchable)
RS-485 Interface	
Options:	DB-25, male or female; RJ-11 or RJ-45 jack; terminal block with strain relief
Transmit Line:	2, 4 wire unconditioned twisted pair
Transmit Mode:	4-wire, full or half duplex; 2-wire half duplex
Control Signals:	DSR turns "ON" immediately after the terminal raises DTR; DCD turns "ON" after recognizing the receive signal from the line; CTS turns "ON" after the terminal raises RTS.
RTS/CTS Delay:	8 mSec or "no delay"
Carrier:	The carrier is switch selected either continuous operation or switched operation, controlled by RTS
Surge Protection:	600W power dissipation at 1 mS
Power:	Draws operating power from RS-232 data and control signals; no AC power or batteries required.
Temperature:	0 to 50° C
Humidity:	5 to 95%, non-condensing
Size:	2.66" x 2.10" x 0.73"

APPENDIX B

PATTON MODEL 2085 RS-232 PIN CONFIGURATIONS

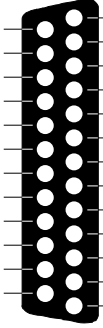
DIRECTION	"DCE" SETTING	DIRECTION
To Model 2085	Data Term. Ready (DTR) - 20	
		To Model 2085 From Model 2085 To Model 2085 From Model 2085 From Model 2085 From Model 2085

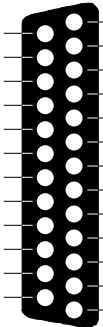
DIRECTION	"DTE" SETTING	DIRECTION
From Model 2085	Data Term. Ready (DTR) - 20	
		From Model 2085 To Model 2085 From Model 2085 To Model 2085 To Model 2085 To Model 2085

Dear Valued Customer,

Thank you for purchasing Patton Electronics products! We do appreciate your business. I trust that you find this user manual helpful.

We manufacture one of the widest selections of data communications products in the world including CSU/DSU's, network termination units, powered and self-powered short range modems, fiber optic modems, interface converters, baluns, electronic data switches, data-line surge protectors, multiplexers, transceivers, hubs, print servers and much more. We produce these products at our Gaithersburg, MD, USA, facility, and can custom manufacture products for your unique needs.

We would like to hear from you. Please contact us in any of the following ways to tell us how you like this product and how we can meet your product needs today and in the future.

Web:	http://www.patton.com
Sales E-mail:	sales@patton.com
Support E-mail:	support@patton.com
Phone - Sales	(301) 975-1000
Phone - Support	(301) 975-1007
Fax:	(301) 869-9293
Mail:	Patton Electronics Company 7622 Rickenbacker Drive Gaithersburg, MD 20879 USA

We are committed to a quality product at a quality price. Patton Electronics is ISO 9001 certified. We meet and exceed the highest standards in the industry (CE, UL, etc.).

It is our business to serve you. If you are not satisfied with any aspect of this product or the service provided from Patton Electronics or its distributors, please let us know.

Thank you.

Burton A. Patton
Vice President

P.S. Please tell us where you purchased this product.

Free Manuals Download Website

<http://myh66.com>

<http://usermanuals.us>

<http://www.somanuals.com>

<http://www.4manuals.cc>

<http://www.manual-lib.com>

<http://www.404manual.com>

<http://www.luxmanual.com>

<http://aubethermostatmanual.com>

Golf course search by state

<http://golfingnear.com>

Email search by domain

<http://emailbydomain.com>

Auto manuals search

<http://auto.somanuals.com>

TV manuals search

<http://tv.somanuals.com>