

Dear Valued Customer,

Thank you for purchasing Patton Electronics products! We do appreciate your business. I trust that you find this user manual helpful.

We manufacture one of the widest selections of data communications products in the world including CSU/DSU's, network termination units, powered and self-powered short range modems, fiber optic modems, interface converters, baluns, electronic data switches, data-line surge protectors, multiplexers, transceivers, hubs, print servers and much more. We produce these products at our Gaithersburg, MD, USA, facility, and can custom manufacture products for your unique needs.

We would like to hear from you. Please contact us in any of the following ways to tell us how you like this product and how we can meet your product needs today and in the future.

Web: <http://www.patton.com>
Sales E-mail: sales@patton.com
Support E-mail: support@patton.com
Phone - Sales (301) 975-1000
Phone - Support (301) 975-1007
Fax: (301) 869-9293
Mail: Patton Electronics Company
7622 Rickenbacker Drive
Gaithersburg, MD 20879 USA

We are committed to a quality product at a quality price. Patton Electronics is BABT and ISO 9001 certified. We meet and exceed the highest standards in the industry (CE, UL, etc.).

It is our business to serve you. If you are not satisfied with any aspect of this product or the service provided from Patton Electronics or its distributors, please let us know.

Thank you.

Burton A. Patton
Vice President

P.S. Please tell us where you purchased this product.

USER MANUAL

MODEL 3054, 3056, 3058 RS-232 and RS-422 Limited Distance Multiplexers



PT PATTON
Electronics Co.



An ISO-9001
Certified Company

Part# 07M305X-B
Doc# 043011UB
Revised 6/18/98

SALES OFFICE
(301) 975-1000
TECHNICAL SUPPORT
(301) 975-1007
<http://www.patton.com>

1.0 WARRANTY INFORMATION

Patton Electronics warrants all Model 305X Series components to be free from defects, and will—at our option—repair or replace the product should it fail within one year from the first date of shipment.

This warranty is limited to defects in workmanship or materials, and does not cover customer damage, abuse, or unauthorized modification. If this product fails or does not perform as warranted, your sole recourse shall be repair or replacement as described above. Under no condition shall **Patton Electronics** be liable for any damages incurred by the use of this product. These damages include, but are not limited to, the following: lost profits, lost savings, and incidental or consequential damages arising from the use of or inability to use this product. **Patton Electronics** specifically disclaims all other warranties, expressed or implied, and the installation or use of this product shall be deemed an acceptance of these terms by the user.

1.1 RADIO AND TV INTERFERENCE

The Model 305X Series generate and use radio frequency energy, and if not installed and used properly—that is, in strict accordance with the manufacturer's instructions—may cause interference to radio and television reception. The Model 305X Series has been tested and found to comply with the limits for a Class A computing device in accordance with the specifications in Subpart J of Part 15 of FCC rules, which are designed to provide reasonable protection from such interference in a commercial installation. However, there is no guarantee that interference will not occur in a particular installation. If the Model 305X Series does cause interference to radio or television reception, which can be determined by disconnecting the unit, the user is encouraged to try to correct the interference by one or more of the following measures: moving the computing equipment away from the receiver, re-orienting the receiving antenna and/or plugging the receiving equipment into a different AC outlet (such that the computing equipment and receiver are on different branches).

1.3 SERVICE

All warranty and non-warranty repairs must be returned freight prepaid and insured to Patton Electronics. All returns must have a Return Materials Authorization number on the outside of the shipping container. This number may be obtained from Patton Electronics Technical Support: **(301) 975-1007**; <http://www.patton.com>; or, support@patton.com.

NOTE: Packages received without an RMA number will not be accepted.

Patton Electronics' Technical Support is also available to answer any questions that might arise concerning the installation or use of your Patton Model 305X Series product. Technical Support hours: **8AM to 5PM EST, Monday through Friday.**

2.0 GENERAL INFORMATION

Thank you for your purchase of this Patton Electronics product. This product has been thoroughly inspected and tested and is warranted for One Year parts and labor. If any questions arise during installation or use of the unit, contact Patton Electronics Technical Support at (301) 975-1007.

2.1 FEATURES

- Multiplexes four, six or eight async RS-232 or RS-422 devices onto two twisted pair, at distances to 6000 ft between muxes
- Operates over 2 dedicated twisted pair wires
- Sub-channels operate full duplex at rates up to 19,200 bps
- Passes through end to end software flow control characters
- Model 3054/AR and 3056/AR allow end-to-end RTS/CTS flow control
- Independent and variable data rates, start/stop bits, and other data parameters for all sub-channels
- Built-in loopback and line tests allow convenient troubleshooting
- Front Panel LEDs show data activity and test status

2.2 DESCRIPTION

The Patton Model 305X Series Short Range Multiplexer is two devices in one: a time division multiplexer and a short range modem. Operating full duplex over a two dedicated twisted pair wires, the Model 305X Series allows up to four, six, or eight serial RS-232 or RS-422 devices to share two twisted pair to communicate at distances up to 6000 feet.

Each of the Model 305X sub-channels can transmit data simultaneously at data rates up to 19.2 kbps without the need for user configuration. Additionally, each sub-channel can operate at a different rate and with different asynchronous data format (word length, start/stop bits, etc.)

The Model 305X Series features built-in local and remote loopback tests that allow easy setup and configuration. Front panel LEDs show data activity for each port as well as power and test conditions. The 305X Series allow software flow control by passing software commands unhindered through the units. In addition, Models 3054AR and 3056AR offer end-to-end RTS/CTS flow control.

3.0 CONFIGURATION

Models 3054 and 3056 require no configuration. If you have Models 3054 or 3056, proceed to **Section 4.0 Installation**. For most applications, the Model 3058 also requires no configuration. However, if you need to connect a Model 3058 to a Patton Model 358 on the main (multiplexed) channel, you must modify an internal jumper strap setting to make the two units compatible with each other. This section shows how to set the jumper strap.

3.1 MODEL 305X/A TO MODEL 358 COMPATIBILITY STRAP

Models 3054/A, 3056/A and 3058/A can be configured to be backward-compatible with the previous generation 8-channel multiplexer--Patton Electronics Model 358. To make the 305X backward-compatible on the main channel, you must remove the Model 358 Compatibility Jumper switch located on the top of the PC board (see Figure 1, below).

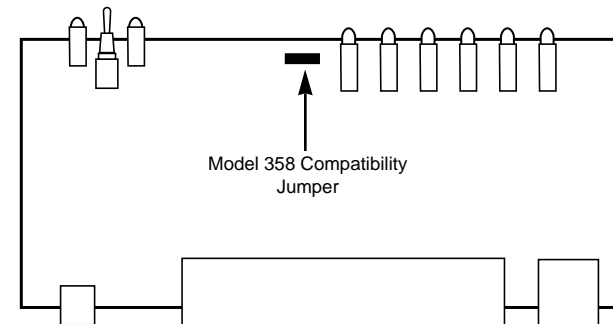

Figure 1: Model 358 Compatibility Jumper

Figure 2, below, shows the two possible settings of the Model 358 Compatibility jumper. The jumper settings are described in the table following Figure 2.

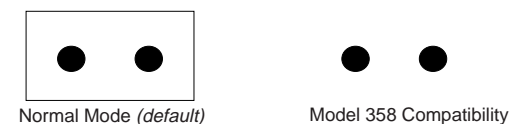

Figure 2: Model 358 Compatibility Jumper

Jumper Position	Compatibility Mode
Jumper strap in place	Normal (<i>default setting</i>)
Jumper strap removed	Backwards Compatible with Model 358

4.0 INSTALLATION

This section describes how to connect each Model 305X to the RS-232 or RS-422 sub-channel devices, to another Model 305X over the main channel, and to the power supply.

4.1 .2 SUB-CHANNEL CONNECTIONS

The RJ-45 female sub-channel ports on the back of the Model 3054, 3056, and 3058 are labeled 1 - 4 (Model 3054), 1 - 6 (Model 3056) and 1 - 8 (Model 3058). Each sub-channel port designates single communication path from the local multiplexer to the remote multiplexer. That is, the serial device connected to port 1 on the local multiplexer will communicate with the serial device that is connected to port 1 on the remote multiplexer. Figure 3 shows the port connections on the rear of the Model 3058.

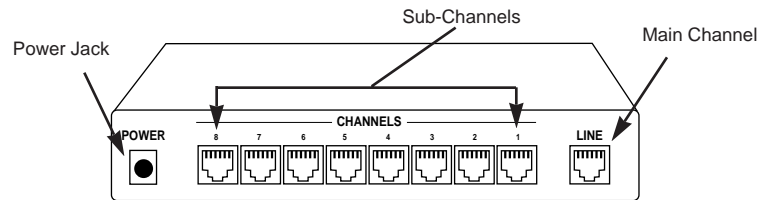

Figure 3: Model 3058 Port Connections

4.1.1 RS-232 Sub-Channel Connections

The Model 305X Series multiplex and de-multiplex data signals from four, six, or eight EIA-232 DTE (terminals, PCs) DCE (modems) devices. Most DTE and DCE devices use a D-Sub 25 or D-Sub 9 connector to transmit and receive data as well as operate flow control. Since the sub-channel ports on the Model 305X Series are modular RJ-45 jacks, you will need an adapter cable to make the proper connections. Figure 4, below, shows the pin assignments on the RJ-45 sub-channel modular jack.

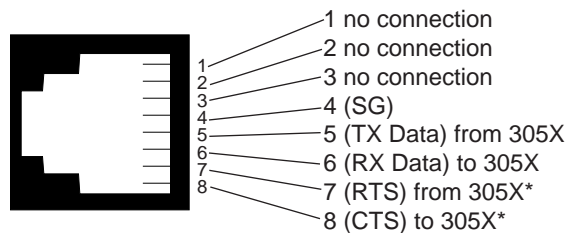
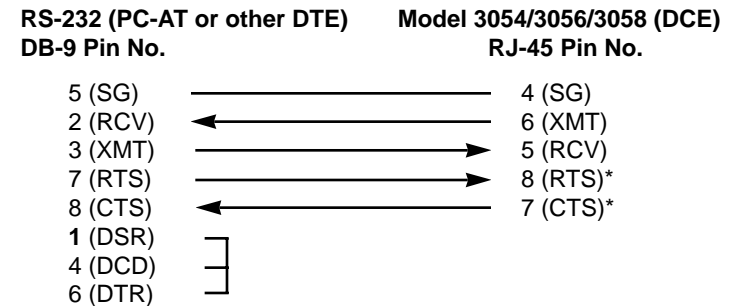
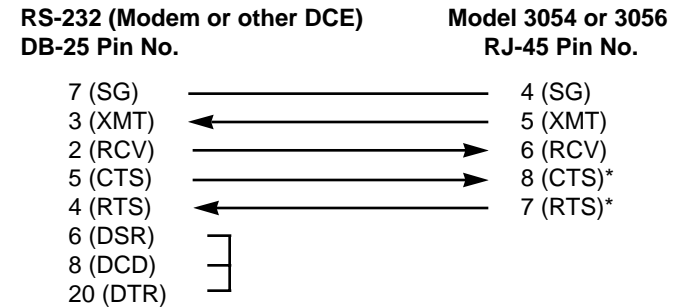
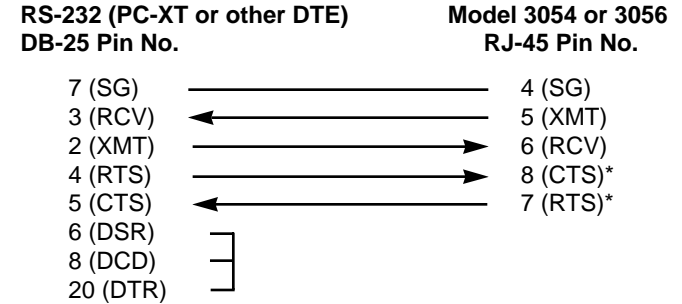

Figure 4: Model 305X RJ-45 Sub-Channel Pin Numbers

***NOTE:** Hardware flow control signals are available only on RS-232 Versions of Models 3054AR and 3056AR (See **Section 4.2.4 Flow Control Requirements**).

Every RS-232 serial device connected to a Model 305X Series unit sub-channel must have a special interface cable. On one end, this interface cable must have an RJ-45 male plug; on the other end, the cable must have a connector that adapts to your RS-232 serial device. The diagrams below show pin connections between the Model 305X sub-channels and common RS-232 interfaces. You may use these diagrams to construct your own cables, or you may purchase cables from Patton Electronics.



***NOTE:** Hardware flow control signals available only on Models 3054/AR and 3056/AR (See **Section 4.2.4 Flow Control Requirements**).

4.2.2 RS-422 Sub-Channel Connections

Similar to the Model 305X, the Models 305X-422 Series multiplex and de-multiplex signals from four or six, or eight EIA-422 devices. EIA-422 devices may use D-Sub 25, D-Sub-9, RJ-45 or another connector type to transmit and receive data and operate flow control.. As with the Model 305X, you will need an adapter cable to make the proper connections. Figure 5, below, shows the pin assignments on the RJ-45 sub-channel modular jack on the 305X-422 Series.

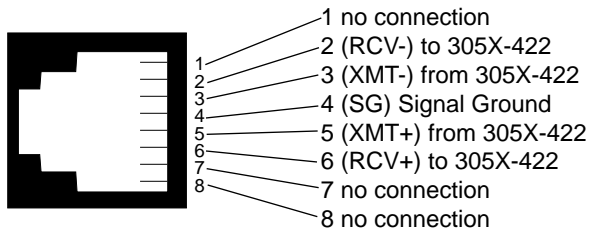
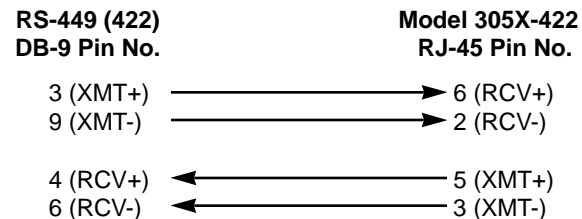
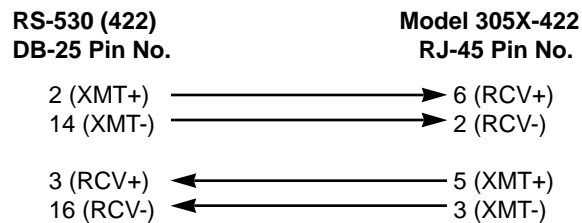

Figure 5: Model 305X-422 RJ-45 Sub-Channel Pin Numbers

The diagrams below show the pinning of two RS-422 patch cables: DB-25 (RS-530) to RJ-45 and DB-9 (RS-449) to RJ-45. Because RS-422 is a balanced interface, you should *always use twisted pair wire* for RS-422 cable (See Appendix B). Using low capacitance twisted pair cable between 19 and 24 AWG, you should be able to attain sub-channel distances up to 1000 ft. Please be careful to observe the correct wire pairing as shown below.



4.2.3 Extending RS-232 Sub-Channel Distances

You can also multiplex signals from sub-channel devices that are located *more than 50 feet* away from the Model 305X. Use a Patton Model 305X-422 with a Patton Model 222N RS-232 to RS-422 converter (see Appendix C for specific model numbers).

As Figure 6 below illustrates, the Model 222N replaces the modular to D-shell converter at the device end. This set-up allows sub-channel cable runs up to 1000 feet over two twisted pair wire. Call Patton Technical Support at for more information about the Model 222N.

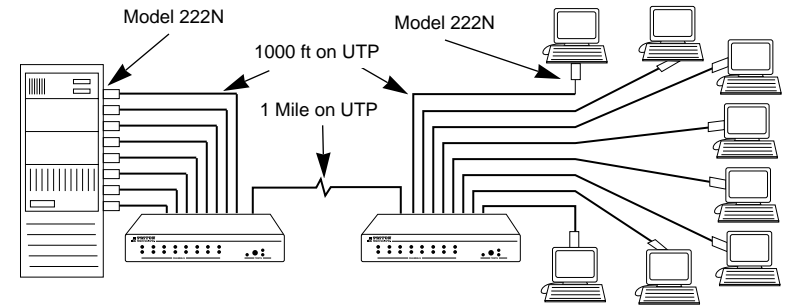

Figure 6. RS-232 sub-channel distance extension

4.2.4 Flow Control Requirements

All versions of the 305X Series accommodate flow control. Flow control is a method whereby devices that process data more slowly (i.e. printers) can request faster processing devices (i.e. PCs) to temporarily stop and then restart data transmission. This gives a slower processing device the ability to clear its receive buffer to accept additional data. All versions of Model 305X operate with software flow control. Models 3054AR and 3056AR may also operate with RTS/CTS (hardware) flow control.

Software Flow Control

The Model 305X Series is transparent to software flow control method on the sub-channel ports. Both sub-channel devices must be set to XON/XOFF or ACK/NAK or any other end-to-end software flow control method. The Model 305X simply passes the software flow control parameters through from end-to-end without modification.

(continued)

RTS/CTS Flow Control (Models 3054AR and 3056AR Only)

In addition to software flow control capability, Models 3054AR and 3056AR offer end-to-end RTS/CTS flow control capability. When using RTS/CTS flow control, the RTS and CTS signals are multiplexed into the composite data stream. The multiplexed RTS/CTS signals are then demultiplexed and passed to the appropriate sub-channel device at opposite end.

4.3 MAIN CHANNEL CONNECTIONS

The main channel port on the back of the Model 305X Series is a female RJ-45 modular jack. The primary connection between the two muxes *must* be dry, unconditioned twisted pair, 19 - 26 AWG (See Appendix B for optimal cable characteristics). The wiring between the wall plates must be *crossed over*, with pairing as shown below:

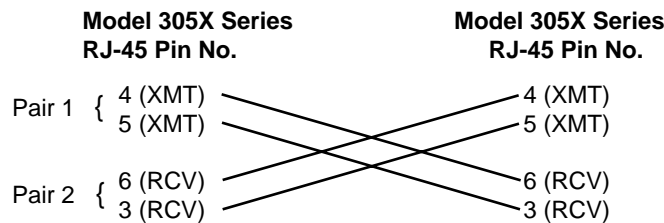

4.4 AC POWER CONNECTION

Power is supplied to the Model 305X Series by a 9-12 VAC, 200mA wall mount transformer. This transformer connects to the Model 305X Series by means of a cannon jack on the rear panel. The Model 305X is powered-up as soon as it is plugged into an AC outlet—there is no power switch.

4.4.1 120 VAC Power (US)

The 120 VAC adapter supplied with the standard version of the Model 305X is a “wall mount” type, and may be plugged into any approved 115 VAC wall plug.

4.4.2 230 VAC Power (IEC)

The 230 VAC adapter supplied with the “international” version of the Model 305X is equipped with an IEC-320 shrouded male connector. This connects with one of several available country-specific power cords (see the ordering information in **Appendix C**). You may purchase these power cords from Patton Electronics, or from a local vendor of your choice.

Once the Model 305X Series is properly installed, it should operate transparently. This section describes the LED status indicators, and the built-in loopback test modes.

5.1 LED STATUS INDICATORS

The Model 305X Series feature front panel LEDs that monitor power, the DTE or DCE signals, link status and test modes. Figure 7 (below) shows the front panel location of each LED. Following Figure 7 is a description of each LEDs function.

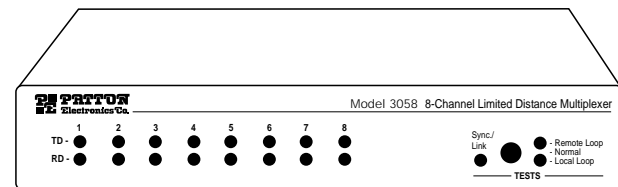

Figure 7. Model 3054/56/58 front panel switch and LEDs

- TD and RD** glow red to indicate idle condition of binary “1” data on respective channel. Green indicates binary “0” data.
- RTS** glows green to indicate that the RS-232 Request-To-Send signal from the terminal is active (**RS-232 Versions: Models 3054AR and 3056AR only**)
- CTS** glows green to indicate that the RS-232 Clear-To-Send signal from the Model 305X is active (**RS-232 Versions: Models 3054A and 3056AR only**)
- Link** glows green to indicate connection to the remote multiplexer.
- Local Loop** glows green when the local multiplexer enters the Local Loop test mode
- Remote Loop** glows green when the local multiplexer enters the Remote Loop test mode

5.2 TEST MODES

The Model 305X Series has three test modes: Local Loopback, Remote Loopback and DTE Remote Loopback. This section tells you how to use these test modes to isolate cabling or multiplexer problems.

5.2.1 Local Loopback

The Local Loopback test allows you to evaluate the integrity of the DTE cable and the local Model 305X. Any data sent to the local Model 305X in this test mode will be echoed (returned) back to the user device. (See Figure 8, below.) For example, characters typed on the keyboard of a terminal will appear on the terminal screen.



Figure 8. Local Loopback Test

To use the local loopback test, follow these instructions.

1. Set the front panel switch of the mux being tested to local loopback. The corresponding LED should glow.
2. On a terminal connected to one of the sub-channel ports, key a character string. You should see those same characters echoed back on the terminal screen.
3. If the keyed character string does not echo on the terminal screen, check all sub-channel connections for continuity and proper pinning.

5.2.2 Remote Loopback

The Model 305X offers a second test that evaluates the integrity of the local and remote multiplexers. With the local multiplexer in REMOTE LOOPBACK mode and the remote multiplexer set to NORMAL, the local mux sends a low frequency pulse to the remote mux over the twisted pair wire. If the two muxes and the twisted pair cable are functioning properly together, you will see the remote multiplexers RECEIVE DATA LEDs blinking together. If you have a RJ-45 loopback adapter connected to the remote sub-channel ports, the remote multiplexers TRANSMIT DATA LEDs and the local multiplexers RECEIVE DATA LEDs will also blink.

5.2.2 DTE Remote Loopback

The DTE Remote Loopback test allows you to evaluate the multiplexers and their connection path by using the local DTE. In order to fully test both units as well as the twisted pair connection path, you will need install the enclosed RJ-45 loopback adapter into the specific remote sub-channel modular jack. Figure 9 shows an example of the Remote Loopback test with the RJ-45 loopback adapter attached to the remote multiplexer.

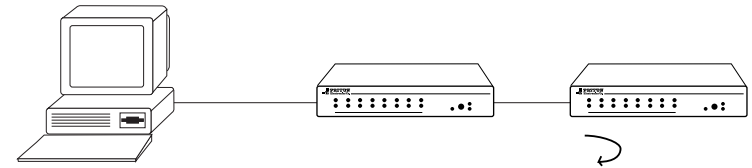

Figure 9 . Line Test

To use this test follow the instructions below:

1. Install the RJ-45 loopback adapter into the sub-channel of the remote multiplexer as shown above in Figure 9. For instance, if you are testing channel 1, install a loopback adapter into the sub-channel 1 RJ-45 jack on the remote multiplexer.
2. Set the front panel switch of the local multiplexer and the remote multiplexer to NORMAL.
3. On a terminal connected to the sub-channel port to be tested, key a character string. You should see those same characters echoed back on the terminal screen after they have passed through the local multiplexer, through the cable and remote multiplexer, and then back to the through the cable to the multiplexer and the attached terminal.
4. If the above test exhibits bit errors or does not work at all, check all sub-channel and main channel connections for continuity and proper pinning.

PATTON MODEL 305X SERIES SPECIFICATIONS

Transmission Lines:	Main channel and RS-422 sub-channels, 19 to 26 AWG twisted pair; RS-232 sub-channels, flat silver cable
Range:	6000 feet (1800m) over twisted pair 24 AWG between multiplexers; 1000 feet (304m) on RS-422 sub-channels; 50 feet (15m) on RS-232 sub-channels
Interfaces:	Asynchronous RS-232, ITU/CCITT
Data Rates:	0 - 19.2 kbps on sub-channels
Indicators:	Transmit Data, Receive Data, Link, Local Loopback, Line Test
Test Modes:	Local loopback, Line Test
Connectors:	RJ-45 female on main and sub-channels
Power Supply:	9-12 Volts AC
Temperature Range:	0-60°C (32-140°F)
Altitude:	0-15,000 feet (0-4572 m)
Humidity:	5 to 95% non-condensing
Dimensions:	8.5" W x 3.5"L x 1.5"H (21.0 x 8.9. x 3.8 cm)
Weight:	Multiplexer, 0.65 lbs; Power supply, 0.5 lbs
Certifications:	Emissions: FCC part 15 Class A,

MODEL 305X SERIES CABLE RECOMMENDATIONS

The Patton Model Series operates at frequencies of 160 kHz or less and has been performance tested by Patton technicians using twisted-pair cable with the following characteristics:

Wire Gauge	Capacitance	Resistance
19 AWG(.9mm)	83nF/mi or 15.72 pF/ft.	.0163 Ohms/ft.
22 AWG(.6mm)	83nF/mi or 15.72 pF/ft.	.0326 Ohms/ft.
24 AWG(.5mm)	83nF/mi or 15.72 pF/ft.	.05165 Ohms/ft.
26 AWG(.4mm)	83nF/mi or 15.72 pF/ft.	.08347 Ohms/ft.

To gain optimum performance from the Model 305X Series, please keep the following guidelines in mind:

- **Always use twisted pair wire—this is not an option.**
- Use twisted pair wire with a capacitance of 20pF/ft or less.
- Avoid twisted pair wire thinner than 26 AWG (i.e. avoid higher AWG numbers than 26).
- Use of twisted pair with a resistance greater than the above specifications may cause a reduction in maximum distance obtainable. Functionality should not be affected.

APPENDIX C

PATTON MODEL 305X SERIES FACTORY REPLACEMENT PARTS

Patton Part # Description

222NM-RJ45.....	RS-232 (male) to RS-422 Converter
222NF-RJ45	RS-232 (female) to RS-422 Converter
222N9M-RJ45.....	RS-232 (DB-9 male) to RS-422 Converter
222N9F-RJ45	RS-232 (DB-9 female) to RS-422 Converter
080510ACB	Power Supply, 120V, 10VAC
080512ACI.....	Power Supply, 230V, 12VAC

APPENDIX D

PATTON MODEL 305X LOOPBACK ADAPTER PIN ASSIGNMENTS

RS-232 LOOPBACK ADAPTER PLUG

**Model 305X - LB
RJ-45 Pin No.**

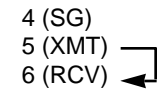

RS-422 LOOPBACK ADAPTER PLUG

**Model 305X-422-LB
RJ-45 Pin No.**

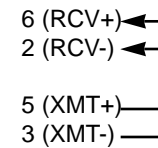

Free Manuals Download Website

<http://myh66.com>

<http://usermanuals.us>

<http://www.somanuals.com>

<http://www.4manuals.cc>

<http://www.manual-lib.com>

<http://www.404manual.com>

<http://www.luxmanual.com>

<http://aubethermostatmanual.com>

Golf course search by state

<http://golfingnear.com>

Email search by domain

<http://emailbydomain.com>

Auto manuals search

<http://auto.somanuals.com>

TV manuals search

<http://tv.somanuals.com>