

# USER MANUAL

---

## MODEL 1000RC Asynchronous Short Range Modem: Dual Rack Mount Card



---

**PI PATTON**  
**E Electronics Co.**

Part# 07M1000RC-B  
Doc# 052011UB  
Revised 4/30/96

SALES OFFICE  
(301) 975-1000  
TECHNICAL SUPPORT  
(301) 975-1007

## 1.0 WARRANTY INFORMATION

**Patton Electronics** warrants all Model 1000RC components to be free from defects, and will—at our option—repair or replace the product should it fail within one year from the first date of shipment.

This warranty is limited to defects in workmanship or materials, and does not cover customer damage, abuse or unauthorized modification. If this product fails or does not perform as warranted, your sole recourse shall be repair or replacement as described above. Under no condition shall **Patton Electronics** be liable for any damages incurred by the use of this product. These damages include, but are not limited to, the following: lost profits, lost savings and incidental or consequential damages arising from the use of or inability to use this product. **Patton Electronics** specifically disclaims all other warranties, expressed or implied, and the installation or use of this product shall be deemed an acceptance of these terms by the user.

### 1.1 RADIO AND TV INTERFERENCE

The Model 1000RC generates and uses radio frequency energy, and if not installed and used properly—that is, in strict accordance with the manufacturer's instructions—may cause interference to radio and television reception. The Model 1000RC has been tested and found to comply with the limits for a Class A computing device in accordance with the specifications in Subpart J of Part 15 of FCC rules, which are designed to provide reasonable protection from such interference in a commercial installation. However, there is no guarantee that interference will not occur in a particular installation. If the Model 1000RC does cause interference to radio or television reception, which can be determined by turning the power off or disconnecting the RS-232 interface, the user is encouraged to try to correct the interference by one of the following measures: moving the computing equipment away from the receiver, re-orienting the receiving antenna and/or plugging the receiving equipment into a different AC outlet (such that the computing equipment and receiver are on different branches).

In the event that the user detects intermittent or continuous product malfunction due to nearby high power transmitting radio frequency equipment, the user is strongly advised to take the following steps:

- 1) Use only data cables with an external outer shield bonded to a metal or metalized connector, and...
- 2) Configure the rear card as shown in Section 3.3.1 in this manual.

### 1.2 SERVICE

All warranty and non-warranty repairs must be returned freight prepaid and insured to Patton Electronics. All returns must have a Return Materials Authorization number on the outside of the shipping container. This number may be obtained from Patton Electronics Technical Service at **(301) 975-1007**. *Packages received without an RMA number will not be accepted.*

Patton Electronics' technical staff is also available to answer any questions that might arise concerning the installation or use of your Model 1000RC. Technical Service hours: **8AM to 5PM EST, Monday through Friday.**

## 2.0 GENERAL INFORMATION

Thank you for your purchase of this Patton Electronics product. This product has been thoroughly inspected and tested and is warranted for One Year parts and labor. If any questions or problems arise during installation or use of this product, please do not hesitate to contact Patton Electronics Technical Support at (301) 975-1007.

### 2.1 FEATURES

- Convenient rack card features two short range modems
- Data rates to 19.2 Kbps
- Full duplex operation
- Supports distances to 17 miles
- Features 13 front panel LEDs
- Silicon Avalanche Diode surge protection
- Fits conveniently in Patton's rack chassis
- Made in USA

### 2.2 DESCRIPTION

**The Model 1000RC Asynchronous Short Range Modem Rack Card** is a dual rack card incorporating two short range modems. Both units operate full duplex at data rates to 19.2 Kbps over 2 twisted pairs and support distances to 17 miles. The Model 1000RC features 13 easy-to-read front panel LEDs, which monitor the status of data transmission. The Model 1000RC also incorporates Silicon Avalanche Diodes for protection against the damaging effects of nearby lightning strikes and other harmful transients.

The Model 1000RC uses the latest surface mount technology to attain high quality short range modem performance in a convenient rack card. Filling one function card slot on Patton's Model 1000R16P rack chassis, the Model 1000RC is available with RJ-11 or RJ-45 rear interface cards. For workgroup and desktop communications, the Model 1000RC also fits in Patton's 2, 4 and 8 slot Cluster Boxes. The combination of rack mount, Cluster Box and self-powered units provides a completely integrated Model 1000 "networking" solution.

## 3.0 CONFIGURATION

This section describes the location and orientation of the Model 1000RC's configuration straps, provides detailed instructions on setting each strap and describes the settings for each of the rear connection cards.

The Model 1000RC uses two sets of configuration straps. These straps are accessible when the card is slid out of the rack chassis (see Figure 1, below). Once configured, the Model 1000RC is designed to operate transparently, without need for frequent re-configuration: just set it and forget it!

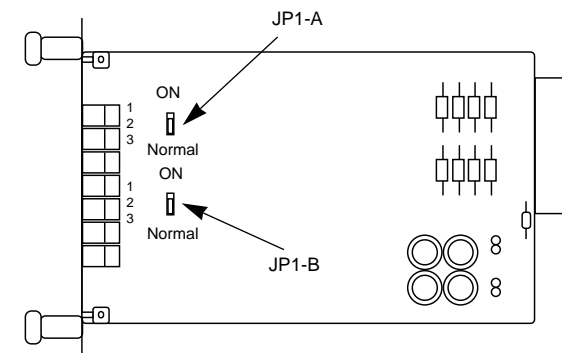

Figure 1. Model 1000RC card, showing location of configuration jumpers

### 3.1 STRAP LOCATIONS AND ORIENTATION

The configuration straps on the Model 1000RC board allow you to configure the function of both "Carrier Detect" outputs. Figure 2 shows the orientation of these straps. Notice that each strap can either be on pegs 1 and 2, or on pegs 2 and 3.

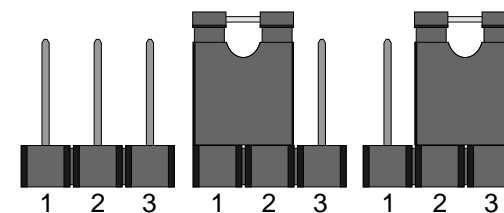

Figure 2. Orientation of interface card straps

### 3.2 FRONT CARD CONFIGURATION

The Model 1000RC contains two sets of configuration straps which allow you to set the function of "Carrier Detect" output. Since the Model 1000RC contains **two** modems, each unit can be configured separately: Jumper 1 (JB1) controls Unit A, while Jumper 2 (JB2) controls Unit B.

Each "Carrier Detect" strap can be set to "Normal" or "Always on". When operating normally, the "CD" LED will blink to indicate the presence or absence of the carrier. When set to "Always on", the "CD" LED will always indicate that the carrier is "ON". Figure 3 (below) summarizes the switch settings.

INTERFACE CARD JUMPER SUMMARY TABLE #1			
Jumper	Function	Position 1&2	Position 2&3
JP1-A	Carrier Detect - Unit A	Always ON*	Normal
JP1-B	Carrier Detect - Unit B	Always ON*	Normal

Figure 3. Summary of jumper settings, \*indicates factory default

### 3.3 REAR CARD CONFIGURATION

The Model 1000RC has two interface card options: the 1Q11 (which comes equipped with two RJ-11 ports and two RJ-45 ports) and the 1Q45 (which comes equipped with four RJ-45 ports). Figure 4 illustrates these two different rear interface options.

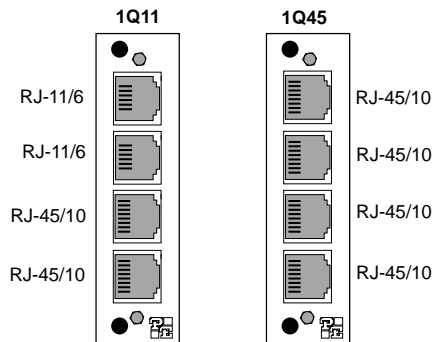

Figure 4. Model 1000RC rear interface card options

Prior to installation, you should examine the rear card you have selected and ensure that it is suitable for your application. Each rear card is configured by setting straps on the PC board. Section 3.3.1 describes the strap locations and settings for each card.

### 3.3.1 REAR CARD STRAP SETTINGS

Figure 5 shows the strap locations for the 1Q11 and the 1Q45 rear cards. These straps determine various grounding characteristics for the RS-232 and twisted pair lines.

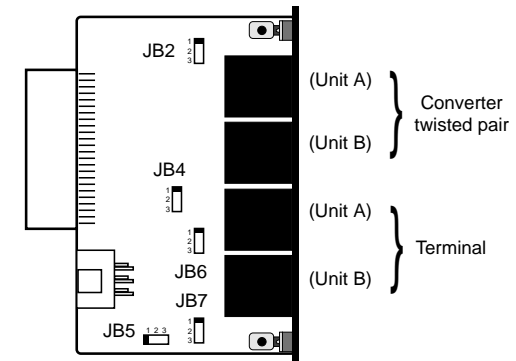

Figure 5. Strap locations for both rear cards

Figure 6 provides a summary of strap functions for both of the rear cards. The next page describes each strap's function.

INTERFACE CARD STRAP SUMMARY TABLE #1		
Strap	Position 1&2	Position 2&3
JB2	Line A Shield	No Shield <sup>†</sup>
JB4	Line B Shield	No Shield <sup>†</sup>
JB5	SGND & FRGND*	Open (Not Connected) <sup>†</sup>
JB6	Unit A DSR <sup>†</sup>	N/A
JB7	Unit B DSR <sup>†</sup>	N/A

Figure 6. Summary of strap settings, <sup>†</sup> indicates factory default  
\*via 100 ohm resistor

#### Line A Shield & Line B Shield (JB2 & JB4)

This strap pertains to the line interface. In position 1&2, the strap links RJ-11 pins 1 and 6 (RJ-45 pins 2 and 7) to frame ground and the rear panel. These pins can be used as connections for the twisted pair cable shield. In position 2&3, pins 1 and 6 (or 2 and 7) are disconnected from frame ground.

(continued)

#### JB2

Position 1&2 = Line A Shield Connected to Frame Ground  
Position 2&3 = No Shield

#### JB4

Position 1&2 = Line B Shield Connected to Frame Ground  
Position 2&3 = No Shield

#### **SGND & FRGND (JB5)**

In position 1&2, this strap links signal ground and frame ground through a 100 Ohm, 1/2 W resistor. In position 2&3, pin 1 is "not connected to frame ground.

#### JB5

Position 1&2 = SGND and FRGND Connected  
Position 2&3 = SGND and FRGND Not Connected

#### **DTE as DSR or RI (JB6 & JB7)**

Because the Model 1000RC uses DSR (but not RI), only position 1&2 is valid when this rear card is used with the Model 1000RC. Position 1&2 causes the terminal (DTE) to see DSR when the Model 1000RC is powered up properly. Position 2&3 is for Ring Indicate, which is non-functional on the Model 1000RC. Furthermore, use of position 2&3 will cause DSR to float, which will lead to improper operation of the Model 1000RC.

#### JB6 & JB7

Position 1&2 = DSR  
Position 2&3 = (Ring Indicate) Not Valid for Model 1000RC

## **4.0 INSTALLATION**

This section describes the functions of the Model 1000R16P rack chassis, tells how to install front and rear Model 1000RC cards into the chassis and provides diagrams for wiring up the interface connections correctly.

### **4.1 THE MODEL 1000R16P RACK CHASSIS**

The Model 1000R16P Rack Chassis (Figure 7) has sixteen short range modem card slots, plus its own power supply. Measuring only 3.5" high, the Model 1000R16P is designed to occupy only 2U in a 19" rack. Sturdy front handles allow the Model 1000R16P to be extracted and transported conveniently.

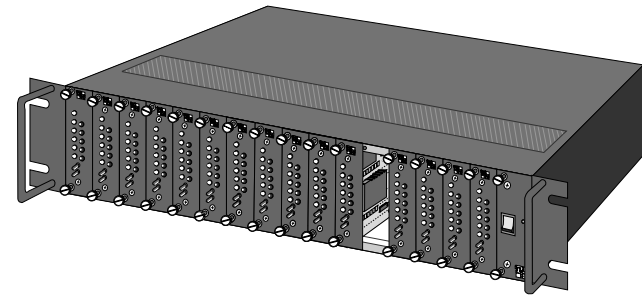

Figure 7. Model 1000R16P Rack Chassis with power supply

#### **4.1.1 THE RACK POWER SUPPLY**

The power supply included in the Model 1000R16P rack uses the same mid-plane architecture as the modem cards. The front card of the power supply slides in from the front, and the rear card slides in from the rear. They plug into one another in the middle of the rack. The front card is then secured by thumb screws and the rear card by conventional metal screws.

**WARNING!** There are no user-serviceable parts in the power supply section of the Model 1000RC. Voltage setting changes and fuse replacement should only be performed by qualified service personnel. Contact Patton Electronics Technical support at (301)975-1007 for more information.

## Switching the Power Supply On and Off

The power switch is located on the front panel. When plugged in and switched on, a red front panel LED will glow. Since the Model 1000R16P is a "hot swappable" rack, *it is not necessary for any cards to be installed before switching on the power supply.* The power supply may be switched off at any time without harming the installed cards.

## 4.2 INSTALLING THE MODEL 1000RC INTO THE CHASSIS

The Model 1000RC is comprised of a front card and a rear card. The two cards meet inside the rack chassis and plug into each other by way of mating 50 pin card edge connectors. Use the following steps as a guideline for installing each Model 1000RC into the Model 1000R16P rack chassis:

1. Slide the rear card into the back of the chassis along the metal rails.
2. Secure the rear card using the metal screws provided.
3. Slide the front card into the front of the chassis. It should meet the rear card when it's almost all the way into the chassis.
4. Push the front card *gently* into the card-edge receptacle of the rear card. It should "click" into place.
5. Secure the front card using the thumb screws.

**Note:** *Since the Model 1000R16P chassis allows "hot swapping" of cards, it is not necessary to power down the rack when you install or remove a Model 1000RC.*

## 4.3 RS-232 CONNECTION

The RS-232 ports are always the *lower* ports on the interface card. The 10-pin RJ-45 is pinned according Patton's Modified Modular Interface Standard (based on the EIA/TIA-561 Standard). For specific interface pin-outs, please refer to the diagrams in **Appendix D**.

**Notice!** Any terminal cable connected to the Model 1000RC must be shielded cable, and the outer shield must be 360 degree bonded—at both ends—to a metal or metalized backshell.

(continued)

The Model 1000RC is wired as a DCE (Data Communications Equipment). Therefore, it wants to connect to a DTE (Data Termination Equipment). If your RS-232 output device is a DTE, you may need to use a special cable (such as a DB-25 to modular cable). If your RS-232 output device is DCE, you will require a null modem connection. Call Patton Technical Support at (301) 975-1007 for specific installation instructions.

## 4.4 TWISTED PAIR CONNECTION

The Model 1000RC operates full duplex over two twisted pair. In *all* applications, the twisted pair wire must be 26 AWG or thicker, unconditioned, dry, metallic wire. Both shielded and unshielded wire are satisfactory. **Note:** The Model 1000RC can only be installed on private twisted pair cable. Dial-up analog circuits, such as those used with a standard Hayes-type modem, are *not acceptable*. For further information about acceptable wire grades, please refer to the diagrams in **Appendix B**.

**Notice!** Any modular twisted pair cable connected to the Model 1000RC must be shielded cable, and the outer shield must be properly terminated to a shielded modular plug on both ends of the cable.

### 4.4.1 POINT-TO-POINT TWISTED PAIR CONNECTION

The 6-position RJ-11 and 8-position RJ-45 jack options for the Model 1000RC—always the *upper* jack on the rear interface card—are prewired for a standard TELCO wiring environment (See Appendix D for pin number orientations). Connection of a 4-wire twisted pair circuit between two or more Model 1000RCs requires a *crossover cable* as shown in the following charts.

#### RJ-11 Cable

SIGNAL	PIN#	PIN#	SIGNAL
GND†	1-----	6	GND†
RCV-	2-----	4	XMT-
XMT+	3-----	5	RCV+
XMT-	4-----	2	RCV-
RCV+	5-----	3	XMT+
GND†	6-----	1	GND†

(continued)

### RJ-45 Cable

<u>SIGNAL</u>	<u>PIN#</u>	<u>PIN#</u>	<u>SIGNAL</u>
GND†	2-----	7	GND†
RCV-	3-----	5	XMT-
XMT+	4-----	6	RCV+
XMT-	5-----	3	RCV-
RCV+	6-----	4	XMT+
GND†	7-----	2	GND†

†Connection to ground is optional

## 5.0 OPERATION

Once you have configured each Model 1000RC and connected the cables, you are ready to operate the units. Section 5.0 describes the LED status monitors and the power-up procedure.

### 5.1 LED STATUS MONITORS

The Model 1000RC features thirteen front panel LEDs that indicate the condition of the modem and communication link. Figure 9 shows the positions of the LEDs and the bullets describe their functions.

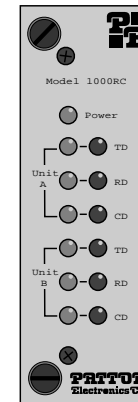

Figure 9. The Model 1000RC front panel, showing LED positions

- The green “PWR” LED glows when power is being applied to the modem card through its mid-plane chassis connection.
- The “TD” and “RD” indicators blink red and green to show data activity. A solid red light indicates an idle state. Solid green is an “illegal” condition and typically indicates a problem in the system.
- If your carrier detect strap is configured as “Always On”, the “CD” light will always be green. If the carrier detect strap is set to “Normal”, the green LED lights when the receive carrier is detected; the red LED lights when the receive carrier is absent.

### 5.2 POWER-UP

There is no power switch on the Model 1000RC: Power is automatically applied to the 1000RC when its card-edge connector touches the chassis’ mid-plane socket, or when the chassis’ power is turned on. *Note: The 1000RC is a “hot swappable” card—it will not be damaged by plugging it in or removing it while the rack is powered up.*

## APPENDIX A SPECIFICATIONS

**Transmission Format:** Asynchronous

**Data Rate:** 0 to 19.2 Kbps

**Surge Protection:** 600W power dissipation at 1 mS

**Control Signal:** DCE Mode: CTS (Pin 8) turns ON immediately after the terminal raises RTS (Pin 9); DSR (Pin 2) turn ON immediately after the rack has power; CD (Pin 3) may be constantly "ON" or "normal" (i.e. follows presence or absence of RXC signal).

**Transmission Line:** 4-wire, unconditioned twisted pair, shielded or unshielded

**Transmit Mode:** Full duplex, 4-wire

**Line Connection:** RJ-11 or RJ-45 jack

**Temperature Range:** 1-50°C (34-122°F)

**Altitude:** 0-15,000 feet

**Humidity:** Up to 95% non-condensing

**Dimensions:** 0.95"w x 3.1"h x 5.4"l

## APPENDIX B CABLE RECOMMENDATIONS

The Patton Model 1000RC operates at frequencies of 20kHz or less and has been performance tested by Patton technicians using twisted-pair cable with the following characteristics:

<u>Wire Gauge</u>	<u>Capacitance</u>	<u>Resistance</u>
19 AWG	83nf/mi or 15.72 pf/ft.	.0163 Ohms/ft.
22 AWG	83nf/mi or 15.72 pf/ft.	.0326 Ohms/ft.
24 AWG	83nf/mi or 15.72 pf/ft.	.05165 Ohms/ft.

To gain optimum performance from the Model 1000RC, please keep the following guidelines in mind:

- *Always* use **twisted pair** wire—this is not an option.
- Use twisted pair wire with a capacitance of 20pf/ft or less.
- Avoid twisted pair wire thinner than 26 AWG (i.e. avoid higher AWG numbers than 26)
- Use of twisted pair with a resistance greater than the above specifications may cause a reduction in maximum distance obtainable. Functionality should not be affected.
- Many environmental factors can affect the maximum distances obtainable at a particular site. Use the above data rate/distance table as a *general guideline only*.



**APPENDIX C  
FACTORY REPLACEMENT PARTS**

The Patton Model 1000RC rack system features interchangeable rear half cards, power cords/fuses for international various operating environments and other user-replaceable parts. Model numbers and descriptions for these parts are listed below:

<u>Patton Model #</u>	<u>Description</u>
1000RPEM.....	120/240V Rear Power Entry Module
1000RPSM-1.....	120/240V Front Power Supply Module
1000RPEM-DC .....	DC Rear Power Entry Module
1000RPSM-48A .....	48V Front Power Supply Module
0805US .....	American Power Cord
0805EUR.....	European Power Cord CEE 7
0805EURP .....	Europlug Power Cord CEE 7/16
0805UK .....	United Kingdom Power Cord
0805AUS.....	Australia/New Zealand Power Cord
0805DEN.....	Denmark Power Cord
0805FR .....	France/Belgium Power Cord
0805IN.....	India Power Cord
0805IS.....	Israel Power Cord
0805JAP.....	Japan Power Cord
0805SW .....	Switzerland Power Cord
0516FPB1 .....	Single Width Blank Front Panel
0516FPB4 .....	4-Wide Blank Front Panel
0516RPB1 .....	Single Width Blank Rear Panel
0516RPB4.....	4-Wide Blank Rear Panel
056S1.....	Set of 16 #4 pan head screws/washers

**APPENDIX D  
INTERFACE SETTINGS & ORIENTATION**

PATTON MODULAR INTERFACE - 10 Wire RJ-45		
Contact Number	Circuit	Description
1	N/A	Not Used
2	125	DSR
3	109	Received Line Signal Indicator (CD)
4	108 / 2	DTE Ready (DTR)
5	102	Signal Common
6	104	Received Data
7	103	Transmitted Data
8	106	Clear to Send
9	105 / 133	Request to Send / Ready for Receiving
10	N/A	Not Used

Pins 2-9 conform to the EIA/TIA-561 eight position non-synchronous interface standard.

For all modular jacks (6, 8 or 10 position):  
**Pin 1** is always toward the **bottom** when the rear card is oriented correctly in the slot

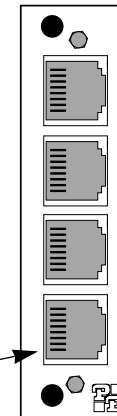

## Free Manuals Download Website

<http://myh66.com>

<http://usermanuals.us>

<http://www.somanuals.com>

<http://www.4manuals.cc>

<http://www.manual-lib.com>

<http://www.404manual.com>

<http://www.luxmanual.com>

<http://aubethermostatmanual.com>

Golf course search by state

<http://golfingnear.com>

Email search by domain

<http://emailbydomain.com>

Auto manuals search

<http://auto.somanuals.com>

TV manuals search

<http://tv.somanuals.com>