

OWNER'S MANUAL

POWER SHREDDER

Model Numbers

242-650A
24650-A

Important:
Read Safety Rules and
Instructions Carefully

Thank you for purchasing an
American built product.

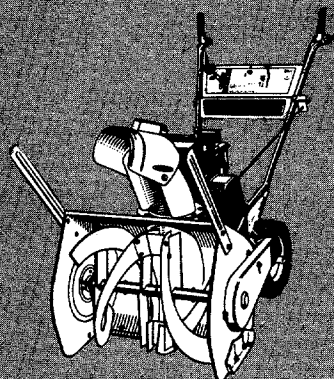
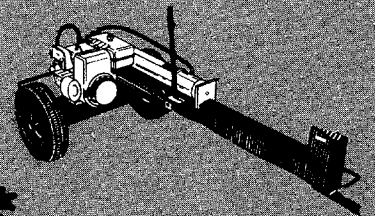
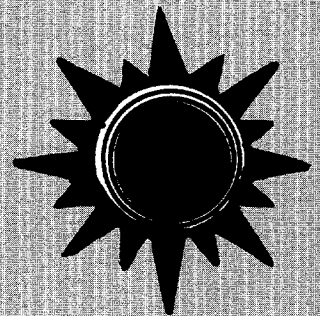
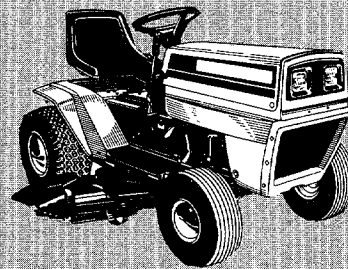
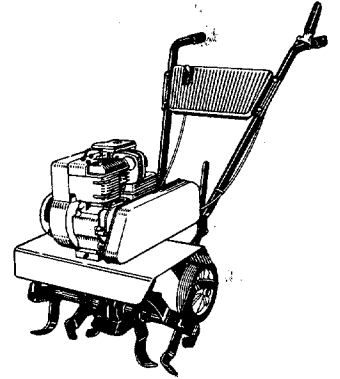

INDEX

Safe Operation Practices	3	Maintenance	9
Assembly Instructions	4	Off-Season Storage	9
Operation	6	Illustrated Parts	10
Adjustments	8	Parts List	11
Lubrication	9		

LIMITED WARRANTY

For one year from the date of original retail purchase, MTD PRODUCTS INC will either repair or replace, at its option, free of charge, F.O.B. factory or authorized service firm, any part or parts found to be defective in material or workmanship. Transportation charges for the movement of any power equipment unit or attachment are the responsibility of the purchaser. Transportation charges for any parts submitted for replacement under this warranty must be paid by the purchaser unless such return is requested by MTD PRODUCTS INC.

This warranty will not apply to any part which has become inoperative due to misuse, excessive use, accident, neglect, improper maintenance, alterations, or unless the unit has been operated and maintained in accordance with the instructions furnished. This warranty does not apply to the engine, motor, battery, battery charger or component parts thereof. Please refer to the applicable manufacturer's warranty on these items.

This warranty will not apply where the unit has been used commercially.

Warranty service is available through your local authorized service dealer or distributor. If you do not know the dealer or distributor in your area, please write to the Customer Service Department of MTD.

The return of a complete unit will not be accepted by the factory unless prior written permission has been extended by MTD.

This warranty gives you specific legal rights. You may also have other rights which vary from state to state.

WARNING TO PURCHASERS OF INTERNAL COMBUSTION ENGINE EQUIPPED MACHINERY OR DEVICES IN THE STATE OF CALIFORNIA

The equipment which you have just purchased does not have a spark arrester. If this equipment is used on any forest covered land, brush covered land, or grass covered unimproved land in the State of California, before using on such land, the California law requires that a spark arrester be provided. In addition, spark arrester is required by law to be in effective working order. The spark arrester must be attached to the exhaust system and comply with Section 4442 of the California Public Resources Code.

IMPORTANT

It is suggested that this manual be read in its entirety before attempting to assemble or operate. Keep this manual in a safe place for future reference and for ordering replacement parts.

This unit is shipped WITHOUT GASOLINE or OIL. After assembly, see operating section of this manual for proper fuel and engine oil recommendations.

SAFE OPERATION PRACTICES FOR POWER SHREDDERS

TRAINING

1. The operator should become fully familiar with all of the different sections of this owner's manual before attempting to operate this equipment.
2. Children must never be allowed to operate this equipment.
3. This equipment should never be operated in the vicinity of children, pets or other persons.
4. Never run your machine in an enclosed area as the exhaust from the engine contains carbon monoxide, which is an odorless, tasteless and deadly poisonous gas.
5. Never allow your hands or any part of your body or clothing inside the feeding chamber, discharge chute, or near any moving part while the machine or engine is running.
6. If it is necessary for any reason to inspect or repair the feeding chamber or any part of the machine where a moving part can come in contact with your body or clothing, stop the machine, allow it to cool, and disconnect the spark plug wire from the spark plug before attempting such inspection or repair.
 - A. Inspect for damage.
 - B. Replace or repair any damaged parts.
 - C. Check for any loose parts and tighten to assure continued safe operation.

PREPARATION

1. It is recommended that the operator of this equipment obtain and wear safety glasses at all times while operating the machine.
2. Wear proper apparel. Avoid wearing loose fitting clothing.
3. This machine should be operated only upon an earthen level surface.
4. Assure that all screws, nuts and bolts and other fasteners are properly secured.

OPERATION

1. When feeding shreddable material into this equipment, be extremely careful that pieces of metal, rocks, bottles, cans or other foreign objects are not included.
2. If the cutting mechanism strikes any foreign object or if your machine should start making an unusual noise or vibration, immediately stop the engine and disconnect the spark plug wire from the spark plug. Allow the machine to stop and take the following steps:

3. The engine must be kept clean of debris and other accumulations.
4. Do not allow an accumulation of processed material to build up in the discharge area as this will prevent proper discharge and can result in kick-back from feed opening.
5. Never allow your hands or any other part of your body or clothing inside the feeding chamber, discharge chute or near any moving part while the engine is running.
6. Keep all guards and deflectors in place and in good working condition to assure continued safe operation.
7. Always stand clear of the discharge area when operating this machine.
8. Keep your face and body back from the feed opening to avoid accidental bounce back of any material.
9. Do not over-reach. Keep proper balance and footing at all times.
10. The engine governor settings on your machine must not be altered, changed, or tampered with. The governor controls the maximum safe operating speeds and protects the engine and all moving parts from damage caused by overspeed.
11. Do not transport machine while engine is running.

MAINTENANCE AND STORAGE

1. When this equipment is stopped for servicing, inspection, storage or to change an accessory, make sure the spark plug wire is disconnected from the spark plug. The machine should be allowed to cool down before making such inspection, adjustments, service, etc. Maintain your machine with care and keep it clean for the best and continued safe operation.
2. When not in use, your machine should be stored out of the reach of children. Keep where gasoline fumes will not reach an open flame or spark. For long periods of storage, the gasoline should be drained and disposed in a safe manner. Always allow the machine to cool before storing in any enclosure.



The right and left side of your shredder is determined from operator's position.

ASSEMBLY INSTRUCTIONS

TOOLS REQUIRED FOR ASSEMBLY

1. (1) 7/16" Open End or Box Wrench
2. (1) 1/2" Open End or Box Wrench
3. (1) Adjustable Wrench

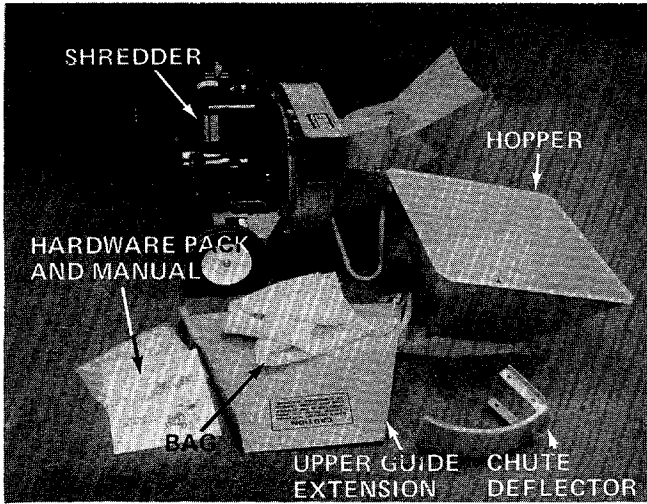

1. Remove the shredder, hardware pack and all parts and literature from the carton before discarding carton.

FIGURE 1

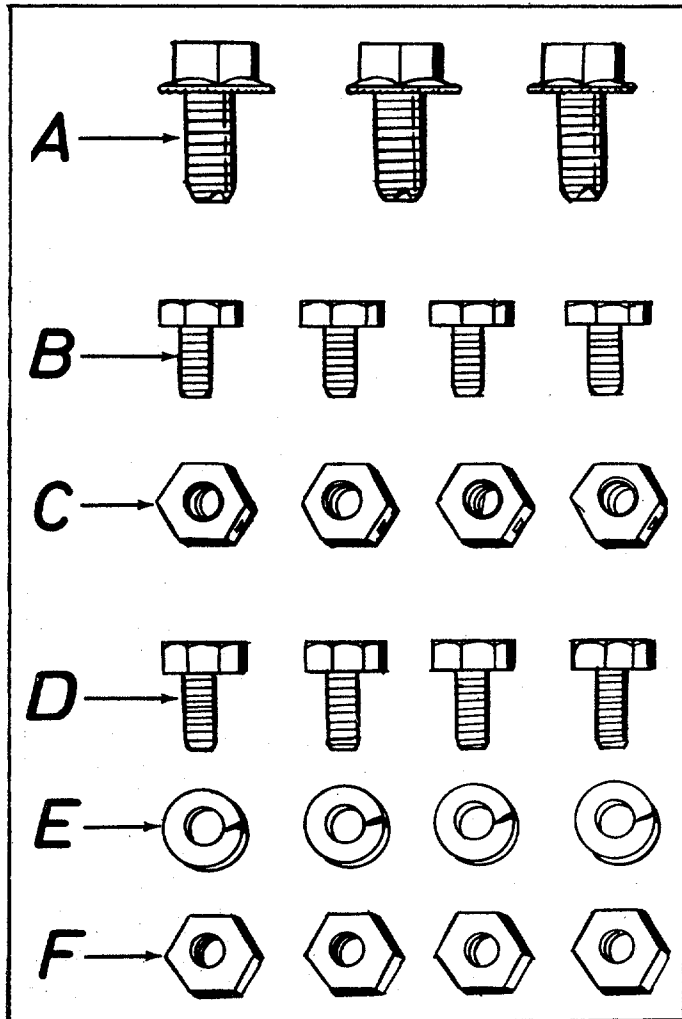

CONTENTS OF HARDWARE PACK

- A (3) Hex washer head self-tapping screws
- B (4) Hex screws 1/4-20 x 1/2" long
- C (4) Hex center lock nuts 1/4-20 thread
- D (4) Hex screws 1/4-20 x 1/2" long
- E (4) Lock washers 1/4" screw
- F (4) Hex center lock nuts 1/4-20 thread

FIGURE 2

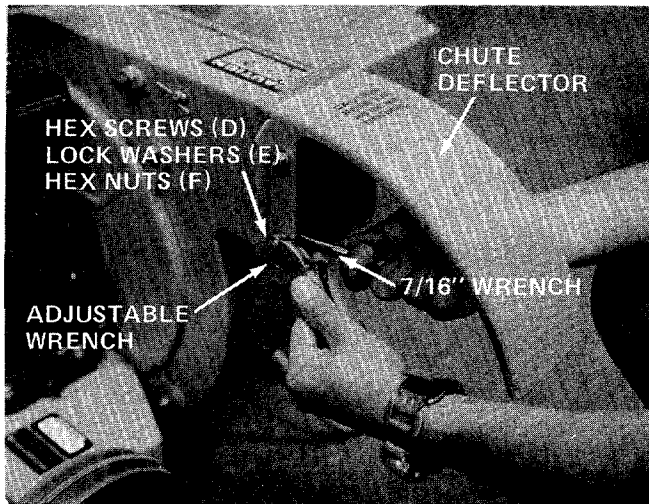

FIGURE 3

2. Place the chute deflector in position on the left hand side of shredder.

← 3. Secure with four hex screws (D), lock washers (E) and hex center lock nuts (F). Heads of screws are assembled from the inside. Nuts and washers go on the outside. Start all four screws, nuts and washers by hand, then tighten with an adjustable wrench and 7/16" wrench. See figure 3.

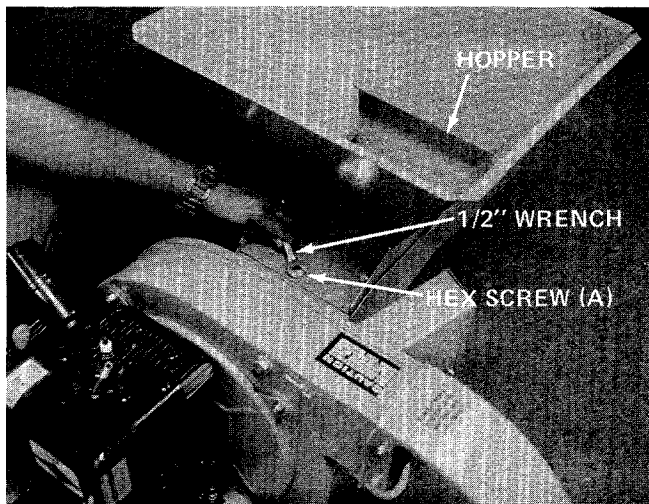

FIGURE 4

← 4. Place the hopper on the shredder. Start all three self-tapping screws (A) by hand, then tighten with a 1/2" wrench. See figure 4.

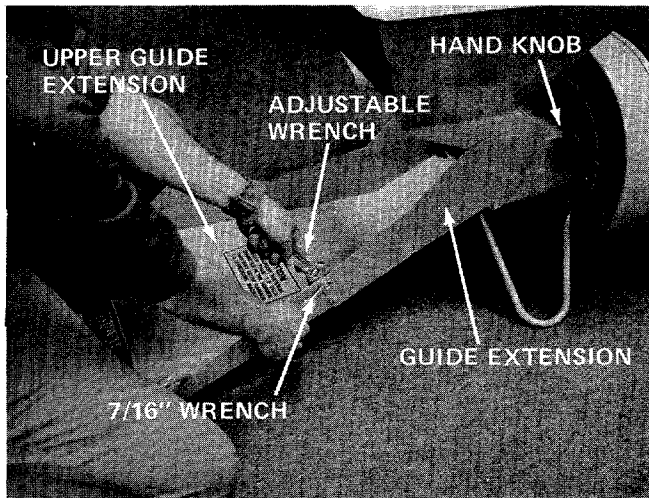

FIGURE 5

← 5. Loosen the hand knob on the right hand side of the shredder. See figure 5.

6. Place upper guide extension in place on guide extension. Secure with four hex screws (B) and hex center lock nuts (C). A 7/16" wrench and adjustable wrench are required. See figure 5.

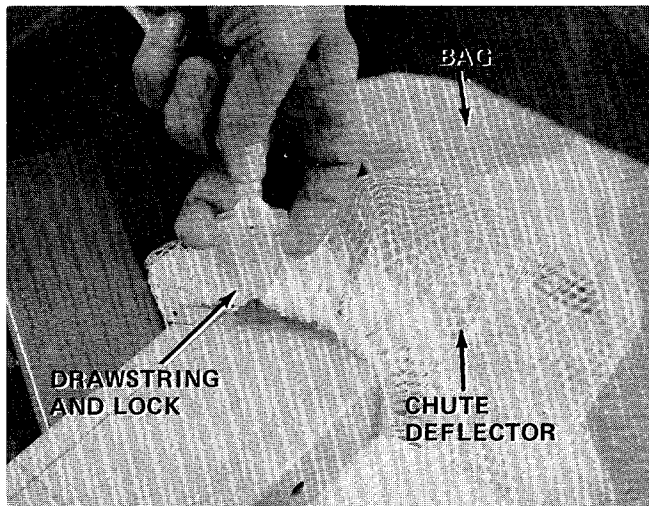

FIGURE 6

7. Place the bag over the chute deflector. Pull on the drawstring and lock. See figure 6.

OPERATION

BEFORE STARTING ENGINE

1. Fill fuel tank with fresh regular gasoline. **Do not mix oil with gasoline.**
2. Fill crankcase with oil. Use MS classification oil. Do not use oils marked only MM or ML or unmarked.
Above 32° use SAE 30; below 32° use SAE 10W. These recommendations must be followed for best performance and long life.
Position equipment so that engine is level. Remove oil fill plug. Pour oil into oil fill opening. Fill to point of overflowing. Pour slowly.
During initial break-in period, oil level should be watched closely. See maintenance section.

TO START ENGINE

1. Place control lever (on engine) in "RUN" position. See figure 7.
2. For cold engine start, move carburetor control to "CHOKE" position. See figure 7.



A warm engine may not require choking.

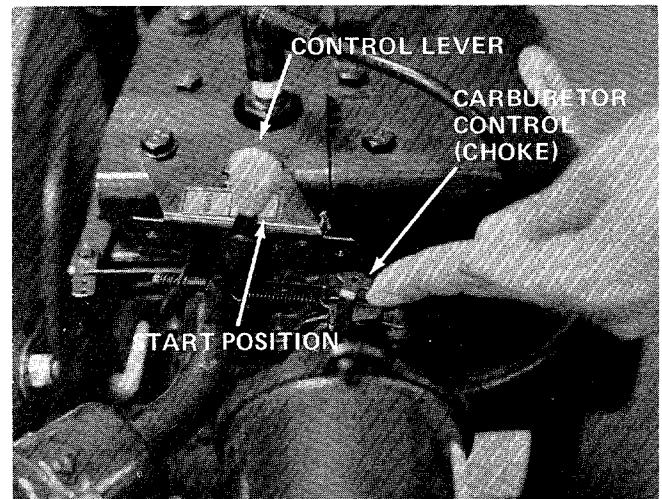

FIGURE 7

3. Pull rewind starter using a quick full arm stroke. Keep a firm grip on the handle and return rop slowly.
4. After engine starts, move choke lever on carburetor gradually to "OFF" position.

TO STOP ENGINE

1. Move control lever to "STOP" position. See figure 8.
2. Remove high tension wire from spark plug to prevent accidental starting while equipment is unattended.

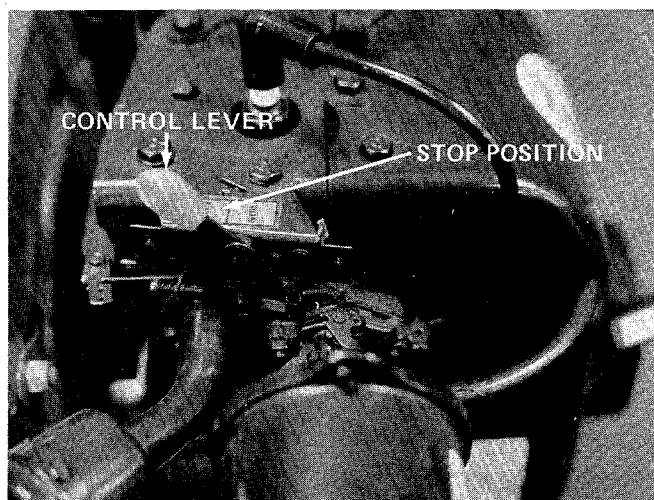

FIGURE 8

USING YOUR SHREDDER

Your shredder is designed for safe, efficient operation. CARE MUST BE EXERCISED THAT HANDS ARE KEPT AWAY FROM ALL OPENINGS.



The manufacturer recommends that the operator wear safety glasses or some other suitable eye protection as it is possible for chips to be ejected out of the inlet openings while feeding material.

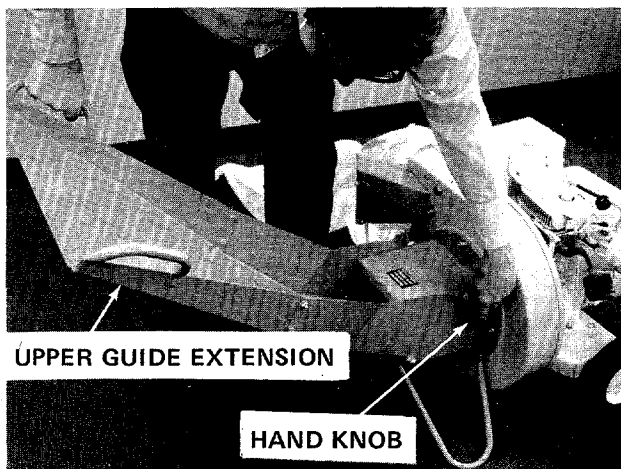

FIGURE 9. UPPER GUIDE EXTENSION ADJUSTMENT.

Your shredder upper guide extension is adjustable. It may be adjusted to desired height by loosening the hand knob as shown in figure 9. Upper guide extension can be raised to close opening if hopper is not installed.

Feed the material so that it slides down upper guide extension. See figure 10.

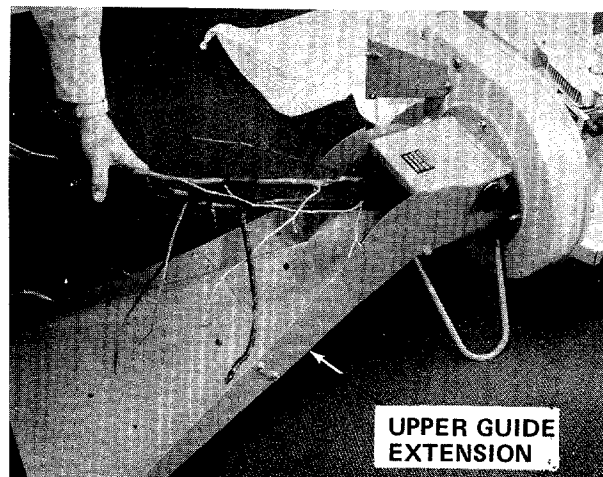

FIGURE 10. FEEDING MATERIAL INTO UPPER GUIDE EXTENSION

Leaves and small twigs can be raked into the upper guide extension when the upper guide extension is lowered. See figure 11.



FIGURE 11. RAKING LEAVES AND TWIGS INTO UPPER GUIDE EXTENSION

Bulky material, such as stalks or heavy branches, should be fed into the chip-it guide extension. See figure 12. Do not force or jam material into the chip-it guide.

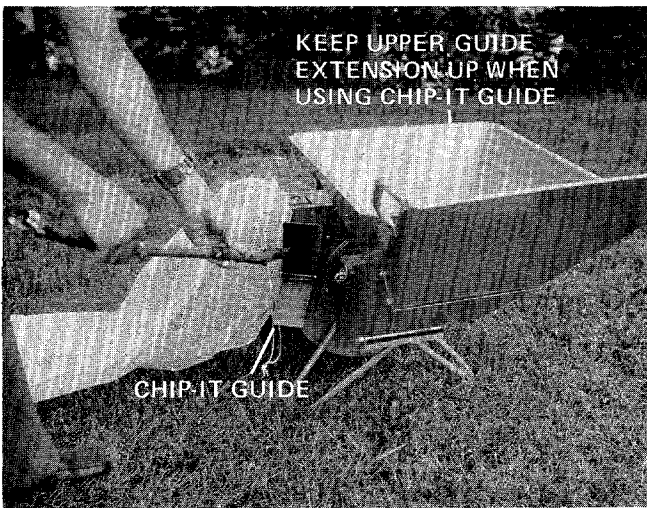

FIGURE 12. FEEDING MATERIAL INTO CHIP-IT GUIDE

Leaves and smaller branches can be fed into the hopper. See figures 13 and 14.

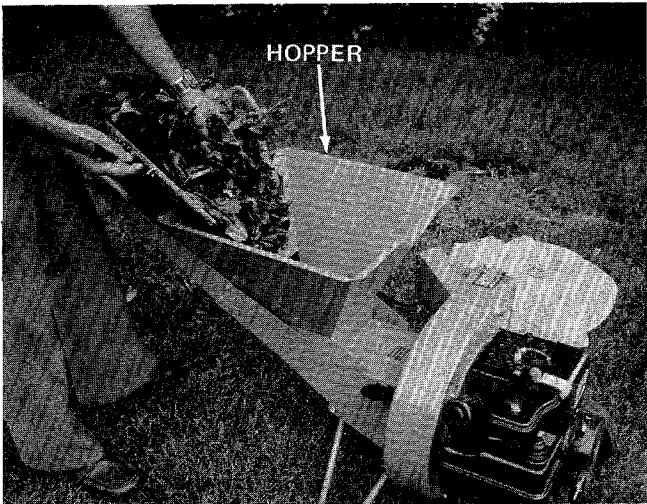

FIGURE 13. FEEDING MATERIAL INTO HOPPER

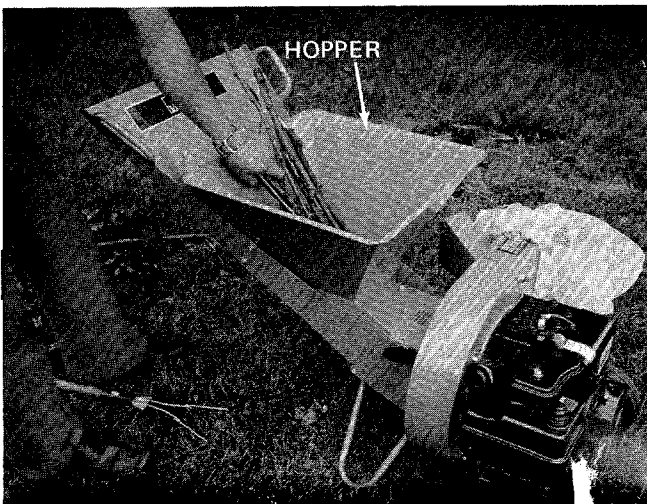

FIGURE 14. FEEDING MATERIAL INTO HOPPER



Do not deposit material larger than 1/2" diameter in hopper. This may cause damage to the shredding mechanism. Any material heavier than 1/2" should be fed into the chip-it guide extension. See figure 12.

It is possible to feed too fast. It will take some experimenting with feeding rates to get the most out of your shredder without stalling the engine. Rotate the material. A steady flow of material provides the best results.

Under certain conditions, it may be necessary to push the materials into the inlet guide assembly. When this becomes necessary, use a small diameter stick -- **NOT YOUR HANDS**. The stick should be of a size that will be ground up if it gets into the impeller assembly.

The discharge chute will direct the shredded material into a pile, a container or the bag.



Your shredder is equipped with a nylon bag with drawstring lock. This will accommodate a perforated disposable plastic bag.



Keep away from the chute area since the shredded material comes out with considerable velocity. Always stop engine and disconnect spark plug wire when changing bags.

ADJUSTMENTS



If any adjustments are made to the engine while the engine is running (e.g. carburetor), keep clear of all moving parts. Be careful of heated surfaces and muffler.

CARBURETOR ADJUSTMENTS

Do not make unnecessary adjustment. Factory settings are correct for most applications. If adjustments are needed, refer to the engine manual packed with your shredder.

LUBRICATION

WHEELS - The wheels require no lubrication.

ENGINE - Follow engine manual for lubrication instructions.

MAINTENANCE



Always stop engine and disconnect spark plug wire before performing any maintenance.

CUTTING BLADE

The blade may easily be removed for grinding or replacement as follows:

1. Remove guide extension assembly by removing four elastic lock nuts (Ref. No. 11). See page 10.
2. Remove bolt (Ref. No. 38), lock washer (Ref. No. 37) flat washer (Ref. No. 36) which holds blade (Ref. No. 45), and blade retainer (Ref. No. 48) to engine crankshaft. See page 10.



Blade is reversible and can be assembled to crankshaft with either side showing.

When sharpening blade, follow the original angle of grind as a guide. It is extremely important that each cutting edge receives an equal amount of grinding to prevent an unbalanced blade. An unbalanced blade will cause excessive vibration when rotating at high speeds and may cause damage to the unit. Upon reassembly, make certain all parts are assembled properly and tightened securely.

FLAILS AND FINGERS

The flails and fingers can be reversed when they become dull.

ENGINE OIL

1. Change oil in crankcase after first two (2) hours of operation. Then change oil every twenty-five (25) operating hours or sooner if equipment is operated in extremely dusty or dirty conditions.

Unscrew oil drain plug located on the side at the bottom of the engine (see figure 15). Always tip engine towards oil drain hole. Be sure oil drains completely.

Replace oil drain plug and refill with oil as directed on page 6.

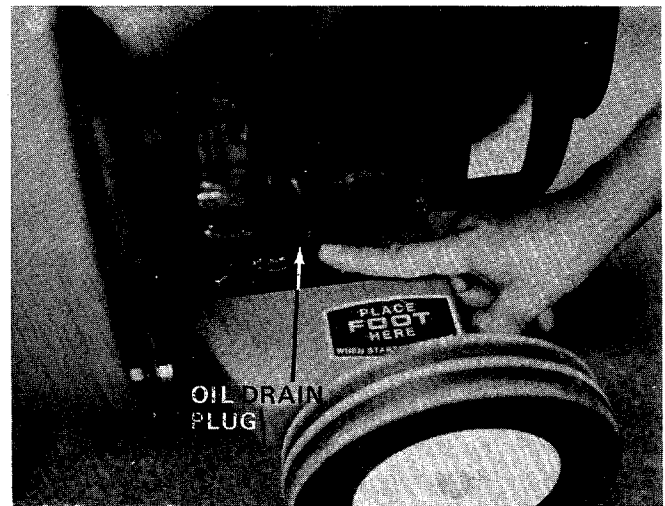

FIGURE 15

2. Check oil every five (5) operating hours or each time equipment is used. Add oil as necessary to keep level full to point of overflowing.

CLEAN ENGINE

Clean cylinder fins and underside of tank or housing thoroughly of all accumulated grass and debris. This is an aircooled engine which operates most efficiently when the cooling fins are clean.

AIR CLEANER

The air cleaner prevents damaging dirt, dust, etc. from entering the carburetor and being forced into the engine and is important to engine life and performance.

To service air cleaner, refer to the engine manual packed with the shredder.

NEVER RUN YOUR ENGINE WITHOUT AIR CLEANER COMPLETELY ASSEMBLED.

OFF-SEASON STORAGE

In event engine is to be stored for any length of time (30 days or more), prepare as follows:

1. Drain gasoline by tipping or syphon hose, then run engine until remainder is used and tank and carburetor are empty.



Drain into container outdoors away from fire or flame.

2. Protect the inside of engine for storage by removing spark plug and pouring one ounce of SAE 30 oil through spark plug hole into cylinder. Crank engine, without starting, several times to spread oil over cylinder walls.

MODEL 650

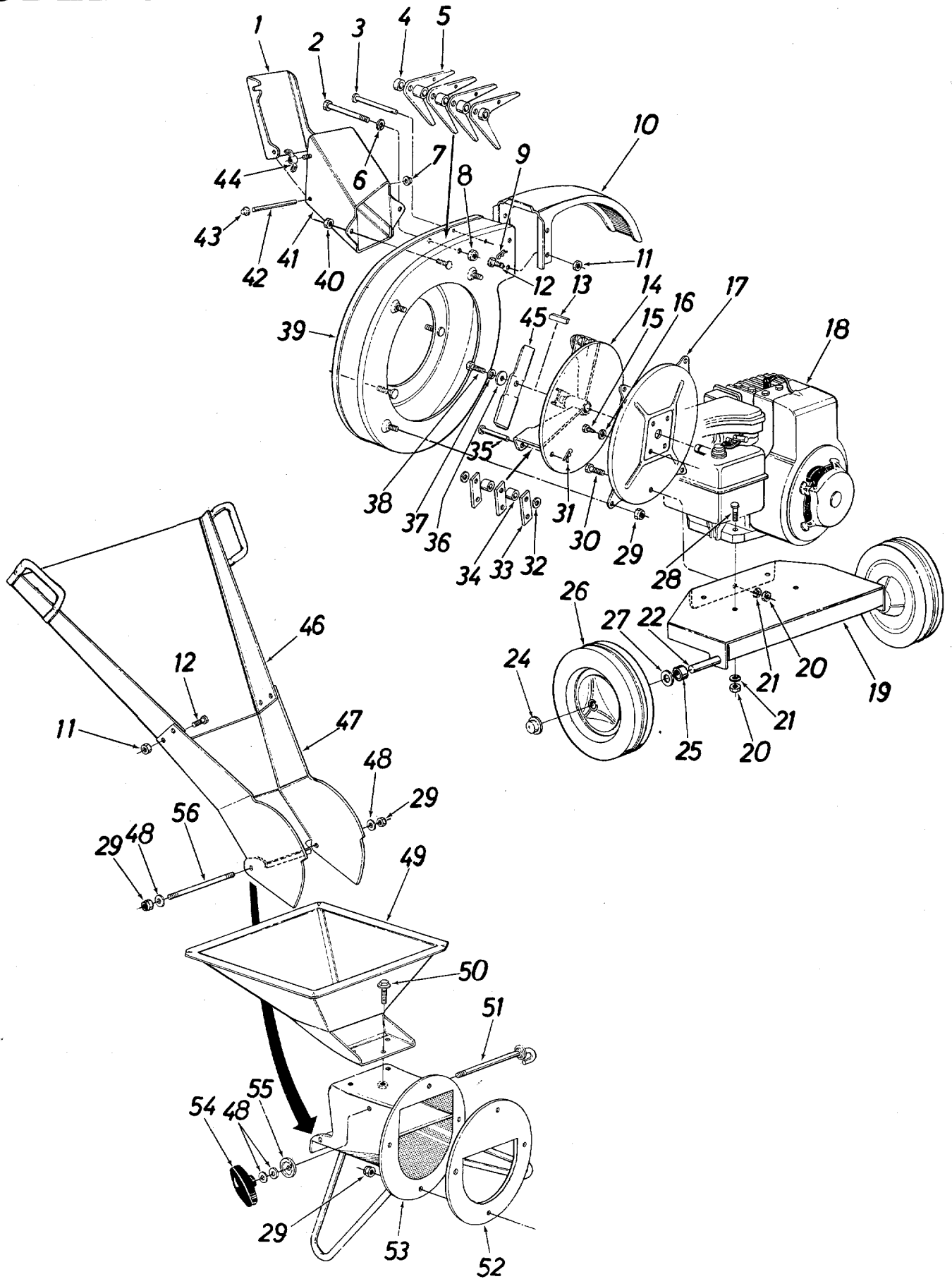

MODEL 650

PARTS LIST FOR MODEL 650 SHREDDER

Ref. No.	Part No.	Color Code	DESCRIPTION	New Part	Ref. No.	Part No.	Color Code	DESCRIPTION	New Part
1	11476	---452	Door-Chip-Ilt		32	736-0192		Fl-Wash. .531" I.D. x.937 O.D. x .09	
2	710-0465		Hex Bolt 1/2-20 x 4.50" Lg.*		33	11459		Flail	
3	711-0580		Clevis Pin		34	711-0564		Flail Spacer 23/32" Lg.	
4	711-0579		Flail Spacer 7/32" Lg.		35	711-0578		Clevis Pin .50" Dia. x 3.0" Lg.	
5	11455	---488	Cutting Finger		36	736-0247		Fl.-Wash. .406" I.D. x 1.25" O.D. Hdn.	
6	736-0921		L.-Wash. 1/2" Scr.*		37	736-0217		L.-Wash. 3/8" Scr. H.D.	
7	726-0111		Palnut 3/16" Dia.		38	710-0151		Hex Bolt 3/8-24 x 2.00" Lg. H.T.	
8	712-0922		Hex Jam Nut 1/2-20 Thd.*		39	14575	---488	Flail Housing Ass'y. -Comp.	N
9	714-0507		Cotter Pin 3/32" Dia. x 3/4" Lg.*		40	712-0107		Hex Cent. L-Nut 1/4-20 Thd.	
10	11465	---452	Chute Deflector		41	11477	---452	Upper Guide Extension Ass'y.	
11	712-0107		L.-Nut 1/4-20 Thd.		42	11478		Hinge Pin	
12	710-0289		Hex Bolt 1/4-20 x .50" Lg.*		43	726-0111		Palnut 3/16" Dia.	
13	714-0114		Sq. Key 1/4" x 2.00" Lg.*		44	712-0109		Wing Nut Elastic 1/4-20 Thd.	
14	13430	---452	Impeller Assembly		45	13431	---452	Blade	
15	710-0157		Hex Bolt 5/16-24 x 3/4" Lg.*		46	11460	---488	Guide Extension Assembly	
16	736-0119		L-Wash. 5/16" Scr.*		47	11472	---488	Guide Extension	
17	14573	---452	Hopper to Engine Mtg. Plate	N	48	736-0264		Fl-Wash. 5/16" Scr.*	
18	-----		Engine		49	11481	---488	Hopper Assembly	
19	11464	---488	Engine Mounting Plate		50	710-0601		Hex Wash. Hd. Self-Tap Scr. 5/16-18 x .50" Lg.	
20	712-0123		Hex Nut 5/16-24 Thd.*		51	11479		Clamp Rod Assembly	
21	736-0119		L-Wash. 5/16" Scr.*		52	11454	---452	Back-up Plate	
22	738-0521		Shaft		53	11467	---488	Inlet Guide Assembly	
24	726-0221		Push Cap		54	09966		Knob Ass'y.	
25	711-0494		Spacer		55	11480		Stop Washer	
26	734-1056		Wheel Ass'y. - Comp.	N	56	711-0566		Chute Pivot Rod	
27	736-0100		Fl-Wash. .50" I.D.*			764-0126		Bag (Not Shown)	
28	710-0624		Hex Bolt 5/16-24 x 1.50" Lg.*						
29	712-0429		Elastic Stopnut 5/16-18 Thd.						
30	710-0237		Hex Bolt 5/16-24 x .62" Lg.*						
31	714-0144		Cotter Pin 1/8" Dia. x 1.00" Lg.* (Special)						

(497 - Yard-Man Red)
(488 - Mack Truck Yellow)

When ordering parts, if color or finish is important use the appropriate color code shown above (e.g. Mack Truck Yellow Finish—11907 (488).)

*For faster service obtain standard nuts, bolts and washers locally. If these items cannot be obtained locally, order by part number and size as shown on parts list.

The engine is not under warranty by the shredder manufacturer. If repairs or service is needed on the engine, please contact your nearest authorized engine service outlet. Check the "Yellow Pages" of your telephone book under "Engines—Gasoline."

Find It Fast
In The
Yellow Pages



MTD PRODUCTS INC YARD-MAN COMPANY

P.O. BOX 36900 • CLEVELAND OHIO 44136

Free Manuals Download Website

<http://myh66.com>

<http://usermanuals.us>

<http://www.somanuals.com>

<http://www.4manuals.cc>

<http://www.manual-lib.com>

<http://www.404manual.com>

<http://www.luxmanual.com>

<http://aubethermostatmanual.com>

Golf course search by state

<http://golfingnear.com>

Email search by domain

<http://emailbydomain.com>

Auto manuals search

<http://auto.somanuals.com>

TV manuals search

<http://tv.somanuals.com>