

# OWNER'S MANUAL

## 18" ROTARY MOWERS

### Model Numbers

112-011A

112-020A

112-011-300

112-020-300

**Important:**  
**Read Safety Rules and**  
**Instructions Carefully**

Thank you for purchasing an  
American built product.

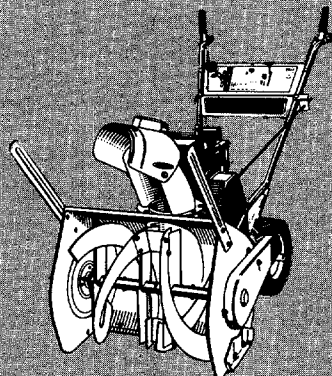
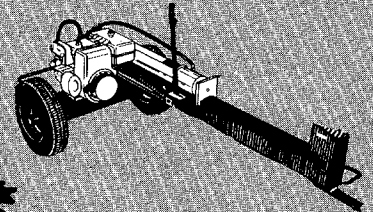
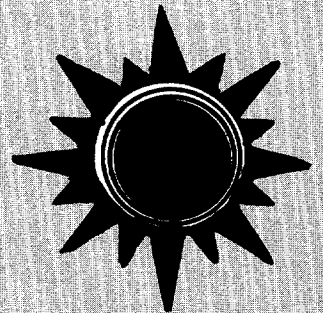
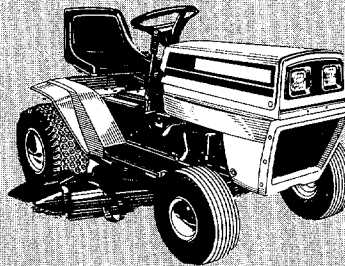
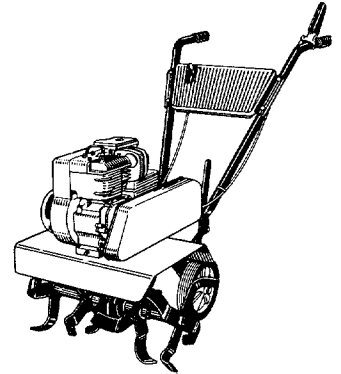

# INDEX

Safe Operation Practices.....	3	Maintenance .....	8
Assembly .....	4	Off-Season Storage.....	9
Operation .....	6	Illustrated Parts.....	10
Using Your Rotary Mower.....	7	Repair Parts List.....	11
Adjustments.....	8	Parts Information.....	Back Cover
Lubrication .....	8		

## LIMITED WARRANTY

For one year from the date of original retail purchase, MTD PRODUCTS INC will either repair or replace, at its option, free of charge, F.O.B. factory or authorized service firm, any part or parts found to be defective in material or workmanship. Transportation charges for the movement of any power equipment unit or attachment are the responsibility of the purchaser. Transportation charges for any parts submitted for replacement under this warranty must be paid by the purchaser unless such return is requested by MTD PRODUCTS INC.

This warranty will not apply to any part which has become inoperative due to misuse, excessive use, accident, neglect, improper maintenance, alterations, or unless the unit has been operated and maintained in accordance with the instructions furnished. This warranty does not apply to the engine, motor, battery, battery charger or component parts thereof. Please refer to the applicable manufacturer's warranty on these items.

This warranty will not apply where the unit has been used commercially.

Warranty service is available through your local authorized service dealer or distributor. If you do not know the dealer or distributor in your area, please write to the Customer Service Department of MTD.

The return of a complete unit will not be accepted by the factory unless prior written permission has been extended by MTD.

This warranty gives you specific legal rights. You may also have other rights which vary from state to state.



**WARNING**

### TO PURCHASERS OF INTERNAL COMBUSTION ENGINE EQUIPPED MACHINERY OR DEVICES IN THE STATE OF CALIFORNIA

The equipment which you have just purchased does not have a spark arrester. If this equipment is used on any forest covered land, brush covered land, or grass covered unimproved land in the State of California, before using on such land, the California law requires that a spark arrester be provided. In addition, spark arrester is required by law to be in effective working order. The spark arrester must be attached to the exhaust system and comply with Section 4442 of the California Public Resources Code.



## WARNING

To reduce the potential for any injury, comply with the following safety instructions. Failure to comply with the instructions may result in personal injury.

# SAFE OPERATION PRACTICES FOR WALK-BEHIND MOWERS

## TRAINING

1. It is suggested that this manual be read in its entirety before attempting to assemble or operate this unit. Keep this manual in a safe place for future reference and for ordering replacement parts.
2. Your rotary mower is a precision piece of power equipment, not a plaything. Therefore, exercise extreme caution at all times.
3. Read this Owner's Manual carefully. Be thoroughly familiar with the controls and the proper use of the equipment.
4. Never allow children to operate a power mower. Only persons well acquainted with these rules of safe operation should be allowed to use your mower.
5. Keep the area of operation clear of all persons, particularly small children and pets. Stop engine when they are in the vicinity of your mower. Although the area of operation should be completely cleared of foreign objects, a small object may have been overlooked and could be accidentally thrown by the mower in any direction and cause injury.
4. After striking a foreign object, stop the engine, remove the wire from the spark plug, and thoroughly inspect the mower for any damage. Repair the damage before restarting and operating the mower.
5. If the equipment should start to vibrate abnormally, stop the engine and check immediately for the cause. Vibration is generally a warning of trouble.
6. Stop the engine whenever you leave the mower, before cleaning the mower housing, and when making any repairs or inspections.
7. When cleaning, repairing or inspecting, make certain the blade and all moving parts have stopped. Disconnect the spark plug wire, and keep the wire away from the plug to prevent accidental starting.
8. Before attempting to unclog the mower or discharge chute, stop the engine and be sure the blade has stopped completely. The cutting blade continues to rotate for a few seconds after the engine is shut off. Never place any part of the body in the blade area until you are sure the blade has stopped rotating. Disconnect the spark plug wire and keep the wire away from the plug to prevent accidental starting.

## PREPARATION

1. Thoroughly inspect the area where the equipment is to be used. Remove all stones, sticks, wire, bones and other foreign objects which could be picked up and thrown by the mower in any direction and cause injury.
2. Do not operate equipment when barefoot or wearing open sandals. Always wear substantial footwear.
3. Do not wear loose fitting clothing that could get caught on the mower.
4. Check the fuel before starting the engine. Gasoline is an extremely flammable fuel. Do not fill the gasoline tank indoors, while the engine is running, or while the engine is still hot. Wipe off any spilled gasoline before starting the engine as it may cause a fire or explosion.
5. Disengage the self-propelled mechanism or drive clutch on units so equipped before starting the engine.
6. Never attempt to make a wheel or cutting height adjustment while the engine is running.
7. Mow only in daylight or in good artificial light.
8. Never operate the equipment in wet grass. Always be sure of your footing. Keep a firm hold on the handle and walk, never run.
9. Do not run the engine indoors.
10. Shut the engine off and wait until the blade comes to a complete stop before removing the grass catcher or unclogging chute.
11. Mow across the face of slopes, never up-and-down. Exercise extreme caution when changing direction on slopes. Do not mow excessively steep slopes.
12. Always disconnect electric mowers (line operated) before cleaning, repairing or adjusting.
13. Never operate mower without proper guards, plates or other safety protective devices in place.
14. Keep washout ports and other mower-housing service openings closed when mowing.

## OPERATION

1. Do not change the engine governor settings or overspeed the engine. Excessive engine speeds are dangerous.
2. Do not put hands or feet near or under rotating parts. Keep clear of the discharge opening at all times as the rotating blade can cause injury.
3. Stop the blade when crossing gravel drives, walks or roads.
3. Never store the equipment with gasoline in the tank inside of a building where fumes may reach an open flame or spark. Allow the engine to cool before storing in any enclosure.
4. To reduce fire hazard, keep the engine free of grass, leaves, or excessive grease.
5. Check the grass catcher bag frequently for wear or deterioration. For safety protection, replace only with new bag meeting original equipment specifications.

# ASSEMBLY INSTRUCTIONS



This unit is shipped WITHOUT GASOLINE or OIL. After assembly, see engine manual for proper fuel and engine oil recommendations.

## Tools Required for Assembly:

- (1) Adjustable Wrench
- (1) 7/16" Open End or Box Wrench
- (1) 3/4" Open End or Box Wrench

## ← Contents of Hardware Pack: (See Figure 1)

- A (5) Hex Bolts 1/4-20 x 1 1/2" Long (020 Only)
- (6) Hex Bolts 1/4-20 x 1 1/2" Long (011 Only)
- B (6) Hex Lock Nuts 1/4-20 Thread
- C (1) Hex Bolt 1/4-20 x 1 3/4" Long (020 Only)
- D (2) Cable Ties (020 Only)
- E (4) Shoulder Bolts (Axles)
- F (4) Belleville Washers
- G (2) Hairpin Cotter
- H (2) Hand Grips (Not Shown)

## ← Loose Parts in Carton: (See Figure 2)

- I (4) Wheels
- J (2) Upper Handles
- K (1) Lower Handle

1. Remove lawn mower and all parts from the carton. Make certain that all loose parts and literature have been removed before the carton is discarded.

2. **Model 020 Only**—Extend throttle control assembly which is attached to engine at the rear of the mower and place on floor. Be careful not to bend or kink control wire.

3. Your mower has four height settings. Use the same hole for all four wheels when assembling. See figure 3.

A. Place shoulder bolt (E) through wheel (I). See figure 3.

B. Place crown side of belleville washer (F) towards the wheel (away from deck). See figure 3.

C. Secure wheel to deck, using a 3/4" wrench.

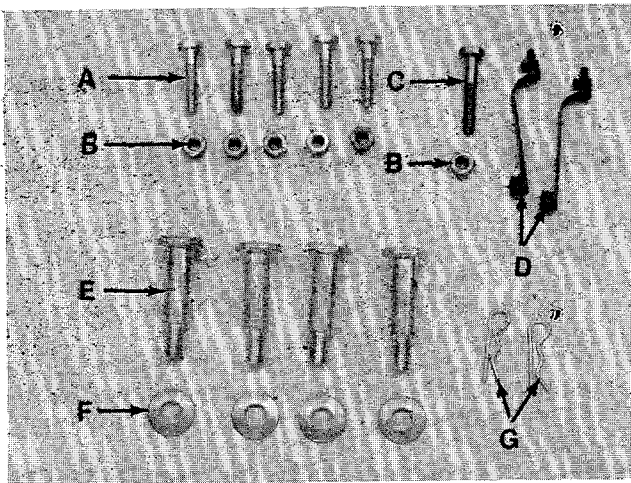

FIGURE 1.

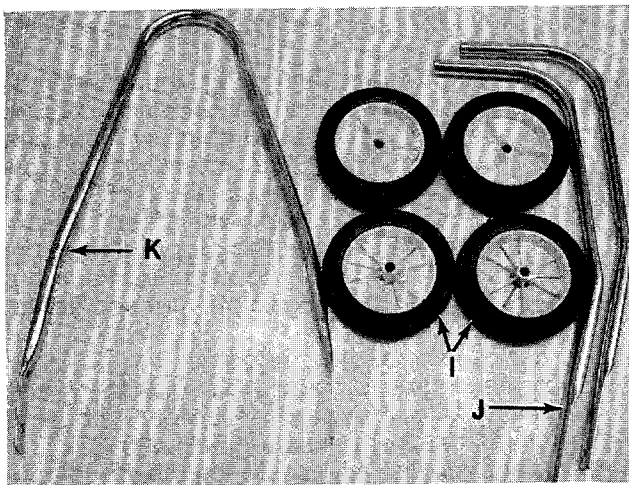

FIGURE 2.

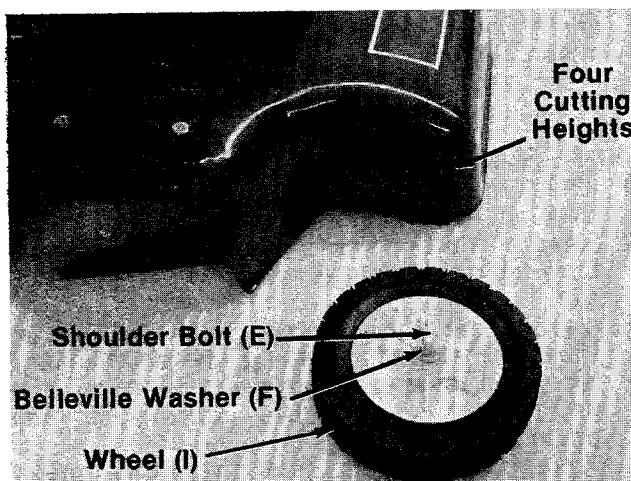

FIGURE 3.

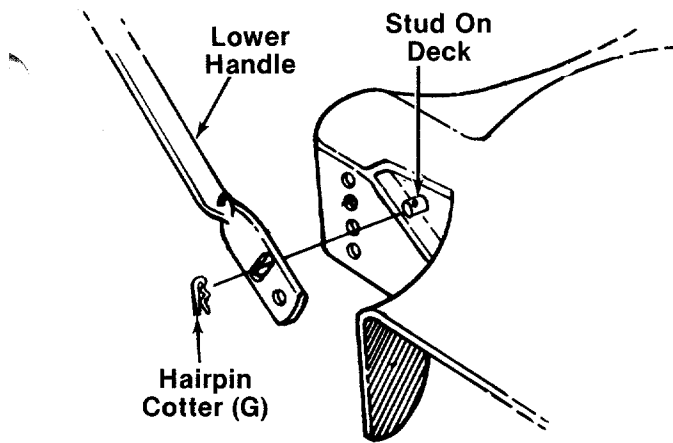

FIGURE 4.

4. Place **upper slotted hole** of lower handle (K) over studs located in front of each rear wheel. Secure with hairpin cotter (G) provided in hardware pack. See figure 4.

**NOTE**

It may be necessary to bend the ends of the lower handle inward slightly to obtain a snug fit against the deck.

**NOTE**

Figure 4 is shown with the rear wheel removed for clarity. It is not necessary to remove wheel for handle assembly.

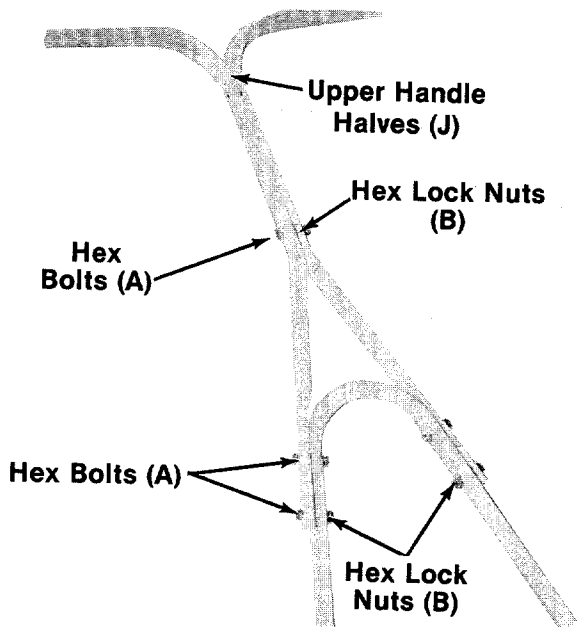

FIGURE 5.

5. Assemble the upper handle halves (J) to lower handle using five hex bolts (A) and lock nuts (B). Only tighten finger tight. See figure 5.
- 6A. **Model 011 Only**—Secure upper handle halves at the top hole using the sixth hex bolt (A).

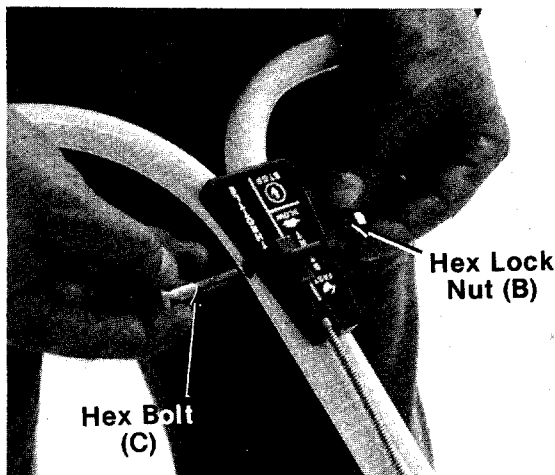

FIGURE 6. Model 020 Only

- 6B. **Model 020 Only**—Place the tab on throttle control between the upper handle halves at top hole. Secure with hex bolt (C) and hex lock nut (B) provided in hardware pack. See figure 6.
7. Tighten securely all six hex bolts and hex lock nuts with 7/16" wrench.

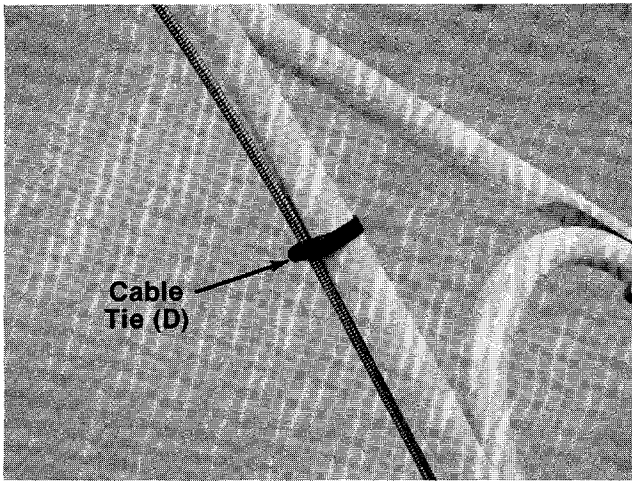

FIGURE 7. Model 020 Only

8. **Model 020 Only**—Secure throttle control wire to upper and lower handles with two cable ties (D) provided in hardware pack. See figure 7.
9. Slip hand grips (H) on the upper end of each handle. They will slip on more easily if you first soak them in warm, soapy water.
10. Check **all** nuts and bolts for correct tightness.

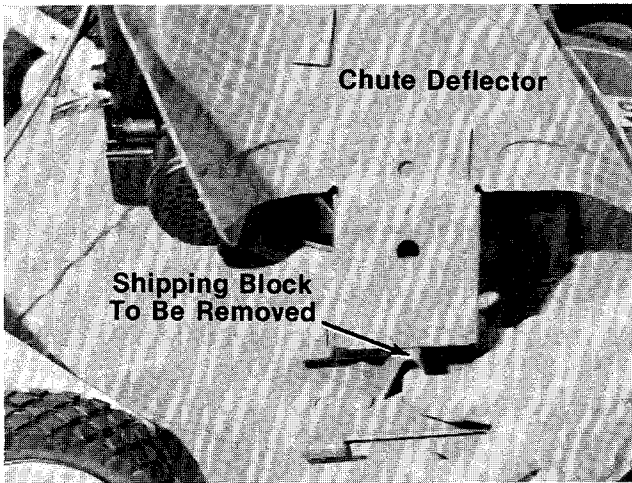

FIGURE 8.



**CAUTION**

Please note that the chute deflector on your mower is in an upright position. It is held in that position by a shipping block. This block is used for shipping purposes only. It must be removed and discarded before your mower is put into operation. See figure 8.

## OPERATION

Keep hands and feet away from the chute area on cutting deck. See figure 9.

### BEFORE STARTING ENGINE

#### Model 020 Only

1. Fill sump with oil, using a high quality detergent oil classified "For Service SC, SD, SE or MS." Nothing should be added to the recommended oil.

Use SAE 30 oil. If not available, use SAE 10W-30.

Place the engine level. Remove oil filler plug. **FILL THE OIL SUMP TO POINT OF OVERFLOWING.** Pour slowly. Capacity 1-1/4 pints.

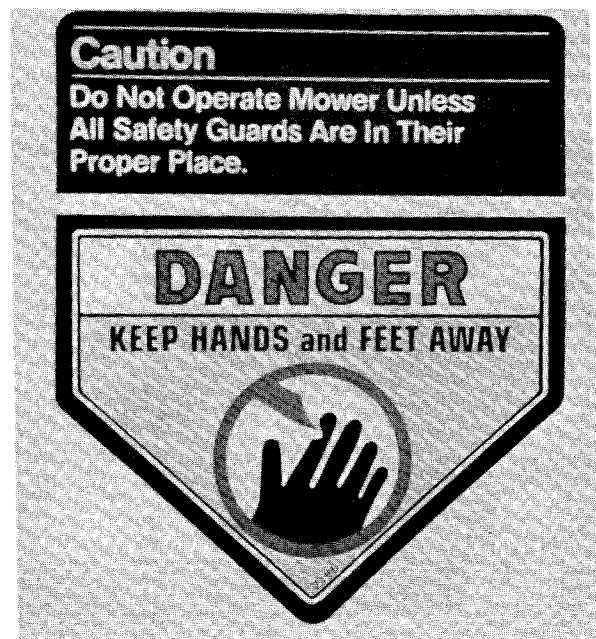

FIGURE 9.



2. Fill fuel tank using clean, fresh, **regular** grade automotive gasoline. Fill tank completely!  
DO NOT MIX OIL WITH GASOLINE.

#### Model 011 Only

This mower has a two cycle engine. It **MUST** use a gasoline-oil mixture of 24:1. Use clean, fresh, **regular** grade automotive gasoline. Refer to engine manual packed with your unit for oil recommendations and mixing procedures.

#### TO START ENGINE

1. **Model 020 Only**—Place throttle control lever on handle in “START” position.  
**Model 011 Only**—Place lever located beneath fuel tank on engine in “CHOKE” position. Make sure spark plug shorting clip is away from the spark plug.
2. Standing on the left side of the unit, place one foot on the mower deck, grasp the starter rope handle and pull to start. NOTE: Left side of unit is determined from behind the unit (in the operator’s position).
3. After engine starts, move throttle control on handle to desired engine speed (Model 020) or place lever on engine in “RUN” position (Model 011).

#### TO STOP ENGINE

1. **Model 020 Only**—Stop engine by placing throttle control lever on handle to “STOP” position.  
**Model 011 Only**—Stop engine by moving the spark plug shorting clip against the spark plug. See figure 10.
2. Disconnect spark plug wire and ground against the engine to prevent accidental starting while equipment is unattended.

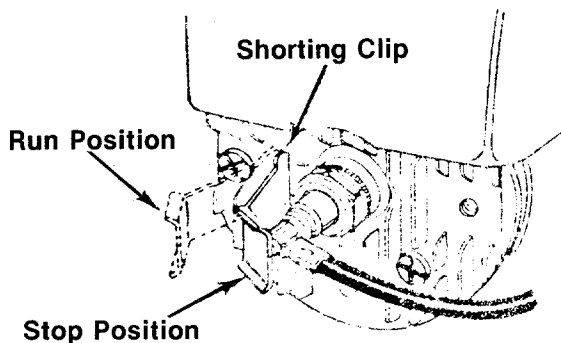

FIGURE 10. Model 011 Only

Be sure that lawn is clear of stones, sticks, wire, or other objects which could damage lawn mower or engine. For best results and to insure more even grass distribution, do not mow when lawn is excessively wet.



If you strike a foreign object, stop the engine. Remove wire from spark plug and thoroughly inspect the mower for any damage. Repair the damage before restarting and operating the mower.

## USING YOUR ROTARY MOWER

For the best results, do not cut wet grass because it tends to stick to the underside of the mower, preventing proper discharge of grass clippings. If wet grass must be cut, reduce walking speed to help distribute the clippings more effectively.

New grass, thick grass or wet grass may require a narrower cut. Blade speed should be adjusted to the condition of the lawn.

The best mowing pattern is one that allows the clippings to discharge towards the uncut part of the lawn. This permits recutting of the clippings to further pulverize them. When cutting high weeds, discharge towards cut portion then recut at right angles to first direction.

For best results, cut off one-third or less of the total length of the grass. Lawn should be cut in the fall as long as there is growth.

## ADJUSTMENTS



Do not at any time make any adjustment to lawn mower without first stopping engine and disconnecting spark plug wire.

#### CUTTING HEIGHT

Adjustment is made by removing and moving axle bolts to desired position. Cutting heights will be raised as axle bolts are moved to a lower hole and lowered as axle bolts are moved to a higher hole in the deck. All axle bolts must be mounted in the same relative position to the deck. The cupped side of the belleville washers must be against the deck. See figure 3.

#### THROTTLE (Model 020 Only)

If adjustment becomes necessary, the throttle control wire assembly can be reset as follows:

1. Loosen, but do not remove, screw securing throttle control wire assembly at engine. See figure 11.

2. Move throttle control lever on handle to "FAST" position.
3. Move lever, to which control wire is fastened at engine, to full open position and retighten screw to secure throttle control wire assembly.

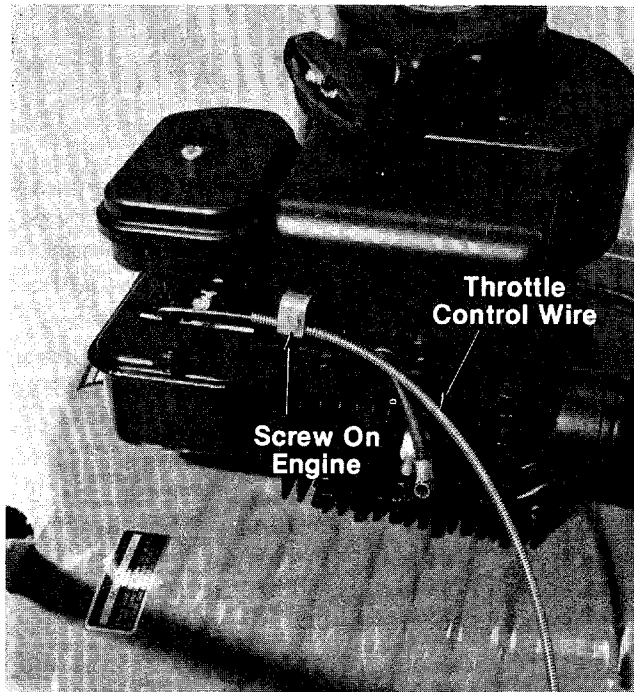

FIGURE 11 Model 020 Only

### CARBURETOR ADJUSTMENTS



If any adjustments are made to the engine while the engine is running (e.g. carburetor), disengage all clutches and blades. Keep clear of all moving parts. Be careful of heated surfaces and muffler.

Minor carburetor adjustment may be required to compensate for differences in fuel, temperature, altitude and load.

Refer to engine manual packed with your mower for carburetor adjustment information.

### LUBRICATION



Always stop engine and disconnect spark plug wire before cleaning, lubricating or doing any kind of work on lawn mower.

**Wheels**—The wheels require no lubrication. However, if the wheels are removed for any reason, lubricate the surface of the axle bolt and the inner surface of the wheel with light oil. A 4 oz. plastic bottle of light oil lubricant is available. Order part number 737-0170. Engine oil may also be used.

**Protective Shield**—The pivot points on the protective shield should be lubricated periodically with light oil to prevent any rust or binding.

**Chute Deflector**—The torsion spring and pivot point should be lubricated periodically with light oil to prevent any rust or binding. Deflector must work freely.

**Engine**—Follow engine manual for lubrication instructions.

**Throttle (Model 020 Only)**—Periodically lubricate throttle control lever and throttle wire assembly with a few drops of light oil for ease of operation.

## MAINTENANCE



Disconnect spark plug wire and ground it against the engine before performing any repairs or maintenance

### CUTTING BLADE

#### A. Removal for Sharpening or Replacement



Be sure to disconnect and ground the spark plug wire before working on the cutting blade to prevent accidental engine starting.

1. Remove the large bolt and lock washer which holds the blade and adapter to the engine crankshaft.
2. Remove the blade and adapter from the crankshaft. Be careful not to lose the key on the crankshaft.
3. If the blade or blade adapter needs replacing, remove the two small bolts, lock washers and nuts which hold the blade to the adapter.



## B. Sharpening

Remove the cutting blade by following the directions of the preceding section.

When sharpening the blade, follow the original angle of grind as a guide. It is **extremely important** that each cutting edge receives an equal amount of grinding to prevent an unbalanced blade. An unbalanced blade will cause excessive vibration when rotating at high speeds, may cause damage to the mower and could break, causing personal injury.

The blade can be tested for balance by balancing it on a round shaft screwdriver. Remove metal from the heavy side until it balances evenly.



### NOTE

It is recommended that the blade always be removed from the adapter for the best test of balance.

## C. Reassembly

Before reassembling the blade and the blade adapter to the unit, lubricate the engine crankshaft and the inner surface of the blade adapter with light oil. Lubricating the bolt holes, bolts and inner surface of the nuts with light oil is also recommended. A 4 oz. plastic bottle of light oil lubricant is available. Order part number 737-0170. Engine oil may also be used.

When replacing the blade, be sure to install the blade with the side of the blade marked "Bottom" (or with part number) facing the ground when the mower is in the operating position. Make certain key is in place on the crankshaft.

### Blade Mounting Torque

3/8" Dia. Bolt 375 in. lb. min., 450 in. lb. max.

5/16" Dia. Bolt 150 in. lb. min., 250 in. lb. max.

To insure safe operation of your unit, **ALL** nuts and bolts must be checked periodically for correct tightness.

## DECK

The underside of mower deck should be cleaned after each period of use as grass clippings, leaves, dirt and other matter will accumulate. This accumulation of grass clippings, etc., is undesirable as it will invite rust and corrosion and may cause an uneven discharge of grass clippings at the next cutting.

The deck may be cleaned by tilting the mower forward or on its side and scraping clean with a suitable tool or by washing with a stream of water from a garden hose.



## CAUTION

Do not direct the stream of water at a hot engine as damage to the engine may result.

## AIR CLEANER

Service air cleaner every 25 hours under normal conditions. Clean every few hours under extremely dusty conditions. Poor engine performance and flooding usually indicates that the air cleaner should be serviced. To service air cleaner, refer to engine manual packed with your mower.

## SPARK PLUG

The spark plug should be cleaned and the gap reset once a season. Spark plug replacement is recommended at the start of each mowing season. Check engine manual for correct plug type and gap specification.

## OFF-SEASON STORAGE

The following steps should be taken to prepare lawn mower for storage.

1. Clean and lubricate mower thoroughly as described in the preceding instructions.
2. Refer to engine manual for correct engine storage instructions.
3. Coat mower's cutting blade with chassis grease to prevent rusting.
4. Place blocks under deck to raise tires clear of floor.
5. Store mower in a dry, clean area.

# Models 011 and 020

IF YOU WRITE TO US ABOUT THIS ARTICLE  
OR IF YOU ORDER REPLACEMENT PARTS AL-  
WAYS MENTION THIS MODEL & SERIAL NO  
MODEL

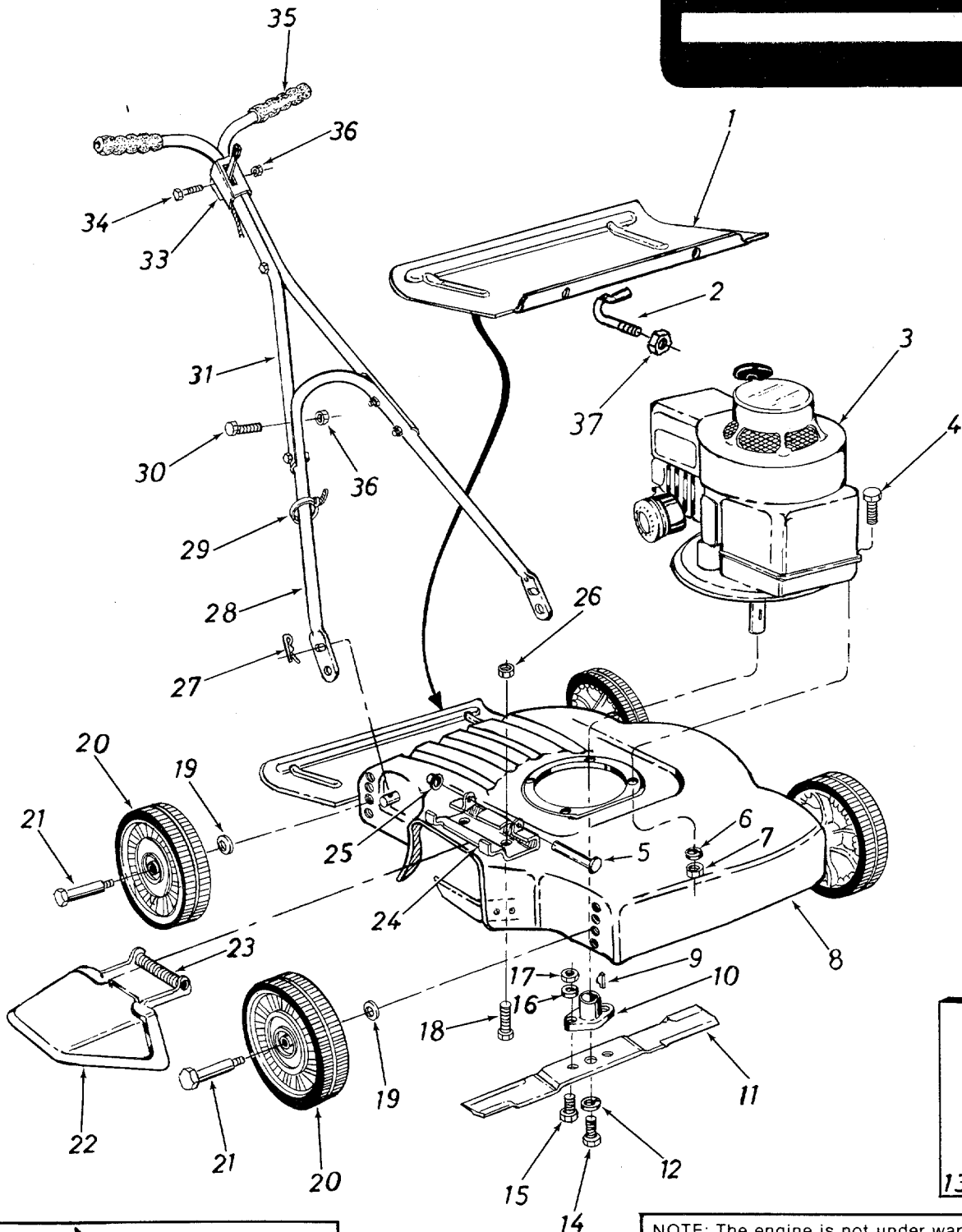

This instruction manual covers various models and all specifications shown do not necessarily apply to your model. Specifications subject to change without notice or obligation.

NOTE: The engine is not under warranty by the mower manufacturer . . . If repairs or service is needed on the engine, please contact your nearest authorized engine service outlet. Check the "Yellow Pages" of your telephone book under "Engines—Gasoline."

Find It Fast  
In The  
Yellow Pages

# Models 011 and 020

## PARTS LIST FOR MODELS 011 and 020 ROTARY MOWERS

REF. NO.	PART NO.	COLOR CODE	DESCRIPTION	NEW PART	REF. NO.	PART NO.	COLOR CODE	DESCRIPTION	NEW PART
1	14375	—486	Protective Shield Ass'y. Comp.		23	732-0253		Torsion Spring	
2	711-0718		Mounting Hook Rear Shield		24	11130		Adapter Plate	
3	—		Engine		25	726-0106		Push-On Flange Palnut	
4	710-0158		Hex Scr. 5/16-24 x 1 1/4" Lg.*		26	712-0107		Hex Cent. L-Nut 1/4-20 Thd.	
5	711-0555		Pivot Pin		27	714-0104		Hairpin Cotter	
6	736-0119		L-Wash. 5/16" Scr.*		28	749-0386		Lower Handle (Painted)	
7	712-0123		Hex Nut 5/16-24 Thd.*		29	726-0188		Lower Handle (Chrome)	
8	11402	—486	Deck Ass'y.—Complete		30	710-0606		Cable Tie (020)	
9	714-0365		#6 Hi-Pro Key 5/32 x 5/8" Dia.		31	749-0111		Hex Scr. 1/4-20 x 1.50" Lg.*	
10	10769		Blade Adapter Kit					Upper Handle (2 Req'd.) (Painted)	
11	742-0121		18 Inch Blade			749-0397		Upper Handle (2 Req'd.) (Chrome)	
12	736-0217		L-Wash. 3/8" Scr. H.D.		33	746-0258		Throttle Control Ass'y. Comp. (020)	
13	10769		Blade Adapter Kit		34	710-0136		Hex Bolt 1/4-20 x 1.75" Lg.* (020)	
14	710-0459		Hex Scr. 3/8-24 x 1 1/2" Lg.			710-0606		Hex Bolt 1/4-20 x 1.50" Lg.* (011)	
15	710-0117		Hex Scr. 5/16-24 x 1" Lg.		35	720-0157		Grip	
16	736-0119		L-Wash. 5/16" Scr.		36	712-0107		Hex Cent. L-Nut 1/4-20 Thd.	
17	712-0123		Hex Nut 5/16-24 Thd.*		37	712-0287		Hex Nut 1/4-20 Thd.*	
18	710-0289		Hex Scr. 1/4-20 x .50" Lg.*						
19	736-0105		Bell-Wash. 3/8" Scr.						
20	734-0839		Wheel Ass'y.—Complete						
21	738-0213		Axle Bolt						
22	11681	—486	Chute Deflector Ass'y.						

\*For faster service obtain standard nuts, bolts and washers locally. If these items cannot be obtained locally, order by part number and size as shown on parts list.

(486—Star Orange) When ordering parts if color or finish is important, use the appropriate color code shown at left. (e.g. Star Orange Finish—11402 (486).)

### Hub Caps Available

Color	Part No.
Red	731-0124
Orange	731-0254
Black	731-0354
Gray	731-0355

### NOTE

The use of any accessory on this Rotary Mower other than those manufactured by the mower manufacturer is **not** recommended.

GRASS CATCHER Model 004 is available as optional equipment for the mowers shown in this manual.



1. The mower should not be operated without the entire grass catcher or chute deflector in place.
2. The mower should not be operated without the protective shield on the rear of the deck in place.

### NOTE

Under normal usage bag material is subject to wear and should be checked periodically. Be sure any replacement bag complies with the mower manufacturer's recommendations. For replacement bags, use only factory authorized replacement bag No. 764-0176.

# PARTS INFORMATION

## POWER EQUIPMENT PARTS AND SERVICE

Parts and service for all MTD manufactured power equipment are available through the authorized service firms listed below. All orders should specify the model number of your unit, part numbers, description of parts and the quantity of each part required.

**NOTE:** If any parts are found to be missing or defective upon assembly of this unit, write to advise the factory so that immediate replacement can be made.

<b>ALABAMA</b>	<b>BIRMINGHAM</b>	
Auto Electric & Carburetor Co. . . . .	2625 4th Ave. S. . . . .	35233
<b>ARKANSAS</b>	<b>FORT SMITH</b>	
Mity Mite Motors, Inc. . . . .	4515 S. 16th St. . . . .	72901
	<b>NORTH LITTLE ROCK</b>	
Sutton's Lawn Mower Shop . . . . .	Rt. 4, Box 368 . . . . .	72117
<b>CALIFORNIA</b>	<b>PORTERVILLE</b>	
Billious . . . . .	75 North D Street . . . . .	93257
<b>COLORADO</b>	<b>DENVER</b>	
Spitzer Industrial Products Co. . . . .	6601 N. Washington St., Box 29114 . . . . .	80229
<b>FLORIDA</b>	<b>JACKSONVILLE</b>	
Radco Distributors . . . . .	4909 Victor St., Box 5459 . . . . .	32207
	<b>OPA LOCKA</b>	
Small Eng. Dist. . . . .	2351 N.W. 147th St. . . . .	33054
<b>GEORGIA</b>	<b>EAST POINT</b>	
East Point Cycle & Key . . . . .	2834 Church St. . . . .	30344
<b>ILLINOIS</b>	<b>LYONS</b>	
Keen Edge Co. . . . .	8615 Ogden Ave. . . . .	60534
<b>INDIANA</b>	<b>ELKHART</b>	
Parts & Sales Inc. . . . .	2101 Industrial Pkwy. . . . .	46514
<b>IOWA</b>	<b>DUBUQUE</b>	
Power Lawn & Garden Equip. . . . .	2551 J.F. Kennedy . . . . .	52001
<b>LOUISIANA</b>	<b>NEW ORLEANS</b>	
Suhren Engine Co. . . . .	8330 Earhart Blvd. . . . .	70118
<b>MARYLAND</b>	<b>TAKOMA PARK</b>	
Center Supply Co. . . . .	6867 New Hampshire Ave. . . . .	20012
<b>MASSACHUSETTS</b>	<b>SPRINGFIELD</b>	
Morton B. Collins Co. . . . .	300 Birnie Ave. . . . .	01107
<b>MICHIGAN</b>	<b>LANSING</b>	
Lorenz Service Co. . . . .	2500 S. Pennsylvania . . . . .	48910
	<b>MOUNT CLEMENS</b>	
Power Equipment Dist. . . . .	340 Hubbard . . . . .	48043
<b>MINNESOTA</b>	<b>HOPKINS</b>	
Hance Distributing Inc. . . . .	420 Excelsior Ave. W. . . . .	55343
<b>MISSISSIPPI</b>	<b>BILOXI</b>	
Biloxi Sales & Service, Inc. . . . .	506 Caillavet St. . . . .	39533
<b>MISSOURI</b>	<b>KANSAS CITY</b>	
Automotive Equip. Service . . . . .	3117 Holmes St. . . . .	64109
	<b>ST. JOSEPH</b>	
Ross-Frazier Supply Co. . . . .	8th and Monterey . . . . .	64503
	<b>ST. LOUIS</b>	
Henzler, Inc. . . . .	2015 Lemay Ferry Rd. . . . .	63125
<b>NEW JERSEY</b>	<b>BELLMAWR</b>	
Lawnmower Parts Inc. . . . .	717 Creek Rd. . . . .	08030
<b>NEW MEXICO</b>	<b>ALBUQUERQUE</b>	
Spitzer Eng. & Parts . . . . .	1023 Third St. N.W. . . . .	87103
<b>NEW YORK</b>	<b>CARTHAGE</b>	
Gamble Dist., Inc. . . . .	West End Ave. . . . .	13619

## BRIGGS AND STRATTON, TECUMSEH AND PEERLESS PARTS AND SERVICE

Briggs & Stratton, Tecumseh and Peerless parts and service should be handled by your nearest authorized engine service firm. Check the yellow pages of your telephone directory under the listing **Engines—Gasoline**, Briggs & Stratton or Tecumseh Lauson.

<b>NORTH CAROLINA</b>	<b>GOLDSBORO</b>	
Smith Hardware Co. . . . .	515 N. George St. . . . .	27530
	<b>GREENSBORO</b>	
Dixie Sales Company . . . . .	335 N. Green . . . . .	27402
<b>OHIO</b>	<b>CARROLL</b>	
Stebe's Mid-State Mower Supply . . . . .	71 High St., Box 366 . . . . .	43112
	<b>CLEVELAND</b>	
Bleckrie, Inc. . . . .	7900 Lorain Ave. . . . .	44102
	<b>WADSWORTH</b>	
National Central . . . . .	687 Seville Rd. . . . .	44281
	<b>YOUNGSTOWN</b>	
Burton Supply Co. . . . .	1301 Logan Ave., Box 929 . . . . .	44501
<b>OKLAHOMA</b>	<b>MUSKOGEE</b>	
Victory Motors, Inc. . . . .	605 S. Cherokee . . . . .	74401
<b>OREGON</b>	<b>PORTLAND</b>	
Kenton Supply Co. . . . .	8216 N. Denver Ave. . . . .	97217
<b>PENNSYLVANIA</b>	<b>HARRISBURG</b>	
EECO Inc. . . . .	4021 N. 6th St. . . . .	17110
	<b>PHILADELPHIA</b>	
Thompson Rubber Co. . . . .	5222-24 N. Fifth St. . . . .	19120
	<b>PITTSBURGH</b>	
Bluemont Co. . . . .	11125 Frankstown Rd. . . . .	15235
	<b>PUNXSUTAWNEY</b>	
Frank Roberts & Sons . . . . .	R.D. 2 . . . . .	15767
<b>TENNESSEE</b>	<b>KNOXVILLE</b>	
Master Repair Service . . . . .	2000 Western Ave. . . . .	37921
	<b>MEMPHIS</b>	
American Sales & Service, Inc. . . . .	3035-43 Bellbrook . . . . .	381
<b>TEXAS</b>	<b>DALLAS</b>	
Marr Brothers, Inc. . . . .	423 E. Jefferson . . . . .	75203
	<b>FORT WORTH</b>	
Woodson Sales Corp. . . . .	1702 N. Sylvania . . . . .	76111
	<b>HOUSTON</b>	
Bullard Supply Co. . . . .	2409 Commerce St. . . . .	77003
<b>UTAH</b>	<b>SALT LAKE CITY</b>	
A-1 Engine & Mower Co. . . . .	437 E. 9th St. . . . .	84111
<b>VERMONT</b>	<b>BURLINGTON</b>	
Vermont Hdwe. Co. Inc. . . . .	180 Flynn Ave. . . . .	05401
<b>VIRGINIA</b>	<b>ASHLAND</b>	
RBI Corp. . . . .	Lake Ridge Park, 101 Cedar Run Dr. . . . .	23005
<b>WASHINGTON</b>	<b>SEATTLE</b>	
Bailey's Inc. . . . .	1414 14th Ave. . . . .	98102
<b>WEST VIRGINIA</b>	<b>CHARLESTON</b>	
Young's, Inc. . . . .	233 Virginia St., E. . . . .	25301
<b>WISCONSIN</b>	<b>MARSHFIELD</b>	
Power Pac . . . . .	301 E. 29th St. . . . .	54449

## WARRANTY PARTS AND SERVICE POLICY

The purpose of warranty is to protect the customer from defects in workmanship and materials, defects which are NOT detected at the time of manufacture. It does not provide for the unlimited and unrestricted replacement of parts. Use and maintenance are the responsibility of the customer. The manufacturer cannot assume responsibility for conditions over which it has no control. Simply put, if it's the manufacturer's fault, it's the manufacturer's responsibility; if it's the customer's fault, it's the customer's responsibility.

### CLAIMS AGAINST THE MANUFACTURER'S WARRANTY INCLUDES:

1. Replacement of Missing Parts on new equipment.
2. Replacement of Defective Parts within the warranty period.
3. Repair of Defects within the warranty period.

All claims MUST be substantiated with the following information:

1. Model Number of unit involved.
2. Date unit was purchased or first put into service.
3. Date of failure.
4. Nature of failure.

MTD PRODUCTS • P.O. BOX 36900 • CLEVELAND, OHIO 44136

## Free Manuals Download Website

<http://myh66.com>

<http://usermanuals.us>

<http://www.somanuals.com>

<http://www.4manuals.cc>

<http://www.manual-lib.com>

<http://www.404manual.com>

<http://www.luxmanual.com>

<http://aubethermostatmanual.com>

Golf course search by state

<http://golfingnear.com>

Email search by domain

<http://emailbydomain.com>

Auto manuals search

<http://auto.somanuals.com>

TV manuals search

<http://tv.somanuals.com>