

OWNER'S MANUAL

- ASSEMBLY
- OPERATION
- MAINTENANCE
- PARTS LIST

Model Nos.
247-640A
24640-7

Important:

**Read Safety Rules and
Instructions Carefully**

LOG SPLITTER

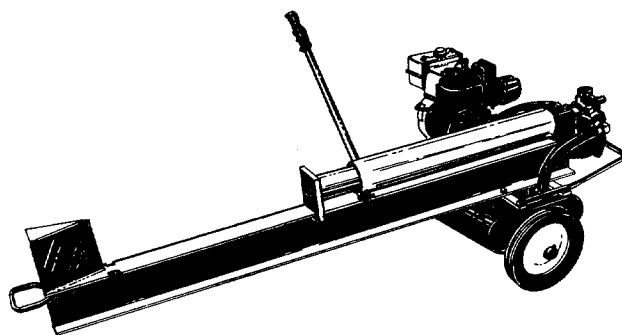

➔ IMPORTANT

It is suggested that this manual be read in its entirety before attempting to assemble or operate. Keep this manual in a safe place for future reference and for ordering replacement parts.

This unit is shipped WITHOUT GASOLINE or OIL. After assembly, see operating section of this manual for proper fuel and amount.

Your log splitter is a precision piece of power equipment, not a plaything. Therefore exercise extreme caution at all times.

SAFE OPERATION PRACTICES FOR LOG SPLITTERS

TRAINING

1. Know the controls and how to stop quickly--
READ THE OWNER'S MANUAL.
2. Do not allow children to operate. Do not allow adults to operate it without proper instruction. Only persons well acquainted with these rules of safe operation should be allowed to use your log splitter.
3. Open doors if engine is run in garage-- exhaust fumes are dangerous. Do not run engine indoors.
6. Always operate the log splitter from the engine side of the beam.

PREPARATION

1. Do not wear loose fitting clothing that could get caught on the moving parts.
2. Do not operate equipment when barefoot or wearing open sandals. Always wear substantial footwear.
3. Check the fuel before starting the engine. Do not fill the gasoline tank indoors, when the engine is running, or while the engine is still hot. Wipe off any spilled gasoline before starting the engine.
4. Use only in daylight or in good artificial light.
5. Never operate the equipment in the rain. Always be sure of your footing.

Stand behind the ram when operating. See drawings.

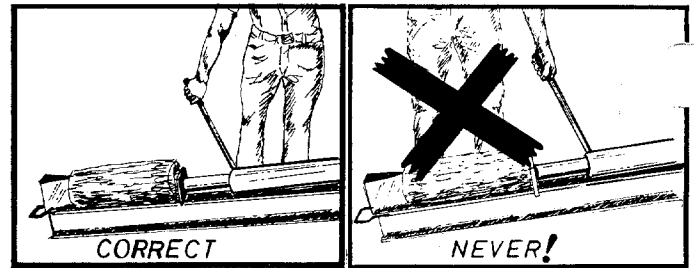

7. Be careful not to touch the muffler after the engine has been running, it is **HOT**.

OPERATION

1. Do not change the engine governor settings or overspeed the engine. Excessive engine speeds are dangerous.
2. Do not put hands or feet near rotating or moving parts.
3. If the equipment should start to vibrate abnormally, stop the engine and check immediately for the cause. Vibration is generally a warning of trouble.
4. When cleaning, repairing or inspecting, make certain all moving parts have stopped. Disconnect the spark plug wire, and keep the wire away from the plug to prevent accidental starting.
5. Handle gasoline with care--it is highly flammable.
 - A. Use approved gasoline container.
 - B. Never remove cap or add gasoline to a running or hot engine or fill fuel tank indoors. Wipe up spilled gasoline.

MAINTENANCE and STORAGE

1. Keep all nuts, bolts, screws, hose clamps and hydraulic fittings tight to be sure equipment is in safe working condition.
2. Never store the equipment with gasoline in the tank inside of a building where fumes may reach an open flame or spark. Allow the engine to cool before storing in any enclosure.
3. To reduce fire hazard keep engine free of grass, leaves, wood chips, excessive grease and oil.
4. Do not change the engine governor setting, overspeed the engine. Excessive engine speeds are dangerous.
5. Never store outside without a waterproof cover. Rain will cause rust on the inside of the cylinder.

ASSEMBLY INSTRUCTIONS

1. Remove the log splitter, parts pack all all literature from the crate before discarding crate.
2. Block up rear end of log splitter so that the rear wheels may be assembled.
3. Place flat washers (A) on axle, then wheels and secure with collars and set screws (B). See figures 1 and 2.

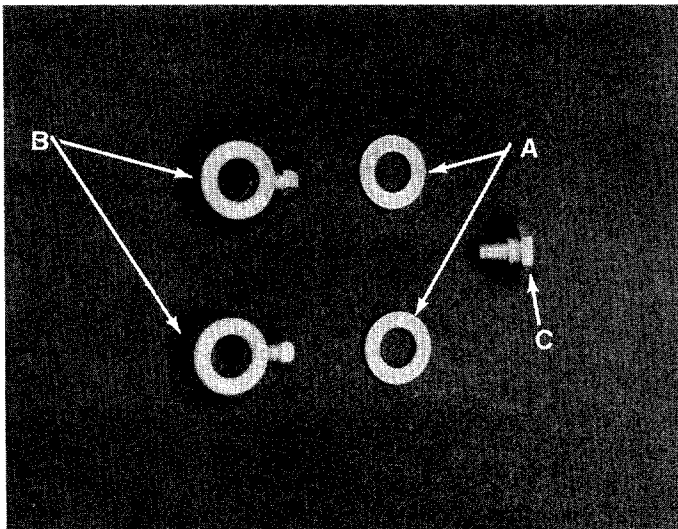

FIGURE 1



FIGURE 2

4. The engagement handle is partly assembled, pivot handle upward into position and secure with shoulder bolt (C). See figure 3.

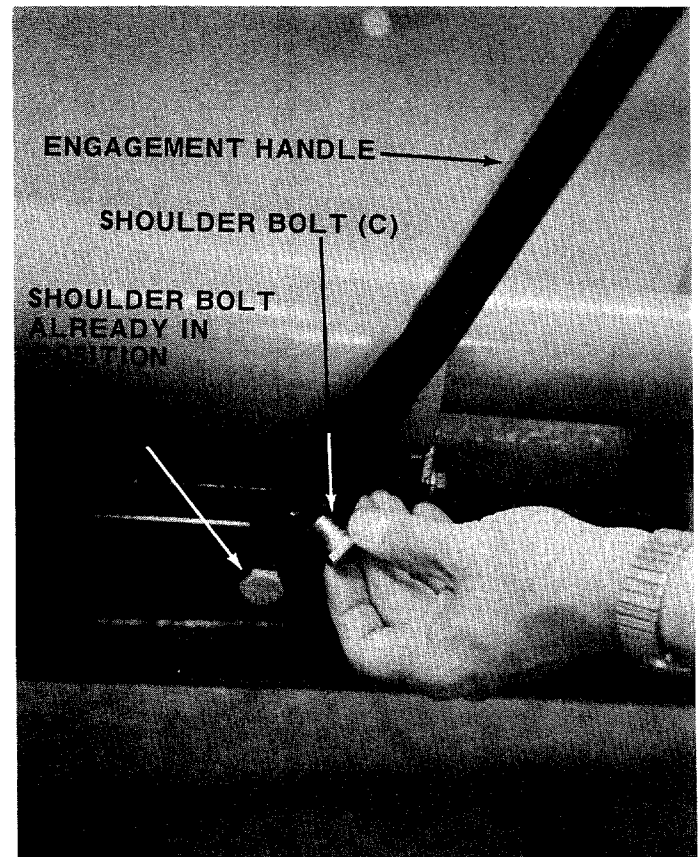

FIGURE 3

5. Tighten both shoulder bolts securely.

OPERATION

1. Service engine with gas and oil. See engine manual packed with log splitter for complete instructions for the care and maintenance of engine. READ DIRECTIONS CAREFULLY.



You must not operate log splitter without proper amount of oil in reservoir tank.

2. Remove the breather cap from reservoir tank. See figure 4.

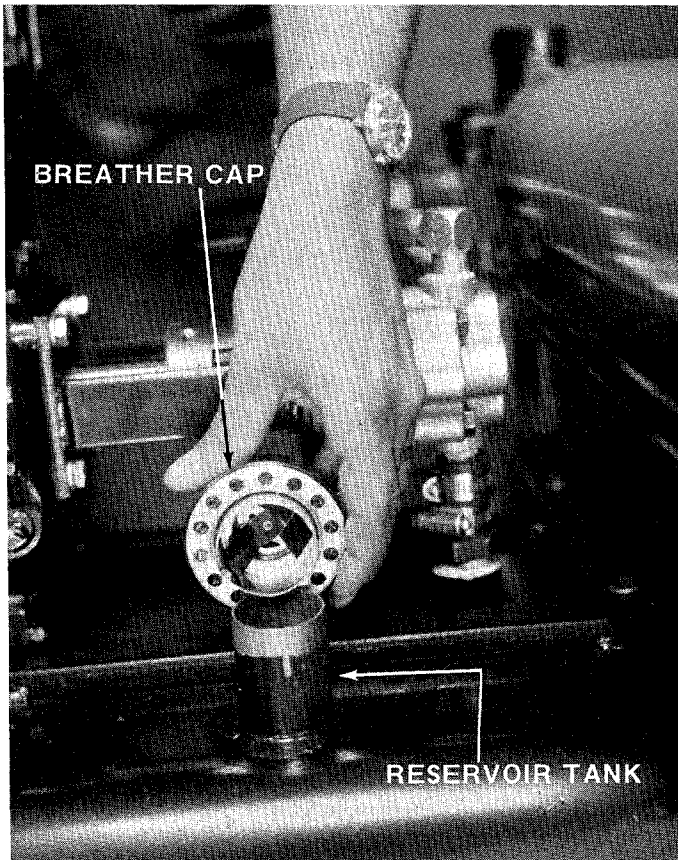

FIGURE 4

3. The hydraulic system takes 4-1/2 gallons of 10W 30 HD only detergent oil. Fill the reservoir tank to the bottom of the fill tube.



You can not get all the oil in the system until after the engine is run. Replace the breather cap.

BEFORE STARTING

During initial break-in period, oil level should be watched closely. See ENGINE MAINTENANCE.

Use MS classification oil. Do not use oils marked only MM or ML or unmarked.

Above 32° use SAE 30; below 32° use SAE 10W. These recommendations must be followed for best performance and long life.

Change oil first two (2) hours of operation and check oil level every five (5) operating hours or each time equipment is used.

Change oil every twenty-five (25) operating hours or sooner if equipment is operated in extremely dusty or dirty conditions.



Carburetors are preset at the factory. DO NOT attempt to make adjustments at this time. See carburetor instructions outlined under CARBURETOR ADJUSTMENT.

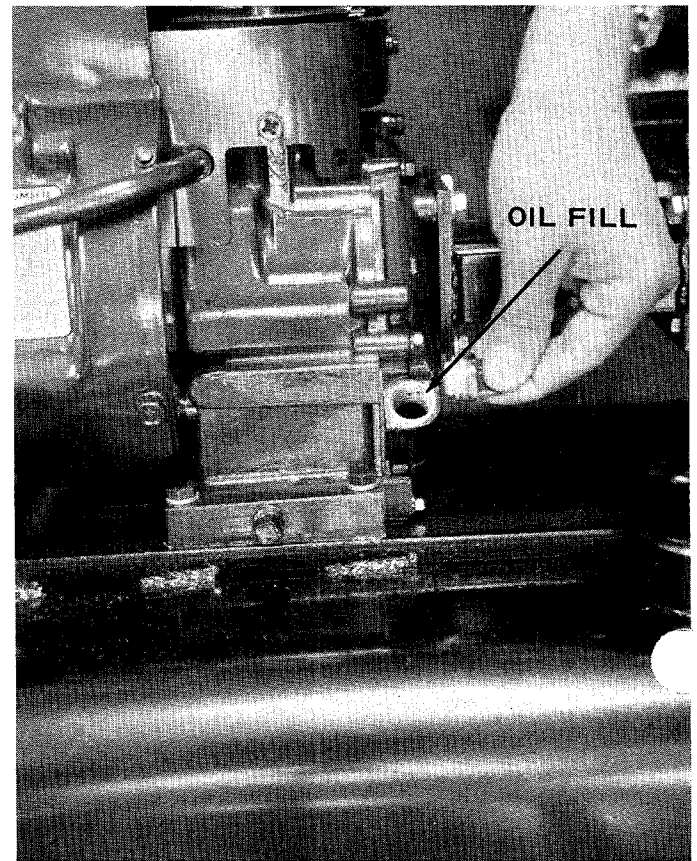

FIGURE 5

TO START ENGINE

1. Place control lever (on engine) in run position. See figure 6.
2. Move choke lever to CHOKE position. See figure 7.
3. Rewind starter—use quick full arm stroke. Keep firm grip on handle and return rope slowly.

TO STOP ENGINE

1. Move control lever to STOP position. See figure 6.
2. Remove high tension wire from spark plug to prevent accidental starting by children while equipment is unattended.

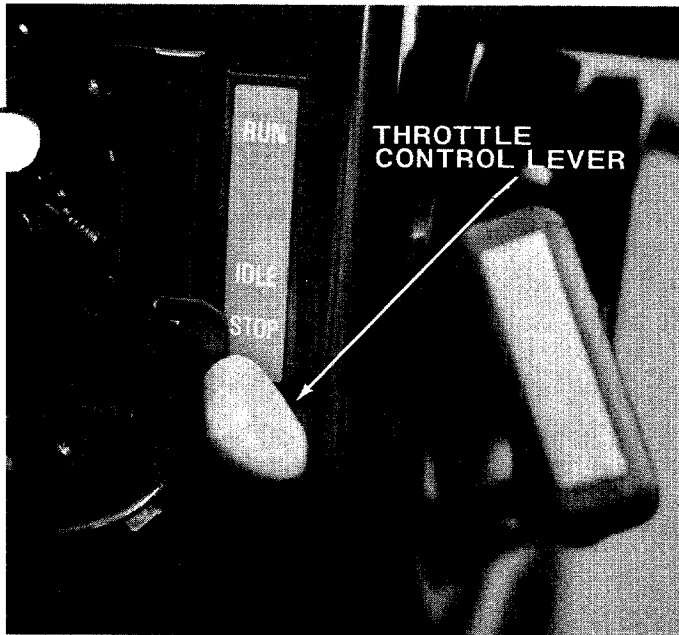

FIGURE 6

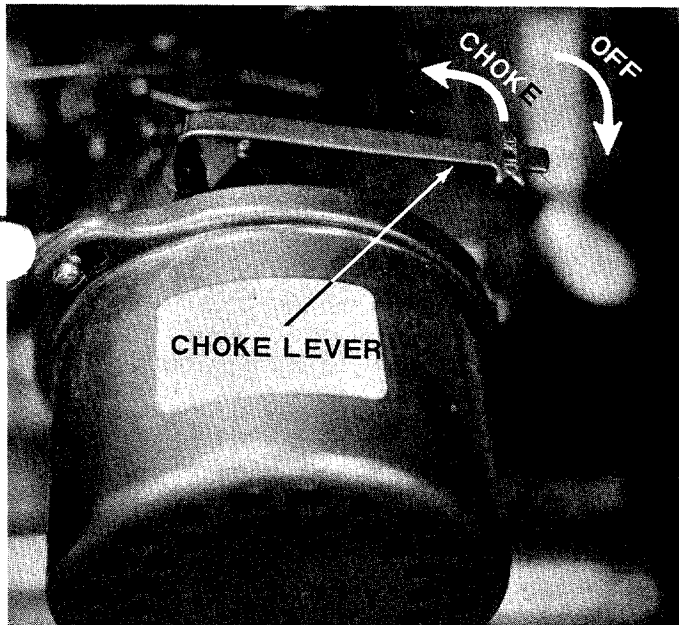

FIGURE 7

NOTE

After engine has been serviced, finish filling oil reservoir. Start engine and operate engagement handle so the ram makes two complete strokes.

CAUTION

This is to purge the hydraulic system of air. Continued operation will cause permanent damage to pump and cylinder. Stop engine and finish filling reservoir tank. It will take about 3 quarts of oil. See figure 4.

USING YOUR LOG SPLITTER

Your log splitter is designed for safe, efficient, operation. CARE, OF COURSE, MUST BE EXERCISED THAT HANDS ARE KEPT AWAY FROM ALL MOVING PARTS.

- A. Set throttle at maximum speed.
- B. Engagement handle has three positions: Forward - moves ram towards wedge. Neutral - ram stops in place. Reverse - ram returns. See figure 8.

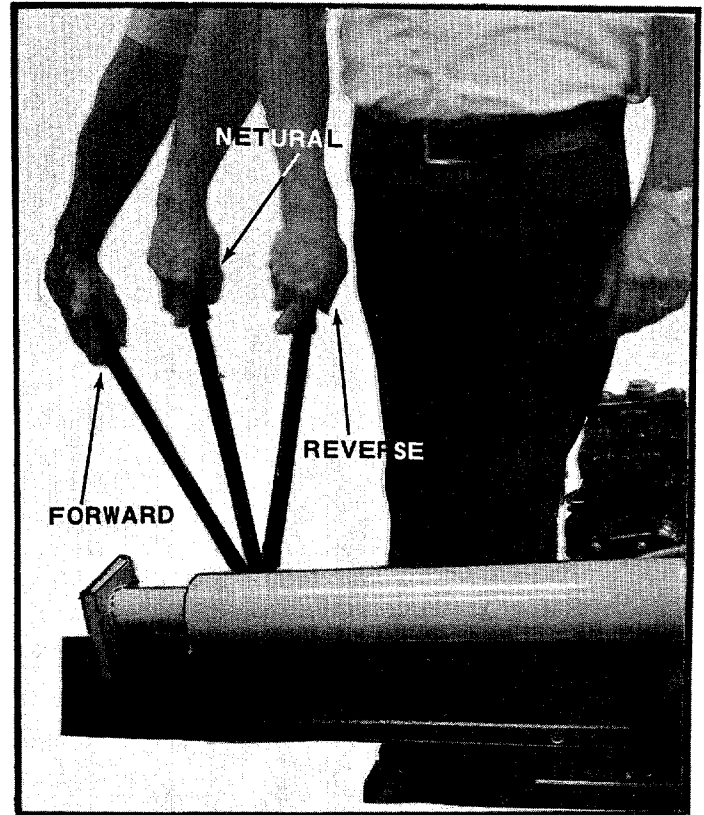

FIGURE 8

- C. Maximum length that can be split is 23''
- D. Place log on beam and hold in place with right hand. See figure 9.

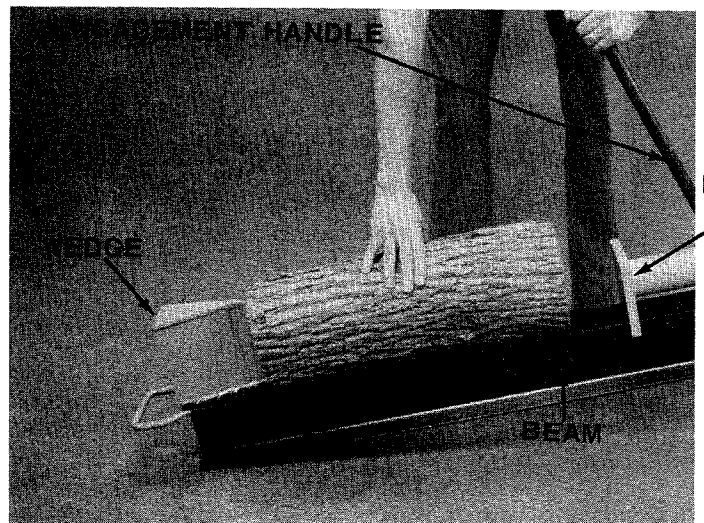

FIGURE 9

- E. Slowly move engagement handle forward until ram rests against log. Release engagement handle (Neutral).
- F. Remove your hand from the log and step behind the ram. See figure 10.

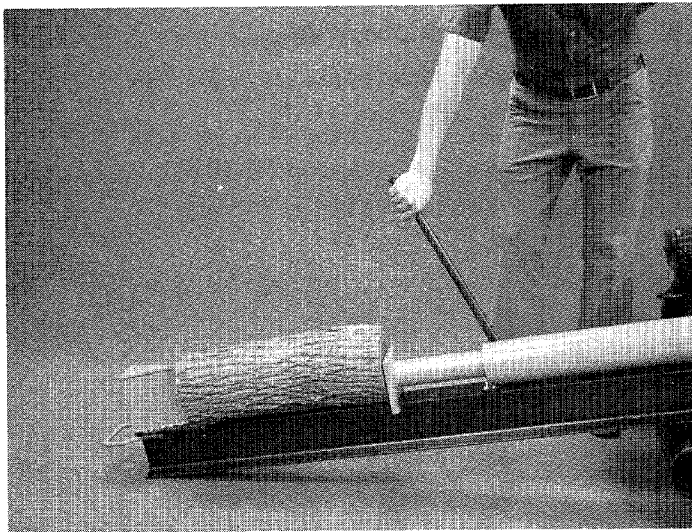

FIGURE 10

- G. Move engagement handle forward until log splits.



NOTE

If you attempt to run the ram beyond its normal stroke it will automatically return the engagement handle to neutral.

- H. Move the engagement handle to the rear to return ram.



DANGER

Never attempt to cut a log in half with the log splitter. See figure 11.

Never stand next to the ram when operating. See figure 12. Always stand behind the ram.

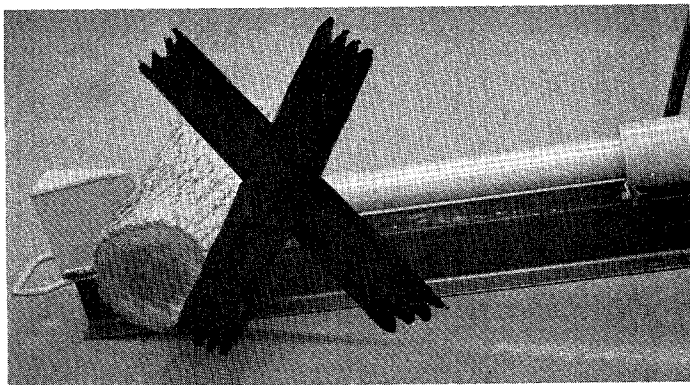

FIGURE 11

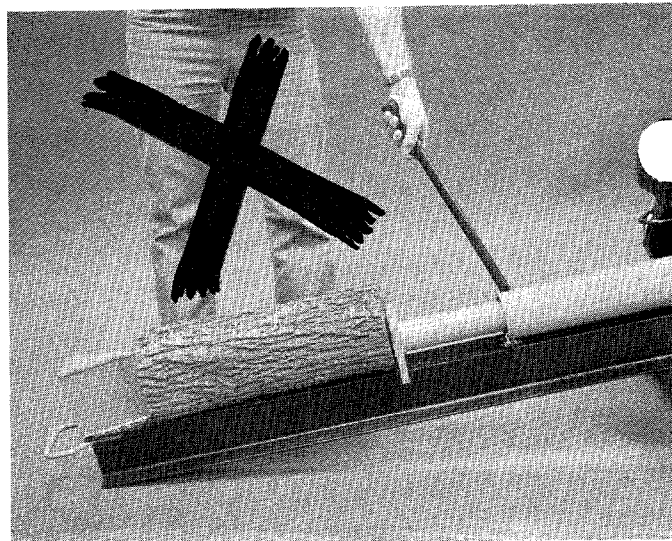

FIGURE 12

MAINTENANCE



WARNING

If ram takes longer than 30 seconds to complete full forward cycle, check strainer tube assembly.



CAUTION

Always stop engine and disconnect spark plug wire before doing any maintenance.

RAM OPERATION

If the ram does not move smoothly, run the ram its full stroke several times to clear out air in the system. If this does not correct the problem see strainer tube assembly paragraph. (Page 7).

RETURN COLLAR

Adjust the return collar so it is 2 inches from the front edge of the wedge. See figure 13.

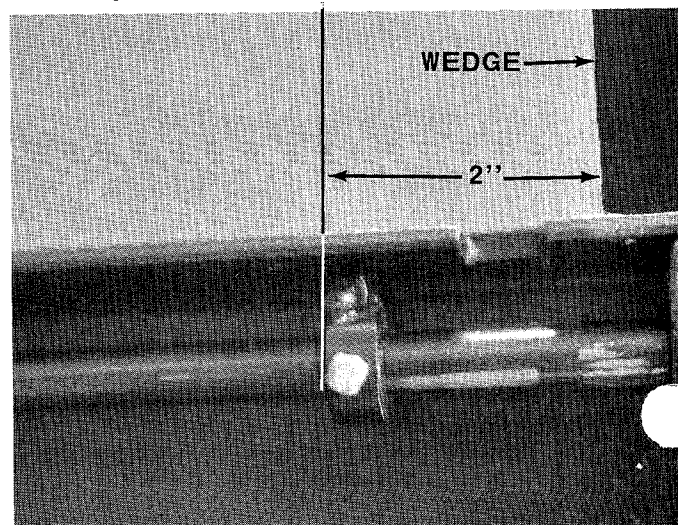

FIGURE 13

HOSE CLAMPS

Check the hose clamps on the bottom of the pump for proper tightness before each use. See figure 14.

Hose clamps on the return hose should be checked once a season. See figure 15.

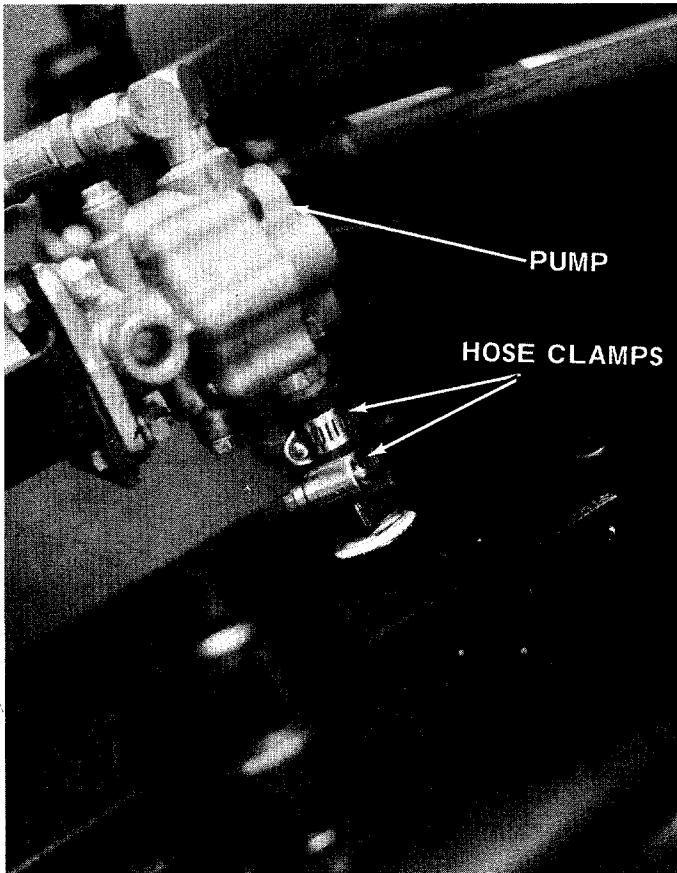

FIGURE 14

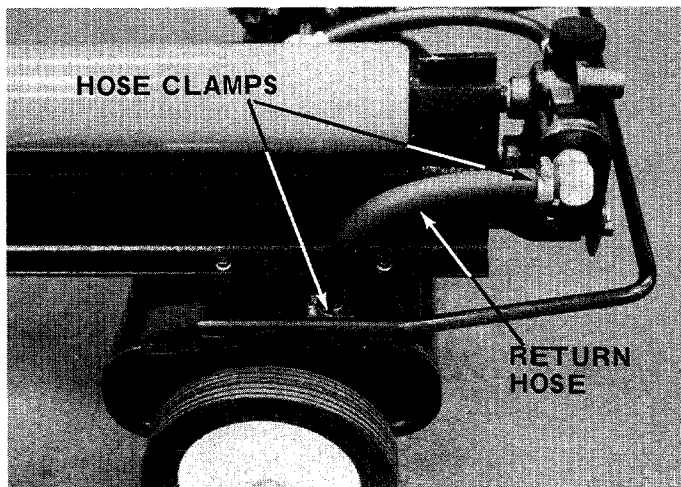

FIGURE 15

OIL RESERVOIR

It is important to keep the oil clean in the reservoir tank. Replace with 4-1/2 gallons of 10W 30 HD only detergent oil if contaminated (e.g. water in tank).

BREATHER CAP

Clean breather cap when dirty. See figure 4.

- A. Wash breather in detergent and water.
- B. Air dry.
- C. Lubricate with one tablespoon of 10W 30 oil.

STRAINER TUBE ASSEMBLY

If the ram does not move back and forth smoothly the strainer tube assembly may be clogged.

To clean follow these steps.

- A. Remove your engine bolts and lockwashers. See figure 16.

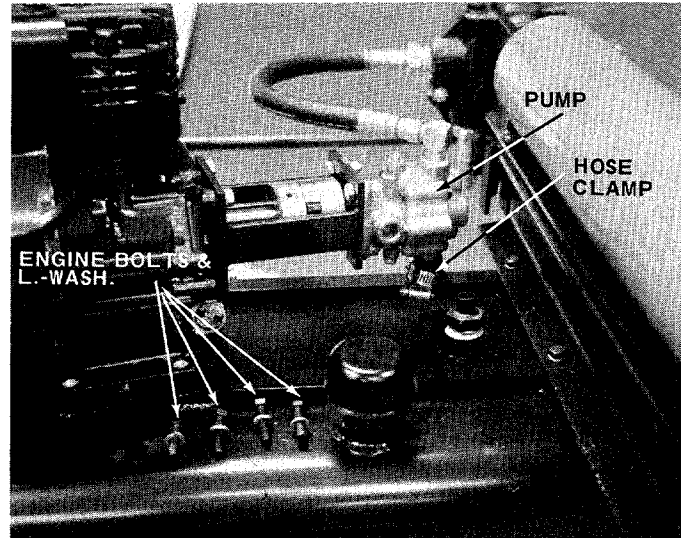

FIGURE 16

- B. Loosen hose clamps (either one) on the bottom of the pump.
- C. Lift engine and pump assembly and rotate to one side. See figure 16.
- D. With a wrench, remove strainer tube assembly. See figure 17.

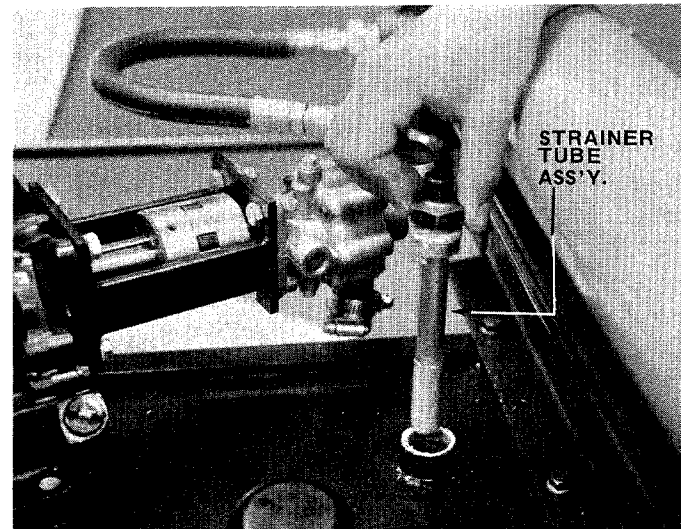

FIGURE 17

- E. Clean and reassemble using a hydraulic sealant on the threads.

ENGINE MAINTENANCE

To obtain long life and trouble-free service from your engine, certain normal maintenance must be performed as outlined below:

1. Change oil in crankcase after first two (2) hours of operation. Then, follow instructions outlined on page 4.

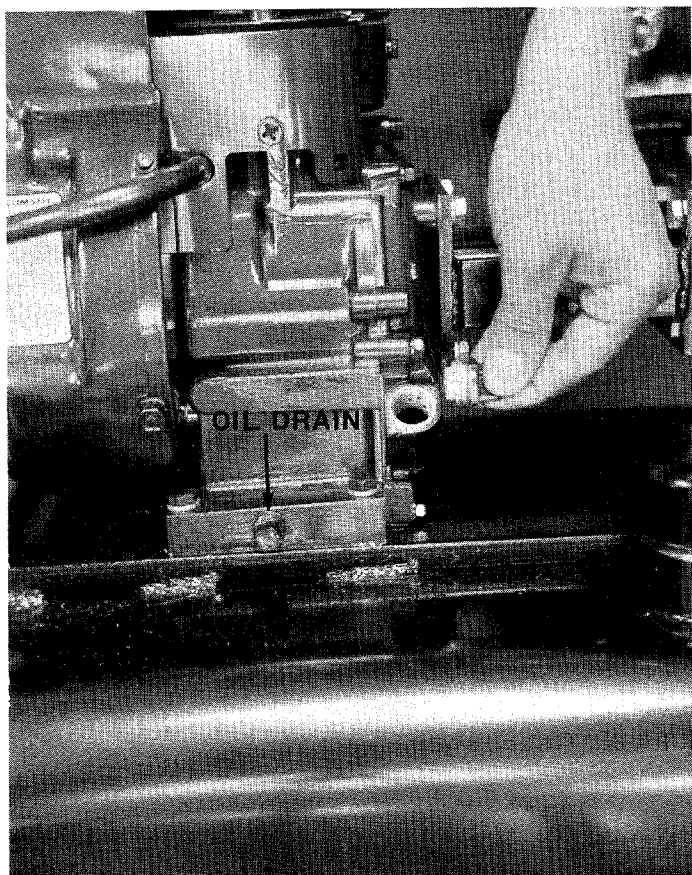

FIGURE 18



CAUTION

Disconnect high tension wire at spark plug to prevent accidental starting of engine. Unscrew oil drain plug located on side at bottom of engine. See figure 18.



NOTE

Always tip engine towards oil drain hole. Be sure oil drains completely.

Replace oil drain plug and refill with oil as directed on page 4 or engine nameplate.

2. Check oil every five (5) operating hours or each time equipment is used.

3. Cleaning engine—This is an aircooled engine which operates most efficiently when the cooling fins are clean.

Clean cylinder fins and underside of tank or housing thoroughly of all accumulated grass and debris

4. Air Cleaner. (See figure 19).

- a. Paper Type Element. Remove every 10 hours or oftener if under dusty conditions. Tap to remove loose dirt and/or blow from inside out with low pressure air. Replace if torn or perforated or when plugged to maintain proper carburetor setting (50 hours). DO NOT WASH IN ANY LIQUID AND DO NOT OIL.

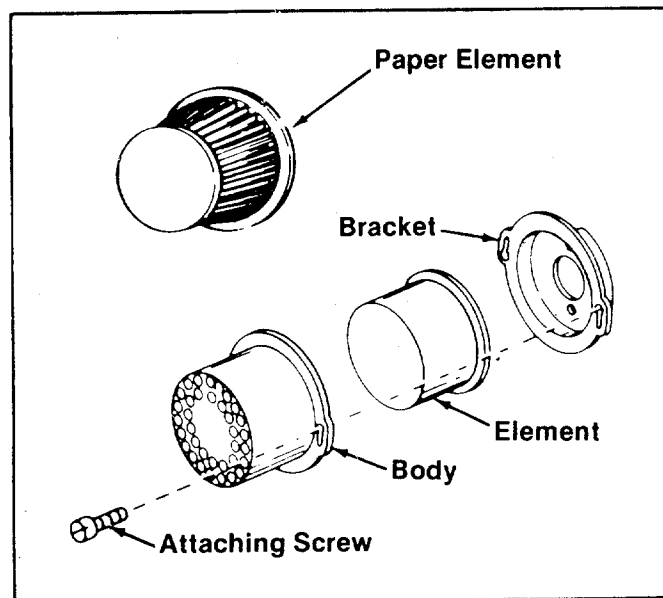

FIGURE 19

CARBURETOR ADJUSTMENTS (See figure 20)

Do not make unnecessary adjustment. Factory settings are correct for most application. If adjustments are needed, proceed as follows:

1. Close power adjusting needle (figure 20) by turning to right (clockwise). Close finger tight only. Forcing will cause damage.
2. Open one turn (counterclockwise).
3. Close idle adjusting needle (figure 20) by turning to right (clockwise). Close finger tight only. Forcing will cause damage.
4. Open one and one-half (1 1/2) turns (counterclockwise).
5. Start engine. Follow starting instructions page 4.
6. With throttle open (carburetor control at RUN FAST position) adjust power adjusting needle one-eighth (1/8) turn at a time forward or backward until engine runs smoothly. If engine tends to stall under load enrich mixture slightly (counterclockwise).

7. Hold throttle lever closed or move carburetor control to IDLE or SLOW position and adjust idle adjusting needle until engine runs smoothly proceeding in step six (6) above.

Allow several seconds between each adjustment when performing either step six (6) or seven (7) to allow engine to react to new setting.

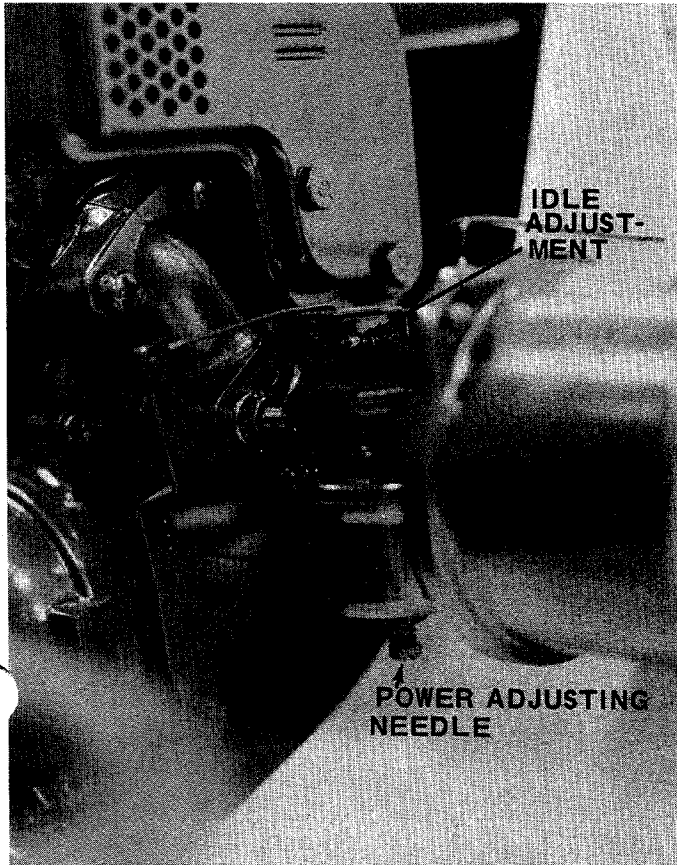

FIGURE 20

STORAGE INSTRUCTIONS

In event engine is to be stored for any length of time (30 days or more), prepare as follows:

1. Drain gasoline by tipping or by syphon hose, then run engine until remainder is used and tank and carburetor are empty.



CAUTION

Drain into container outdoors away from fire or flame.

2. Drain carburetor by running engine until it stops.
3. Inside protection of engine for storage is performed by removing spark plug and pouring one ounce of SAE 30 oil through spark plug hole into cylinder. Crank engine, without starting, several times to spread oil over cylinder walls.
4. Never store outside without a waterproof cover.

247-640A 24640-7

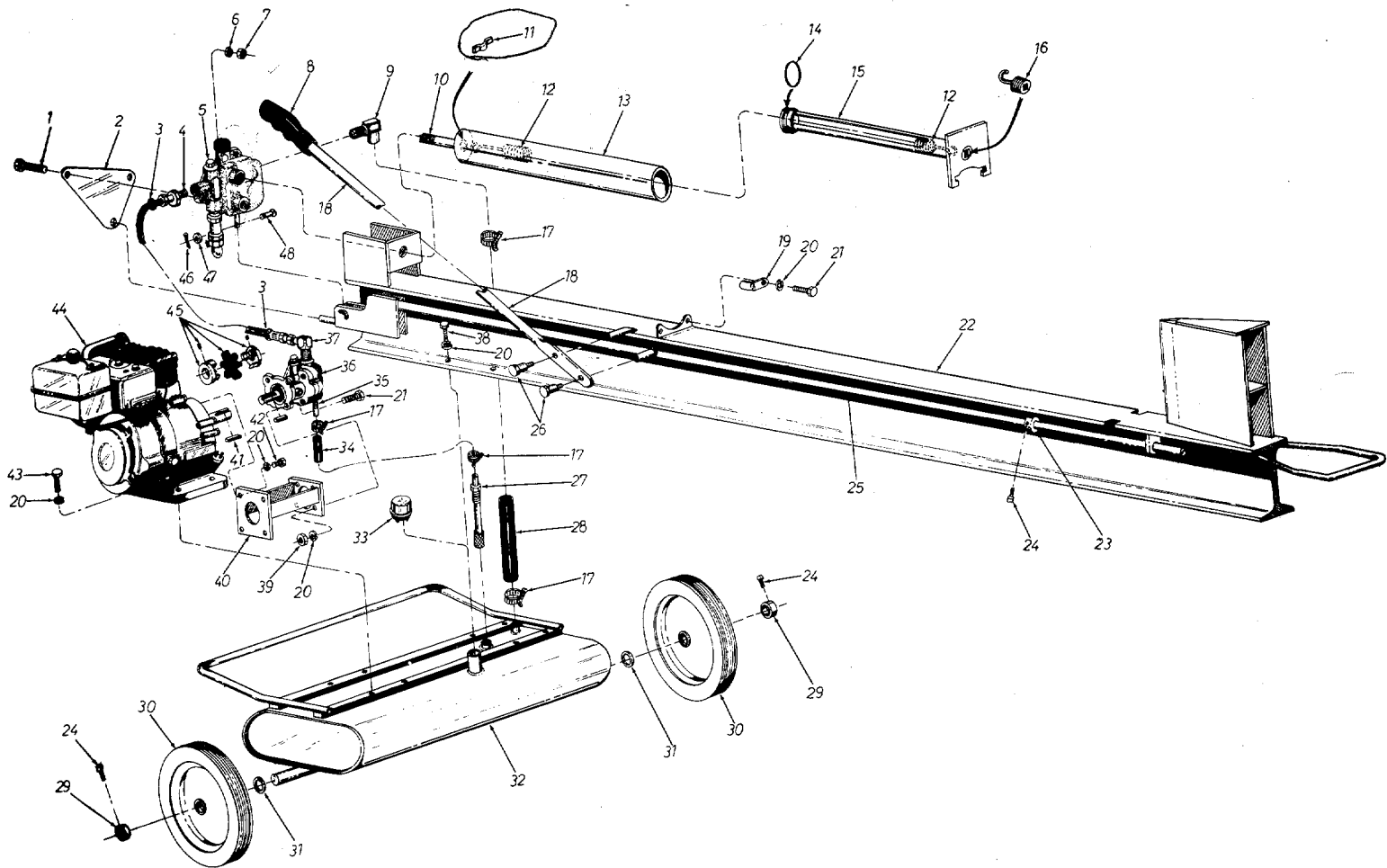

PARTS LIST FOR LOG SPLITTER MODELS 247-640A and 24640-7

Ref. No.	Part No.	Color Code	Description	New Part	Ref. No.	Part No.	Color Code	Description	New Part
1	710-0331		Hex Scr. 3/8-24 x 2.25" Lg.*		25	13291		Engagement Lever Ass'y.	N
2	13275		Cam Plate	N	26	738-0258		Shoulder Scr. 3/8-16 Thd.	
3	727-0203		High Pressure Hose Ass'y. 11.0" Lg.	N	27	13280		Strainer Tube Ass'y.	N
					28	727-0204		Return Hose	N
4	737-0155		Reducing Bushing	N	29	711-0169		Collar	
5	717-0364		Valve	N	30	734-0584		Wheel Ass'y. Comp.	
6	736-0119		L-Wash. 3/8" Scr.*		31	736-0237		Fl.-Wash. .656 I.D. x 1.00 Thd.	
7	712-0241		Hex Nut 3/8-24 Thd.*		32	13276		Tank Ass'y. Complete	N
8	08118		Grip		33	751-0224		Breather Cap	N
9	737-0153		Return Elbow	N	34	727-0205		Inlet Hose	N
10	737-0154		Cylinder nipple .75" x 4.5" Lg.	N	35	737-0151		Inlet Nipple	N
11	732-0342		Spring Clip	N	36	717-0363		Pump - Complete (WEBSTER)	N
12	732-0341		Cylinder Return Spring	N	37	737-0152		High Pressure Elbow	N
13	13304		Cylinder Ass'y.	N	38	710-0376		Hex Scr. 5/16-18 x 1.00" Lg.*	
14	721-0159		"O"-Ring	N	39	712-0267		Hex Nut 5/16-18 Thd.*	
15	13302		Push Cylinder Ass'y.	N	40	13295		Coupling Support Brkt. Ass'y.	N
16	13314		Spring Hook Ass'y.	N	41	714-0114		Sq. Key 1/4" x 2.00" Lg.*	
7	726-0173		Hose Clamp	N	42	710-0237		Hex Scr. 5/16-24 x .62" Lg.*	
18	749-0251		Engagement Handle	N	43	710-0528		Hex Scr. 5/16-18 x 1.25" Lg.*	
19	13310		Cylinder Holding Plate	N	44	-----		Engine	
20	736-0119		L-Wash. 5/16" Scr.*		45	717-0374		Flexible Coupling Comp.	N
21	710-0528		Hex Scr. 5/16-18 x 1.25" Lg.		46	714-0507		Cotter Pin 3/32" Dia. x .75" Lg.*	
22	13305		"I"-Beam Ass'y. Comp.	N	47	736-0142		Fl.-Wash. .28 I.D. x .50" O.D.	
23	13312		Return Collar Ass'y.	N	48	711-0660		Clevis Pin	N
24	710-0494		Sq. Hd. Set Scr. 5/16-18 x .38" Lg.						

*For faster service obtain standard nuts, bolts and washers locally. If these items cannot be obtained locally, order by part number and size as shown on parts list.

The engine is not under warranty by the log splitter manufacturer. If repairs or service is needed on the engine, please contact your nearest authorized engine service outlet. Check the "Yellow Pages" of your telephone book under "Engines - Gasoline."



PARTS INFORMATION

POWER EQUIPMENT PARTS AND SERVICE

Parts and service for all MTD manufactured power equipment are available through the authorized service firms listed below. All orders should specify the model number of your unit, parts numbers, description of parts and the quantity of each part required.

ALABAMA	BIRMINGHAM	Auto Electric & Carburetor Co. 2625 4th Ave. S. 35233
ARKANSAS	NORTH LITTLE ROCK	Sutton's Lawn Mower Shop Rt. 4, Box 368 72117
	FORT SMITH	Mity Mite Motors, Inc. 2515 Towson Ave. 72901
CALIFORNIA	SAN BERNARDINO	Lawn Mower Supply Co. 25608 E. Baseline 92410
	SAN FRANCISCO	J.W. Jewett Co. 981 Folsom St. 94107
	SACRAMENTO	Luttig & Severson 2030 28th St. 95818
COLORADO	DENVER	South Denver Lawn Equip. 527 West Evans 80223
CONNECTICUT	SUFFIELD	The Jones & Ramsey Co. 850 Thompsonville Rd. 06078
FLORIDA	JACKSONVILLE	Radco Distributors 2403 Market St. 32206
	CORAL GABLES	Moz-All of Florida, Inc. 365 Greco Ave. 33146
GEORGIA	EAST POINT	East Point Cycle & Key 2834 Church St. 30344
ILLINOIS	LYONS	Keen Edge Co. 8615 Ogden Ave. 60534
INDIANA	ELKHART	Parts & Sales Inc. 2101 Industrial Pkwy. 46514
IOWA	DUBUQUE	Power Lawn & Garden Equip. 2551 J.F. Kennedy 52001
KANSAS	WICHITA	Hixon, Inc. 3030 Mascot 67204
LOUISIANA	NEW ORLEANS	Suhren Engine Co. 8330 Earhart Blvd. 70118
MARYLAND	TAKOMA PARK	Center Supply Co. 6867 New Hampshire Ave. 20012
MASSACHUSETTS	SPRINGFIELD	Morton B. Collins Co. 300 Birnie Ave. 01107
MICHIGAN	MOUNT CLEMENS	Power Equipment Dist. 36463 South Graftiot... 48043
	LANSING	Lorenz Service Co. 2500 S. Pennsylvania... 48900
MINNESOTA	MINNETONKA	Hance Distributing Inc. 11212 Wayzata Blvd. 55343
MISSISSIPPI	BILOXI	Biloxi Sales & Service, Inc. 506 Caillavet St. 39533
MISSOURI	KANSAS CITY	Automotive Equip. Service 3117 Holmes St. 64109
	ST. LOUIS	Henzler, Inc. 2015 Lemoy Ferry Rd. 63125
NEW YORK	CARTHAGE	Gamble Dist., Inc. West End Ave. 13619
	SYRACUSE	Kimber's, Inc. 115 N. Geddes St. 13204

BRIGGS & STRATTON, TECUMSEH AND PEERLESS PARTS AND SERVICE

Briggs & Stratton, Tecumseh and Peerless parts service should be handled by your nearest authorized engine service firm. Check the yellow pages of your telephone directory under the listing *Engines Gasoline*, Briggs & Stratton or Tecumseh Lauson

NORTH CAROLINA	GREENSBORO	Dixie Sales Company 327 Battleground Ave.. 27402
	GOLDSBORO	Smith Hardware Co. 515 N. George St. 27530
OHIO	WADSWORTH	National Central 687 Seville Rd. 44281
	CLEVELAND	Bleckrie, Inc. 7900 Lorain Ave. 44102
	CARROLL	Stebe's Mid-State Mower Supply Box 366 43112
	WILLARD	Sunshine Wholesale Tire Outlet Route 224 44890
	MANSFIELD	McClure Lawn & Garden Supply...1114 Lexington Ave. . 44903
OKLAHOMA	MUSKOGEE	Victory Motors, Inc. 605 S. Cherokee 74401
	ADA	Ada Auto Supply 301 E. 12th St. 74820
OREGON	PORTLAND	Kenton Supply Co. 8216 N. Denver Ave. . 97217
PENNSYLVANIA	LANCASTER	Raub Supply Co. James & Mulberry Sts...17604
	PITTSBURGH	Bluemont Co. 11125 Frankstown Rd.. 15235
TENNESSEE	KNOXVILLE	Master Repair Service 2423 Broadway, N.E. ... 37917
	MEMPHIS	Memphis Cycle & Supply Co. 421 Monroe Ave. 381
	MEMPHIS	American Sales & Service, Inc. . 1922 Lynnbrook 38110
TEXAS	DALLAS	Marr Brothers, Inc. 423 E. Jefferson 75203
	HOUSTON	Bullard Supply Co. 2409 Commerce St. 77003
	SAN ANTONIO	Catto & Putty, Inc. P.O. Box 2408 78206
	FORT WORTH	Woodson Sales Corp. 1702 N. Sylvania 76111
UTAH	SALT LAKE CITY	A-1 Engine & Mower Co. 437 E. 9th St. 84111
VERMONT	BURLINGTON	Vermont Appliance Co. 44 Lakeside Ave. 05401
VIRGINIA	RICHMOND	RBI Corp. 963 Myers St. 23260
WASHINGTON	SEATTLE	Bailey's Rebuild, Inc. 1325 E. Madison St. ... 98102
WEST VIRGINIA	CHARLESTON	Young's, Inc. 233 Virginia St., E. ... 25301
WISCONSIN	APPLETON	Automotive Supply Co. 123 S. Linwood Ave. ... 54911

WARRANTY PARTS AND SERVICE POLICY

The purpose of warranty is to protect the customer from defects in workmanship and materials, defects which are NOT detected at the time of manufacture. It does not provide for the unlimited and unrestricted replacement of parts. Use and maintenance are the responsibility of the customer. The manufacturer cannot assume responsibility for conditions over which it has no control. Simply put, if it's the manufacturer's fault, it's the manufacturer's responsibility; if it's the customer's fault, it's the customer's responsibility.

CLAIMS AGAINST THE MANUFACTURER'S WARRANTY INCLUDES

- 1. Replacement of Missing Parts on new equipment.
- 2. Replacement of Defective Parts within the warranty period.
- 3. Pair of Defects within the warranty period.

All claims MUST be substantiated with the following information:

- 1. Model Number of unit involved.
- 2. Date unit was purchased or first put into service.
- 3. Date of failure.
- 4. Nature of failure.

Free Manuals Download Website

<http://myh66.com>

<http://usermanuals.us>

<http://www.somanuals.com>

<http://www.4manuals.cc>

<http://www.manual-lib.com>

<http://www.404manual.com>

<http://www.luxmanual.com>

<http://aubethermostatmanual.com>

Golf course search by state

<http://golfingnear.com>

Email search by domain

<http://emailbydomain.com>

Auto manuals search

<http://auto.somanuals.com>

TV manuals search

<http://tv.somanuals.com>