

# OWNER'S MANUAL

## POWER VACUUMS

### Model Numbers

- 242-675A**
- 242-685A**
- 24677A**
- 24687A**

**Important:**  
**Read Safety Rules and**  
**Instructions Carefully**

Thank you for purchasing an  
 American built product.

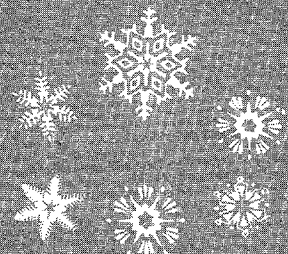
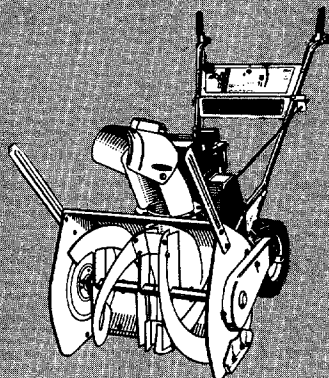
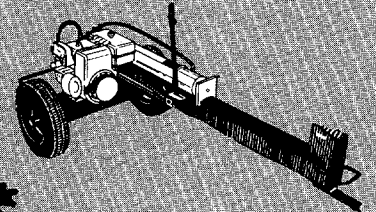
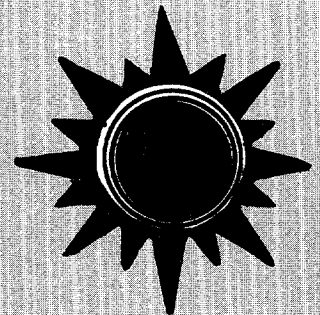
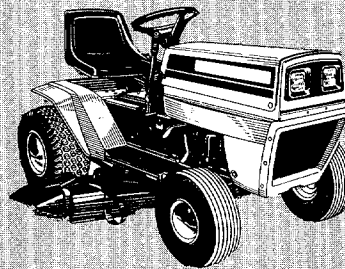
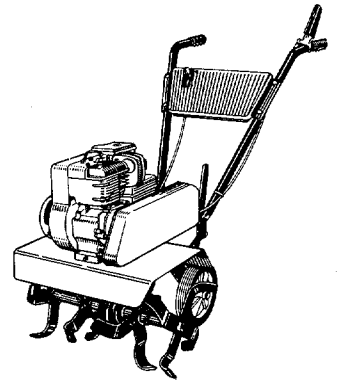

# INDEX

Safe Operation Practices .....	3	Off-Season Storage .....	1
Assembly Instructions .....	4	Illustrated Parts .....	12, 15
Operation .....	8	Replacement Parts List .....	13, 15
Maintenance .....	9	Parts Information .....	Back Cover

## LIMITED WARRANTY

For one year from the date of original retail purchase, MTD PRODUCTS INC will either repair or replace, at its option, free of charge, F.O.B. factory or authorized service firm, any part or parts found to be defective in material or workmanship. Transportation charges for the movement of any power equipment unit or attachment are the responsibility of the purchaser. Transportation charges for any parts submitted for replacement under this warranty must be paid by the purchaser unless such return is requested by MTD PRODUCTS INC.

This warranty will not apply to any part which has become inoperative due to misuse, excessive use, accident, neglect, improper maintenance, alterations, or unless the unit has been operated and maintained in accordance with the instructions furnished. This warranty does not apply to the engine, motor, battery, battery charger or component parts thereof. Please refer to the applicable manufacturer's warranty on these items.

This warranty will not apply where the unit has been used commercially.

Warranty service is available through your local authorized service dealer or distributor. If you do not know the dealer or distributor in your area, please write to the Customer Service Department of MTD.

The return of a complete unit will not be accepted by the factory unless prior written permission has been extended by MTD.

This warranty gives you specific legal rights. You may also have other rights which vary from state to state.



### TO PURCHASERS OF INTERNAL COMBUSTION ENGINE EQUIPPED MACHINERY OR DEVICES IN THE STATE OF CALIFORNIA

The equipment which you have just purchased does not have a spark arrester. If this equipment is used on any forest covered land, brush covered land, or grass covered unimproved land in the State of California, before using on such land, the California law requires that a spark arrester be provided. In addition, spark arrester is required by law to be in effective working order. The spark arrester must be attached to the exhaust system and comply with Section 4442 of the California Public Resources Code.

# **IMPORTANT**

It is suggested that this manual be read in its entirety before attempting to assemble or operate. Keep this manual in a safe place for future reference and for ordering replacement parts.

This unit is shipped **WITHOUT GASOLINE or OIL**. After assembly, see operating section of this manual for proper fuel and amount.

## **SAFE OPERATION PRACTICES FOR POWER VACUUMS**

1. Read this operating and service instructing manual carefully. Be thoroughly familiar with the controls and proper use of the power vacuum.
2. Never allow children to operate this power vacuum.
3. Keep the area of operation clear of all persons, particularly small children and pets.
4. Check fuel before starting engine. Do not fill fuel tank indoors, when engine is running, or while engine is hot. Wipe off any spilled fuel before starting engine.
5. Do not change engine governor settings.
6. Do not put hands near rotating parts for any reason.
7. If the power vacuum should start to vibrate abnormally, stop the engine and check immediately for the cause. Vibration is generally a warning of trouble.
8. Before cleaning, repairing or inspecting, make certain all moving parts have come to a complete stop. Disconnect spark plug wire and keep wire away from plug to prevent accidental starting. Also keep throttle control lever in the stop position.
9. If the power vacuum should become blocked with debris at any point, shut engine off and wait until the impeller comes to a complete stop before attempting to remove the obstruction. Disconnect spark plug wire to prevent accidental starting.
10. Check all bolts for tightness at frequent periods.
11. Never store this power vacuum with fuel in the tank. Allow engine to cool before storing in any enclosure.
12. Keep bag and equipment free of debris when not in use.
13. Never operate this power vacuum unless air duct and vacuum bag are properly affixed in their place. Large zippered end of bag must be closed when operating to prevent objects from being blown out.
14. Never empty vacuum bag when engine is running.
15. Never change inlet nozzle or auxiliary hose attachment when engine is running.
16. The manufacturer recommends that the operator wear safety glasses or some other suitable eye protection when operating this machine.
17. Check the vacuum bag frequently for wear and replace when necessary.
18. Never operate as a leaf blower unless impeller guard and guard assembly are properly affixed in their place.
19. Exercise caution whenever operating as a leaf blower. Do Not allow discharge to be pointed in the direction of persons.

# ASSEMBLY INSTRUCTIONS

## CONTENTS OF HARDWARE PACK (See Figure 1.)

- A (1) Clutch Grip Assembly\*
- B (1) Hair Pin Cotter\*
- C (1) Clevis Pin\*
- D (1) Extension Spring\*
- E (1) Lock Nut 1/4-20 Thread\*
- F (3) Hand Knobs
- G (3) Belleville Washers
- H (1) Heavy Flat Washer
- I (4) Hex Bolts 1/4-20 x 1.75" Long
- J (4) Hex Lock Nuts 1/4-20 Thread
- K (2) Stud Pins
- L (2) Push-on Speed Nuts

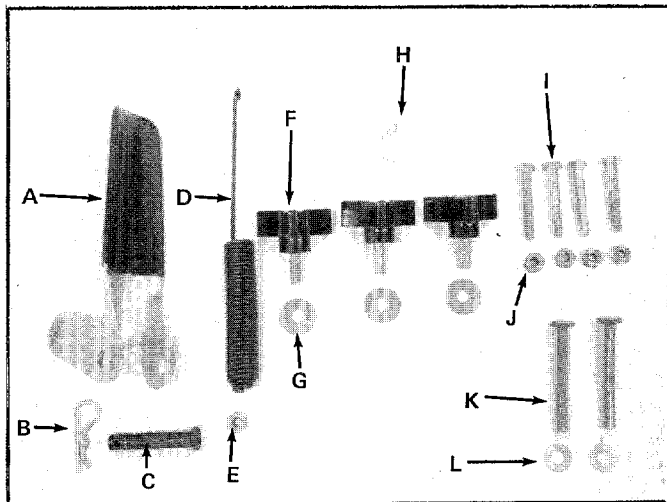

FIGURE 1.

## LOOSE PARTS IN CARTON (See Figure 2.)

- M (1) Bag
  - N (1) Nozzle
  - O (1) Upper Handle
  - P (1) Air Duct Assembly
  - Q (1) Clutch Rod\*
  - R (1) Directional Discharge Assembly
  - S (1) Impeller Guard
- \* Self-Propelled Models 685 and 24687 Only.

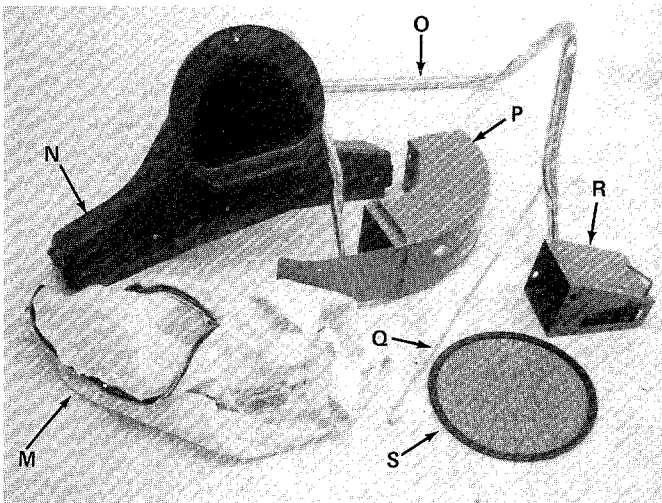

FIGURE 2.

## TOOLS REQUIRED:

- (2) 7/16" Open End or Box Wrenches.
- (1) Hammer or Mallet.
- (1) Adjustable Wrench.

1. Place nozzle (N) in position on front of housing so that it rests in flanges. Secure with one hand knob (F) and belleville washer (G). See figure 3.

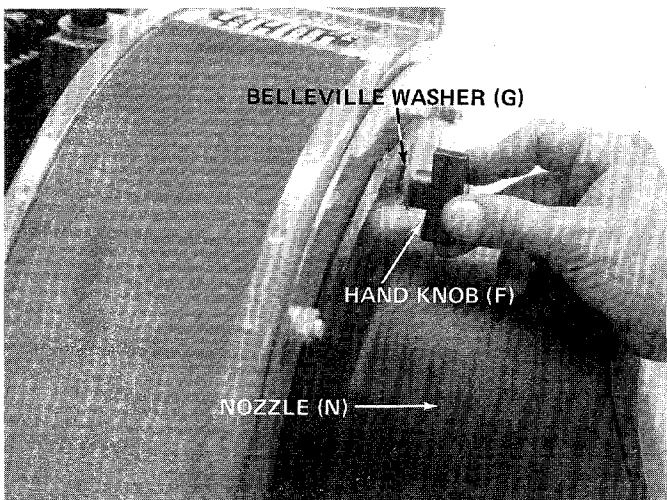

FIGURE 3.

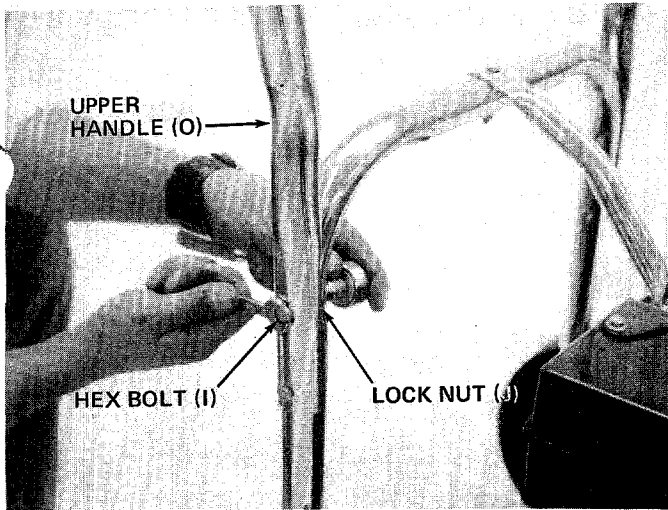

FIGURE 4.

2. Place the upper handle (O) in position over lower handle. Fasten with four hex bolts (I) and lock nuts (J) provided. See figure 4. Two 7/16" wrenches are required.

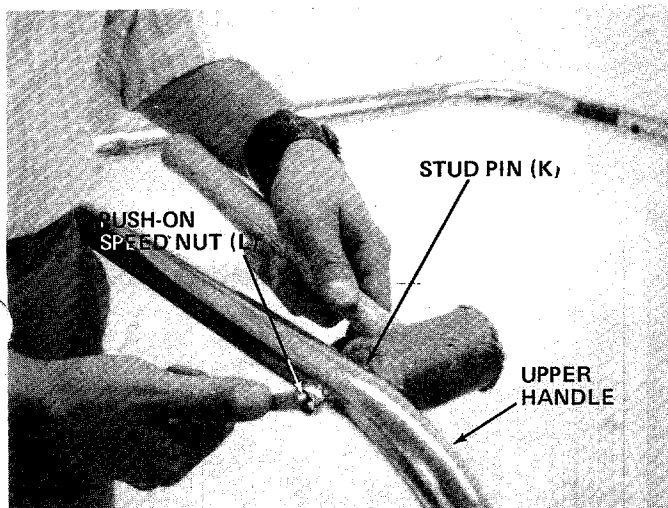

FIGURE 5.

3. Place the stud pins (K) in holes in upper handle (head of pins go to the inside of handle). Secure pins with push-on speed nuts (L) by holding speed nut with box wrench and tapping pin with hammer. See figure 5.

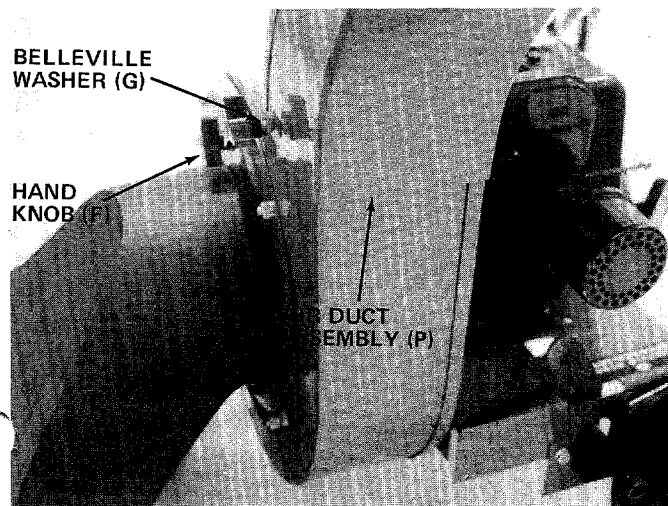

FIGURE 6.

4. Place air duct assembly (P) over opening on top of housing. Secure with two hand knobs (F) and belleville washers (G). See figure 6.

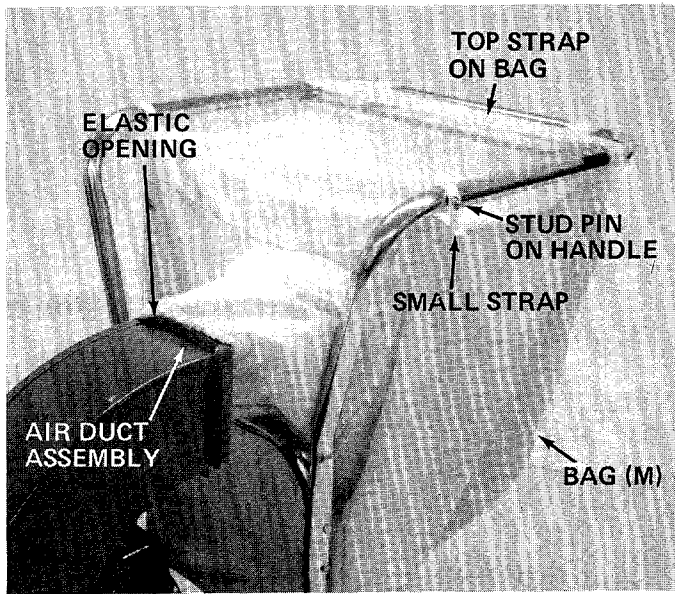

FIGURE 7.

5. Assemble the bag by slipping the top straps on bag (M) over upper handle. Hook two small straps over stud pins on handle. Slip elastic opening of bag over air duct assembly. See figure 7.

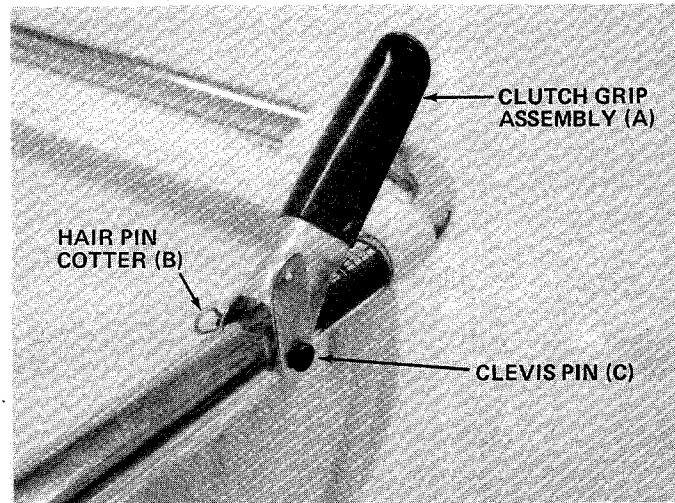

FIGURE 8.

6. Assemble the clutch grip (A) to the left hand side of upper handle. Secure in place with clevis pin (C) and hair pin cotter (B). See figure 8. Head of clevis pin should be to the outside of handle.

**NOTE**

Steps 6, 7 and 8 for self-propelled units only.

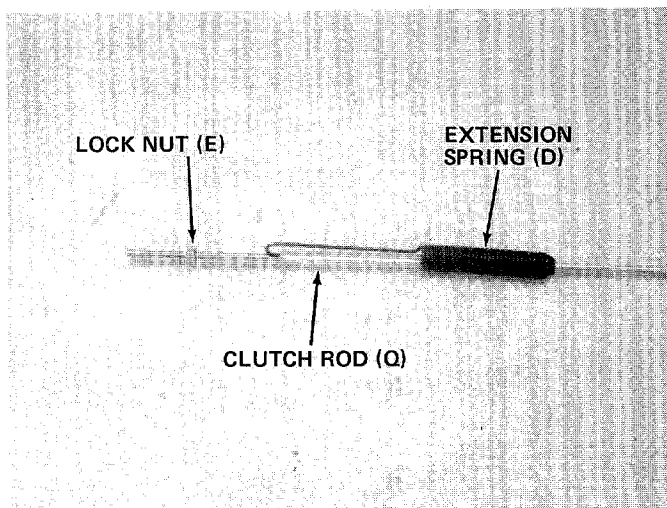

FIGURE 9.

7. Slide the extension spring (D) onto clutch rod (Q) as shown in figure 9. Thread lock nut (E) onto clutch rod approximately 2 1/2 inches.

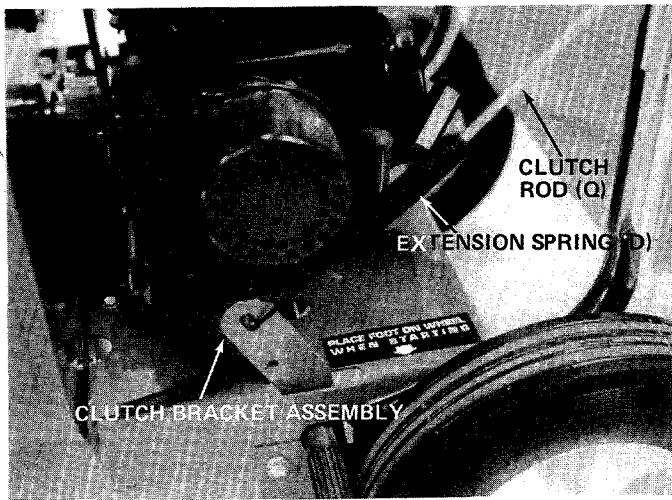

FIGURE 10.

8. Hook top (hooked end) of clutch rod into clutch grip. Hook spring into clutch bracket assembly. See figure 10. Spring should not have any slack. Adjust nut so that when the clutch grip is all the way up, there is no slack in the spring.



Engine must be stopped (off) and spark plug wire disconnected.

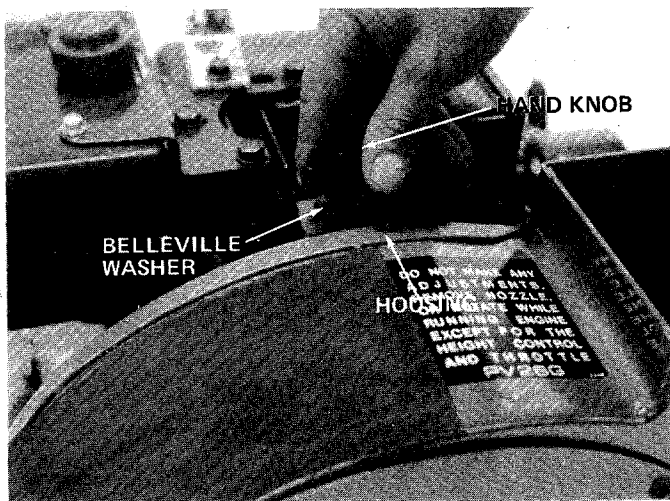

FIGURE 11.

#### ASSEMBLY INSTRUCTIONS

##### To Convert from a Vacuum to a Leaf Blower.

1. Remove the bag.
2. Remove the air duct assembly by removing two hand knobs and belleville washers.
3. Remove the nozzle by removing one hand knob and belleville washer.
4. Remove the hand knob and belleville washer holding the housing to engine brace. See figure 11.

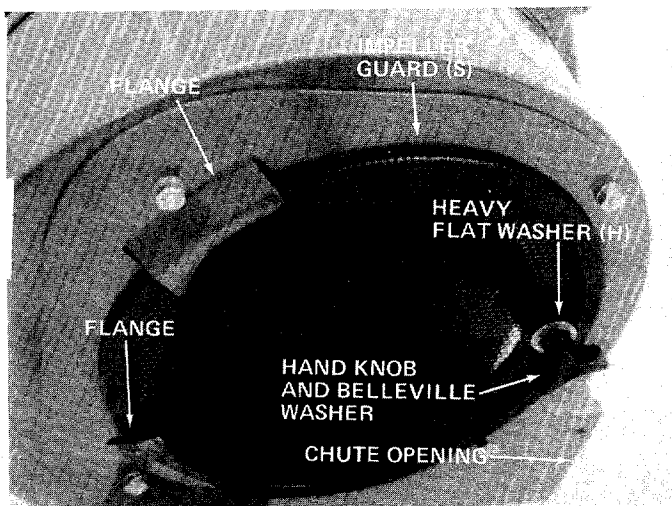
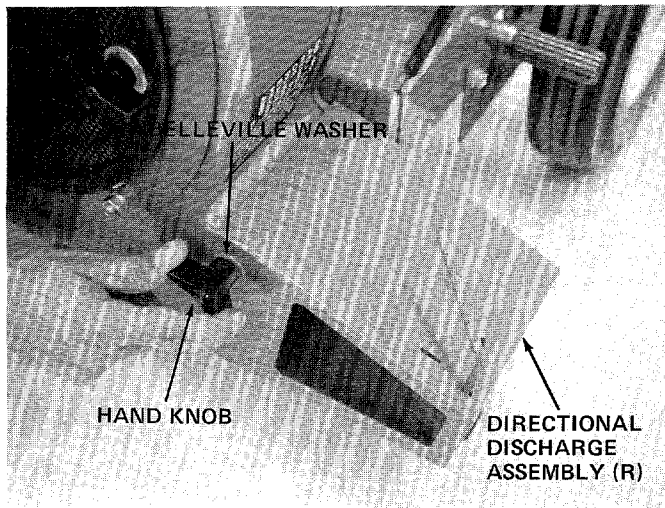

FIGURE 12.

5. Lift up on the housing and rotate it 90° clockwise. Chute opening should be to the right hand side when viewed from the front of unit. See figure 12.
6. Place the impeller guard (S) into flanges on front of housing. Line up hole in screen with hole on housing. Secure with one hand knob, belleville washer and heavy flat washer (H). See figure 12.



7. Place the directional discharge assembly (R) over chute opening. Secure with two hand knobs and belleville washers. See figure 13.

FIGURE 13.

## OPERATION

### PRE-START PREPARATIONS

Service engine with gas and oil. See engine manual packed with vacuum for complete instructions for care and maintenance of engine. **READ DIRECTIONS CAREFULLY.**

### TO START ENGINE

After the engine has been properly fueled and oiled (refer to engine operating and maintenance instructions), start engine following the instructions below.

1. Move throttle control lever on engine to START position.
2. Crank engine. Pull recoil with quick firm pull. Do not pull out so far the rope stops with a jerk as this will cause rope failure. Do not allow rope and handle to snap back into place.
3. After two or three full firm pulls on recoil (or as soon as engine fires), move speed control to run position.
4. **Self-Propelled Units Only** - To engage the drive mechanism, squeeze the clutch grip against the upper handle. Release the clutch grip to stop the forward motion.

### TO STOP ENGINE

1. To stop engine, move throttle control lever to STOP position.
2. Disconnect spark plug wire and ground to prevent accidental starting while equipment is unattended.

Operate a new engine at intermediate speeds and light load for the first few hours as you would a new automotive engine.



The vacuum bag has an air escape located on the upper right hand side. The air escape should be opened when the vacuum is in use. See figure 14.

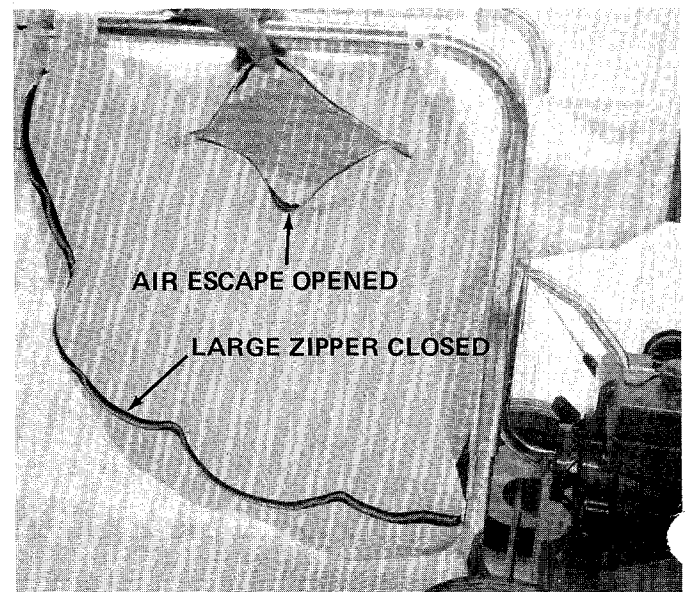

FIGURE 14.



# ADJUSTMENTS



Do not at any time make any adjustment to the unit without first stopping engine and disconnecting spark plug wire.

## HEIGHT ADJUSTMENT

To adjust the height of the nozzle, stand on the right hand side of vacuum and move the index handle towards the engine. Move handle towards rear of unit to lower height. Move the handle forward to raise the height. See figure 15.

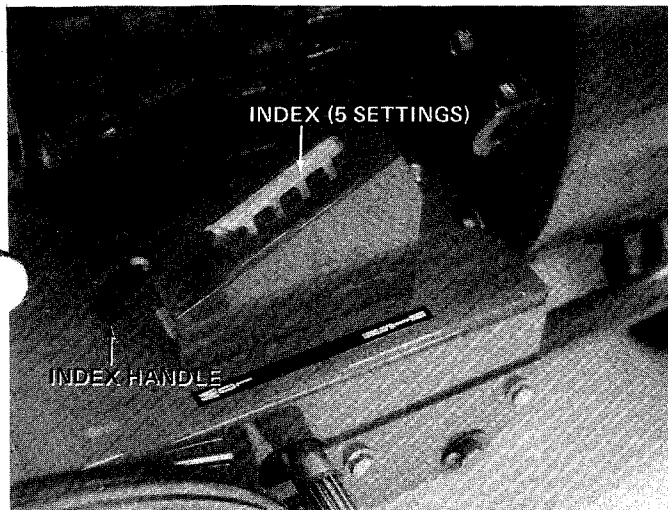

FIGURE 15.

## CARBURETOR ADJUSTMENT

If carburetor needs adjustment to start or for operation, see "Carburetor Adjustment" section of engine manual.

## CLUTCH ROD ADJUSTMENT (Self-Propelled Units Only)

To adjust the clutch rod, refer to step number 8 under assembly instructions.

# LUBRICATION

**Wheels** - Rear wheels are provided with oil lite bearings. Place a few drops of SAE 30 oil on each bearing once a season.

**Gear Box (Self-Propelled Units Only)** - The gear box lubricated with 2 ounces of High Temp. (450° F.) grease. Order part number 737-0120. Periodically check lubricant level by removing the two self-tapping screws on the gear box cover and lifting off the cover. Do not change grease; simply add if necessary.

# MAINTENANCE



Disconnect spark plug wire and ground it against the engine before performing any repairs or maintenance.

## BELT REPLACEMENT (Self-Propelled Units Only)

1. Remove the nozzle or impeller guard from front of air duct housing.
2. Remove hex bolt and lock washer from center of impeller. See figure 16. A 9/16" socket wrench with extension is needed.

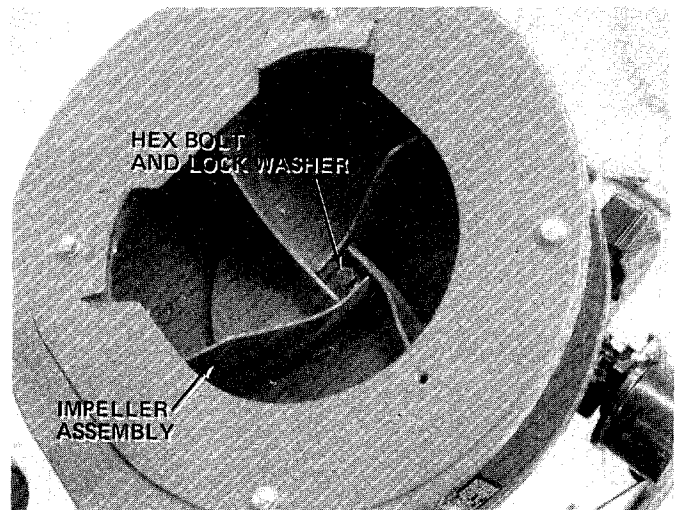

FIGURE 16.

3. Remove hand knob and Belleville washer from top of housing.
4. Remove two self-tapping screws which hold the belt guard. See figure 17. A 3/8" wrench is required. Lift off belt guard.

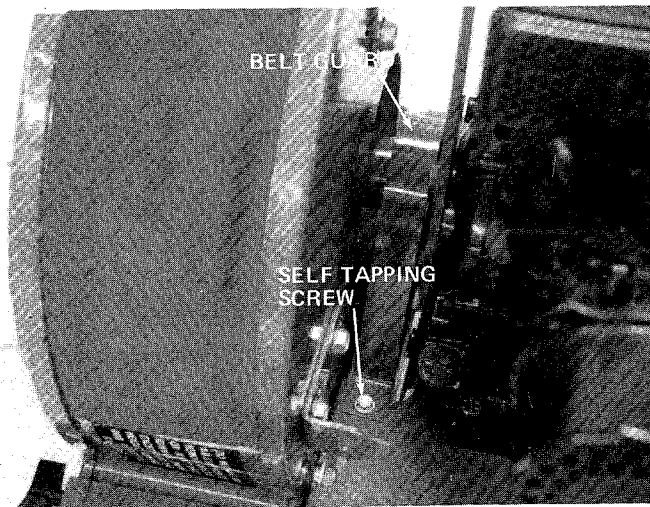

FIGURE 17.

5. Slide belt off the impeller pulley. Slide housing and impeller off engine crankshaft. Be careful not to lose square key. See figure 18.

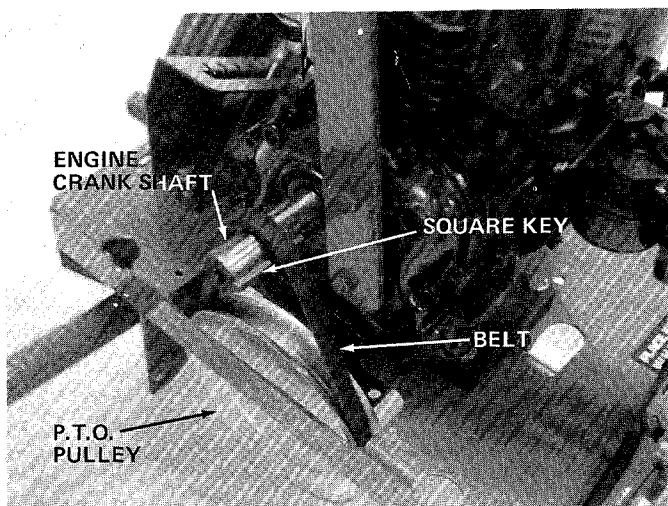

FIGURE 18.

6. Slide belt off crank shaft.
7. Remove belt from P.T.O. pulley and install new belt. See figure 18.



When reassembling the new belt, the aid of another person will be helpful.

8. Turn the crankshaft until the key way on shaft is directly on top. While holding housing assembly and impeller assembly, line up the key way on the pulley with the key on the crankshaft, and slide housing and impeller assemblies onto crankshaft.

9. Secure impeller to crankshaft with hex bolt and lockwasher, removed in step 2. Tighten securely.
10. Slip belt over impeller pulley and reassemble the belt guard.
11. Reassemble the nozzle or impeller guard.

## OFF-SEASON STORAGE

The following steps should be taken to prepare the unit for storage.

1. Clean the engine and the entire unit thoroughly.
2. Refer to engine manual for correct engine storage instructions.
3. Store unit in a clean, dry area.

# NOTES

A large rectangular box with a black border, intended for taking notes. On the left side of the box, there are three circular binder holes. The interior of the box is completely blank.

# Models 675, 685, 24677 and 24687

IF YOU WRITE TO US ABOUT THIS ARTICLE  
OR IF YOU ORDER REPLACEMENT PARTS AL-  
WAYS MENTION THIS MODEL & SERIAL NO  
MODEL

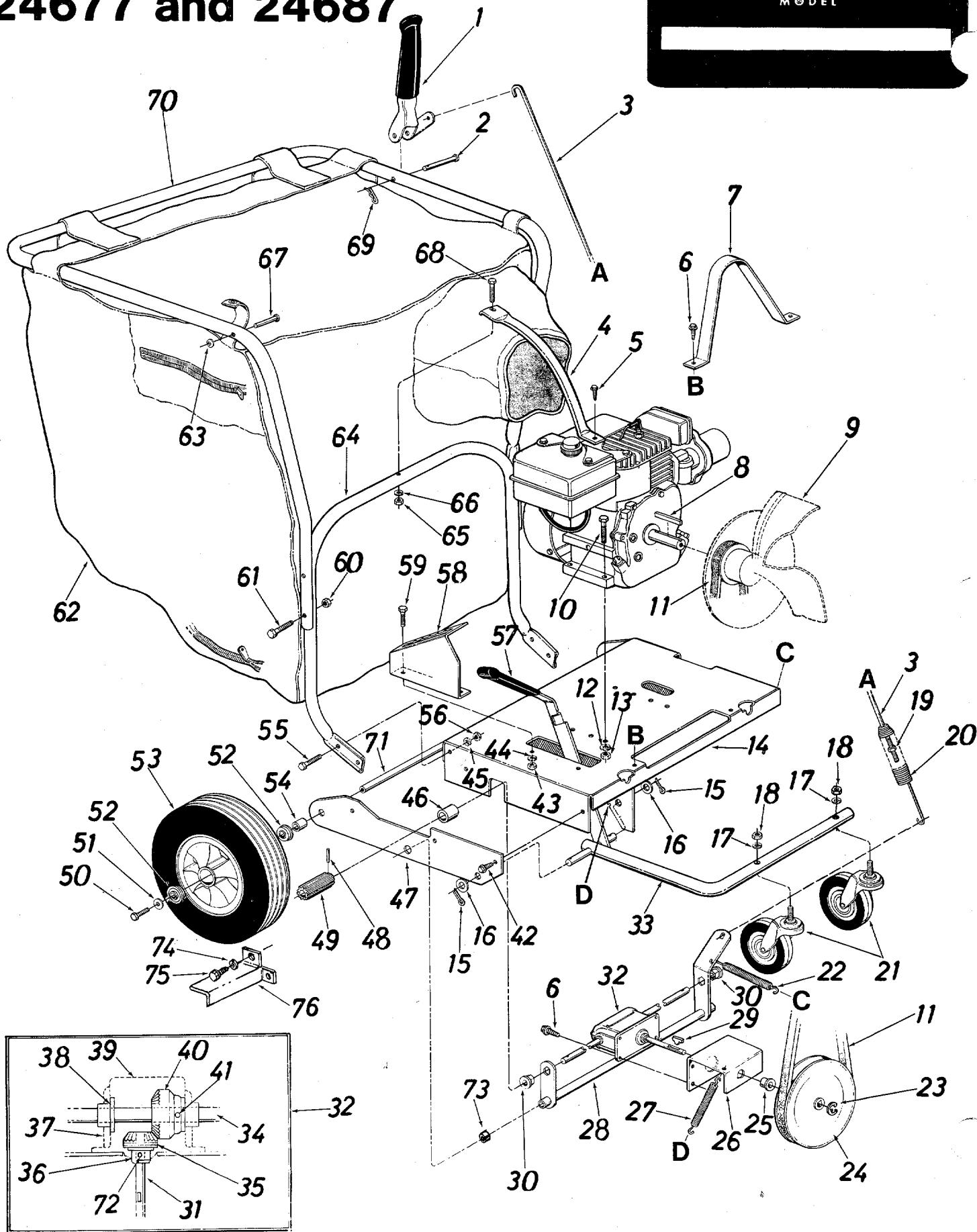

PARTS LIST FOR MODELS 675, 685, 24677 and 24687

Ref. No.	Part No.	Color Code	DESCRIPTION	New Part	Ref. No.	Part No.	Color Code	DESCRIPTION	New Part
1	05778		Clutch Grip Ass'y. †		39	08187		Gear Box Cover †	
2	711-0679		Clevis Pin .375" Dia. x 1.88" Lg. †		40	748-0135		Bevel Gear .62" I.D. x 28 Teeth †	
3	747-0154		Clutch Rod 32" Lg. †		41	715-0246		Spring Pin Spiral 3/16" Dia. x 1.25" Lg. †	
4	749-0482		Handle Brace (5 H.P. Tecumseh)	N	42	710-0726		Hex Wash. Hd. "AB" Tap Scr. 5/16" x .75" Lg.	
	749-0483		Handle Brace (5 H.P. Briggs & Stratton)	N	43	712-0267		Hex Nut 5/16-18 Thd.*	
	749-0484		Handle Brace (8 H.P. Tecumseh)	N	44	736-0119		L-Wash. 5/16" I.D.*	
5	-----		Part of Engine		45	736-0119		L-Wash. 5/16" I.D.*	
6	710-0776		Hex Wash. Hd. "AB" Tap Scr. 1/4" x .62" Lg. †		46	750-0372		Spacer .63 I.D. x 1.00" O.D. x 1.12" Lg. †	
7	14558		Belt Guard †	N	47	14530 --- 488		Right Side Plate	N
8	714-0114		Square Key 1/4" x 1/4" x 2.00" Lg.*			<del>14531 --- 488</del>		<del>Left Side Plate</del>	N
9	14536 --- 488		Air Vane Plate Ass'y. (675 and 677)	N	48	715-0139		Spring Pin Spiral 3/16" Dia. x .81" Lg. †	
	14557 --- 488		Air Vane Plate Ass'y. w/pulley †		49	748-0288		Drive Pinion †	N
10	710-0442		Hex Bolt 5/16-18 x 1.50" Lg.*		50	710-0170		Hex Locking Bolt 5/16-24 x .62" Lg.	
11	754-0219		"V"-Belt 1/2" x 26" Lg. †		51	736-0159		Fl.-Wash. .34" I.D. x 87" O.D.	
12	736-0119		L-Wash. 5/16" I.D.*		52	-----		Ball Bearings - Part of Wheel Ass'y. (Ref. 53)	
13	712-0267		Hex Nut 5/16-18 Thd.*		53	734-1035		Wheel Ass'y. - Comp. 12"x3"	N
14	14527 --- 488		Engine Mounting Frame Ass'y.		54	750-0194		Spacer .63" I.D. x 1.00" O.D. x .94" Lg.	
15	1544-019		Cotter Pin 5/32" Dia. x 1.25" Lg.*		55	710-0118		Hex Bolt 5/16-18 x .75" Lg.*	
16	736-0187		Fl.-Wash. .63" I.D. x 1.25" O.D.		56	712-0267		Hex Nut 5/16-18 Thd.*	
17	736-0921		L-Wash. 1/2" I.D.*		57	720-0142		Flat Grip Vinyl	
18	712-0206		Hex Nut 1/2-13 Thd.*		58	14561		Index Plate	N
	712-0107		Hex Cent. L.-Nut 1/2" I.D.		59	710-0118		Hex Bolt 5/16-18 x .75" Lg.*	
20	732-0411		Extension Spring .78" O.D. x 7.50" Lg. †	N	60	712-0107		Hex Cent. L.-Nut 1/4-20 Thd.	
21	734-1036		Swivel Caster Wheel 5" Dia. x 1.25"	N	61	710-0136		Hex Bolt 1/4-20 x 1.75" Lg.	
22	732-0409		Extension Spring .38" O.D. x 3.18" Lg. †	N	62	764-0161		Vacuum Bag	
23	716-0104		Snap "E"-Ring .50" Dia. Shaft †		63	1539-019		Push Speed Nut for .25" Dia. Stud	
24	756-0367		"V"-Pulley 5/8" x 6.50" O.D. †	N	64	749-0481		Lower Handle	N
25	748-0142		Flange Bearing .502" I.D. †		65	712-0287		Hex Nut 1/4-20 Thd.*	
26	14570		Gear Box Mounting Bracket †	N	66	736-0329		L-Wash. 1/4" I.D.*	
27	40318		Extension Spring .50" O.D. x 3.28" Lg. †		67	711-0737		Stud Pin .250" Dia. x 1.75" Lg.	
28	14565		Clutch Bracket Ass'y. †	N	68	710-0136		Hex Bolt 1/4-20 x 1.75" Lg.*	
29	714-0229		#2 Woodruff Key 3/32" Dia. x .81" Lg. †		69	714-0145		Internal Cotter Pin 3/8" Dia.	
30	741-0225		Hex Flange Bearing Plastic .625" I.D. †		70	749-0480		Upper Handle	N
31	738-0516		Pinion Shaft .50" Dia. x 5.0" Lg. †	N	71	738-0185		Rear Axle .624" Dia. x 24.37" Lg.	
32	717-0493		Gear Box Ass'y. Comp. †	N	72	715-0249		Spring Roll Pin 5/32" Dia. x 1.12" †	
33	14571 --- 488		Caster Arm Ass'y.	N	73	750-0142		Spacer .82" I.D. x 1.00" O.D. x .305" Lg. †	
34	08348		Drive Shaft .624" Dia. x 22.75" Lg. †		74	736-0175		L-Wash. .265" I.D. †	
35	748-0136		Bevel Gear .50" I.D. x 14 Teeth †		75	710-0352		Hex Self Tap Scr. 1/4" x 3/8" Lg. †	
36	748-0108		Flange Bearing .503" I.D. †		76	14556		R.H. Pinion Guard †	N
37	08189		Gear Box †			14555		L.H. Pinion Guard (Not Shown) †	N
38	748-0110		Flange Bearing .630" I.D. †						

† Parts for Self-Propelled Units (Models 685 and 24687) Only.

# Models 675, 685, 24677 and 24687

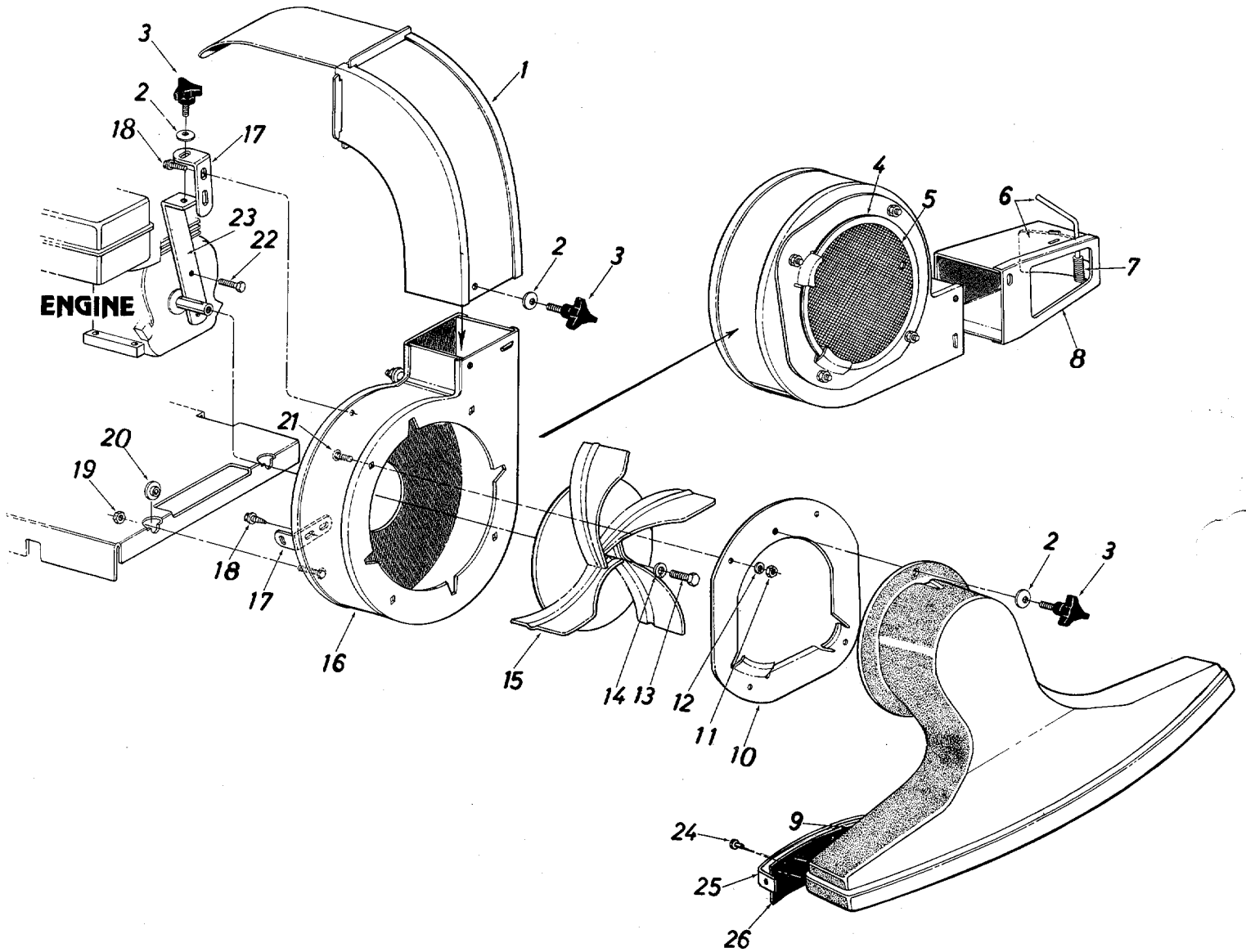

# Models 675, 685, 24677 and 24687

## PARTS LIST FOR MODELS 675, 685, 24677 and 24687

Ref. No.	PART No.	COLOR CODE	DESCRIPTION	New Part
1	14532 --- 488		Air Duct Assembly	N
2	736-0242		Belleville Wash. .34" I.D. x .87" O.D.	
3	720-0170		3-Arm Thumb Scr. 5/16-18 x .75" Lg.	
4	731-0516		Trim Strip 36.5" Lg.	N
5	14560		Impeller Guard	N
6	14549		Door Assembly	N
7	732-0335		Compression Spring	
8	14546		Directional Discharge Ass'y. (Includes Ref. No. 6 & 7)	N
9	14562		Nozzle Ass'y.	N
10	14563		Nozzle Plate Ass'y.	N
11	712-0267		Hex Nut 5/16-18 Thd.*	
12	736-0119		L.-Wash. 5/16" I.D.	
13	710-0191		Hex Bolt 3/8-24 x 1.25" Lg.*	
14	736-0217		L.-Wash. 3/8" I.D. H.D.	
15	14536 --- 488		Air Vane Plate Ass'y. (675 and 24677)	N
	14557 --- 488		Air Vane Plate Ass'y. w/pulley (685 and 24687)	N
16	14542 --- 488		Blower Housing Complete	N
17	14541		Right Angle Bracket	N
18	710-0600		Hex Wash. Hd. Self Tap Scr. 5/16-18 x .50" Lg.	
19	712-0158		Hex Cent. L.-Nut 5/16-18 Thd.	
20	736-0289		Shoulder Spacer .50" I.D. x .135	
21	710-0260		Carriage Bolt 5/16-18 x .62" Lg.*	
22	710-0170		Hex Locking Bolt 5/16-24 x .62" Lg.	
23	14539		Housing - Engine Brace Ass'y.	
24	728-0143		Pop Rivet (5-Required)	
25	14569		Wiper Retaining Strip	N
26	735-0214		Nozzle Wiper	N

\*For faster service obtain standard nuts, bolts and washers locally. If these items cannot be obtained locally, order by part number and size as shown on parts list.

(488 - Mack Truck Yellow)  
(497 - Yard-Man Red)

When ordering parts, if color or finish is important use the appropriate color code shown above. (e.g. Mack Truck Yellow Finish—14542 (488).)

NOTE: The engine is not under warranty by the vacuum manufacturer... If repairs or service is needed on the engine, please contact your nearest authorized engine service outlet. Check the "Yellow Pages" of your telephone book under "Engines—Gasoline."



### NOTE

This instruction manual covers various models and all specifications shown do not necessarily apply to your model. Specifications subject to change without notice or obligation.

**MTD PRODUCTS INC ..... YARD-MAN COMPANY**

P.O. BOX 36900 • CLEVELAND, OHIO 44136



## Free Manuals Download Website

<http://myh66.com>

<http://usermanuals.us>

<http://www.somanuals.com>

<http://www.4manuals.cc>

<http://www.manual-lib.com>

<http://www.404manual.com>

<http://www.luxmanual.com>

<http://aubethermostatmanual.com>

Golf course search by state

<http://golfingnear.com>

Email search by domain

<http://emailbydomain.com>

Auto manuals search

<http://auto.somanuals.com>

TV manuals search

<http://tv.somanuals.com>