

RIVA ZOOM 135EX FREEDOM ZOOM 135EX

E INSTRUCTION MANUAL

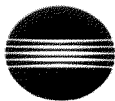
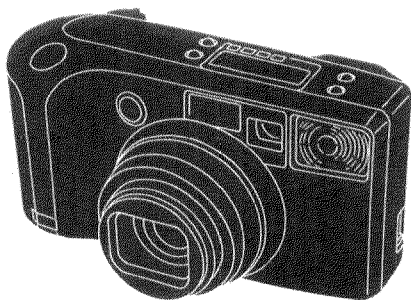

MINOLTA

Congratulations on your purchase of this Minolta camera. This manual gives you explanations for each function, plus all the information you'll need to understand and operate this camera properly.

To begin taking pictures in the easiest way possible, read **Getting Started**. Later, when you're ready to learn how to use the camera's other buttons and functions to improve your pictures, move along to **Advanced Operation**.

ATTACHING THE STRAP

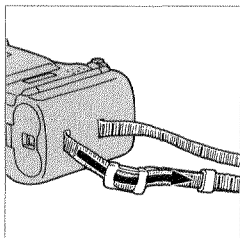
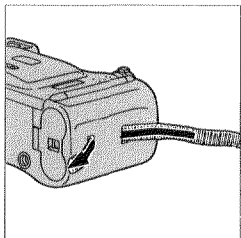

TABLE OF CONTENTS

NAMES OF PARTS

Camera Body	2
Viewfinder	4
Data Panel	5

GETTING STARTED

Inserting Batteries	6
Low Battery Symbol	7
Auto Power Off	7
Loading Film	8
Full-Auto Operation	10
Film Rewind	13

ADVANCED OPERATION

Focus Hold	14
Flash	16
Auto-Switchover Flash	16
Manual Fill-Flash	16
Flash Cancel	16
Red-Eye Reduction	17
Flash Information	18
Exposure Compensation	19
Subject Program Selection	20
Macro	22
Portrait	23
Night Portrait	24
Thank You/Take Me	25
Spot Metering	26
Self-Timer	27
Continuous-Drive Mode	28
Double Exposure	29
Remote Control	30

FOR OWNERS OF THE DATE MODEL

CARING FOR YOUR CAMERA

TECHNICAL DETAILS

NAMES OF PARTS

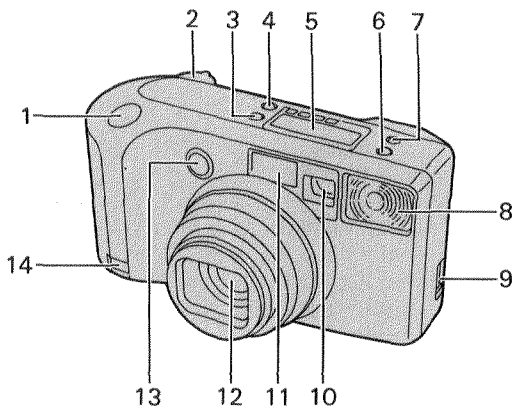

1. Shutter-release button
2. Zoom control
3. Drive/Operating-mode button
4. Subject-program selector
5. Data panel
6. Flash-mode button
7. Red-eye-reduction button
8. Flash
9. Back-cover release
10. Viewfinder window*
11. Autofocus window*
12. Lens*
13. AF illuminator, Red-eye reduction lamp, Self-timer indicator, Delayed-release indicator
14. Remote-control window

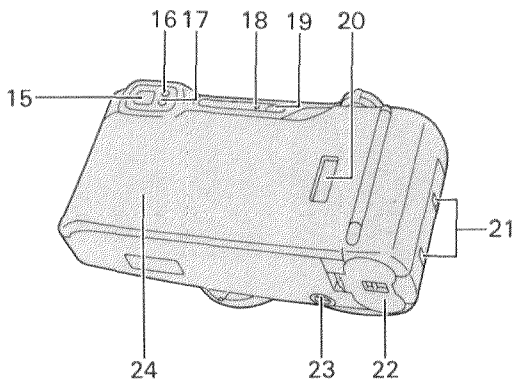

- 15. Viewfinder*
- 16. Focus lamp (green)
- 17. Flash lamp (orange)
- 18. Rewind button
- 19. On/Off button
- 20. Film window
- 21. Strap eyelet
- 22. Battery cover
- 23. Tripod socket
- 24. Back cover

* Do not touch

VIEWFINDER

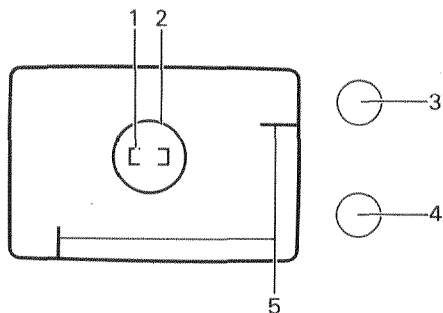

1. Focus frame
Camera focuses within this frame.
2. Spot-metering circle
Camera sets exposure with a reading from inside this circle.
3. Focus lamp (green)
Glow steadily: Focus confirmed.
Blinks quickly: Subject too close.
Blinks slowly: Contrast too low.
4. Flash lamp (orange)
Glow steadily: Flash will fire with shutter release.
Blinks quickly: Flash charging.
Blinks slowly: Camera-shake warning.
5. Close-framing guides
When your subject is closer than 1.8m (5.9 ft.) at 50-135mm, the picture should be composed within this frame.

DATA PANEL

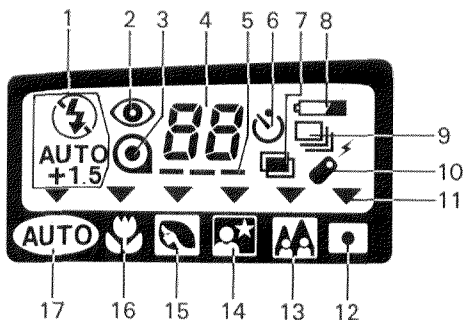

1. Flash-mode indicator

 : Auto-Switchover Flash

 : Manual fill-flash

 : Flash cancel

 : Exposure compensation (+1.5EV)
+1.5

2. Red-eye-reduction indicator

3. Film-cartridge mark

4. Frame counter

5. Film-transport signals

6. Self-timer indicator

7. Double-exposure indicator

8. Low-battery symbol

9. Continuous-drive indicator

10. Remote-control indicator

11. Subject-program pointer

12. Spot-metering indicator

13. Thank-you/Take-me-mode indicator

14. Night-portrait-mode indicator

15. Portrait-mode indicator

16. Macro-mode indicator

17. Full-auto indicator

GETTING STARTED INSERTING BATTERIES

Your camera uses two 3-volt lithium batteries (CR-123A) that supply power for all camera operations except the Remote Control (optional).

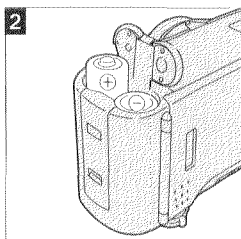
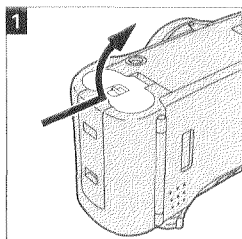

- 1** Open the battery cover by sliding the battery-cover lock in the direction indicated.
- 2** Insert the batteries as shown on the inside of the battery cover and snap the cover closed.

Battery Cautions

- Read and follow all warnings and instructions supplied with the batteries.
- Keep batteries away from children.
- Do not attempt to disassemble, recharge, short out, or subject batteries to high temperatures or fire.
- Do not mix batteries of different ages or brands.

Low-Battery Symbol



If the blinking low-battery symbol appears in the data panel along with the other indicators, you can still use the camera, but the batteries will have to be replaced soon.



If the blinking low battery symbol appears alone, you cannot use the camera until you replace the batteries.

Auto Power Off

To save power, your camera automatically turns off if it is not operated for more than three minutes.

LOADING FILM

You should only use DX-coded, 35mm film with ISO ratings from 25 to 3200. We recommend ISO 400 or higher for telephoto photographs or pictures taken in low light.

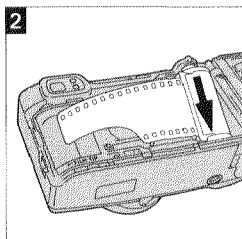
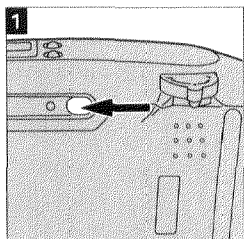

- 1** Turn the camera on and make sure 0 is displayed in the data panel.
- 2** Open the back cover by sliding the back-cover release down and place the film cartridge into the film chamber, bottom first as shown.

Always load your film in the shade or away from direct sunlight.

Polaroid instant 35mm films cannot be used.

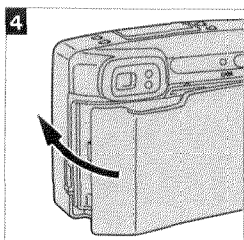
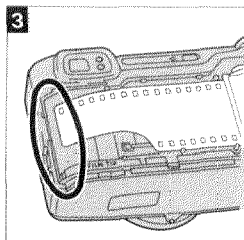

RIGHT

WRONG



3 Lay the film flat between the guide rails and extend to the "FILM TIP" mark.

If the film extends too far, gently push the excess back into the cartridge.

4 Snap the back cover closed.

The film automatically advances to the first frame and 1 appears in the data panel.

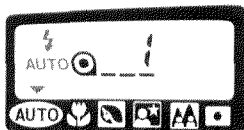

If 0 blinks in the data panel, the film was incorrectly loaded. Open the back cover and re-load the film.

AUTO

FULL-AUTO OPERATION

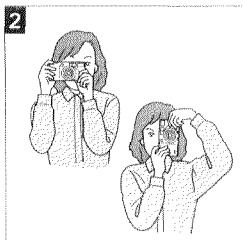
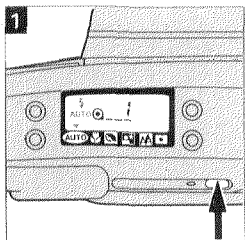

- 1 Press the On/Off button to turn the camera on.**

The camera will be set to Full-Auto which is the camera's standard "point and shoot" mode. The flash will fire whenever necessary (see "FLASH" section on page 16).

- 2 Hold the camera steady and make sure your fingers are not covering the flash. If you are taking a vertically-framed picture, turn the camera so the flash is on top as shown.**

When your subject is closer than 1.8m (5.9 ft.) at 50-135mm, compose your picture within the close-framing guides using focus hold if necessary (see page 14).



Caution: Do not hold the lens barrel while you photograph, otherwise focus may not be accurate.

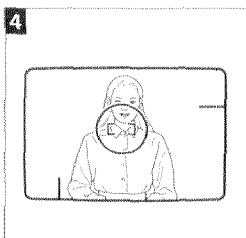
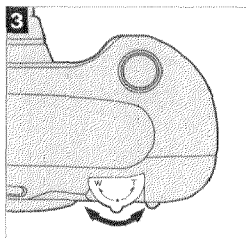

3 To zoom the lens toward wide (38mm), move the zoom control to the left. To zoom toward telephoto (135mm) move the control to the right. The focal length is indicated on the lens barrel.

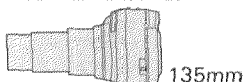
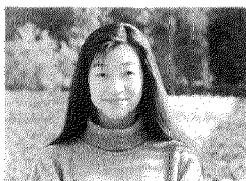

4 Center the focus frame on your subject.

Between 38mm and 50mm, the lens barrel will be visible in the lower-right corner of the viewfinder, but will not appear in the photograph.

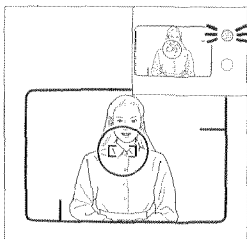
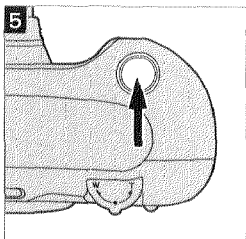

5 Press the shutter-release button partway down so that the green focus lamp glows then all-the-way down to take the picture.

- In low-light conditions, the lamp on the front of the camera lights automatically.
- Always press the shutter-release button with a slow, steady squeeze--never a quick jab.
- The film will automatically advance to the next frame.

The green focus lamp blinks quickly and the shutter locks when you are too close to the subject. Make sure you are at least 0.65m (2.1 ft.) at 135mm and 0.8m (2.6 ft.) at 38mm from your subject.

For close-up photography, see "MACRO" section on page 22.

- If you are closer than 0.35m (1 ft.), the green focus lamp will blink slowly and the picture will not be in focus.

The green focus lamp blinks slowly when the subject contrast is low. The shutter can be released, but focus will be set to 3.1m (10.2 ft.) with flash and infinity without flash. See "FOCUS HOLD" on page 14 for other focusing techniques.

FILM REWIND

Automatic Rewind



After you take the last picture on the roll, the camera automatically begins rewind and the frame counter counts down to 0.

When 0 appears in the data panel and the film-cartridge mark blinks, open the back cover and remove the film.

Manual Rewind

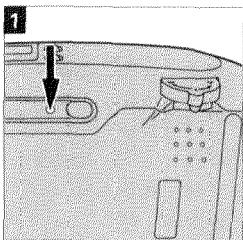

1 Gently press the manual-rewind button using a pen or similar object.

2 When 0 and the blinking film-cartridge mark appear in the data panel, open the back and remove the film.

CAUTION

If 0 doesn't appear in the data panel after the motor stops running, check the display for the low-battery symbol. If it appears by itself, replace the battery and press the manual-rewind button. If all the indicators blink and rewind stops, press the manual-rewind button. If rewind does not resume, contact an authorized Minolta Service Facility.

ADVANCED OPERATION FOCUS HOLD

If you want to take a picture with the main subject placed to one side, use focus hold to ensure accurate focusing. You should also use focus hold in the special situations described on the next page.

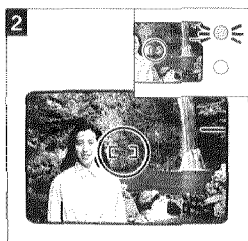
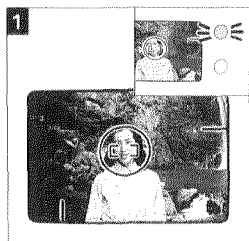

Off-Center Subjects

1 Center the focus frame on your subject, then press and hold the shutter-release button partway down until the green focus lamp glows.

2 Without lifting your finger, recompose the frame and press the shutter-release button all-the-way down to take the picture.

SPECIAL FOCUSING SITUATIONS

Some subjects or scenes, such as those described below, are difficult for the autofocus system to detect. To ensure proper focus in these situations, first lock focus on another object at the same distance from you as your main subject, then recompose your picture and press the shutter-release button.

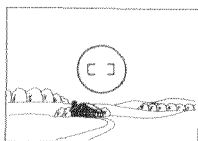

When a very bright or low-contrast area fills the center of the viewfinder.

- The green lamp will blink slowly to warn you that focus may not be accurate.



When your subject is near a very bright object or area.

- The focus lamp may glow, but focus may not be correct.



When two subjects overlap.

- The green lamp will glow and the closer of the two subjects will be in focus.

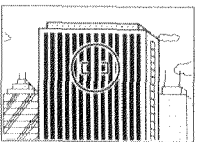

When a subject composed of alternating light and dark lines fills the center of the viewfinder.

- The green lamp will blink rapidly and the shutter will lock.

FLASH

SELECTING THE FLASH MODE

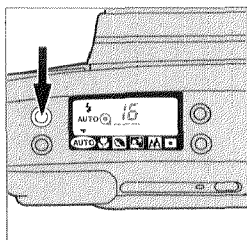

Press the flash mode button until the indicator of the mode you want appears in the data panel.

Flash modes remain selected after you take the picture.

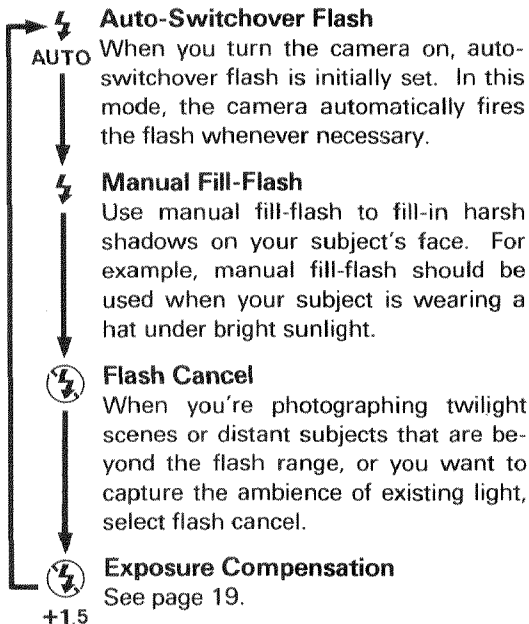

RED-EYE REDUCTION

Reduce red-eye in flash pictures of people by using red-eye reduction.

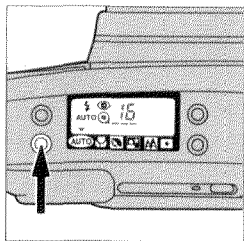

Press the red-eye-reduction button so  appears in the data panel.

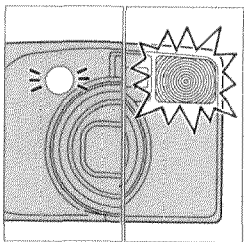

Warn the people whom you are photographing that the lamp on the front of the camera will blink three times before the flash fires.

When you press the shutter-release button all-the-way down, the lamp on the front of the camera and the flash lamp blink three times, then the main flash fires with the shutter release.

Red-eye-reduction mode remains selected until you cancel it. To cancel, press the red-eye-reduction button so that the indicator disappears from the data panel.

FLASH INFORMATION

Flash Lamp

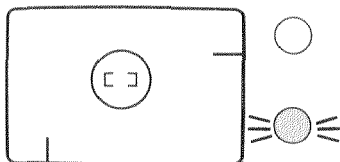

When the orange flash lamp blinks rapidly, the flash is charging. Wait until it glows steadily and then take the picture.

● The flash takes approximately 4 seconds to charge.

When the orange flash lamp blinks slowly, your scene is too dark for a sharp hand-held picture. Use flash or place the camera on a tripod.

Flash Range

Make sure your subject is positioned within the flash range.

Flash Range		
	ISO 100	ISO 400
38mm	0.80m to 5.5m (2.6 - 18 ft.)	0.80m to 11m (2.6 - 36 ft.)
135mm	0.65m to 3.1m (2.1 - 10.2 ft.)	0.65m to 6.2m (2.1 - 20.3 ft.)



+1.5 EXPOSURE COMPENSATION



Exposure compensation is recommended when you are photographing snow scenes, beach scenes, back-lit or spot-lit subjects, or scenes with a large amount of sky. Exposure compensation will increase the exposure by 1.5 EV (stops).

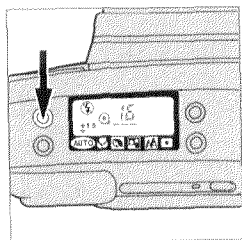

Press the flash-mode button until  appears in the data panel.

- The exposure compensation level cannot be changed.
- When the background is very bright, use spot metering (page 26).



SUBJECT PROGRAM SELECTION

Subject Program Selection allows you to tailor the camera's fully automatic operation to suit the subject. It provides optimal camera settings for close-ups, portraits, portraits at night, pictures of you taken by someone else with your camera, and back-lit or spot-lit subjects.

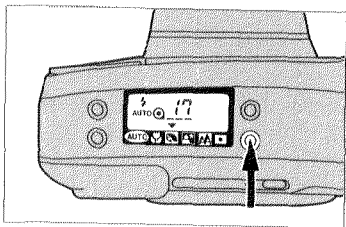

Press the subject program selector until the pointer is above the icon of the subject you are photographing.

- After you take the picture, the camera will return to Full-Auto automatically and the flash will return to the mode which was set before you used a subject program.



Full-Auto: Camera's standard point-and-shoot mode which is suited for general photography. Full-Auto is automatically set when you turn the camera on and after you take a picture in one of the subject programs.



Macro: Optimizes camera settings for close-up photography.



Portrait: Provides suitable framing, size, and camera settings for portrait situations.



Night Portrait: Synchronizes flash with a slow-shutter speed to provide a balanced exposure between the subject and the background.



Thank You/Take Me: Sets the camera so you can ask someone to photograph you and your family or friends.



Spot Metering: Sets exposure based on the area in the spot metering circle.



MACRO



With Macro mode, you can take pictures of small objects such as flowers or models as close as 50cm (19-11/16 in.). At this distance, the camera will automatically provide

a subject magnification of 1/4 lifesize.

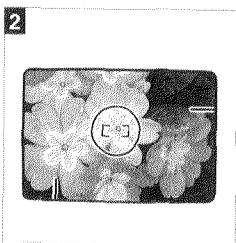
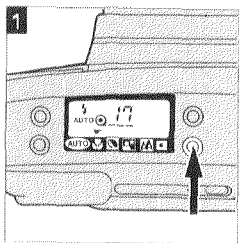

1 Press the subject program selector until the pointer is above the  icon.

2 Place the subject within the focus frame and press the shutter-release button all-the-way down.

- Two seconds after you select Macro mode, the lens will automatically zoom to 105mm and lock.
- Auto-switchover flash is initially set, but any other flash mode including exposure compensation can be selected.
- When your subject is closer than 1.4m (4.5 ft.) compose your picture within the close-framing guides.
- When the green focus lamp blinks slowly, focus will be set to 0.5m (1.6 ft.)



PORTRAIT



In Portrait mode, the lens automatically zooms to provide suitable framing for portraits when you press the shutter-release button partway down.

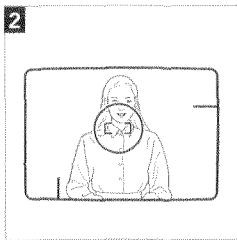
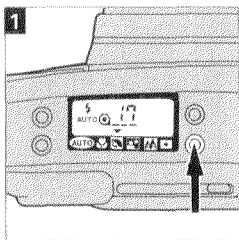

- 1** Press the subject program selector until the pointer is above the  icon.
- 2** Place your subject inside the focus frame and press the shutter-release button partway down.
- 3** Wait for the lens to zoom and press the shutter-release button all-the-way down.
 - The main subject must be centered before pressing the shutter-release button partway down.
 - If you manually zoom the lens after selecting Portrait mode, autozoom will not function again.
 - Auto-switchover flash is initially set, but any other flash mode including exposure compensation can be selected.



NIGHT PORTRAIT



In Night-portrait mode, the camera will balance flash and existing light so you can take beautiful pictures of people at sunset or at night.

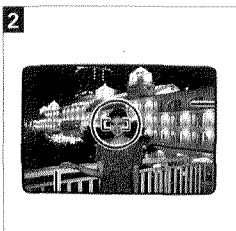
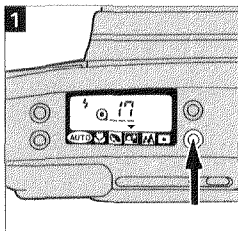

1 Press the subject program selector until the pointer is above the  icon.

2 Place the subject within the focus frame and press the shutter-release button all-the-way down.

- The flash is set to manual fill-flash and cannot be changed. Red-eye reduction is recommended because low light presents optimum conditions for red-eye to occur.

- The maximum shutter speed in Night-portrait mode is one second. Since the shutter speed will most likely be slow, a tripod or other camera support is highly recommended.





THANK YOU/TAKE ME

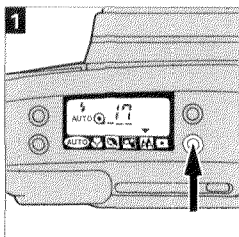

When you ask someone who is unfamiliar with the camera to take your picture, select Thank-you/Take-me mode. The camera automatically zooms the lens to 38mm for

a wide view and limits the focusing range to ensure that you will be in focus.



1 Press the subject program selector until the pointer is above the  icon.

2 Frame the subject in the viewfinder and press the shutter-release button all-the-way down.

Effective Focusing Range	
Clear day	2.5-12m (8.2-39.6 ft.)
Cloudy day	3-7m (9.8-23 ft.)

● If the subject is not within this range, Full-auto mode is recommended.

- Two seconds after you select this mode, the lens will automatically zoom to 38mm and lock.
- Auto-switchover flash is initially set, but any other flash mode including exposure compensation can be selected.
- When the green focus lamp blinks slowly, focus will be set to 3.1m (10.2 ft.) with flash and 4.2m (13.8 ft.) without flash.



SPOT METERING



In Spot-metering mode, the camera sets exposure based on the center of the picture. Use this mode to photograph strongly back-lit or spot-lit subjects.

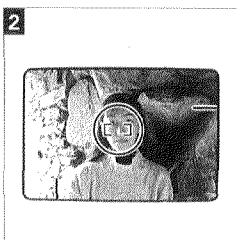
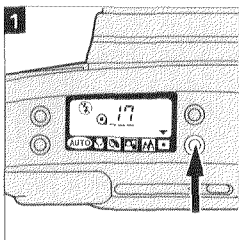

- 1** Press the subject program selector until the pointer is above the  icon
- 2** Place your subject inside the spot-metering circle and press the shutter-release partway down.
- 3** When the green focus lamp glows, press the shutter-release button all-the-way down.
 - Flash is initially canceled, but any other flash mode including exposure compensation can be selected.

SELF-TIMER

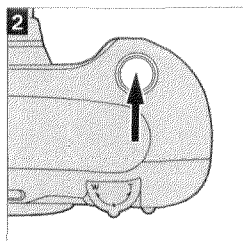
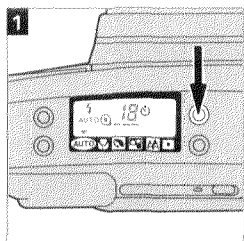

1 Set up the picture. Press the drive/operating-mode button until the self-timer indicator blinks in the data panel.

2 When you are ready to take the picture, press the shutter-release button all-the-way down.

- The indicator will blink for two seconds before the self-timer is selected.
- The self-timer indicator in the data panel and the lamp on front of the camera blink to show that self-timer is operating. There is a 10 sec. delay before the picture is taken.
- Self-timer mode is canceled after the picture is taken. To stop self-timer operation before the picture is taken, turn off the camera or move the zoom control.



CONTINUOUS-DRIVE MODE

Continuous-drive mode is recommended for taking sequence shots of moving subjects.

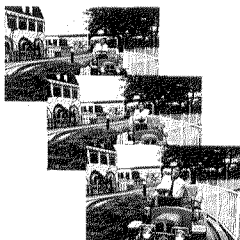
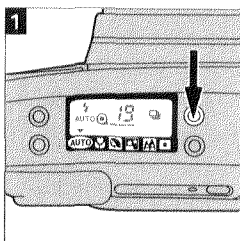

1 Press the drive/operating-mode button until the continuous-drive indicator blinks in the data panel.

2 When you're ready to take pictures, press the shutter-release button all-the-way down and hold.

- The indicator will blink for two seconds before continuous-drive mode is selected.
- The shutter will continue to release as long as the shutter-release button is held down. When taking flash pictures, the shutter will release after the flash has charged.
- To cancel continuous-drive mode, press the drive/operating-mode button until the indicators disappear from the data panel or turn off the camera.



DOUBLE EXPOSURE

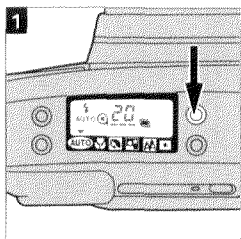

1 Press the drive/operating-mode button until the double-exposure indicator blinks in the data panel.

The indicator will blink for two seconds before double-exposure mode is selected.

2 Press the shutter-release button all-the-way down to take the first picture.

The double-exposure indicator and the film-transport mark blink to show that one picture of the double exposure has been taken. If the camera is turned off after the first picture is taken, these will continue blinking when it is turned on again.

3 Recompose your picture and press the shutter-release button all-the-way down again to take the second picture.

- Double-exposure mode is canceled after the second picture has been taken.

- If you have the DATE model, please select the "No imprinting" mode (see page 33).

For best results, use a dark background.



REMOTE CONTROL

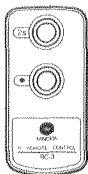

Optional accessory IR Remote Control RC-3 is required for the use of remote-control mode.

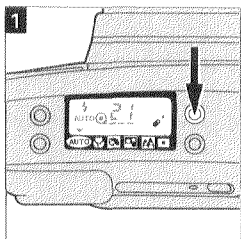

1 To select remote-control mode, press the drive/operating-mode button until the remote-control indicator blinks in the data panel.

To cancel remote-control mode, press the drive/operation-mode button until the indicators disappear from the data panel or turn off the camera.

- The indicator will blink for two seconds before remote-control mode is selected.
- After selecting remote-control mode, please refer to the remote control's manual for operating instructions.

FOR OWNERS OF THE DATE MODEL

The data back enables you to record the date, in a choice of three formats, or the time directly onto the film. It features a quartz clock and automatic calendar through the year 2019, and automatically controls the imprint exposure according to the camera's film-speed setting.

Names of Parts

- ① Print indicator
- ② MODE button
- ③ SELECT button
- ④ ADJUST button

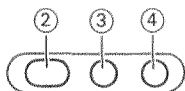

MODE SELECT ADJUST

Mode Selection

Use the MODE button to change the data display as shown.

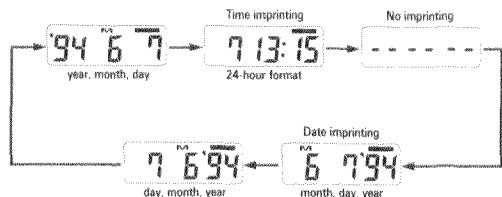

Care and Storage

This unit is designed for use between 40° and 0°C (104° and 32°F). At temperatures above or below this range, LCD and imprinted date may become difficult to read. Even higher temperatures may cause the LCD to temporarily blacken.

Data Imprinting

Press the MODE button to select the desired data type, then take the picture.

Following exposure, the print indicator blinks in the data panel for approximately two seconds to confirm imprinting.

- The imprinted data may be difficult to read if the subject area over which it is superimposed is bright or non-uniform.

Setting Data

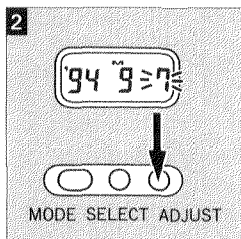
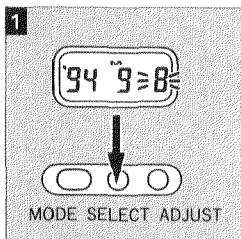

1 Use the SELECT button to move between different parts of the displayed data.

With the date displayed, pressing the SELECT button successively causes the settings for year, month, and then day to blink.

In time mode, pressing the SELECT button successively causes the hour, minute, and then the colon to blink.

2 Press the ADJUST button to change the blinking display.

In time mode, pressing the ADJUST button while the colon is blinking synchronizes the seconds counter to 00.

Battery Replacement

The quartz data back uses a 3V lithium battery (CR1220) to maintain memory while the camera batteries are being changed. Replace the quartz data back battery if the display changes or becomes dim while the camera batteries are removed.

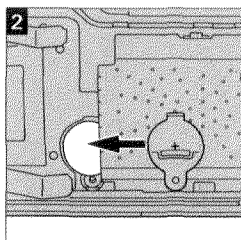
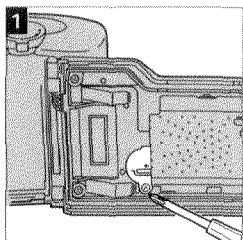

1 Open the camera back. Remove the screw from the battery cover using a small Phillips screwdriver.

2 Insert the new battery (+ side up). Replace the battery cover and attach with the screw.

After battery replacement, follow the instructions under **Setting Data** to reset day and time.

CARING FOR YOUR CAMERA

Cleaning

- If the lens becomes dirty, clean it gently with a lens brush. If necessary, moisten a sheet of lens tissue with one drop of lens-cleaning fluid and gently wipe the lens. Never put the lens-cleaning fluid directly on the lens. Never touch the lens surface with your fingers.
- Never use alcohol or chemical solvents on the camera body. If it is dirty, wipe it gently with a soft, clean, dry cloth.

Precautions

- Use extra care when taking pictures at the beach. Do not let the camera get wet and do not let sand or other grit get into the camera. This could result in costly or irreparable damage to the camera.
- This camera is designed for use between -10° and 40°C (14° to 104°F).
- Never subject the camera to shock, high heat, or humidity.
- Never push or pull on the lens barrel — this could result in damage.
- This camera contains high-voltage circuits. Do not attempt to disassemble or repair it yourself.

- Using the camera at very low temperatures impairs its performance. In cold weather, carry the camera inside your coat to keep it warm. Do not transfer the camera directly from an extremely cold to a warm area, since condensation may form inside and prevent normal operation.

Storage

- When not in use, keep the camera in a cool, dry place away from dust and chemicals. For extended storage we recommend that you place the camera in an airtight container with a drying agent such as silica gel.

- Do not store your camera in the glove compartment or other places in motor vehicles where it may be subjected to high temperatures.

Questions and Service

- If you have questions about your camera, contact your local camera dealer. For more information write to the Minolta distributor or subsidiary in your area (addresses listed at the back of this manual).

- To assure prompt service, please contact an authorized Minolta Service Center before shipping your camera for repairs.

- If all indicators blink in the data panel, remove the batteries and insert them again. If normal operation does not resume, contact an authorized Minolta Service Facility.

TECHNICAL DETAILS

Lens: 38-135mm f/3.5-9.2 power zoom lens; 8 elements in 7 groups (including 2 double-sided aspheric elements); max. magnification: approx. 1/4X (Macro mode, $f = 105\text{mm}$)

Focusing Range: 38mm: 0.8m (2.6 ft.) - ∞ ; 135mm: 0.65 (2.1 ft.) - ∞ ; Macro: 0.5m (1.6 ft.) - ∞

Metering Range (ISO 100): 38mm: EV 2.4-17 (f/3.5, 2.4 sec. - f/16, 1/500 sec.); 135mm: EV 4.4-17 (f/9.2, 4 sec. - f/20, 1/315 sec.)

Flash Range (ISO 100): 38mm: 0.8 - 5.5m (2.6 - 18 ft.); 135mm: 0.65 - 3.1m (2.1 - 10.2 ft.); Macro: 0.5 - 3.8m (1.6 - 12.5 ft.)

Batteries: 2 3V lithium batteries (CR123A)

Battery Performance: Approximately 23 rolls (based on Minolta's standard test method using 24 exposure film with flash 50% of exposures)

Viewfinder:

Magnification: 38mm: 0.40X; 135mm: 1.32X (subject at 4m)

Field of view: 84% (for subject at 3m)

Dimensions:

Standard model: 131.5 x 69.5 x 57mm
(5-3/16 x 2-3/4 x 2-1/4 in.)

DATE model: 131.5 x 69.5 x 61mm
(5-3/16 x 2-3/4 x 2-3/8 in.)

Weight (without batteries):

Standard model: 305g (10-3/4 oz.)

DATE model: 310g (10-15/16 oz.)

Specifications are based on the latest information available at the time of printing and are subject to change without notice.

This device complies with Part 15 of the FCC Rules. Operation is subject to the following two conditions: (1) This device may not cause harmful interference, and (2) this device must accept any interference received, including interference that may cause undesired operation. Changes or modifications not approved by the party responsible for compliance could void the user's authority to operate the equipment. This equipment has been tested and found to comply with the limits for a Class B digital device, pursuant to Part 15 of the FCC Rules. These limits are designed to provide reasonable protection against harmful interference in a residential installation. This equipment generates, uses and can radiate radio frequency energy and, if not installed and used in accordance with the instructions, may cause harmful interference to radio communications. However, there is no guarantee that interference will not occur in a particular installation. If this equipment does cause harmful interference to radio or television reception, which can be determined by turning the equipment off and on, the user is encouraged to try to correct the interference by one or more of the following measures:

- Reorient or relocate the receiving antenna.
- Increase the separation between the equipment and receiver.
- Connect the equipment into an outlet on a circuit different from that to which the receiver is connected.
- Consult the dealer or an experienced radio/TV technician for help.

This digital apparatus does not exceed the Class B limits for radio noise emissions from digital apparatus as set out in the Radio Interference Regulations of the Canadian Department of Communications.

Minolta Co., Ltd.	
3-13, 2-Chome, Azuchi-Machi, Chuo-Ku, Osaka 541, Japan	
Minolta GmbH	Kurt-Fischer-Strasse 50, D-22923 Ahrensburg, Germany
Minolta France S.A.	365, Route de Saint-Germain, F-78420 Carrières-Sur-Seine, France
Minolta (UK) Limited	Rooksley Park, Precedent Drive, Rooksley, Milton Keynes, MK13 8HF, England
Minolta Austria Ges. m.b.H.	Amalienstrasse 59-61, A-1131 Wien, Austria
Minolta Camera Benelux B.V.	Zonnebaan 39, P.O. Box 6000, NL-3600 HA Maarsse, The Netherlands
Belgium Branch	Kontichsesteenweg 38, B-2630 Aartselaar, Belgium
Minolta (Schweiz) AG	Redstrasse 6, CH-8953 Dietikon, Switzerland
Minolta Svenska AB	P.O. Box 9058, Albygatan 114, S-17109 Solna, Sweden
Finland Branch	Nillykatu 6 Pl. 37, SF-02201 Espoo, Finland
Minolta Portugal Limitada	Rua Afonso Lopes Vieira 55-B, P-1700 Lisboa, Portugal
Minolta Corporation	
Head Office	101 Williams Drive, Ramsey, New Jersey 07446, U.S.A.
Los Angeles Branch	11150 Hope Street Cypress, CA 90630, U.S.A.
Minolta Canada Inc.	
Head Office	369 Britannia Road East, Mississauga, Ontario L4Z 2H5, Canada
Vancouver Branch	230-3771 Jacombs Road, Richmond, B.C. V6V 2L9, Canada
Minolta Hong Kong Limited	Room 208, 2/F, Eastern Center, 1065 King's Road, Quarry Bay, Hong Kong, China
Minolta Singapore (Pte) Ltd.	10, Teban Gardens Crescent, Singapore 608923
Shanghai Minolta Optical Products Co., Ltd.	368 Minolta Road, Songjiang, Shanghai, China

© 1994 Minolta Co., Ltd. under the Berne Convention
and Universal Copyright Convention

Free Manuals Download Website

<http://myh66.com>

<http://usermanuals.us>

<http://www.somanuals.com>

<http://www.4manuals.cc>

<http://www.manual-lib.com>

<http://www.404manual.com>

<http://www.luxmanual.com>

<http://aubethermostatmanual.com>

Golf course search by state

<http://golfingnear.com>

Email search by domain

<http://emailbydomain.com>

Auto manuals search

<http://auto.somanuals.com>

TV manuals search

<http://tv.somanuals.com>