

Satellite TV

# Nomad 2 User Guide

v.1

 **MotoSAT**

LM-07.19.06

# NOMAD 2 UNIVERSAL CONTROLLER

## USER INSTRUCTIONS MANUAL

The NOMAD 2 Universal Controller gives an all new meaning to the word *simplicity* with its easy one step process. This revolutionary product will bring satellite TV technology to new heights.

### Table of Contents:

NOMAD 2 Bill of Materials (Packaged Components).....	2
NOMAD 2 Specifications.....	2
Using the NOMAD 2 Universal Controller	
First Time Installation.....	3, 4
Test Dish Functions.....	3, 4
Explanation Display Options	
Front Panel.....	4
Button Operations (Find Satellite/Stowing the Dish).....	4
Dish Services and Their Assigned Satellites.....	4, 5
Front Panel LEDS.....	5
Operation Procedures .....	6
Explanation NOMAD 2 Hardware	
Rear Panel.....	7
Control Cable Wiring Diagram.....	7
Nomad Visual Setup Diagram .....	8
Trouble Shooting and Error Codes .....	9
Technical Support Info.....	9
Products Used with the NOMAD 2.....	10
Important Notes for Dish Network.....	11
Rain Fade Effect on Domes.....	12
Wiring Configuration .....	13
SYSTEM CONFIGURATION .....	14
Satellite Coverage Maps .....	15
Clearance Diagram .....	16
NOMAD 2 QUICK GUIDE .....	17
Warranty .....	18, 19

## **NOMAD 2 Universal Controller Bill of Materials:**

The NOMAD 2 Universal Controller Systems (when shipped with a mount of choice) are shipped with the following components:

Components shipped with NOMAD 2 Controller:

- NOMAD 2 Universal Controller
- 12 VDC 4 AMP Power Supply
- NOMAD 2 Universal Controller User Manual

Components shipped with your mount of choice:

- 30' Control Cable
- 30' Coax Cable



## **NOMAD 2 Universal Controller Specifications:**

- 10 7/8" Wide by 7" Deep by 1 1/16" Height
- Voltage Requirements: 12VDC 4 AMP power supply (supplied)

## Using the NOMAD 2 Universal Controller

- **Dish Pro 500 (300,500,800) Series Receiver(s) are a required component when using the Model MD500.**

### First Time Installation:

- 1- Plug in all necessary cable connections to the back of the NOMAD 2 (see diagram on pg. 8). **Note:** Plugging the receiver and NOMAD 2 controller into an independent power strip is recommended.
- 2- Connect coax from NOMAD 2 to Mount.

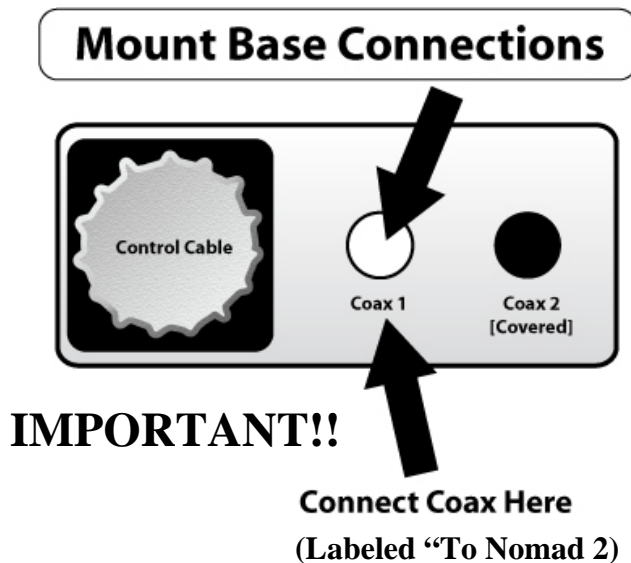

- 3- Set the satellite mode to which service you are using by using the Quick Guide for DirecTV, Dish Network, Etc. You will also need to know whether or not your unit is a *non-skewable* unit [Executive, Freedom], or a *skewable* unit [MD500, MHDTV]. To get into the satellite mode selector, have the Nomad power off, hold both the 'Find' and 'Stow' buttons down and hit the Power Button, continue to hold down the Find and Stow button for an additional 5 seconds after power is on. Let go at this point and the front display lights will show the current satellite mode of the unit. Use the 'Find' and 'Stow' buttons to cycle through the light patterns until the desired configuration is shown. Turn the 'Power' off to store the programmed settings. [See page 14 Satellite Mode Guide and page 17 Quick Guide for configurations and more detailed instructions]

4- To run the “**MANDATORY**” Test Dish function, hit the power button, wait 10 seconds for the Nomad to finish the startup sequence then, press the ‘Find’ and ‘Stow’ buttons simultaneously. This procedure must be performed following a configuration change.

The purpose of the “**MANDATORY**” test dish:

- A- Automatically determines if the non-skewable mount is a Dome or Open Face dish.
- B- Checks to ensure proper working order of all (Elevation, Azimuth, Skew) motor functions.

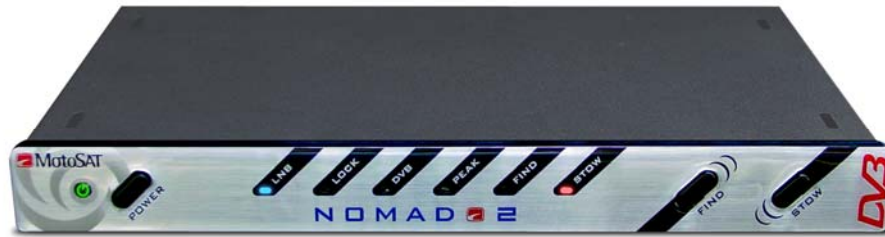

### NOMAD 2 UNIVERSAL CONTROLLER “FRONT” PANEL

#### BUTTONS:

##### FIND: (Find Satellite)

Pressing the Find button will begin the dish “search” to locate and lock onto the “main” satellite.

**For non-skewable single LNB dishes** pressing the Find button, while on satellite enables you to switch between multiple satellites. For example:

Pressing the find button while locked onto:

- Dish Network will toggle between satellites 110 and 119.
- Dish Network International East will toggle between satellites 61.5, 110, and 119.
- Dish Network International West will toggle between satellites 110, 119 and 148
- Bell ExpressVu will toggle between satellites 82 and 91.

#### Dish Services and their Assigned Satellites

1. Dish Network – Can use satellite(s) 110 & 119 [also 61.5 and 148]
2. DirecTV – Can use satellite(s) 101
3. Bell ExpressVu – Can use satellite(s) 82 & 91

**To initiate a REPEAK – *Skewable Mounts ONLY*** - Pressing the Find button, when “on satellite” and the signal strength shows weakness, will re-peak the dish for a higher signal quality when using the twin LNB skewable dish model(s) MD500 or triple LNB MDHDTV **ONLY**. (**Note:** Single LNB non-skewable dishes “re-peak” during satellite transition.)

**STOW: (Stowing the Dish)**

Pressing this button returns the dish to its stowed or travel position.

**LED’S:**

**LNB:** When lit, this LED indicates the coax cable from the receiver has been correctly connected to the NOMAD 2 Universal Controller, and the receiver has power. (**Note:** The LNB LED is illuminated once the coax cable of the receiver has been connected, but does **NOT** indicate the Controller has power).

**LOCK:** When lit, this LED indicates the “strongest” or “highest” signal strength of the satellite has been achieved and is locked onto the desired satellite.

**DVB:** When lit, indicates the DVB is actively locking onto the satellite

**PEAK:** When lit, this LED indicates the dish has found a signal and is adjusting for the “strongest” or “highest” signal strength of the satellite.

**FIND:** When the “Find” button has been pressed, the Find LED will blink until a satellite has been identified and can establish a connection. Once the satellite has been identified, the Find LED will remain solid. (The Stow LED also blinks indicating motor movement.) If the Nomad 2 is locked onto a satellite with a skewable dish, pressing the “Find” button again will activate a re-peak routine which will verify the dish alignment to the satellite for optimum signal level for the skewable dishes (MD500 for Dish Network and MHDTV for DirecTV). Pressing the Find button on non-skewable dishes (Dome and Executive) allows you to switch between satellites.

**STOW:** When the “Stow” button has been pressed, the Stow LED will blink indicating motor movement as the dish is being stowed. Once the dish has been stowed, the Stow LED will remain solid for a short period of time and then the power will automatically turn off.

## OPERATION PROCEDURES

### TO FIND A SATELLITE

#### **If the Mount Type is SKEWABLE (Models MD500 and MHDTV)**

1. Turn ON power.
2. After 10-15 seconds (after Nomad power up sequencing) press the FIND button.

**The dish will search out and lock onto the proper programmed satellite.**

3. Pressing the FIND button while on satellite will initiate a re-peaking sequence.

#### **If the Mount Type is NON-SKEWABLE (Executive (One LNB))**

1. Turn ON power.
2. After 10-15 seconds (after Nomad power up sequencing) press the FIND button.

**The dish will search out and lock onto the proper programmed satellite.**

3. Pressing the FIND button while on satellite will initiate a 'FIND NEXT SATELLITE' routine.

#### **If the Mount Type is a NON-SKEWABLE FREEDOM (using the Nomad 2)**

1. Turn ON Power.
2. If **ON** a Satellite when turning the Power ON, the system will search for the next available satellite in sequence.
3. If **NOT ON** a Satellite, the system will search for the primary satellite for the service subscribed to.
4. Once the system has located a satellite, the Power will turn OFF.

When Power is turned ON the system will go through steps 1-4 above.

### TO STOW THE DISH

1. Press the STOW button and the dish will stow, or return, to the proper travel position.

**After the dish has been properly stowed, the power will automatically turn OFF.**

## NOMAD 2 UNIVERSAL CONTROLLER “REAR” PANEL

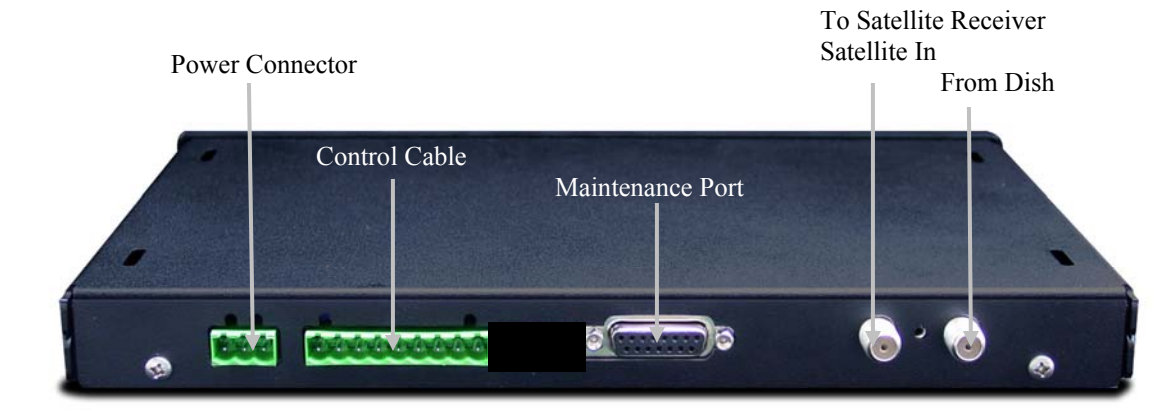

**Power Supply Interface:** Is used to connect the 12 VDC **4 AMP** power supply to provide power to the NOMAD 2 Universal Controller. (**Note:** Only use the power supply provided by MotoSAT or a power source known to have at least a 4 Amp min.)

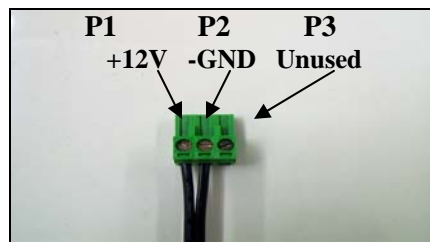

**Control Cable Interface:** Connects the mount by way of a 9 pin conductor cable to the NOMAD 2 Universal Controller. The cable is color coordinated for exact connection configuration. (See Figure Below)

**Wiring to 9 Pin Control Connector**  
Black-Brown-Red-Orange-Yellow-Green-Blue-White-Purple  
(Purple is only used on Skewable Mounts, and not required on Non-Skewable Mounts)

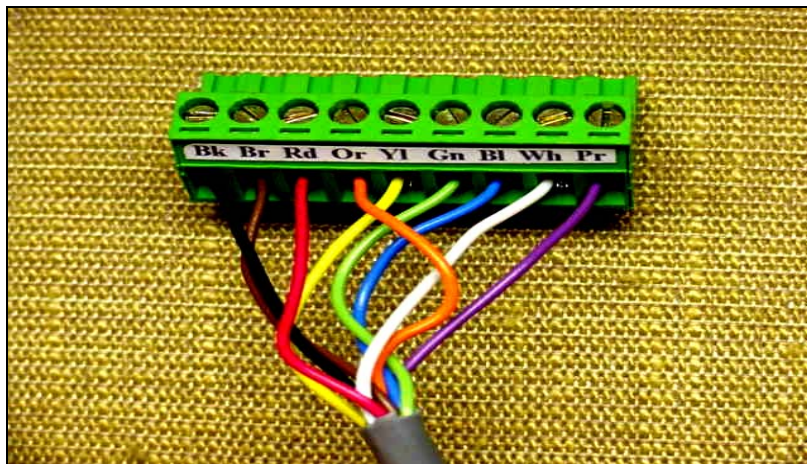



**Serial Port:** Used to provide software upgrades.

**From Dish:** Coax connection from the dish to the NOMAD 2 Universal Controller.

**To Satellite “IN” on Receiver:** Coax connection used to connect the NOMAD 2 Universal Controller to the satellite/LNB connection on the satellite receiver.

### **NOMAD 2 VISUAL SETUP DIAGRAM**

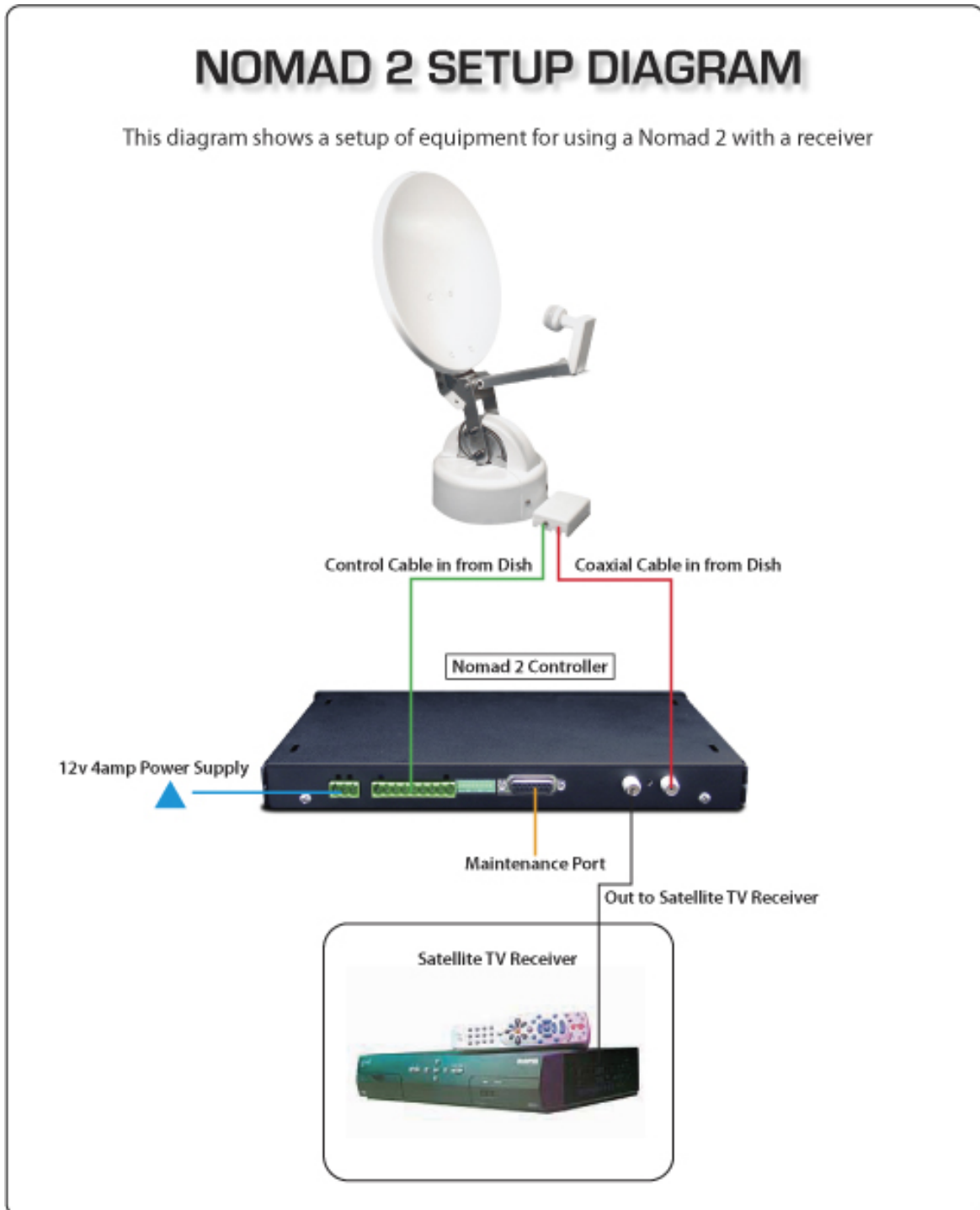

# TROUBLESHOOTING

**ERROR CODES ARE FLASHING LED LIGHTS AT 1 SECOND INTERVALS**

**Stow Flashing:** This is not an error but motors moving.

**Find Flashing:** Invalid Mode Dome and Skewable.

**Find and Stow Flashing:** Invalid Mode.

**Peak Flashing:** Motor Time Out. No counts Elevation.

**Peak and Stow Flashing:** Motor Time Out. No counts Azimuth.

**Peak and Find Flashing:** Motor Time Out. No counts Skew.

**Peak, Find and Stow Flashing:** Limit Error Elevation.

**DVB Flashing:** Limit Error Azimuth.

**DVB and Stow Flashing:** Limit Error Skew.

**DVB and Peak Flashing:** Only Main sat found.

**DVB, Peak and Stow Flashing:** Main sat not found but Secondary sat found.

**DVB, Peak, Find and Stow Flashing:** Signal lost NO LNB Power

**Lock Flashing:** No satellite found.

**Lock and Stow Flashing:** Over Temperature on Satellite Receiver.

**Lock and Find Flashing:** Dish did not raise high enough.

**Lock, Find and Stow Flashing:** Coax cables on backward.

**Lock, Peak, Find and Stow Flashing:** Could not find main sat after Skew.

**Lock and DVB flashing:** EEPROM failure.

**Lock, DVB and Stow flashing:** AGC Control Failure.

**NOTE: Before calling Technical Support please perform a “Test Dish” and press “Find” one more time before calling.**

## Technical Support

- **MotoSAT Customer/Technical Service** – (1-800-247-7486) - Available Mon-Fri 9:00 a.m. to 5:00 p.m. Mountain Standard Time.

- Please have your MotoSAT Model # and Satellite Receiver Brand prior to calling Customer/Technical Support.

# MotoSAT Products that use the Nomad Controller

## Non-Skewable Mounts



**FREEDOM**



**EXECUTIVE [1 LNB]**

## Skewable Mounts



**MD500 [2 LNB]**



**MHDTV [3 LNB]**

# Special Notes

## **Stowing the dish when all else fails.**

**If you are able to go onto the roof -**

1. Unplug the “Green” 9 pin connector from the back of the NOMAD 2.
2. Go to the roof where you can apply a slight amount of force to move the dish into an acceptable position for traveling.
3. Call Tech Support when you get to a location that you can perform trouble shooting.

**If you are unable to go onto the roof –**

The dish can be manipulated by applying 12 volt DC power to specific wires in the control cable located in the back of the NOMAD 2. The 12 Volts going to your NOMAD 2 controller (3 pin “green” connector) can be used as this source.

1. **ELEVATION** - Orange and Red wires (reversing polarity will change direction.)
2. **AZIMUTH** - Black and Brown (reversing polarity will change direction.)

**If a chain or motor/gearbox assembly is broken, the dish will have to be stowed by hand.**

## **Dish Network receivers**

**NON-SKEWABLE Dome or Open Faced mounts.**

If your satellite receiver is a Dish 500 or Dish Pro and you remove it from your home to your RV, you will need to perform a “Check Switch” **while the non-skewable dish is in the STOWED POSITION**. Your screen upon completion of the “Check Switch” should have 8 X’s in the check boxes meaning that the “Check Switch” failed. This procedure must be accomplished ***before*** you “FIND” satellite. **Failure to do so will result in improper operation of the receiver.**

# RAIN FADE ON DOME SYSTEMS

Read all about it.....

Subject: **Rain fade on Domed (Covered) Systems**

What is rain fade? Rain fade is signal degradation due to the interference of rain droplets. Rain can affect performance as well as heavy water content thunder clouds. Satellite frequencies have a great deal to do with degradation. C band satellite frequencies have the best resistance to rain fade, KU band satellite frequencies have the next best performance, and KA band frequencies are the most susceptible to rain fade. Rain fade is also known as *rain attenuation*.

There are quiet a few examples of rain fade or degradation.

1. There is heavy rain (large droplets); it can block the uplink channels for reception.
2. There is heavy rain that can block the receive signal to the satellite.
3. There is also moisture build-up on the dome or cover.

Unfortunately, all these examples are caused by acts of nature, that with a domed system you will always experience all of the symptoms in varying degrees. There are things you can do to reduce degradation.

1. If you live in Seattle, move to Arizona.
2. Get a big fan, point it towards the sky and blow the clouds away.
3. KEEP YOUR DOME CLEAN- Soap and water are the most efficient methods. Some harsh or abrasive cleaners can be harmful to the outside of the dome as well as signal interference. NOTE: Some types of cleaners as well can eventually collect dirt. Be sure to select one that will work for you.
4. After rain, wipe the water droplets off the Dome.
5. A bigger dish size and superior surface accuracy reduces rain fade problems.

All domes on the market are susceptible to rain fade. MotoSAT's Dome (aka Mini Dome) as well as the T2 AutoMotion are the two domed satellite television systems that have the lowest rain degradation on the market. Because of size and surface accuracy of our dish, MotoSAT can offer the best performance in rain fade situations.

You're Staff at MotoSAT

## WIRING TABLE

### Open Face TV Mounts

The Control Cable, 9 conductors, colored coded, 22Awg stranded that connects to the mount with a twist lock connector is configured in the following manner:

Color Code	Pin Designation	Mount Destination	Counts per Degree
Black	1	Motor, Azimuth Positive	
*Brown	2	Motor, Azimuth/Skew Negative	
*Red	3	Motor, Elevation/Skew Positive	
Orange	4	Motor, Elevation Negative	
Yellow	5	Sensor, Count Azimuth	3.408
Green	6	Sensor, Ground Azimuth/Elevation	
Blue	7	Sensor Count Elevation	5.034
White	8	Power, Mount LED	
**Purple	9	Sensor, Count Skew	8.500

\* The Brown and Red wire perform a dual function when used on a Skewable (MD500/MHDTV) mount. They control the Skew motors when directed by the Nomad 2 Controller. Applying 12 volt power directly to these wires will skew the dish.

\*\*The Purple cable is for use on skewable dishes but it WILL NOT effect the operations of a non-skewable dish when it is connected (or not connected).

The Mount is coil wrapped inside with the following cables and wire:

2 ea RG179 Teflon coated coax cables (can do four (4) if required)

1 ea Control Cable, 9 conductor cable, colored coded, 22Awg stranded. This cable is molded with a twist lock connector on one end and manually terminated at the other with a 9 pin connector.

2 or 4 ea RG179 coax cables terminate at the LNB to provide availability of cabling for multiple receivers.

1 ea Black and White 22Awg stranded wires carry the positive (white) voltage and ground (black) to the LED which is used to illuminate the dish face.

For any questions or comments please contact our  
**Technical Support Department** at 1-800-247-7486.



## Dish Network, Bell Express Vu Modes and Dishes

Use the "Find" and "Stow" Buttons to cycle through the various modes, press 'Power' to set the mode.



Dish Network *Non-Skewable* [Executive, Freedom] \*see page 10

Dish Network mode for non-skewable dishes.

(Will cycle between satellites, 110° and 119°, by pressing the 'Find' button while locked onto satellite.)

**NO LIGHTS**



Dish Network *Skewable* [MD500] \*see page 10

Dish Network Mode for the MD500

(Will see satellites 110° and 119° at the same time.)

**STOW LIGHT ONLY**



Dish Network International East *Non-Skewable* [Executive, Freedom] \*see page 10

Dish Network mode for non-skewable dishes

(Will cycle between satellites, 61.5°, 110°, and 119°, by pressing the 'Find' button while locked onto satellite.)

**DVB, PEAK, FIND LIGHTS ONLY**



Dish Network International West *Non-Skewable* [Executive, Freedom] \*see page 10

Dish Network mode for non-skewable dishes

(Will cycle between satellites 110°, 119°, and 148°, by pressing the 'Find' button while locked onto satellite.)

**LOCK LIGHT ONLY**



Bell ExpressVu *Non-Skewable* [Executive, Freedom] \*see page 10

Bell ExpressVu mode for non-skewable dishes

(Will cycle between satellites, 82° and 91°, by pressing the 'Find' button while locked onto satellite.)

**PEAK LIGHT ON ONLY**



Bell ExpressVu *Skewable* [MD500] \*see page 10

Bell ExpressVu for the MD500

(Will see satellites 82° and 91° at the same time.)

**PEAK AND STOW LIGHTS ONLY**

## DirecTV Modes and Dishes

Use the 'Find and 'Stow' buttons to cycle through the various modes, press 'Power' to



DirecTV *Non-Skewable* [Executive, Freedom] \*see page 10

DirecTV mode for non-skewable dishes

**FIND LIGHT ONLY**



DirecTV *Skewable* [MHDTV] \*see page 10

DirecTV mode for the MHDTV

(Will see satellite 101°)

**FIND AND STOW LIGHTS ONLY**

## Show Modes



*Skewable* Dishes \*see page 10

**DVB, FIND, AND STOW LIGHTS ONLY**



*Non-Skewable* Dishes \*see page 10

**DVB AND PEAK LIGHTS ONLY**

## Satellite Coverage Maps

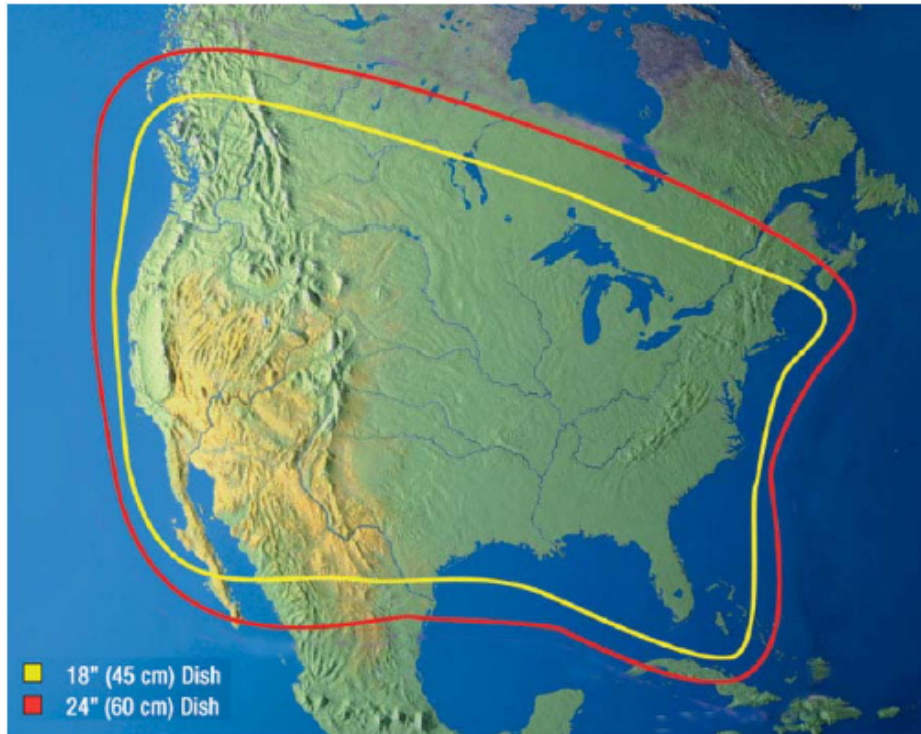

U.S. Services Available :  
• DIRECTV  
• DISH Network

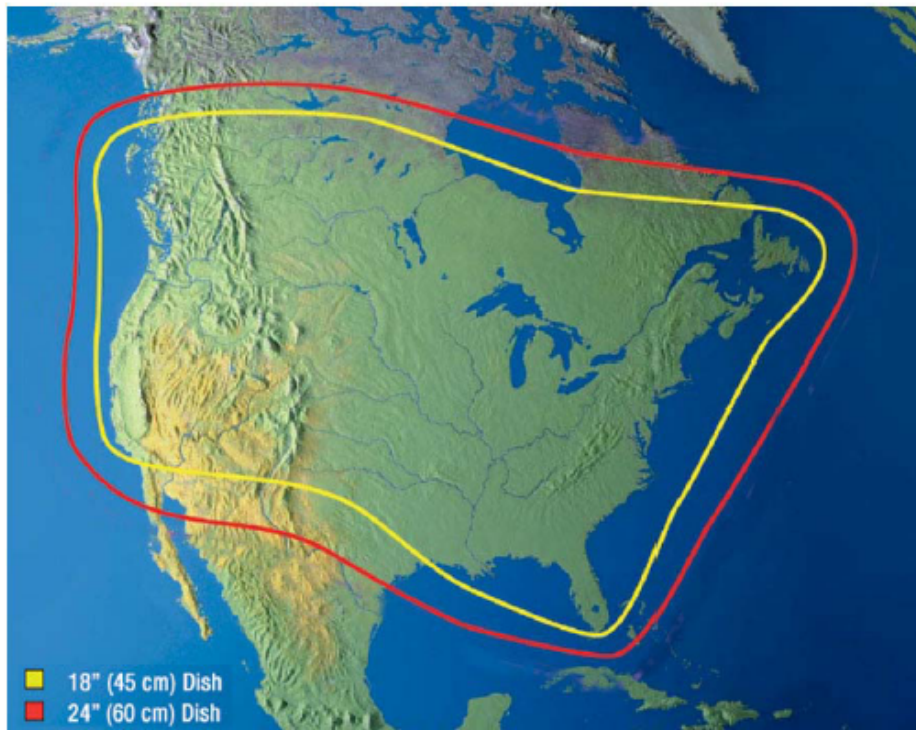

Canadian Service Available :  
• Express Vu



# IMD500™ & IMHDTV™

## CLEARANCE DIAGRAMS

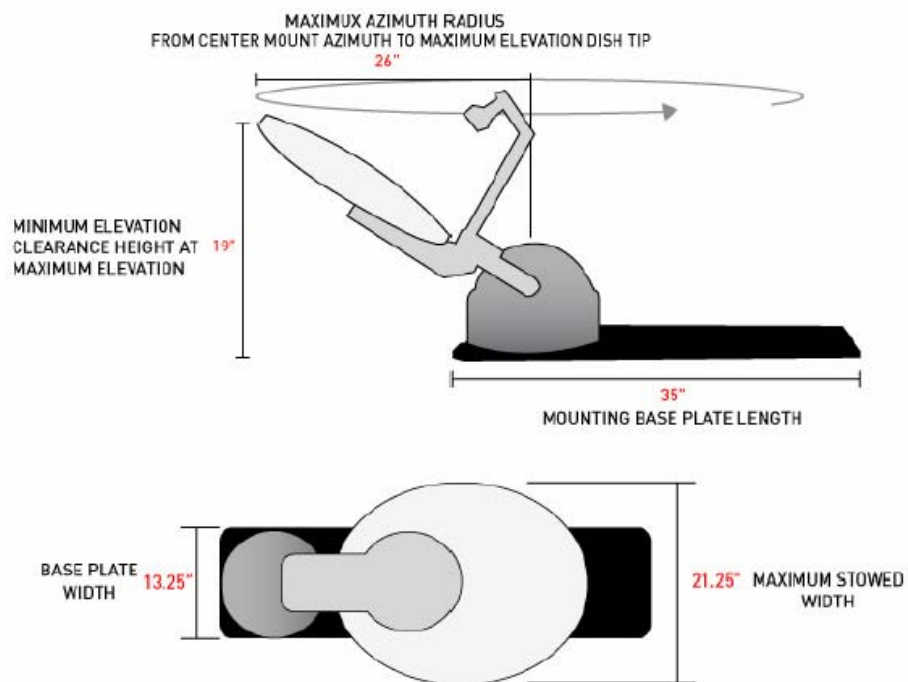

# Nomad 2 Quick Guide

We have introduced an exciting new product, the Nomad 2. It has incorporated all the features that you (the dealer and consumer) have asked for. We are excited about it and know that you will be also. To help you become familiar with the programming, and to assist you in the first turn on, we are offering this Quick Guide to programming.

*After all connections are made please take the time to read through this guide once and then follow each step as outlined:*

## **TO PROGRAM**

Step 1:

Make sure your Nomad 2 is turned OFF:

- Note: The Nomad 2 is OFF when the green light next to the power button is not lit.

Step 2:

Locate the FIND, STOW and POWER buttons on the Nomad 2:

- *Read the following steps carefully before beginning* –
  - With your right hand Press and hold down together the FIND and STOW buttons, while continuing to hold.....
  - **Use your left hand to Press the POWER button once and release**
  - Your right hand will continue holding down the FIND and STOW buttons for an additional 5-7 seconds.
- This will put the Nomad 2 into a Program Mode.

Step 3:

Refer to the diagram on page 14 in the Nomad 2 Manual to determine what Program Mode settings you will need for the type of MotoSAT system you have:

- Use the FIND or STOW button to navigate through the different settings on the front LED panel of the Nomad 2.
- When the light configuration on the Nomad 2 matches the selected diagram on the page 14, press the POWER button once to turn off the Nomad 2.
- This will store the configuration that you have set.

Step 4:

Turn on the Nomad 2 by pressing the POWER button. Wait 5-7 seconds for the Nomad 2 to perform startup sequences.

## **TO TEST DISH**

Step 5:

Complete a "Test Dish" by:

- Push both the FIND and STOW buttons at the same time.
- You will see the STOW light blink. It is indicating that the dish is moving.
- When the Test Dish is completed, the STOW light will stop blinking and go solid.

## **TO LOCATE SATELLITE**

Step 6:

Press the FIND button.

- This will locate your satellite(s) based upon the configuration settings that have been programmed.

Thanks for buying a MotoSAT product.

## Free Manuals Download Website

<http://myh66.com>

<http://usermanuals.us>

<http://www.somanuals.com>

<http://www.4manuals.cc>

<http://www.manual-lib.com>

<http://www.404manual.com>

<http://www.luxmanual.com>

<http://aubethermostatmanual.com>

Golf course search by state

<http://golfingnear.com>

Email search by domain

<http://emailbydomain.com>

Auto manuals search

<http://auto.somanuals.com>

TV manuals search

<http://tv.somanuals.com>