

ONLINE MANUAL FOR

The Stick™



RELAX. This is NOT rocket science.

About This Manual

We are serious about making the finest products on the market. And we are serious about the information you need to make the product function correctly.... but we can't get real serious about writing product manuals.

There are enough bad product manuals out there to sink an aircraft carrier. You've probably seen them-the ones that take a degree in Electrical Engineering to figure out, or they are written in every language except English or... they are just plain boring.

Our humor or wit (or lack of either) in the rhetoric of this manual is not put here to lessen any aspect of the product except maybe the painful task of getting through some very dry material. Thanks.

Something You Should Know Now That You Have Purchased Our Product-

You are the most important person in the world and we at Multi-Link want to THANK YOU for your business. We can't say it enough! At one time in America, business was conducted face to face where a word and a handshake were good enough. While we seldom get the opportunity to personally meet and thank the people who buy our products, we realize your purchase of The Stick(tm) is a vote of confidence and trust in our product and our company. We will not betray this confidence or trust-that is our word and handshake to you. You are the backbone of our business.

The ultimate goal we, as a company, have targeted is your satisfaction. We want you as a customer and a commitment to your complete satisfaction AFTER THE SALE is our pledge. If at any time you have a problem, comment or question about The Stick (tm), its operation, functions or features - call us at 1 800 535 4651. We want to hear from you. And again, THANKS for the opportunity to do

THE STICK OPERATING MANUAL Table of Contents

SAFETY INSTRUCTIONS	
1 HOW THE STICK WORKS	1
1.1) Programmable Features	1
1.2) Standard Features	4
2 PROGRAMMING THE STICK	6
2.1) Programming and Quick Reference Guide	7
2.2) Initial Check, Power Up, Connect To The Phone Line.	8
3 THE “HOW TO” OF PROGRAMMING	9
3.1) Tones / Programming Commands	10
3.2) Overview of Programming	11
3.3) Audible “Read Back” of Programming	12
4 POINTERS FOR HOOK-UP OF VOICE/DATA EQUIPMENT	14
4.1) FAX / PC Fax Cards	14
4.2) Answering Machines	16
4.3) Computer Modems	17
4.4) Other Stuff	18
5 INSTALLATION- Introduction	19
5.1) On Single Phone Line	21
A) Simple Plug-In	21
B) Simple Plug-In W/Extensions	22
C) “Barge-In Protection” For Simple Plug-In W/Extensions ..	22
D) Not-So-Simple In Line Installation	24
5.2) On Multiple Phone Line System	25
A) Key System or PBX	25
B) RJ-14 Two Line Phone System	26
6 MOUNTING THE STICK	28
7 TECHNICAL SPECIFICATIONS	29
8 FCC/DOC/LIMITED WARRANTY	30



IMPORTANT SAFETY INSTRUCTIONS

When using your telephone equipment, basic safety precautions should always be followed to reduce the risk of fire, electric shock and injury to persons, including the following:

1. Read and understand all instructions.
2. Follow all warnings and instructions marked on the product.
3. Unplug this product from the wall outlet before cleaning. Do not use liquid cleaners or aerosol cleaners. Use a damp cloth for cleaning.
4. Do not use this product near water, for example, near a bathtub, wash bowl, kitchen sink or laundry tub, in a wet basement, or near a swimming pool.
5. Do not place this product on an unstable cart, stand, or table. The product may fall causing serious damage to the product.
6. This product should never be placed near or over a radiator or heat register. This product should not be placed in a built-in installation unless proper ventilation is provided.
7. This product should be operated only from the type of power source indicated on the marking label. If you are not sure of the type of power supply to your home, consult your dealer or local power company.
8. Do not allow anything to rest on the power cord. Do not locate this product where the cord will be abused by persons walking on it.
9. Do not overload wall outlets and extension cords as this can result in the risk of fire or electric shock.
10. Never push objects of any kind into this product through cabinet slots as they may touch dangerous voltage points or short out parts

that could result in a risk of fire or electric shock. Never spill liquid of any kind on the product.

11. To reduce the risk of electric shock, do not disassemble this product, but take it to a qualified serviceman when some service or repair work is required. Opening or removing covers may expose you to dangerous voltages or other risks. Incorrect reassembly can cause electric shock when the appliance is subsequently used.
12. Unplug this product from the wall outlet and refer servicing to qualified service personnel under the following conditions:
 - A) When the power supply cord or plug is damaged or frayed.
 - B) If liquid has been spilled into the product.
 - C) If the product has been exposed to rain or water.
 - D) If the product does not operate normally by following the operating instructions. Adjust only those controls, that are covered by the operating instructions because improper adjustment of other controls may result in damage and will often require extensive work by a qualified technician to restore the product to normal operation.

- E) If the product has been dropped or the cabinet has been damaged.
- F) If the product exhibits a distinct change in performance.

13. Avoid using a telephone (other than a cordless type) during an electrical storm. There may be a remote risk of electric shock from lightning.
14. Do not use the telephone to report a gas leak in the vicinity of the leak.

INSTALLATION INSTRUCTIONS

1. Never install telephone wiring during a lightning storm.
2. Never install telephone jacks in wet locations unless the jack is specially designed for wet locations.
3. Never touch uninsulated telephone wires or terminals unless the telephone line has been disconnected at the network interface.
4. Use caution when installing or modifying telephone lines.

"SAVE THESE INSTRUCTIONS!"

1 INTRODUCTION

Congratulations! You have purchased the highest quality voice/fax/modem call processor in the industry-The Stick! This manual has been designed to get you, your communications devices and The Stick operating on the phone line with a minimal amount of work. Please read this manual carefully and BE SURE TO FILL OUT AND MAIL YOUR WARRANTY CARD!

HOW THE STICK WORKS

When installed on a phone line, The Stick automatically answers all inbound calls and “screens” for fax tones (CNG-Calling tones) and Security Access Codes (in the form of DTMF/touch tones). While performing the “screening” function for both types of tones The Stick is transmitting phone company-simulated “ringback”

tones to the calling party. After the screening function is performed, the call is routed to the proper device.

The Stick’s performance is dependent on how it is installed on a home or business phone line and what programmable features are activated. The next section explains the different features which optimize performance in particular installations.

1.1 PROGRAMMABLE FEATURES- Read This First!!!!

Fax Tone Detection-This feature, when activated, tells The Stick to detect the presence of CNG/fax tones which may be transmitted by a calling fax machine or PC Fax card. All calls accompanied by CNG tones, whether they be from a fax machine or PC Fax card, are routed through to equipment connected to the device port labeled FAX. If no

fax-type equipment is used on The Stick, simply deactivate this feature. Factory preset is “on”.

Protected Hook Flash-This feature allows The Stick to be compatible with certain multi-line KSU phone systems. Some KSU systems do not allow touch tones (DTMF tones) to be generated from a telephone key pad after an inbound call has arrived. With Protected Hook flash "on" the phone system can be “fooled” into generating touch tones by striking the flash key. Calls can then be manually transferred between devices by dialing the proper security access code. Factory preset is “off.”

Unanswered Call Silent Transfer-This feature was engineered for those of you who may receive manual fax or modem calls after normal business hours but do not use an answering machine. Manual fax calls (not accompanied by CNG fax tones) and modem calls usually wind up routed to the phone when the caller cannot execute the proper access code. With Unanswered Call Silent Transfer “on”, the inbound call (routed to the phone) will be switched over to a designated port (see Silent Transfer Destination) after the unanswered phone has been rung

the maximum number of rings. Factory preset is “off.”

Answering Machine Silent Transfer-This feature works like Unanswered Call Silent Transfer except that it is designed for calls of 45 seconds or less. It should only be activated when you are using an answering machine to field after-hours calls. When a manual fax or modem call arrives and the answering machine has answered, the caller will still be able to get to a destination device by staying on the line after the answering machine “times out”. If you answer a call and hang up before 45 seconds, The Stick will transfer the call to the designated device. Factory preset is “off.”

Silent Transfer Destination-After activating either Silent Transfer feature, you will want to tell The Stick where to route the call. The “Destination” program feature gives you the option of routing all after-hours calls to either the fax or modem. Factory preset is to the port labeled “FAX”.

Programmable Security Access Codes (SAC's)-Transfer of a call is executed by dialing the programmed SAC for each voice/data device

connected to The Stick. SAC's are programmable (using a touch tone **phone** only) up to 4 characters long- digits 0 through 9 and symbols * (star) and # (pound). The Stick will not detect SAC's dialed from "calling" pulse phones- only from touch tone phones. Call transfers dialed by a pulse phone are limited to phones hooked to or on the same line as The Stick and are limited to transfer to the "FAX" port only. The pulse dial SAC for this is fixed at "2". You must also have the "Pulse Detect" feature on if you use a pulse dial phone to transfer a call.

Do's and Don'ts Of SAC Programming

- 1 Digit Security Access Codes ARE NOT recommended. (Refer to "Programming" Section, page 9).
- DO NOT use the codes "9" "#", "# #", or anything beginning with "9" or "##" These codes are reserved for the "Call Grab" feature and programming access to The Stick, respectively.
- DO NOT select an access code that may be the first part of a dialed number or the control code of your answering machine.

Factory preset Security Access Codes are as follows:

	Touch Tone	Pulse Dial
VOICE 1 and VOICE 2 Ports-	*1	None
FAX Port-	*2	2
MODEM Port-	*3	None

Pulse Detection-The Pulse Detection feature, when activated, allows The Stick to detect the factory preset code "2" and "Call Grab" preset code "9" when dialed from a pulse dial phone. The factory preset for this feature is "off."

Rings To Answer-This feature directs The Stick to answer an inbound call after a programmed number of rings (0 to 10 rings) from the phone company. If RTA is programmed to "0", The Stick will answer the call during the first ring. Extension phones elsewhere in your location will only "chirp" the first ring before going quiet. If the RTA is greater than "0", The Stick will allow all incoming calls to ring extensions and devices connected to the ports labeled VOICE 1 and VOICE 2 for the programmed number of rings. Factory preset is 0 rings.

Call Override--With Call Override "on"-when The Stick "answers" a call and you pick up an extension more than one second later, The Stick will recognize the lifting of the handset and stop transmitting ringback tone to the caller. You can immediately begin to talk or (within 15 seconds) transfer the call to another device. In some areas of the country, your local telephone company's lines and switching equipment may cause this feature to not function properly. Just deactivate the feature. (See the "Call Grab" feature explanation in the Standard Features section for another option to Call Override.) Factory preset is "off."

Maximum Rings--This feature allows you to program the number of rings transmitted to your phones/answering machine, fax and modem by The Stick. Maximum Rings can be programmed anywhere from 4 rings (minimum) to up to 30 rings. Factory preset is 8 rings to all equipment.

Unrestricted Manual Transfer--With the UMT feature "off," The Stick will only allow a manual transfer to be done during the first 15 seconds of an inbound call when answered from an extension. The UMT feature, when activated, enables a transfer to be executed from an

extension phone and by either party at any time during the call, no matter if the call is inbound or outbound. Of course, inbound calls answered by equipment through the VOICE 1 or 2 ports may be transferred at any time using the appropriate SAC, regardless of the setting for this feature. Factory preset is "on."

1.2 STANDARD FEATURES - No Programming Needed!

Barge-In Protection--When installed on an incoming telephone line before ALL telephone equipment (extension wall jacks or multi-line phone systems), The Stick will protect any voice or data call from being accessed by other telephone equipment on the same line. Any phone device that goes "off-hook" during a conversation or data transmission will receive a silent line.

Note: ***The Barge-In Protection feature will control only those phone/data devices connected directly to The Stick. For optimum performance and protection, it is recommended that all premise extension phones be wired into The Stick at either the Voice 1 or Voice 2 ports. Relax! This is not a difficult operation to perform. See the section titled "Installation Procedures" for the easiest way to get the job done.***

Call Grab-If the Call Override feature does not perform due to any line problems with your local phone service provider, this standard feature will allow you to override The Stick's tone detect and call routing operation. Call Grab can be initiated from any touch tone or pulse extension phone by dialing "9" on the telephone key pad. When "9" is dialed, The Stick will immediately cease its call routing function. This feature is standard and will work regardless of the status of the "Call Override" feature. Note: *YOU must enable the "Pulse Detect" feature if you want to grab a call from a pulse dial phone.*

Power/Call Status Light---The LED on the front of The Stick demonstrates two functions-when lit, it tells you the unit is powered up and while processing inbound and outbound calls, the LED signals which port is being used. A "one blink" pattern tells you a voice call is being processed, a repeating "two blink" pattern says The Stick has either detected CNG tones and is routing the call to your fax machine or a fax is outbound. A repeating "three blink" pattern denotes the proper security access code has been monitored and a caller has been routed to your

computer modem or data is being transmitted outbound from your computer modem.

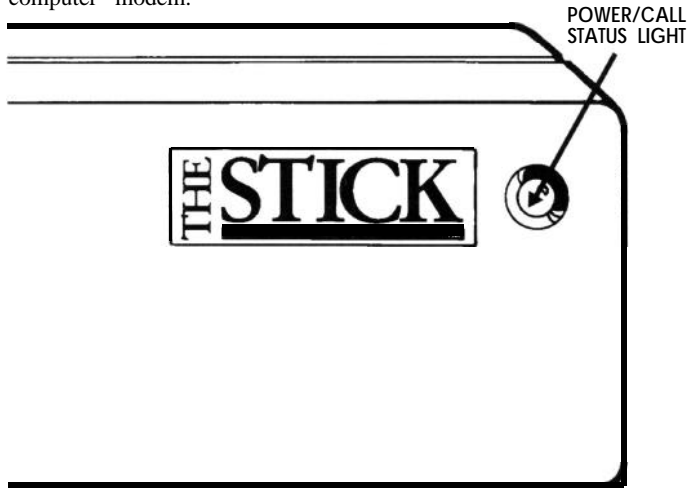

2

PROGRAMMING THE STICK

The average consumer usually starts to freak when they open up any product manual and see the word “PROGRAMMING”. We have all experienced “programming” anxiety with VCR’s, computers, fax machines . . . whatever. Relax. This is relatively painless. All you have to do is understand each programmable feature and how you want The Stick to operate in your chosen installation.

On the next page is the Programming and Quick Reference Guide. This table was developed as an easy reference/record for program features with corresponding Register Number, programming range of each feature, the factory preset of each feature (how The Stick works “out of

the box” if you don’t bother to program anything), program recommendations for certain types of installations and finally, a space for writing down what you’ve done (or what you want The Stick to do).

Please use the Programming and Quick Reference Guide. Mark on it. Highlight it. If you can’t remember which Register Number controls which feature. . . refer back to it. And take a tip from us, pencil in how you have programmed all the features. It will save you some time and frustration.

We advise you to read through the Programmable Features section again if you are not quite sure of how you want The Stick to operate.

THE STICK PROGRAMMING AND QUICK REFERENCE GUIDE

REGISTER #	PROGRAMMABLE FEATURE	PROGRAM RANGE	FACTORY PRESET	PROGRAMMING / INSTALLATION RECOMMENDATIONS	YOUR PROGRAM
01	FAX Tone Detection	0 = off 1 = on	ON	Regardless of how you install the Stick, if a FAX/PC FaxCard is used—Program this feature “ON”	
02	Protected Hook Flash	0 = off 1 = on	OFF	With older KEY and PBX systems, you may need to program this feature “ON”	
03	Unanswered Call Silent Transfer	0 = off 1 = on	OFF	“UCST” routes all unanswered after-hours calls to fax or modem ports (on any installation)—program “ON”	
04	Silent Transfer Destination	0 = fax 1 = modem	FAX	This feature determines what device will receive a call after it has been “silently transferred”	
05	Pulse Detection	0 = off 1 = on	OFF	If you have pulse-dial phones and wish to transfer or “grab” a call—program this feature “ON”	
06	Call Override	0 = off 1 = on	OFF	If The Stick is installed at a walljack and you want to answer a call from any extension phone—program “ON”	
07	Unrestricted Manual Transfer	0 = off 1 = on	ON	Gives transfer ability at any time, from either party from any phone, recommended programming “ON”	
08	Answering Machine Silent Transfer	0 = off 1 = on	OFF	After answering machine times out, call will be routed to fax or modem port (any installation)—program “ON”	
11	Security Access Code for VOICE Ports	Digits 0-9 * and # 4 digits max.	*1	This register contains the code for transfer of a voice or modem call to devices connected to voice 1 & 2 ports	
12	Security Access code for FAX Port	Digits 0-9 * and # 4 digits max.	*2	This register contains the code for transfer of a voice or modem call to FAX/PC FaxCard CONNECTED to fax port	
13	Security access code for MODEM Port	Digits 0-9 * and # 4 digits max.	*3	This code is usually sent by calling modem—we recommend programming a 4 digit code for security purposes	
14	Rings to answer	0 to 10 Rings	0 Rings	If the stick is used on a KSU or PBX set to “0” – home installs w/ext. phone access, program needed no. of rings	
15	Maximum rings	4 to 30 Rings	8 Rings	This feature controls the number of times a device (voice, fax, modem) is rung by the stick before dropping the call	

2.2 INITIAL CHECK

Included with The Stick are additional items that make life a whole lot easier. Please check the box and make sure you have:

- The Stick™ Voice/Fax/Modem Call Processor
- One 12 Volt Class 2 Power Source
- One Silver Modular Line Cord

If any of these items are missing, please alert the retailer from which you purchased the unit and also Multi-Link, Inc. at 1-800-535-4651

POWER UP

The first thing you must do before programming The Stick is to “power up” the unit. It is recommended that you choose a power outlet close to a

telephone wall jack. Plug the power supply (supplied) into the 110 volt outlet and insert the barrel plug into the port labeled :

**USE ONLY WITH
12 VAC 0.8-1.0A
CLASS 2
POWER SOURCE**

at the rear of the unit. The red light beside “The Stick” logo should be lit at this time.

CONNECTING TO THE PHONE LINE

Before programming The Stick, you will need to install it on your existing telephone line and connect a touch-tone (DTMF) telephone to the port labeled “VOICE 1” at the bottom of the unit. A silver Modular Line Cord has been supplied for connecting The Stick to a phone line. Plug one end of the line cord into the port labeled “LINE”. Plug the other end into a telephone wall jack. At this time you should hear dial tone when the handset on your touch tone phone is lifted off-hook.

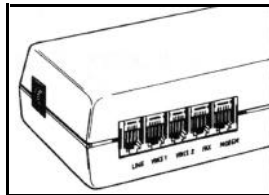

3 THE "HOW TO" OF PROGRAMMING

Now that you've gotten everything hooked up and in place, the fun begins! We advise that you read through this section once or twice for familiarity with the process. You may also want to refer back to the **Programming and Quick Reference Guide** table to pencil in selected programming values for each feature you wish to control.

The first thing you should do is place a local call to your best buddy. Ask him or her to lay their phone receiver down for a moment.... but don't hang it up. This will keep you from incurring any long distance phone charges or "freaking out" the local phone company with all the numbers you will dial to program The Stick.

After placing a call to your friend, wait at least five seconds before proceeding. First, DIAL "# # 7 7" on your telephone key pad. The LED light will begin blinking rapidly. Immediately listen for three rapid high-pitch beeps in **your handset. Three high-pitch tones indicate that**

you have entered the programming mode and may "PROCEED".

At this time, you should enter the **Register Number** of the feature you wish to program and proper value(s). If the proper register number and programming value(s) are entered, The Stick will answer with a high-pitch tone immediately followed by a mid-pitch tone. It kind of sounds like "bee-blip". This means "OK".

If the numbers you enter are invalid (either for the Feature Register or program value), The Stick will respond with a single low-pitch "ERROR" tone. This tone might remind you of the sound you hear when you "blow it" on your favorite video game.

In either case, three rapid high-pitch tones will immediately follow telling you to "PROCEED". At this time you may either access and program a new feature register or correct the previous attempt by entering new numbers.

3.1 Summary of the types of tones you will hear.

“PROCEED”-Three high-pitch tones in rapid succession tell you The Stick is ready to program a register or receive more commands in the form of touch tones. “Bee-Bee-Beep”

“OK”- (or “Okay” for you purists)-One high-pitch tone immediately followed by a mid-pitch tone means that the numbers that you have entered are acceptable and within range for the Register Number and feature value. "Bee-Bip"

“ERROR”- A single low-pitch tone indicates that the Register Number, feature value or program commands (we talk about those next) you have entered are invalid. Common errors committed when programming could be:

- Entering the **Register Number** for a feature, let's say it's “Protected Hook Flash”, and you enter only part of the number. The Register Number for “Protected Hook Flash” is “02”. If you enter "2" The Stick will give you an “ERROR” tone.
- Entering a feature value that is outside of the program range. As an example, we will use “Protected Hook Flash” again. You are only

allowed to program this feature value as “0” (off) or " 1” (on). If you enter the number “2” after the correct Register Number, The Stick will give you an “ERROR” tone.

PROGRAMMING COMMANDS-

Save To Memory/Exit-After programming all feature values you wish to manipulate, you will need to save the program to memory and exit the programming mode. This can be done by dialing “80”. At that time you will hear the “OK” tone twice. The LED will go back to normal operation. Even if there is a power loss to The Stick, all programming is saved.

No Save/Exit-If you wish to “dump” any programming you've done and exit the programming mode, dial "90" At that time you will only hear the “OK” tone once. The LED will go back to normal operation.

Set Registers To Factory Preset-This command sets all program registers to the factory presets (refer to the Programming and Quick Reference Guide). When you dial "60" all registers automatically revert

to factory preset. The Stick will answer with an “OK” tone followed immediately by a “PROCEED” tone. Dial “80” to save and exit.

3.2 An Overview of Programming

This is “the big picture” for how to program The Stick.

Being the good consumer you are, you’ve read the manual thoroughly (NOT!), penciling in the feature changes on your **Programming and Quick Reference Guide**. You call your mom (a local call) and ask her to lay the phone down for a moment while you program this neat new call processor you’ve just purchased. She says OK.

You’ve decided to reprogram the Security Access Code for the MODEM port, turn the “**Unrestricted Manual Transfer**” feature off and turn the “**Pulse Detect**” feature on.

1) Since five seconds has more than elapsed since you initiated the call to your mom, you can enter the programming mode. You dial “##77” on your touch tone phone connected to the “VOICE 1” port.

The Stick Response: Answers with a “PROCEED” tone. The LED is blinking very rapidly. You have 30 seconds to begin the next command.

2) You change the SAC for the MODEM port to “007” by dialing 13007. “13” selects Register 13 (Security Access Code for MODEM port) and 007 is the new SAC.

The Stick Response: Answers with an “OK” tone, then a “PROCEED” tone. You have 30 seconds to begin the next command.

3) You change the “Unrestricted Manual Transfer” feature to “OFF” (factory preset “ON”) by dialing 070. “07” selects Register 7 and “0” turns the feature off.

The Stick Response: Answers with an “OK” tone, then a “PROCEED” tone. You have 30 seconds to begin the next command.

4) You change the “Pulse Detect” feature to “ON” (factory preset “OFF”) by dialing 051. “05” selects Register 5 and “1” turns the feature on.

The Stick Response: Answers with an “OK” tone, then a “PROCEED” tone. You have 30 seconds to begin the next command.

5) You have finished programming the desired feature changes and wish to save them to nonvolatile memory and exit the programming mode. You dial “80”.

The Stick Response: Answers with the “OK” tone twice. The LED returns to normal blinking which demonstrates that your touch tone phone connected to the “VOICE 1” port is off-hook.

Check and see if your **mom** is on the other end of the line. If not, hang up the phone.

*NOTE: If The **Stick does not receive a command within 30 seconds, it will give you an “OK” tone and exit the programming mode without saving any programming. Basically it is acting as if you have dialed "90" (See section titled **Programming Commands.**)***

3.3 AUDIBLE “READ BACK” OF PROGRAMMING-BEEP BEEP BEEP-BOOOOOOOP!

There is a programming command that allows The Stick to audibly “read back” (via the phone) the values of any program register. This feature is handy when you forget what you have just programmed and want a quick read back or checking to see if a feature is (de)activated before leaving your home or office.

There are two types of tones that The Stick will transmit through your receiver on the audible “read -back”:

*A clipped, high pitched “bip” which has a numerical value of one.

*A long, low pitched “beep” which has the numerical value of five.

The chart below describes the audible tones which coincide with each number or symbol in a register.

NUMBER/SYMBOL	AUDIBLE TONES
1	"BIP"
2	"BIP BIP"
3	"BIP BIP BIP"
4	"BIP BIP BIP BIP"
5	"BEEP"
6	"BEEP BIP"
7	"BEEP BIP BIP"
8	"BEEP BIP BIP BIP"
9	"BEEP BIP BIP BIP BIP"
0	"BEEP BEEP"
*	"BEEP BEEP BIP"
#	"BEEP BEEP BIP BIP"

Executing Audible “Read Back” With The Stick:

First, you must enter the programming mode by dialing “##7 7”. Then press “*” and the Register Number you wish to read back.

An example:

***First, you press “# # 7 7” on your touch tone phone to enter the programming mode.**

***The Stick responds with a “PROCEED” tone.**

***You press “* 0 5” (telling The Stick to audibly read back the value in Register 5).**

***The Stick transmits 2 ‘Beeps’ signifying the value “0” (the feature is turned off).**

***After a short pause, The Stick will transmit an “OK” tone followed by a “PROCEED” tone.**

***At that time you may either “read back” or program any register.**

For Registers Containing More Than A Single Value

Some registers can (or are required to) contain more than a single value, i.e., Registers 11 to 15. Here’s a short example of what a “read back” would sound like where more than 2 digits or symbols are programmed in the register. Let’s say the register you want to “read back” is number 13, the Security Access Code for the MODEM port, and it is programmed as “* 7 5”:

***You first enter programming (# # 7 7).**

***Press “* 1 3” to “read back” Register 13.**

***The Stick transmits “Beep Beep Bip (pause) Beep Bip Bip (pause) Beep”. (Equivalent to * 75).**

Stick immediately transmits the “OK” and “PROCEED” tones.

Note: You will receive an “Error” tone when entering an incorrect Register Number on audible “read back”. Never fear-try again!

4 POINTERS FOR HOOK-UP OF VOICE/DATA EQUIPMENT

This section involves the connection of communications equipment to The Stick. You may configure the “hook up” of different types of equipment in a number of ways. Whatever suits your operational needs and your installation requirements!

Although each device port is labeled with generic titles designating what equipment would connect to what port, YOU CAN CONFIGURE IT ANY WAY YOU LIKE! Just be sure to read this section thoroughly before trying anything weird (that might not work).

4.1 FAX MACHINES AND PC FAX CARDS

The Stick has special features that make it work extremely well with either a PC FAX Card or a FAX machine. The feature that enables The Stick to route an incoming FAX call to your “FAX” type device is **“FAX Tone Detection”**.

What’s a “FAX Tone”?

In a nutshell, most FAX machines generate a tone when they are operated “automatically”. Automatic generally means you just drop the paper(s) to be faxed in the document carriage, the machine loads it, the desired phone number is entered, you hit the “START” button and you’re done. The machine automatically dials the number and begins emitting the tone (commonly known as CNG or AUTO-FAX tone) to identify itself as a FAX-type device. This tone is continuously transmitted until the called FAX machine answers the call and “handshakes” with the sending

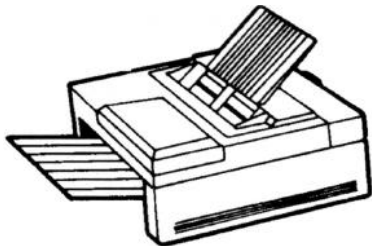

With The Stick at the receiving end, the call is “answered” and the FAX Tone is detected. At that time the call is routed to the port labeled “FAX”. Hence, we suggest if you use either a FAX machine or PC FAX Card connect it to the port labeled “FAX”.

From The ".....And Here's Another Curve Ball" File.

Sometimes people pick up the handset on their FAX machine and dial the phone number of the fax machine they want to connect with. By doing this they have told their FAX machine they want to use it for voice purposes only. No problem for the FAX machine.....but now it will **not** transmit any AUTO-FAX tones after dialing a phone number. If The Stick is at the receiving end, it will answer the call and detect the absence of FAX tones, assume it is a voice call and route it to the VOICE 1 & 2 ports.

When you answer the phone, the person at the other end will say, “I am trying to send you a FAX!” Of course you can manually transfer the call to your FAX by pressing *2 (or another code if reprogrammed). But before you do, we suggest you share the nugget of brilliant information

found in the preceding paragraph with your misguided (no pun intended) caller and suggest the next time they fax you, try calling without lifting the FAX machine handset. It will make everything a whole lot easier at both ends of the conversation.

PC FAX Cards And The Meaning of Life.....

If a PC FAX Card is connected to The Stick at the port labeled “FAX”, you should have no operational problems when a call is routed. There are about a half-a-million different types of PC FAX Cards on the market today and each has its own operational idiosyncrasies. If you do experience a problem, check the operations manual included with the PC FAX Card. If you can't figure the



problem out on your own, call our Tech Support **gurus**; they're **pretty sharp** about stuff like that.

4.2 ANSWERING MACHINES

An answering machine is an effective tool when used with The Stick. When connected to either "VOICE" port, the answering machine will field any unanswered voice calls, and via a message, provide instructions on how to access other equipment. A sample message might go something like this:

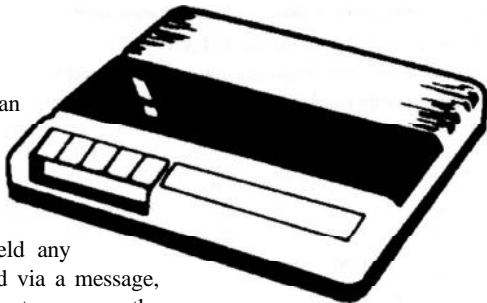

Hi! You have reached (Name/Company/Phone Number). We are not in right now, but if you wish to leave a message, wait for the beep. If you want to send us a FAX, press * 2 (or reprogrammed code). If you can't dial * 2 on your phone, just stay silent after

the beep and wait until the answering machine stops. You will then be transferred to the FAX automatically. Start your transmission when you hear our FAX signal. Thanks and have a nice day!

This message reflects the use of three programmable features-the **SAC for the FAX port, Answering Machine Silent Transfer** and **Silent Transfer Destination**. The SAC for transfer to the FAX machine is factory preset at *2 "Answering Machine Silent Transfer" has been programmed "on" and the "Silent Transfer Destination" used is factory preset to the "FAX" port.

Retrieving An Answering Machine Message-Most answering machines on the market today have factory preset "retrieval codes" for accessing a message from a remote phone. There is no special feature on The Stick for accessing your answering machine-just call your phone number, let the machine answer the line, and dial your "retrieval code". Again, we remind you to program all SAC's used for voice/data equipment differently from your answering machine "retrieval code".

4.3 COMPUTER MODEMS-

The Stick is compatible with all dial-up modems that use a “single pair” RJ-11 line cord to connect to a phone line. We suggest connecting the modem to the port labeled “MODEM” (we bet you’ve already figured that one out!). Most incoming calls to your modem are from remote (off location) computer modems. The Stick will route calls to your computer modem when the calling modem dials the proper SAC after The Stick has answered the call.

The “How To” Of Calling Your Modem-For any person to access your modem through The Stick, they must know your programmed Security Access Code for the “MODEM” port. Dialing your telephone number and SAC is done on the remote computer communications software. It should look something like this (for a HAYES-compatible modem):

```
1606 555 1234,,*3 |
```

The commas after the phone number are commands telling the modem to wait two seconds per comma before dialing the SAC *3. You should

instruct your friends to “time” a call to your residence. Tell them to count the seconds between the last digit dialed and the last ring to the phone before The Stick answers the call (how many rings before The Stick answers). Divide that amount of seconds by two and you have the needed number of commas between the phone number and SAC.

It is safe to repeat the SAC twice in the dialing string like so:

```
1 606 555 1234,,*3,,*3 |
```

Note that additional commas will need to be inserted between the SACs at the end of the dialing string. A minimum of 2 seconds between SACs is needed for The Stick to recognize and register the proper sequence of digits and symbols.

Some modems cannot dial the * and # symbols. You may want to reprogram a specific code for one time access by an outside caller.

Again, if you have any questions, call our [Tech Support line](#). They can help you out on timing or SACs.

4.4 OTHER STUFF THAT WORKS....

The Stick can operate on virtually all multi-line Key and PBX phone systems. We do recommend a specific type of installation for The Stick on either system. Refer to the section on [Installation page 25](#).

The Stick is also compatible with virtually all Credit Card Authorization Terminals, Point of Sale Terminals, Loop-Start dial-up TELEX machines, dictation machines, Answering Machines, cordless telephones, CALLER ID Display equipment- anything that requires a phone line to communicate.

If you have a CALLER ID Display device, we do recommend that it be installed on the telephone line BEFORE The Stick and the “[Rings To Answer](#)” feature be set for 2 or more rings. The data transmitted by the local telco, which identifies the calling party’s phone number, arrives between the first and second ring so it should register on the display device without a problem.

Services Offered by Your Local Telco-Most telephone companies are now marketing “Call Packages” that allow subscribers to customize their phone service in a multitude of ways. Most of the different services available are compatible with The Stick, but some may impede performance. Here are a few.

Call Waiting-The “beep” heard during a phone conversation, alerting you of another call, will not affect the performance of The Stick. However, pressing the hook switch to field a call will cause The Stick to do strange things....like inadvertently transferring a call to your fax machine. We do not advise having call waiting on the same line with The Stick.

Call Forwarding-The Stick’s automatic answering function (answer after a programmed number of rings) will not allow calls to be forwarded to another phone number. You may want to weigh the pro’s and con’s of using The Stick versus the Call Forwarding service.

5 INSTALLATION

This next section covers installation for The Stick in various configurations and applications. We have tried to cover virtually all installation, scenarios that may be found in the home and business. If we missed yours or you have something weird in mind for an installation-**please call**. Maybe we can help you out or save you some time and unneeded expense.

Where You Gonna Put It?

It really makes no difference if you are installing The Stick in a business or a home-the main considerations for installation really have to do with how you require The Stick to perform and what you are willing to do with it as far as installation requirements go. Below are the three main questions you should ask yourself:

- 1) Do You Require “**Barge-In**” Protection or Call Access From All Extensions?

- 2) **Is** There A Multi-line Phone System Present?

- 3) How Much Hassle and Expense Do I Want To Incur Installing The Stick?

How Do You Want It To Work?

To better understand the type of installation/placement that may be right for you, think of The Stick as either a “traffic cop” or a “personal secretary”.

!@&?)+!! **Traffic Cops!**

“Traffic cops” aren’t the most popular people in the world so we’ll keep this analogy short and sweet. If installed into the phone-line **BEFORE** all phone extensions, wall jacks, multi-line phone systems, etc., The Stick acts like a “traffic cop” at an intersection. All inbound call “traffic” is

intercepted by The Stick via its automatic answer feature and routed to its proper destination (i.e. phone, fax, modem).

The standard feature that makes this type of installation attractive is “**Barge-In Protection**” and The Stick’s ability to transfer a call between devices. If a voice call is answered and routed, only the phones will ring. If a call, accompanied by CNG, is answered and routed, only the fax machine will receive the call. Once a call is directed to its intended device, our “traffic cop” also keeps equipment connected to The Stick from “Barging-In” on the existing call.

Once again, for The Stick to perform in this manner, it must be installed on the phone line **BEFORE** all phone extensions, wall jacks or phone systems.

Your Own Personal Secretary

Everybody needs their own personal secretary to screen calls when they are busy with other things. If you install The Stick on the phone line by plugging it into a telephone wall jack, that is basically what you've got somebody to answer an incoming call and either:

A) tell you it is a voice call (by ringing the phone connected to a VOICE port) or

B) route it to the appropriate equipment.

Here’s the scenario-you are in the basement working one Saturday and the phone rings. Of course you hav 3 or 4 extension phones scattered about your palatial estate, and particularly, one in the basement. With The Stick plugged into a telephone wall jack upstairs, you have the option of either “grabbing” the call before The Stick does via the basement extension or allowing The Stick to answer the call and route it to the appropriate device.

This type of installation gives you the advantage of accessing an inbound call from any extension- but you lose “Barge-In Protection”. Manual transfers can still be executed from an extension phone if needed.

The Right Features For The Right Installation

In the next section, we have outlined different types of installations and included some recommendations for feature settings that should optimize

performance of The Stick for that particular installation. These are just recommendations. If you don't like the way it works-mutter something under your breath about "busybodies" and change feature settings. We don't mind.

5.1 INSTALLING THE STICK ON A SINGLE PHONE LINE

Single line installation is pretty much a no-brainer. If this is how your home or office is wired, then you should browse through each wiring configuration to find out the best one for your needs.

A) SIMPLE PLUG-IN (ONE WALL JACK, NO EXTENSIONS)

Pros: Great Barge-In Protection!
Easy Installation!

Cons: Fat Chance You'll Be Lucky Enough To Have This Wiring Configuration

*Simply unplug whatever is in the wall jack and connect the "LINE" input of The Stick to the wall jack with the supplied line cord.

*Reattach your phone to the VOICE 1 port and connect your answering machine and data equipment to their respective ports.

Feature Recommendations Pertinent To This Installation

- **Rings To Answer** - Set To "0". The Stick will answer the call immediately.
- If You Have A Pulse Dial Phone, Set **Pulse Detection ON**.

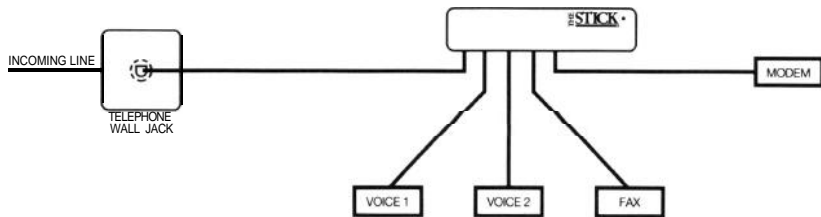

B) SIMPLE PLUG-IN WITH MULTIPLE EXTENSIONS

Pros: Can Access Calls From Extension Phones!
Easy Installation!
Installation Can Occur At Any Wall Jack.

Cons: No Barge-In Protection-Sorry!

*This installation is the same as the “Simple Plug-In, No Extensions”.
Connection to a telephone wall jack is the same.

Feature Recommendations Pertinent To This Installation

- *If any phones are pulse dial, program Pulse Detect ON.
- *If you wish to access a call from an extension phone prior to The Sticks answering, program the needed amount of rings in the “Rings To Answer” feature.
- *Program “Call Override” to ON for call access AFTER The Stick has answered a call.

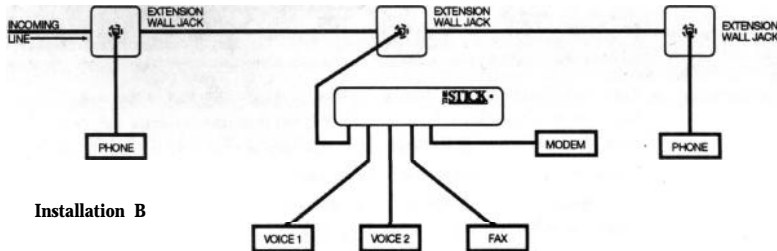

Installation B

C) SIMPLE PLUG-IN WITH EXTENSIONS AND TOTAL BARGE-IN PROTECTION

Pros: Provides Total Barge-In Protection.
Only voice calls will ring phone extensions.
The best installation for total control of inbound calls.

Cons: Calls cannot be accessed from an extension phone before The Stick answers.
Installation requires splitter/adapters (not included) and an extra line cord.
May need to do a little rewiring at each wall jack.

Most homes and businesses are wired with either 2-pair or 3-pair telephone cable from extension to extension. This installation with splitter/adapters utilizes the unused pair of wires in the cable to connect all phones to the VOICE 1 port.

- 1) The point of connection to the telephone line for The Stick can be at any extension wall jack. Unplug anything connected to this wall jack and plug a splitter/adaptor into the wall jack.
- 2) Plug one end of the supplied line cord into the port labeled "LINE" on The Stick and the other end in the "Line 1" port of the splitter/adaptor.
- 3) Connect the "VOICE 1" port of The Stick to the "Line 2" side of the splitter/adaptor using an additional line cord (not supplied).
- 4) At extension wall jacks located away from The Stick, unplug any phones from these jacks. Plug splitter/adapters in all wall jacks. Reconnect phones to the "Line 2" side of the splitter/adapters.

At any point "down line" from The Stick where it is impractical to insert a splitter/adaptor (for example: a wall mount telephone), this type of jack may be converted by:

- a) swapping the GREEN wire with the BLACK wire
- b) swapping the RED wire with the YELLOW wire

The phone can then be plugged into the converted jack.

Feature Recommendations Pertinent To Installation

*Set Rings To Answer to "0".

*If you are using Pulse dial phones at any point in installation, set Pulse Detection "ON".

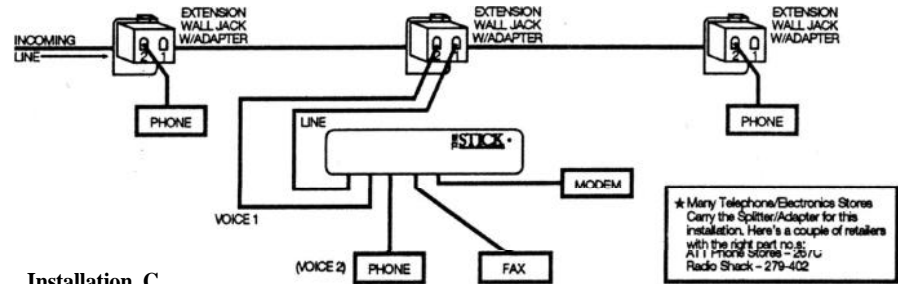

Installation C

D) NOT-SO-SIMPLE IN LINE INSTALLATION

Pros: Total **Barge-In Protection!**

Cons: You may require the services of a telephone installation guru.
Requires severing the phone line before all existing wall jacks and installing either modular plugs and an extra modular line cord

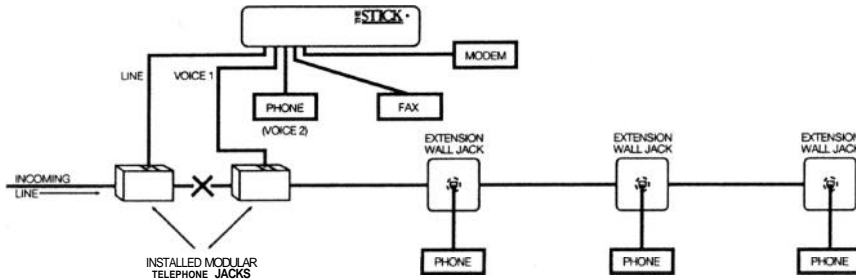

This one can be real difficult due to the materials required and the point of installation for The Stick. Remember, what we are trying to achieve in this scenario is “Barge-In Protection”. All voice calls are routed to all phones and fax and modem calls go to their respective devices-without one being able to access the other.

- 1) Find a point on the incoming phone line before all wall jacks or telephone equipment. Sever the phone line.
- 2) Install two modular wall jacks on each end of the severed phone line. Make sure you are using the correct pair of wires when connecting the severed phone line to the modular jacks.
- 3) Plug one end of the supplied line cord into the port labeled “LINE” on The Stick and the other end into the first modular wall jack. An additional line cord will be needed to connect the port labeled “VOICE 1” to the second modular wall jack.
- 4) From this location, additional wiring may need to be run to your fax machine and computer modem (if located in another room).

Feature Recommendations Pertinent To Installation

*Set Rings To Answer to "0"

*If you are using Pulse dial phones at any point, set Pulse Detection to ON.

5.2 INSTALLING THE STICK ON A MULTIPLE PHONE LINE SYSTEM

The Stick can be installed in a multiple line application where either an electronic phone system (KSU or PBX) or a 2 line phone configuration exists. Installing The Stick in these types of situations is a little bit more involved than the single line installations previously outlined. Review this section and if things get a little too hairy.....call a telephone installer, show him this section and save yourself a lot of time and hassle.

A) INSTALLING ON A KEY SYSTEM OR PBX

Pros: Great **Barge-In Protection!**

Cons: Installation is not for amateurs.

Requires you to run station wiring from The Stick to the fax machine and computer modem location.

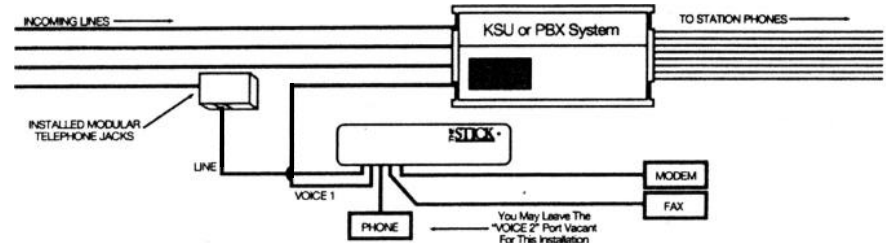

Installation of The Stick on a multi-line phone system should always occur at the "Trunk" side. "Trunk" is telephone nerd-speak for the side closest to the telephone company where incoming lines connect to the phone system. Confused... just look at the picture.

We recommend that if you have rollover from your phone company, install The Stick on the last line of the rollover sequence.

- 1) Unplug the chosen line from your KSU or PBX. A modular wall jack will need to be installed on that line close to the KSU or PBX if the plug is not RJ-11 modular. If the plug is RJ-11 modular, then it can be plugged directly into the "LINE" port of The Stick.

2) If a modular wall jack is installed, plug one end of the supplied line cord into the modular wall jack and plug the other end into the port labeled "LINE". An additional line cord will be needed for connection from the "VOICE 1" port to the KSU/PBX. From this point phone wire is run to the fax machine and modem.

Feature Recommendations Pertinent To This Installation

*Set Rings To Answer to "0"

*Set Protected Hook Flash to ON.

*If Pulse dial phones are used, set Pulse Detection to ON.

B) RT-14 TWO LINE SYSTEM (NO KSU)

Pros: Great **Barge-In Protection** For One Line

Cons: This installation is not recommended for even the gutsiest do-it-yourselfer!

The standard RJ-14 two line phone system utilizes "two pair" phone line. To install The Stick in this scenario, you will have to access the pair that controls the chosen phone line and install modular wall jacks for connection to the line.

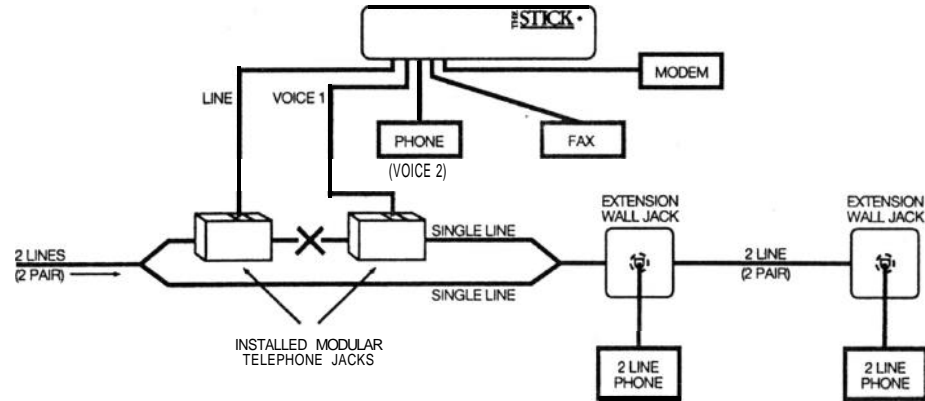

This can get really involved. Standard color pairings for telephone wiring are Red with Green, Black with Yellow and Blue with White. To physically see what pairs coincide with each phone number, you may need to chase the wiring back to the "demarcation" point (where telco wiring ends and residence wiring begins). Before you undertake such a sincere and monumental task, consider this

This wiring scheme has been the Waterloo of many an armchair telephone dude (or dudette). Either you or the wiring is going to win and odds are not in your favor. We strongly recommend- no, we beg of you- call a telephone installer for this one. Show your installer the picture on page 26 and/or ask him if he's got a better idea. He might.

Feature Recommendations Pertinent To Installation

- *Set Rings To Answer to "0".
- * Most two-line phones are not pulse dial, but if you happen to own the only pulse dial two line phone system in America, set Pulse Detect to ON.

6 MOUNTING THE STICK

The Stick can operate just about anywhere. Here are a few suggestions:

- a) mounted to a baseboard at the bottom of a wall,
- b) on a desk top beside your fax, phone or PC modem or
- c) tucked away underneath a desk.

Sticken' It To The Wall

We suggest using an adhesive double-sided mounting tape to keep

The Stick firmly attached to any surface. Keep in mind that the adhesive on the tape can be very strong. We recommend that you invest some thought into the best location before peeling back the cover and “going for it”.

Sticken' It On A Desktop

Anti-skid material works great to keep The Stick on a desk or counter top and off of the floor. We recommend this for people who might need to relocate The Stick at some time in the future.

7 THE STICK™ TECHNICAL SPECIFICATIONS

INPUT POWER REQUIREMENTS-

At AC Transformer: 110-125 Volts AC Only, 50-60 Hz
At Power Jack On Stick: 12-14 Volts AC and DC

POWER CONSUMPTION- 6.2 Watts

CO INTERFACE-

Ringer Equivalence Number: 0.5 B
Input Ring Detection: 40-150 Volts AC, 15-68 Hz

DEVICE INTERFACE-

Battery: -48 Volts Nominal DC To All Devices
Off-Hook Detection: 3-80 mA

Ring Generator Frequency: 30 Hz (+/- .1) Hz Voltage Regulated and Current Limited

Waveform: True Sinusoidal

Ring No Load: Approx. 82.8 Volts RMS AC

Ring 8000 Ohm Impedance (REN 1.0): Approx. 81.6 Volts RMS AC

Ring 4000 Ohm Impedance (REN 2.0): Approx. 73.0 Volts RMS AC

Ring 2667 Ohm Impedance (REN 3.0): Approx. 64.5 Volts RMS AC

Ring 2000 Ohm Impedance (REN 4.0): Approx. 55.0 Volts RMS AC

Ring 1800 Ohm Impedance (REN 5.0): Approx. 49.5 Volts RMS AC

8 FCC/DOC/REGISTRATION AND WARRANTY

FCC REGISTRATION

This equipment complies with Part 68 of the FCC rules. On the bottom of this equipment is a label that contains, among other information, the FCC Registration Number and Ringer Equivalence Number (REN) for this equipment. You must, upon request, provide this information to your telephone company.

The REN is used to determine the quantity of devices you may connect to the telephone line and still have all those devices ring when your telephone number is called. In most, but not all areas, the sum of the RENs of all devices connected to one line should not exceed five (5.0). To be certain of the number of devices you may connect to your line, as determined by the REN, you should contact your local telephone company to determine the maximum REN for your calling area.

If your telephone equipment causes harm to the telephone network, the telephone company may discontinue your service temporarily. If possible, they will notify you in advance. But if advance notice is not practical, you will be notified as soon as possible. You will be informed of your right to file a complaint with the FCC.

Your telephone company may make changes in its facilities, equipment, operations or procedures that could affect the proper functioning of your equipment. If they do, you will be notified in advance to give you an opportunity to maintain uninterrupted telephone service.

If you experience trouble with The S t i c k please contact your retailer or **Multi-Link, Inc.**, for information on obtaining service and repairs. The telephone company may ask that you disconnect this equipment from the network until the problem has been corrected or until you are sure that the equipment is not malfunctioning.

This equipment may not be used on coin service provided by the telephone company, and is not intended for use with a party line service. This equipment is intended for use only on loop start service, and will not operate on a ground start central office line.

DOC REGISTRATION

The Department of Communications label identifies certified equipment. This certification means that the equipment meets certain telecommunications network protective, operational and safety requirements. The Department does not guarantee the equipment will operate to the user's satisfaction. Before installing this equipment, users should ensure that it is permissible to be connected to the facilities of the local telecommunications company. The equipment must also be installed using an accepted method of connection. In some cases, the company's inside wiring associated with a single line individual service may be extended by means of a certified connector assembly (telephone extension cord). The customer should be aware that compliance with the above conditions may not prevent degradation of service in some situations.

Repairs to certified equipment should be made by an authorized Canadian maintenance facility designated by the supplier. Any repairs or alterations made by the user to this equipment, or equipment malfunctions, may give the telecommunications company cause to request the user to disconnect the equipment.

Users should ensure, for their own protection, that the electrical ground connections of the power utility, telephone lines and internal metallic water pipe system, if present, are connected together. This precaution may be particularly important in rural areas.

Caution: **Users should not attempt to make such connections themselves, but should contact the appropriate electric inspection authority, or electrician, as appropriate.**

The Load Number (LN) assigned to each terminal device denotes the percentage of the total load to be connected to a telephone loop which is used by the device, to prevent overloading. The termination on a loop may consist of any combination of devices subject only to the requirement that the total of the Load Numbers of all devices does not exceed 100.

Notice: This product has been tested and meets the Class B limits for radio noise emissions set out by the Radio Interference Regulations of the Canadian Department Of Communications.

LIMITED WARRANTY

To register your purchase, please fill out the warranty card and mail it.

We warrant that if The Stick Voice/pax/Modem Call Processor, manufactured by **Multi-Link, Inc.** and purchased by you, proves to be defective in material or workmanship, we will provide without charge, for a period of one (1) year (USA only), the labor and parts necessary to remedy any such defect. Warranty commences on the date of purchase by the original retail consumer.

The duration of any implied warranty of merchantability, fitness for a particular purpose, or otherwise, on this product shall be limited to the duration of the applicable express warranty set forth above. In no event shall we be liable for any loss, inconvenience or damage whether direct, incidental, consequential or otherwise resulting from breach of any

express or implied warranty, of merchantability, fitness for a particular purpose, or otherwise with respect to this product, except as set forth herein. Some states do not allow limitations on how long an implied warranty lasts and some states do not allow the exclusion or limitation of incidental or consequential damages, so the above limitations or exclusions may not apply to you.

To obtain service under this warranty, you must first request a RMA number from our technical support department. Present The Stick product with the RMA number and copy of a sales receipt (or credit card receipt) or other satisfactory proof of the date of the original retail purchase of the product to Multi-Link, Inc. or an authorized service repair center.

The AC power supply used with this product is covered under this warranty. This warranty does not cover damage which results from accident, misuse, abuse, improper line voltage, lightning strike, fire, flood, or damage resulting from unauthorized repairs or alterations performed by an unauthorized service center. This warranty gives you specific legal rights, and you may also have other rights which vary from state to state.

SERVICE INFORMATION FOR THE U.S. AND CANADA

Your machine has been registered with the Federal Communications Commission, and under this program, in the event of equipment malfunction, all repairs will be performed by Multi-Link, Inc. or a repair center we have authorized. The owner is restricted from performing any maintenance operation other than those specified within this instruction manual.

If you require -service, please contact Multi-Link, Incorporated at:

In Canada: Unit A1, 6120 – 2nd Street S.E.
Calgary, AB T2H 2L8
1-403-258-1646

In The U.S. 225 Industry Parkway
Nicholasville, **Kentucky 40356**
1-800-535-4651

SERVICE INFORMATION OUTSIDE THE U.S. AND CANADA

For units installed outside the U.S. and Canada, please contact your original point of purchase dealer for information regarding warranty and service.

MULTI-LINK INC.

*For more information and technical support
visit our website at www.multi-link.net*

Rev. 6/98

Free Manuals Download Website

<http://myh66.com>

<http://usermanuals.us>

<http://www.somanuals.com>

<http://www.4manuals.cc>

<http://www.manual-lib.com>

<http://www.404manual.com>

<http://www.luxmanual.com>

<http://aubethermostatmanual.com>

Golf course search by state

<http://golfingnear.com>

Email search by domain

<http://emailbydomain.com>

Auto manuals search

<http://auto.somanuals.com>

TV manuals search

<http://tv.somanuals.com>