Intelligent
Serial *Interface*

ISI4608-PCI & ISI4604-PCI
User Guide



User Guide

P/N S0000112, Revision C

Model ISI4608-PCI

This publication may not be reproduced, in whole or in part, without prior expressed written permission from Multi-Tech Systems, Inc. All rights reserved.

Copyright © 2001 by Multi-Tech Systems, Inc.

Multi-Tech Systems, Inc. makes no representation or warranties with respect to the contents hereof and specifically disclaims any implied warranties of merchantability or fitness for any particular purpose. Furthermore, Multi-Tech Systems, Inc. reserves the right to revise this publication and to make changes from time to time in the content hereof without obligation of Multi-Tech Systems, Inc. to notify any person or organization of such revisions or changes.

Record of Revision

Revision	Description
A (11/11/98)	Manual released. All pages at Revision A.
B (8/25/00)	Revised for ISI universal drivers and to include ISI4604-PCI.
C (5/8/01)	Info added on Win 2000, MTS Patent, Win Me, Novell, Linux, & regulatory matters.

TRADEMARKS

The Multi-Tech logo is a registered trademark of Multi-Tech Systems, Inc. Windows 2000, Windows NT, Windows 95, Windows 98, and Windows Me are registered trademarks of Microsoft.

Pentium is a registered trademark of Intel Corporation.

Contact Info	Patent Info
Multi-Tech Systems, Inc. 2205 Woodale Dr. Mounds View, Minnesota 55112, U.S.A. (763) 785-3500 (800) 328-9717 U.S. Fax: (763) 785-9874 Tech Support: (800) 972-2439 Internet: www.multitech.com	This device is covered by one or more of the following patents: 6,031,867; 6,012,113; 6,009,082; 5,905,794; 5,864,560; 5,815,567; 5,815,503; 5,812,534; 5,809,068; 5,790,532; 5,764,628; 5,764,627; 5,754,589; D394,250; 5,724,356; 5,673,268; 5,673,257; 5,644,594; 5,628,030; 5,619,508; 5,617,423; 5,600,649; 5,592,586; 5,577,041; 5,574,725; D374,222; 5,559,793; 5,546,448; 5,546,395; 5,535,204; 5,500,859; 5,471,470; 5,463,616; 5,453,986; 5,452,289; 5,450,425; D361,764; D355,658; D355,653; D353,598; D353,144; 5,355,365; 5,309,562; 5,301,274. Other Patents Pending

Contents

Chapter 1—Introduction and Description	5
Introduction to the IntelligentSerialInterface	6
Product Description	6
How to Use This Manual	7
ISI460x-PCI Applications	8
Technical Specifications	8
Computer Requirements	8
Physical/Electrical/Environmental	8
Chapter 2—Hardware Installation	11
Introduction	12
Safety Warnings Telecom	12
Hardware Installation Procedures	12
Chapter 3—Driver Installation	15
Introduction	16
Installing ISI460x-PCI Software for Windows 2000	17
ISI460x-PCI for Windows 2000: Installing ISI Management Software ...	24
Remove ISI460x-PCI Driver (Windows 2000)	26
ISI460x-PCI Software Install for Windows NT 3.51/4.0	26
Removing ISI4608x-PCI Card and Driver in Windows NT 3.51/4.0	29
I/O Addresses and IRQ Codes	30
ISI460x-PCI Software Install for Windows 95/98/Me	31
Removing the ISI460x-PCI Driver (Windows 95/98/Me)	35
NetWare Driver Installation	35
Configuring Ports for NetWare Connect	37
Removing the Driver (Novell)	37
SCO Open Server 5 Driver Installation	37
To install from CD-ROM:	37
To format a floppy disk for SCO5:	38
To untar the driver file and copy files onto floppy disk:	38
To install driver from floppy disk	39
MultiTech Installation Script	40
Activating Ports in SCO Open Server 5	43
Removing the Driver (SCO Open Server 5)	45

Chapter 3: Driver Installation (continued)

Linux Driver for Multi-Tech ISI460x-PCI Server Cards	45
LINUX: Pre-Installation Issues	45
LINUX: Copying the driver from the media	45
LINUX: Copying and untarring the driver from CD-ROM	45
LINUX: Copying and untarring the driver from a floppy	46
LINUX: Driver installation and loading	47
LINUX: Setting the baud rate	48
LINUX: Verifying the ports	48
LINUX: TTY Devices Created by the Drivers:	48
LINUX -- Dial-in configuration:	50
LINUX -- PPP setup:	50
Removing the ISI Driver (Linux)	51

Chap 4: Warranty, Service, & Tech Support 53

Warranty, Service & Tech Support 54

Limited Warranty	54
Addendum for North American Products	54
Addendum for International Products	55
Out of Warranty Repair Cost Charts	56
Upgrades and Product Support via Internet	56
Technical Support	56
Recording ISI460x-PCI Information	57
Software User License Agreement	57
On-Line Warranty Registration	59
About the Internet	59

Appendix A—Crossover Cable Wiring Diagrams 62

Appendix B—Regulatory Information 64

Index 67

Intelligent **Serial** *Interface*

Chapter 1—Introduction and Description



Introduction to the Intelligent *Serial* Interface

The **Intelligent *Serial* Interface** cards, model ISI4608-PCI and ISI4604-PCI, are hardware solutions for adding fast serial ports to communication servers and async hosts that have 32-bit PCI bus architecture.

Serial ports are essential to

- Communication servers that pool modems and other communication devices for users on a LAN and to
- Asynchronous hosts that provide user access through serial ports.

Each ISI4604-PCI card adds four serial ports to the computer; each ISI4608-PCI card adds eight serial ports to the computer. (From now on in this manual we will use “ISI460x-PCI” when referring to both models.) The ISI460x-PCI ships with drivers for the following multiuser operating systems: Windows® 2000 Server and Advanced Server, Windows NT, versions 3.51 and 4.0; Windows 95, Windows 98, and Windows Me.

The **Intelligent *Serial* Interface** card can be combined to support asynchronous serial devices (local or dial-up). The ports can be used to connect basic terminals with or without multiple pages of memory to multiplexer channels and asynchronous modems. Each ISI460x-PCI port can support as many screens as there are physical pages of memory on the terminal. In Windows NT, a built-in *autodetect* utility enables detection of Multi-Tech modems and sets the proper initialization strings.

This manual contains product specifications, installation instructions, and technical support information to assist you in the installation process. It is assumed you have basic PC skills. Therefore, we have not included step-by-step instructions for basic operations such as logging in and file editing, etc.

Product Description

The ISI460x-PCI is a multiport serial port expansion card that adds data buffering on each port for enhanced serial port performance. The ISI460x-PCI features an on-board microprocessor to coordinate the

communications activity of your local and remote terminals. Using the ISI460x-PCI to provide additional serial connections enables your system's processor to perform more efficiently since the ISI460x-PCI handles all byte-by-byte interrupts generated by asynchronous terminals and stores the data in buffers.

The processor, along with 256K bytes of RAM, work to allocate resources dynamically to the most active port. The ISI then generates one interrupt for an entire block of information and transfers the block to the system's microprocessor.

The ISI4608-PCI has one 78-pin (DB78S) connector that interfaces with an eight-port fan-out, or *octopus*, cable (supplied with the card), that provides eight additional serial ports. The ISI4604-PCI has a four-port fan-out cable (supplied with the card), that provides four additional ports. Both are 3/4 size add-on cards that support a high-speed interface up to 460 Kbps.

MultiTech's ISI Management Software is shipped with the ISI460x-PCI server card. It is designed to monitor data traffic and control the modems attached to the ISI460x-PCI card in a computer using Windows 2000 Server or Windows 2000 Advanced Server as its operating system.

How to Use This Manual

This manual presents installation procedures for the ISI460x-PCI card and for its software drivers. It contains information about technical support and warranty coverage, as well as appendices for wiring and regulatory matters. Hardware configuration and installation procedures are described in Chapter 2. Installing the ISI460x-PCI card also involves linking a driver to the operating system. This information is presented in Chapter 3.

Most of the steps listed in the driver installation section instruct you to press ENTER. This is a reference to the key commonly known as the Enter, carriage-return, or Return key. Also, please note the difference between the letter O and the number 0. Both the letter and the number may be used in this manual.

ISI460x-PCI Applications

The ISI460x-PCI is an ideal solution for adding ports when a powerful microcomputer used as a server or host lacks enough connectivity to accommodate the desired number of users. The ISI4608-PCI provides eight additional serial ports with every card installed, with a potential of four additional cards installed per system—for a total of thirty-two serial ports per system. The ISI4604-PCI provides four additional serial ports with every card installed, with a potential of four additional cards installed per system—for a total of sixteen serial ports per system.

Technical Specifications

Computer Requirements

- 386, 486, or Pentium®- based PC or compatible with PCI bus architecture
- Microsoft Windows 2000 Server and Advanced Server; Windows NT v. 3.51 and v. 4.0; Windows 95, Windows 98, and Windows Me; Linux (kernels 2.0, 2.2, and 2.4); SCO Open Server 5; Novell Netware.
- a CD-ROM drive (or, if software/drivers have been downloaded, a floppy drive)
- 100K bytes of hard disk space

Physical/Electrical/Environmental

- Dimensions: 6.875" x 4.2"
17.46 cm x 10.67 cm
- Baud Rates: 300 bps to 460 Kbps per port
- Bus Type: PCI
- Connectors: DB78S
- Cables: The ISI4608-PCI has an eight-port fan-out cable. DB78M (male) interface goes to card; eight DB25 (male) connectors are available for serial devices. The ISI4604-PCI has an four-port fan-out cable. DB78M (male) interface goes to card; four DB25 (male) connectors are available for serial devices.
- Serial Interface: For ISI4608-PCI, eight RS232C or RS232D ports for ISI4604-PCI, four RS232C or RS232D ports.

- Temperature: 32° to 120°F (0° to 50°C)
- Power: 0.1 amp @ +12v DC
0.1 amp @ -12v DC
1 amp @ +5v DC
- Base I/O Address: One 16-byte address space per card
- Interrupt Request (IRQ): One IRQ per card (can be shared)
- Warranty: Two years

Manufactured in Mounds View, MN, U.S.A.

Intelligent
Serial *Interface*

Chapter 2—Hardware Installation



Introduction

This chapter describes installation of the Multi-Tech ISI4608-PCI as an expansion card in your PCI bus computer.

Safety Warnings Telecom

1. Never install telephone wiring during a lightning storm.
2. Never install telephone jacks in wet locations unless the jack is specifically designed for wet locations.
3. This product is to be used with *UL* and *CUL* listed computers.
4. Never touch uninsulated telephone wires or terminals unless the telephone line has been disconnected at the network interface.
5. Use caution when installing or modifying telephone lines.
6. Avoid using a telephone (other than a cordless type) during an electrical storm. There may be a remote risk of electrical shock from lightning.
7. Do not use the telephone to report a gas leak in the vicinity of that leak.
8. To reduce the risk of fire, use only No 26 AWG or larger Telecommunication line Cord.

Hardware Installation Procedures

To install the ISI4608-PCI card into your PC-PCI bus computer:

1. Before handling the ISI4608-PCI, discharge any static in your body by touching a piece of grounded metal such as the computer chassis.
2. Carefully remove the ISI4608-PCI from its antistatic bag, handling it only by the mounting bracket and edges. Do not touch the gold-plated connectors along the bottom edge. (You may want to save packaging for possible future use.)
3. Visually inspect the ISI4608-PCI. If you have any concerns about its condition, call Technical Support at (800) 972-2439.

4. To avoid damaging the ISI4608-PCI card and your PC, make sure your computer and any peripheral equipment connected to it are turned off. The ISI4608-PCI can be installed in a PC-AT, 386, 486, or Pentium equivalent PCI bus computer.
5. Remove the cover of your computer as instructed in your computer's documentation.
6. Locate the unused PCI slot you will be using for your ISI4608-PCI card and remove the slot cover according to instructions in your computer's documentation.
7. Install the ISI4608-PCI card into the selected expansion slot in the same manner as any other add-on card, as instructed in your computer's documentation.
8. Fasten the retaining bracket to computer chassis and replace cover.
9. Attach the octopus cable to the DB78S female connector on the ISI4608-PCI card at the back of your computer. The RS232 ports on the octopus cable are for connecting to modems, multiplexers or other devices. If the other device is a local terminal port, a crossover cable (not included) is required between the octopus cable and the terminal port. See Appendix A for schematic of a crossover cable.

Note: *Any cables connected to the computer must be shielded to reduce interference.*

Intelligent **Serial** *Interface*

Chapter 3—Driver Installation



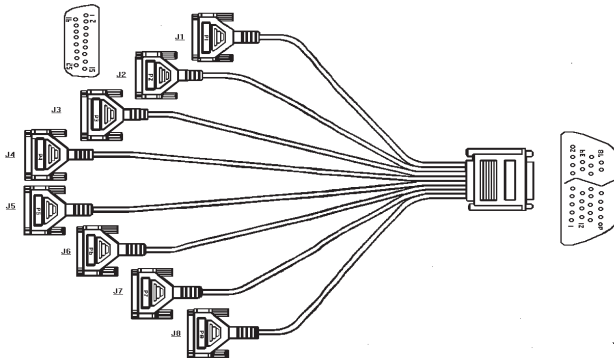

Figure 2-2. Octopus Cable

10. Turn on the power to the computer. You now are ready to install the software/drivers.

Introduction

The ISI460x-PCI ships with drivers for each of the following operating systems: Windows® 2000 Server and Advanced Server, Windows NT, Windows 95, Windows 98, Windows Me, Novell Netware, SCO Open Server, and Linux. This chapter describes the installation of these drivers. We also describe installation of MultiTech’s Management Software for use with ISI cards under Windows 2000.

Installing a device driver modifies your system. For this reason, only the *super user* (system administrator) is allowed to perform the installation. If you cannot login as **administrator**, find the person in your organization with this authorization (i.e., password). To begin driver installation, login as **administrator**. Then proceed with the appropriate installation section in this chapter.

Installing ISI460x-PCI Software for Windows 2000

NOTE: A series of 'installation wizard' screens will appear repeatedly during this procedure (step 12). This is not an error. Do not discontinue the procedure when the 'installation wizard' screens repeatedly appear.

1. Shut down Windows 2000 and turn off the PC.
2. Install the ISI460x-PCI card in an available PCI expansion slot in the computer. Follow the computer manufacturer's instructions concerning installation of expansion cards. Observe standard precautions regarding electro-static discharge (ESD) when handling the ISI460x-PCI board (the board should be kept in its shipping bag until used). During installation, handle the ISI460x-PCI circuit card by its edges and keep one hand in contact with the PC chassis.
3. Turn on the PC and start Windows 2000.
4. Insert the ISI driver CD-ROM into the CD-ROM drive (if drivers have been downloaded from the MultiTech web site, they will typically be on diskette; in that case, insert diskette into floppy drive).

5. Windows 2000 will detect the ISI460x-PCI card. The **Found New Hardware Wizard- Welcome** screen will appear.



Click **Next**.

6. The **Install Hardware Device Drivers** screen appears. Select "Search for a suitable driver ..." and click **Next**.



7. The **Locate Driver Files** screen appears (Windows 2000 is seeking the driver for the ISI460x-PCI card). Select “CD-ROM drives” and click **Next**.



8. The **Driver File Search Results** screen appears.

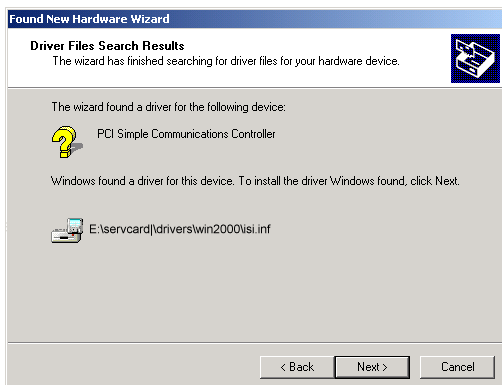

Click **Next**.

9. A progress screen will appear briefly while files are being copied.

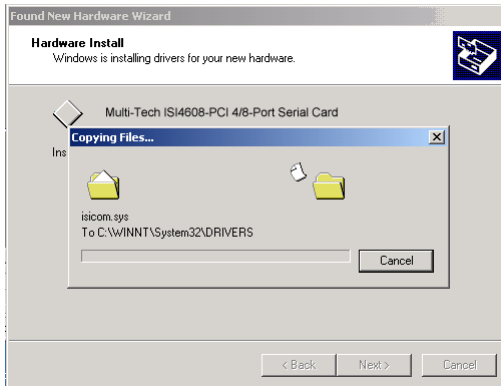

10. A completion screen will appear.

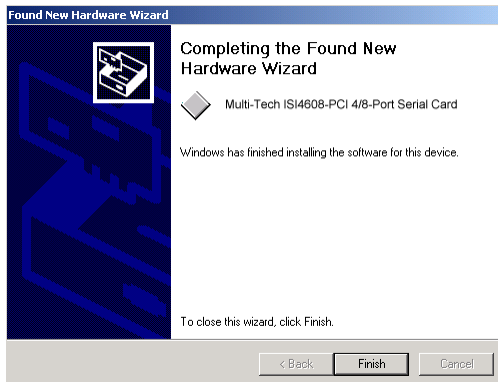

Click **Finish**.

11. Immediately after the ISI driver installation has been completed, another **Found New Hardware** screen will appear briefly indicating that the “MultiTech ISI Port” has been detected.

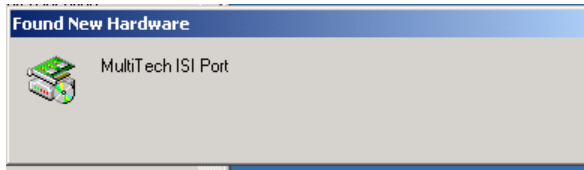

A second sequence of ‘installation wizard’ screens appears. This sequence of screens deals with the setting up of ISI ports. The first screen in this sequence is the **Found New Hardware Wizard -- Welcome** screen.

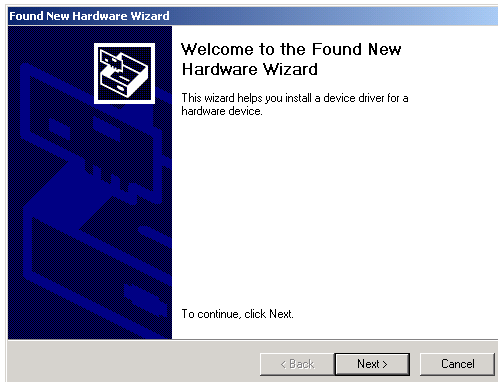

The **Found New Hardware -- MultiTech ISI Port** screen will appear four times for the ISI4604-PCI and eight times for the ISI4608-PCI.

12. The **Install Hardware Device Drivers** screen appears.



Select “Search for a suitable driver ... “ and click **Next**.

13. The **Locate Driver Files** screen appears (Windows 2000 is seeking the ISI Port device driver). Select “CD-ROM drives” and click **Next**.

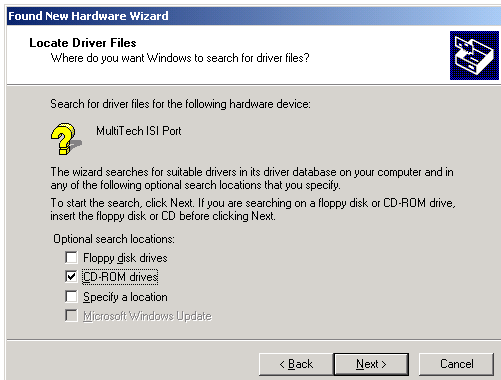

14. The **Driver Files Search Results** screen will indicate that the

“isiport.inf” file has been found on the CD-ROM.

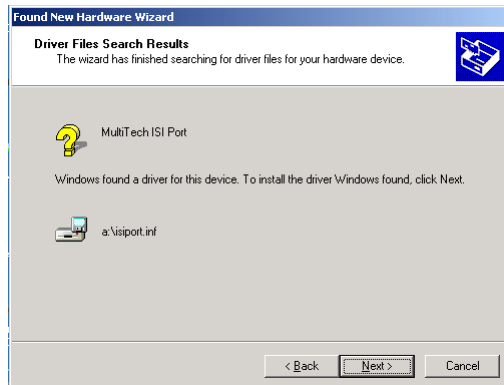

Click **Next**.

15. A completion screen will appear. It will indicate that the first “MultiTech ISI Port” has been set up successfully.

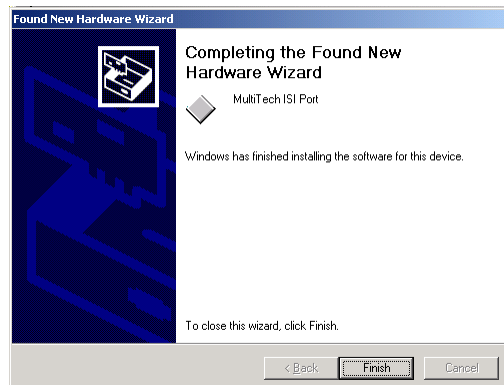

Click **Finish**.

Notice that the auto-detection facility of Windows 2000 will repeat the “ISI Port” installation sequence 7 more times for the ISI4608-PCI, or 3 more times for the ISI4604-PCI. That is, the **Found New Hardware-- MultiTech ISI Port** screen will appear many times after the ISI driver has been located. On this screen, the messages “Found New Hardware” and “Installing ...” will appear alternately.

Please understand that the repetition of these screen sequences is normal and is not an error. It does not indicate any problem with your PC, or with the MultiTech ISI card, or its driver software.

16. Driver installation for the ISI460x-PCI card is complete.

ISI460x-PCI for Windows 2000: Installing ISI Management Software (server OSs only)

If you are using a Windows 2000 Server operating system ("Server" or "Advanced Server"), you must decide whether you want to use the MultiTech ISI Management Software in conjunction with your ISI460x-PCI card. The ISI Management Software is shipped with the ISI card.

1. Turn on your computer and start Windows 2000.
2. Insert the CD-ROM containing the ISI Management Software into your CD-ROM drive. (If ISI Management Software has been downloaded from the MultiTech web site, it will typically be on a diskette. In that case, insert diskette into floppy drive).
3. Go to **Start | Run**. In the **Run** window, enter the file path of the ISI Management software. Typically, this would be
E:\SERVCARD\UTILITY\MGMT\SETUP.EXE.

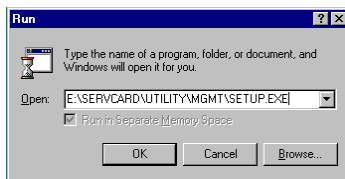

Click **OK**.

4. The **ISI Management** setup screen appears. At the **Welcome** screen, click **Next**.
5. A progress screen appears while files are copied. If the **Error Creating WWW Server** message appears, it may indicate that there was an attempt to install the ISI Management Software on a client version of Windows 2000. (The ISI Management Software can be installed only in the *Windows 2000 Server* and *Windows 2000 Advanced Server* operating systems.)



6. A completion screen appears.

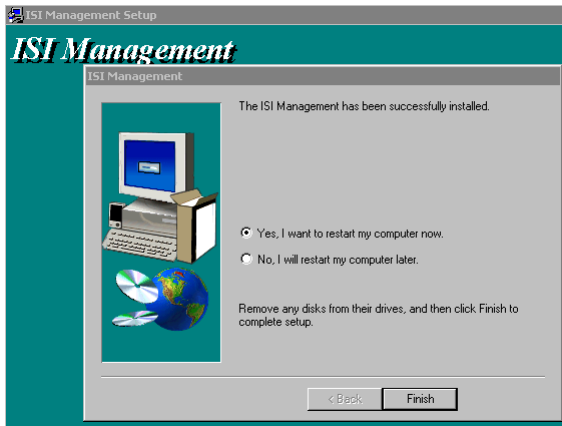

Select "Yes, I want to restart my computer now" and click **Finish**.

After the computer has restarted, the installation of the driver and of the ISI Management Software will be complete.

Remove ISI460x-PCI Driver (Windows 2000)

1. Go to **Start | Settings | Control Panel**.
2. Click on **Add/Remove Hardware**. Click **Next**.
3. Click on “Uninstall/Unplug a device” and click **Next**.
4. In the subsequent screen, click on “Uninstall a device” and click **Next**.
5. At the **Add/Remove Hardware Wizard** screen, highlight the ISI driver file for the specific server card that you intend to remove. Click **Next**.
6. When you are asked to confirm removal, click on the **Yes** radio button and click **Next**.
7. Click **Finish**. You can remove the driver for only one ISI460x-PCI card at a time.

ISI460x-PCI Software Installation Procedure for Windows NT 3.51/4.0

1. Turn off the PC.
2. The ISI460x-PCI card must be installed in a PCI expansion slot in the computer. If not, follow the computer manufacturer's instructions concerning installation of expansion cards. Observe standard precautions regarding electro-static discharge (ESD) when handling the ISI460x-PCI board (the board should be kept in its shipping bag until used). During installation, handle the ISI460x-PCI circuit card by its edges and keep one hand in contact with the computer chassis.
3. Turn on the PC and start Windows NT.
4. Insert the driver CD-ROM into the CD-ROM drive. (If drivers were obtained from MultiTech web site and stored on diskette, place diskette into floppy drive now.)
5. Click **Start | Settings | Control Panel | Network | Adapters**. Then click **Add**.

6. The **Select Network Adapter** dialog box appears. Click **Have Disk**.

7. The **Insert Disk** dialog box appears. Type or browse for the path (file directory location) of the Windows NT driver (for example, E:\SERVCARD\DRIVERS\WINNT\SETUP.EXE). Click **OK**.

8. The **Select OEM Option** dialog box appears. Click **OK**.

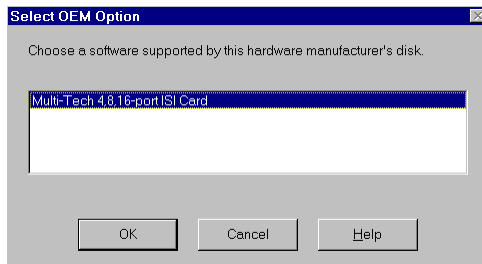

A transient dialog box will appear indicating the progress of the setup program.

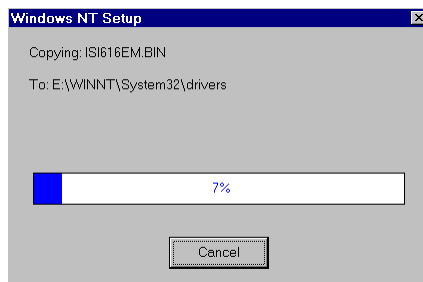

9. The **ISI Cards** dialog box appears. Click **Add**.

10. Then the **ISI Card Settings** dialog box appears. Enter the correct port count:

- allocate 4 ports for ISI4604-PCI cards;
- allocate 8 ports for the ISI4608-PCI cards.

Select the first port number for modems, which is usually COM3.

Click "PCI" in the **Bus Type** field.

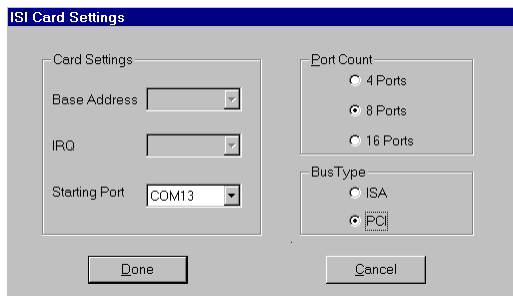

11. The **ISI Cards** dialog box appears again and shows the port resource allocation just made. To add more cards, click **Add** and repeat Step 9.

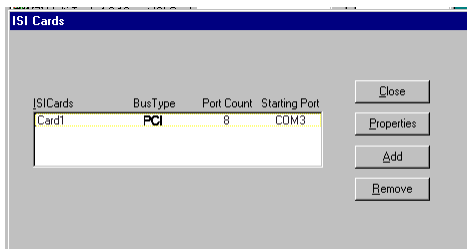

After the last ISI card has been added, click **Close**.

12. The file is copied and "Multi-Tech ISI4608-PCI Adapter" appears in the **Network Adapters** box. Click **Close**.

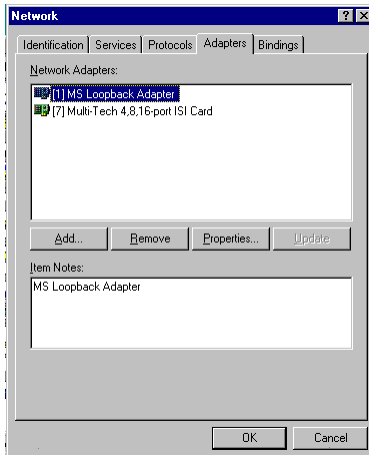

13. When prompted about restarting your computer, click **Yes**.

The ISI460x-PCI card software is now installed in Windows NT.

Removing ISI4608x-PCI Card and Driver in Windows NT 3.51/4.0

1. Go to **Start | Settings | Control Panel | Network**. Click on the **Adapters** tab.

2. Select "MultiTech 4, 8, 16-port ISI card," and then click **Remove**.

To complete the un-install procedure, restart your computer.

I/O Addresses and IRQ Codes

Unlike the ISI4608, the ISI460x-PCI has no DIP switch for I/O addresses and no jumper to determine the IRQ code. The input/output address and the interrupt request code (IRQ) for the ISI460x-PCI are assigned automatically during driver installation. During any subsequent re-configuring of your PC, you may need to know the assigned I/O address and IRQ code. To determine the I/O address and IRQ assigned to the ISI460x-PCI:

(for Windows NT) click on **Start, Settings, Control Panel** and select the **ISI Cards** icon; or click on **Start, Programs, Administrative Tools (Common), Windows NT Diagnostics, Resources**;

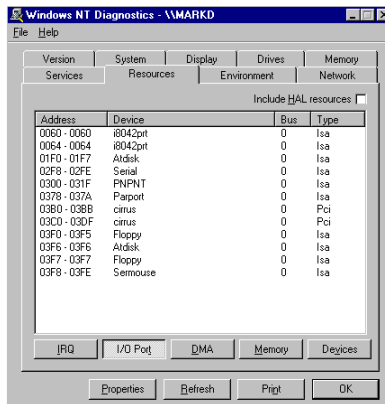

(for Windows 95) click on **Start, Settings, and Control Panel**. From the Control Panel, click on **System** icon and then the **Device Manager** tab. From there, click on the **Computer** icon at the top of the **Device Manager** window. The **Computer Properties** dialog box will appear. In the **View Resources** tab, click on either the **Interrupt Request (IRQ)** or **Input/Output (I/O)** radio buttons to view lists of both the IRQs and I/O memory addresses in use in the computer and what devices are currently using these resources.

ISI460x-PCI Software Installation Procedure for Windows 95/98/Me

1. Turn off the computer.
2. The ISI460x-PCI card must be installed in a PCI expansion slot in the computer. If not, follow the computer manufacturer's instructions concerning installation of expansion cards. Observe standard precautions regarding electro-static discharge (ESD) when handling the ISI board (the board should be kept in its shipping bag until used). During installation, handle the ISI circuit card by its edges and keep one hand in contact with the computer chassis.
3. Turn on the computer and start Windows 95/98/Me.
4. Windows will autodetect the ISI460x-PCI card. When the **Add New Hardware Wizard** screen appears, click **Cancel**.
5. Insert the MultiTech ISI driver CD-ROM into the CD-ROM drive. (If driver was downloaded from MultiTech web site and placed on a diskette, insert diskette into floppy drive now.)

6. (Follow either 6A or 6B, but not both.)
 - A. From Windows Explorer, open the **95-98-Me** directory on the CD-ROM (for example, E:\SERVCARD\DRIVERS\95-98-Me\SETUP.EXE) or floppy drive that contains the ISI driver file. Highlight the file **setup.exe**.

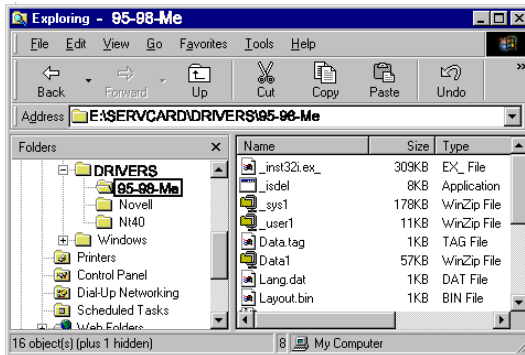

- B. From the **Start** menu, go to **Run**. Browse to the path of the **95-98-Me** directory (for example, E:\SERVCARD\DRIVERS\95-98-Me\).

7. Launch the setup program. (From Windows Explorer, double-click on **setup.exe**; from the **Run** menu, click **OK**.)



8. The installation wizard will begin running. At the **Welcome** screen, click **Next**.

9. Under **Select Type of Card**, do not check the **Install ISA Card** box.

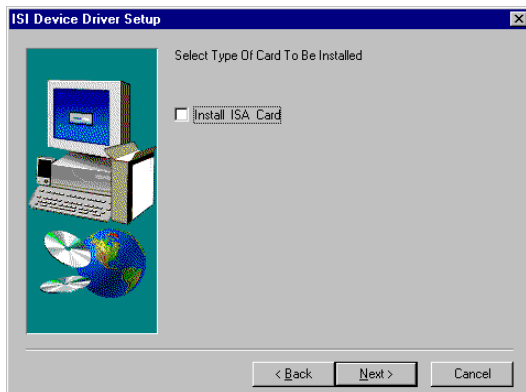

Click **Next**.

10. A completion screen appears.



11. When prompted to restart your computer, click **Yes** and click **OK**.

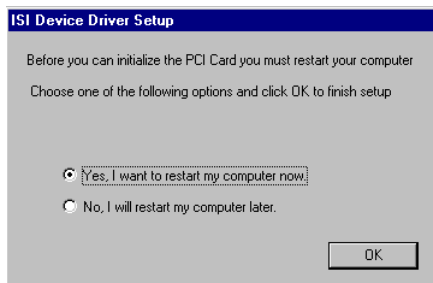

12. During the re-start process, Windows 95/98/Me will detect the ISI460x-PCI card. The **Add New Hardware Wizard** screen will appear. Click **Next**.
13. The next screen asks, **What do you want Windows to do?** Click on **Search for the best driver for your device**. Click **Next**.
14. When asked for the location at which Windows 95/98/Me should search for the new driver, check **Specify a Location** and enter the path (file directory location) of the driver.
15. Windows will indicate that the .INF file for the ISI460x-PCI card has been found. Click **Finish** to complete device driver installation.



16. Windows will now detect and create COM ports (for ISI4608-PCI, 8 ports are made; for ISI4604-PCI, 4 ports are made).
17. After the COM ports have been created, you must re-boot your PC.

- To view the COM ports, click **Control Panel** and double-click **System**. The **System Properties** dialog box appears.

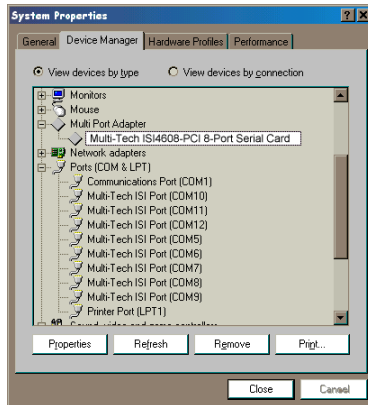

The **MultiTech PCI ISI Card** is located under **Multi Port Adapter**. Click **Ports (COM & LPT)** to view the ports. Click **OK** to close.

Removing the ISI460x-PCI Driver (Windows 95/98/Me)

- Click **Settings**, **Control Panel**, and then double-click **Add/Remove Programs**.
- From the list box, select **MultiTech ISI Driver Device**.
- Click **Add/Remove** and follow screen instructions.

NetWare Driver Installation

Multi-Tech Systems provides AIO drivers for the ISI460x-PCI cards, so they can function with Novell compatible asynchronous applications (e.g., NetWare Connect). The AIO driver is simply an NLM (NetWare Loadable Module) that runs on the file server. Drivers must be loaded on the file server where the board is installed. Drivers can be loaded from the file server's console prompt or incorporated for autoloading in the AUTOEXEC.NCF file.

The file `AIOMTS.MDC` contains Novell (version 3.12 and higher) initialization strings for ISI products not previously listed for use with BorderManager and Netware Connect. The file `AIOMTS.MDC` is included on the ISI Product Family CD. To benefit from the `AIOMTS.MDC` file, you must copy it from the CD to the appropriate directory on your computer.

To use `AIOMTS.MDC` under Border Manager, RAS, NIAS in 4.2 or 5.x:

Copy `AIOMTS.MDC` to your System directory.

To use `AIOMTS.MDC` under Novell NetWare 3.x, 4.1, 4.11 with NetWare Connect 2.0.28 or higher:

Copy `AIOMTS.MDC` to your System and System/AIO directory.

To install the Multi-Tech AIO driver, copy the file `AIOISIX.NLM` to the system directory of the file server from a workstation on the network.

To copy, you can use the following command:

```
COPY E:\SERVCARD\DRIVERS\NOVELL\AIOSIX.NLM
F:\SYSTEM
```

If you have downloaded the ISI driver from the MultiTech web site onto a diskette, use this command:

```
COPY A:\NOVELL\AIOISIX.NLM F:\SYSTEM
```

To load the driver, go to the system or PC console (where the ISI card is installed) and enter the following at the prompt:

```
LOAD AIOISIX [port=W] [interrupt=X] [name=Y]
[note=Z]
```

For the ISI460x-PCI cards, which are PCI-bus equipped, Netware will set up the interrupt (IRQ) and I/O address automatically.

To install the ISI card scripts, copy `aiomdms.mdc` to

f:\system\aiod\directory. Click **Yes** to overwrite the existing aiomdms.mdc file.

Configuring Ports for NetWare Connect

When the driver is installed, it will allocate consecutive ports for the ISI card as follows:

- 8 consecutive ports for the ISI4608-PCI.
- 4 consecutive ports for the ISI4604-PCI.

To set up NetWare Connect ports, enter **LOAD NWCCON** at the NetWare console prompt. **LOAD NWCCON** opens the NetWare Connect Configuration Utility. Select the appropriate menu options (modem type, speed, flow control, etc.).

Removing the Driver (Novell)

In Novell, remove file AIOISIX.NLM from the system directory and make the appropriate changes to the *Autoexec.ncf* file.

SCO Open Server 5 Driver Installation

The ISI driver for SCO Open Server 5 is shipped on CD-ROM (FAT file system) and can also be downloaded from the Multi-Tech web site. In both cases, the driver files are compressed (“tarred”). Users installing from the CD-ROM should begin at “To install from CD-ROM” directly below. Users installing from a floppy disk should skip down to “To install driver from floppy disk” later in this section. The filename of the SCO5 driver in its tarred form is **isisco.tar**.

This present installation section is task-oriented with minimal explanation of procedural steps. The section *Multi-Tech Installation Script*, which immediately follows this section, presents additional details to aid in installation.

To install from CD-ROM:

```
# mount -r /dev/cd0 /mnt
```

```
# cd /mnt  
# cd servcard/drivers/sco50x  
#cp isisco.tar /  
# cd <ENTER>
```

To format a floppy disk for SCO5:

1. At the Unix prompt, run the **scosh** program.
2. Select **Manager**.
3. Select **Archive**.
4. Select **Format**.
5. Make sure that Device is pointed to the floppy drive.
6. Select **Continue**.

To untar the driver file and copy files onto floppy disk:

1. Make a temporary directory for the ISI driver files..

```
# mkdir /isi
```
2. Copy the tarred isi driver file into the temporary directory.

```
# cp sco50x.tar /isi
```
3. Untar this file and put its contents into the temporary directory.

```
# cd /isi  
# tar xf sco50x.tar
```
4. Copy the untarred (inflated or non-compressed) files to a floppy disk

```
# cd /isi/unifiedinstimg  
#scosh  
-Select Manager.  
-Select Archive.
```

- Select **Create**.
- Press space bar to highlight tmp/ and usr/ directories.
- Press ENTER to copy.
- Make sure Device is pointed to the floppy disk.
- Make sure that the “Type” is cpio.
- Select **Continue**.

5. To verify that the files have been copied onto the floppy disk, use these commands:

```
# scosh
```

- Select **Manager**.
- Select **Archive**.
- Select **List**.
- Make sure Device is pointed to the floppy disk.
- Select **Continue**.

To install driver from floppy disk

(Users starting with the untarred SCO5 driver on a floppy disk can begin the installation here).

1. Run the **custom** utility.
2. Select **Software**.
3. Select **Install New**.
- 4 Highlight driver file from local host and select **Continue**.
5. Select as the Media Device “Floppy Disk Drive.”
6. Select .
7. Highlight “Multi-Tech ISA/PCI ...” and select **Install**.
8. Enter **Y** (yes) to continue installing the ISI driver.

9. As many as four ISI cards can be installed in the server. Type 0. Because the ISI460x-PCI card has a PCI bus, SCO can detect how many ISI cards are present. (For ISA-bus cards, the number of cards, 1, 2, 3, or 4, must be specified overtly.)

For further details see *MultiTech Installation Script* step 1.

10. Type the number of pseudo-devices to be created.

For the ISI4604-PCI, type 4.

For the ISI4608-PCI, type 8.

For further details see *MultiTech Installation Script* step 2.

11. Type Y (yes) to accept the prefix for tty ports. For further details see *MultiTech Installation Script* step 3.

12. Type Y (yes) to confirm the selection. For further details see *MultiTech Installation Script* step 4.

13. After the driver is installed, press ENTER to continue. For further details see *MultiTech Installation Script* step 4(last paragraph) and step 5.

14. Exit the **custom** utility. For further details see *MultiTech Installation Script* step 6.

15. Remove the floppy disk and reboot your computer. For further details see *MultiTech Installation Script* step 7.

MultiTech Installation Script

The Multi-Tech Installation Script for SCO Open Server 5 systems requests information about how many boards you want to install, designations for communication ports and printer ports, and how many pseudo devices you want to create for Multi_View utility. Based on this information, the appropriate driver files will be installed and linked with your system's kernel.

1. This text appears on the screen:

```
You can install up to 4 ISA/PCI cards in a
system. The PCI cards will be autodetected
on bootup. Enter the number of ISA cards you
want to install and configure on your system
```

(0-4) :

Select **0** if your computer has a PCI bus. This tells the SCO operating system to autodetect the ISI cards.

2. The following text appears on the screen:

```
Multi_View is a utility which will allow you
to have multiple sessions on terminals that
have multiple pages of physical memory. In
order for this utility to work with
MultiTech's serial cards, pseudo devices
have to be created in your /dev directory.
These devices are system-wide resources.
```

```
Enter the number of pseudo-devices to be
created for the use of Multi_View utility
(1 - 256).
```

The Multi_View utility initializes the multiple-page capability of terminals with multiple pages of memory. The number specified here is the total number of devices (between 1 and 256) available to all Multi-Tech terminals and it's the number of pseudo devices available to the Multi_View utility.

Specify **4** pseudo devices for each ISI4604-PCI card installed; specify **8** for each ISI4608-PCI card installed.

For example, if the computer contains three ISI4608-PCI cards, you would enter **24**.

You must initialize the ports separately using the **enable** command (for example, `enable ttylla`).

3. This text appears on the screen and relates to the “/dev” directory.

```
This script also creates the devices in your
system to communicate with the ports of
ISICOM. The default prefix for the tty
ports is ttyl. The default prefix for the
printer is prnl. Is this acceptable? (y/n/
```

q) .

For most users, it's best to select **y**, which entails accepting the default values. Then proceed to step 4.

Details for use of non-default port/printer values. The /dev directory holds device-information files used by the kernel to access the hardware. When you add an ISI card, you must give the ISI ports unique names so they do not conflict with existing ports or with other devices known to your system. If a device name has already been assigned to an existing device and the operator assigns that name to a new device, then the existing device will be *deleted* when the ISI port using its name is created.

a. To use a non-default base name, type **N** and then enter a basename having less than five characters. The base name you select will be used for all ports on each card you install. ISI port designations will have this form:

[*basename prefix*][*board number*][*port letter*].

basename: Length is one to four characters.

board number: Values will be 1, 2, 3, or 4, depending on how many ISI cards are installed in your computer.

port letter: For ISI4604-PCI, use letters A through D for modems. For ISI4608-PCI, use letters A through H for modems. (For terminal control devices, use lower-case letters as port identifiers.)

Device basename selected: _____

- b. After you select a device basename, you are prompted for a printer base name. This prefix identifies each port that supports a terminal with a printer attached to its auxiliary port (for transparent printing). Specify a unique printer base name (printer parameters are outlined in the Multi_Setup Utility section in this manual).

Printer base name selected: _____

When you have specified the device base name and the printer base name, press **ENTER** to continue.

4. The confirmation screen lists the values you have selected. The following text appears on the screen (default values are shown):

```
You have chosen the following setup
The tty prefix is ttyl.
The printer prefix is prnl.
Number of Multi_View pseudo devices
[user-specified number].
```

If these values are correct, type **Y** and the installation process will continue. If there is an error in any of the values displayed, type **N** and the first screen displays. Then re-enter the information for each card.

When you accept the confirmation list (by typing **Y**), a series of messages displays while the driver is being installed and the kernel rebuilt. After the terminals have been added to the Terminal Control database, and when the display says “**Press <Enter> to continue:**”, then press **ENTER**. When **Installation complete** displays, press **ENTER** again.

5. Select **Host** and press **ENTER** . Remove the diskette from the drive.
6. Select **Exit** and press **ENTER** .
7. To reboot the system (required), enter the following commands:

```
Type shutdown -g0-y and press ENTER
OR
```

```
Type init 6 and press ENTER .
```

Driver installation for the ISIHP card now is complete.

Activating Ports in SCO Open Server 5

SCO Open Server 5 provides a device database that monitors the activity of serial ports through which users can log onto the host. If your ISI ports are used by terminals (e.g., to allow users to log onto your host), you must create an entry in the system's device database that furnishes specific information for the terminals that will be used on each ISI port. The database is referenced each time a user attempts to log in. If there is no database entry for a particular terminal, access to the host is denied.

1. Turn on your system and verify that the firmware for each ISIHPC loads successfully. If the firmware for a given ISI460x-PCI card does not load, none of its ports will be accessible. (If this happens, see *Multi-Tech's Administrative Utility* section in this manual.)
2. Type the complete name of the first device you want to create in **usr/lib/uucp/Devices**. Substitute the specific base name, board number, and port letter for the generic parameters in the expression **ttylbx**. Use a lower-case **x** value for local DTE (terminal) support and an upper case **X** value for modem control for each port you want to enable. Example: **ttyl2A** denotes the second ISI card (2) and the first port on that card (A). The port status can be altered later, but one setting must be selected at this time. The ACU line would read as follows:
ACU ttylbx - 9600 dialer name. Replace **b**, **x** and **dialer-name** with appropriate values.
3. Repeat this process for each port on each board you have installed. **Record the setting you select for each port.**
4. Using device names created in the previous section, type the following command for each port you want to activate: **enable ttylbx**
5. Repeat this command for each port you want to activate, using the lower case letter for local terminal use or upper case for modem control.

Note: Only one of the options (e.g., modem control or local terminal access) should be enabled for any port at one time. For example, you cannot enable `tty11a` and then enable `tty11A`. To change the status of a port, disable the current status (disable `tty11a`) and then enable it for the desired status (enable `tty11A`).

Removing the Driver (SCO Open Server 5)

To remove the Multi-Tech Serial Card Driver, enter the configuration utility (e.g., custom for SCO Open Server 5) and follow instructions to remove the entire driver and rebuild the kernel without the ISI driver. If it is necessary to reinstall the driver due to I/O address or IRQ overlap, remove the driver first.

Note: Remove the driver before permanently removing the ISI card from the computer.

Linux Driver for Multi-Tech ISI460x-PCI Server Cards

LINUX: Pre-Installation Issues

When unpacking the Linux driver, there are two choices, one driver for the 2.0.x kernel (at this writing, it is filename `L300_20X.TAR`), and one driver that works for both the 2.2.x kernel and the 2.4.x kernel (at this writing, it is filename `L305_22X_24X.TAR`). Be absolutely positive about which kernel you have! Note that updated driver files may be issued from time to time.

The 'make' utility, GNU C compiler, and the kernel sources need to be installed on your system. If any of these are missing, the compilation will fail. Most later Linux OSs install these elements automatically .

LINUX: Copying the driver from the media

The Linux drivers (for 2.0 and 2.2/2.4 kernels) are shipped in compressed ('tarred') form on a CD-ROM formatted with the FAT file system. In some cases, users may download Linux ISI drivers from the MultiTech web site onto diskette (in ext2 format). We present instructions for both situations below.

LINUX: Copying and untarring the driver from CD-ROM

1. Mount the CD-ROM using this command:

```
mount /mnt/cdrom
```

2. Change directory

```
cd /mnt/cdrom
```

3. List the files on the CD-ROM and locate the directory for the kernel in use (2.0 or 2.2/2.4), using this command

```
ls
```

4. Untar the appropriate Linux driver using this command:

```
> tar vxf {filename}/tmp
```

At this writing, the filename will be either L300_20X.TAR or L305_22X_24X.TAR.

LINUX: Copying and untarring the driver from a floppy

The ISI driver .tar file can be copied from a DOS formatted floppy using the 'mcopy' command if the 'mtools' have been installed. Issue 'mcopy a:isilinux.tar <destination folder>' to copy the isilinux.tar (or current driver name) file to the destination folder. As an alternative, the floppy can be manually mounted and the file copied to the required destination folder.

NOTE: To read from a DOS formatted floppy, a kernel with support for the FAT file system (either statically linked in the kernel or as modules) is required.

Steps for copying the driver from a floppy:

1. Linux floppy disks are in ext2 format.
2. Insert Linux driver in drive A: and mount floppy drive.

```
> mount /dev/fd0
```

```
> mount -t ext2 /dev/fd0 /mnt/floppy
```

3. Copy files from floppy to a temporary directory on hard drive.

```
> mkdir /isi  
> cd /isi  
> cp /mnt/floppy/kernel_2.2.x/* /isi
```

After you have copied the installation tar file to a folder, use the command 'tar xvf isilinux.tar' to untar (unzip or de-compress) the installation files in that folder.

LINUX: Driver installation and loading

Execute the 'Install' script to build the driver and to copy the driver and firmware files to the required folder.

```
> cd /isi  
> ./Install
```

For ISI460x-PCI cards, which are equipped with the PCI-type bus, simply press ENTER when asked for addresses and IRQs. The installation creates the script file 'ISICOMStart' in the destination folder. 'ISICOMStart' automates the loading process for the driver and firmware.

To view busy I/O address space on your system, enter

```
cat /proc/ioproports
```

To view busy IRQs, enter:

```
cat /proc/interrupts
```

You must load the driver before you can load the firmware. You can load the driver manually using the 'insmod' utility. For ISI cards with the ISA bus, the I/O base address and the IRQ required by the card also need to be passed as parameters to insmod (this does not apply to ISI460x-PCI cards, which are equipped with the PCI-type bus).

```
insmod isicom io=card1, ... card4 irq=card1,  
... card4
```

The ISI460x-PCI cards and their configurations will be auto-detected by the driver.

You can manually load the firmware into all of the installed ISI cards simultaneously by executing the 'firmld' utility in the installation folder. The firmware to all the installed cards can be manually loaded by executing the 'firmld' utility in the installation folder. This utility requires the firmware files (.bin) to be located in the /usr/local/ISICOM/ folder.

LINUX: Setting the baud rate

The 'stty' utility can be used to set the baud rate of a particular port. For example, to set the baud rate of the first port on the first card (ttyM1a) to 38400 bps, execute 'stty 38400 < /dev/ttyM1a'.

The current baud rate can be viewed by executing 'stty < /dev/ttyM1a'.

LINUX: Verifying the ports

Terminal utilities like 'minicom' can be used to verify the ports, 'talk' to the modem, and dial out.

To configure 'minicom' for a particular port, run it with the '-s' option. In the 'serial port setup' menu option, set the serial device to the required ISI port device (for example, '/dev/ttyM1a' for the first port on the first card). Save the configuration for a particular port using the 'save setup as' menu option as, for example, '1a' for the port /dev/ttyM1a. To connect to the port /dev/ttyM1a using minicom the next time, 'minicom 1a' needs to be executed.

LINUX: TTY Devices Created by the Drivers:

Device files corresponding to ports on the ISI card are created in the /dev folder. Use **ttymxy** for normal ports and **cumxy** for corresponding callout ports. Normal ports (**ttym**) are configured for dial-in connections. Callout ports (**cum**) are used for dial-out connections.

In these expressions (**ttymxy** and **cumxy**), the letter **x** is the card number (1-4), and **y** is the port designator (a, b, c, ...).

The ISI Linux driver creates the following TTY devices in /dev directory:

- /dev/ttyM1a TO /dev/ttyM1p for the first ISI card
- /dev/ttyM2a TO /dev/ttyM2p for the second ISI card
- /dev/ttyM3a TO /dev/ttyM3p for the third ISI card
- /dev/ttyM4a TO /dev/ttyM4p for the fourth ISI card

For 4-port cards, it uses the following:

- /dev/ttyM1a TO /dev/ttyM1d for the first ISI card
- /dev/ttyM2a TO /dev/ttyM2d for the second ISI card
- /dev/ttyM3a TO /dev/ttyM3d for the third ISI card
- /dev/ttyM4a TO /dev/ttyM4d for the fourth ISI card

For 8-port cards, it uses the following:

- /dev/ttyM1a TO /dev/ttyM1h for the first ISI card
- /dev/ttyM2a TO /dev/ttyM2h for the second ISI card
- /dev/ttyM3a TO /dev/ttyM3h for the third ISI card
- /dev/ttyM4a TO /dev/ttyM4h for the fourth ISI card

Devices mapped for ISI460x-PCI Cards :

For the ISI4604-PCI:

- /dev/ttyM1a to /dev/ttyM1d *for modem ports.*

For the ISI4608-PCI:

- /dev/ttyM1a to /dev/ttyM1h *for modem ports.*

LINUX -- Dial-in configuration:

To configure a particular port for dial-in, utilities like 'mgetty' need to be installed on the system. If, for example, the port `/dev/ttyM2c` needs to be configured for a remote-access dial-in connection, an entry of the form `'M2c:12345:respawn:/sbin/mgetty ttyM2c'` needs to be added in the `/etc/inittab` file. After you have made the change, execute `'init q'` so that the 'init' process re-reads the inittab file and spawns the mgetty process to wait for an incoming connection. Users can then dial in, use their user names and passwords to log in, and access their accounts on the machine.

To disable dial-in access on a particular port, change the entry in the `/etc/inittab` file to `'M2c:12345:off:/sbin/mgetty ttyM2c'` or just comment-out that entry by prefixing a '#' to the entry on the line.

LINUX -- PPP setup:

The 'PPP-HOWTO' (a document that is available as a part of the 'HOWTO' documentation on most of the distributions under `/usr/doc/HOWTO`) explains in detail the procedure for configuring a Linux machine as a PPP server. This information is also available at

<http://www.interweft.com.au/other/ppp-howto/ppp-howto.html>.

The documentation in the PPP-HOWTO is directly applicable to ISI ports.

Note: A base I/O address of 0, e.g., `ISIBaseX=0x0`, or omission of these parameters for any card X, disables that particular card.

Miscellaneous:

Device files corresponding to ports on the ISI460x-PCI cards are created in the `/dev` folder. Use `ttymxy` for normal ports and `cumxy` for corresponding callout ports. The letter **x** is the card number (1-4), and **y** is the port number, (a-p) for 16-port cards.

Normal ports (`ttym`) are configured for dial-in connections. Callout ports (`cum`) are used for dial-out connections.

To view busy I/O address space on your system, enter:

```
cat /proc/ioports
```

To view busy IRQs, enter:

```
cat /proc/interrupts
```

To load the driver manually, use **insmod**.

Example: To load two ISI cards configured with base I/O addresses 0x210 and 0x200 and IRQs 5 and 10, enter the following in the destination folder:

```
insmod isicom
ISIBase1=0x210
Irq1=5
ISIBase2=0x200
Irq2=10
```

To remove the driver manually, enter **rmmmod isicom**. This removes the driver only if no ISI ports are in use.

Removing the ISI Driver (Linux)

1. Type `cd /usr/local`. Press ENTER.
2. Type `rm -r ISICOM`. Press ENTER.
3. This will remove driver for all ISI460x-PCI cards in that Linux server.
4. Remove the `isictl` file by typing `rm isictl` in the `/dev` directory.
5. Remove all devices that start with `ttyM1x`, `ttyM2x`, `ttyM3x` and `ttyM4x` in the `/dev` directory.

```
“rm ttyM1*”
```

```
“rm ttyM2*”
```

```
“rm ttyM3*”
```

```
“rm ttyM4*”
```

Intelligent **Serial** *Interface*

Chap 4: Warranty, Service, & Tech Support



Warranty, Service & Tech Support

Limited Warranty

Multi-Tech Systems, Inc., (hereafter “MTS”) warrants that its products will be free from defects in material or workmanship for a period of two, five, or ten years (depending on model) from date of purchase, or if proof of purchase is not provided, two, five, or ten years (depending on model) from date of shipment.

MTS MAKES NO OTHER WARRANTY, EXPRESS OR IMPLIED, AND ALL IMPLIED WARRANTIES OF MERCHANTABILITY AND FITNESS FOR A PARTICULAR PURPOSE ARE HEREBY DISCLAIMED.

This warranty does not apply to any products which have been damaged by lightning storms, water, or power surges or which have been neglected, altered, abused, used for a purpose other than the one for which they were manufactured, repaired by Customer or any party without MTS’s written authorization, or used in any manner inconsistent with MTS’s instructions.

MTS’s entire obligation under this warranty shall be limited (at MTS’s option) to repair or replacement of any products which prove to be defective within the warranty period or, at MTS’s option, issuance of a refund of the purchase price. Defective products must be returned by Customer to MTS’s factory — transportation prepaid.

MTS WILL NOT BE LIABLE FOR CONSEQUENTIAL DAMAGES, AND UNDER NO CIRCUMSTANCES WILL ITS LIABILITY EXCEED THE PRICE FOR DEFECTIVE PRODUCTS.

Addendum for North American Products

In the event that service is required, products may be shipped, freight prepaid, to our Mounds View, Minnesota, factory (Multi-Tech Systems, Inc., 2205 Woodale Drive, Mounds View, MN 55112, Attn: Repairs, Serial # _____). A Returned Materials Authorization (RMA) is not required. Return shipping charges (surface) will be paid by MTS. Please include, inside the shipping box, a description of the problem, a return shipping address (must have street address, not P.O. Box), a

telephone number, and if the product is out of warranty, a check or purchase order for repair charges.

Extended two-year overnight replacement agreements are available for selected products. Please refer to our Overnight Replacement Agreement for details on rates and coverages.

Please direct your questions regarding technical matters, product configuration, verification that the product is defective, etc., to our Technical Support department at 1-800-972-2439. Please direct your questions regarding repair expediting, receiving, shipping, billing, etc., to our Repair Accounting department at (800) 328-9717 or (763) 717-5631.

Repairs for damages caused by lightning storms, water, power surges, incorrect installation, physical abuse, or user-caused damages are billed on a time-plus-materials basis.

Addendum for International Products

Distributors should contact Amex, Inc., for information about the repairs for your Multi-Tech product.

Amex, Inc.
2724 Summer Street NE
Minneapolis, MN 55413 U.S.A.
Tel: +(612)331-3251
Fax: +(612)331-3180

Please direct your questions regarding technical matters, product configuration, verification that the product is defective, etc., to our Technical Support department nearest you. When calling the U.S., please direct your questions regarding repair expediting, receiving, shipping, billing, etc., to our Repair Accounting department at +(763) 717-5631 in the U.S.A., or a nearby Multi-Tech office which is listed on the “Multi-Tech Corporate Offices” sheet in this International Distributor Resource Kit.

Repairs for damages caused by lightning storms, water, power surges, incorrect installation, physical abuse, or user-caused damages are billed on a time-plus-materials basis.

Out of Warranty Repair Cost Charts

See the Multi-Tech web site for current repair rates.

Upgrades and Product Support via Internet

You can access updated versions of firmware, drivers, flash utility programs and other software-related support for ISI4608-PCI or ISI4604-PCI server cards via the MultiTech web site and/or the MultiTech FTP site.

www.multitech.com. Go to **Support** page. Drivers, software, and firmware are available here. Follow links for manuals, replacements, our warranty, and access to our FTP site.

<ftp://ftp.multitech.com>. **ISI Cards** have their own directory.

Technical Support

Multi-Tech has an excellent technical support staff available to help you get the most out of your Multi-Tech product. If you have any questions about the operation of this product, call Technical Support at (800) 972-2439. Model and serial numbers are located on the Multi-Tech label on the component side of the ISI460x-PCI. To display the firmware version, type AT11 in terminal mode. Software versions are printed on the diskette labels. Before calling Technical Support, note the status of your equipment, including screen messages, diagnostic test results, problems with a specific application, etc.

Send the ISI4608-PCI to this address:

MULTI-TECH SYSTEMS, INC.
2205 WOODALE DRIVE
MOUNDS VIEW, MINNESOTA 55112
ATTN: SERVICE OR REPAIRS

Recording ISI460x-PCI Information

Please fill in the following information on your Multi-Tech product. This will help tech support in answering your questions.

Serial No.: _____
Firmware Version: _____
Driver Version: _____
Operating System: _____
COM Port #: _____

Please note the status of your ISI4608-PCI before calling tech support (e.g., screen messages, diagnostic test results, problems with a specific application, etc.).

Software User License Agreement

The ISI drivers and firmware are licensed by Multi-Tech Systems, Inc. to the original end-user purchaser of the product, hereafter referred to as *Licensee*. The License includes the distribution diskette or CD-ROM, other accompanying programs, and the documentation.

The ISI drivers and firmware, hereafter referred to as *Software*, consists of the computer program files included on the original distribution diskette.

Licensee agrees that by purchase and/or use of the Software, he hereby accepts and agrees to the terms of this License Agreement.

In consideration of mutual covenants contained herein, and other good and valuable considerations, the receipt and sufficiency of which is acknowledged, Multi-Tech Systems, Inc. does hereby grant to the Licensee a non-transferrable and nonexclusive license to use the Software and accompanying documentation on the following conditions and terms:

The software is furnished to the Licensee for execution and use on a single computer system only and may be copied (with the inclusion of the Multi-Tech Systems, Inc. copyright notice) only for use on that computer system.

The Licensee hereby agrees not to provide or otherwise make available any portion of this software in any form to any third party without the prior express written approval of Multi-Tech Systems, Inc.

Licensee is hereby informed that this Software contains confidential, proprietary, and valuable trade secrets developed by or licensed to Multi-Tech Systems, Inc. and agrees that sole ownership shall remain with Multi-Tech Systems, Inc.

The Software is copyrighted. Except as provided herein, the Software and documentation supplied under this agreement may not be copied, reproduced, published, licensed, sublicensed, distributed, transferred, or made available in any form, in whole or in part, to others, without expressed written permission of Multi-Tech Systems, Inc. Copies of the Software may be made to replace worn or deteriorated copies for archive or backup procedures.

Licensee agrees to implement sufficient security measures to protect Multi-Tech Systems', Inc. proprietary interests and not to allow the use, copying or transfer by any means, other than in accordance with this agreement.

Licensee agrees that any breach of this agreement will be damaging to Multi-Tech Systems, Inc.

Licensee agrees that all warranties, implied or otherwise, with regard to this Software, including all warranties of merchantability and fitness for any particular purpose are expressly waived, and no liability shall extend to any damages, including consequential damages, whether known to Multi-Tech Systems, Inc. It is hereby expressly agreed that Licensee's remedy is limited to replacement or refund of the license fee, at the option of Multi-Tech Systems, Inc. for defective distribution media. There is no warranty for misused materials.

Neither this Software nor the accompanying documentation may be modified or translated without the written permission of Multi-Tech Systems, Inc.

This agreement shall be governed by the laws of the State of Minnesota. The terms and conditions of this agreement shall prevail regardless of the terms of any other submitted by the Licensee. This

agreement supersedes any proposal or prior agreement. Licensee further agrees that this License Agreement is the complete and exclusive Statement of Agreement, and supersedes oral, written, or any other communications between Multi-Tech Systems, Inc. and Licensee relating to the subject matter of this agreement is not assignable without written permission of an authorized agent of Multi-Tech Systems, Inc.

On-Line Warranty Registration

If you want to register your ISI card on-line, you can do so at the following address:

<http://www.multitech.com/register>

About the Internet

Multi-Tech's Internet presence includes a Web site and an FTP site:

<http://www.multitech.com>

<ftp://ftp.multitech.com>

Intelligent **Serial** *Interface*

Appendices



Appendix A— Crossover Cable Wiring Diagrams

The following wiring diagrams illustrate the types of cables that should be used to make the connection between specific devices and the ISI4608-PCI card. The ports on each card are wired according to the RS232 standard for data terminal equipment (DTE) that implements a *male* connector.

If you have an ISI4608-PCI, the 8-port *fan-out* cable has eight 25-pin male connectors (shown in Figure A-1).



Figure A-1. DTE-type 25-pin, male D-style connector

25-pin ISI connector

25-pin DCE device

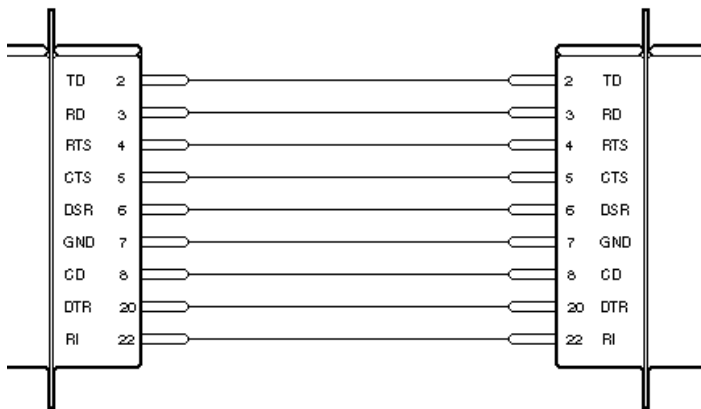

Figure A-2. DB25-to-DB25 straight patch cable

25-pin ISI connector

25-pin DTE device

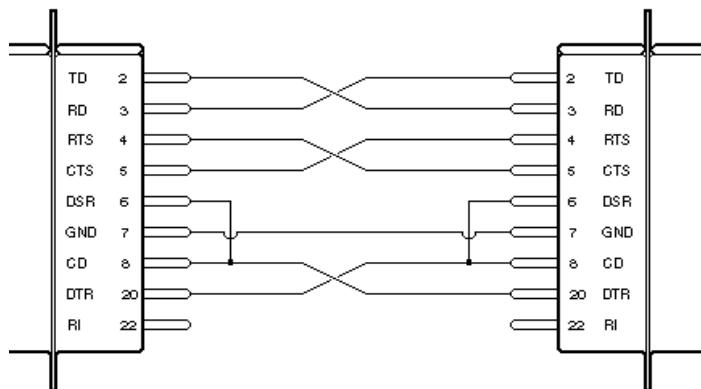

Figure A-3. DB25-to-DB25 crossover cable

Appendix B—Regulatory Information

Note: This equipment has been tested and found to comply with the limits for a Class B digital device, pursuant to Part 15 of the FCC rules. These limits are designed to provide reasonable protection against harmful interference when the equipment is operated in a residential installation. This equipment generates, uses, and can radiate radio frequency energy, and if not installed and used in accordance with the instruction manual, may cause harmful interference to radio communications. However, there is no guarantee that interference will not occur in a particular installation. If this equipment does cause harmful interference to radio or television reception, which can be determined by turning the equipment off and on, the user is encouraged to try to correct the interference by one or more of the following measures:

- Reorient or relocate the receiving antenna.
- Increase the separation between the equipment and receiver.
- Connect the equipment into an outlet on a circuit different from that of which the receiver is connected.
- Consult the dealer or an experienced radio/TV technician for help.

Warning: Changes or modifications to this unit, not expressly approved by the party responsible for compliance, could void the user's authority to operate this equipment.



EMC, Safety, and R&TTE Directive Compliance

The CE mark is affixed to the enclosed MultiTech product to confirm compliance with the following European Community Directives:

Council Directive 89/336/EEC of 3 May 1989 on the approximation of the laws of Member States relating to electromagnetic compatibility;

and

Council Directive 73/23/EEC of 19 February 1973 on the harmonization of the laws of Member States relating to electrical equipment designed for use within certain voltage limits;

both amended by

Council Directive 1999/5/EC of 9 March 1999 on radio equipment and telecommunications terminal equipment and the mutual recognition of their conformity.

Intelligent Serial *Interface*

Index



Index

A

activating ports in SCO 44

B

base I/O address 9

baud rates 8

bus types 8

C

cables 8

crossover 13, 62

octopus 13

wiring diagrams 62

CE mark 65

computer requirements 8

configuration

ports

in Netware 37

connector

DB78S female 13

connectors 8

D

DB78S female connector 13

dimensions 8

E

electrical specifications 8

enabling ports in SCO 44

environmental specifications 8

H

hardware installation 12

I

I/O address

and ISI460x-PCI cards 30

in Linux 50

installation

activating ports

in SCO Open Server 5 43

software/drivers

in Linux 47

in SCO Open Server 5 37

in Windows NT 26

Netware 35

Windows 2000 17

Windows 95/98/Me 31

installation, ISI Management Software 24

installation, ISI460x-PCI driver

in Linux 47

in Netware 37

in SCO 37

in Windows 2000 17

in Windows 95/98/Me 31

in Windows NT 26

installing

hardware 12

software 16

interrupt request (IRQ) 9

IRQ 9

IRQ values

and ISI460x cards 30

in Linux 51

in Netware 36

ISI Management Software

installation 24

ISI460x-PCI

applications 8

introduction to 6

product description 6

ISI460x-PCI install

in Linux 47

in Netware 36

in SCO 37

- in Windows 2000 17
- in Windows 95/98/Me 31
- in Windows NT 26

K

- kernel versions, Linux 45

L

- Linux, install in 45

M

- manual
 - how to use 7

O

- octopus cable 16
- on-line warranty registration 59

P

- port activation
 - SCO 43
- port allocation
 - Linux 48
 - Netware 37
 - SCO 41
 - Windows 2000 21
 - Windows 95/98/Me 34
 - Windows NT 28
- power 9
- PPP, info for Linux 50
- product description 6

R

- recording ISI4608-PCI information 57
- removing
 - software/driver
 - Linux 51
 - Netware 37

- SCO 45
- Windows 2000 26
- Windows 95/98/Me 35
- Windows NT 29

S

- safety warnings 12
- SCO driver installation
 - detailed form 40
 - from CD-ROM 37
 - from diskette 39
 - terse form 37, 39
- SCO Open Server 5
 - install in 37
- serial interface 8
- software installation 16
- software user licence agreement 57
- specifications 8
 - base I/O address 9
 - baud rates 8
 - bus type 8
 - cables 8
 - computer requirements 8
 - connectors 8
 - dimensions 8
 - electrical 8
 - environmental 8
 - interrupt request (IRQ) 9
 - physical 8
 - power 9
 - serial interface 8
 - temperature 9
 - warranty 9
- super user 16

T

- technical specifications 8
- technical support 56
- temperature 9

U

uninstall ISI driver

- Linux 51
- Netware 37
- SCO 45
- Windows 2000 26
- Windows 95/98/Me 35
- Windows NT 29

W

warranty 9

- on-line registration 59

Windows 2000

- ISI460x-PCI install 17
- uninstall driver 26

Windows 95/98/Me

- ISI460x-PCI install 31
- uninstall driver 35

Windows NT

- ISI460x-PCI install 26
- uninstall driver 29

Free Manuals Download Website

<http://myh66.com>

<http://usermanuals.us>

<http://www.somanuals.com>

<http://www.4manuals.cc>

<http://www.manual-lib.com>

<http://www.404manual.com>

<http://www.luxmanual.com>

<http://aubethermostatmanual.com>

Golf course search by state

<http://golfingnear.com>

Email search by domain

<http://emailbydomain.com>

Auto manuals search

<http://auto.somanuals.com>

TV manuals search

<http://tv.somanuals.com>