Multi*VOIP*TM

Voice / Fax over IP Networks

User Guide for Voice/IP Gateways

Digital Models

(T1, E1, ISDN-PRI):

MVP2400

MVP2410

MVP3010

Analog Models:

MVP210

MVP410

MVP810



User Guide

S000249C

Analog MultiVOIP Units (Models MVP210, MVP410 & MVP810)
Digital MultiVOIP Units (Models MVP2400, MVP2410, MVP3010,
MVP24-48 and MVP30-60)

This publication may not be reproduced, in whole or in part, without prior expressed written permission from Multi-Tech Systems, Inc. All rights reserved.

Copyright © 2002, by Multi-Tech Systems, Inc.

Multi-Tech Systems, Inc. makes no representations or warranties with respect to the contents hereof and specifically disclaims any implied warranties of merchantability or fitness for any particular purpose. Furthermore, Multi-Tech Systems, Inc. reserves the right to revise this publication and to make changes from time to time in the content hereof without obligation of Multi-Tech Systems, Inc. to notify any person or organization of such revisions or changes.

Record of Revisions

Revision	Description
A (05/10/02)	Initial Release.
B (05/24/02)	Index added.
C (10/11/02)	Updated for 4.03/6.03 software.

Patents

This Product is covered by one or more of the following U.S. Patent Numbers: **5.301.274; 5.309.562; 5.355.365; 5.355.653; 5.452.289; 5.453.986**. Other Patents Pending.

Trademark

Trademark of Multi-Tech Systems, Inc. is the Multi-Tech logo. Windows and NetMeeting are registered trademarks of Microsoft.

Multi-Tech Systems, Inc.
2205 Woodale Drive
Mounds View, Minnesota 55112
(763) 785-3500 or (800) 328-9717
U.S. Fax: 763-785-9874
Technical Support: (800) 972-2439

<http://www.multitech.com>

CONTENTS

CONTENTS	3
CHAPTER 1: OVERVIEW.....	7
ABOUT THIS MANUAL.....	8
INTRODUCTION TO TI MULTIVOIPs (MVP2400, MVP2410, & MVP24-48)	10
<i>T1 Front Panel LEDs</i>	12
<i>T1 LED Descriptions</i>	13
INTRODUCTION TO EI MULTIVOIPs (MVP3010 & MVP30-60).....	14
<i>E1 Front Panel LEDs</i>	16
<i>E1 LED Descriptions</i>	16
INTRODUCTION TO ANALOG MULTIVOIPs (MVP-210/410/810 & MVP428).....	18
<i>Analog MultiVOIP Front Panel LEDs</i>	20
<i>Analog MultiVOIP LED Descriptions</i>	21
COMPUTER REQUIREMENTS.....	22
SPECIFICATIONS.....	23
<i>Specs for Digital T1 MultiVOIP Units</i>	23
<i>Specs for Digital E1 MultiVOIP Units</i>	24
<i>Specs for Analog MultiVOIP Units</i>	25
INSTALLATION AT A GLANCE	26
RELATED DOCUMENTATION.....	26
CHAPTER 2: QUICK START INSTRUCTIONS.....	27
INTRODUCTION	28
MULTIVOIP STARTUP TASKS	28
<i>Phone/IP Details *Absolutely Needed* Before Starting the Installation</i>	29
Gather IP Information.....	29
Gather Telephone Information	29
Gather Telephone Information	30
Gather Telephone Information	30
Obtain Email Address for VOIP (for email call log reporting).....	31
Identify Remote VOIP Site to Call.....	31
Identify VOIP Protocol to be Used.....	31
<i>Placement</i>	32
<i>The Command/Control Computer (Specs & Settings)</i>	32
<i>Quick Hookups</i>	33
<i>Load MultiVOIP Control Software onto PC</i>	35
<i>Phone/IP Starter Configuration</i>	36
<i>Phonebook Starter Configuration (with remote voip)</i>	39
Outbound Phonebook	39
Inbound Phonebook.....	43
<i>Phonebook Tips</i>	46
<i>Phonebook Example</i>	49
<i>Connectivity Test</i>	54
<i>Troubleshooting</i>	58

CHAPTER 3: MECHANICAL INSTALLATION AND CABLING.....	59
INTRODUCTION.....	60
SAFETY WARNINGS.....	60
<i>Lithium Battery Caution</i>	60
<i>Safety Warnings Telecom</i>	60
UNPACKING YOUR MULTIVOIP.....	61
<i>Unpacking the MVP2410/3010</i>	61
<i>Unpacking the MVP2400</i>	62
<i>Unpacking the MVP410/810</i>	63
<i>Unpacking the MVP210</i>	64
RACK MOUNTING INSTRUCTIONS FOR MVP2410/3010 & MVP410/810.....	65
<i>Safety Recommendations for Rack Installations</i>	66
<i>19-Inch Rack Enclosure Mounting Procedure</i>	67
CABLING.....	68
<i>Cabling Procedure for MVP2410/3010</i>	68
<i>Cabling Procedure for MVP2400</i>	69
<i>Cabling Procedure for MVP410/810</i>	70
<i>Cabling Procedure for MVP210</i>	72
CHAPTER 4: SOFTWARE INSTALLATION	74
INTRODUCTION.....	75
LOADING MULTIVOIP SOFTWARE ONTO THE PC.....	75
UN-INSTALLING THE MULTIVOIP CONFIGURATION SOFTWARE.....	82
CHAPTER 5: TECHNICAL CONFIGURATION FOR DIGITAL T1/E1 MULTIVOIPS (MVP2400, MVP2410, MVP3010).....	86
CONFIGURING THE DIGITAL T1/E1 MULTIVOIP.....	87
LOCAL CONFIGURATION.....	89
<i>Pre-Requisites</i>	89
IP Parameters.....	89
T1 Telephony Parameters (for MVP2400 & MVP2410).....	90
E1 Telephony Parameters (for MVP3010).....	91
SMTP Parameters (for email call log reporting).....	92
<i>Local Configuration Procedure (Summary)</i>	93
<i>Local Configuration Procedure (Detailed)</i>	94
CHAPTER 6: TECHNICAL CONFIGURATION FOR ANALOG MULTIVOIPS (MVP210/410/810).....	161
CONFIGURING THE ANALOG MULTIVOIP.....	162
LOCAL CONFIGURATION.....	165
<i>Pre-Requisites</i>	165
IP Parameters.....	165
Analog Telephony Interface Parameters (for MVP210/410/810).....	166
SMTP Parameters (for email call log reporting).....	167
<i>Local Configuration Procedure (Summary)</i>	168
<i>Local Configuration Procedure (Detailed)</i>	169

CHAPTER 7: T1 PHONEBOOK CONFIGURATION	235
CONFIGURING THE MVP2400/2410 MULTIVOIP PHONEBOOKS.....	236
T1 PHONEBOOK EXAMPLES.....	254
3 Sites, All-T1 Example.....	254
Configuring Mixed Digital/Analog VOIP Systems	260
Call Completion Summaries	270
Variations in PBX Characteristics.....	273
CHAPTER 8: E1 PHONEBOOK CONFIGURATION	274
MVP3010 INBOUND AND OUTBOUND MULTIVOIP PHONEBOOKS	275
Free Calls: One VOIP Site to Another.....	276
Local Rate Calls: Within Local Calling Area of Remote VOIP	277
National Rate Calls: Within Nation of Remote VOIP Site.....	279
Inbound versus Outbound Phonebooks.....	280
PHONEBOOK CONFIGURATION PROCEDURE.....	284
E1 PHONEBOOK EXAMPLES.....	298
3 Sites, All-E1 Example	298
Configuring Digital & Analog VOIPs in Same System.....	305
Call Completion Summaries.....	314
Variations in PBX Characteristics.....	317
International Telephony Numbering Plan Resources	318
CHAPTER 9: ANALOG PHONEBOOK CONFIGURATION	320
CHAPTER 10: OPERATION AND MAINTENANCE	322
OPERATION AND MAINTENANCE	323
System Information screen.....	323
Statistics Screens.....	325
About Call Progress.....	325
About Logs.....	331
About Reports	334
About IP Statistics.....	335
About T1/E1 Statistics.....	339
MULTIVOIP PROGRAM MENU ITEMS	347
Date and Time Setup.....	349
Obtaining Updated Firmware.....	349
Implementing a Software Upgrade	353
Identifying Current Firmware Version	353
Downloading Firmware.....	354
Downloading CAS Protocol	357
Downloading Factory Defaults.....	360
Setting and Downloading User Defaults	362
Setting a Password (Windows GUI)	364
Setting a Password (Web Browser GUI)	367
Un-Installing the MultiVOIP Software	368
Upgrading Software.....	370
FTP SERVER FILE TRANSFERS (“DOWNLOADS”).....	371

WEB BROWSER INTERFACE	381
SYSLOG SERVER FUNCTIONS	386
CHAPTER 11: WARRANTY, SERVICE, AND TECH SUPPORT	389
LIMITED WARRANTY	390
REPAIR PROCEDURES FOR U.S. AND CANADIAN CUSTOMERS	390
TECHNICAL SUPPORT.....	392
<i>Contacting Technical Support</i>	392
CHAPTER 12: REGULATORY INFORMATION	393
<i>EMC, Safety, and R&TTE Directive Compliance</i>	394
FCC DECLARATION.....	394
<i>Industry Canada</i>	395
<i>FCC Part 68 Telecom</i>	395
<i>Canadian Limitations Notice</i>	396
APPENDIX A: EXPANSION CARD INSTALLATION (MVP24-48 & MVP30-60).....	397
INSTALLATION.....	398
OPERATION.....	400
APPENDIX B: CABLE PINOUTS	401
APPENDIX B: CABLE PINOUTS.....	402
<i>Command Cable</i>	402
<i>Ethernet Connector</i>	402
<i>T1/E1 Connector</i>	403
<i>Voice/Fax Channel Connectors</i>	403
APPENDIX C: TCP/UDP PORT ASSIGNMENTS	405
WELL KNOWN PORT NUMBERS	406
PORT NUMBER ASSIGNMENT LIST	406
APPENDIX D: INSTALLATION INSTRUCTIONS FOR MVP428 UPGRADE CARD.....	407
INDEX	413

Chapter 1: Overview

About This Manual

This manual is about Voice-over-IP products made by Multi-Tech Systems, Inc. It describes three product groups.

1. T1 Digital MultiVOIP units, models MVP2400, MVP2410, and the capacity-doubling add-on expansion card, model MVP24-48.
2. E1 Digital MultiVOIP units, models, MVP3010 and the capacity-doubling add-on expansion card, model MVP30-60.
3. Analog MultiVOIP units, models MVP810, MVP410, and MVP210.

The table below describes the vital characteristics of these various models.

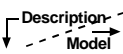
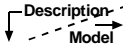
MultiVOIP Product Family					
 Description-Model	MVP 2400	MVP 2410	MVP 24-48	MVP 3010	MVP 30-60
Function	T1 digital VOIP unit	T1 digital VOIP unit	T1 digital VOIP add-on card	E1 digital VOIP unit	E1 digital VOIP add-on card
Capacity	24 channels	24 channels	24 added channels	30 channels	30 added channels
Chassis/ Mounting	table top	19" 1U rack mount	circuit card only	19" 1U rack mount	circuit card only
 Description-Model	MVP 810	MVP 428	MVP 410	MVP 210	
Function	analog voip	add-on card	analog voip	analog voip	
Capacity	8 channels	4 added channels	4 channels	2 channels	
Chassis/ Mounting	19" 1U rack mount	circuit card only	19" 1U rack mount	table top	

Variable Model/Version Icon and Typography. The MultiVOIP product family is a coordinated set of products that can operate with each other in a seamless fashion. For example, both the digital and analog MultiVOIP units use the same graphic user interface (GUI) in the MultiVOIP configuration software and both operate under a single GUI in the MultiVoipManager remote management software. Because this is the case, the various model numbers and version numbers of MultiVOIP family products will each appear in various dialog boxes and commands. But instead of showing these dialog boxes once for each model in this manual, we substitute the following icon.



Figure 1-1: Variable Model/Version Icon

It indicates that, whatever MultiVOIP model you are using, all details except the very model and version numbers themselves will be the same regardless of the MultiVOIP model used. Also, in some cases, we will use other typographic devices, like blank underlining (“MultiVOIP _____”) to denote information that applies to any and all of the products in this product family.

Introduction to T1 MultiVOIPs (MVP2400, MVP2410, & MVP24-48)

We proudly present MultiTech's T1 Digital Multi-VOIP products. The MVP2400 is a table-top model; the MVP2410 is a rack-mount model; and the MVP24-48 is an add-on expansion card that doubles the capacity of the MVP2410 without adding another chassis. All of these voice-over-IP products have fax capabilities. All adhere to the North American standard of T1 trunk telephony using digital 24-channel time-division multiplexing, which allows 24 phone conversations to occur on the T1 line simultaneously. All can also accommodate T1 lines of the ISDN Primary Rate Interface type (ISDN-PRI).

Scale-ability. The MVP2400 and MVP2410 are tailored to companies needing more than a few voice-over-IP lines, but not needing carrier-class equipment. When expansion is needed, the MVP2410 can be field-upgraded into a dual T1 unit by installing the MVP24-48 kit, which is essentially a second MultiVOIP motherboard that fits in an open expansion-card slot in the MVP2410. The upgraded dual unit then accommodates two T1 lines.

T1 VOIP Traffic. The MVP2400/2410 accepts its outbound traffic from a T1 trunk that's connected to either a PBX or to a telco/carrier. The MVP2400/2410 transforms the telephony signals into IP packets for transmission on LANs, WANs, or the Internet. Inbound IP data traffic is converted to telephony data and signaling.

When connected to PBX. When connected to a PBX, the MVP2400/2410 creates a network node served by 10/100-Base T connections. Local PBX phone extensions gain toll-free access to all phone stations directly connected to the VOIP network. Phone extensions at any VOIP location also gain toll-free access to the entire local public-switched telephone network (PSTN) at every other VOIP location in the system.

When connected to PSTN. When the T1 line(s) connected to the MVP2400/2410 are connected directly to the PSTN, the unit becomes a Point-of-Presence server dedicated to local calls off-net.

H.323 & SIP. Being H.323 compatible, the MVP2400/2410 can place calls to telephone equipment at remote IP network locations that also contain H.323 compatible voice-over-IP gateways. It will interface with H.323 software and H.323 gatekeeper units. H.323 specifications also bring to voip telephony many special features common to conventional telephony. H.323 features of this kind that have been implemented into the MultiVOIP include Call Hold, Call Waiting, Call Name

Identification, Call Forwarding (from the H.450 standard), and Call Transfer (H.450.2 from H.323 Version 2). The fourth version of the H.323 standard improves system resource usage (esp. logical port or socket usage) by handling call signaling more compactly and allowing use of the low-overhead UDP protocol instead of the error-correcting TCP protocol where possible.

The MultiVOIP is also SIP-compatible. However, H.450 Supplementary Services features can be used under H.323 only and not under SIP.

The MultiVOIP2400/2410 comes equipped with a variety of data compression capabilities, including G.723, G.729, and G.711 and features DiffServ quality-of-service (QoS) capabilities.

VOIP Functions. The MultiVOIP MVP2400/2410 gateway performs four basic functions: (a) it converts a dialed number into an IP address, (b) it sends voice over the data network, (c) it establishes a connection with another VOIP gateway at a remote site, and (d) it receives voice over the data network. Voice is handled as IP packets with a variety of compression options. Each T1 connection to the MultiVOIP provides 24 time-slot channels to connect to the telco or to serve phone or fax stations connected to a PBX.

Ports. The MVP2400/2410 also has a 10/100 Mbps Ethernet LAN interface, and a Command port for configuration. An MVP2410 upgraded with the MVP24-48 kit will have two Ethernet LAN interfaces and two Command ports.

Management. Configuration and system management can be done locally with the MultiVOIP configuration software. After an IP address has been assigned locally, other configuration can be done remotely using the MultiVOIP web browser GUI. Remote system management can be done with the MultiVoipManager SNMP software or via the MultiVOIP web browser GUI. All of these control software packages are included on the Product CD.

T1 Front Panel LEDs

The MVP2400, MVP2410, and MVP24-48 all use a common main circuit board or motherboard. Consequently the LED indicators are the same for all.

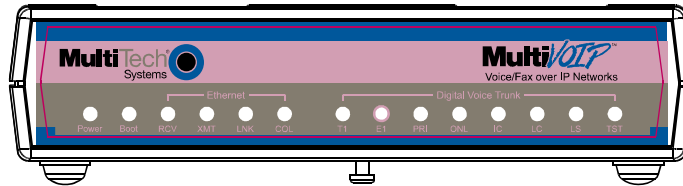

Figure 1-2. MultiVOIP MVP2400 Front Panel

Active LEDs. The MVP2410 front panel has two sets of identical LEDs. In the MVP2410 as shipped (that is, without an expansion card), the left-hand set of LEDs is functional whereas the right-hand set is not.

When the MVP2410 has been upgraded with an MVP24-48 kit, the right-hand set of LEDs will also become active.



Figure 1-3. MultiVOIP MVP2410 Chassis

T1 LED Descriptions

The descriptions below apply to all digital T1 MultiVOIP units.

MVP2400/2410 Front Panel LED Definitions

MVP2400/2410 Front Panel LED Definitions	
LED NAME	DESCRIPTION
Power	Indicates presence of power.
Boot	After power up, the Boot LED will be on for about 10 seconds while the MVP2400/2410 is booting.
RCV	Receive. Lights when receiving data on Ethernet port.
XMT	Transmit. Lights when transmitting data on Ethernet port.
LNK	Link. When lit, VOIP "sees" the hub or network via the Ethernet connection.
COL	Collision. Lit when data collisions occur.
T1	When lit, indicates presence of T1 connection.
E1	E1. Not supported.
PRI	PRI. On if T1 line is of ISDN-Primary-Rate type.
ONL	Online. This LED is on when frame synchronization has been established on the T1/E1 link.
IC	IC LED is on when Internal Clocking is selected in T1/E1 configuration.
LC	Indicates Loss of Carrier.
LS	Indicates Loss of Signal.
Test	For testing purposes only.

Introduction to E1 MultiVOIPs (MVP3010 & MVP30-60)

We proudly present MultiTech's E1 Digital Multi-VOIP products. The MVP3010 is a rack-mount model and the MVP30-60 is an add-on expansion card that doubles the capacity of the MVP3010 without adding another chassis. All of these voice-over-IP products have fax capabilities. All adhere to the European standard of E1 trunk telephony using digital 30-channel time-division multiplexing, which allows 30 phone conversations to occur on the E1 line simultaneously. All can also accommodate E1 lines of the ISDN Primary Rate Interface type (ISDN-PRI).

Scale-ability. The MVP3010 is tailored to companies needing more than a few voice-over-IP lines, but not needing carrier-class equipment. When expansion is needed, the MVP3010 can be field-upgraded into a dual E1 unit by installing the MVP30-60 kit, which is essentially a second MultiVOIP motherboard that fits into an open expansion-card slot in the MVP3010. The upgraded dual unit then accommodates two E1 lines.

E1 VOIP Traffic. The MVP3010 accepts its outbound traffic from a E1 trunk that's connected to either a PBX or to a telco/carrier. The MVP3010 transforms the telephony signals into IP packets for transmission on LANs, WANs, or the Internet. Inbound IP data traffic is converted to telephony data and signaling.

When connected to PBX. When connected to a PBX, the MVP3010 creates a network node served by 10/100-Base T connections. Local PBX phone extensions gain toll-free access to all phone stations directly connected to the VOIP network. Phone extensions at any VOIP location also gain local-rate access to the entire local public-switched telephone network (PSTN) at every other VOIP location in the system.

When connected to PSTN. When the E1 line(s) connected to the MVP3010 are connected directly to the PSTN, the unit becomes a Point-of-Presence server dedicated to local calls off-net.

H. 323 & SIP. Being H.323 compatible, the MVP3010 can place calls to telephone equipment at remote IP network locations that also contain H.323 compatible voice-over-IP gateways. It will interface with H.323 software and H.323 gatekeeper units. H.323 specifications also bring to voip telephony many special features common to conventional telephony. H.323 features of this kind that have been implemented into the MultiVOIP include Call Hold, Call Waiting, Call Identification, Call Forwarding (from the H.450 standard), and Call Transfer (H.450.2 from

H.323 Version 2). The fourth version of the H.323 standard improves system resource usage (esp. logical port or socket usage) by handling call signaling more compactly and allowing use of the low-overhead UDP protocol instead of the error-correcting TCP protocol where possible.

The MultiVOIP is also SIP-compatible. However, H.450 Supplementary Services features can be used under H.323 only and not under SIP.

The MultiVOIP3010 comes equipped with a variety of data compression capabilities, including G.723, G.729, and G.711 and features DiffServ quality-of-service (QoS) capabilities.

VOIP Functions. The MultiVOIP MVP3010 gateway performs four basic functions: (a) it converts a dialed number into an IP address, (b) it sends voice over the data network, (c) it establishes a connection with another VOIP gateway at a remote site, and (d) it receives voice over the data network. Voice is handled as IP packets with a variety of compression options. Each E1 connection to the MultiVOIP provides 30 time-slot channels to connect to the telco or to serve phone or fax stations connected to a PBX.

Ports. The MVP3010 also has a 10/100 Mbps Ethernet LAN interface, and a Command port for configuration. An MVP3010 upgraded with the MVP30-60 kit will have two Ethernet LAN interfaces and two Command ports.

Management. Configuration and system management can be done locally with the MultiVOIP configuration software. After an IP address has been assigned locally, other configuration can be done remotely using the MultiVOIP web browser GUI. Remote system management can be done with the MultiVoipManager SNMP software or via the MultiVOIP web browser GUI. All of these control software packages are included on the Product CD.

E1 Front Panel LEDs

Because the MVP3010 and MVP30-60 both use a common main circuit card or motherboard, the LED indicators are the same for both.



Figure 1-4. MultiVOIP MVP3010 Chassis

Active LEDs. The MVP3010 front panel has two sets of identical LEDs. In the MVP3010 as shipped (that is, without an expansion card), the left-hand set of LEDs is functional whereas the right-hand set is not.

When the MVP3010 has been upgraded with an MVP30-60 kit, the right-hand set of LEDs will also become active.

E1 LED Descriptions

MVP3010 Front Panel LED Definitions

MVP3010 Front Panel LED Definitions	
LED NAME	DESCRIPTION
Power	Indicates presence of power.
Boot	After power up, the Boot LED will be on for about 10 seconds while the MVP3010 is booting.
RCV	Receive. Lights when receiving data on Ethernet port.
XMT	Transmit. Lights when transmitting data on Ethernet port.
LNK	Link. When lit, VOIP “sees” the hub or network via the Ethernet connection.
COL	Collision. Lit when data collisions occur.

MVP3010 Front Panel LED Definitions (cont'd)	
T1	T1. Not supported.
E1	E1. When lit, indicates presence of E1 connection.
PRI	PRI. On if E1 line is of ISDN-Primary-Rate type.
ONL	Online. This LED is on when frame synchronization has been established on the T1/E1 link.
IC	IC LED is on when Internal Clocking is selected in T1/E1 configuration.
LC	Indicates Loss of Carrier.
LS	Indicates Loss of Signal.
Test	For testing purposes only. For testing purposes only.

Introduction to Analog MultiVOIPs (MVP-210/410/810 & MVP428)

VOIP: The Free Ride. We proudly present Multi-Tech's MVP-210/410/810 generation of MultiVOIP Voice-over-IP Gateways. They allow voice/fax communication to be transmitted at no additional expense over your existing IP network, which has ordinarily been data-only. To access this free voice and fax communication, you simply connect the MultiVOIP to your telephone equipment and your existing Internet connection. These analog MultiVOIPs inter-operate readily with T1 or E1 MultiVOIPs units.

Capacity. The MultiVOIP model MVP810 is a eight-channel unit, the MVP410 a four-channel unit, and the MVP210 a two-channel unit. All of these MultiVOIP units have a 10/100Mbps Ethernet interface and a command port for configuration. The MVP428 is an expansion circuit card for the four-channel MVP410 that turns it into an eight-channel voip.

Mounting. Mechanically, the MVP410 and MVP810 MultiVOIPs are designed for a one-high industry-standard EIA 19-inch rack enclosure. By contrast, the MVP210 is a table-top unit. The product must be installed by qualified service personnel in a restricted-access area, in accordance with Articles 110-16, 10-17, and 110-18 of the National Electrical Code, ANSI/NFPA 70.

Phone System Transparency. These MultiVOIPs inter-operate with a telephone switch or PBX, acting as a switching device that directs voice and fax calls over an IP network. The MultiVOIPs have "phonebooks," directories which determine to who calls may be made and the sequences that must be used to complete calls through the MultiVOIP. The phonebooks allow the phone user to interact with the VOIP system just as they would with an ordinary PBX or telco switch. When the phonebooks are set, special dialing sequences are minimized or eliminated altogether. Once the call destination is determined, the phonebook settings determine whether the destination VOIP unit must strip off or add dialing digits to make the call appear at its destination to be a local call.

H.323 & SIP. The MultiVOIP supports the H.323 standards-based protocol enabling your MultiVOIP to participate in real-time conferencing with other third-party VOIP Gateways or endpoints that support the H.323 protocol (for example, Microsoft NetMeeting®). The H.323 standard defines how endpoints make and receive calls, how endpoints negotiate a common set of audio and data capabilities, how information is formatted and sent over the network, and how endpoints communicate with their respective Gatekeepers.

H.323 specifications also bring to voip telephony many special features common to conventional telephony. H.323 features of this kind that have been implemented into the MultiVOIP include Call Hold, Call Waiting, Call Identification, Call Forwarding (from the H.450 standard), and Call Transfer (H.450.2 from H.323 Version 2). The fourth version of the H.323 standard improves system resource usage (esp. logical port or socket usage) by handling call signaling more compactly and allowing use of the low-overhead UDP protocol instead of the error-correcting TCP protocol where possible.

The MultiVOIP is also SIP-compatible. However, H.450 Supplementary Services features can be used under H.323 only and not under SIP.

Gatekeepers. Gatekeeper software is optional and when used in a network, it typically resides on a designated PC. It acts as the central point for all calls within its zone and provides call control services to all registered endpoints. In addition, Gatekeepers can perform bandwidth management through support for Bandwidth Request, Confirm, and Reject messages.

Management. Configuration and system management can be done locally with the MultiVOIP configuration software. After an IP address has been assigned locally, other configuration can be done remotely using the MultiVOIP web browser GUI. Remote system management can be done with the MultiVoipManager SNMP software or via the MultiVOIP web browser GUI. All of these control software packages are included on the Product CD.



Figure 1-5: MVP-410/810 Chassis

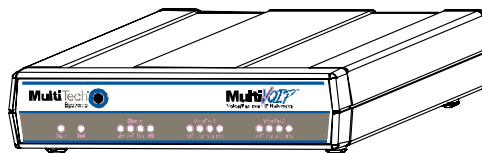

Figure 1-6: MVP-210 Chassis

Analog MultiVOIP Front Panel LEDs

LED Types. The MultiVOIPs have two types of LEDs on their front panels:

- (1) general operation LED indicators (for power, booting, and ethernet functions), and
- (2) channel operation LED indicators which describe the data traffic and performance in each VOIP data channel.

Active LEDs. On both the MVP410 and MVP810, there are eight sets of channel-operation LEDs. However, on the MVP410, only the lower four sets of channel-operation LEDs are functional. On the MVP810, all eight sets are functional.



Figure 1-7. MVP410/810 Front Panel

Similarly, the MVP210 has the general-operation indicator LEDs and two sets of channel-operation LEDs, one for each channel.

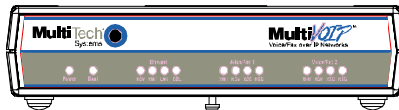

Figure 1-8. MVP210 Front Panel

Analog MultiVOIP LED Descriptions

MVP-210/410/810 Front Panel LED Definitions	
LED NAME	DESCRIPTION
General Operation LEDs (one set on each MultiVOIP model)	
Power	Indicates presence of power.
Boot	After power up, the Boot LED will be on briefly while the MultiVOIP is booting. It lights whenever the MultiVOIP is booting or downloading a setup configuration data set.
Ethernet	<p>RCV. Receive. Lights (blinks) when receiving data on Ethernet port.</p> <p>XMT. Transmit. Lights (blinks) when transmitting data on Ethernet port. ..</p> <p>LNK. Link. When lit, VOIP “sees” the hub or network via the Ethernet connection. ..</p> <p>COL. Collision. Lit when data collisions occur. ..</p>
Channel-Operation LEDs (one set for each channel)	
XMT	Transmit. This indicator blinks when voice packets are being transmitted to the local area network.
RCV	Receive. This indicator blinks when voice packets are being received from the local area network.
XSG	Transmit Signal. This indicator lights when the FXS-configured channel is off-hook, the FXO-configured channel is receiving a ring from the Telco, or the M lead is active on the E&M configured channel. That is, it lights when the MultiVOIP is receiving a ring from the PBX.
RSG	Receive Signal. This indicator lights when the FXS-configured channel is ringing, the FXO-configured channel has taken the line off-hook, or the E lead is active on the E&M-configured channel.

Computer Requirements

The computer on which the MultiVOIP's configuration program is installed must meet these requirements:

- must be IBM-compatible PC with MS Windows operating system;
- must have an available COM port for connection to the MultiVOIP.

However, this PC does not need to be connected to the MultiVOIP permanently. It only needs to be connected when local configuration and monitoring are done. Nearly all configuration and monitoring functions can be done remotely via the IP network.

Specifications

Specs for Digital T1 MultiVOIP Units

Digital T1 MultiVOIP Specifications			
Parameter/Model	MVP-2400	MVP-2410	MVP-2410 w/ MVP24-48 Expansion Card
Operating Voltage(s)	External transformer: 1.6A@5v	100-240 VAC 1.2 - 0.6 A	100-240 VAC 1.2 - 0.6 A
Mains Frequencies	50/60 Hz	50/60 Hz	50/60 Hz
Power Consumption	13 watts	17 watts	27 watts
Mechanical Dimensions	6.2" W x 9" D x 1.4" H 15.8cm W x 22.9cm D x 3.6cm H	1.75"H x 17.4"W x 8.75"D 4.5cm H x 44.2 cm W x 22.2 cm D	1.75"H x 17.4"W x 8.75"D 4.5cm H x 44.2 cm W x 22.2 cm D
Weight	1.8lbs (.82kg) 2.2lbs (.98kg) with transformer	7.1 lbs. (3.2 kg)	7.5 lbs. (3.4 kg)

Specs for Digital E1 MultiVOIP Units

Digital E1 MultiVOIP Specifications		
Parameter/Model	MVP-3010	MVP-3010 w/ MVP30-60 Expansion Card
Operating Voltage(s)	100-240 VAC 1.2 - 0.6 A	100-240 VAC 1.2 - 0.6 A
Mains Frequencies	50/60 Hz	50/60 Hz
Power Consumption	17 watts	27 watts
Mechanical Dimensions	1.75"H x 17.4"W x 8.75"D 4.5cm H x 44.2 cm W x 22.2 cm D	1.75"H x 17.4"W x 8.75"D 4.5cm H x 44.2 cm W x 22.2 cm D
Weight	7.1 lbs. (3.2 kg)	7.5 lbs. (3.4 kg)

Specs for Analog MultiVOIP Units

Analog MultiVOIP Specifications			
Parameter/Model	MVP210	MVP410	MVP810 or MVP410 + 428
Operating Voltage(s)	External transformer: 3A @5V	100-240 VAC 1.2 - 0.6 A	100-240 VAC 1.2 - 0.6 A
Mains Frequencies	50/60 Hz	50/60 Hz	50/60 Hz
Power Consumption	19 watts	29 watts	46 watts
Mechanical Dimensions	6.2" W x 9" D x 1.4" H 15.8cm W x 22.9cm D x 3.6cm H	1.75"H x 17.4"W x 8.5"D 4.5cm H x 44.2 cm W x 21.6 cm D	1.75"H x 17.4"W x 8.5"D 4.5cm H x 44.2 cm W x 21.6 cm D
Weight	1.8lbs (.82kg) 2.6lbs (1.17kg) with transformer	7.1 lbs. (3.2 kg)	7.7 lbs. (3.5 kg)

Installation at a Glance

The basic steps of installing your MultiVOIP network involve unpacking the units, connecting the cables, and configuring the units using management software (MultiVOIP Configuration software) and confirming connectivity with another voip site. This process results in a fully functional Voice-Over-IP network.

Related Documentation

The MultiVOIP User Guide (the document you are now reading) comes in electronic form and is included on your system CD. It presents in-depth information on the features and functionality of Multi-Tech's MultiVOIP Product Family.

The CD media is produced using Adobe Acrobat™ for viewing and printing the user guide. To view or print your copy of a user guide, load Acrobat Reader™ on your system. The Acrobat Reader is included on the MultiVOIP CD and is also a free download from Adobe's Web Site:

www.adobe.com/prodindex/acrobat/readstep.html

This MultiVOIP User Guide is also available on Multi-Tech's Web site at:

<http://www.multitech.com>

Viewing and printing a user guide from the Web also requires that you have the Acrobat Reader loaded on your system. To select the MultiVOIP User Guide from the Multi-Tech Systems home page, click **Documents** and then click **MultiVOIP Family** in the product list drop-down window. All documents for this MultiVOIP Product Family will be displayed. You can then choose *User Guide (MultiVOIP Product Family)* to view or download the **.pdf** file.

Chapter 2: Quick Start Instructions

Introduction

This chapter gets the MultiVOIP up and running quickly. The details we've skipped to make this brief can be found elsewhere in the manual (see Table of Contents and Index).

MultiVOIP Startup Tasks

Task	Summary
● Collecting Phone/IP Details (vital!)	The MultiVOIP must be configured to interface with your particular phone system and IP network. To do so, certain details must be known about those phone and IP systems.
● Placement	Decide where you'll mount the voip.
● The Command/Control Computer: Specs & Settings	Some modest minimum specifications must be met. A COM port must be set up.
● Hookup	Connect power, phone, and data cables per diagram.
● Software Installation	This is the configuration program. It's a standard Windows software installation.
● Phone/IP Starter Configuration	You will enter phone numbers and IP addresses. You'll use default parameter values where possible to get the system running quickly.
● Phonebook Starter Configuration	The phonebook is where you specify how calls will be routed. To get the system running quickly, you'll make phonebooks for just two voip sites.
● Connectivity Test	You'll find out if your voip system can carry phone calls between two sites. That means you're up and running!
● Troubleshooting	Detect and remedy any problems that might have prevented connectivity.

Phone/IP Details *Absolutely Needed* Before Starting the Installation

Gather IP Information

➤	Ask your computer network administrator.	<i>Info needed to operate:</i> all MultiVOIP models.
	 IP Network Parameters: Record for each VOIP Site in System	
	<ul style="list-style-type: none"> • IP Address 	
	<ul style="list-style-type: none"> • IP Mask 	
	<ul style="list-style-type: none"> • Gateway 	
	<ul style="list-style-type: none"> • Domain Name Server (DNS) Info <i>(not implemented; for future use)</i> 	

Gather Telephone Information

➤	T1 Phone Parameters <i>Ask phone company or PBX maintainer.</i>	<i>Info needed to operate:</i> MVP2400 MVP2410
	 T1 Telephony Parameters: Record for this VOIP Site	
	<ul style="list-style-type: none"> • Which frame format is used? ESF___ or D4___ 	
	<ul style="list-style-type: none"> • Which CAS or PRI protocol is used? _____ 	
	<ul style="list-style-type: none"> • Clocking: Does the PBX or telco switch use internal or external clocking? _____ Note that the setting used in the voip unit will be the opposite of the setting used by the telco/PBX. 	
	<ul style="list-style-type: none"> • Which line coding is used? AMI___ or B8ZS___ 	
	<ul style="list-style-type: none"> • Pulse shape level?: (most commonly 0 to 40 meters) 	

Phone/IP Details *Absolutely Needed* (cont'd)

Gather Telephone Information

➤	E1 Phone Parameters <i>Ask phone company or PBX maintainer.</i>	<i>Info needed to operate:</i> MVP3010
	 E1 Telephony Parameters: Record for this VOIP Site	
	<ul style="list-style-type: none"> • Which frame format is used? Double Frame _____ MultiFrame w/ CRC4 _____ MultiFrame w/ CRC4 modified _____ 	
	<ul style="list-style-type: none"> • Which CAS or PRI protocol is used? _____ 	
	<ul style="list-style-type: none"> • Clocking: Does the PBX or telco switch use internal or external clocking? _____ Note that the setting used in the voip unit will be the opposite of the setting used by the telco/PBX. 	
	<ul style="list-style-type: none"> • Which line coding is used? AMI ___ or HDB3 ___ 	
	<ul style="list-style-type: none"> • Pulse shape level?: (most commonly 0 to 40 meters) 	

Gather Telephone Information

➤	Analog Phone Parameters <i>Ask phone company or telecom manager.</i>	<i>Needed for:</i> MVP810 MVP410 MVP210
	 Analog Telephony Interface Parameters: Record for this VOIP Site	
	<ul style="list-style-type: none"> • Which interface type (or “signaling”) is used? E&M _____ FXS/FXO _____ 	
	<ul style="list-style-type: none"> • If FXS, determine whether the line will be used for a phone, fax, or KTS (key telephone system) 	
	<ul style="list-style-type: none"> • If FXO, determine if line will be an analog PBX extension or an analog line from a telco central office 	
	<ul style="list-style-type: none"> • If E&M, determine these aspects of the E&M trunk line from the PBX: <ul style="list-style-type: none"> • What is its Type (1, 2, 3, 4, or 5)? • Is it 2-wire or 4-wire? • Is it Dial-Tone or Wink? 	

Phone/IP Details Often Needed/Wanted

Obtain Email Address for VOIP (for email call log reporting)

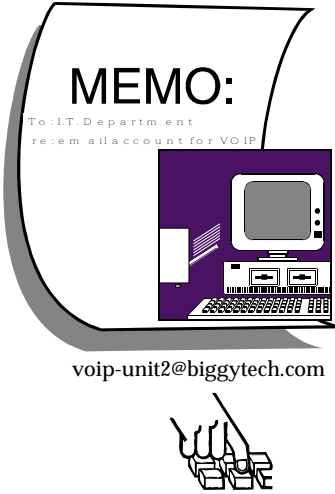
<i>required if log reports of VOIP call traffic are to be sent by email</i>	Optional
<p>SMTP Parameters Preparation Task:</p> <p>Ask Mail Server administrator to set up email account (with password) for the MultiVOIP unit itself. Be sure to give a unique identifier to each individual MultiVOIP unit.</p> <p>Get the IP address of the mail server computer, as well.</p>	

Identify Remote VOIP Site to Call

When you're done installing the MultiVOIP, you'll want to confirm that it is configured and operating properly. To do so, it's good to have another voip that you can call for testing purposes. You'll want to confirm end-to-end connectivity. You'll need IP and telephone information about that remote site.

If this is the very first voip in the system, you'll want to coordinate the installation of this MultiVOIP with an installation of another unit at a remote site.

Identify VOIP Protocol to be Used

Will you use H.323 or SIP? Each has advantages and disadvantages. Although it is possible to mix protocols in a single VOIP system, it is highly desirable to use the same VOIP protocol for all VOIP units in the system.

Placement

Mount your MultiVOIP in a safe and convenient location where cables for your network and phone system are accessible. Rack-mounting instructions are in *Chapter 3: Mechanical Installation & Cabling*.

The Command/Control Computer (Specs & Settings)

The computer used for command and control of the MultiVOIP

- (a) must be an IBM-compatible PC,
- (b) must use a Microsoft operating system,
- (c) must be connected to your local network (Ethernet) system, and
- (d) must have an available serial COM port.

The configuration tasks and control tasks the PC will have to do with the MultiVOIP are not especially demanding. Still, we recommend using a reasonably new computer. The computer that you use to configure your MultiVOIP need not be dedicated to the MultiVOIP after installation is complete.

COM port on controller PC. You'll need an available COM port on the controller PC. You'll need to know which COM port is available for use with the MultiVOIP (COM1, COM2, etc.).

Quick Hookups

Hookup for MVP2410 & MVP3010

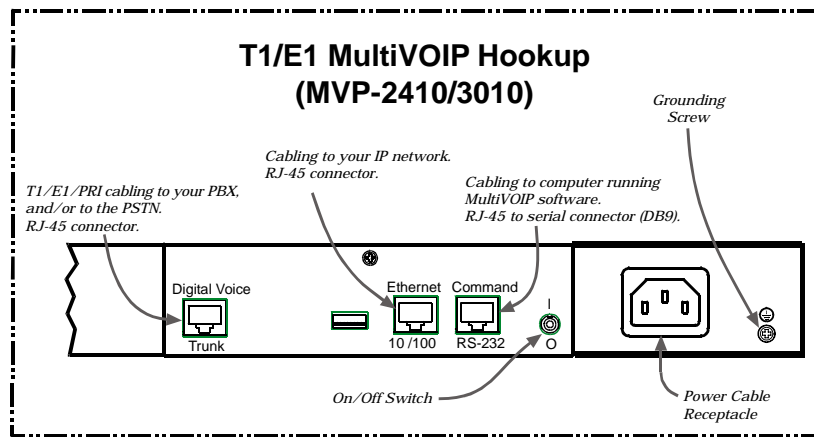

Hookup for MVP410 & MVP810

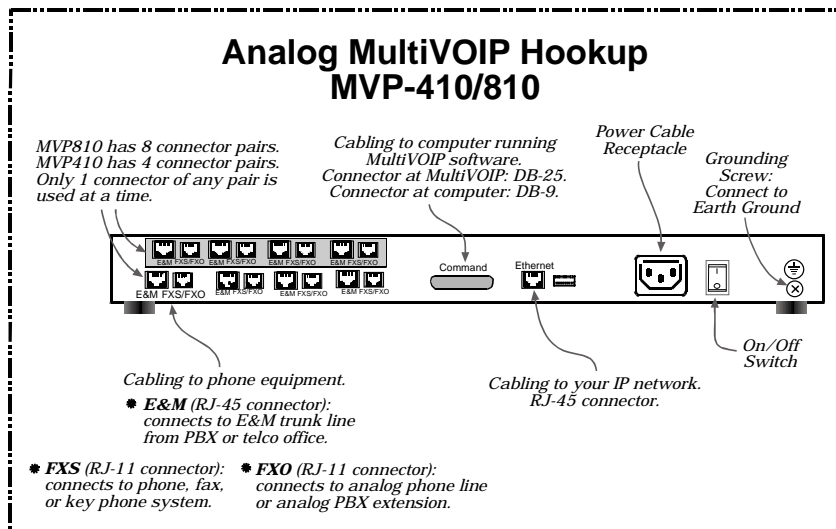

Hookup for MVP2400

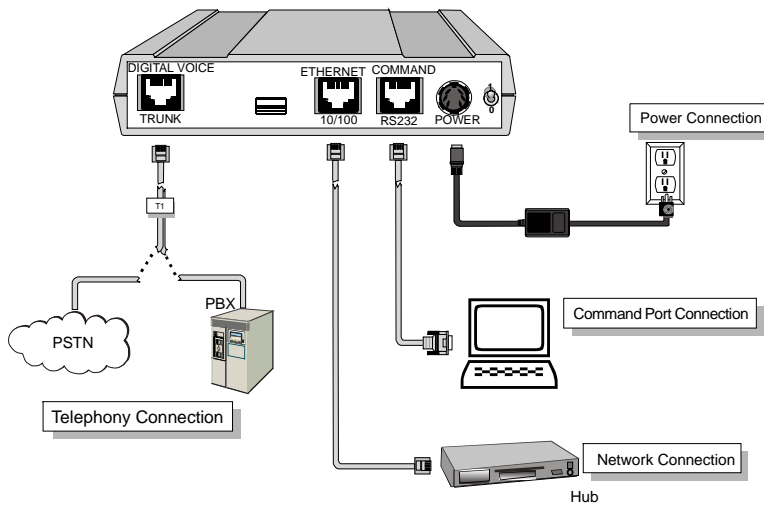

Hookup for MVP210

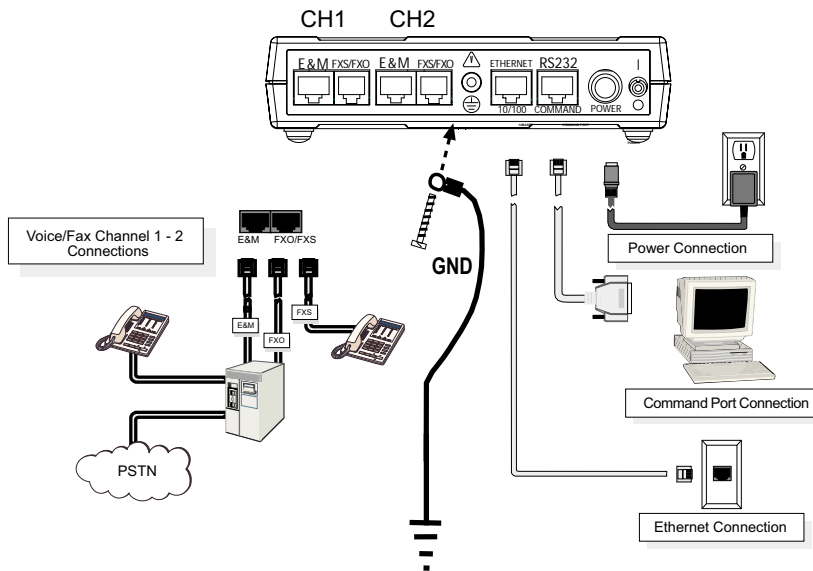

Load MultiVOIP Control Software onto PC

For more details, see *Chapter 4: Software Installation*.

1. MultiVOIP must be properly cabled. Power must be turned on.
2. Insert MultiVOIP CD into drive. Allow 10-20 seconds for Autorun to start. If Autorun fails, go to **My Computer | CD ROM drive | Open**. Click **Autorun** icon.
3. At first dialog box, click **Install Software**.
4. At 'welcome' screen, click **Next**.
5. Follow on-screen instructions. Accept default program folder location and click **Next**.
6. Accept default icon folder location. Click **Next**. Files will be copied.
7. Select available COM port on command/control computer.
8. At completion screen, click **Finish**.
9. At the prompt "Do you want to run MultiVOIP Configuration?," click **No**. Software installation is complete.

Phone/IP Starter Configuration

Full details here:

MVP2400 MVP2410 MVP3010	<i>Chapter 5: Technical Configuration for Digital T1/E1 MultiVOIPs</i>
MVP210 MVP410 MVP810	<i>Chapter 6: Technical Configuration for Analog MultiVOIPs</i>

1. Open MultiVOIP program: **Start | MultiVOIP xxx | Configuration.**
2. Go to **Configuration | IP.** Enter the IP parameters for your voip site.
3. Do you want to configure and operate the MultiVOIP unit using the web browser GUI? (It has the same functionality as the local Windows GUI, but offers remote access.)
If NO, skip to step 5.
If YES, continue with step 4.
4. **Enable Web Browser GUI (Optional).** To do configuration and operation procedures using the web browser GUI, you must first enable it. To do so, follow these steps.

A. Be sure an IP address has been assigned to the MultiVOIP unit (this must be done in the MultiVOIP Windows GUI).	E. Open web browser. (Note: The PC being used must be connected to and have an IP address on the same IP network that the voip is on.)
B. Save Setup in Windows GUI.	F. Browse to IP address of MultiVOIP unit.
C. Close the MultiVOIP Windows GUI.	G. If username and password have been established, enter them when prompted by voip.
D. Install Java program from MultiVOIP product CD. <i>NOTE: Required on first use of Web Browser GUI only.</i>	H. Use web browser GUI to configure or operate voip.
Need more info?	See "Web Browser Interface" in <i>Operation & Maintenance</i> chapter of User Guide (on CD).

Once you've begun using the web browser GUI, you can go back to the MultiVOIP Windows GUI at any time. However, you must log out of the web browser GUI before using the MultiVOIP Windows GUI.

5. Go to **Configuration | Voice/Fax**. Select **Coder | “Automatic.”** At the right-hand side of the dialog box, click **Default**. If you know any specific parameter values that will apply to your system, enter them. Click **Copy Channel**. Select **Copy to All**. Click **Copy**. At main Voice/Fax Parameters screen, click **OK** to exit from the dialog box.
6. Enter telephone system information.

Analog MultiVOIPs MVP-210/410/810	Digital MultiVOIPs MVP-2400/2410/3010
Go to Configuration Interface. Enter parameters obtained from phone company or PBX administrator.	Go to Configuration T1/E1/ISDN. Enter parameters obtained from phone company or PBX administrator.

7. Go to **Configuration | Regional Parameters**. Select the **Country/Region** that fits your situation. Click **Default** and confirm. Click **OK** to exit from the dialog box.
8. Do you want the phone-call logs produced by the MultiVOIP to be sent out by email (to your Voip Administrator or someone else)?
If NO, skip to step 10.
If YES, continue with step 9.
9. Go to **Configuration | SMTP**.
SMTP lets you send phone-call log records to the Voip Administrator by email. Select **Enable SMTP**.
You should have already obtained an email address for the MultiVOIP itself (this serves as the origination email account for email logs that the MultiVOIP can email out automatically).

Enter this email address in the “Login Name” field.
Type the password for this email account.

Enter the IP address of the email server where the MultiVOIP’s email account is located in the “Mail Server IP Address” field.

Typically the email log reports are sent to the Voip Administrator but they can be sent to any email address. Decide where you want the email logs sent and enter that email address in the “Recipient Address” field.

Phone/IP Starter Configuration (continued)

9. (continued) Whenever email log messages are sent out, they must have a standard Subject line. Something like “Phone Logs for Voip N” is useful. If you have more than one MultiVoip unit in the building, you’ll need a unique identifier for each one (select a useful name or number for “N”). In this “Subject” field, enter a useful subject title for the log messages.

In the “Reply-To Address” field, enter the email address of your Voip Administrator.

10. Go to **Configuration | Logs**.
Select “Enable Console Messages.” (*Not applicable if using Web GUI*)

To allow log reports by email (if desired), click **SMTP**. Click **OK**.

To do logging with a SysLog client program, click on “SysLog Server – Enable” in the **Logs** screen. To implement this function, you must install a SysLog client program. For more info, see the “SysLog Server Functions” section of the *Operation & Maintenance* chapter of the **User Guide**.

11. Enable premium (H.450) telephony features.

Go to **Supplementary Services**. Select any features to be used. For Call Hold, Call Transfer, & Call Waiting, specify the key sequence that the phone user will press to invoke the feature. For Call Name Identification, specify the allowed name types to be used and a caller-id descriptor.

If Call Forwarding is to be used, enable this feature in the **Add/Edit Inbound Phone Book** screen.

12. Go to **Save Setup | Save and Reboot**. Click **OK**. This will save the parameter values that you have just entered.

The MultiVOIP’s “BOOT” LED will light up while the configuration file is being saved and loaded into the MultiVOIP. Don’t do anything to the MultiVOIP until the “BOOT” LED is off (a loss of power at this point could cause the MultiVOIP unit to lose the configuration settings you have made).

END OF PROCEDURE.

Phonebook Starter Configuration (*with remote voip*)

To do this part of the quick setup, you need to know of another voip that you can call to conduct a test. It should be at a remote location, typically somewhere outside of your building. You must know the phone number and IP address for that site. We are assuming here that the MultiVOIP will operate in conjunction with a PBX.

You must configure both the Outbound Phonebook and the Inbound Phonebook. A starter configuration only means that two voip locations will be set up to begin the system and establish voip communication.

Outbound Phonebook

1. Open the MultiVOIP program
(Start | MultiVOIP xxx | Configuration)
2. Go to **Phone Book | PhoneBook Modify | Outbound Phonebook | Add Entry.**
3. On a sheet of paper, write down the calling code of the remote voip (area code, country code, city code, etc.) that you'll be calling.

Follow the example that best fits your situation.

North America, Long-Distance Example

Technician in Seattle (area 206) must set up one voip there, another in Chicago (area 312, downtown).

Answer: Write down **312**.

Euro, National Call Example

Technician in central London (area 0207) to set up voip there, another in Birmingham (area 0121).

Answer: write down **0121**.

Euro, International Call Example

Technician in Rotterdam (country 31; city 010) to set up one voip there, another in Bordeaux (country 33; area 05).

Answer: write down **3305**.

4. Suppose you want to call a phone number outside of your building using a phone station that is an extension from your PBX system (if present). What digits must you dial? Often a “9” or “8” must be dialed to “get an outside line” through the PBX (i.e., to connect to the PSTN). Generally, “1” or “11” or “0” must be dialed as a prefix for calls outside of the calling code area (long-distance calls, national calls, or international calls).

On a sheet of paper, write down the digits you must dial before you can dial a remote area code.

**North America,
Long-Distance Example**

Seattle-Chicago system.

Seattle voip works with PBX that uses “8” for all voip calls. “1” must immediately precede area code of dialed number.

Answer: write down 81.

**Euro, National Call
Example**

London/Birming. system.

London voip works with PBX that uses “9” for all out-of-building calls whether by voip or by PSTN. “0” must immediately precede area code of dialed number.

Answer: write down 90.

Euro, International Call Example

Rotterdam/Bordeaux system.

Rotterdam voip works with PBX where “9” is used for all out-of-building calls. “0” must precede all international calls.

Answer: write down 90.

5. In the “Destination Pattern” field of the **Add/Edit Outbound Phonebook** screen, enter the digits from step 4 followed by the digits from step 3.

<p>North America, Long-Distance Example Seattle-Chicago system. Answer: enter 81312 as Destination Pat- tern in Outbound Phone-book of Seattle voip.</p>	<p>Euro, National Call Example London/Birming. system. Leading zero of Birmingham area code is dropped when combined with national-dialing access code. (Such practices vary by country.) Answer: enter 90121 as Destination Pat- tern in Outbound Phonebook of London voip. <i>Not 900121.</i></p>
<p>Euro, International Call Example Rotterdam/Bordeaux system. Answer: enter 903305 as Destination Pattern in Outbound Phonebook of Rotterdam voip.</p>	

6. Tally up the number of digits that must be dialed to reach the remote voip site (including prefix digits of all types). Enter this number in the “Total Digits” field.

<p>North America, Long-Distance Example Seattle-Chicago system.</p> <p>To complete Seattle-to-Chicago call, 81312 must be followed by the 7-digit local phone number in Chicago.</p> <p>Answer: enter 12 as number of Total Digits in Outbound Phonebook of Seattle voip.</p>	<p>Euro, National Call Example London/Birming. system.</p> <p>To complete London-to-Birmingham call, 90121 must be followed by the 7-digit local phone number in Birmingham.</p> <p>Answer: enter 12 as number of Total Digits in Outbound Phonebook of London voip.</p>
<p>Euro, International Call Example Rotterdam/Bordeaux system.</p> <p>To complete Rotterdam-to-Bordeaux call, 903305 must be followed by 8-digit local phone number in Bordeaux.</p> <p>Answer: enter 14 as number of Total Digits in Outbound Phonebook of Rotterdam voip.</p>	

7. In the “Remove Prefix” field, enter the initial PBX access digit (“8” or “9”).

<p>North America, Long-Distance Example Seattle-Chicago system.</p> <p>Answer: enter 8 in “Remove Prefix” field of Seattle Outbound Phonebook.</p>	<p>Euro, National Call Example London/Birming. system.</p> <p>Answer: enter 9 in “Remove Prefix” field of London Outbound Phonebook.</p>
<p>Euro, International Call Example Rotterdam/Bordeaux system.</p> <p>Answer: enter 9 in “Remove Prefix” field of Outbound Phonebook for Rotterdam voip.</p>	

Some PBXs will not ‘hand off’ the “8” or “9” to the voip. But for those PBX units that do, it’s important to enter the “8” or “9” in the “Remove Prefix”

field in the Outbound Phonebook. This precludes the problem of having to make two inbound phonebook entries at remote voips, one to account for situations where “8” is used as the PBX access digit, and another for when “9” is used.

8. Select the voip protocol that you will use (H.323 or SIP).
9. Click **OK** to exit from the **Add/Edit Outbound Phonebook** screen.

Inbound Phonebook

1. Open the MultiVOIP program.
(**Start** | **MultiVOIP xxx** | **Configuration**)
2. Go to **Phone Book** | **PhoneBook Modify** | **Inbound Phonebook** | **Add Entry**.
3. In the “Remove Prefix” field, enter your local calling code (area code, country code, city code, etc.) preceded by any other “access digits” that are required to reach your local site from the remote voip location (think of it as though the call were being made through the PSTN – even though it will not be).

North America, Long-Distance Example

Seattle-Chicago system.

Seattle is area 206. Chicago employees must dial 81 before dialing any Seattle number on the voip system.

Answer: **1206** is prefix to be removed by local (Seattle) voip.

Euro, National Call Example

London/Birming. system.

Inner London is 0207 area. Birmingham employees must dial 9 before dialing any London number on the voip system.

Answer: **0207** is prefix to be removed by local (London) voip.

Euro, International Call Example

Rotterdam/Bordeaux system.

Rotterdam is country code 31, city code 010. Bordeaux employees must dial 903110 before dialing any Rotterdam number on the voip system.

Answer: **03110** is prefix to be removed by local (Rotterdam) voip.

4. In the “Add Prefix” field, enter any digits that must be dialed from your local voip to gain access to the PSTN.

<p>North America, Long-Distance Example</p> <p>Seattle-Chicago system.</p> <p>On Seattle PBX, “9” is used to get an outside line.</p> <p>Answer: 9 is prefix to be added by local (Seattle) voip.</p>	<p>Euro, National Call Example</p> <p>London/Birming. system.</p> <p>On London PBX, “9” is used to get an outside line.</p> <p>Answer: 9 is prefix to be added by local (London) voip.</p>
<p>Euro, International Call Example</p> <p>Rotterdam/Bordeaux system.</p> <p>On Rotterdam PBX, “9” is used to get an outside line.</p> <p>Answer: 9 is prefix to be added by local (Rotterdam) voip.</p>	

5. In the “Channel Number” field, enter “0.” A zero value means the voip unit will assign the call to an available channel. If desired, specific channels can be assigned to specific incoming calls (i.e., to any set of calls received with a particular incoming dialing pattern).

6. In the “Description” field, it is useful to describe the ultimate destination of the calls. For example, in a New York City voip system, “incoming calls to Manhattan office,” might describe a phonebook entry, as might the descriptor “incoming calls to NYC local calling area.” The description should make the routing of calls easy to understand. (40 characters max.)

<p>North America, Long-Distance Example</p> <p>Seattle-Chicago system.</p> <p>Possible Description: Free Seattle access, all employees</p>	<p>Euro, National Call Example</p> <p>London/Birming. system.</p> <p>Possible Description: Local-rate London access, all empl.</p>
<p>Euro, International Call Example</p> <p>Rotterdam/Bordeaux system.</p> <p>Possible Description: Local-rate Rotterdam access, all empl.</p>	

7. Repeat steps 2-6 for each inbound phonebook entry. When all entries are complete, go to step 8.
8. Click **OK** to exit the inbound phonebook screen.
9. Click on **Save Setup**. Highlight **Save and Reboot**. Click **OK**.
- Your starter inbound phonebook configuration is complete.

Phonebook Tips

Preparing the phonebook for your voip system is a complex task that, at first, seems quite daunting. These tips may make the task easier.

1. Use Dialing Patterns, Not Complete Phone Numbers. You will not generally enter complete phone numbers in the voip phonebook. Instead, you'll enter "destination patterns" that involve area codes and other digits. If the destination pattern is a whole area code, you'll be assigning all calls to that area code to go to a particular voip which has a unique IP address. If your destination pattern includes an area code plus a particular local phone exchange number, then the scope of calls sent through your voip system will be narrowed (only calls within that local exchange will be handled by the designated voip, not all calls in that whole area code). In general, when there are fewer digits in your destination pattern, you are asking the voip to handle calls to more destinations.

2. The Four Types of Phonebook Digits Used. Important!

"Destination patterns" to be entered in your phonebook will generally consist of:

- (a) calling area codes,
- (b) access codes,
- (c) local exchange numbers, and
- (d) specialized codes.

Although voip phonebook entries may look confusing at first, it's useful to remember that all the digits in any phonebook entry must be of one of these four types.

(a) **calling area codes.** There are different names for these around the world: "area codes," "city codes," "country codes," etc. These codes, are used when making non-local calls. They always precede the phone number that would be dialed when making a local call.

4. Using a Comma.

Commas are used in telephone dialing strings to indicate a pause to allow a dial tone to appear (common on PBX and key systems). Commas may be used only in the “Add Prefix” field of the Inbound Phonebook.

Detail

, = 1-second pause
in many PBX systems
(not needed in all)

5. **Ease of Use.** The phonebook setup determines how easy the voip system is to use. Generally, you’ll want to make it so dialing a voip call is very similar to dialing any other number (on the PSTN or through the PBX).

6. **Avoid Unintentional Calls to Official/Emergency Numbers.** Dialing a voip call will typically be somewhat different than ordinary dialing. Because of this, it’s possible to set up situations, quite unwittingly, where phone users may be predisposed to call official numbers without intending to do so. Conversely, a voip/PBX system might also make it difficult to place an official/emergency call when one intends to do so. Study your phonebook setup and do some dialing on the system to avoid these pitfalls.

7. **Inbound/Outbound Pattern Matching.** In general, the Inbound Phonebook entries of the local voip unit will match the Outbound Phonebook entries of the remote voip unit. Similarly, the Outbound Phonebook entries of the local voip unit will match the Inbound Phonebook entries of the remote voip unit. There will often be non-matching entries, but it’s nonetheless useful to notice the matching between the phonebooks.

8. **Simulating Network in-lab/on-benchtop.** One common method of configuring a voip network is to set up a local IP network in a lab, connect voip units to it, and perhaps have phones connected on channel banks to make test calls.

Phonebook Example

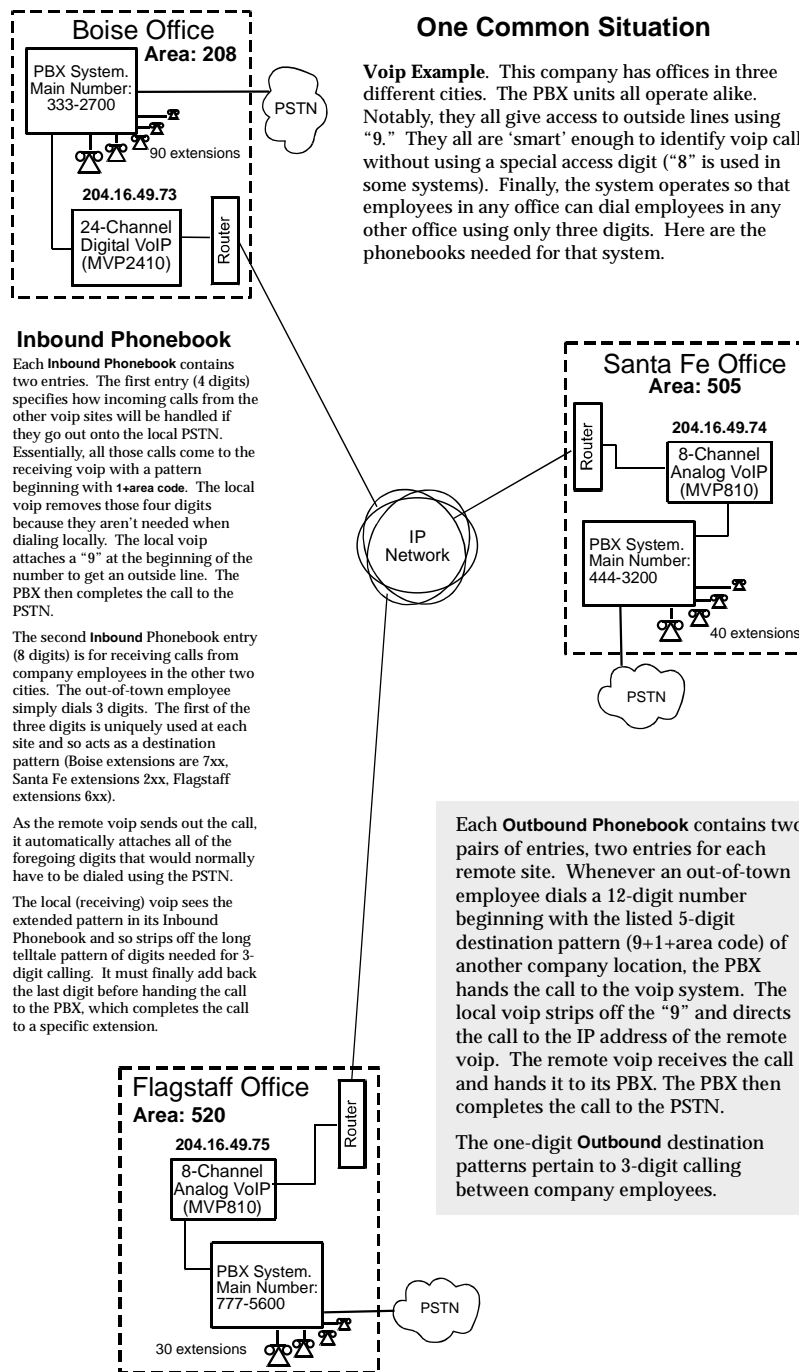

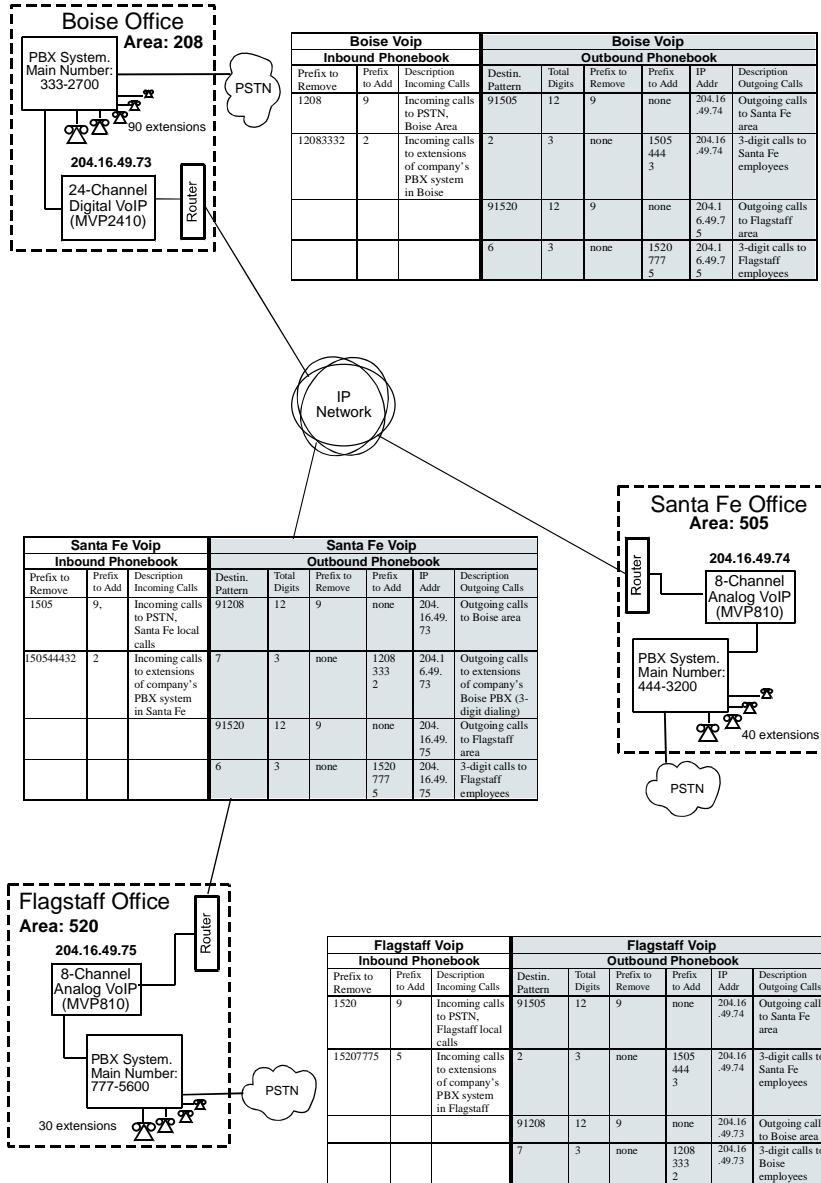

Sample Phonebooks Enlarged

Boise Voip Inbound Phonebook			Boise Voip Outbound Phonebook					
Prefix to Remove	Prefix to Add	Description Incoming Calls	Destin. Pattern	Total Digits	Prefix to Remove	Prefix to Add	IP Addr	Description Outgoing Calls
1208	9,	Incoming calls to PSTN, Boise Area	91505	12	9	none	204.16.49.74	Outgoing calls to Santa Fe area
120833327	7	Incoming calls to extensions of company's PBX system in Boise	2	3	none	15054443	204.16.49.74	3-digit calls to Santa Fe employees (extensions 200 to 240)
			91520	12	9	none	204.16.49.75	Outgoing calls to Flagstaff area
			6	3	none	15207775	204.16.49.75	3-digit calls to Flagstaff employees (extensions 600-630)

Santa Fe Voip Inbound Phonebook			Santa Fe Voip Outbound Phonebook					
Prefix to Remove	Prefix to Add	Description Incoming Calls	Destin. Pattern	Total Digits	Prefix to Remove	Prefix to Add	IP Addr	Description Outgoing Calls
1505	9,	Incoming calls to PSTN, Santa Fe local calls	91208	12	9	none	204.16.49.73	Outgoing calls to Boise area
150544432	2	Incoming calls to extensions of company's PBX system in Santa Fe	7	3	none	12083332	204.16.49.73	3-digit calls to Boise employees (extensions 700-790)
			91520	12	9	none	204.16.49.75	Outgoing calls to Flagstaff area
			6	3	none	15207775	204.16.49.75	3-digit calls to Flagstaff employees (extensions 600-630)

Flagstaff Voip Inbound Phonebook			Flagstaff Voip Outbound Phonebook					
Prefix to Remove	Prefix to Add	Description Incoming Calls	Destin. Pattern	Total Digits	Prefix to Remove	Prefix to Add	IP Addr	Description Outgoing Calls
1520	9,	Incoming calls to PSTN, Flagstaff local calls	91505	12	9	none	204.16.49.74	Outgoing calls to Santa Fe area
152077756	6	Incoming calls to extensions of company's PBX system in Flagstaff	2	3	none	15054443	204.16.49.74	3-digit calls to Santa Fe employees (extensions 200-240)
			91208	12	9	none	204.16.49.73	Outgoing calls to Boise area
			7	3	none	12083332	204.16.49.73	3-digit calls to Boise employees (extensions 700-790)

Phonebook Worksheet

Voip Location/ID: _____

Inbound Phonebook			Outbound Phonebook					
Prefix to Remove	Prefix to Add	Description Incoming Calls	Destin. Pattern	Total Digits	Prefix to Remove	Prefix to Add	IP Addr	Description Outgoing Calls

Other Details:

Voip Location/ID: _____

Inbound Phonebook			Outbound Phonebook					
Prefix to Remove	Prefix to Add	Description Incoming Calls	Destin. Pattern	Total Digits	Prefix to Remove	Prefix to Add	IP Addr	Description Outgoing Calls

Other Details:

Voip Location/ID: _____

Inbound Phonebook			Outbound Phonebook					
Prefix to Remove	Prefix to Add	Description Incoming Calls	Destin. Pattern	Total Digits	Prefix to Remove	Prefix to Add	IP Addr	Description Outgoing Calls

Other Details:

Enlarged Phonebook Worksheet

Voip Location/ID:

Inbound Phonebook			Outbound Phonebook					
Prefix to Remove	Prefix to Add	Description Incoming Calls	Destin. Pattern	Total Digits	Prefix to Remove	Prefix to Add	IP Addr	Description Outgoing Calls

Other Details:

Connectivity Test

The procedures “Phone/IP Starter Configuration” and “Phonebook Starter Configuration” must be completed before you can do this procedure.

1. These connections must be made:

Connections	
for digital MultiVOIPs (MVP-2400/2410/3010)	for analog MultiVOIPs (MVP-210/410/810)
MultiVOIP to local PBX	MultiVOIP to local phone station -OR- MultiVOIP to extension of key phone system
MultiVOIP to command PC	MultiVOIP to command PC
MultiVOIP to Internet	MultiVOIP to Internet

2. Inbound Phonebook and Outbound Phonebook must both be set up with at least one entry in each. These entries must allow for connection between two voip units.
3. Console messages must be enabled. (If this has not been done already, go, in the MultiVOIP GUI, to Configuration | Logs and select the “Console Messages” checkbox.
4. You now need to free up the COM port connection (currently being used by the MultiVOIP program) so that the HyperTerminal program can use it. To do this, you can either (a) click on **Connection** in the sidebar and select “Disconnect” from the drop-down box, or (b) close down the MultiVOIP program altogether.
5. Open the **HyperTerminal** program.

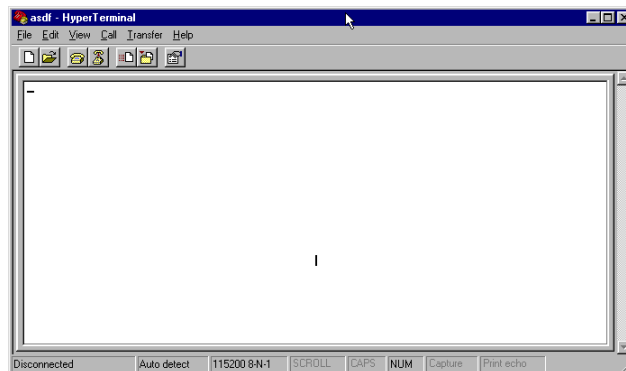

6. Use HyperTerminal to receive and record console messages from the MultiVOIP unit. To do so, set up HyperTerminal as follows (setup shown is for Windows NT4; details will differ slightly in other MS operating systems):

In the upper toolbar of the HyperTerminal screen, click on the **Properties** button.

In the "Connect To" tab of the **Connection Properties** dialog box, click on the **Configure** button.

In the next dialog box, on the "General" tab, set "Maximum Speed" to 115200 bps.

On the "Connection" tab, set connection preferences to:

Data bits: 8

Parity: none

Stop bits: 1

Click **OK** twice to exit settings dialog boxes.

7. Make VOIP call.

for digital MultiVOIPs (MVP-2400/2410/3010)	for analog MultiVOIPs (MVP-210/410/810)
Make call from an extension of the local PBX.	Make call on a local phone line accessing PSTN directly or through key system

8. Read console messages recorded on HyperTerminal.

Console Messages from **Originating VOIP**. The voip unit that originates the call will send back messages like that shown below.

```
[00026975] CAS[0] : RX : ABCD = 1, 1, 1, 1,Pstn State[1]
           TimeStamp : 26975
[00027190] CAS[0] : TX : ABCD = 1, 1, 1, 1
[00027190] PSTN: cas seizure detected on 0
[00027440] CAS[0] : TX : ABCD = 0, 0, 0, 0
[00033290] PSTN:call detected on 0 num=17637175662*
[00033290] H323IF[0]:destAddr =
           TA:200.2.10.5:1720,NAME:Mounds
           View,TEL:17637175662,17637175662
[00033290] H323IF[0]:srcAddr = NAME:New
           York,TA:200.2.9.20
[00033440] H323IF [0]:cmCallStateProceeding
[00033500] H323[0]: Remote Information (Q931): MultiVOIP
           - T1
[00033565] CAS[0] : TX : ABCD = 1, 1, 1, 1
[00033675] H323IF [0]: MasterSlaveStatus=Slave
[00033675] H323IF[0]:FastStart Setup Not Used
[00033690] CAS[0] : TX : ABCD = 1, 1, 1, 1
[00033755] H323IF[0]: Coder used 'g7231'
[00033810] PSTN:pstn call connected on 0
```

Console Messages from **Terminating VOIP**. The voip unit connected to the phone where the call is answered will send back messages like that shown below.

```
[00170860] H323[0]: New incoming call
[00170860] PSTNIF : Placing call on channel 0 Outbound
digit 7175662
[00170885] CAS[0] : TX : ABCD = 1, 1, 1, 1
[00171095] H323IF [0]: MasterSlaveStatus=Master
[00171105] CAS[0] : RX : ABCD = 1, 1, 1, 1,Pstn State[7]
TimeStamp : 171105
[00171105] H323IF[0]: Coder used 'g7231'
[00171110] H323IF[0]:FastStart Setup Not Used
[00171110] H323IF[0]: Already opened the outgoing logical
channel
[00171110] H323IF[0]: Coder used 'g7231'
[00171315] CAS[0] : RX : ABCD = 0, 0, 0, 0,Pstn State[9]
TimeStamp : 171315
[00172275] PSTN: dialing digit ended on 0
[00172285] PSTN: pstn proceeding indication on 0
[00172995] CAS[0] : RX : ABCD = 1, 1, 1, 1,Pstn State[12]
TimeStamp : 172995
[00173660] CAS[0] : TX : ABCD = 1, 1, 1, 1
[00173760] PSTN:pstn call connected on 0
```

9. When you see the following message, end-to-end voip connectivity has been achieved.

“PSTN: pstn call connected on X”

where x is the number of the voip channel carrying the call

10. If the HyperTerminal messages do not confirm connectivity, go to the **Troubleshooting** procedure below.

Troubleshooting

If you cannot establish connectivity between two voips in the system, follow the steps below to determine the problem.

1. Ping both MultiVOIP units to confirm connectivity to the network.

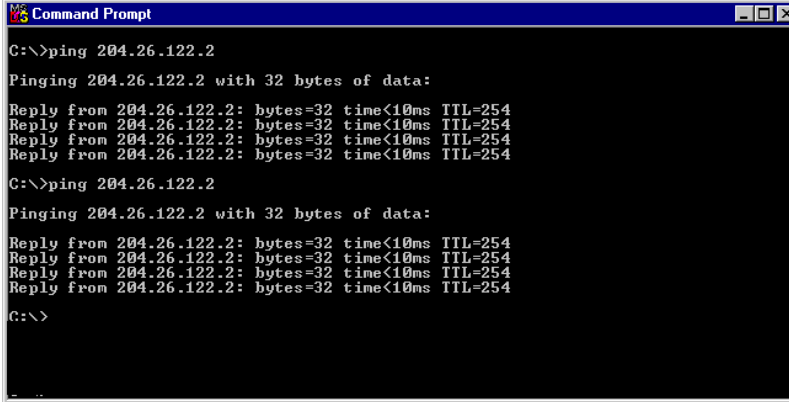

```
Command Prompt
C:\>ping 204.26.122.2
Pinging 204.26.122.2 with 32 bytes of data:
Reply from 204.26.122.2: bytes=32 time<10ms TTL=254
Reply from 204.26.122.2: bytes=32 time<10ms TTL=254
Reply from 204.26.122.2: bytes=32 time<10ms TTL=254
Reply from 204.26.122.2: bytes=32 time<10ms TTL=254
C:\>ping 204.26.122.2
Pinging 204.26.122.2 with 32 bytes of data:
Reply from 204.26.122.2: bytes=32 time<10ms TTL=254
Reply from 204.26.122.2: bytes=32 time<10ms TTL=254
Reply from 204.26.122.2: bytes=32 time<10ms TTL=254
Reply from 204.26.122.2: bytes=32 time<10ms TTL=254
C:\>
```

2. Verify the telephone connections.

- A. For **MVP2400, MVP2410, or MVP3010.**

Check cabling. Are connections well seated? To correct receptacle?

Is the **ONL** LED on?

(If on, ONL indicates that the MultiVOIP is online on the network.)

Are T1/E1/PRI Parameter settings correct?

- B. For **MVP210, MVP410, or MVP810.**

Check cabling. Are connections well seated? To correct receptacle?

Are telephone Interface Parameter settings correct?

3. Verify phonebook configuration.

4. Observe console messages while placing a call. Look for error messages indicating phonebook problems, network problems, voice-coder mismatches, etc.

Chapter 3: Mechanical Installation and Cabling

Introduction

The MultiVOIP models MVP210 and MVP2400 are table-top units and can be handled easily by one person. However, the MVP410, MVP810, MVP2410, and MVP3010 are somewhat heavier units. When these units are to be installed into a rack, two able-bodied persons should participate.

Please read the safety notices before beginning installation.

Safety Warnings

Lithium Battery Caution

A lithium battery on the voice/fax channel board provides backup power for the timekeeping capability. The battery has an estimated life expectancy of ten years.

When the battery starts to weaken, the date and time may be incorrect. If the battery fails, the board must be sent back to Multi-Tech Systems for battery replacement.

Warning: There is danger of explosion if the battery is incorrectly replaced.

Safety Warnings Telecom

1. Never install telephone wiring during a lightning storm.
2. Never install a telephone jack in wet locations unless the jack is specifically designed for wet locations.
3. This product is to be used with UL and cUL listed computers.
4. Never touch uninsulated telephone wires or terminals unless the telephone line has been disconnected at the network interface.
5. Use caution when installing or modifying telephone lines.
6. Avoid using a telephone (other than a cordless type) during an electrical storm. There may be a remote risk of electrical shock from lightning.
7. Do not use a telephone in the vicinity of a gas leak.
8. To reduce the risk of fire, use only 26 AWG or larger telecommunication line cord.

Unpacking Your MultiVOIP

When unpacking your MultiVOIP, check to see that all of the items shown are included in the box. For the various MultiVOIP models, the contents of the box will be different. Study the particular illustration below that is appropriate to the model you have purchased. If any box contents are missing, contact MultiTech Tech Support at 1-800-972-2439.

Unpacking the MVP2410/3010

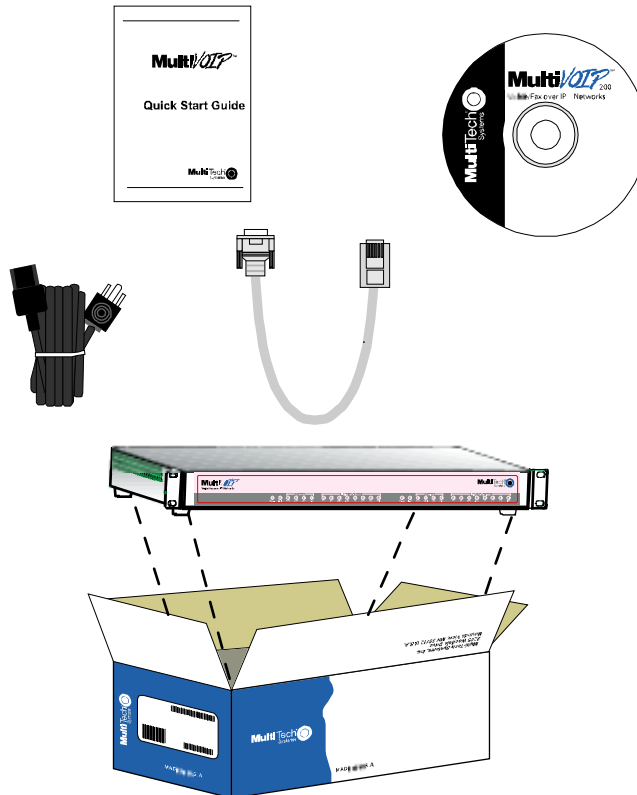

Figure 3-1: Unpacking the MVP2410/3010

Unpacking the MVP2400



Figure 3-2: Unpacking the MVP2400

Unpacking the MVP410/810

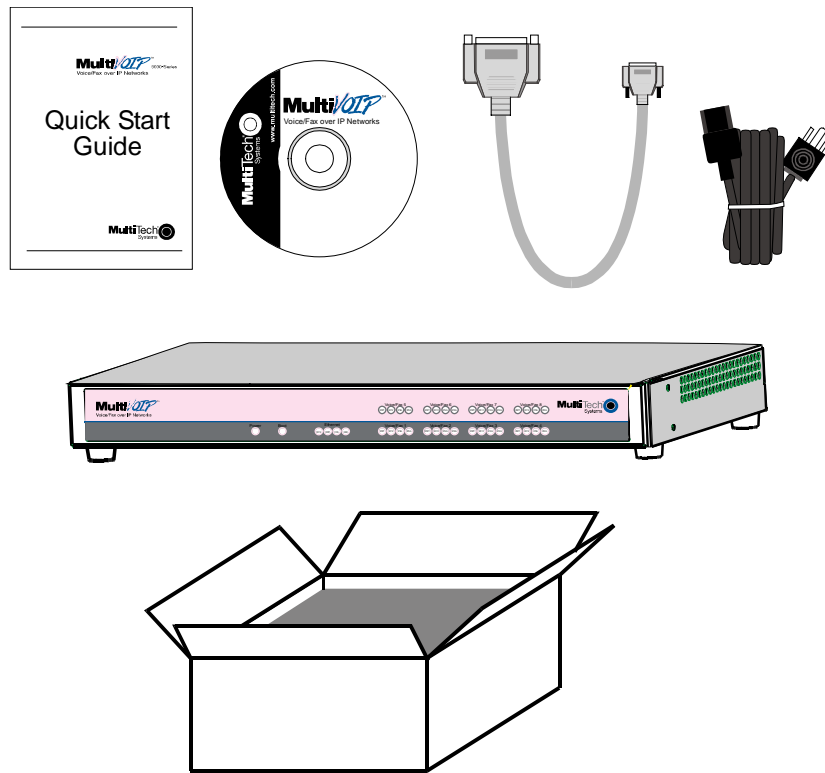

Figure 3-3: Unpacking the MVP410/810

Unpacking the MVP210

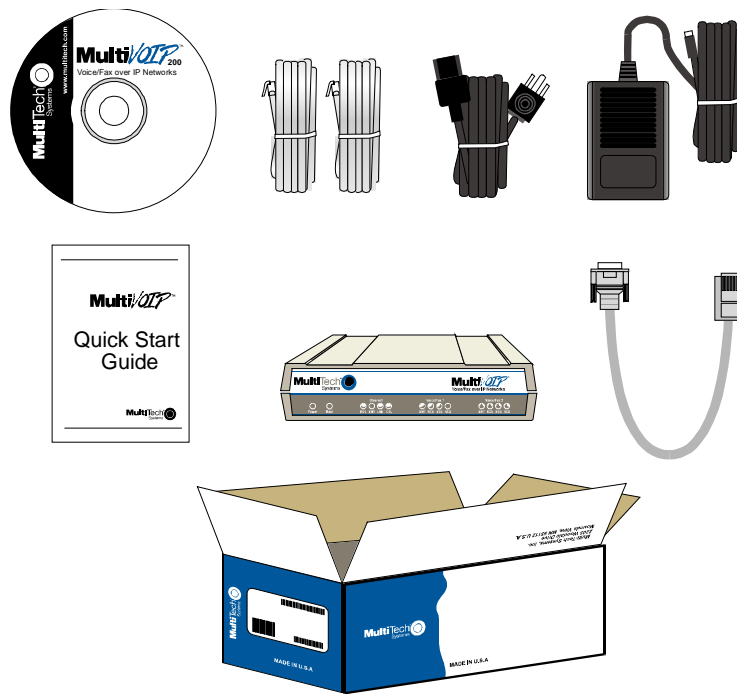

Figure 3-4: Unpacking the MVP210

Rack Mounting Instructions for MVP2410/3010 & MVP410/810

The MultiVOIPs can be mounted in an industry-standard EIA 19-inch rack enclosure, as shown in Figure 2-5.

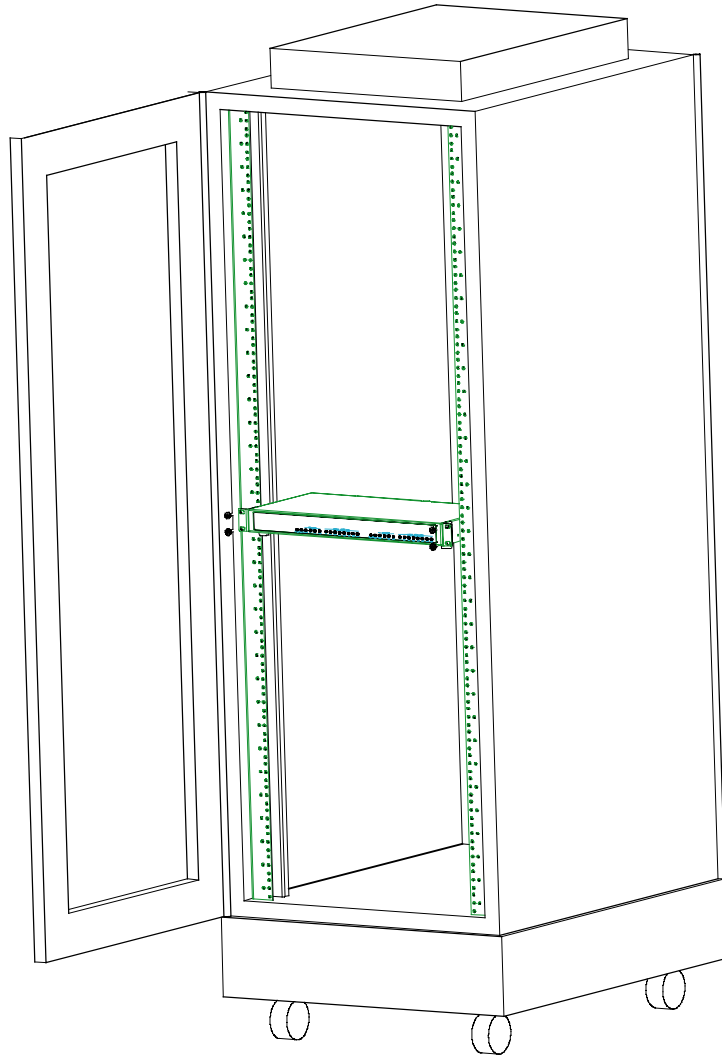

Figure 3-5: Rack-Mounting (MVP2410/3010 or MVP410/810)

Safety Recommendations for Rack Installations

Ensure proper installation of the unit in a closed or multi-unit enclosure by following the recommended installation as defined by the enclosure manufacturer. Do not place the unit directly on top of other equipment or place other equipment directly on top of the unit. If installing the unit in a closed or multi-unit enclosure, ensure adequate airflow within the rack so that the maximum recommended ambient temperature is not exceeded. Ensure that the unit is properly connected to earth ground by verifying that it is reliably grounded when mounted within a rack. If a power strip is used, ensure that the power strip provides adequate grounding of the attached apparatus.

When mounting the equipment in the rack, make sure mechanical loading is even to avoid a hazardous condition, such as loading heavy equipment in rack unevenly. The rack used should safely support the combined weight of all the equipment it supports.

Ensure that the mains supply circuit is capable of handling the load of the equipment. See the power label on the equipment for load requirements (full specifications for MultiVOIP models are presented in chapter 1 of this manual).

Maximum ambient temperature for the unit is 40 degrees Celsius (104 degrees Fahrenheit). This equipment should only be installed by properly qualified service personnel. Only connect like circuits. In other words, connect SELV (Secondary Extra Low Voltage) circuits to SELV circuits and TN (Telecommunications Network) circuits to TN circuits.

19-Inch Rack Enclosure Mounting Procedure

Attaching the MultiVOIP to a rack-rail of an EIA 19-inch rack enclosure will certainly require two persons. Essentially, the technicians must attach the brackets to the MultiVOIP chassis with the screws provided, as shown in Figure 3-6, and then secure unit to rack rails by the brackets, as shown in Figure 3-7. Because equipment racks vary, screw for rack-rail mounting are not provided. Follow the instructions of the rack manufacturer and use screws that fit.

1. Position the right rack mounting bracket on the MultiVOIP using the two vertical mounting screw holes.
2. Secure the bracket to the MultiVOIP using the two screws provided.
3. Position the left rack mounting bracket on the MultiVOIP using the two vertical mounting screw holes.
4. Secure the bracket to the MultiVOIP using the two screws provided.
5. Remove feet (4) from the MultiVOIP unit.
6. Mount the MultiVOIP in the rack enclosure per the rack manufacture's mounting procedure.

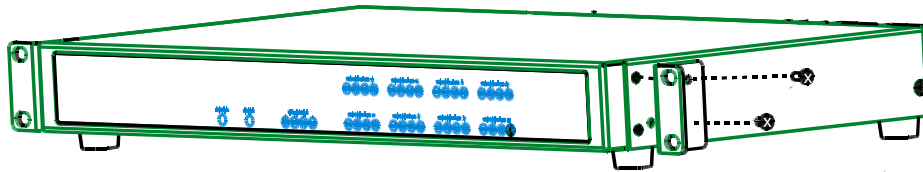

**Figure 3-6: Bracket Attachment for Rack Mounting
(MVP2410/3010 or MVP410/810)**

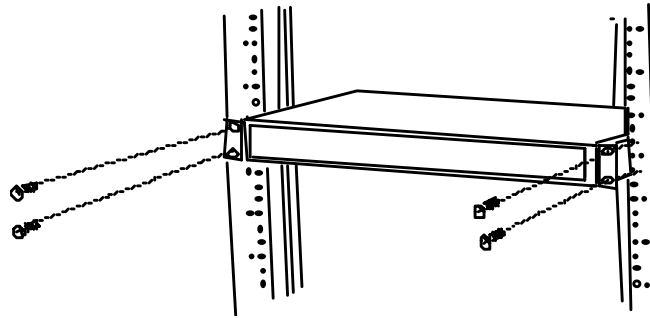

**Figure 3-7: Attaching MultiVOIP to Rack Rail
(MVP2410/3010 or MVP410/810)**

Cabling

Cabling Procedure for MVP2410/3010

Cabling your MultiVOIP entails making the proper connections for power, command port, phone system (T1/E1 line connected to PBX or telco office), and Ethernet network. Figure 3-8 shows the back panel connectors and the associated cable connections. The following procedure details the steps necessary for cabling your MultiVOIP.

1. Connect the power cord to a live AC outlet, then connect it to the MultiVOIP's power receptacle shown at top right in Figure 3-8.

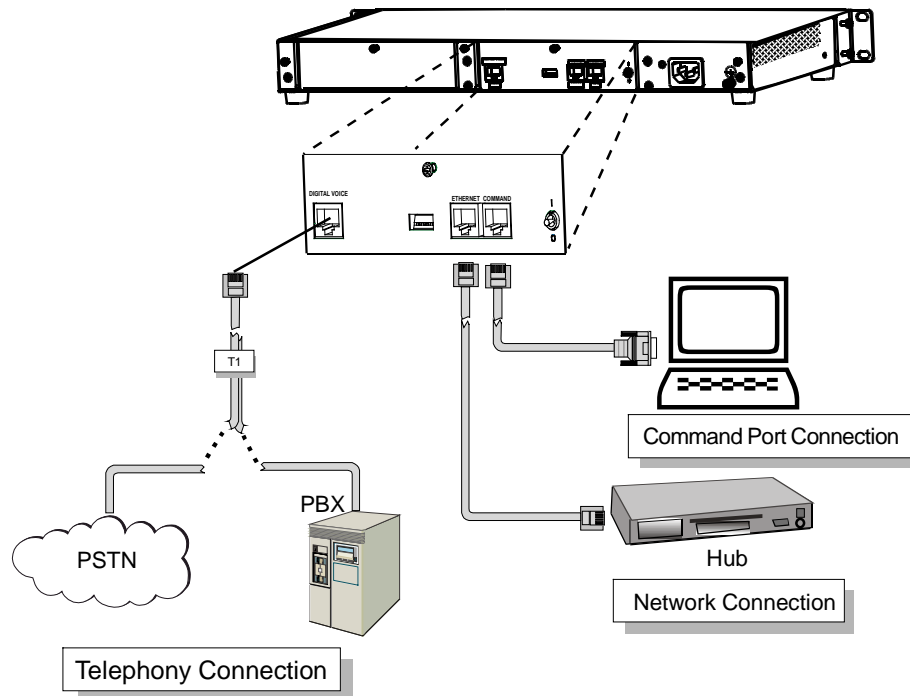

Figure 3-8. Cabling for MVP2410/3010

2. Connect the MultiVOIP to the PC (the computer that will hold the MultiVOIP software) using the RJ-45 to DB9 (female) cable provided with your unit. Plug the RJ-45 end of the cable into the **Command** port of the MultiVOIP and connect the other end (the DB9 connector) to the PC serial port you are using (typically COM1 or COM2). See Figure 3-8.

3. Connect a network cable to the **Ethernet** connector on the back of the MultiVOIP. Connect the other end of the cable to your network.
4. Turn on power to the MultiVOIP by setting the power switch on the right side panel to the **ON** position. Wait for the **Boot** LED on the MultiVOIP to go off before proceeding. This may take a couple of minutes.

Proceed to Chapter 4 “Software Installation.”

Cabling Procedure for MVP2400

Cabling your MultiVOIP entails making the proper connections for power, command port, phone system (T1 line connected to PBX or telco office), and Ethernet network. Figure 3-9 shows the back panel connectors and the associated cable connections. The following procedure details the steps necessary for cabling your MultiVOIP.

1. Connect the power supply to a live AC outlet, then connect it to the MultiVOIP as shown in Figure 3-9.

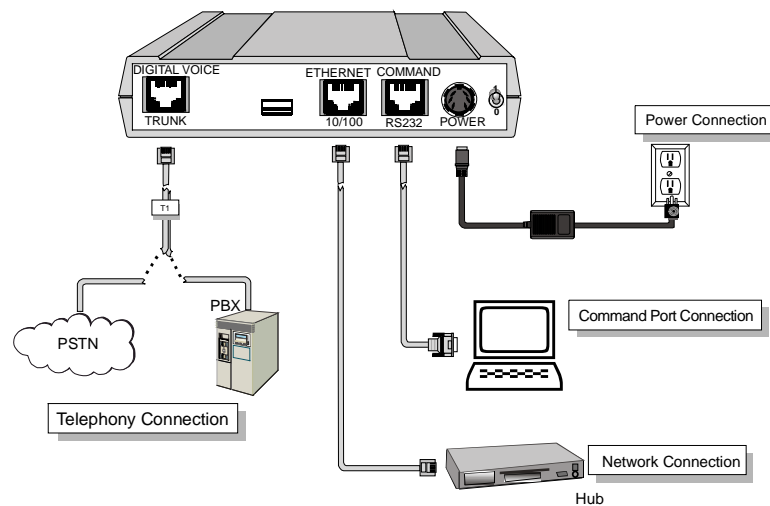

Figure 3-9: Cabling for MVP2400

2. Connect the MultiVOIP to the PC (the computer that will hold the MultiVOIP software) using the RJ-45 to DB9 (female) cable provided with your unit. Plug the RJ-45 end of the cable into the **Command** port of the MultiVOIP and connect the other end (the DB9 connector) to the PC serial port you are using (typically COM1 or COM2). See Figure 3-9.

3. Connect a network cable to the **Ethernet** connector on the back of the MultiVOIP. Connect the other end of the cable to your network.
4. Turn on power to the MultiVOIP by setting the power switch on the right side panel to the **ON** position. Wait for the **Boot** LED on the MultiVOIP to go off before proceeding. This may take a couple of minutes.

Proceed to Chapter 4 “Software Installation.”

Cabling Procedure for MVP410/810

Cabling involves connecting the MultiVOIP to your LAN and telephone equipment.

1. Connect the power cord supplied with your MultiVOIP to a live AC outlet and to the power connector on the back of the MultiVOIP as shown at top right in Figure 3-10.

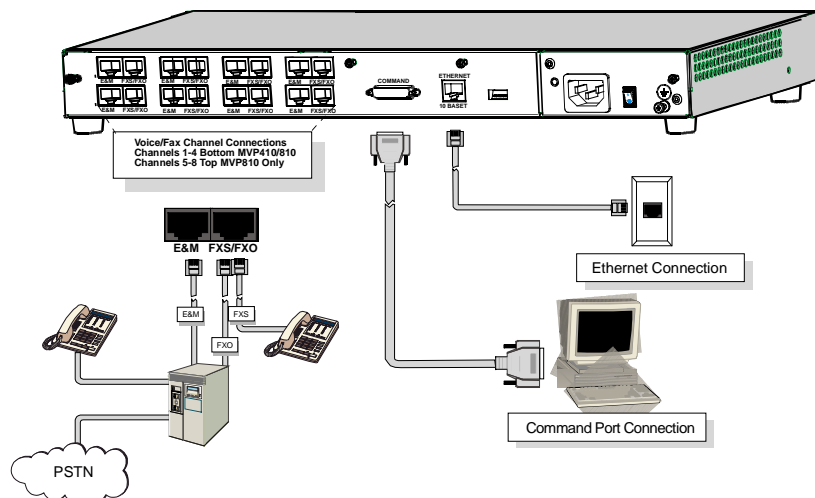

Figure 3-10: Cabling for MVP410/810

2. Connect the MultiVOIP to a PC by using a DB-25 (male) to DB-9 (female) cable. Plug the DB-25 end of the cable into the Command port of the MultiVOIP and the other end into the PC serial port. See Figure 3-10.

3. Connect a network cable to the **ETHERNET 10BASET** connector on the back of the MultiVOIP. Connect the other end of the cable to your network.
4. If you are connecting a station device such as an analog telephone, a fax machine, or a Key Telephone System (KTS) (FXS interface), or a PBX extension (FXO interface) to your MultiVOIP, connect one end of an RJ-11 phone cord to the **Channel 1 FXS/FXO** connector on the back of the MultiVOIP and the other end to the device or phone jack. You will define the interface in the Interface dialog box in the software when you configure the unit.

If you are connecting an E&M trunk from a telephone switch to your MultiVOIP, connect one end of an RJ-45 phone cord to the **Channel 1 E&M** connector on the back of the MultiVOIP and the other end to the trunk. Verify that the E&M Type in the E&M Options group of the Interface dialog box is the same as the E&M trunk type support by the telephone switch. See Appendix B for an E&M cabling pinout.

5. Repeat the above step to connect the remaining telephone equipment to each Channel on your MultiVOIP.
6. Ensure that the unit is properly connected to earth ground by verifying that it is reliably grounded when mounted within a rack.

This can be accomplished by connecting a grounding wire between the chassis and a metallic object that will provide an electrical ground.

7. Turn on power to the MultiVOIP by placing the ON/OFF switch on the back panel to the ON position. Wait for the **Boot** LED on the MultiVOIP to go off before proceeding. This may take a few minutes.

Proceed to Chapter 4 to load the MultiVOIP software.

Cabling Procedure for MVP210

Cabling involves connecting the MultiVOIP to your LAN and telephone equipment.

1. Connect the power cord supplied with your MultiVOIP to the power connector on the back of the MultiVOIP and a live AC outlet as shown in Figure 3-11.

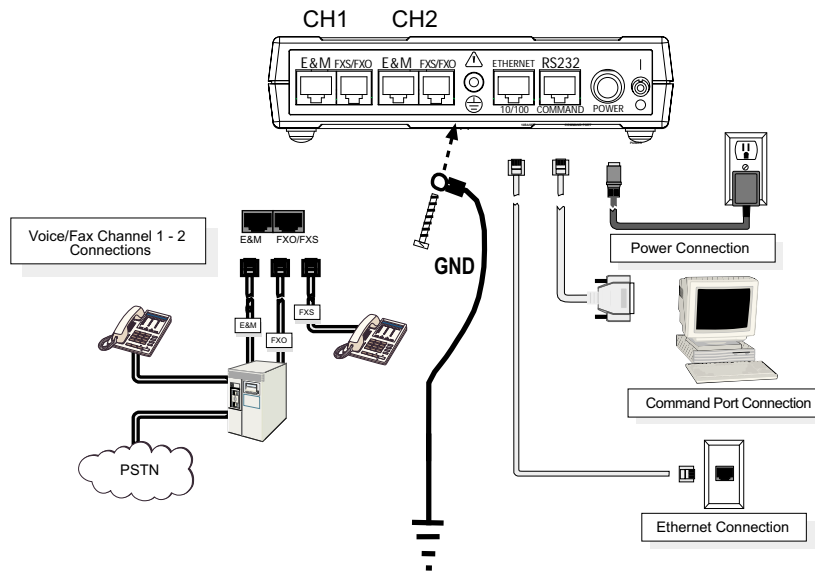

Figure 3-11: Cabling for MVP210

2. Connect the MultiVOIP to a PC by using an RJ-45 (male) to DB-9 (female) cable. Plug the RJ-45 end of the cable into the Command port of the MultiVOIP and the other end into the PC serial port. See Figure 3-11.
3. Connect a network cable to the **ETHERNET 10/100** connector on the back of the MultiVOIP. Connect the other end of the cable to your network.
4. If you are connecting a station device such as an analog telephone, a fax machine, or a Key Telephone System (KTS) (FXS interface), or a PBX extension (FXO interface) to your MultiVOIP, connect one end of an RJ-11 phone cord to the Channel 1 **FXS/FXO** connector on the back MultiVOIP and the other end to the device or phone jack. You

will define the interface in the Interface dialog box in the software when you configure the unit.

If you are connecting an E&M trunk from a telephone switch to your MultiVOIP, connect one end of an RJ-45 phone cord to the Channel 1 E&M connector on the back of the MultiVOIP and the other end to the trunk. Verify that the E&M Type in the E&M Options group of the Interface dialog box is the same as the E&M trunk type support by the telephone switch. See Appendix B for an E&M cabling pinout.

5. Repeat the above step to connect the remaining telephone equipment to the second channel on your MultiVOIP.

6. Ensure that the unit is properly connected to earth ground by verifying that it is reliably grounded when mounted within a rack.

This can be accomplished by connecting a grounding wire between the chassis and a metallic object that will provide an electrical ground.

7. Turn on power to the MultiVOIP by placing the ON/OFF switch on the back panel to the ON position. Wait for the **BOOT** LED on the MultiVOIP to go off before proceeding. This may take a few minutes.

Proceed to Chapter 4 to load the MultiVOIP software.

Chapter 4: Software Installation

Introduction

Configuring software for your MultiVOIP entails three tasks:

- (1) loading the software onto the PC (this is “Software Installation and is discussed in this chapter),
- (2) setting values for telephony and IP parameters that will fit your system (this is “Technical Configuration” and it is discussed in Chapter 5 for T1/E1 MultiVOIP units and in Chapter 6 for analog MultiVOIP units), and
- (3) establishing “phonebooks” that contain the various dialing patterns for VOIP calls made to different locations (this is “Phonebook Configuration” and it is discussed in Chapters 7, 8, and 9 for T1, E1, and analog MultiVOIP units respectively).

Loading MultiVOIP Software onto the PC

The software loading procedure does not present every screen or option in the loading process. It is assumed that someone with a thorough knowledge of Windows and the software loading process is performing the installation.

The MultiVOIP software and User Guide are contained on the MultiVOIP product CD. Because the CD is auto-detectable, it will start up automatically when you insert it into your CD-ROM drive. When you have finished loading your MultiVOIP software, you can view and print the User Guide by clicking on the **View Manuals** icon.

1. Be sure that your MultiVOIP has been properly cabled and that the power is turned on.

2. Insert the MultiVOIP CD into your CD-ROM drive. The CD should start automatically. It may take 10 to 20 seconds for the Multi-Tech CD installation window to display.



- If the Multi-Tech Installation CD window does not display automatically, click **My Computer**, then right click the **CD ROM drive** icon, click **Open**, and then click the **Autorun** icon.
3. When the Multi-Tech Installation CD dialog box appears, click the **Install Software** icon.

4. A 'welcome' screen appears.

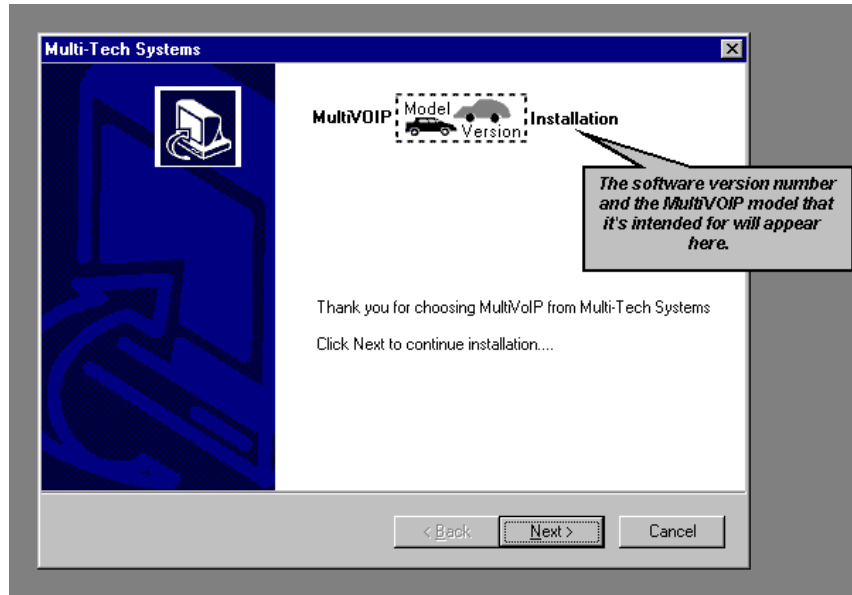

Press **Enter** or click **Next** to continue.

5. Follow the on-screen instructions to install your MultiVOIP software. The first screen asks you to choose the folder location of the files of the MultiVOIP software.

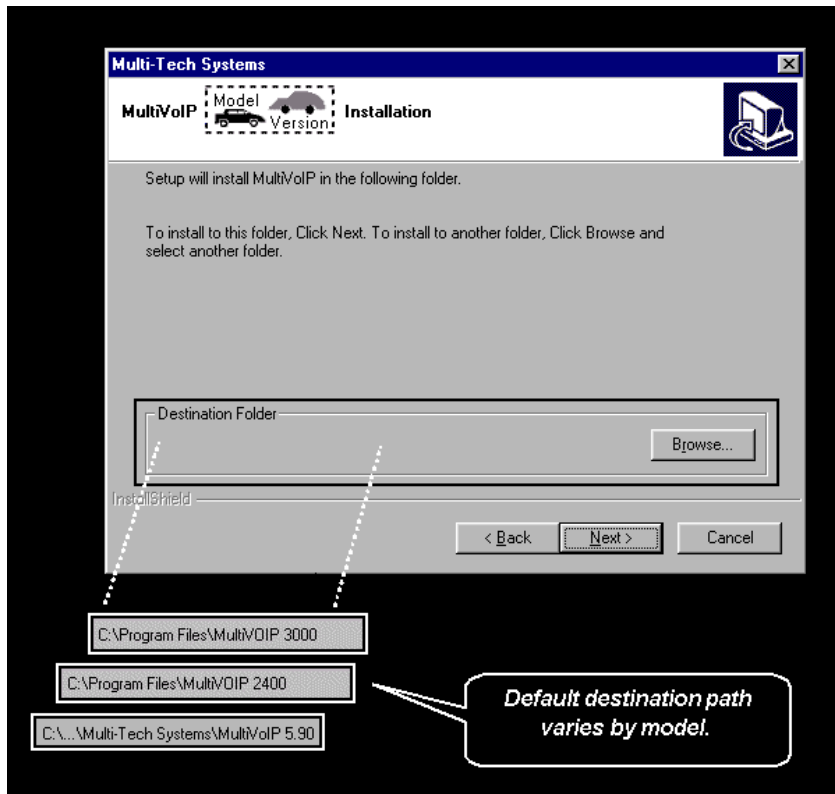

Choose a location and click **Next**.

- At the next screen, you must select a program folder location for the MultiVOIP software program icon.

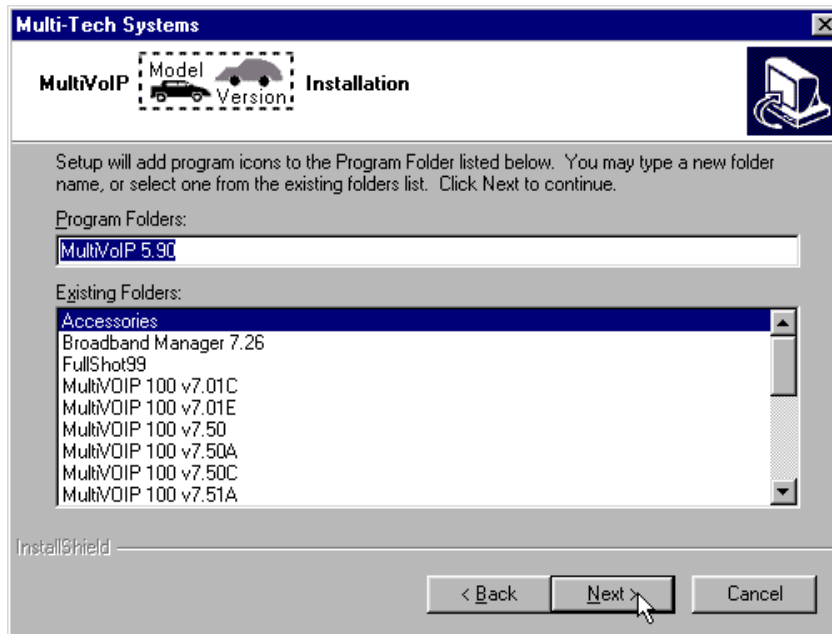

Click **Next**. Transient progress screens will appear while files are being copied.

7. On the next screen you can select the COM port that the command PC will use when communicating with the MultiVoip unit. After software installation, the COM port can be re-set in the MultiVoip Software (from the sidebar menu, select **Connection** | **Settings** to access the **COM Port Setup** screen or use the keyboard shortcut Ctrl + G).

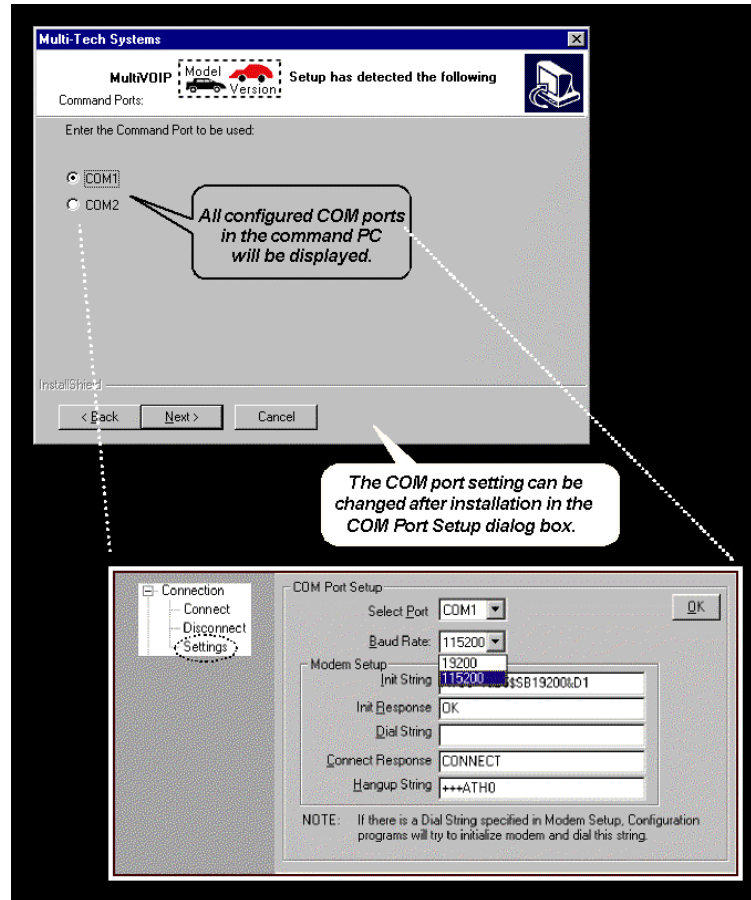

NOTE: If the COM port setting made here conflicts with the actual COM port resources available in the command PC, this error message will appear when the MultiVOIP program is launched. If this occurs, you must reset the COM port.



8. A completion screen will appear.

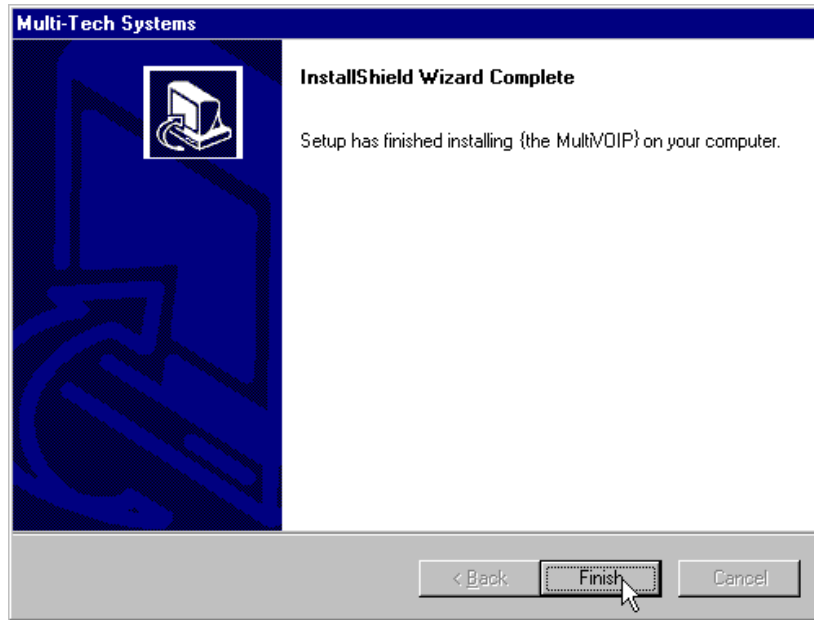

Click **Finish**.

9. When setup of the MultiVOIP software is complete, you will be prompted to run the MultiVOIP software to configure the VOIP.

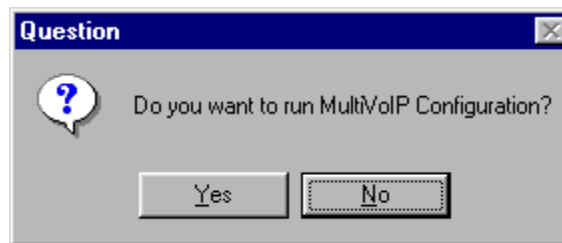

Software installation is complete at this point. You may proceed with Technical Configuration now or not, at your convenience.

Technical Configuration instructions are in the next two chapters of this manual: Chapter 5 for T1/E1 MultiVOIP units and Chapter 6 for Analog MultiVOIP units.

Un-Installing the MultiVOIP Configuration Software

1. To un-install the MultiVOIP configuration software, go to **Start | Programs** and locate the entry for the MultiVOIP program. Select **Uninstall**.

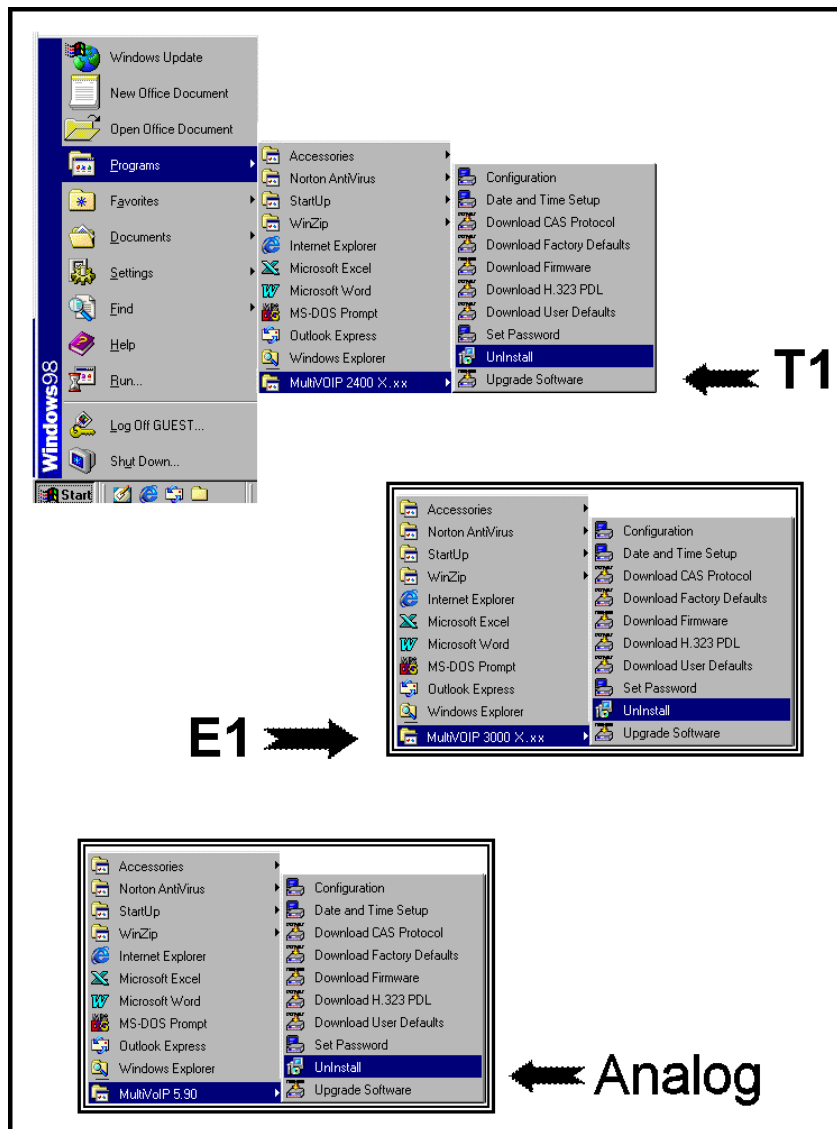

- Two confirmation screens will appear. Click **Yes** and **OK** when you are certain you want to continue with the uninstallation process.

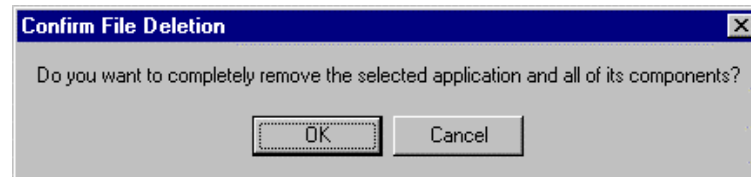
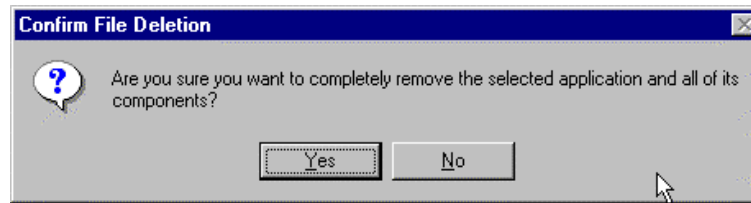

- A special warning message similar to that shown below may appear concerning the MultiVOIP software's ".bin" file. Click **Yes**.

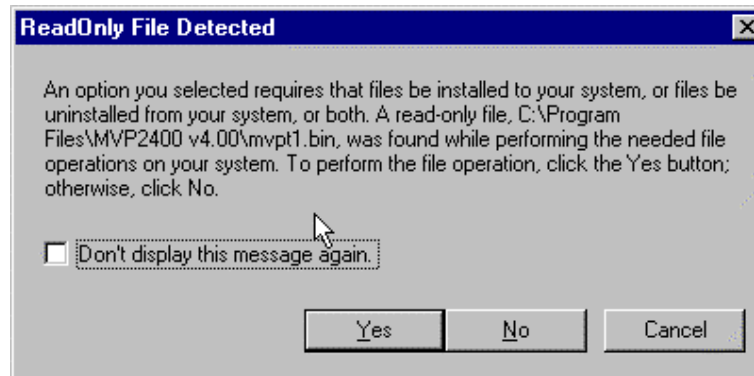

4. A completion screen will appear.

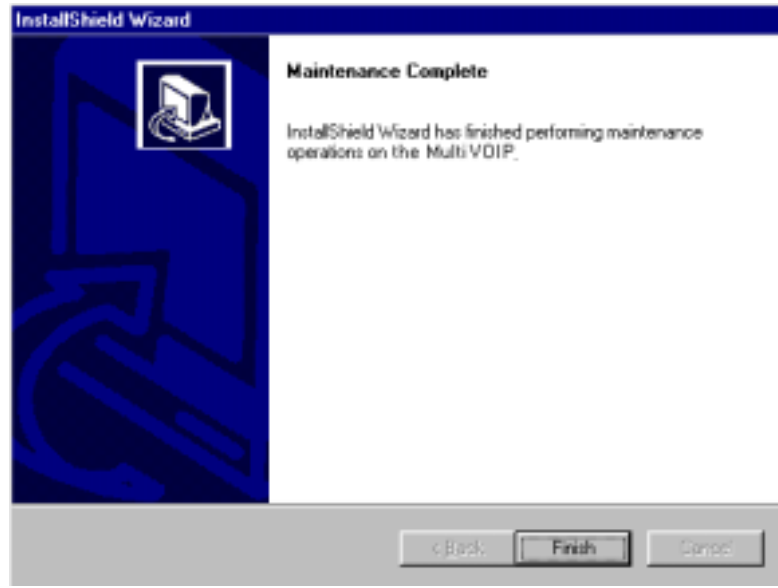

Click **Finish**.

Chapter 5: Technical Configuration for Digital T1/E1 MultiVOIPs (MVP2400, MVP2410, MVP3010)

Configuring the Digital T1/E1 MultiVOIP

There are two ways in which the MultiVOIP must be configured before operation: technical configuration and phonebook configuration.

Technical Configuration. First, the MultiVOIP must be configured to operate with technical parameter settings that will match the equipment with which it interfaces. There are seven types of technical parameters that must be set.

These technical parameters pertain to

- (1) its operation in an IP network,
- (2) its operation with T1/E1 telephony equipment,
- (3) its transmission of voice and fax messages,
- (4) its interaction with SNMP (Simple Network Management Protocol) network management software (MultiVoipManager),
- (5) certain telephony attributes that are common to particular nations or regions,
- (6) its operation with a mail server on the same IP network (per SMTP parameters) such that log reports about VoIP telephone call traffic can be sent to the administrator by email,
- (7) implementing some common premium telephony features (Call Transfer, Call Hold, Call Waiting, Call ID – “Supplementary Services”), and
- (8) selecting the method by which log reports will be made accessible.

The process of specifying values for the various parameters in these seven categories is what we call “technical configuration” and it is described in this chapter.

Phonebook Configuration. The second type of configuration required for the MultiVOIP pertains to the phone number dialing sequences that it will receive and transmit when handling calls. Dialing patterns will be affected by both the PBX/telephony equipment and the other VOIP devices that the MultiVOIP unit interacts with. We call this “Phonebook Configuration,” and it is described in *Chapter 7: T1 Phonebook Configuration* and *Chapter 8: E1 Phonebook Configuration* of this manual. Chapter 2, the *Quick Start Instructions*, presents additional examples relevant to the T1/E1 voips.

Local/Remote Configuration. The MultiVOIP must be configured locally at first (to establish an IP address for the MultiVOIP unit). But changes to this initial configuration can be done either locally or remotely.

Local configuration is done through a connection between the “Command” port of the MultiVOIP and the COM port of the computer; the MultiVOIP configuration program is used.

Remote configuration is done through a connection between the MultiVOIP's Ethernet (network) port and a computer connected to the same network. The computer could be miles or continents away from the MultiVOIP itself. There are two ways of doing remote configuration and operation of the MultiVOIP unit: (1) using the MultiVoipManager SNMP program, or (2) using the MultiVOIP web browser interface program.

MultiVoipManager. MultiVoipManager is an SNMP agent program (Simple Network Management Protocol) that extends the capabilities of the MultiVOIP configuration program: MultiVoipManager allows the user to manage any number of VOIPs on a network, whereas the MultiVOIP configuration program can manage only the VOIP to which it is directly/locally connected. The MultiVoipManager can configure multiple VOIPs simultaneously, whereas the MultiVOIP configuration program can configure only one at a time.

MultiVoipManager may (but does not need to) reside on the same PC as the MultiVOIP configuration program. The MultiVoipManager program is on the MultiVOIP Product CD. Updates, when applicable, may be posted at on the MultiTech FTP site. To download, go to <ftp://ftp.multitech.com/MultiVoip/>.

Web Browser Interface. The MultiVOIP web browser GUI gives access to the same commands and configuration parameters as are available in the MultiVOIP Windows GUI except for logging functions. When using the web browser GUI, logging can be done by email (the SMTP option).

Functional Equivalence. The MultiVOIP configuration program is required to do the initial configuration (that is, setting an IP address for the MultiVOIP unit) so that the VOIP unit can communicate with the MultiVoipManager program or with the web browser GUI. Management of the VOIP after that point can be done from any of these three programs since they all offer essentially the same functionality. Functionally, either the MultiVoipManager program or the web browser GUI can replace the MultiVOIP configuration program after the initial configuration is complete (with minor exceptions, as noted).

WARNING: Do not attempt to interface the MultiVOIP unit with two control programs simultaneously (that is, by accessing the MultiVOIP configuration program via the Command Port and either the MultiVoipManager program or the web browser interface via the Ethernet Port). The results of using two programs to control a single VOIP simultaneously would be unpredictable.

Local Configuration

This manual describes local configuration only. For information on remote configuration and management, see the MultiVoipManager documentation.

Pre-Requisites



To complete the configuration of the MultiVOIP unit, you **must** know several things about the overall system.

Before configuring your MultiVOIP Gateway unit, you must know the values for several IP and T1/E1 parameters that describe the IP network system and telephony system (PBX or telco central office equipment) with which the digital MultiVOIP will interact. If you plan to receive log reports on phone traffic by email (SMTP), you must arrange to have an email address assigned to the VOIP unit on the email server on your IP network.

IP Parameters

The following parameters must be known about the network (LAN, WAN, Internet, etc.) to which the MultiVOIP will connect:

➤	<i>Ask your computer network administrator.</i>	<i>Info needed to operate: all MultiVOIP models.</i>
	 IP Network Parameters: Record for each VOIP Site in System	
	• IP Address	
	• IP Mask	
	• Gateway	
	• Domain Name Server (DNS) Info <i>(not implemented; for future use)</i>	

Write down the values for these IP parameters. You will need to enter these values in the “IP Parameters” screen in the Configuration section of the MultiVOIP software. You must have this IP information about every VOIP in the system.

T1 Telephony Parameters (for MVP2400 & MVP2410)

The following parameters must be known about the PBX or telco central office equipment to which the T1 MultiVOIP will connect:

➤	T1 Phone Parameters <i>Ask phone company or PBX maintainer.</i>	<i>Info needed to operate:</i> MVP2400 MVP2410
	 T1 Telephony Parameters: Record for this VOIP Site	
	<ul style="list-style-type: none"> • Which frame format is used? ESF___ or D4___ 	
	<ul style="list-style-type: none"> • Which CAS or PRI protocol is used? _____ 	
	<ul style="list-style-type: none"> • Clocking: Does the PBX or telco switch use internal or external clocking? _____ Note that the setting used in the voip unit will be the opposite of the setting used by the telco/PBX. 	
	<ul style="list-style-type: none"> • Which line coding is used? AMI___ or B8ZS___ 	

Write down the values for these T1 parameters. You will need to enter these values in the “T1/E1 Parameters” screen in the Configuration section of the MultiVOIP software.

E1 Telephony Parameters (for MVP3010)

The following parameters must be known about the PBX or telco central office equipment to which the E1 MultiVOIP will connect:

➤	E1 Phone Parameters <i>Ask phone company or PBX maintainer.</i>	<i>Info needed to operate:</i> MVP3010
	 E1 Telephony Parameters: Record for this VOIP Site	
	<ul style="list-style-type: none"> • Which frame format is used? Double Frame _____ MultiFrame w/ CRC4 _____ MultiFrame w/ CRC4 modified _____ 	
	<ul style="list-style-type: none"> • Which CAS or PRI protocol is used? _____ 	
	<ul style="list-style-type: none"> • Clocking: Does the PBX or telco switch use internal or external clocking? _____ Note that the setting used in the voip unit will be the opposite of the setting used by the telco/PBX. 	
	<ul style="list-style-type: none"> • Which line coding is used? AMI _____ or HDB3 _____ 	
	<ul style="list-style-type: none"> • Pulse shape level?: (most commonly 0 to 40 meters) 	

Write down the values for these E1 parameters. You will need to enter these values in the "T1/E1 Parameters" screen in the Configuration section of the MultiVOIP software.

SMTP Parameters (for email call log reporting)

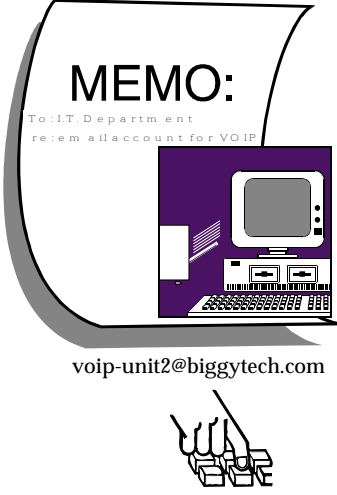
<i>required if log reports of VOIP call traffic are to be sent by email</i>	Optional
<p>SMTP Parameters Preparation Task:</p> <p>Ask Mail Server administrator to set up email account (with password) for the MultiVOIP unit itself. Be sure to give a unique identifier to each individual MultiVOIP unit .</p> <p>Get the IP address of the mail server computer, as well.</p>	

Local Configuration Procedure (Summary)

After the MultiVOIP configuration software has been installed in the 'Command' PC (which is connected to the MultiVOIP unit), several steps must be taken to configure the MultiVOIP to function in its specific setting. Although the summary below includes all of these steps, some are optional.

1. Check Power and Cabling.
2. Start MultiVOIP Configuration Program.
3. Confirm Connection.
4. Solve Common Connection Problems.
 - A. Fixing a COM Port Problem.
 - B. Fixing a Cabling Problem.
5. Familiarize yourself with configuration parameter screens and how to access them.
6. Set IP Parameters.
7. Enable web browser GUI (optional).
8. Set Voice/Fax Parameters.
9. Set T1/E1 Parameters.
10. Set ISDN Parameters (if applicable).
11. Set SNMP Parameters (applicable if MultiVoipManager remote management software is used).
12. Set Regional Parameters (Phone Signaling Tones and Cadences).
13. Set Custom Tones and Cadences (optional).
14. Set SMTP Parameters (applicable if Log Reports are via Email).
15. Set Log Reporting Method (GUI, locally in MultiVOIP Configuration program; SNMP, remotely in MultiVoipManager program; or SMTP, via email).
16. Set Supplementary Services Parameters. The Supplementary Services screen allows voip deployment of features that are normally found in PBX or PSTN systems (e.g., call transfer and call waiting).
17. Set Baud Rate (of COM port connection to 'Command' PC).
18. View System Information and set updating interval (optional).
19. Save the MultiVOIP configuration.
20. Create a User Default Configuration (optional).

Local Configuration Procedure (Detailed)

You can begin the configuration process as a continuation of the MultiVOIP software installation. You can establish your configuration or modify it at any time by launching the MultiVOIP program from the Windows **Start** menu.

1. **Check Power and Cabling.** Be sure the MultiVOIP is turned on and connected to the computer via the MultiVOIP's Command Port (DB9 connector at computer's COM port; RJ45 connector at MultiVOIP).

You must allow the MultiVOIP to finish booting before you launch the MultiVOIP Configuration Program. The RED boot LED turns itself off when the booting process is completed.

2. **Start MultiVOIP Configuration Program.** Launch the MultiVOIP program from the Windows **Start** menu (from the folder location determined during installation).

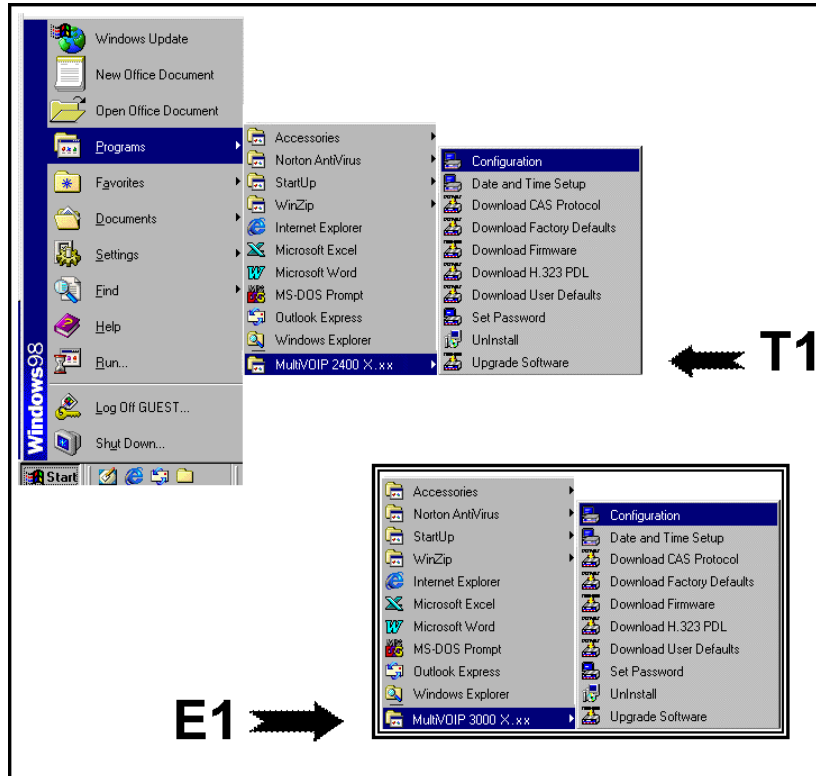

3. **Confirm Connection.** If the MultiVOIP is set for an available COM port and is correctly cabled to the PC, the MultiVOIP main screen will appear. (If the main screen appears *grayed out* and seems inaccessible, go to step 4.)

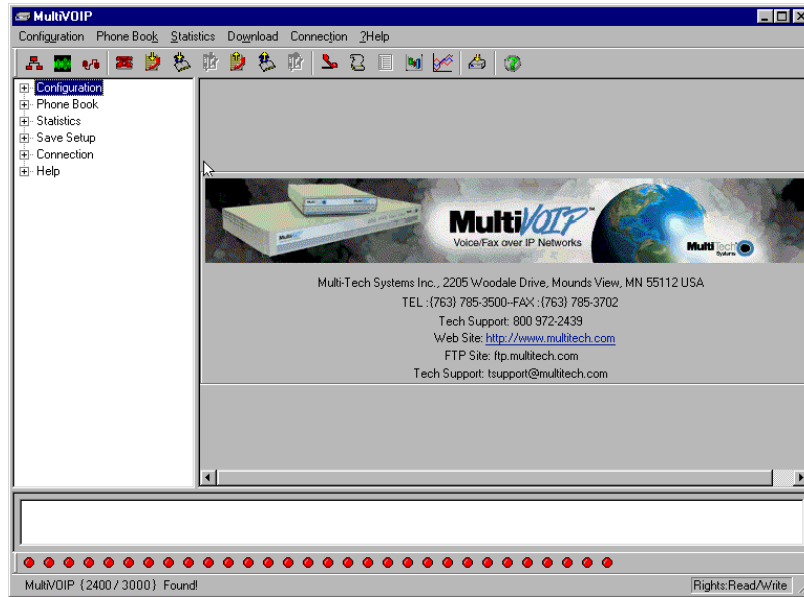

In the lower left corner of the screen, the connection status of the MultiVOIP will be displayed. The messages in the lower left corner will change as detection occurs. The message “MultiVOIP Found” confirms that the MultiVOIP is in contact with the MultiVOIP configuration program. Skip to step 5.

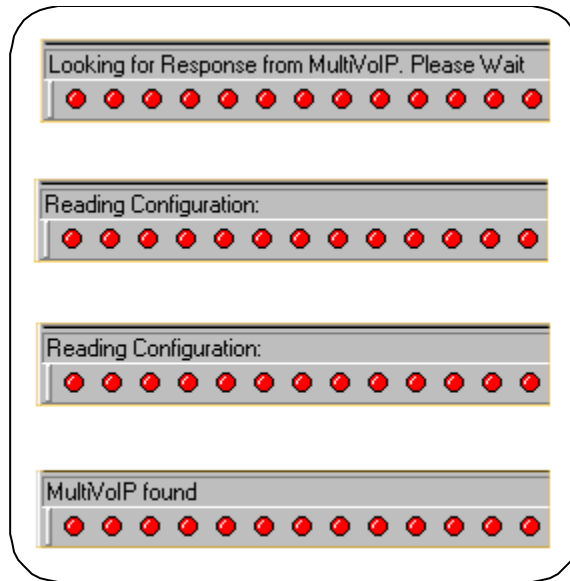

4. Solving Common Connection Problems.

A. Fixing a COM Port Problem. If the MultiVOIP main screen appears but is grayed out and seems inaccessible, the COM port that was specified for its communication with the PC is unavailable and must be changed. An error message will appear.



To change the COM port setting, use the **COM Port Setup** dialog box, which is accessible via the keyboard shortcut **Ctrl + G** or by going to the **Connection** pull-down menu and choosing “Settings.” In the “Select Port” field, select a COM port that is available on the PC. (If no COM ports are currently available, re-allocate COM port resources in the computer’s MS Windows operating system to make one available.)

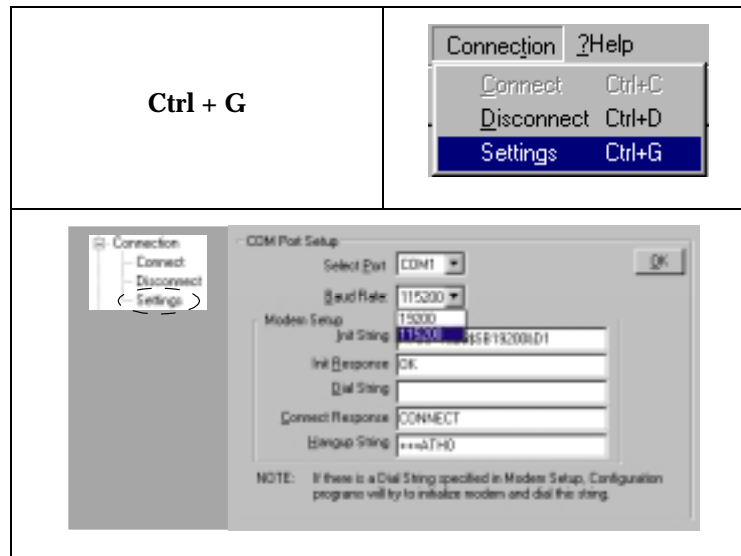

4B. Fixing a Cabling Problem. If the MultiVOIP cannot be located by the computer, two error messages will appear (saying “Multi-VOIP Not Found” and “Phone Database Not Read”).

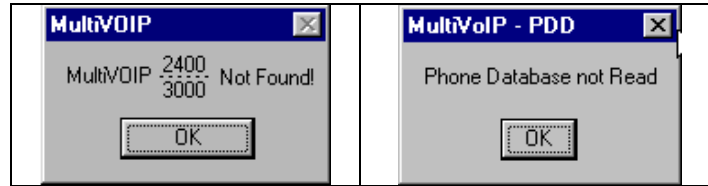

In this case, the MultiVOIP is simply disconnected from the network. For instructions on MultiVOIP cable connections, see the “Cabling” section of Chapter 3.

5. Configuration Parameter Groups: Getting Familiar, Learning About Access. The first part of configuration concerns IP parameters, Voice/FAX parameters, T1/E1 parameters, SNMP parameters, Regional parameters, SMTP parameters, Supplementary Services parameters, Logs, and System Information. In the MultiVOIP software, these seven types of parameters are grouped together under “Configuration” and each has its own dialog box for entering values.

Generally, you can reach the dialog box for these parameter groups in one of four ways: pulldown menu, toolbar icon, keyboard shortcut, or sidebar..

6. **Set IP Parameters.** This dialog box can be reached by pulldown menu, toolbar icon, keyboard shortcut, or sidebar.

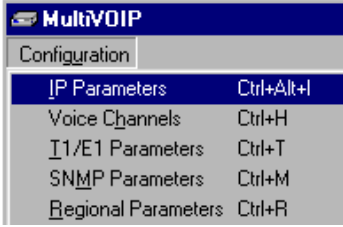
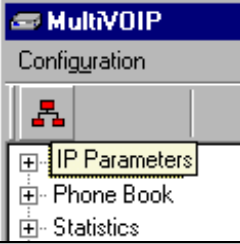
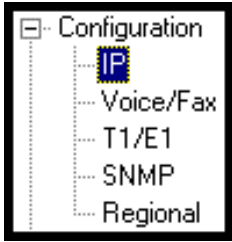
Accessing "IP Parameters"	
Pulldown	Icon
	
Shortcut	Sidebar
<p>Ctrl + Alt + I</p>	

In each field, enter the values that fit your particular network.

The image shows a network configuration dialog box with the following sections:

- IP Parameters:**
 - Enable Diffserv
 - Frame Type: TYPE-II (dropdown menu)
 - IP Address: 192 . 168 . 3 . 143
 - IP Mask: 255 . 255 . 255 . 0
 - GateWay: . . .
- DNS:**
 - Enable DNS
 - DNS Server IP Address: . . .
- FTP Server:**
 - Enable

Buttons on the right: OK, Cancel, Help.

A callout box shows the Frame Type dropdown menu expanded, listing TYPE-II and SNAP.

The **IP Parameters** fields are described in the table below.

IP Parameter Definitions		
Field Name	Values	Description
Enable Diffserv	Y/N	Diffserv is used for QoS (quality of service). When enabled, we configure the TOS (Type of Service) bits in the IP header so routers supporting Diffserv can give priority to the VOIP's IP packets. Disabled by default.
Frame Type	Type II, SNAP	Must be set to match network's frame type. Default is Type II.
IP Address	4-places, 0-255	The unique LAN IP address assigned to the MultiVOIP.
IP Mask	4-places, 0-255	Subnetwork address that allows for sharing of IP addresses within a LAN.
Gateway	4-places, 0-255	The IP address of the device that connects your MultiVOIP to the Internet.
Enable DNS	Y/N <i>(feature not yet implemented; for future use)</i>	Enables Domain Name Space/System function where computer names are resolved using a worldwide distributed database.
DNS Server IP Address	4-places, 0-255. <i>(feature not yet implemented; for future use)</i>	IP address of specific DNS server to be used to resolve Internet computer names.
FTP Server Enable	Y/N See "FTP Server File Transfers" in <i>Operation & Maintenance</i> chapter.	MultiVOIP unit has an FTP Server function so that firmware and other important operating software files can be transferred to the voip via the network.

7. Enable Web Browser GUI (Optional). After an IP address for the MultiVOIP unit has been established, you can choose to do any further configuration of the unit (a) by using the MultiVOIP web browser GUI, or (b) by continuing to use the MultiVOIP Windows GUI. If you want to do configuration work using the web browser GUI, you must first enable it. To do so, follow the steps below.

- A. Set IP address of MultiVOIP unit using the MultiVOIP Configuration program (the Windows GUI).
- B. Save Setup in Windows GUI.
- C. Close Windows GUI.
- D. Install Java program from MultiVOIP product CD (required on first use only).
- E. Open web browser.
- F. Browse to IP address of MultiVOIP unit.
- G. If username and password have been established, enter them when when prompted.
- H. Use web browser GUI to configure or operate MultiVOIP unit. The configuration screens in the web browser GUI will have the same content as their counterparts in the Windows GUI; only the graphic presentation will be different.

For more details on enabling the MultiVOIP web GUI, see the “Web Browser Interface” section of the *Operation & Maintenance* chapter of this manual.

8. **Set Voice/FAX Parameters.** This dialog box can be reached by pulldown menu, toolbar icon, keyboard shortcut, or sidebar.

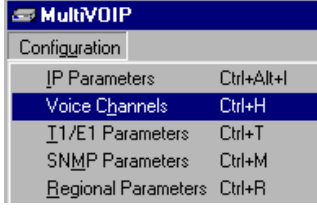
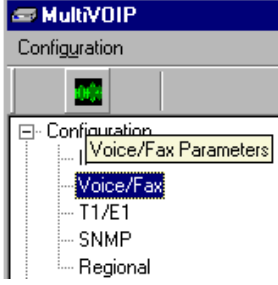
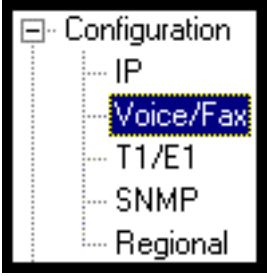
Accessing "Voice/FAX Parameters"	
Pulldown	Icon
	
Shortcut	Sidebar
<p>Ctrl + H</p>	

In each field, enter the values that fit your particular network.

Voice/Fax Parameters

Select Channel

Voice Gain
Input dB Output dB

Dtmf
Gain
High dB Low dB

DTMF Out of Band

Coder
 Manual Automatic
Selected Coder
Max bandwidth kbps

Fax
 Fax Enable
Max Baud Rate
Fax Volume dB
Jitter Value ms
Mode

Advanced Features
 Silence Compression
 Echo Cancellation
 Forward Error Correction

Auto Call
 Auto Call Enable
Phone Number

Dynamic Jitter Buffer
Minimum Jitter Value ms
Maximum Jitter Value ms
Optimization Factor

Automatic Disconnection
 Jitter Value ms Consecutive Packets Lost
 Call Duration seconds Network Disconnection seconds

OK
Cancel
Copy Channel
Default
Help

Note that Voice/FAX parameters are applied on a channel-by-channel basis. However, once you have established a set of Voice/FAX parameters for a particular channel, you can apply this entire set of Voice/FAX parameters to another channel by using the **Copy Channel** button and its dialog box. To copy a set of Voice/FAX parameters to all channels, select “Copy to All” and click **Copy**.

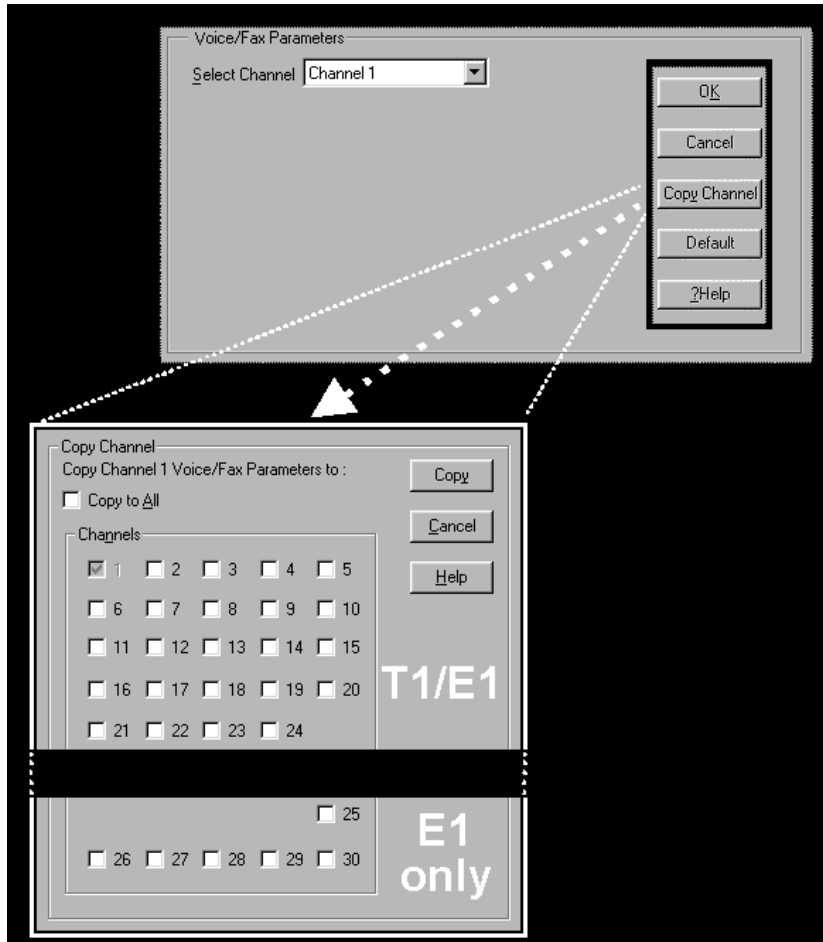

The **Voice/FAX Parameters** fields are described in the tables below.

Voice/Fax Parameter Definitions		
Field Name	Values	Description
Default	--	When this button is clicked, all Voice/FAX parameters are set to their default values.
Select Channel	1-24 (T1) 1-30 (E1)	Channel to be configured is selected here.
Copy Channel	--	Copies the Voice/FAX attributes of one channel to another channel. Attributes can be copied to multiple channels or all channels at once.
Voice Gain	--	Signal amplification (or attenuation) in dB.
Input Gain	+31dB to -31dB	Modifies audio level entering voice channel before it is sent over the network to the remote VOIP. The default & recommended value is 0 dB .
Output Gain	+31dB to -31dB	Modifies audio level being output to the device attached to the voice channel. The default and recommended value is 0 dB .
DTMF Parameters		
DTMF Gain	--	The DTMF Gain (Dual Tone Multi-Frequency) controls the volume level of the digital tones sent out for Touch-Tone dialing.
DTMF Gain, High Tones	+3dB to -31dB & "mute"	Default value: -4 dB . Not to be changed except under supervision of MultiTech's Technical Support.
DTMF Gain, Low Tones	+3dB to -31dB & "mute"	Default value: -7 dB . Not to be changed except under supervision of MultiTech's Technical Support.

Voice/Fax Parameter Definitions (cont'd)		
Field Name	Values	Description
DTMF Parameters		
Duration (DTMF)	60 – 3000 ms	When DTMF: Out of Band is selected, this setting determines how long each DTMF digit 'sounds' or is held. Default = 100 ms.
DTMF In/Out of Band	Out of Band, or Inband	When DTMF Out of Band is selected (checked), the MultiVOIP detects DTMF tones at its input and regenerates them at its output. When DTMF Inband is selected, the DTMF digits are passed through the MultiVOIP unit as they are received.
FAX Parameters		
Fax Enable	Y/N	Enables or disables fax capability for a particular channel.
Max Baud Rate (Fax, bps)	2400, 4800, 7200, 9600, 12000, 14400	Set to match baud rate of fax machine connected to channel (see Fax machine's user manual). Default = 14400 bps.
Fax Volume Default = -9.5 dB	-18.5 dB to -3.5 dB	Controls output level of fax tones. To be changed only under the direction of Multi-Tech's Technical Support.
Jitter Value (Fax)	Default = 400 ms	Defines the inter-arrival packet deviation (in milliseconds) for the fax transmission. A higher value will increase the delay, allowing a higher percentage of packets to be reassembled. A lower value will decrease the delay allowing fewer packets to be reassembled.
Mode (Fax)	FRF 11; T.38 (T.38 not currently supported)	FRF11 is frame-relay FAX standard using these coders: G.711, G.728, G.729, G.723.1. T.38 is an ITU-T standard for storing and forwarding FAXes via email using X.25 packets. It uses T.30 fax standards and includes special provisions to preclude FAX timeouts during IP transmissions.

Voice/Fax Parameter Definitions (cont'd)		
Coder Parameters		
Coder	Manual or Automatic	Determines whether selection of coder is manual or automatic. When Automatic is selected, the local and remote voice channels will negotiate the voice coder to be used by selecting the highest bandwidth coder supported by both sides without exceeding the Max Bandwidth setting. G.723, G.729, or G.711 are negotiated.
Selected Coder	G.711 a/u law 64 kbps; G.726 , @ 16/24/32 /40 kbps; G.727 , @ nine bps rates; G.723.1 @ 5.3 kbps, 6.3 kbps; G.729 , 8kbps; Net Coder @ 6.4, 7.2, 8, 8.8, 9.6 kbps	Select from a range of coders with specific bandwidths. The higher the bps rate, the more bandwidth is used. The channel that you are calling must have the same voice coder selected. Default = G.723.1 @ 6.3 kbps, as required for H.323. Here 64K of digital voice is compressed to 6.3K, allowing several simultaneous conversations over the same bandwidth that would otherwise carry only one. To make selections from the Selected Coder drop-down list, the Manual option must be enabled.
Max bandwidth (coder)	11 – 128 kbps	This drop-down list enables you to select the maximum bandwidth allowed for this channel. The Max Bandwidth drop-down list is enabled only if the Coder is set to Automatic. If coder selected automatically, then enter a value for maximum bandwidth, as directed by VOIP administrator.

Voice/Fax Parameter Definitions (cont'd)		
Field Name	Values	Description
Advanced Features		
Silence Compression	Y/N	Determines whether silence compression is enabled (checked) for this voice channel. With Silence Compression enabled, the MultiVOIP will not transmit voice packets when silence is detected, thereby reducing the amount of network bandwidth that is being used by the voice channel. Default = off.
Echo Cancellation	Y/N	Determines whether echo cancellation is enabled (checked) for this voice channel. Echo Cancellation removes echo and improves sound quality. Default = on.
Forward Error Correction	Y/N	Determines whether forward error correction is enabled (checked) for this voice channel. Forward Error Correction enables some of the voice packets that were corrupted or lost to be recovered. FEC adds an additional 50% overhead to the total network bandwidth consumed by the voice channel. Default = Off
Auto Call Enable	Y/N	The Auto Call option enables the local MultiVOIP to call a remote MultiVOIP without the user having to dial a Phone Directory Database number. As soon as you access the local MultiVOIP voice/fax channel, the MultiVOIP immediately connects to the remote MultiVOIP identified in the Phone Number box of this option.
Phone No. (Auto Call)	--	Phone number used for Auto Call function. A corresponding phone number must be listed in the Outbound Phonebook.

Voice/Fax Parameter Definitions (cont'd)		
Field Name	Values	Description
Dynamic Jitter		
Dynamic Jitter Buffer		<p>Dynamic Jitter defines a minimum and a maximum jitter value for voice communications. When receiving voice packets from a remote MultiVOIP, varying delays between packets may occur due to network traffic problems. This is called Jitter. To compensate, the MultiVOIP uses a Dynamic Jitter Buffer. The Jitter Buffer enables the MultiVOIP to wait for delayed voice packets by automatically adjusting the length of the Jitter Buffer between configurable minimum and maximum values. An Optimization Factor adjustment controls how quickly the length of the Jitter Buffer is increased when jitter increases on the network. The length of the jitter buffer directly effects the voice delay between MultiVOIP gateways.</p> <p>The default minimum dynamic jitter buffer of 60 milliseconds is the minimum delay that would be acceptable over a low jitter network. The default maximum dynamic jitter buffer of 300 milliseconds is the maximum delay tolerable over a high jitter network.</p>
Minimum Jitter Value	60 to 400 ms	The default minimum dynamic jitter buffer of 60 milliseconds is the minimum delay that would be acceptable over a low jitter network. Default = 60 msec

Voice/Fax Parameter Definitions (cont'd)		
Field Name	Values	Description
Dynamic Jitter		
Maximum Jitter Value	60 to 400 ms	The default maximum dynamic jitter buffer of 300 milliseconds is the maximum delay tolerable over a high jitter network. Default = 300 msec
Optimization Factor	0 to 12	The Optimization Factor determines how quickly the length of the Dynamic Jitter Buffer is changed based on actual jitter encountered on the network. Selecting the minimum value of 0 means low voice delay is desired, but increases the possibility of jitter-induced voice quality problems. Selecting the maximum value of 12 means highest voice quality under jitter conditions is desired at the cost of increased voice delay. Default = 7.

Voice/Fax Parameter Definitions (cont'd)		
Field Name	Values	Description
Auto Disconnect		
Automatic Disconnection	--	The Automatic Disconnection group provides four options which can be used singly or in any combination.
Jitter Value	1-65535 milliseconds	The Jitter Value defines the average inter-arrival packet deviation (in milliseconds) before the call is automatically disconnected. The default is 150 milliseconds. A higher value means voice transmission will be more accepting of jitter. A lower value is less tolerant of jitter. Inactive by default. When active, default = 150 ms. However, value must equal or exceed Dynamic Minimum Jitter Value.
Call Duration	1-65535 seconds	Call Duration defines the maximum length of time (in seconds) that a call remains connected before the call is automatically disconnected. Inactive by default. When active, default = 180 sec. This may be too short for most configurations, requiring upward adjustment.
Consecutive Packets Lost	1-65535	Consecutive Packets Lost defines the number of consecutive packets that are lost after which the call is automatically disconnected. Inactive by default. When active, default = 30
Network Disconnection	1 to 65535 seconds; Default = 300 sec.	Specifies how long to wait before disconnecting the call when IP network connectivity with the remote site has been lost.

9. **Set T1/E1/ISDN Parameters.** This dialog box can be reached by pulldown menu, toolbar icon, keyboard shortcut, or sidebar.

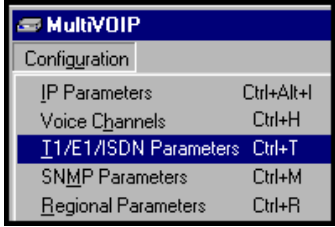
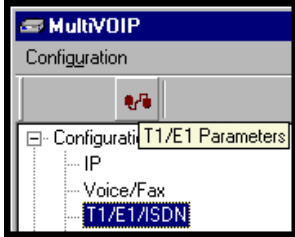
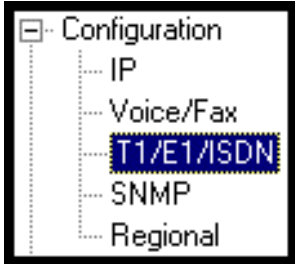
Accessing "T1/E1/ISDN Parameters"	
Pulldown	Icon
	
Shortcut	Sidebar
<p>Ctrl + T</p>	

In each field, enter the values that fit your particular network.

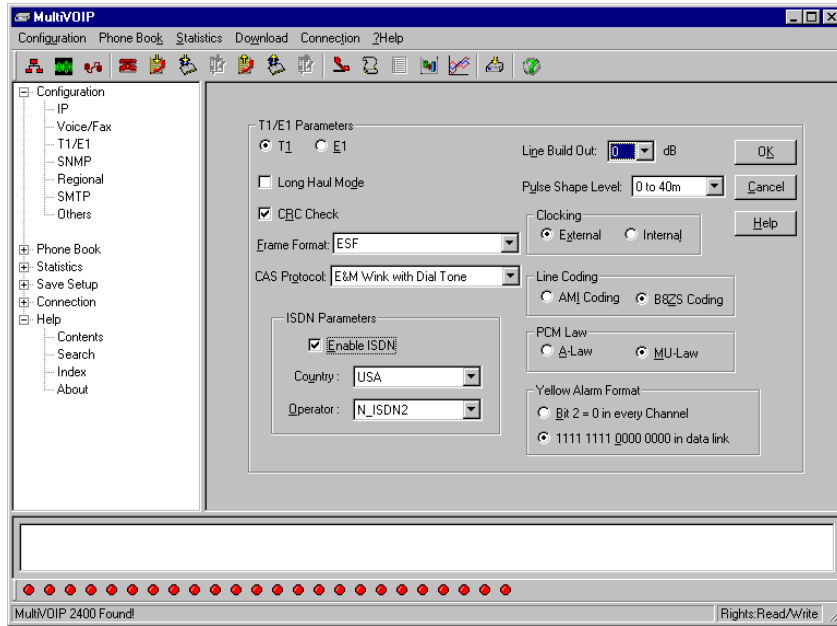

T1 Parameters. The parameters applicable to T1 and their values are shown in the figure below. These **T1 Parameter** fields are described in the tables that follow.

T1 Parameter Definitions		
Field Name	Values	Description
T1/E1/ISDN	T1	North American standard.
Long-Haul Mode	Y/N	In Long-Haul Mode, the MultiVOIP auto-matically recovers received signals as low as -36 dB. The maximum reachable length with 22 AWG cable is 2000 meters. When Long-Haul Mode is disabled, signals as low as -10 dB can be received. Default: disabled.
CRC Check (Cyclic Redundancy Check)	Y/N	When enabled, allows generation and checking of CRC bits. If not enabled, all check bits in the transmit direction are set. Only applies to ESF frame format. Default: enabled.
Frame Format	F4, D4, ESF, SLC96	Frame Format of MultiVOIP should match that used by PBX or telco. ESF and D4 are commonly used.

T1 Parameter Definitions (cont'd)		
Field Name	Values	Description
CAS Protocol	E&M Immed Strt E&M Wink Start E&M Wink with dial tone FXO Ground Strt FXO Loop Start FXS Ground Strt FXS Loop Start	<p>Channel Associated Signaling (CAS) is a method of incorporating telephony signaling info into a T1 voice/data stream. In CAS, the signaling bits (the A, B, C, and D bits) are multiplexed into the signal stream of each T1 channel. (By contrast, in Common Channel Signaling (CCS), one channel handles signaling for all other channels.) Each CAS protocol defines the states of the signaling bits during the various stages of a call (IDLE, SEIZED, ANSWER, RING-ON, RING-OFF).</p> <p>The CAS protocol code allows the VOIP to interact properly with the PBX or central-office switch that it serves. The need to download CAS protocols arises for only a small minority of VOIP users, and only when PBX/switch is found to be incompatible with standard protocols.</p> <p>Match this parameter to the setting of PBX or central-office switch.</p>

T1 Parameter Definitions (cont'd)		
ISDN Parameters		
Field Name	Values	Description
Enable ISDN-PRI	Y/N	If digital connection is ISDN-PRI type, this box should be checked. When ISDN is enabled, the "CAS Protocols" field is grayed out (ISDN has its own signaling method).
Terminal/Network	either "Terminal" or "Network"	When "Terminal" is selected, it indicates that the MultiVOIP should emulate the subscriber (terminal) side of the digital connection. When "Network" is selected, it indicates that the MultiVOIP should emulate the central office (network) side of the digital connection. Setting used for MultiVOIP must be opposite to the setting used in the PBX. For example, if the PBX is set to "Terminal," then the MultiVOIP must be set to "Network."
Country	see table, later this chapter	Country in which MultiVOIP is operating with ISDN.
Operator	see table, later this chapter	Indicates phone switch manufacturer/model or refers to telco so as to specify the switching system in question. ISDN is implemented somewhat differently in different switches.
Note on Country & Operator options.	—	[ISDN implementation options are shown, arranged by country, in a table below – soon after E1 Parameter Definitions.]

T1 Parameter Definitions (cont'd)		
Field Name	Values	Description
Line Build Out	0 dB, -7.5 dB, -15 dB, -22.5 dB	To reduce the crosstalk on received signals, a transmit attenuator can be placed in the data path. Transmit attenuation is selectable. Default: 0 dB
Pulse Shape Level	0 to 40 Meters 40 to 81 m 81 to 122 m 122 to 162 m 162 to 200 m	Refers to length of cable between MultiVOIP and PBX/telco in meters. Most common will be 0 to 40m.
Clocking	External/Internal	Set opposite to telco/PBX setting. Example: if telco clocking internal, set VOIP clocking as external.
Line Coding	AMI / B8ZS	Match to PBX or telco.
PCM Law	A-Law/Mu-Law	Match to PBX or telco. "Mu-law" is analog-to-digital compression/expansion standard used in North America. "A-law" is European standard.
Yellow Alarm Format	Bit 2 / 1111...	Depending on the Frame Format used, there are choices of Yellow Alarm format, as follows: D4: -Bit2 = 0 in every speech channel -FS bit of frame 12 is forced to one. ESF: -Bit2 = 0 in every speech channel -1111111100000000 pattern in data link channel. Check with your PBX/telco administrator for the correct setting or use the default value (1111 ...).

E1 Parameters. The parameters applicable to E1 and their values are shown in the figure below. These **E1 Parameter** fields are described in the tables that follow.

T1/E1/ISDN Parameters

T1 E1

Long Haul Mode

CRC Check

Line Build Out: 0 dB

Frame Format: MultiFrame with CRC4(modified)

Pulse Shape Level: 0 to 40m

CAS Prglocat: E&M Wink with Dial Tone

Clocking: External Internal

Line Coding: AMI Coding HDB3 Coding

PCM Law: A-Law MU-Law

ISDN Parameters

Enable ISDN-PR!

Terminal Network

Country: []

Operator: []

E1 Parameter Definitions		
Field Name	Values	Description
T1/E1/ISDN	E1	European standard.
Long-Haul Mode	Y/N	In Long-Haul Mode, the MultiVOIP auto-matically recovers received signals as low as -36 dB. The maximum reachable length with 22 AWG cable is 2000 meters. When Long-Haul Mode is disabled, signals as low as -10 dB can be received. Default: disabled.
CRC Check (Cyclic Redundancy Check)	--	Not applicable to E1.
Frame Format	Double Frame; MultiFrame (with CRC4); MultiFrame (w/CRC4, modified)	Frame Format of MultiVOIP should match that used by PBX or telco.

E1 Parameter Definitions (cont'd)		
Field Name	Values	Description
CAS Protocol	E&M Immed Strt E&M Wink Start E&M Wink with dial tone FXO Ground Strt FXO Loop Start FXS Ground Strt FXS Loop Start MFR2ITU MFR2 China MFR2 ANI	<p>Channel Associated Signaling (CAS) is a method of incorporating telephony signaling info into an E1 voice/data stream. In CAS, the signaling bits (the A, B, C, and D bits) are multiplexed into the signal stream of each E1 channel. (By contrast, in Common Channel Signaling (CCS), one channel handles signaling for all other channels.) Each CAS protocol defines the states of the signaling bits during the various stages of a call (IDLE, SEIZED, ANSWER, RING-ON, RING-OFF).</p> <p>The CAS protocol code allows the VOIP to interact properly with the PBX or central-office switch that it serves. The need to download CAS protocols arises for only a small minority of VOIP users, and only when PBX/switch is found to be incompatible with standard protocols.</p> <p>Match this parameter to the setting of PBX or central-office switch.</p>

E1 Parameter Definitions (cont'd)		
ISDN Parameters		
Field Name	Values	Description
Enable ISDN-PRI	Y/N	If digital connection is ISDN-PRI type, this box should be checked. When ISDN is enabled, the "CAS Protocols" field is grayed out (ISDN has its own signaling method).
Terminal/Network	either "Terminal" or "Network"	When "Terminal" is selected, it indicates that the MultiVOIP should emulate the subscriber (terminal) side of the digital connection. When "Network" is selected, it indicates that the MultiVOIP should emulate the central office (network) side of the digital connection. Setting used for MultiVOIP must be opposite to the setting used in the PBX. For example, if the PBX is set to "Terminal," then the MultiVOIP must be set to "Network."
Country	see table, later this chapter	Country in which MultiVOIP is operating with ISDN.
Operator	see table, later this chapter	Indicates phone switch manufacturer/model or refers to telco so as to specify the switching system in question. ISDN is implemented somewhat differently in different switches.
Note on Country & Operator options.	—	[ISDN implementation options are shown, arranged by country, in a table below – soon after E1 Parameter Definitions.]

E1 Parameter Definitions (cont'd)		
Field Name	Values	Description
Line Build Out	0 dB, -7.5 dB, -15 dB, -22.5 dB	To reduce the crosstalk on received signals, a transmit attenuator can be placed in the data path. Transmit attenuation is selectable. Default: 0 dB
Pulse Shape Level	0 to 40 Meters 40 to 81 m 81 to 122 m 122 to 162 m 162 to 200 m	Refers to length of cable between MultiVOIP and PBX/telco in meters. Most common will be 0 to 40m.
Clocking	External/Internal	Set opposite to telco/PBX setting. Example: if telco clocking internal, set VOIP clocking as external.
Line Coding	AMI / HDB3	Match to PBX or telco.
PCM Law	A-Law/Mu-Law	Match to PBX or telco. "A-law" is analog-to-digital compression/expansion standard used in Europe. "Mu-law" is North American standard.

10. **Set ISDN Parameters** (if applicable). These parameters are accessible in the **T1/E1/ISDN Parameters** screen. If your T1 or E1 phone line is a Primary Rate Interface ISDN line, enable ISDN-PRI and set it for the particular implementation of ISDN that your telco uses. The ISDN types supported by the digital MultiVOIP units (at press time) are listed below, organized by country.

ISDN Parameters

Enable ISDN-PRI

Terminal Network

Country :

Operator :

Country :	Operator :
Australia	AUSTEL_1
Belgium	BG_V1
Europe	ETSI ECMA_QSIG FT_VN6 RITA
France	FT_VN2 FT_VN3 FT_VN6
Germany	DT_1TR6
HongKong	HK_TEL
Italy	ETSI
Japan	NTT KDD
Korea	KOREAN_OP
NewZealand	TEL_NZ
Sweden	SWD_TVKT
USA	N_ISDN1 N_ISDN2 ATT_4ESS ATT_5E5 ATT_5E9 ATT_5E10 BELLCORE_PRI NT_DMS100
UK	BT_ISDN2

11. **Set SNMP Parameters** (Remote Voip Management). This dialog box can be reached by pulldown menu, keyboard shortcut, or sidebar. To make the MultiVOIP controllable by a remote PC running the MultiVoipManager software, check the “Enable SNMP Agent” box on the **SNMP Parameters** screen.

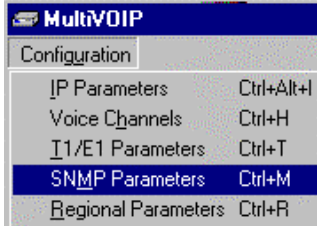
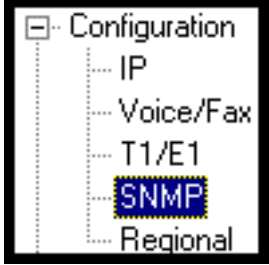
Accessing “SNMP Parameters”	
Pulldown	Icon
	
Shortcut	Sidebar
<p>Ctrl + M</p>	

In each field, enter the values that fit your particular system.



The image shows a configuration dialog box titled "SNMP Parameters". It contains the following elements:

- A checked checkbox labeled "Enable SNMP Agent".
- A "Trap Manager" section containing:
 - An "Address" field with the value "0 . 0 . 0 . 0".
 - A "Community Name" field (empty).
 - A "Port Number" field with the value "162".
- Two "Community Name - 1" entries:
 - The first has a "Community Name" field with "public" and a "Permissions" dropdown menu set to "Read Only".
 - The second has a "Community Name" field with "public" and a "Permissions" dropdown menu with "Read/Write" selected. The dropdown menu is open, showing "Read Only" and "Read/Write" as options.
- Three buttons on the right side: "OK", "Cancel", and "Help".

The SNMP Parameter fields are described in the table below.

SNMP Parameter Definitions		
Field Name	Values	Description
Enable SNMP Agent	Y/N	Enables the SNMP code in the firmware of the MultiVOIP. This must be enabled for the MultiVOIP to communicate with and be controllable by the MultiVoipManager software. Default: disabled
Trap Manager Parameters		
Address	4 places; n.n.n.n n = 0-255	IP address of MultiVoipManager PC.
Community Name	--	A "community" is a group of VOIP endpoints that can communicate with each other. Often "public" is used to designate a grouping where all end users have access to entire VOIP network. However, calling permissions can be configured to restrict access as needed.
Port Number	162	The default port number of the SNMP manager receiving the traps is the standard port 162.
Community Name 1	Length = 19 characters (max.) Case sensitive.	First community grouping.
Permissions	Read-Only, Read/Write	If this community needs to change MultiVOIP settings, select Read/Write. Otherwise, select Read-Only to view settings.
Community Name 2	Length = 19 characters (max.) Case sensitive.	Second community grouping
Permissions	Read-Only, Read/Write	If this community needs to change MultiVOIP settings, select Read/Write. Otherwise, select Read-Only to view settings.

12. Set Regional Parameters (Phone Signaling Tones & Cadences).

This dialog box can be reached by pulldown menu, keyboard shortcut, or sidebar.

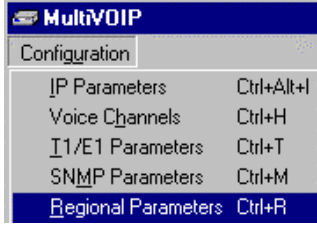
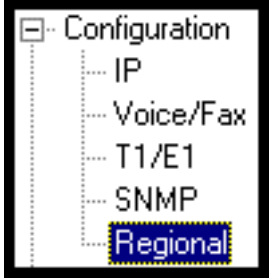
Accessing "Regional Parameters"	
Pulldown	Icon
	
Shortcut	Sidebar
<p>Ctrl + R</p>	

The **Regional Parameters** screen will appear. For the country selected, the standard set of frequency pairs will be listed for dial tone, busy tone, 'unobtainable' tone (fast busy or trunk busy), and ring tone.

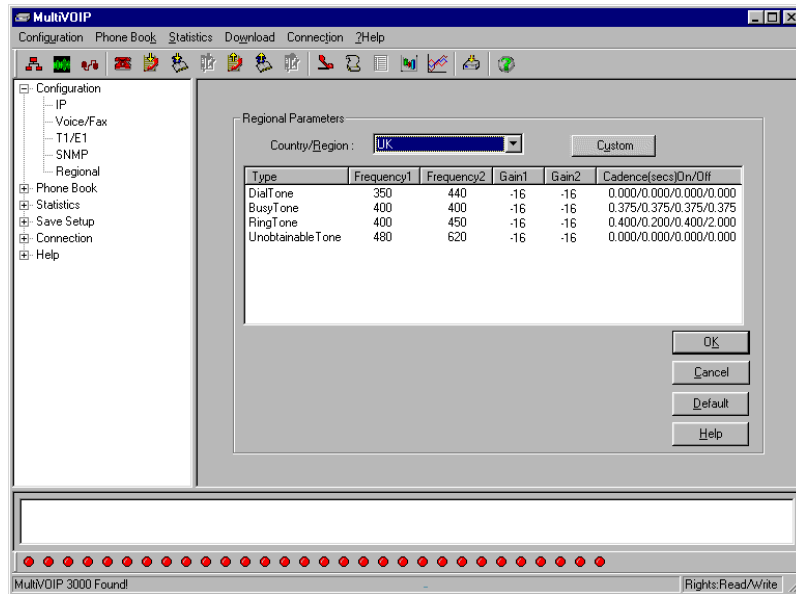

In each field, enter the values that fit your particular system.

The **Regional Parameters** fields are described in the table below.

“Regional Parameter” Definitions		
Field Name	Values	Description
Country/ Region	USA, Japan, UK, Custom	Name of a country or region that uses a certain set of tone pairs for dial tone, ring tone, busy tone, and ‘unobtainable’ tone (fast busy tone). In some cases, the tone-pair scheme denoted by a country name may also be used outside of that country. The “Custom” option (button) assures that any tone-pairing scheme worldwide can be accommodated.
Type column	dial tone, ring tone, busy tone, unobtainable tone (fast busy)	Type of telephony tone-pair for which frequency, gain, and cadence are being presented.
Frequency 1	frequency in Hertz	Lower frequency of pair.
Frequency 2	frequency in Hertz	Higher frequency of pair.
Gain 1	gain in dB +3dB to -31dB and “mute” setting	Amplification factor of lower frequency of pair. This figure describes amplification that the MultiVOIP applies to outbound tones entering the MultiVOIP at the T1 port. Default: -16dB
Gain 2	gain in dB +3dB to -31dB and “mute” setting	Amplification factor of higher frequency of pair. This figure describes amplification that the MultiVOIP applies to outbound tones entering the MultiVOIP at the T1 port. Default: -16dB

"Regional Parameter" Definitions (cont'd)		
Field Name	Values	Description
Cadence (msec) On/Off	n/n/n/n four integer time values in milli-seconds; zero value for dial-tone indicates continuous tone	On/off pattern of tone durations used to denote phone ringing, phone busy, connection unobtainable (fast busy), and dial tone (continuous and described as "0"). Default values differ for different countries/regions. Although most cadences have only two parts (an "on" duration and an "off" duration), some telephony cadences have four parts. Most cadences, then, are expressed as two iterations of a two-part sequence. Although this is redundant, it is necessary to allow for expression of 4-part cadences.
Custom (button)	--	Click on the "Custom" button to bring up the Custom Tone Pair Settings screen. This screen allows the user to specify tone pair attributes that are not found in any of the standard national/regional telephony toning schemes.

13. **Set Custom Tones and Cadences** (optional) . The **Regional Parameters** dialog box has a secondary dialog box that allows you to customize DTMF tone pairs to create unique ring-tones, dial-tones, busy-tones or “unobtainable” tones (fast busy signal) for your system. This screen allows the user to specify tone-pair attributes that are not found in any of the standard national/regional telephony toning schemes. To access this customization feature, click on the **Custom** button on the **Regional Parameters** screen.

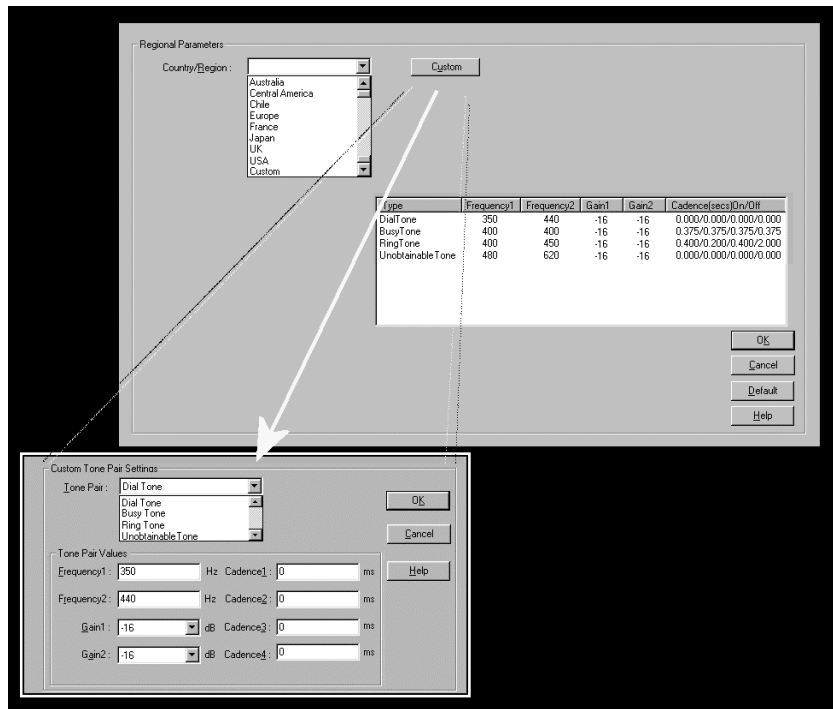

The **Custom Tone-Pair Settings** fields are described in the table below.

Custom Tone-Pair Settings Definitions		
Field Name	Values	Description
Tone Pair	dial tone busy tone ring tone, 'unobtainable' tone	Identifies the type of telephony signaling tone for which frequencies are being specified.
TONE PAIR VALUES		About Defaults: US telephony values are used as defaults on this screen. However, since this dialog box is provided to allow custom tone-pair settings, default values are essentially irrelevant.
Frequency 1	frequency in Hertz	Frequency of lower tone of pair. This outbound tone pair enters the MultiVOIP at the T1/E1 port.
Frequency 2	frequency in Hertz	Frequency of higher tone of pair. This outbound tone pair enters the MultiVOIP at the T1/E1 port.
Gain 1	gain in dB +3dB to -31dB and "mute" setting	Amplification factor of lower frequency of pair. This figure describes amplification that the MultiVOIP applies to outbound tones entering the MultiVOIP at the T1 port. Default = -16dB
Gain 2	gain in dB +3dB to -31dB and "mute" setting	Amplification factor of higher frequency of pair. This figure describes amplification that the MultiVOIP applies to outbound tones entering the MultiVOIP at the T1 port. Default = -16dB

Custom Tone-Pair Settings Definitions		
Field Name	Values	Description
Cadence 1	integer time value in milli-seconds; zero value for dial-tone indicates continuous tone	On/off pattern of tone durations used to denote phone ringing, phone busy, connection unobtainable tone (fast busy), and dial tone (which is continuous and described as "0"). Cadence 1 is duration of first period of tone being "on" in the cadence of the telephony signal (which could be ring-tone, busy-tone, unobtainable tone, or dial-tone).
Cadence 2	duration in milliseconds	Cadence 2 is duration of first "off" period in signaling cadence.
Cadence 3	duration in milliseconds	Cadence 3 is duration of second "on" period in signaling cadence.
Cadence 4	duration in milliseconds	Cadence 4 is duration of second "off" period in the signaling cadence, after which the 4-part cadence pattern of the telephony signal repeats.

14. **Set SMTP Parameters** (Log Reports by Email). The **SMTP Parameters** screen is applicable when the VOIP administrator has chosen to receive log reports by email (this is done by selecting the “SMTP” checkbox in the **Others** screen and selecting “Enable SMTP” in the **SMTP Parameters** screen.). The **SMTP Parameters** screen can be reached by pulldown menu, keyboard shortcut, or sidebar.

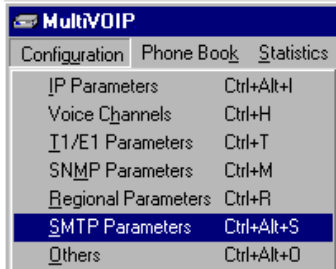
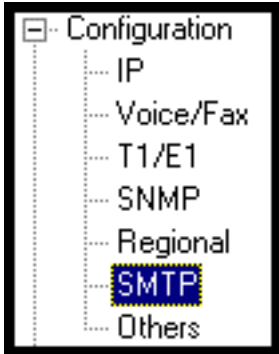
Accessing “SMTP Parameters”	
Pulldown	Icon
	
Shortcut	Sidebar
<p>Ctrl + Alt + S</p>	

MultiVOIP as Email Sender. When SMTP is used, the MultiVOIP will actually be given its own email account (with Login Name and Password) on some mail server connected to the IP network. Using this account, the MultiVOIP will then send out email messages containing log report information. The “Recipient” of the log report email is ordinarily the VoIP administrator. Because the MultiVOIP cannot receive email, a “Reply-To” address must also be set up. Ordinarily, the “Reply-To” address is that of a technician who has access to the mail server or MultiVOIP or both, and the VoIP administrator might also be designated as the “Reply-To” party. The main function of the Reply-To address is to receive error or failure messages regarding the emailed reports.

The **SMTP Parameters** screen is shown below.

"SMTP Parameters" Definitions		
Field Name	Values	Description
Enable SMTP	Y/N	In order to send log reports by email, this box must be checked. However, to enable SMTP functionality, you must also select "SMTP" in the Logs screen.
Login Name	alpha-numeric, per email domain	This is the User Name for the MultiVOIP unit's email account.
Password	alpha-numeric	Login password for MultiVOIP unit's email account.
Mail Server IP Address	n.n.n.n for n= 0 to 255	This mail server must be accessible on the IP network to which the MultiVOIP is connected.
Port Number	25	25 is a standard port number for SMTP.

.....

“SMTP Parameters” Definitions (cont’d)		
Field Name	Values	Description
Mail Type	text or html	Mail type in which log reports will be sent.
Subject	text	User specified. Subject line that will appear for all emailed log reports for this MultiVOIP unit.
Reply-To Address	email address	User specified. This email address functions as a source email identifier for the MultiVOIP, which, of course, cannot usefully receive email messages. The Reply-To address provides a destination for returned messages indicating the status of messages sent by the MultiVOIP (esp. to indicate when log report email was undeliverable or when an error has occurred).
Recipient Address	email address	User specified. Email address at which VOIP administrator will receive log reports.
Mail Criteria		Criteria for sending log summary by email. The log summary email will be sent out either when the user-specified number of log messages has accumulated, or once every day or multiple days, <i>which ever comes first</i> .
Number of Records	integer	This is the number of log records that must accumulate to trigger the sending of a log-summary email.
Number of Days	integer	This is the number of days that must pass before triggering the sending of a log-summary email.

The **SMTP Parameters** dialog box has a secondary dialog box, **Custom Fields**, that allows you to customize email log messages for the MultiVOIP. The MultiVOIP software logs data about many aspects of the call traffic going through the MultiVOIP. The Custom Fields screen lets you pick which aspects will be included in the email log reports.

"Custom Fields" Definitions			
Field	Description	Field	Description
Select All	Log report to include all fields shown.		
Channel Number	Data channel carrying call.	Start Date, Time	Date and time the phone call began.
Duration	Length of call.	Call Mode	Voice or fax.
Packets Sent	Total packets sent in call.	Packets Received	Total packets received in call.
Bytes Sent	Total bytes sent in call.	Bytes Received	Total bytes received in call.
Packets Lost	Packets lost in call.	Coder	Voice Coder /Compression Rate used for call will be listed in log.

“Custom Fields” Definitions (cont’d)			
Field	Description	Field	Description
Outbound Digits	Digits put out by MultiVOIP onto the T1 or E1 line.	Prefix Matched	When selected, the phonebook prefix matched in processing call will be listed in log.
Call Status	Successful or unsuccessful.		
From Details		To Details	
Gateway Number	Originating gateway	Gatew N.	Completing or terminating gateway
IP Addr	IP address where call originated.	IP Addr	IP address where call was completed or terminated.
Descript	Identifier of site where call originated.	Descript	Identifier of site where call was completed or terminated.
Options	When selected, log will not use/non-use of Silence Compression and Forward Error Correction by call originator.	Options	When selected, log will not use/non-use of Silence Compression and Forward Error Correction by call terminator.

SMTP

SMTP Parameters

Enable SMTP

Login Name:

Password:

Mail Server IP Address:

Port Number:

Mail Type: Text HTML

Subject:

Reply To Address:

Recipient Address:

Mail Criteria:

Number of Records:

Number of Days:

Logs

Enable Console Messages

Turn Off Logs

Reporting Method:

GUI SMTP SNMP

Custom Fields

Select All

Fields:

Chgnnel Number Start Date, Time

Dguration Call Mode

Packets Sepr Packets Received

Bytes Sent Bytes Received

Packets Lost Coder

Outbound Digits Prefix Matched

Call Status

From Details: GatewayName IPAddress Description Options

To Details: GatewayName IPAddress Description Options

Call Logs

Sl.No.	Start Date & Time	Duration	Status	Call Mode
1	01/17/2002 & 09:43:24	00:01:47	Success	Voice
2	01/17/2002 & 10:30:33	00:26:46	Success	Voice
3	01/17/2002 & 11:05:22	00:09:47	Success	Voice
4	01/17/2002 & 11:16:02	00:01:25	Success	Voice
5	01/17/2002 & 11:21:02	00:00:33	Success	Voice
6	01/17/2002 & 11:51:26	00:00:00	Unsuccess	Voice

Call Logs

Sl.No.	From IP Addr.	To IP Addr.	OutBound Digits	Prefix Matched
1	204.026.122.105	202.054.039.100		4470
2	204.026.122.105	202.054.039.100		4470
3	204.026.122.105	202.054.039.100		4470
4	202.054.039.100	204.026.122.105		763717
5	204.026.122.105	202.054.039.100		4470
6	204.026.122.105	202.054.039.100		4470

SMTP Parameters

Enable SMTP

Login Name:

Password:

Mail Server IP Address:

Port Number:

Mail Type: Text HTML

Subject:

Reply To Address:

Recipient Address:

Mail Criteria:

Number of Records:

Number of Days:

Logs

Enable Console Messages

Turn Off Logs

Reporting Method:

GUI SMTP SNMP

Custom Fields

Select All

Fields:

Chgnnel Number Start Date, Time

Dguration Call Mode

Packets Sepr Packets Received

Bytes Sent Bytes Received

Packets Lost Coder

Outbound Digits Prefix Matched

Call Status

From Details: GatewayName IPAddress Description Options

To Details: GatewayName IPAddress Description Options

Call Logs

Sl.No.	Start Date & Time	Duration	Status	Call Mode
1	01/17/2002 & 09:43:24	00:01:47	Success	Voice
2	01/17/2002 & 10:30:33	00:26:46	Success	Voice
3	01/17/2002 & 11:05:22	00:09:47	Success	Voice
4	01/17/2002 & 11:16:02	00:01:25	Success	Voice
5	01/17/2002 & 11:21:02	00:00:33	Success	Voice
6	01/17/2002 & 11:51:26	00:00:00	Unsuccess	Voice

Call Logs

Sl.No.	From IP Addr.	To IP Addr.	OutBound Digits	Prefix Matched
1	204.026.122.105	202.054.039.100		4470
2	204.026.122.105	202.054.039.100		4470
3	204.026.122.105	202.054.039.100		4470
4	202.054.039.100	204.026.122.105		763717
5	204.026.122.105	202.054.039.100		4470
6	204.026.122.105	202.054.039.100		4470

To use the "SMTP Parameters" screen, SMTP must first be selected in the "Logs" screen.

The secondary screen "Custom Fields" lets the user determine which technical details of each phone call to record in the logs.

Email reports can be sent out periodically or when a certain number of phone calls have been logged.

The requested technical details will then appear in the log report that is automatically emailed to the VoIP administrator.

15. Set Log Reporting Method. The **Logs** screen lets you choose how the VoIP administrator will receive log reports about the MultiVOIP's performance and the phone call traffic that is passing through it. Log reports can be received in one of three ways:

- A. in the MultiVOIP program (GUI),
- B. via email (SMTP), or
- C. at the MultiVoipManager remote voip system management program (SNMP).

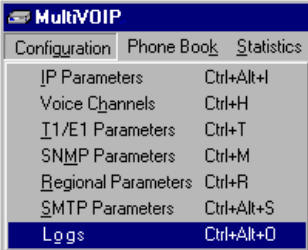
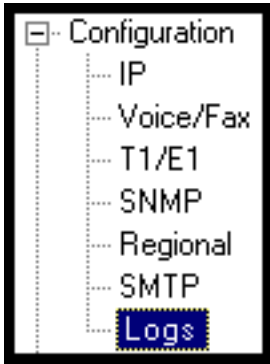
Accessing "Logs" Screen	
Pulldown	Icon
 <p>A screenshot of the MultiVOIP application's pulldown menu. The menu is titled 'MultiVOIP' and contains several options: Configuration, Phone Book, and Statistics. Below these are several parameter settings, each with a keyboard shortcut: IP Parameters (Ctrl+Alt+I), Voice Channels (Ctrl+H), T1/E1 Parameters (Ctrl+T), SNMP Parameters (Ctrl+M), Regional Parameters (Ctrl+R), SMTP Parameters (Ctrl+Alt+S), and Logs (Ctrl+Alt+O). The 'Logs' option is highlighted in blue.</p>	
Shortcut	Sidebar
<p>Ctrl + Alt + O</p>	 <p>A screenshot of the MultiVOIP application's sidebar. The sidebar is titled 'Configuration' and contains a list of options: IP, Voice/Fax, T1/E1, SNMP, Regional, SMTP, and Logs. The 'Logs' option is highlighted in blue.</p>

Select the logging option that applies to your VoIP system design. If you intend to use a SysLog Server program for logging, click in that Enable check box. The common SysLog logical port number is 514. If you intend to use the MultiVOIP web browser GUI for configuration and control of MultiVOIP units, be aware that the web browser GUI does not support logs directly. However, when the web browser GUI is used, log files can still be sent to the voip administrator via email (which requires activating the SMTP logging option in this screen).

“Logs” Screen Definitions

Field Name	Values	Description
Enable Console Messages	Y/N	Allows MultiVOIP debugging messages to be read via a basic telecommunications program like HyperTerminal™ or similar application. Normally, this should be disabled because it consumes MultiVOIP processing resources. Console messages are intended for use by tech support personnel.
Turn Off Logs	Y/N	Disables log reporting function.
Logs Buttons		Only one of these three log reporting methods, GUI, SMTP, or SNMP, may be chosen.
GUI	Y/N	User must view logs at the MultiVOIP configuration program.

SNMP	Y/N	Log messages will be delivered to the MultiVoipManager application program.
SMTP	Y/N	Log messages will be sent to user-specified email address.
SysLog Server Enable	Y/N	This box must be checked if logging is to be done in conjunction with a SysLog Server program. For more on SysLog Server, see <i>Operation & Maintenance</i> chapter.
IP Address	n.n.n.n for n= 0-255	IP address of computer, connected to voip network, on which SysLog Server program is running.
Port	514	Logical port for SysLog Server. 514 is commonly used.
Online Statistics Updation Interval	integer	Set the interval (in seconds) at which logging information will be updated.

16. **Set Supplementary Services Parameters.** This dialog box can be reached by pulldown menu, keyboard shortcut, or sidebar.

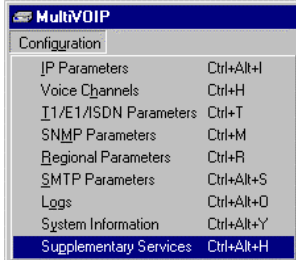
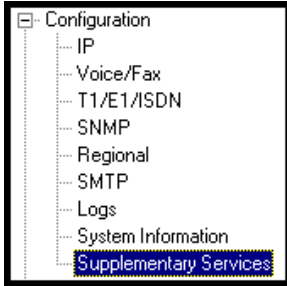
Accessing “Supplementary Services Parameters”	
Pulldown	Icon
	
Shortcut	Sidebar
<p>Ctrl + Alt +H</p>	

Supplementary Services features derive from the H.450 standard, which brings to voip telephony functionality once only available with PSTN or PBX telephony. Supplementary Services features can be used under H.323 only and not under SIP.

In each field, enter the values that fit your particular network.

Of the features implemented under Supplementary Services, three are very closely related: Call Transfer, Call Hold, and Call Waiting. Call Name Identification is similar but not identical to the premium PSTN feature commonly known as **Caller ID**.

Call Transfer. Call Transfer allows one party to re-connect the party with whom they have been speaking to a third party. The first party is disconnected when the third party becomes connected. Feature is invoked by a program-mable phone keypad sequence (for example, #7).

Call Hold. Call Hold allows one party to maintain an idle (non-talking) connection with another party while receiving another call (Call Waiting), while initiating another call (Call Transfer), or while performing some other call management function. Invoked by keypad sequence.

Call Waiting. Call Waiting notifies an engaged caller of an incoming call and allows them to receive a call from a third party while the party with whom they have been speaking is put on hold. Invoked by keypad sequence.

Call Name Identification. When enabled for a given voip unit (the 'home' voip), this feature gives notice to remote voips involved in calls. Notification goes to the remote voip administrator, not to individual phone stations. When the home voip is the caller, a plain English descriptor will be sent to the remote (callee) voip identifying

the channel over which the call is being originated (for example, “Calling Party - Omaha Sales Office Line 2”). If that voip channel is dedicated to a certain individual, the descriptor could say that, as well (for example “Calling Party - Harold Smith in Omaha”). When the home voip receives a call from any remote voip, the home voip sends a status message back to that caller. This message confirms that the home voip’s phone channel is either busy or ringing or that a connection has been made (for example, “Busy Party - Omaha Sales Office Line ”). These messages appear in the **Statistics – Call Progress** screen of the remote voip.

Note that Supplementary Services parameters are applied on a channel-by-channel basis. However, once you have established a set of Supplementary parameters for a particular channel, you can apply this entire set of parameters to another channel by using the **Copy Channel** button and its dialog box. To copy a set of Supplementary Services parameters to all channels, select “Copy to All” and click **Copy**.

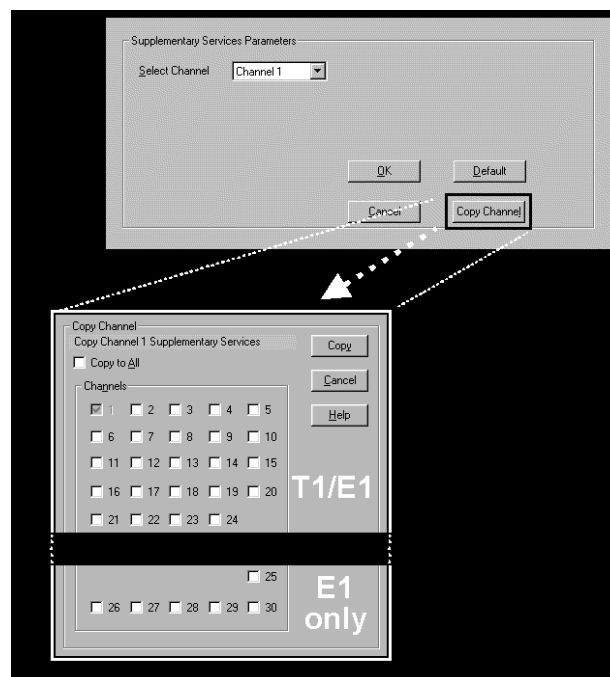

The **Supplementary Services** fields are described in the tables below.

Supplementary Services Parameter Definitions		
Field Name	Values	Description
Select Channel	1-2 (210); 1-4 (410); 1-8 (810)	The channel to be configured is selected here.
Call Transfer Enable	Y/N	Select to enable the Call Transfer function in the voip unit. This is a “blind” transfer and the sequence of events is as follows: Callers A and B are having a conversation. Caller A wants to put B into contact with C. Caller A dials call transfer sequence. Caller A hears dial tone and dials number for caller C. Caller A gets disconnected while Caller B gets connected to caller C.
Transfer Sequence	any phone keypad character	The numbers and/or symbols that the caller must press on the phone keypad to initiate a call transfer. The call-transfer sequence can be 1 to 4 characters in length using any combination of digits or characters (* or #). The sequences for call transfer, call hold, and call waiting can be from 1 to 4 digits in length consisting of any combination of digits 1234567890*#.

Supplementary Services Definitions (cont'd)		
Field Name	Values	Description
Call Hold Enable	Y/N	Select to enable Call Hold function in voip unit. Call Hold allows one party to maintain an idle (non-talking) connection with another party while receiving another call (Call Waiting), while initiating another call (Call Transfer), or while performing some other call management function.
Hold Sequence	phone keypad characters	The numbers and/or symbols that the caller must press on the phone keypad to initiate a call hold. The call-hold sequence can be 1 to 4 characters in length using any combination of digits or characters (* or #).
Call Waiting Enable	Y/N	Select to enable Call Waiting function in voip unit.
Retrieve Sequence	phone keypad characters, two characters in length	The numbers and/or symbols that the caller must press on the phone keypad to initiate retrieval of a waiting call. The call-waiting retrieval sequence can be 1 to 4 characters in length using any combination of digits or characters (* or #). This is the phone keypad sequence that a user must press to retrieve a waiting call. Customize-able. Sequence should be distinct from sequence that might be used to retrieve a waiting call via the PBX or PSTN.

Supplementary Services Definitions (cont'd)		
Field Name	Values	Description
Call Name Identification Enable		<p>Enables CNI function. Call Name Identification is not the same as Caller ID. When enabled on a given voip unit currently being controlled by the MultiVOIP GUI (the 'home voip'), Call Name Identification sends an identifier and status information to the administrator of the remote voip involved in the call. The feature operates on a channel-by-channel basis (each channel can have a separate identifier).</p> <p>If the home voip is originating the call, only the Calling Party field is applicable. If the home voip is receiving the call, then the Alerting Party, Busy Party, and Connected Party fields are the only applicable fields (and any or all of these could be enabled for a given voip channel). The status information confirms back to the originator that the callee (the home voip) is either busy, or ringing, or that the intended call has been completed and is currently connected.</p> <p>The identifier and status information are made available to the remote voip unit and appear in the Caller ID field of its Statistics - Call Progress screen. (This is how MultiVOIP units handle CNI messages; in other voip brands, H.450 may be implemented differently and then the message presentation may vary.)</p>

Supplementary Services Definitions (cont'd)		
Field Name	Values	Description
Calling Party, Allowed Name Type (CNI)		<p>If the 'home' voip unit is originating the call and Calling Party is selected, then the identifier (from the Caller Id field) will be sent to the remote voip unit being called. The Caller Id field gives the remote voip administrator a plain-language identifier of the party that is originating the call occurring on a specific channel.</p> <p>This field is applicable only when the 'home' voip unit is originating the call.</p> <p>Example. Suppose a voip system has offices in both Denver and Omaha. In the Omaha voip unit (the 'home' voip in this example), Call Name Identification has been enabled, Calling Party has been enabled as an Allowed Name Type, and "Omaha Sales Office Voipchannel 2" has been entered in the Caller Id field.</p> <p>When channel 2 of the Omaha voip is used to make a call to any other voip phone station (for example, the Denver office), the message "Calling Party - Omaha Sales Office Voipchannel 2" will appear in the "Caller Id" field of the Statistics - Call Progress screen of the Denver voip.</p>

Supplementary Services Definitions (cont'd)		
Field Name	Values	Description
Alerting Party, Allowed Name Type (CNI)		<p>If the 'home' voip unit is receiving the call and Alerting Party is selected, then the identifier (from the Caller Id field) will tell the originating remote voip unit that the call is ringing.</p> <p>This field is applicable only when the 'home' voip unit is receiving the call.</p> <p>Example. Suppose a voip system has offices in both Denver and Omaha. In the Omaha voip unit (the 'home' voip unit in this example), Call Name Identification has been enabled, Alerting Party has been enabled as an Allowed Name Type, and "Omaha Sales Office Voipchannel 2" has been entered in the Caller Id field of the Supplementary Services screen.</p> <p>When channel 2 of the Omaha voip receives a call from any other voip phone station (for example, the Denver office), the message "Alerting Party - Omaha Sales Office Voipchannel 2" will be sent back and will appear in the Caller Id field of the Statistics - Call Progress screen of the Denver voip. This confirms to the Denver voip that the phone is ringing in Omaha.</p>

Supplementary Services Definitions (cont'd)		
Field Name	Values	Description
Busy Party, Allowed Name Type (CNI)		<p>If the 'home' voip unit is receiving a call directed toward an already engaged channel or phone station and Busy Party is selected, then the identifier (from the Caller Id field) will tell the originating remote voip unit that the channel or called party is busy.</p> <p>This field is applicable only when the 'home' voip unit is receiving the call.</p> <p>Example. Suppose a voip system has offices in both Denver and Omaha. In the Omaha voip unit (the 'home' voip unit in this example), Call Name Identification has been enabled, Busy Party has been enabled as an Allowed Name Type, and "Omaha Sales Office Voipchannel 2" has been entered in the Caller Id field of the Supplementary Services screen.</p> <p>When channel 2 of the Omaha voip is busy but still receives a call attempt from any other voip phone station (for example, the Denver office), the message "Busy Party - Omaha Sales Office Voipchannel 2" will be sent back and will appear in the Caller Id field of the Statistics - Call Progress screen of the Denver voip. This confirms to the Denver voip that the channel or phone station is busy in Omaha.</p>

Supplementary Services Definitions (cont'd)		
Field Name	Values	Description
Connected Party, Allowed Name Type (CNI)		<p>If the 'home' voip unit is receiving a call and Connected Party is selected, then the identifier (from the Caller Id field) will tell the originating remote voip unit that the attempted call has been completed and the connection is made.</p> <p>This field is applicable only when the 'home' voip unit is receiving the call.</p> <p>Example. Suppose a voip system has offices in both Denver and Omaha. In the Omaha voip unit (the 'home' voip unit in this example), Call Name Identification has been enabled, Connected Party has been enabled as an Allowed Name Type, and "Omaha Sales Office Voipchannel 2" has been entered in the Caller Id field of the Supplementary Services screen.</p> <p>When channel 2 of the Omaha voip completes an attempted call from any other voip phone station (for example, the Denver office), the message "Connected Party - Omaha Sales Office Voipchannel 2" will be sent back and will appear in the Caller Id field of the Statistics - Call Progress screen of the Denver voip. This confirms to the Denver voip that the call has been completed to Omaha.</p>

Supplementary Services Definitions (cont'd)		
Field Name	Values	Description
Caller ID		This is the identifier of a specific channel of the 'home' voip unit. The Caller Id field typically describes a person, office, or location, for example, "Harry Smith," or "Bursar's Office," or "Barnesville Factory."
Default	--	When this button is clicked, all Supplementary Service parameters are set to their default values.
Copy Channel	--	Copies the Supplementary Service attributes of one channel to another channel. Attributes can be copied to multiple channels or all channels at once.

17. **Set Baud Rate.** The **Connection** option in the sidebar menu has a “Settings” item that includes the baud-rate setting for the COM port of the computer running the MultiVOIP software.

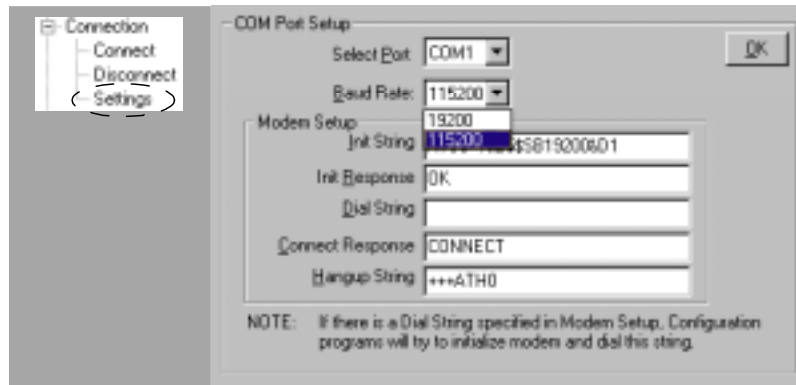

First, it is important to note that the default COM port established by the MultiVOIP program is COM1. ***Do not accept the default value until you have checked the COM port allocation on your PC.*** To do this, check for COM port assignments in the system resource dialog box(es) of your Windows operating system. If COM1 is not available, you must change the COM port setting to COM2 or some other COM port that you have confirmed as being available on your PC.

The default baud rate is 115,200 bps.

18. View **System Information** screen and set updating interval (optional).

This dialog box can be reached by pulldown menu, keyboard shortcut, or sidebar.

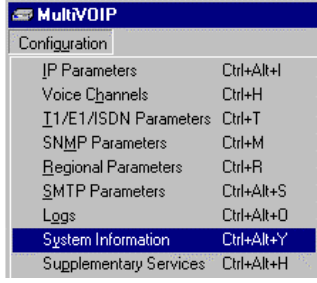
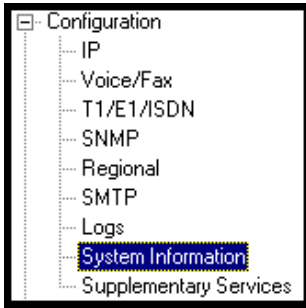
Accessing the “System Information” Screen	
Pulldown	Icon
	
Shortcut	Sidebar
<p>Ctrl + Alt + Y</p>	

This screen presents vital system information at a glance. It's primary use is in troubleshooting.

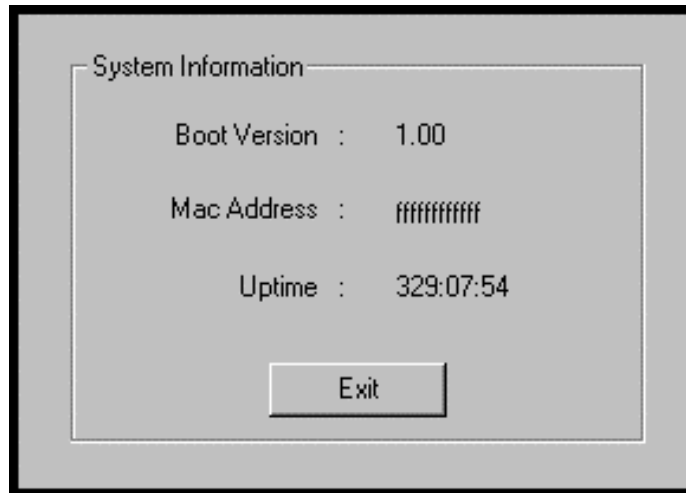

System Information Parameter Definitions		
Field Name	Values	Description
Boot Code Version	nn.nn	Indicates the version of the code that is used at the startup (booting) of the voip. The boot code version is independent of the software version.
Mac Address	alpha-numeric	Denotes the number assigned as the voip unit's unique Ethernet address.
Up Time	hours: mm:ss	Indicates how long the voip has been running since its last booting.

The frequency with which the System Information screen is updated is determined by a setting in the Logs screen

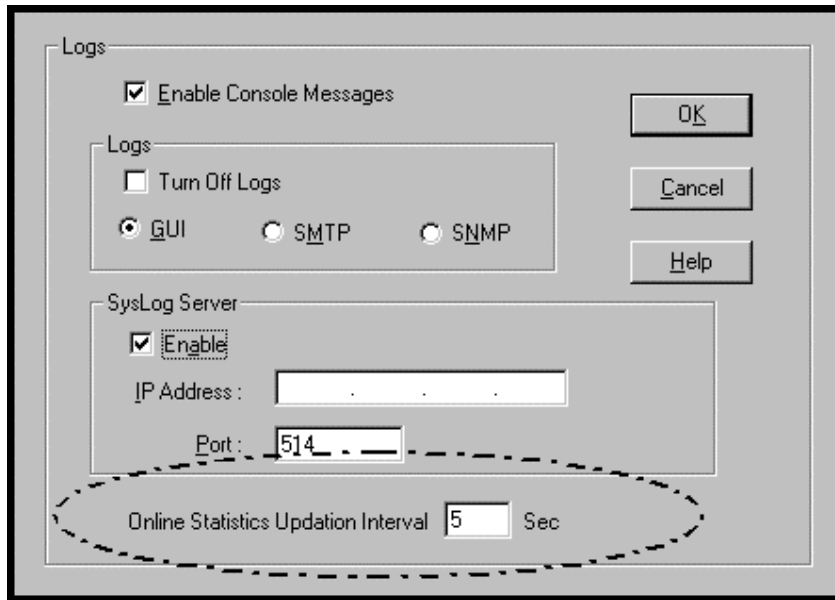

19. Saving the MultiVOIP Configuration. When values have been set for all of the MultiVOIP's various operating parameters, click on **Save Setup** in the sidebar.

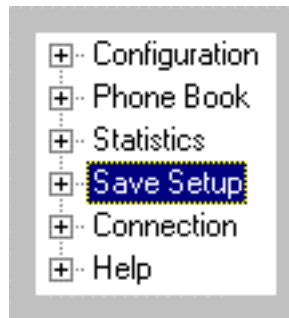

20. **Creating a User Default Configuration.** When a “Setup” (complete grouping of parameters) is being saved, you will be prompted about designating that setup as a “User Default” setup. A User Default setup may be useful as a baseline of site-specific values to which you can easily revert. Establishing a User Default Setup is optional.

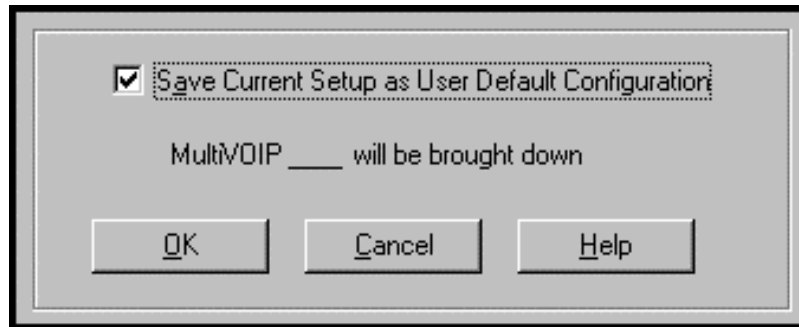

Chapter 6: Technical Configuration for Analog MultiVOIPs (MVP210/410/810)

Configuring the Analog MultiVOIP

There are two ways in which the MultiVOIP must be configured before operation: technical configuration and phonebook configuration.

Technical Configuration. First, the MultiVOIP must be configured to operate with technical parameter settings that will match the equipment with which it interfaces. There are eight types of technical parameters that must be set.

These technical parameters pertain to

- (1) its operation in an IP network,
- (2) its operation with telephony equipment,
- (3) its transmission of voice and fax messages,
- (4) its interaction with SNMP (Simple Network Management Protocol) network management software (MultiVoipManager),
- (5) certain telephony attributes that are common to particular nations or regions,
- (6) its operation with a mail server on the same IP network (per SMTP parameters) such that log reports about VoIP telephone call traffic can be sent to the administrator by email,
- (7) implementing some common premium telephony features (Call Transfer, Call Hold, Call Waiting, Call ID – “Supplementary Services”), and
- (8) selecting the method by which log reports will be made accessible.

The process of specifying values for the various parameters in these seven categories is what we call “technical configuration” and it is described in this chapter.

Phonebook Configuration. The second type of configuration required for the MultiVOIP pertains to the phone number dialing sequences that it will receive and transmit when handling calls. Dialing patterns will be affected by both the PBX/telephony equipment and the other VOIP devices that the MultiVOIP unit interacts with. We call this “Phonebook Configuration,” and, for analog MultiVOIP units, it is described nominally in *Chapter 9: Analog Phonebook Configuration* of this manual. But, in fact, nearly all of the descriptions and examples for analog phonebook configuration are to be found in Chapter 7 if the analog voip is operating under the North American telephony scheme, or in Chapter 8 if the analog voip is operating under a European telephony scheme. Chapter 2, the *Quick Start Instructions*, presents additional examples relevant to the analog voips.

Local/Remote Configuration. The MultiVOIP must be configured locally at first (to establish an IP address for the MultiVOIP unit). But changes to this initial configuration can be done either locally or remotely.

Local configuration is done through a connection between the “Command” port of the MultiVOIP and the COM port of the computer; the MultiVOIP configuration program is used.

Remote configuration is done through a connection between the MultiVOIP’s Ethernet (network) port and a computer connected to the same network. The computer could be miles or continents away from the MultiVOIP itself. There are two ways of doing remote configuration and operation of the MultiVOIP unit: (1) using the MultiVoipManager SNMP program, or (2) using the MultiVOIP web browser interface program.

MultiVoipManager. MultiVoipManager is an SNMP agent program (Simple Network Management Protocol) that extends the capabilities of the MultiVOIP configuration program: MultiVoipManager allows the user to manage any number of VOIPs on a network, whereas the MultiVOIP configuration program can manage only the VOIP to which it is directly/locally connected. The MultiVoipManager can configure multiple VOIPs simultaneously, whereas the MultiVOIP configuration program can configure only one at a time.

MultiVoipManager may (but does not need to) reside on the same PC as the MultiVOIP configuration program. The MultiVoipManager program is on the MultiVOIP Product CD. Updates, when applicable, may be posted at on the MultiTech FTP site. To download, go to <ftp://ftp.multitech.com/MultiVoip/>.

Web Browser Interface. The MultiVOIP web browser GUI gives access to the same commands and configuration parameters as are available in the MultiVOIP Windows GUI except for logging functions. When using the web browser GUI, logging can be done by email (the SMTP option).

Functional Equivalence The MultiVOIP configuration program is required to do the initial configuration (that is, setting an IP address for the MultiVOIP unit) so that the VOIP unit can communicate with the MultiVoipManager program or with the web browser GUI. Management of the VOIP after that point can be done from any of these three programs since they all offer essentially the same functionality. Functionally, either the MultiVoipManager program or the web browser GUI can replace the MultiVOIP configuration program after the initial configuration is complete (with minor exceptions, as noted).

WARNING: Do not attempt to interface the MultiVOIP unit with two control programs simultaneously (that is, by accessing the MultiVOIP configuration program via the Command Port and either the MultiVoipManager program or the web browser interface via the Ethernet Port). The results of using two programs to control a single VOIP simultaneously would be unpredictable.

Local Configuration

This manual describes local configuration only. For information on remote configuration and management, see the MultiVoipManager documentation.

Pre-Requisites



To complete the configuration of the MultiVOIP unit, you **must** know several things about the overall system.

Before configuring your MultiVOIP Gateway unit, you must know the values for several IP and telephone parameters that describe the IP network system and telephony system (PBX or telco central office equipment) with which the digital MultiVOIP will interact. If you plan to receive log reports on phone traffic by email (SMTP), you must arrange to have an email address assigned to the VOIP unit on the email server on your IP network.

IP Parameters

The following parameters must be known about the network (LAN, WAN, Internet, etc.) to which the MultiVOIP will connect:

➤	<i>Ask your computer network administrator.</i>	<i>Info needed to operate: all MultiVOIP models.</i>
	 IP Network Parameters: Record for each VOIP Site in System	
	• IP Address	
	• IP Mask	
	• Gateway	
	• Domain Name Server (DNS) Info <i>(not implemented; for future use)</i>	

Write down the values for these IP parameters. You will need to enter these values in the “IP Parameters” screen in the Configuration section of the MultiVOIP software. You must have this IP information about every VOIP in the system.

Analog Telephony Interface Parameters (for MVP210/410/810)

The following parameters must be known about the PBX or telco central office equipment to which the analog MultiVOIP will connect :

➤	Analog Phone Parameters <i>Ask phone company or telecom manager.</i>	<i>Needed for:</i> MVP810 MVP410 MVP210
	 Analog Telephony Interface Parameters: Record for this VOIP Site	
	<ul style="list-style-type: none"> • Which interface type (or “signaling”) is used? E&M _____ FXS/FXO _____ 	
	<ul style="list-style-type: none"> • If FXS, determine whether the line will be used for a phone, fax, or KTS (key telephone system) 	
	<ul style="list-style-type: none"> • If FXO, determine if line will be an analog PBX extension or an analog line from a telco central office 	
	<ul style="list-style-type: none"> • If E&M, determine these aspects of the E&M trunk line from the PBX: <ul style="list-style-type: none"> • What is its Type (1, 2, 3, 4, or 5)? • Is it 2-wire or 4-wire? • Is it Dial-Tone or Wink? 	

Write down the values for these telephony parameters. You will need to enter these values in the “Interface” screen in the Configuration section of the MultiVOIP software.

SMTP Parameters (for email call log reporting)

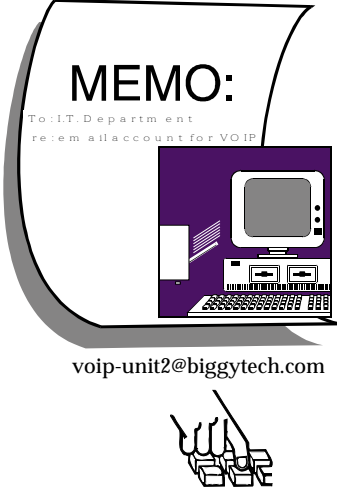
<i>required if log reports of VOIP call traffic are to be sent by email</i>	Optional
<p>SMTP Parameters Preparation Task:</p> <p>Ask Mail Server administrator to set up email account (with password) for the MultiVOIP unit itself. Be sure to give a unique identifier to each individual MultiVOIP unit .</p> <p>Get the IP address of the mail server computer, as well.</p>	 <p>MEMO: To: I.T. Department From: email account for VOIP</p> <p>voip-unit2@biggytech.com</p>

Local Configuration Procedure (Summary)

After the MultiVOIP configuration software has been installed in the 'Command' PC (which is connected to the MultiVOIP unit), several steps must be taken to configure the MultiVOIP to function in its specific setting. Although the summary below includes all of these steps, some are optional.

1. Check Power and Cabling.
2. Start MultiVOIP Configuration Program.
3. Confirm Connection.
4. Solve Common Connection Problems.
 - A. Fixing a COM Port Problem.
 - B. Fixing a Cabling Problem.
5. Familiarize yourself with configuration parameter screens and how to access them.
6. Set IP Parameters.
7. Enable web browser GUI (optional).
8. Set Voice/Fax Parameters.
9. Set Telephony Interface Parameters.
10. Set SNMP Parameters (applicable if MultiVoipManager remote management software is used).
11. Set Regional Parameters (Phone Signaling Tones and Cadences).
12. Set Custom Tones and Cadences (optional).
13. Set SMTP Parameters (applicable if Log Reports are via Email).
14. Set Log Reporting Method (GUI, locally in MultiVOIP Configuration program; SNMP, remotely in MultiVoipManager program; or SMTP, via email).
15. Set Supplementary Services Parameters. The Supplementary Services screen allows voip deployment of features that are normally found in PBX or PSTN systems (e.g., call transfer and call waiting).
16. Set Baud Rate (of COM port connection to 'Command' PC).
17. View System Info screen and set updating interval (optional).
18. Save the MultiVOIP configuration.
19. Create a User Default Configuration (optional).

Local Configuration Procedure (Detailed)

You can begin the configuration process as a continuation of the MultiVOIP software installation. You can establish your configuration or modify it at any time by launching the MultiVOIP program from the Windows **Start** menu.

1. **Check Power and Cabling.** Be sure the MultiVOIP is turned on and connected to the computer via the MultiVOIP's Command Port (DB9 connector at computer's COM port; RJ45 connector at MultiVOIP).
2. **Start MultiVOIP Configuration Program.** Launch the MultiVOIP program from the Windows **Start** menu (from the folder location determined during installation).

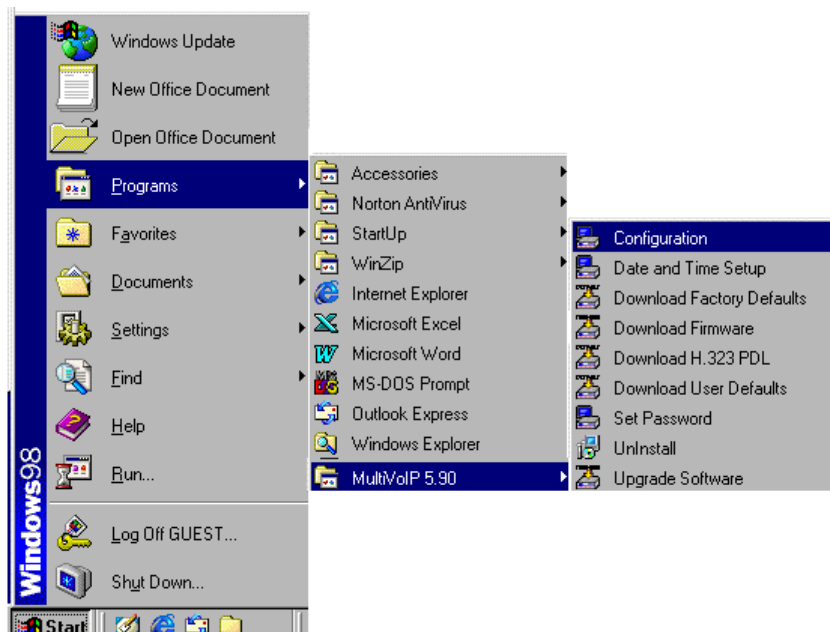

3. **Confirm Connection.** If the MultiVOIP is set for an available COM port and is correctly cabled to the PC, the MultiVOIP main screen will appear. (If the main screen appears *grayed out* and seems inaccessible, go to step 4.)

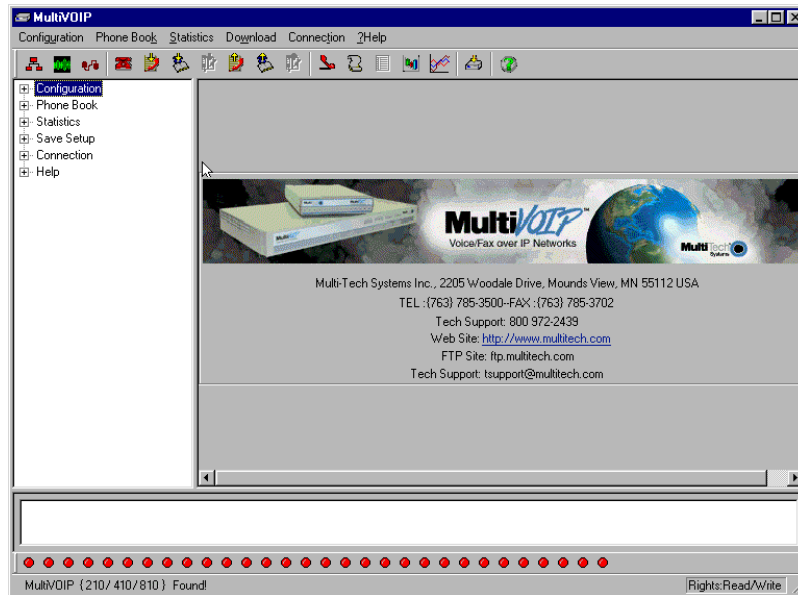

In the lower left corner of the screen, the connection status of the MultiVOIP will be displayed. The messages in the lower left corner will change as detection occurs. The message “MultiVOIP Found” confirms that the MultiVOIP is in contact with the MultiVOIP configuration program. Skip to step 5.

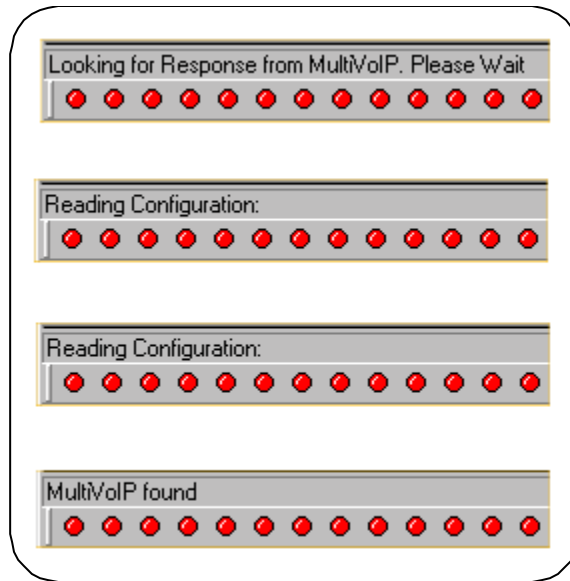

4. Solving Common Connection Problems. .

A. Fixing a COM Port Problem. If the MultiVOIP main screen appears but is grayed out and seems inaccessible, the COM port that was specified for its communication with the PC is unavailable and must be changed. An error message will appear.



To change the COM port setting, use the **COM Port Setup** dialog box, which is accessible via the keyboard shortcut **Ctrl + G** or by going to the **Connection** pull-down menu and choosing “Settings.” In the “Select Port” field, select a COM port that is available on the PC. (If no COM ports are currently available, re-allocate COM port resources in the computer’s MS Windows operating system to make one available.)

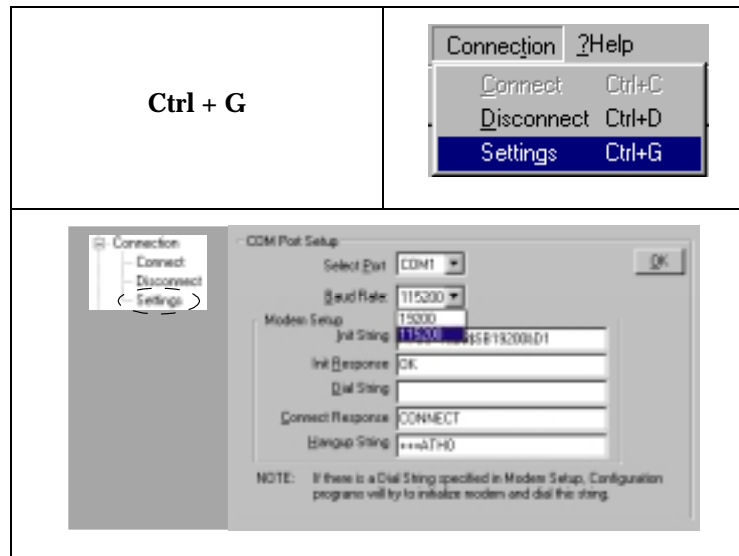

4B. Fixing a Cabling Problem. If the MultiVOIP cannot be located by the computer, two error messages will appear (saying “Multi-VOIP Not Found” and “Phone Database Not Read”).

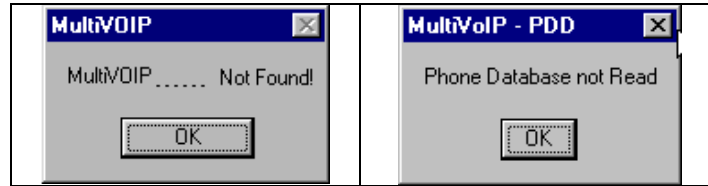

In this case, the MultiVOIP is simply disconnected from the network. For instructions on MultiVOIP cable connections, see the Cabling section of Chapter 3.

5. Configuration Parameter Groups: Getting Familiar, Learning About Access. The first part of configuration concerns IP parameters, Voice/FAX parameters, Telephony Interface parameters, SNMP parameters, Regional parameters, SMTP parameters, Supplementary Services parameters, Logs, and System Information. In the MultiVOIP software, these seven types of parameters are grouped together under “Configuration” and each has its own dialog box for entering values.

Generally, you can reach the dialog box for these parameter groups in one of four ways: pulldown menu, toolbar icon, keyboard shortcut, or sidebar. ..

6. **Set IP Parameters.** This dialog box can be reached by pulldown menu, toolbar icon, keyboard shortcut, or sidebar.

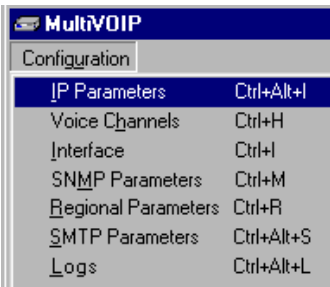
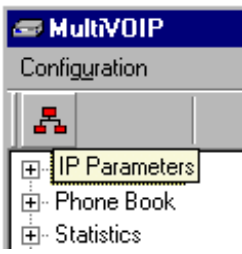
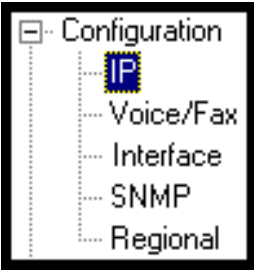
Accessing "IP Parameters"	
Pulldown	Icon
	
Shortcut	Sidebar
<p>Ctrl + Alt + I</p>	

In each field, enter the values that fit your particular network.

The image shows a network configuration dialog box with the following sections:

- IP Parameters:**
 - Enable Diffserv
 - Frame Type: TYPE-II (dropdown menu)
 - IP Address: 192 . 168 . 3 . 143
 - IP Mask: 255 . 255 . 255 . 0
 - GateWay: . . .
- DNS:**
 - Enable DNS
 - DNS Server IP Address: . . .
- FTP Server:**
 - Enable

Buttons: OK, Cancel, Help

A callout box highlights the Frame Type dropdown menu, showing the following options:

- TYPE-II (selected)
- SNAP

The **IP Parameters** fields are described in the table below.

IP Parameter Definitions		
Field Name	Values	Description
Enable Diffserv	Y/N	Diffserv is used for QoS (quality of service). When enabled, we configure the TOS (Type of Service) bits in the IP header so routers supporting Diffserv can give priority to the VOIP's IP packets. Disabled by default.
Frame Type	Type II, SNAP	Must be set to match network's frame type. Default is Type II.
IP Address	4-places, 0-255	The unique LAN IP address assigned to the MultiVOIP.
IP Mask	4-places, 0-255	Subnetwork address that allows for sharing of IP addresses within a LAN.
Gateway	4-places, 0-255. <i>(feature not yet implemented; for future use)</i>	The IP address of the device that connects your MultiVOIP to the Internet.
Enable DNS	Y/N. <i>(feature not yet implemented; for future use)</i>	Enables Domain Name Space/System function where computer names are resolved using a worldwide distributed database.
DNS Server IP Address	4-places, 0-255	IP address of specific DNS server to be used to resolve Internet computer names.
FTP Server Enable	Y/N See "FTP Server File Transfers" in <i>Operation & Maintenance</i> chapter.	MultiVOIP unit has an FTP Server function so that firmware and other important operating software files can be transferred to the voip via the network.

7. Enable Web Browser GUI (Optional). After an IP address for the MultiVOIP unit has been established, you can choose to do any further configuration of the unit (a) by using the MultiVOIP web browser GUI, or (b) by continuing to use the MultiVOIP Windows GUI. If you want to do configuration work using the web browser GUI, you must first enable it. To do so, follow the steps below.

- A. Set IP address of MultiVOIP unit using the MultiVOIP Configuration program (the Windows GUI).
- B. Save Setup in Windows GUI.
- C. Close Windows GUI.
- D. Install Java program from MultiVOIP product CD (on first use only).
- E. Open web browser.
- F. Browse to IP address of MultiVOIP unit.
- G. If username and password have been established, enter them when when prompted.
- H. Use web browser GUI to configure or operate MultiVOIP unit. The configuration screens in the web browser GUI will have the same content as their counterparts in the Windows GUI; only the graphic presentation will be different.

For more details on enabling the MultiVOIP web GUI, see the “Web Browser Interface” section of the *Operation & Maintenance* chapter of this manual.

8. Set Voice/FAX Parameters. This dialog box can be reached by pulldown menu, toolbar icon, keyboard shortcut, or sidebar.

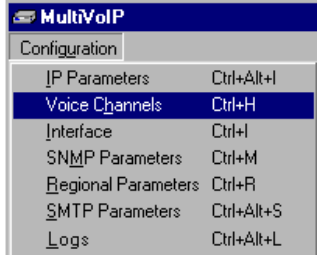
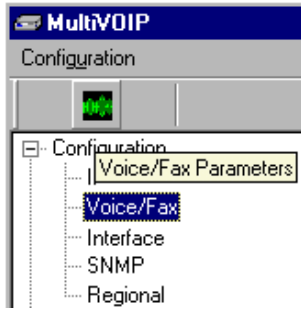
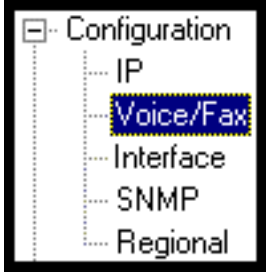
Accessing "Voice/FAX Parameters"	
Pulldown	Icon
	
Shortcut	Sidebar
<p>Ctrl + H</p>	

In each field, enter the values that fit your particular network.

Voice/Fax Parameters

Select Channel

Voice Gain

Input dB Output dB

Dtmf

Gain

High dB Low dB

Duration ms

DTMF :

Coder

Manual Automatic

Selected Coder

Max bandwidth kbps

Auto Call

Auto Call Enable

Phone Number

Dynamic Jitter Buffer

Minimum Jitter Value ms

Maximum Jitter Value ms

Optimization Factor

Automatic Disconnection

Jitter Value ms Consecutive Packets Lost

Call Duration seconds Network Disconnection seconds

Fax

Fax Enable

Max Baud Rate

Fax Volume dB

Jitter Value ms

Mode

Advanced Features

Silence Compression

Echo Cancellation

Forward Error Correction

OK

Cancel

Copy Channel

Default

Help

Note that Voice/FAX parameters are applied on a channel-by-channel basis. However, once you have established a set of Voice/FAX parameters for a particular channel, you can apply this entire set of Voice/FAX parameters to another channel by using the **Copy Channel** button and its dialog box. To copy a set of Voice/FAX parameters to all channels, select “Copy to All” and click **Copy**.

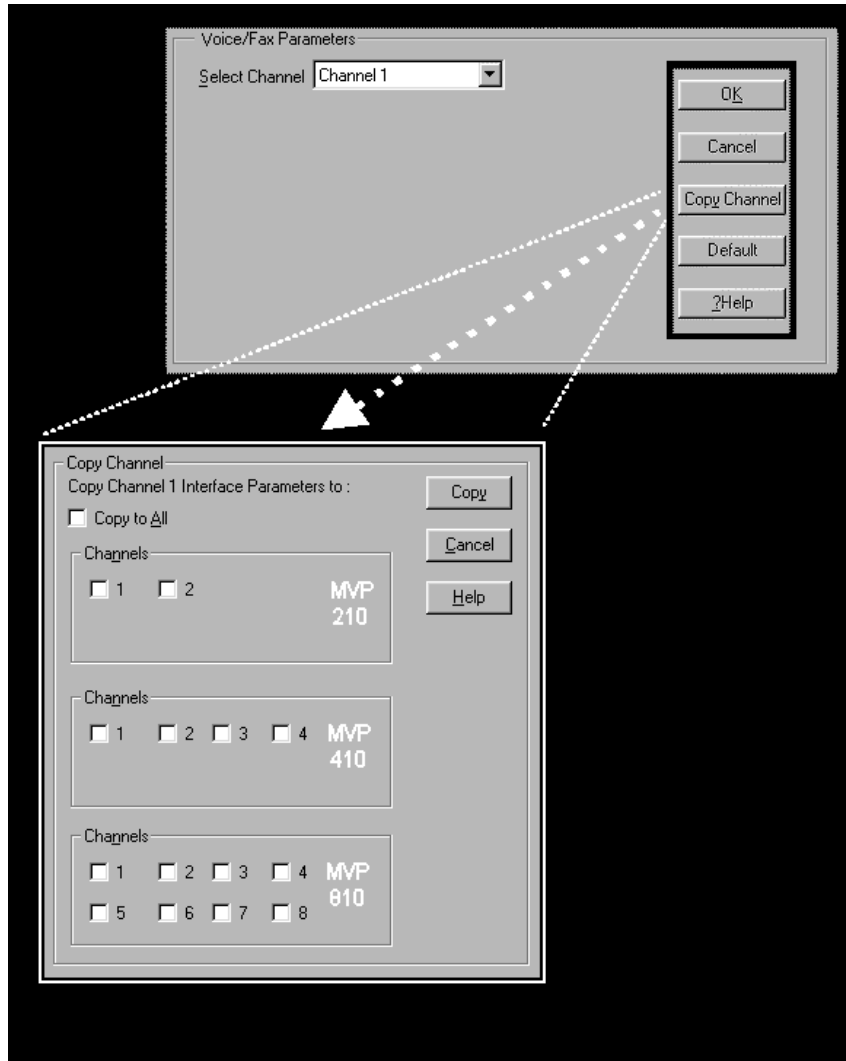

The **Voice/FAX Parameters** fields are described in the tables below.

Voice/Fax Parameter Definitions		
Field Name	Values	Description
Default	--	When this button is clicked, all Voice/FAX parameters are set to their default values.
Select Channel	1-2 (210) 1-4 (410) 1-8 (810)	Channel to be configured is selected here.
Copy Channel	--	Copies the Voice/FAX attributes of one channel to another channel. Attributes can be copied to multiple channels or all channels at once.
Voice Gain	--	Signal amplification (or attenuation) in dB.
Input Gain	+31dB to -31dB	Modifies audio level entering voice channel before it is sent over the network to the remote VOIP. The default & recommended value is 0 dB .
Output Gain	+31dB to -31dB	Modifies audio level being output to the device attached to the voice channel. The default and recommended value is 0 dB .
DTMF Parameters		
DTMF Gain	--	The DTMF Gain (Dual Tone Multi-Frequency) controls the volume level of the digital tones sent out for Touch-Tone dialing.
DTMF Gain, High Tones	+3dB to -31dB & "mute"	Default value: -4 dB . Not to be changed except under supervision of MultiTech's Technical Support.
DTMF Gain, Low Tones	+3dB to -31dB & "mute"	Default value: -7 dB . Not to be changed except under supervision of MultiTech's Technical Support.

Voice/Fax Parameter Definitions (cont'd)		
Field Name	Values	Description
DTMF Parameters		
Duration (DTMF)	60 – 3000 ms	When DTMF: Out of Band is selected, this setting determines how long each DTMF digit 'sounds' or is held. Default = 100 ms.
DTMF In/Out of Band	Out of Band, or Inband	When DTMF Out of Band is selected (checked), the MultiVOIP detects DTMF tones at its input and regenerates them at its output. When DTMF Inband is selected, the DTMF digits are passed through the MultiVOIP unit as they are received.
FAX Parameters		
Fax Enable	Y/N	Enables or disables fax capability for a particular channel.
Max Baud Rate (Fax)	2400, 4800, 7200, 9600, 12000, 14400 bps	Set to match baud rate of fax machine connected to channel (see Fax machine's user manual). Default = 14400 bps.
Fax Volume (Default = -9.5 dB)	-18.5 dB to -3.5 dB	Controls output level of fax tones. To be changed only under the direction of Multi-Tech's Technical Support.
Jitter Value (Fax)	Default = 400 ms	Defines the inter-arrival packet deviation (in milliseconds) for the fax transmission. A higher value will increase the delay, allowing a higher percentage of packets to be reassembled. A lower value will decrease the delay allowing fewer packets to be reassembled.
Mode (Fax)	FRF 11; T.38 (T.38 not currently supported)	FRF11 is frame-relay FAX standard using these coders: G.711, G.728, G.729, G.723.1. T.38 is an ITU-T standard for storing and forwarding FAXes via email using X.25 packets. It uses T.30 fax standards and includes special provisions to preclude FAX timeouts during IP transmissions.

Voice/Fax Parameter Definitions (cont'd)		
Coder Parameters		
Coder	Manual or Automatic	Determines whether selection of coder is manual or automatic. When Automatic is selected, the local and remote voice channels will negotiate the voice coder to be used by selecting the highest bandwidth coder supported by both sides without exceeding the Max Bandwidth setting. G.723, G.729, or G.711 are negotiated.
Selected Coder	G.711 a/u law 64 kbps; G.726 , @ 16/24/32 /40 kbps; G.727 , @ nine bps rates; G.723.1 @ 5.3 kbps, 6.3 kbps; G.729 , 8kbps; Net Coder @ 6.4, 7.2, 8, 8.8, 9.6 kbps	Select from a range of coders with specific bandwidths. The higher the bps rate, the more bandwidth is used. The channel that you are calling must have the same voice coder selected. Default = G.723.1 @ 6.3 kbps, as required for H.323. Here 64K of digital voice is compressed to 6.3K, allowing several simultaneous conversations over the same bandwidth that would otherwise carry only one. To make selections from the Selected Coder drop-down list, the Manual option must be enabled.
Max bandwidth (coder)	11 – 128 kbps	This drop-down list enables you to select the maximum bandwidth allowed for this channel. The Max Bandwidth drop-down list is enabled only if the Coder is set to Automatic. If coder is to be selected automatically ("Auto" setting), then enter a value for maximum bandwidth.

Voice/Fax Parameter Definitions (cont'd)		
Field Name	Values	Description
Advanced Features		
Silence Compression	Y/N	Determines whether silence compression is enabled (checked) for this voice channel. With Silence Compression enabled, the MultiVOIP will not transmit voice packets when silence is detected, thereby reducing the amount of network bandwidth that is being used by the voice channel. Default = off.
Echo Cancellation	Y/N	Determines whether echo cancellation is enabled (checked) for this voice channel. Echo Cancellation removes echo and improves sound quality. Default = on.
Forward Error Correction	Y/N	Determines whether forward error correction is enabled (checked) for this voice channel. Forward Error Correction enables some of the voice packets that were corrupted or lost to be recovered. FEC adds an additional 50% overhead to the total network bandwidth consumed by the voice channel. Default = Off
Auto Call Enable	Y/N	The Auto Call option enables the local MultiVOIP to call a remote MultiVOIP without the user having to dial a Phone Directory Database number. As soon as you access the local MultiVOIP voice/fax channel, the MultiVOIP immediately connects to the remote MultiVOIP identified in the Phone Number box of this option.
Phone No. (Auto Call)	--	Phone number used for Auto Call function. A corresponding phone number must be listed in the Outbound Phonebook.

Voice/Fax Parameter Definitions (cont'd)		
Field Name	Values	Description
Dynamic Jitter		
Dynamic Jitter Buffer		Dynamic Jitter defines a minimum and a maximum jitter value for voice communications. When receiving voice packets from a remote MultiVOIP, varying delays between packets may occur due to network traffic problems. This is called Jitter. To compensate, the MultiVOIP uses a Dynamic Jitter Buffer. The Jitter Buffer enables the MultiVOIP to wait for delayed voice packets by automatically adjusting the length of the Jitter Buffer between configurable minimum and maximum values. An Optimization Factor adjustment controls how quickly the length of the Jitter Buffer is increased when jitter increases on the network. The length of the jitter buffer directly effects the voice delay between MultiVOIP gateways.
Minimum Jitter Value	60 to 400 ms	The minimum dynamic jitter buffer of 60 milliseconds is the minimum delay that would be acceptable over a low jitter network. Default = 150 msec

Voice/Fax Parameter Definitions (cont'd)		
Field Name	Values	Description
Dynamic Jitter		
Maximum Jitter Value	60 to 400 ms	The maximum dynamic jitter buffer of 400 milliseconds is the maximum delay tolerable over a high jitter network. Default = 300 msec
Optimization Factor	0 to 12	The Optimization Factor determines how quickly the length of the Dynamic Jitter Buffer is changed based on actual jitter encountered on the network. Selecting the minimum value of 0 means low voice delay is desired, but increases the possibility of jitter-induced voice quality problems. Selecting the maximum value of 12 means highest voice quality under jitter conditions is desired at the cost of increased voice delay. Default = 7.

Voice/Fax Parameter Definitions (cont'd)		
Field Name	Values	Description
Auto Disconnect		
Automatic Disconnection	--	The Automatic Disconnection group provides four options which can be used singly or in any combination.
Jitter Value	1-65535 milliseconds	The Jitter Value defines the average inter-arrival packet deviation (in milliseconds) before the call is automatically disconnected. The default is 300 milliseconds. A higher value means voice transmission will be more accepting of jitter. A lower value is less tolerant of jitter. Inactive by default. When active, default = 300 ms. However, value must equal or exceed Dynamic Minimum Jitter Value.
Call Duration	1-65535 seconds	Call Duration defines the maximum length of time (in seconds) that a call remains connected before the call is automatically disconnected. Inactive by default. When active, default = 180 sec. This may be too short for most configurations, requiring upward adjustment.
Consecutive Packets Lost	1-65535	Consecutive Packets Lost defines the number of consecutive packets that are lost after which the call is automatically disconnected. Inactive by default. When active, default = 30
Network Disconnection	1 to 65535 seconds; Default = 30 sec.	Specifies how long to wait before disconnecting the call when IP network connectivity with the remote site has been lost.

9. **Set Telephony Interface Parameters.** This dialog box can be reached by pulldown menu, toolbar icon, keyboard shortcut, or sidebar.

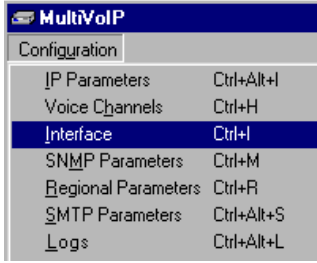
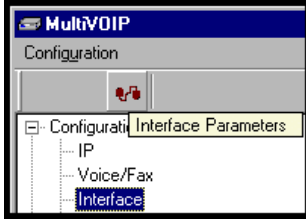
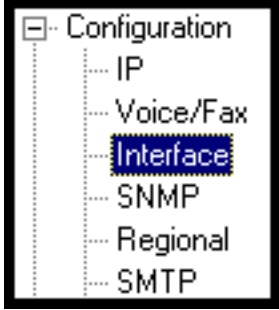
Accessing Telephony Interface Parameters	
Pulldown	Icon
	
Shortcut	Sidebar
<p>Ctrl + I</p>	

In each field, enter the values that fit your particular network.

The screenshot shows a configuration window titled "Interface" for "Channel 1". The "Interface" section has radio buttons for "FXS (Loop Start)", "FXS (Ground Start)", "FXO", and "E&M". The "E&M Options" section includes "Signal" (Dial Tone, Wink), "Wink Timer (in ms)" (250), "Type" (TYPE 1 2 Wire), and "Pass Through". The "Dialing Options" section includes "Regeneration" (Inter Digit Timer, Flash Hook Timer, Message Waiting Light), "Inter Digit Regeneration Time" (100), and "FXO Disconnect On" (Current Loss, Tone Detection, Silence Detection). The "Ring Count" section includes "Ring Count" (8), "FXO" (2), and "FXS Options" (Current Loss, Disconnect On Call Progress Tone). The "Disconnect Tone Sequence" section includes "Disconnect Tone Sequence" (A, None), "Silence Timer (in Seconds)" (15), and "Current Loss Detect Timer (in ms)" (500). Buttons for "OK", "Cancel", "Copy Channel", "Default", and "Help" are visible.

The kinds of parameters for which values must be chosen depend on the type of telephony supervisory signaling or interface used (FXO, E&M, etc.). We present here the various parameters grouped and organized by interface type.

FXS Loop Start Parameters. The parameters applicable to FXS Loop Start are shown in the figure below and described in the table that follows.

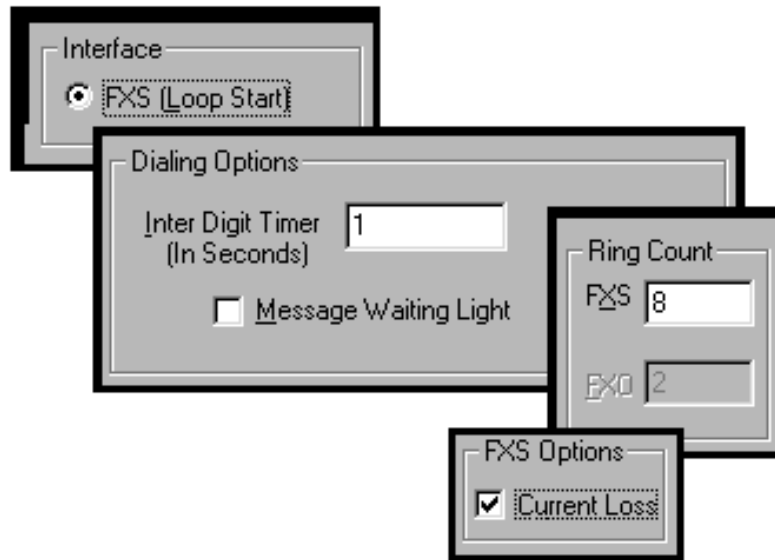

FXS Loop Start Interface: Parameter Definitions

Field Name	Values	Description
FXS Loop Start	Y/N	Enables FXS Loop Start interface type.
Inter Digit Timer	integer values in seconds	This is the length of time that the MultiVOIP will wait between digits. When the time expires, the MultiVOIP will look in the phonebook for the number entered. Default = 2.

FXS Loop Start Interface: Parameter Definitions		
Field Name	Values	Description
Message Waiting Light	Y/N	Applicable only when MultiVOIP is used with Avaya Magix PBX units equipped with Merlin Messaging Centralized mail. When enabled, the Message Waiting Light feature allows the PBX to send mode-codes and message-waiting indications to another Avaya Magix PBX, which in turn will turn on the message waiting light on a phone station. It also allows Direct Inward Dialing, such that no additional dial tone is needed on voip call.
Ring Count, FXS	integer values	Maximum number of rings that the MultiVOIP will issue before giving up the attempted call.
FXS Options, Current Loss	Y/N	When enabled, the MultiVOIP will interrupt loop current in the FXS circuit to initiate a disconnection. This tells the device connected to the FXS port to hang up. The MultiVOIP cannot drop the call; the FXS device must go on hook.

FXS Ground Start Parameters (not supported). The parameters applicable to FXS Ground Start are shown in the figure below and described in the table that follows.

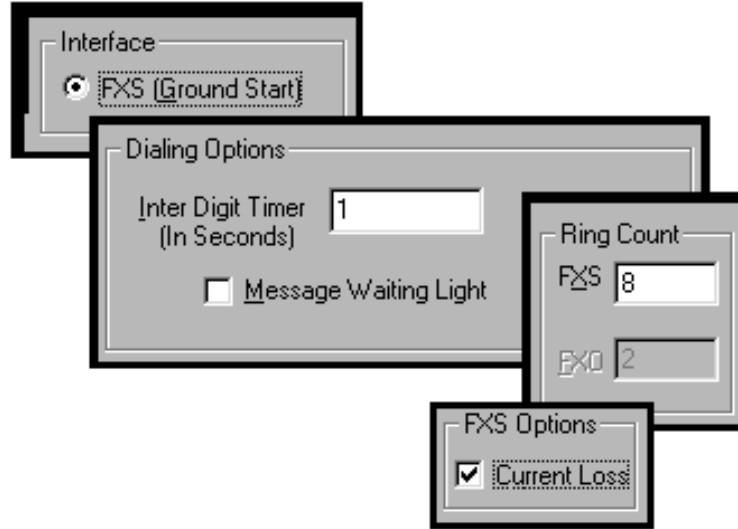

FXS Ground Start Interface: Parameter Definitions

Field Name	Values	Description
FXS Ground Start	Y/N	Enables FXS Loop Start interface type.
Inter Digit Timer	integer values in seconds	This is the length of time that the MultiVOIP will wait between digits. When the time expires, the MultiVOIP will look in the phonebook for the number entered. Default = 2.
Message Waiting Light	Y/N	Applicable only when MultiVOIP is used with Avaya Magix PBX units equipped with Merlin Messaging Centralized mail. When enabled, the Message Waiting Light feature allows the PBX to send mode-codes and message-waiting indications to another Avaya Magix PBX, which in turn will turn on the message waiting light on a phone station. It also

		allows Direct Inward Dialing, such that no additional dial tone is needed on voip call.
Ring Count, FXS	integer values	Maximum number of rings that the MultiVOIP will issue before giving up the attempted call.
FXS Options, Current Loss	Y/N	When enabled, the MultiVOIP will interrupt loop current in the FXS circuit to initiate a disconnection. This tells the device connected to the FXS port to hang up. The Multi-VOIP cannot drop the call; the FXS device must go on hook.

FXO Parameters. The parameters applicable to the FXO telephony interface type are shown in the figure below and described in the table that follows.

The image shows a configuration window for an FXO interface. It is divided into several sections:

- Interface:** A radio button labeled "FXO" is selected.
- Dialing Options:**
 - Regeneration:** Two radio buttons, "Pulse" and "DTMF", are present. "DTMF" is selected.
 - Inter Digit Timer (In Seconds):** A text box containing the value "1".
 - Flash Hook Timer (in ms):** A text box containing the value "600".
 - Message Waiting Light:** An unchecked checkbox.
 - Inter Digit Regeneration Time:** A text box containing the value "100".
- FXO Disconnect On:**
 - Current Loss:** A checked checkbox.
 - Tone Detection:** A checked checkbox.
 - Silence Detection:** A dropdown menu with "Two Way" selected.
 - Disconnect Tone Sequence:** Two dropdown menus, the first containing "'A'" and the second containing "None", separated by a plus sign.
 - Silence Timer (In Seconds):** A text box containing the value "15".
 - Current Loss Detect Timer (in ms):** A text box containing the value "500".
- Ring Count:** Two text boxes, one for "FXS" containing "8" and one for "FXO" containing "2".
- Disconnect On Call Progress Tone:** An unchecked checkbox labeled "Enable".

FXO Interface: Parameter Definitions		
Field Name	Values	Description
Interface, FXO	Y/N	Enables FXO functionality
Dialing Options		
Regeneration	Pulse, DTMF	Determines whether digits generated and sent out will be pulse tones or DTMF.
Inter Digit Timer	integer values, in seconds	This is the length of time that the MultiVOIP will wait between digits. When the time expires, the MultiVOIP will look in the phonebook for the number entered. Default = 2.
Flash Hook Timer	integer values, in milliseconds	Length of flash hook that will be generated and sent out when the remote end initiates a flash hook and it is regenerated locally. Default = 600 ms.
Message Waiting Light	Y/N	Applicable only when MultiVOIP is used with Avaya Magix PBX units equipped with Merlin Messaging Centralized mail. When enabled, the Message Waiting Light feature allows the PBX to send mode-codes and message-waiting indications to another Avaya Magix PBX, which in turn will turn on the message waiting light on a phone station. It also allows Direct Inward Dialing, such that no additional dial tone is needed on voip call.

FXO Interface: Parameter Definitions (cont'd)		
Field Name	Values	Description
Dialing Options (cont'd)		
Inter Digit Regeneration Time	milliseconds	The length of time between the outputting of DTMF digits. Default = 100 ms.
FXO Disconnect On		There are three possible criteria for disconnection under FXO: current loss, tone detection, and silence detection. Disconnection can be triggered by more than one of the three criteria.
Current Loss	Y/N	Disconnection to be triggered by loss of current. That is, when Current Loss is enabled ("Y"), the MultiVOIP will hang up the call when it detects a loss of current initiated by the attached device.
FXO Current Detect Timer	integer values (in milliseconds)	The minimum time required for detecting the current loss signal on the FXO interface. In other words, this is the minimum length of time the current must be absent to validate 'current loss' as a disconnection criterion. Default = 500 ms.
Tone Detection	Y/N	Disconnection to be triggered by a tone sequence.

FXO Interface: Parameter Definitions (cont'd)																																
Field Name	Values	Description																														
FXO Disconnect On (cont'd)																																
Disconnect Tone Sequence	1 st tone pair + 2 nd tone pair	These are DTMF tone pairs. Values for first tone pair are: *, #, 0, 1-9, and A-D. Values for second tone pair are: none, 0, 1-9, A-D, *, and #. The tone pairs 1-9, 0, *, and # are the standard DTMF pairs found on phone sets. The tone pairs A-D are "extended DTMF" tones, which are used for various PBX functions.																														
	<table border="1"> <thead> <tr> <th colspan="5">DTMF Tone Pairs</th> </tr> <tr> <th></th> <th>1</th> <th>2</th> <th>3</th> <th>Low Tones</th> </tr> </thead> <tbody> <tr> <td></td> <td>4</td> <td>5</td> <td>6</td> <td>A 697Hz</td> </tr> <tr> <td></td> <td>7</td> <td>8</td> <td>9</td> <td>B 770Hz</td> </tr> <tr> <td></td> <td>*</td> <td>0</td> <td>#</td> <td>C 852Hz</td> </tr> <tr> <td>High Tones</td> <td>1209Hz</td> <td>1336Hz</td> <td>1447Hz</td> <td>D 941Hz</td> </tr> </tbody> </table>		DTMF Tone Pairs						1	2	3	Low Tones		4	5	6	A 697Hz		7	8	9	B 770Hz		*	0	#	C 852Hz	High Tones	1209Hz	1336Hz	1447Hz	D 941Hz
DTMF Tone Pairs																																
	1	2	3	Low Tones																												
	4	5	6	A 697Hz																												
	7	8	9	B 770Hz																												
	*	0	#	C 852Hz																												
High Tones	1209Hz	1336Hz	1447Hz	D 941Hz																												
Silence Detection	One-Way or Two-Way	Disconnection to be triggered by silence in one direction only or in both directions simultaneously.																														
Silence Timer in seconds	integer value	Duration of silence required to trigger disconnection.																														
Disconnect on Call Progress Tone	Y/N	Allows call on FXO port to be disconnected when a PBX issues a call-progress tone denoting that the phone station on the PBX that has been involved in the call has been hung up.																														
Ring Count, FXO	integer value	Number of rings required before the MultiVOIP answers the incoming call.																														

E&M Parameters. The parameters applicable to the E&M telephony interface type are shown in the figure below and described in the table that follows.

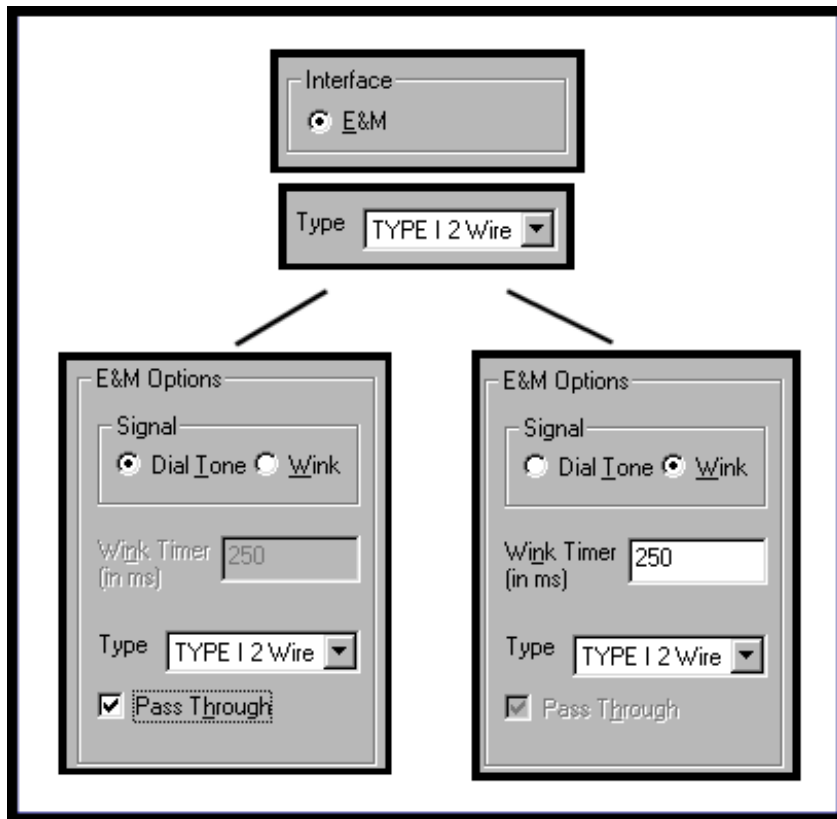

E&M Interface Parameter Definitions		
Field Name	Values	Description
Interface	E&M	enables E&M functionality
Type	Types 1-5. Each type can be 2-wire or 4-wire.	Refers to the type of E&M interface being used.
Signal	Dial Tone or Wink	When Dial Tone is selected, no wink is required on the E lead or M lead in the call initiation or setup. When Wink is selected, a wink is required during call setup.
Wink Timer (in ms)	integer values, in milliseconds	This is the length of the wink for wink signaling. Applicable only when Signal parameter is set to "Wink."
Pass Through	Y/N	When enabled ("Y"), this feature is used to create an open audio path for 2- or 4-wire. The E&M leads are actually unused. Applicable only for E&M Signaling with Dial Tone.

10. **Set SNMP Parameters** (Remote Voip Management). This dialog box can be reached by pulldown menu, keyboard shortcut, or sidebar. To make the MultiVOIP controllable by a remote PC running the MultiVoipManager software, check the “Enable SNMP Agent” box on the **SNMP Parameters** screen.

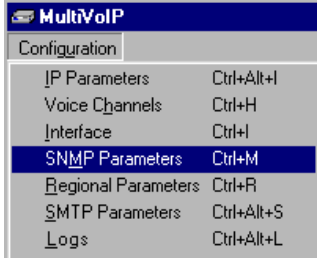
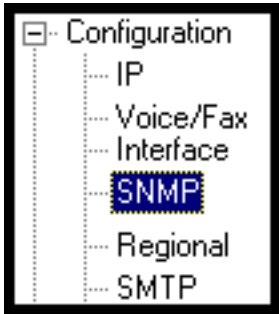
Accessing “SNMP Parameters”	
Pulldown	Icon
	
Shortcut	Sidebar
<p>Ctrl + M</p>	

In each field, enter the values that fit your particular system.

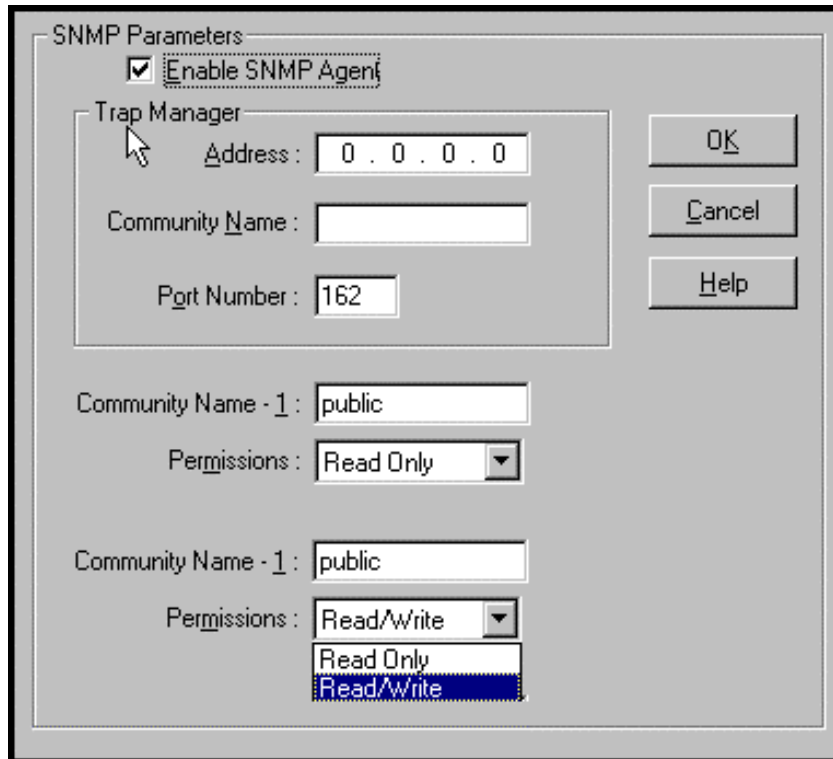

The image shows a configuration dialog box titled "SNMP Parameters". It contains the following elements:

- A checked checkbox labeled "Enable SNMP Agent".
- A sub-section titled "Trap Manager" containing:
 - An "Address" field with the value "0 . 0 . 0 . 0".
 - A "Community Name" field (empty).
 - A "Port Number" field with the value "162".
- Two "Community Name" fields, both containing the value "public".
- A "Permissions" dropdown menu for the first community, currently set to "Read Only".
- A "Permissions" dropdown menu for the second community, currently set to "Read/Write". A list of options is visible below the dropdown, including "Read Only" and "Read/Write".
- Three buttons on the right side: "OK", "Cancel", and "Help".

The SNMP Parameter fields are described in the table below.

SNMP Parameter Definitions		
Field Name	Values	Description
Enable SNMP Agent	Y/N	Enables the SNMP code in the firmware of the MultiVOIP. This must be enabled for the MultiVOIP to communicate with and be controllable by the MultiVoipManager software. Default: disabled
Trap Manager Parameters		
Address	4 places; n.n.n.n n = 0-255	IP address of MultiVoipManager PC.
Community Name	--	A "community" is a group of VOIP endpoints that can communicate with each other. Often "public" is used to designate a grouping where all end users have access to entire VOIP network. However, calling permissions can be configured to restrict access as needed.
Port Number	162	The default port number of the SNMP manager receiving the traps is the standard port 162.
Community Name 1	Length = 19 characters (max.) Case sensitive.	First community grouping.
Permissions	Read-Only, Read/Write	If this community needs to change MultiVOIP settings, select Read/Write. Otherwise, select Read-Only to view settings.
Community Name 2	Length = 19 characters (max.) Case sensitive.	Second community grouping
Permissions	Read-Only, Read/Write	If this community needs to change MultiVOIP settings, select Read/Write. Otherwise, select Read-Only to view settings.

11. Set Regional Parameters (Phone Signaling Tones & Cadences).

This dialog box can be reached by pulldown menu, keyboard shortcut, or sidebar.

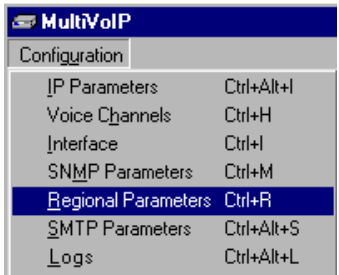
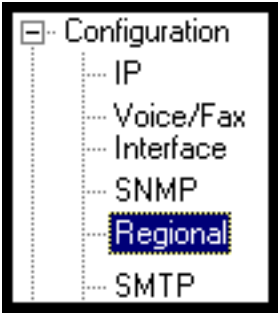
Accessing "Regional Parameters"	
Pulldown	Icon
	
Shortcut	Sidebar
<p>Ctrl + R</p>	

The **Regional Parameters** screen will appear. For the country selected, the standard set of frequency pairs will be listed for dial tone, busy tone, 'unobtainable' tone (fast busy or trunk busy), and ring tone.

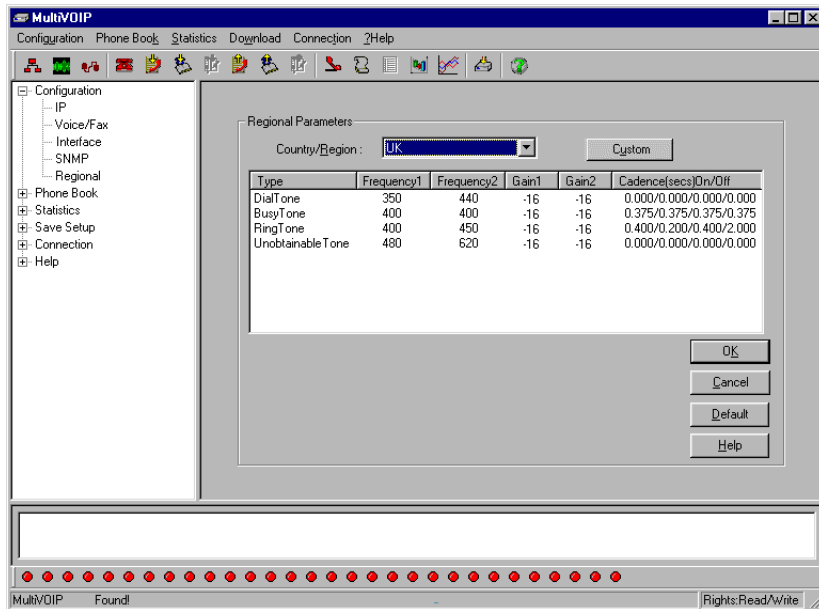

In each field, enter the values that fit your particular system.

The **Regional Parameters** fields are described in the table below.

“Regional Parameter” Definitions		
Field Name	Values	Description
Country/ Region	USA, Japan, UK, Custom	Name of a country or region that uses a certain set of tone pairs for dial tone, ring tone, busy tone, and ‘unobtainable’ tone (fast busy tone). In some cases, the tone-pair scheme denoted by a country name may also be used outside of that country. The “Custom” option (button) assures that any tone-pairing scheme worldwide can be accommodated.
Type column	dial tone, ring tone, busy tone, unobtainable tone (fast busy)	Type of telephony tone-pair for which frequency, gain, and cadence are being presented.
Frequency 1	frequency in Hertz	Lower frequency of pair.
Frequency 2	frequency in Hertz	Higher frequency of pair.
Gain 1	gain in dB +3dB to -31dB and “mute” setting	Amplification factor of lower frequency of pair. This applies to the dial, ring, busy and ‘unobtainable’ tones that the MultiVOIP outputs as audio to the eFXS, FXS, or E&M port. Default: -16dB
Gain 2	gain in dB +3dB to -31dB and “mute” setting	Amplification factor of higher frequency of pair. This applies to the dial, ring, busy, and ‘unobtainable’ (fast busy) tones that the MultiVOIP outputs as audio to the FXS, FXO, or E&M port. Default: -16dB

"Regional Parameter" Definitions (cont'd)		
Field Name	Values	Description
Cadence (msec) On/Off	n/n/n/n four integer time values in milli-seconds; zero value for dial-tone indicates continuous tone	On/off pattern of tone durations used to denote phone ringing, phone busy, connection unobtainable (fast busy), and dial tone ("0" indicates continuous tone). Default values differ for different countries/regions. Although most cadences have only two parts (an "on" duration and an "off" duration), some telephony cadences have four parts. Most cadences, then, are expressed as two iterations of a two-part sequence. Although this is redundant, it is necessary to allow for expression of 4-part cadences.
Pulse Generation Ratio	pair of integer values in milliseconds; 60/40 or 67/33	Ratio of "make" duration versus "break" duration when a tone pulse is generated. 60/40 applies to US telephony; 67/33 applies internationally (note, however, that US telephony standards are used in certain regions/nations outside the US).
Custom (button)	--	Click on the "Custom" button to bring up the Custom Tone Pair Settings screen. (The "Custom" button is active only when "Custom" is selected in the Country/Region field.) This screen allows the user to specify tone pair attributes that are not found in any of the standard national/regional telephony toning schemes.

12. **Set Custom Tones and Cadences** (optional). . The **Regional Parameters** dialog box has a secondary dialog box that allows you to customize DTMF tone pairs to create unique ring-tones/dial-tones, busy-tones or “unobtainable” tones (fast busy signal) for your system. This screen allows the user to specify tone-pair attributes that are not found in any of the standard national/regional telephony toning schemes. To access this customization feature, click on the **Custom** button on the **Regional Parameters** screen. (The “Custom” button is active only when “Custom” is selected in the **Country/Region** field.)

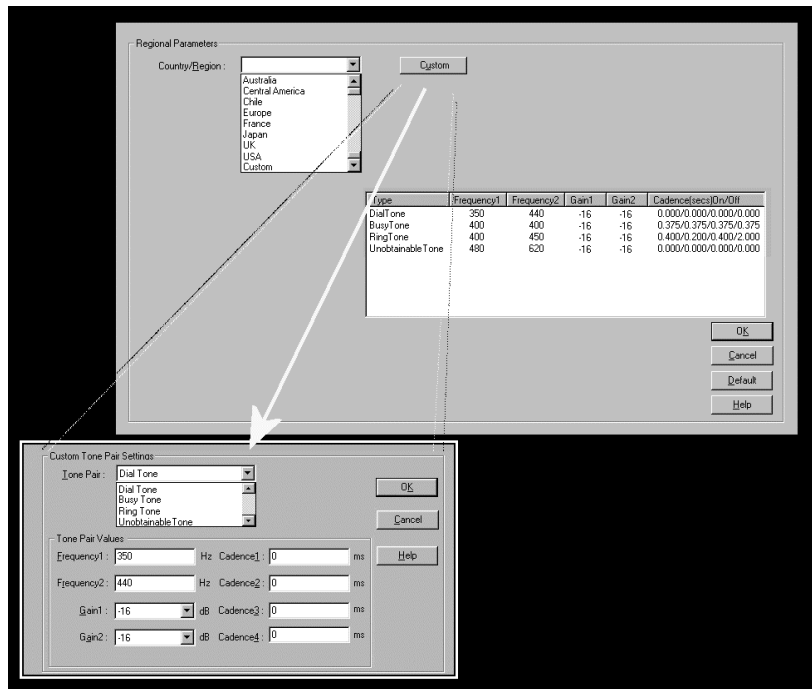

The **Custom Tone-Pair Settings** fields are described in the table below.

Custom Tone-Pair Settings Definitions		
Field Name	Values	Description
Tone Pair	dial tone, busy tone, ring tone, 'unobtainable' tone	Identifies the type of telephony signaling tone for which frequencies are being specified.
TONE PAIR VALUES		About Defaults: US telephony values are used as defaults on this screen. However, since this dialog box is provided to allow custom tone-pair settings, default values are essentially irrelevant.
Frequency 1	frequency in Hertz	Frequency of lower tone of pair. This outbound tone pair enters the MultiVOIP at the input port.
Frequency 2	frequency in Hertz	Frequency of higher tone of pair. This outbound tone pair enters the MultiVOIP at the input port.
Gain 1	gain in dB +3dB to -31dB and "mute" setting	Amplification factor of lower frequency of pair. This figure describes amplification that the MultiVOIP applies to outbound tones entering the MultiVOIP at the input port. Default = -16dB
Gain 2	gain in dB +3dB to -31dB and "mute" setting	Amplification factor of higher frequency of pair. This figure describes amplification that the MultiVOIP applies to outbound tones entering the MultiVOIP at the input port. Default = -16dB

Custom Tone-Pair Settings Definitions		
Field Name	Values	Description
Cadence 1	integer time value in milli-seconds; zero value for dial-tone indicates continuous tone	On/off pattern of tone durations used to denote phone ringing, phone busy, and dial tone ("0" indicates continuous tone). Cadence 1 is duration of first period of tone being "on" in the cadence of the telephony signal (which could be ring-tone, busy-tone, unobtainable-tone, or dial-tone).
Cadence 2	duration in milliseconds	Cadence 2 is duration of first "off" period in signaling cadence.
Cadence 3	duration in milliseconds	Cadence 3 is duration of second "on" period in signaling cadence.
Cadence 4	duration in milliseconds	Cadence 4 is duration of second "off" period in the signaling cadence, after which the 4-part cadence pattern of the telephony signal repeats.

13. **Set SMTP Parameters** (Log Reports by Email). The **SMTP Parameters** screen is applicable when the VOIP administrator has chosen to receive log reports by email (this is done by selecting the “SMTP” checkbox in the **Others** screen and selecting “Enable SMTP” in the **SMTP Parameters** screen.). The **SMTP Parameters** screen can be reached by pulldown menu, keyboard shortcut, or sidebar.

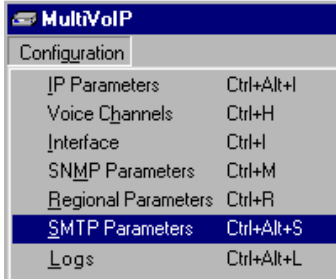
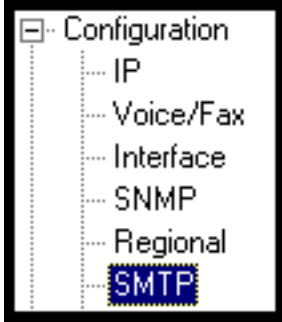
Accessing “SMTP Parameters”	
Pulldown	Icon
	
Shortcut	Sidebar
<p>Ctrl + Alt + S</p>	

MultiVOIP as Email Sender. When SMTP is used, the MultiVOIP will actually be given its own email account (with Login Name and Password) on some mail server connected to the IP network. Using this account, the MultiVOIP will then send out email messages containing log report information. The “Recipient” of the log report email is ordinarily the VoIP administrator. Because the MultiVOIP cannot receive email, a “Reply-To” address must also be set up. Ordinarily, the “Reply-To” address is that of a technician who has access to the mail server or MultiVOIP or both, and the VoIP administrator might also be designated as the “Reply-To” party. The main function of the Reply-To address is to receive error or failure messages regarding the emailed reports.

The SMTP Parameters screen is shown below . .

"SMTP Parameters" Definitions		
Field Name	Values	Description
Enable SMTP	Y/N	In order to send log reports by email, this box must be checked. However, to enable SMTP functionality, you must also select "SMTP" in the Logs screen.
Login Name	alpha-numeric, per email domain	This is the User Name for the MultiVOIP unit's email account.
Password	alpha-numeric	Login password for MultiVOIP unit's email account.
Mail Server IP Address	n.n.n.n for n= 0 to 255	This is the mail server's IP address. This mail server must be accessible on the IP network to which the MultiVOIP is connected.
Port Number	25	25 is a standard port number for SMTP.

.....

“SMTP Parameters” Definitions (cont’d)		
Field Name	Values	Description
Mail Type	text or html	Mail type in which log reports will be sent.
Subject	text	User specified. Subject line that will appear for all emailed log reports for this MultiVOIP unit.
Reply-To Address	email address	User specified. This email address functions as a source email identifier for the MultiVOIP, which, of course, cannot usefully receive email messages. The Reply-To address provides a destination for returned messages indicating the status of messages sent by the MultiVOIP (esp. to indicate when log report email was undeliverable or when an error has occurred).
Recipient Address	email address	User specified. Email address at which VOIP administrator will receive log reports.
Mail Criteria		Criteria for sending log summary by email. The log summary email will be sent out either when the user-specified number of log messages has accumulated, or once every day or multiple days, <i>which ever comes first</i> .
Number of Records	integer	This is the number of log records that must accumulate to trigger the sending of a log-summary email.
Number of Days	integer	This is the number of days that must pass before triggering the sending of a log-summary email.

The **SMTP Parameters** dialog box has a secondary dialog box, **Custom Fields**, that allows you to customize email log messages for the MultiVOIP. The MultiVOIP software logs data about many aspects of the call traffic going through the MultiVOIP. The Custom Fields screen lets you pick which aspects will be included in the email log reports.

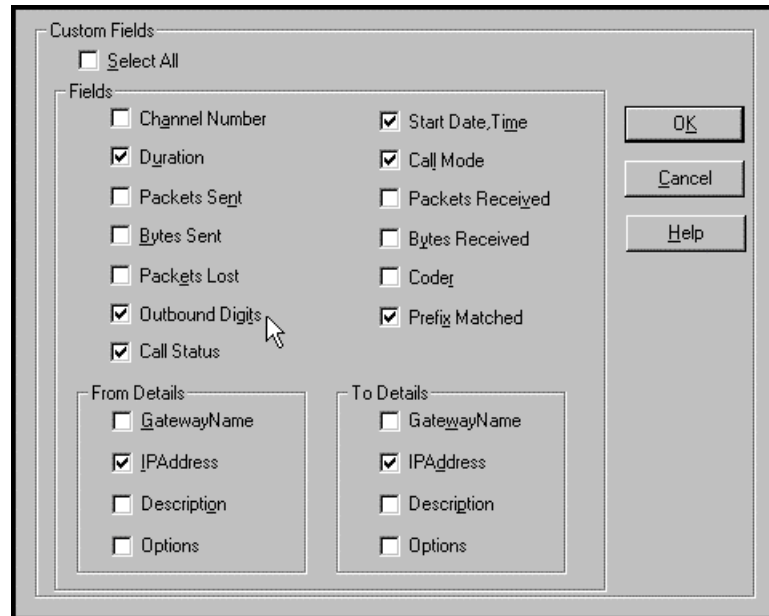

"Custom Fields" Definitions			
Field	Description	Field	Description
Select All	Log report to include all fields shown.		
Channel Number	Data channel carrying call.	Start Date, Time	Date and time the phone call began.
Duration	Length of call.	Call Mode	Voice or fax.
Packets Sent	Total packets sent in call.	Packets Received	Total packets received in call.
Bytes Sent	Total bytes sent in call.	Bytes Received	Total bytes received in call.
Packets Lost	Packets lost in call.	Coder	Voice Coder /Compression Rate used for call will be listed in log.

“Custom Fields” Definitions (cont’d)			
Field	Description	Field	Description
Outbound Digits	Digits put out by MultiVOIP onto the phone line.	Prefix Matched	When selected, the phonebook prefix matched in processing the call will be listed in log.
Call Status	Successful or unsuccessful.		
From Details		To Details	
Gateway Number	Originating gateway	Gatew N.	Completing or answering gateway
IP Addr	IP address where call originated.	IP Addr	IP address where call was completed or answered.
Descript	Identifier of site where call originated.	Descript	Identifier of site where call was completed or answered.
Options	When selected, log will not use/non-use of Silence Compression and Forward Error Correction by call originator.	Options	When selected, log will not use/non-use of Silence Compression and Forward Error Correction by party answering call.

SMTP

To use the "SMTP Parameters" screen, SMTP must first be selected in the "Logs" screen.

The secondary screen "Custom Fields" lets the user determine which technical details of each phone call to record in the logs.

Email reports can be sent out periodically or when a certain number of phone calls have been logged.

The requested technical details will then appear in the log report that is automatically emailed to the VoIP administrator.

Call Logs

Sl.No.	Start Date & Time	Duration	Status	Call Mode
1	01/17/2002 & 09:43:24	00:01:47	Success	Voice
2	01/17/2002 & 10:30:33	00:26:46	Success	Voice
3	01/17/2002 & 11:05:22	00:09:47	Success	Voice
4	01/17/2002 & 11:16:02	00:01:25	Success	Voice
5	01/17/2002 & 11:21:02	00:00:33	Success	Voice
6	01/17/2002 & 11:51:26	00:00:00	Unsuccess	Voice

Call Logs

Sl.No.	From IP Addr.	To IP Addr.	OutBound Digits	Prefix Matched
1	204.026.122.105	202.054.039.100		4470
2	204.026.122.105	202.054.039.100		4470
3	204.026.122.105	202.054.039.100		4470
4	202.054.039.100	204.026.122.105		763717
5	204.026.122.105	202.054.039.100		4470
6	204.026.122.105	202.054.039.100		4470

14. Set Log Reporting Method. The **Logs** screen lets you choose how the VoIP administrator will receive log reports about the MultiVOIP's performance and the phone call traffic that is passing through it. Log reports can be received in one of three ways:

- A. in the MultiVOIP program (GUI),
- B. via email (SMTP), or
- C. at the MultiVoipManager remote voip system management program (SNMP).

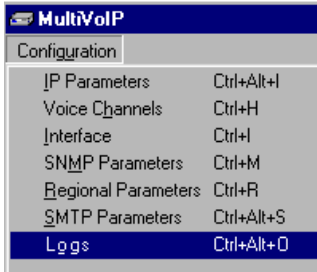
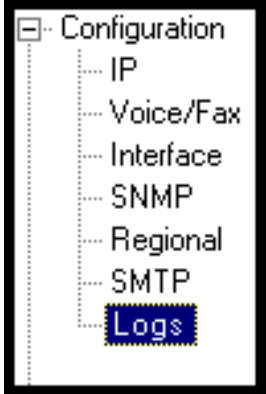
Accessing "Logs" Screen	
Pulldown	Icon
	
Shortcut	Sidebar
<p>Ctrl + Alt + O</p>	

Select the logging option that applies to your VoIP system design. If you intend to use a SysLog Server program for logging, click in that Enable check box. The common SysLog logical port number is 514. If you intend to use the MultiVOIP web browser GUI for configuration and control of MultiVOIP units, be aware that the web browser GUI does not support logs directly. However, when the web browser GUI is used, log files can still be sent to the voip administrator via email (which requires activating the SMTP logging option in this screen).

The screenshot shows a configuration window titled "Logs" with the following elements:

- Enable Console Messages
- Turn Off Logs
- GUI
- SMTP
- SNMP
- Enable (under SysLog Server)
- IP Address : [. . .]
- Port : [514]
- Online Statistics Updation Interval [5] Sec

Buttons on the right side include OK, Cancel, and Help.

“Logs” Screen Definitions		
Field Name	Values	Description
Enable Console Messages	Y/N	Allows MultiVOIP debugging messages to be read via a basic terminal program like HyperTerminal™ or equivalent. Normally, this should be disabled because it uses MultiVOIP processing resources. Console messages are meant for tech support personnel.
Turn Off Logs	Y/N	Check to disable log reporting function.
Logs Buttons		Only one of these three log reporting methods, GUI, SMTP, or SNMP, may be chosen.
GUI	Y/N	User must view logs at the MultiVOIP configuration program.
SNMP	Y/N	Log messages will be delivered to the MultiVoipManager application program.
SMTP	Y/N	Log messages will be sent to user-specified email address.
SysLog Server Enable	Y/N	This box must be checked if logging is to be done in conjunction with a SysLog Server program. For more on SysLog Server, see <i>Operation & Maintenance</i> chapter.
IP Address	n.n.n.n for n= 0-255	IP address of computer, connected to voip network, on which SysLog Server program is running.
Port	514	Logical port for SysLog Server. 514 is commonly used.
Online Statistics Updation Interval	integer	Set the interval (in seconds) at which logging information will be updated.

15. **Set Supplementary Services Parameters.** This dialog box can be reached by pulldown menu, keyboard shortcut, or sidebar.

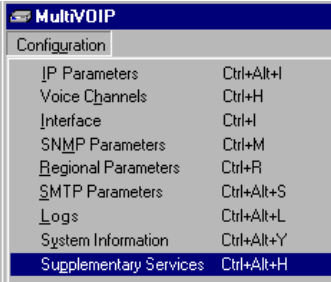
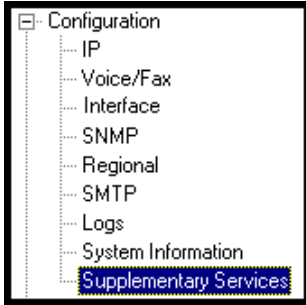
Accessing "Supplementary Services" Parameters	
Pulldown	Icon
	
Shortcut	Sidebar
<p>Ctrl + Alt + H</p>	

Supplementary Services features derive from the H.450 standard, which brings to voip telephony functionality once only available with PSTN or PBX telephony. Supplementary Services features can be used under H.323 only and *not* under SIP.

In each field, enter the values that fit your particular network.

The screenshot shows a configuration window titled "Supplementary Services Parameters". At the top, there is a "Select Channel" dropdown menu set to "Channel 1". Below this are four main sections, each with an "Enable" checkbox and a sequence field:

- Call Transfer:** The "Enable" checkbox is checked. The "Transfer Sequence" field contains "#*1".
- Call Hold:** The "Enable" checkbox is checked. The "Hold Sequence" field contains "#*2".
- Call Waiting:** The "Enable" checkbox is checked. The "Retrieve Sequence" field contains "#*3".
- Call Name Identification:** The "Enable" checkbox is checked. Below it is an "Allowed Name Type" section with four unchecked checkboxes: "Calling Party", "Busy Party", "Alerting Party", and "Connected Party". Below that is a "Caller Id" text field.

At the bottom right of the window, there are four buttons: "OK", "Default", "Cancel", and "Copy Channel".

Of the features implemented under Supplementary Services, three are very closely related: Call Transfer, Call Hold, and Call Waiting. Call Name Identification is similar but not identical to the premium PSTN feature commonly known as **Caller ID**.

Call Transfer. Call Transfer allows one party to re-connect the party with whom they have been speaking to a third party. The first party is disconnected when the third party becomes connected. Feature is invoked by a program-mable phone keypad sequence (for example, #7).

Call Hold. Call Hold allows one party to maintain an idle (non-talking) connection with another party while receiving another call (Call Waiting), while initiating another call (Call Transfer), or while performing some other call management function. Invoked by keypad sequence.

Call Waiting. Call Waiting notifies an engaged caller of an incoming call and allows them to receive a call from a third party while the party with whom they have been speaking is put on hold. Invoked by keypad sequence.

Call Name Identification. When enabled for a given voip unit (the 'home' voip), this feature gives notice to remote voips involved in calls. Notification goes to the remote voip administrator, not to individual phone stations. When the home voip is the caller, a plain English descriptor will be sent to the remote (callee) voip identifying

the channel over which the call is being originated (for example, “Calling Party - Omaha Sales Office Line 2”). If that voip channel is dedicated to a certain individual, the descriptor could say that, as well (for example “Calling Party - Harold Smith in Omaha”). When the home voip receives a call from any remote voip, the home voip sends a status message back to that caller. This message confirms that the home voip’s phone channel is either busy or ringing or that a connection has been made (for example, “Busy Party - Omaha Sales Office Line 2”). These messages appear in the **Statistics - Call Progress** screen of the remote voip.

Note that Supplementary Services parameters are applied on a channel-by-channel basis. However, once you have established a set of Supplementary parameters for a particular channel, you can apply this entire set of parameters to another channel by using the **Copy Channel** button and its dialog box. To copy a set of Supplementary Services parameters to all channels, select “Copy to All” and click **Copy**.

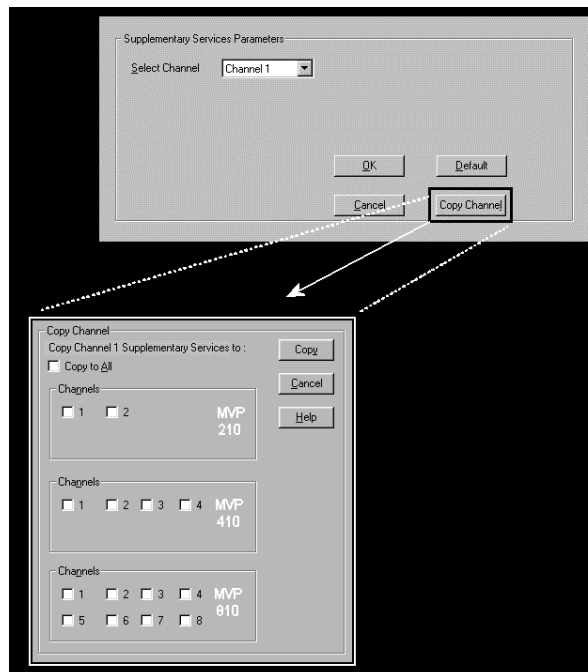

The **Supplementary Services** fields are described in the tables below.

Supplementary Services Parameter Definitions		
Field Name	Values	Description
Select Channel	1-2 (210); 1-4 (410); 1-8 (810)	The channel to be configured is selected here.
Call Transfer Enable	Y/N	Select to enable the Call Transfer function in the voip unit. This is a “blind” transfer and the sequence of events is as follows: Callers A and B are having a conversation. Caller A wants to put B into contact with C. Caller A dials call transfer sequence. Caller A hears dial tone and dials number for caller C. Caller A gets disconnected while Caller B gets connected to caller C.
Transfer Sequence	any phone keypad character	The numbers and/or symbols that the caller must press on the phone keypad to initiate a call transfer. The call-transfer sequence can be 1 to 4 characters in length using any combination of digits or characters (* or #). The sequences for call transfer, call hold, and call waiting can be from 1 to 4 digits in length consisting of any combination of digits 1234567890*#.

Supplementary Services Definitions (cont'd)		
Field Name	Values	Description
Call Hold Enable	Y/N	Select to enable Call Hold function in voip unit. Call Hold allows one party to maintain an idle (non-talking) connection with another party while receiving another call (Call Waiting), while initiating another call (Call Transfer), or while performing some other call management function.
Hold Sequence	phone keypad characters	The numbers and/or symbols that the caller must press on the phone keypad to initiate a call hold. The call-hold sequence can be 1 to 4 characters in length using any combination of digits or characters (* or #).
Call Waiting Enable	Y/N	Select to enable Call Waiting function in voip unit.
Retrieve Sequence	phone keypad characters, two characters in length	The numbers and/or symbols that the caller must press on the phone keypad to initiate retrieval of a waiting call. The call-waiting retrieval sequence can be 1 to 4 characters in length using any combination of digits or characters (* or #). This is the phone keypad sequence that a user must press to retrieve a waiting call. Customize-able. Sequence should be distinct from sequence that might be used to retrieve a waiting call via the PBX or PSTN.

Supplementary Services Definitions (cont'd)		
Field Name	Values	Description
Call Name Identification Enable		<p>Enables CNI function. Call Name Identification is not the same as Caller ID. When enabled on a given voip unit currently being controlled by the MultiVOIP GUI (the 'home voip'), Call Name Identification sends an identifier and status information to the administrator of the remote voip involved in the call. The feature operates on a channel-by-channel basis (each channel can have a separate identifier).</p> <p>If the home voip is originating the call, only the Calling Party field is applicable. If the home voip is receiving the call, then the Alerting Party, Busy Party, and Connected Party fields are the only applicable fields (and any or all of these could be enabled for a given voip channel). The status information confirms back to the originator that the callee (the home voip) is either busy, or ringing, or that the intended call has been completed and is currently connected.</p> <p>The identifier and status information are made available to the remote voip unit and appear in the Caller ID field of its Statistics - Call Progress screen. (This is how MultiVOIP units handle CNI messages; in other voip brands, H.450 may be implemented differently and then the message presentation may vary.)</p>

Supplementary Services Definitions (cont'd)		
Field Name	Values	Description
Calling Party, Allowed Name Type (CNI)		<p>If the 'home' voip unit is originating the call and Calling Party is selected, then the identifier (from the Caller Id field) will be sent to the remote voip unit being called. The Caller Id field gives the remote voip administrator a plain-language identifier of the party that is originating the call occurring on a specific channel.</p> <p>This field is applicable only when the 'home' voip unit is originating the call.</p> <p>Example. Suppose a voip system has offices in both Denver and Omaha. In the Omaha voip unit (the 'home' voip in this example), Call Name Identification has been enabled, Calling Party has been enabled as an Allowed Name Type, and "Omaha Sales Office Voipchannel 2" has been entered in the Caller Id field.</p> <p>When channel 2 of the Omaha voip is used to make a call to any other voip phone station (for example, the Denver office), the message "Calling Party - Omaha Sales Office Voipchannel 2" will appear in the "Caller Id" field of the Statistics - Call Progress screen of the Denver voip.</p>

Supplementary Services Definitions (cont'd)		
Field Name	Values	Description
Alerting Party, Allowed Name Type (CNI)		<p>If the 'home' voip unit is receiving the call and Alerting Party is selected, then the identifier (from the Caller Id field) will tell the originating remote voip unit that the call is ringing.</p> <p>This field is applicable only when the 'home' voip unit is receiving the call.</p> <p>Example. Suppose a voip system has offices in both Denver and Omaha. In the Omaha voip unit (the 'home' voip unit in this example), Call Name Identification has been enabled, Alerting Party has been enabled as an Allowed Name Type, and "Omaha Sales Office Voipchannel 2" has been entered in the Caller Id field of the Supplementary Services screen.</p> <p>When channel 2 of the Omaha voip receives a call from any other voip phone station (for example, the Denver office), the message "Alerting Party - Omaha Sales Office Voipchannel 2" will be sent back and will appear in the Caller Id field of the Statistics - Call Progress screen of the Denver voip. This confirms to the Denver voip that the phone is ringing in Omaha.</p>

Supplementary Services Definitions (cont'd)		
Field Name	Values	Description
Busy Party, Allowed Name Type (CNI)		<p>If the 'home' voip unit is receiving a call directed toward an already engaged channel or phone station and Busy Party is selected, then the identifier (from the Caller Id field) will tell the originating remote voip unit that the channel or called party is busy.</p> <p>This field is applicable only when the 'home' voip unit is receiving the call.</p> <p>Example. Suppose a voip system has offices in both Denver and Omaha. In the Omaha voip unit (the 'home' voip unit in this example), Call Name Identification has been enabled, Busy Party has been enabled as an Allowed Name Type, and "Omaha Sales Office Voipchannel 2" has been entered in the Caller Id field of the Supplementary Services screen.</p> <p>When channel 2 of the Omaha voip is busy but still receives a call attempt from any other voip phone station (for example, the Denver office), the message "Busy Party - Omaha Sales Office Voipchannel 2" will be sent back and will appear in the Caller Id field of the Statistics - Call Progress screen of the Denver voip. This confirms to the Denver voip that the channel or phone station is busy in Omaha.</p>

Supplementary Services Definitions (cont'd)		
Field Name	Values	Description
Connected Party, Allowed Name Type (CNI)		<p>If the 'home' voip unit is receiving a call and Connected Party is selected, then the identifier (from the Caller Id field) will tell the originating remote voip unit that the attempted call has been completed and the connection is made.</p> <p>This field is applicable only when the 'home' voip unit is receiving the call.</p> <p>Example. Suppose a voip system has offices in both Denver and Omaha. In the Omaha voip unit (the 'home' voip unit in this example), Call Name Identification has been enabled, Connected Party has been enabled as an Allowed Name Type, and "Omaha Sales Office Voipchannel 2" has been entered in the Caller Id field of the Supplementary Services screen.</p> <p>When channel 2 of the Omaha voip completes an attempted call from any other voip phone station (for example, the Denver office), the message "Connect Party - Omaha Sales Office Voipchannel 2" will be sent back and will appear in the Caller Id field of the Statistics - Call Progress screen of the Denver voip. This confirms to the Denver voip that the call has been completed to Omaha.</p>

Supplementary Services Definitions (cont'd)		
Field Name	Values	Description
Caller ID		This is the identifier of a specific channel of the 'home' voip unit. The Caller Id field typically describes a person, office, or location, for example, "Harry Smith," or "Bursar's Office," or "Barnesville Factory."
Default	--	When this button is clicked, all Supplementary Service parameters are set to their default values.
Copy Channel	--	Copies the Supplementary Service attributes of one channel to another channel. Attributes can be copied to multiple channels or all channels at once.

16. **Set Baud Rate.** The **Connection** option in the sidebar menu has a “Settings” item that includes the baud-rate setting for the COM port of the computer running the MultiVOIP software.

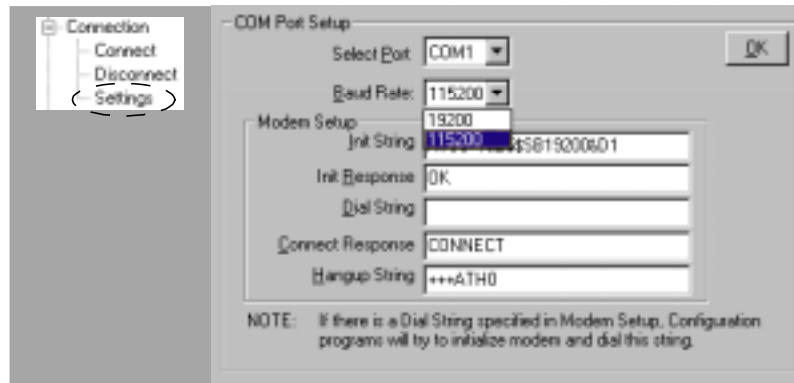

First, it is important to note that the default COM port established by the MultiVOIP program is COM1. **Do not accept the default value until you have checked the COM port allocation on your PC.** To do this, check for COM port assignments in the system resource dialog box(es) of your Windows operating system. If COM1 is not available, you must change the COM port setting to COM2 or some other COM port that you have confirmed as being available on your PC.

The default baud rate is 115,200 bps.

17. View **System Information** screen and set updating interval (optional).

This dialog box can be reached by pulldown menu, keyboard shortcut, or sidebar.

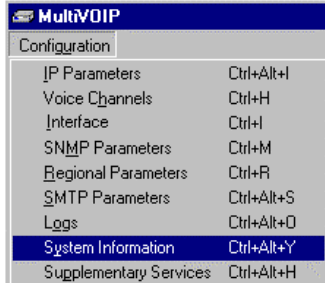
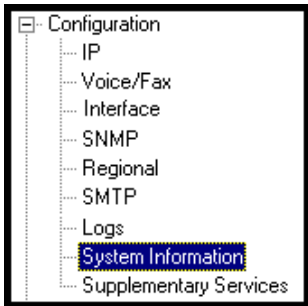
Accessing "System Information" Screen	
Pulldown	Icon
	
Shortcut	Sidebar
<p>Ctrl + Alt + Y</p>	

This screen presents vital system information at a glance. It's primary use is in troubleshooting.

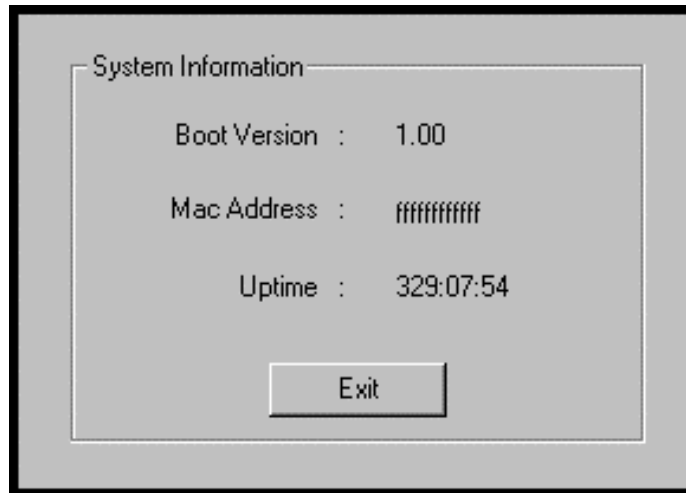

System Information Parameter Definitions		
Field Name	Values	Description
Boot Code Version	nn.nn	Indicates the version of the code that is used at the startup (booting) of the voip. The boot code version is independent of the software version.
Mac Address	alpha-numeric	Denotes the number assigned as the voip unit's unique Ethernet address.
Up Time	hours: mm:ss	Indicates how long the voip has been running since its last booting.

The frequency with which the System Information screen is updated is determined by a setting in the Logs screen

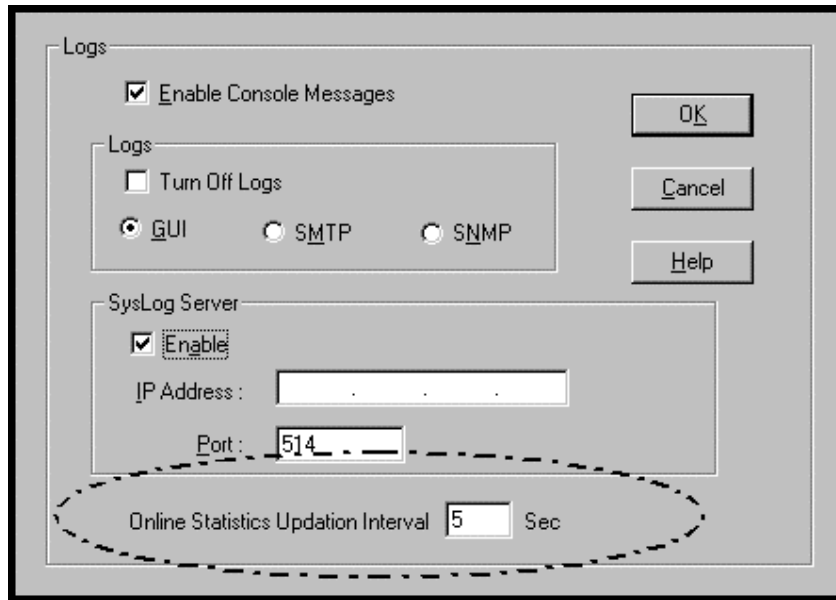

18. Saving the MultiVOIP Configuration. When values have been set for all of the MultiVOIP's various operating parameters, click on **Save Setup** in the sidebar.

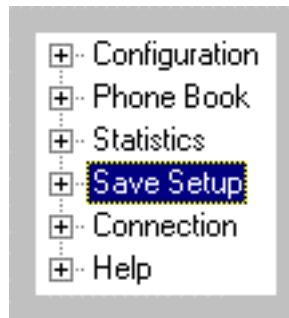

19. **Creating a User Default Configuration.** When a “Setup” (complete grouping of parameters) is being saved, you will be prompted about designating that setup as a “User Default” setup. A User Default setup may be useful as a baseline of site-specific values to which you can easily revert. Establishing a User Default Setup is optional.

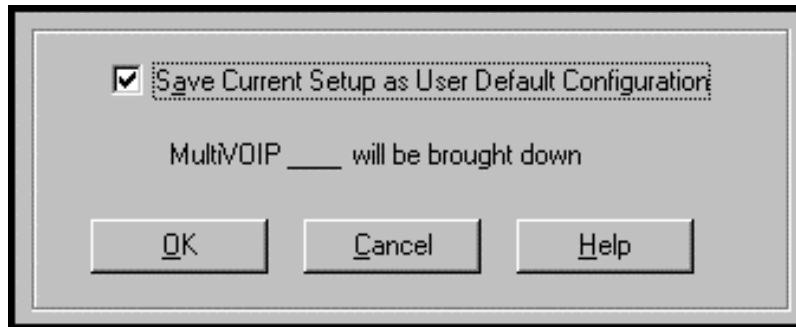

Chapter 7: T1 Phonebook Configuration

(North American Telephony Standards)

Configuring the MVP2400/2410 MultiVOIP Phonebooks

When a VoIP serves a PBX system, it's important that the operation of the VoIP be transparent to the telephone end user. That is, the VoIP should not entail the dialing of extra digits to reach users elsewhere on the network that the VoIP serves. On the contrary, VOIP service more commonly reduces dialed digits by allowing users (served by PBXs in facilities in distant cities) to dial their co-workers with 3-, 4-, or 5-digit extensions as if they were in the same facility.

Furthermore, the setup of the VoIP generally should allow users to make calls on a non-toll basis to any numbers accessible without toll by users at all other locations on the VoIP system. Consider, for example, a company with VOIP-equipped offices in New York, Miami, and Los Angeles, each served by its own PBX. When the VOIP phone books are set correctly, personnel in the Miami office should be able to make calls without toll not only to the company's offices in New York and Los Angeles, but also to any number that's local in those two cities.

To achieve transparency of the VoIP telephony system and to give full access to all types of non-toll calls made possible by the VOIP system, the VoIP administrator must properly configure the "Outbound" and "Inbound" phone-books of each VoIP in the system.

The "Outbound" phonebook for a particular VoIP unit describes the dialing sequences required for a call to originate locally (typically in a PBX in a particular facility) and reach any of its possible destinations at remote VoIP sites, including non-toll calls completed in the PSTN at the remote site.

The "Inbound" phonebook for a particular VoIP unit describes the dialing sequences required for a call to originate remotely from any other VOIP sites in the system, and to terminate on that particular VOIP.

Briefly stated, *the MultiVOIP's Outbound phonebook lists the phone stations it can call; its Inbound phonebook describes the dialing sequences that can be used to call that MultiVOIP and how those calls will be directed.* (Of course, the phone numbers are not literally "listed" individually, but are, instead, described by rule.)

Consider two types of calls in the three-city system described above: (1) calls originating from the Miami office and terminating in the New York (Manhattan) office, and (2) calls originating from the Miami office







and terminating in New York City but off the company's premises in an adjacent area code, an area code different than the company's office but still a local call from that office (e.g., Staten Island).

The first type of call requires an entry in the Outbound PhoneBook of the Miami VOIP and a coordinated entry in the Inbound phonebook of the New York VOIP. These entries would allow the Miami caller to dial the New York office as if its phones were extensions on the Miami PBX.

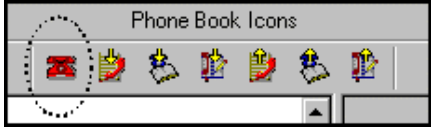
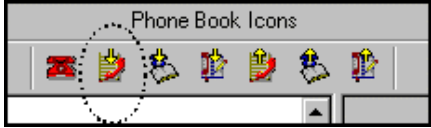
The second type of call similarly requires an entry in the Outbound PhoneBook of the Miami VOIP and a coordinated entry in the Inbound Phonebook of the New York VOIP. However, these entries will be longer and more complicated. Any Miami call to New York City local numbers will be sent through the VOIP system rather than through the regular toll public phone system (PSTN). But the phonebook entries can be arranged so that the VOIP system is transparent to the Miami user, such that even though that Miami user dials the New York City local number just as they would through the public phone system, that call will still be completed through the VOIP system.

This PhoneBook Configuration procedure is brief, but it is followed by an example case. For many people, the example case may be easier to grasp than the procedure steps. Configuration is not difficult, but all phone number sequences and other information must be entered exactly; otherwise connections will not be made.

Phonebook configuration screens can be accessed using icons or the sidebar menu.

Phonebook Icons	Description
 <p>The image shows a horizontal menu titled "Phone Book Icons" containing seven icons. The first icon, which is a red telephone handset, is circled with a dashed line.</p>	Phonebook Configuration
 <p>The image shows a horizontal menu titled "Phone Book Icons" containing seven icons. The second icon, which is a red telephone handset with a speech bubble, is circled with a dashed line.</p>	Inbound Phonebook Entries List
 <p>The image shows a horizontal menu titled "Phone Book Icons" containing seven icons. The third icon, which is a blue telephone handset with a plus sign, is circled with a dashed line.</p>	Add Inbound Phonebook Entry
 <p>The image shows a horizontal menu titled "Phone Book Icons" containing seven icons. The fourth icon, which is a blue telephone handset with a minus sign, is circled with a dashed line.</p>	Edit selected Inbound Phonebook Entry
 <p>The image shows a horizontal menu titled "Phone Book Icons" containing seven icons. The fifth icon, which is a red telephone handset with a speech bubble, is circled with a dashed line.</p>	Outbound Phonebook Entries List
 <p>The image shows a horizontal menu titled "Phone Book Icons" containing seven icons. The sixth icon, which is a blue telephone handset with a plus sign, is circled with a dashed line.</p>	Add Outbound Phonebook Entry
 <p>The image shows a horizontal menu titled "Phone Book Icons" containing seven icons. The seventh icon, which is a blue telephone handset with a minus sign, is circled with a dashed line.</p>	Edit selected Outbound Phonebook Entry

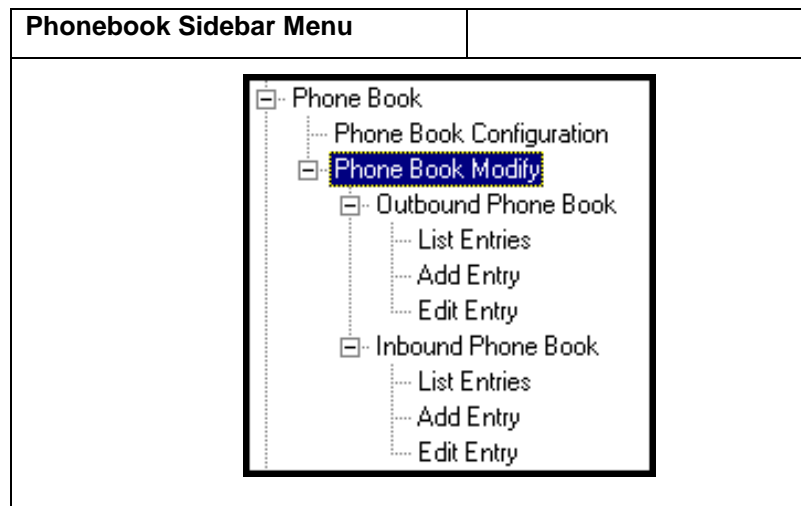

1. Go to the **PhoneBook Configuration** screen (using either the sidebar or drop-down menu).

The screenshot shows the "Phone Book Configuration" dialog box. It contains the following fields and options:

- Gateway Name: MultiVolIP
- Q.931 Parameters:
 - Use Fast Start
 - Call Signaling Port: 1720
- Register with GateKeeper
- Gatekeeper RAS Parameters:
 - Gatekeeper/Clear Channel IP Address: 192 . 168 . 3 . 1
 - Port Number: 1719
 - Gateway Prefix: 65
 - Gatekeeper Name: [Empty]
 - Gateway H323 ID: [Empty]
- Enable Proxy
- Proxy Parameters:
 - Proxy Server IP Address: 0 . 0 . 0 . 0
 - Port Number: 0
- H323 Version 4 Options:
 - Q.931 Multiplexing [Mux] H.245 Tunneling [Tun]
 - Parallel H.245 [FS+Tun] Annex - E [AE]

Buttons: OK, Cancel, Help

In consultation with your VOIP administrator, enter the Gateway Name and values for Q.931 parameters and Gatekeeper RAS parameters. Determine whether your voip system will operate with a proxy server. Determine which H.323 version 4 functions you will implement. (They are not always applicable. See field description for each parameter.)

The table below describes all fields in the **PhoneBook Configuration** screen.

PhoneBook Configuration Parameter Definitions		
Field Name	Values	Description
Gateway Name	Y/N	This field allows you to specify a name for this MultiVOIP. When placing a call, this name is sent to the remote MultiVOIP for display in Call Progress listings, Logs, etc.
Q.931 Parameters		
Use Fast Start	Y/N	Enables the H.323 Fast Start procedure. May need to be enabled/disabled for compatibility with third-party VOIP gateways.
Call Signalling Port	port number	Default: 1720 (H.323)
GateKeeper RAS Parameters		
IP Address		IP address of the GateKeeper.
Port Number		Well-known port number for GateKeepers. Must match port number of GateKeeper, 1719.
Gateway Prefix		This number becomes registered with the GateKeeper. Call requests sent to the gatekeeper and preceded by this prefix will be routed to the VOIP gateway.
Gatekeeper Name	<i>alpha-numeric string</i>	Optional. The name of the GateKeeper with which this MultiVOIP is trying to register.
H.323 ID		The H.323 ID is used to register this particular MultiVOIP with the GateKeeper.

PhoneBook Configuration Parameter Definitions (cont'd)		
Field Name	Values	Description
Proxy Server Parameters		
Enable Proxy	Y/N	Allows the MultiVOIP to work in conjunction with a proxy server.
Proxy Server IP Address	n.n.n.n where n=0-255	Network address of the proxy server that the voip is using.
Port Number		Logical port number for proxy communications.
H.323 Version 4 Parameters		
Q.931 Multiplexing (Mux)	Y/N	Signalling for multiple phone calls can be carried on a single port rather than opening a separate signalling port for each call. This conserves bandwidth resources.
H.245 Tunneling (Tun)	Y/N	H.245 messages are encapsulated within the Q.931 call signalling channel. Among other things, the H.245 messages let the two endpoints tell each other what their technical capabilities are and determine who, during the call, will be the client and who the server. Tunneling is the process of transmitting these H.245 messages through the Q.931 channel. The same TCP/IP socket (or logical port) already being used for the Call Signalling Channel is then also used by the H.245 Control Channel. This encapsulation reduces the number of logical ports (sockets) needed and reduces call setup time.

PhoneBook Configuration Parameter Definitions (cont'd)		
Field Name	Values	Description
H.323 Version 4 Parameters		
Parallel H.245 (FS + Tun)	Y/N	FS (Fast Start or Fast Connect) is a Q.931 feature of H.323v2 to hasten call setup as well as 'pre-opening' the media channel before the CONNECT message is sent. This pre-opening is a requirement for certain billing activities. Under Parallel H.245 FS + Tun, this Fast Connect feature can operate simultaneously with H.245 Tunneling (see description above).
Annex -E (AE)	Y/N	Multiplexed UDP call signalling transport. Annex E is helpful for high-volume voip system endpoints. Gateways with lesser volume can afford to use TCP to establish calls. However, for larger volume endpoints, the call setup times and system resource usage under TCP can become problematic. Annex E allows endpoints to perform call signalling functions under the UDP protocol, which involves substantially streamlined overhead. (This feature should not be used on the public Internet because of potential problems with security and bandwidth usage.)

2. Select **PhoneBook Modify** and then select **Outbound Phone Book/List Entries**.

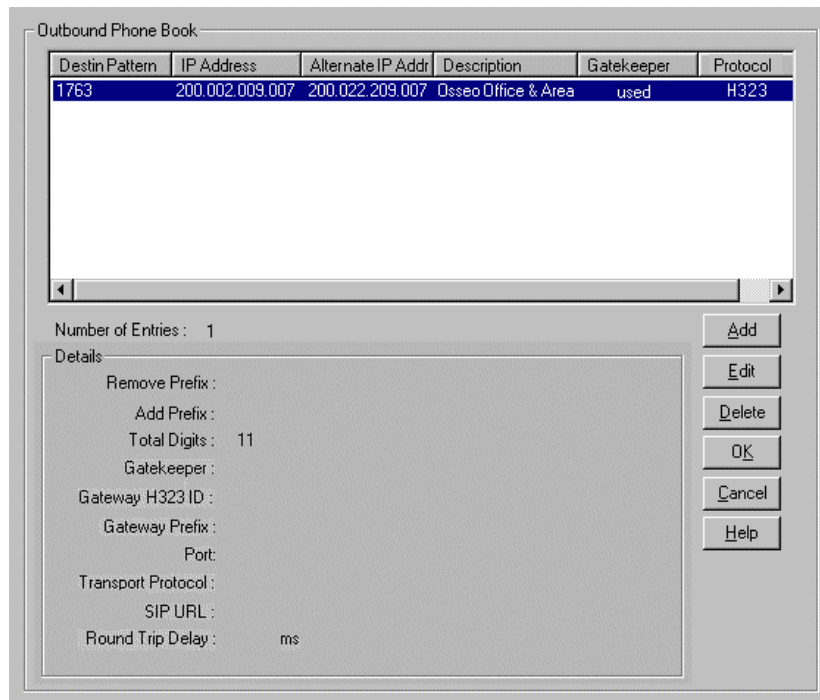

Click **Add**.

3. The **Add/Edit Outbound PhoneBook** screen appears.

The screenshot displays the MultiVOIP 2400 configuration software. The left sidebar shows a tree view with 'Phone Book' expanded to 'Outbound Phone Book', where 'Add Entry' is selected. The main window is titled 'Add/Edit Outbound Phone Book' and contains the following fields and controls:

- Phone Number Details:**
 - Destination Pattern: [Text Field]
 - Total Digits: [0] [Spin Box]
 - Remove Prefix: [Text Field]
 - Add Prefix: [Text Field]
- Buttons: OK, Cancel, Help, Advanced
- IP Address: [Text Field]
- Description: [Text Field]
- Protocol Type: SIP, H.323
- H.323 Section:**
 - Use Gatekeeper
 - Gateway H323 ID: [Text Field]
 - Gateway Prefix: [Text Field]
 - Q.931 Port Number: [1720] [Spin Box]
- SIP Section:**
 - Use Proxy
 - Transport Protocol: TCP, UDP
 - SIP Port Number: [5060] [Spin Box]
 - SIP URL: [Text Field]

Enter Outbound PhoneBook data for your MVP2400/2410. Note that the Advanced button gives access to the Alternate IP Routing feature, if needed. Alternate IP Routing can be implemented in a secondary screen (as described after the primary screen field definitions below).

The fields of the **Add/Edit Outbound Phone Book** screen are described in the table below.

Add/Edit Outbound Phone Book: Field Definitions		
Field Name	Values	Description
Destination Pattern	prefixes, area codes, exchanges, line numbers, extensions	Defines the beginning of dialing sequences for calls that will be connected to another VOIP in the system. Numbers beginning with these sequences are diverted from the PTSN and carried on Internet or other IP network.
Total Digits	as needed	number of digits the phone user must dial to reach specified destination
Remove Prefix	dialed digits	portion of dialed number to be removed before completing call to destination
Add Prefix	dialed digits	digits to be added before completing call to destination
IP Address	n.n.n.n for n = 0-255	the IP address to which the call will be directed if it begins with the destination pattern given
Description	alpha-numeric	Describes the facility or geographical location at which the call will be completed.
Protocol Type	SIP or H.323	Indicates protocol to be used in outbound transmission.

Add/Edit Outbound Phone Book: Field Definitions (cont'd)		
Field Name	Values	Description
H.323 fields		
Use Gatekeepr	Y/N	Indicates whether or not gatekeeper is used.
H.323 ID		The H.323 ID assigned to the destination MultiVOIP. Only valid if "Use Gatekeeper" is enabled for this entry.
Gateway Prefix		This number becomes registered with the GateKeeper. Call requests sent to the gatekeeper and preceded by this prefix will be routed to the VOIP gateway.
Q.931 Port Number	1720	Q.931 is the call signalling protocol for setup and termination of calls (aka ITU-T Recommendation I.451). H.323 employs only one "well-known" port (1720) for Q.931 signalling. If Q.931 message-oriented signalling protocol is used, the port number 1720 must be chosen.

Add/Edit Outbound Phone Book: Field Definitions (cont'd)		
Field Name	Values	Description
SIP Fields		
Use Proxy	Y/N	Select if proxy server is used.
Transport Protocol	TCP or UDP	Voip administrator must choose between UDP and TCP transmission protocols. UDP is a high-speed, low-overhead connectionless protocol where data is transmitted without acknowledgment, guaranteed delivery, or guaranteed packet sequence integrity. TCP is slower connection-oriented protocol with greater overhead, but having acknowledgment and guarantees delivery and packet sequence integrity.
SIP Port Number	5060 or other *See RFC3087 ("Control of Service Context using SIP Request-URI," by the Network Working Group).	The SIP Port Number is a UDP logical port number. The voip will "listen" for SIP messages at this logical port. If SIP is used, 5060 is the default, standard, or "well known" port number to be used. If 5060 is not used, then the port number used is that specified in the SIP Request URI (Universal Resource Identifier).
SIP URL	<i>sip.userphone</i> @ <i>hostserver</i> , where "userphone" is the telephone number and "hostserver" is the domain name or an address on the network	Looking similar to an email address, a SIP URL identifies a user's address. In SIP communications, each caller or callee is identified by a SIP url: sip:user_name@host_name. The format of a sip url is very similar to an email address, except that the "sip:" prefix is used.

Advanced button	--	Gives access to secondary screen where an Alternate IP Route can be specified for backup or redundancy of signal paths. See discussion on next page.
---------------------------	----	--

Clicking on the **Advanced** button brings up the **Alternate Routing** secondary screen. This feature provides an alternate path for calls if the primary IP network cannot carry the traffic. Often in cases of failure, call traffic is temporarily diverted into the PSTN. However, this feature could also be used to divert traffic to a redundant (backup) unit in case one voip unit fails. The user must specify the IP address of the alternate route for each destination pattern entry in the Outbound Phonebook.

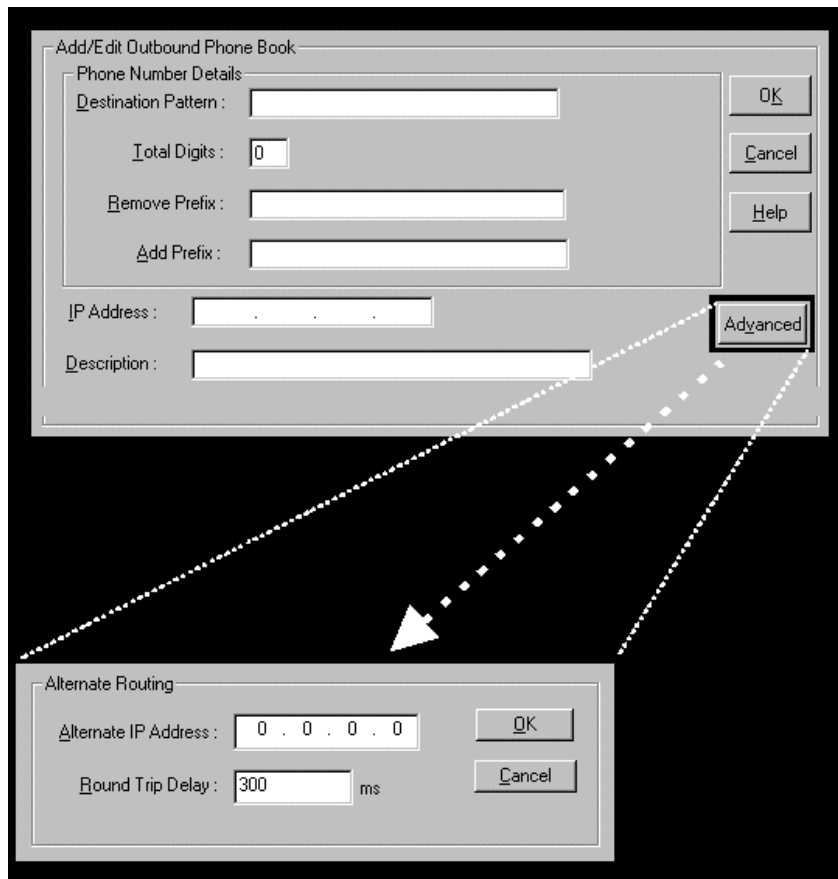

Alternate Routing Field Definitions		
Field Name	Values	Description
Alternate IP Address	n.n.n.n where n= 0-255	Alternate destination for outbound data traffic in case of excessive delay in data transmission.
Round Trip Delay	milliseconds	The Round Trip Delay is the criterion for judging when a data pathway is considered blocked. When the delay exceeds the threshold specified here, the data stream will be diverted to the alternate destination specified as the Alternate IP Address.

4. Select PhoneBook Modify and then select Inbound PhoneBook/List Entries.

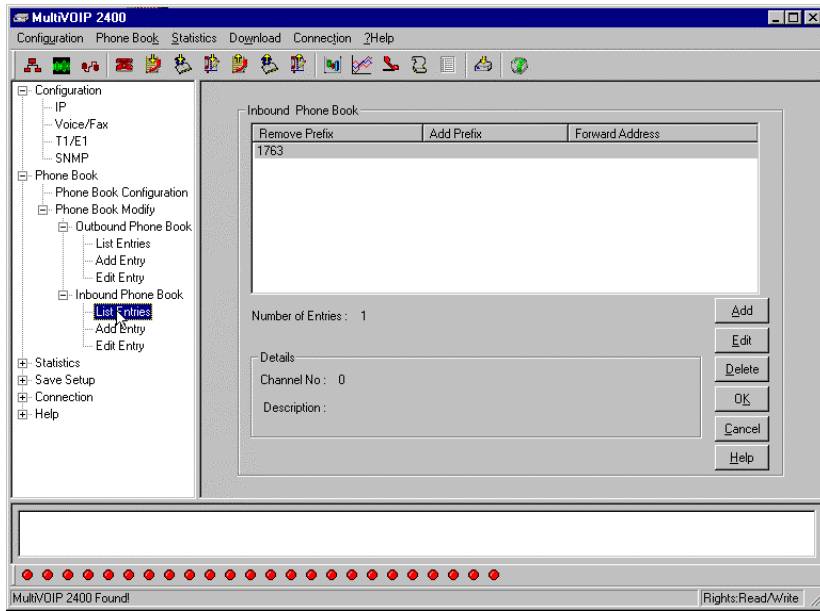

5. The **Add/Edit Inbound PhoneBook** screen appears.

Enter Inbound PhoneBook data for your MultiVOIP. The fields of the Add/Edit Inbound PhoneBook screen are described in the table below.

Add/Edit Inbound Phone Book: Field Definitions		
Field Name	Values	Description
Remove Prefix	dialed digits	portion of dialed number to be removed before completing call to destination (often a local PBX)
Add Prefix	dialed digits	digits to be added before completing call to destination (often a local PBX)
Channel Number	1-24, or "Hunting"	T1 channel number to which the call will be assigned as it enters the local telephony equipment (often a local PBX). "Hunting" directs the call to any available channel.

Add/Edit Inbound Phone Book: Field Definitions (cont'd)		
Field Name	Values	Description
Description	--	Describes the facility or geographical location at which the call originated.
Call Forward Parameters		
Enable	Y/N	Click the check-box to enable the call-forwarding feature.
Forward Condition	Uncondit.; Busy No Resp.	Unconditional. When selected, all calls received will be forwarded. Busy. When selected, calls will be forwarded when station is busy. No Response. When selected, calls will be forwarded if called party does not answer after a specified number of rings, as specified in Ring Count field.
Forward Address/ Number	IP addr. or phone number	Phone number or IP address to which calls will be directed.
Ring Count	integer	When No Response is condition for forwarding calls, this determines how many unanswered rings are needed to trigger the forwarding.

6. When your Outbound and Inbound PhoneBook entries are completed, click on **Save Setup** in the sidebar menu to save your configuration.

You can change your configuration at any time as needed for your system.

Remember that the initial MVP2400/2410 setup must be done locally using the MultiVOIP program. However, after the initial configuration is complete, all of the MVP2400/2410 units in the VOIP system can be configured, re-configured, and updated from one location using the MultiVoipManager software program.

T1 Phonebook Examples

The following example demonstrates how Outbound and Inbound PhoneBook entries work in a situation of multiple area codes. Consider a company with offices in Minneapolis and Baltimore.

3 Sites, All-T1 Example

Notice first the area code situation in those two cities: Minneapolis's local calling area consists of multiple adjacent area codes; Baltimore's local calling area consists of a base area code plus an overlay area code.

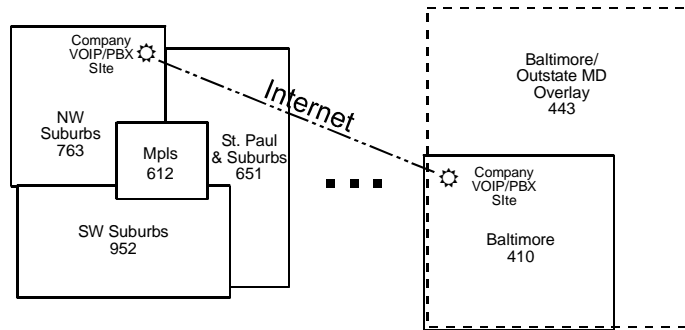

An outline of the equipment setup in both offices is shown below.

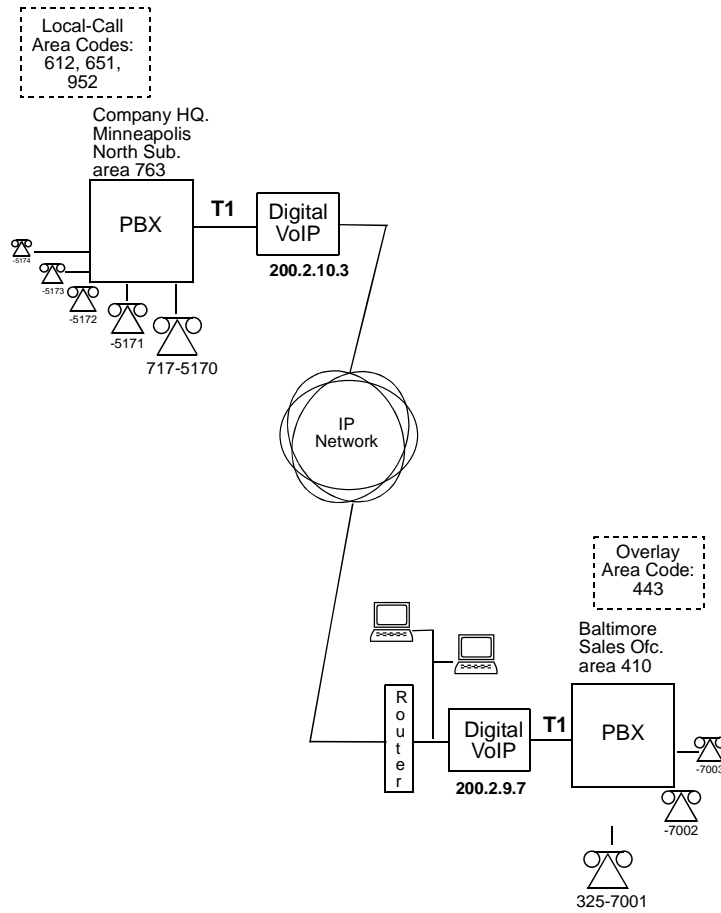

The screen below shows Outbound PhoneBook entries for the VOIP located in the company's Baltimore facility.

Outbound PhoneBook **{ Baltimore voip unit }**

Dest Pattern	IP Address	Description
1612	200.002.010.003	Minneapolis
1651	200.002.010.003	St Paul
1763	200.002.010.003	Minneapolis, N Suburbs
1952	200.002.010.003	Minneapolis, S Suburbs

Number of Entries : 4

Details:

H.323 ID :

Remove Prefix :

Add Prefix :

Total Digits : 11

Add Edit Delete Cancel

The entries in the Minneapolis VOIP's Inbound PhoneBook match the Outbound PhoneBook entries of the Baltimore VOIP, as shown below.

Inbound PhoneBook **{ Minneapolis voip unit }**

Plans Prefix	Add Prefix
1612	9.612
1651	9.651
1763	9.
17637175	9
1952	9.952

Number of Entries : 5

Details:

Channel No : 0

Description : localcalls to Minneapolis (city)

Add Edit Delete Cancel

To call the Minneapolis/St. Paul area, a Baltimore employee must dial eleven digits. (In this case, we are assuming that the Baltimore PBX does not require an “8” or “9” to seize an outside phone line.)

If a Baltimore employee dials any phone number in the 612 area code, the call will automatically be handled by the company’s voip system. Upon receiving such a call, the Minneapolis voip will remove the digits “1612”. But before the suburban-Minneapolis voip can complete the call to the PSTN of the Minneapolis local calling area, it must dial “9” (to get an outside line from the PBX) and then a comma (which denotes a pause to get a PSTN dial tone) and then the 10-digit phone number which includes the area code (612 for the city of Minneapolis; which is different than the area code of the suburb where the PBX is actually located -- 763).

A similar sequence of events occurs when the Baltimore employee calls number in the 651 and 952 area codes because number in both of these area codes are local calls in the Minneapolis/St. Paul area.

The simplest case is a cal from Baltimore to a phone within the Minneapolis/St. Paul area code where the company’s voip and PBX are located, namely 763. In that case, that local voip removes 1763 and dials 9 to direct the call to its local 7-digit PSTN.

Finally, consider the longest entry in the Minneapolis Inbound Phonebook, “17637175. Note that the main phone number of the Minneapolis PBX is 763-717-5170. The destination pattern 17637175 means that all calls to Minneapolis employees will stay within the suburban Minneapolis PBX and will not reach or be carried on the local PSTN.

Similarly, the Inbound PhoneBook for the Baltimore VOIP (shown first below) generally matches the Outbound PhoneBook of the Minneapolis VOIP (shown second below).

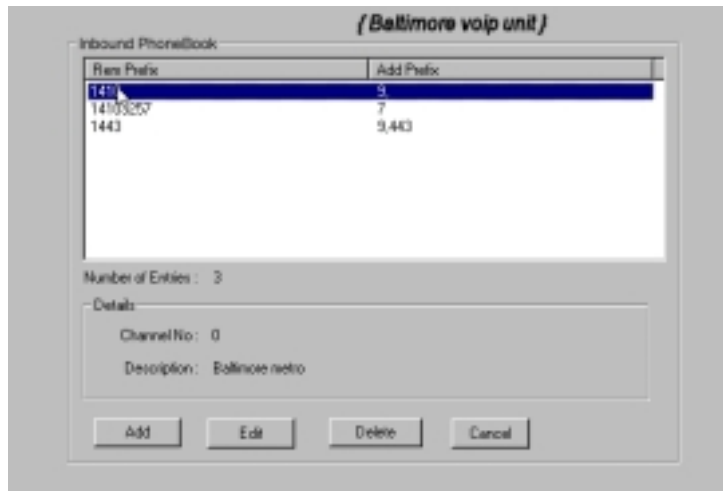

Notice the extended prefix to be removed: 14103257. This entry allows Minneapolis users to contact Baltimore co-workers as though they were in the Minneapolis facility, using numbers in the range 7000 to 7999.

Note also that a comma (as in the entry 9,443) denotes a delay in dialing. A one-second delay is commonly used to allow a second dial-tone to be generated for calls going outside of the facility's PBX system.

The Outbound PhoneBook for the Minneapolis VOIP is shown below. The third destination pattern, "7" facilitates reception of co-worker calls using local-appearing-extensions only. In this case, the "Add Prefix" field value for this phonebook entry would be "1410325" .

Outbound PhoneBook (Minneapolis voip unit)

Dest Pattern	IP Address	Description
1410	200.002.003.007	Saltmore
1443	200.002.003.007	Saltmore overlay
7	200.002.003.007	Saltmore Office Extensions

Number of Entries : 3

Details:

H.323 ID :

Remove Prefix :

Add Prefix :

Total Digits : 11

Add

Edit

Delete

Cancel

Configuring Mixed Digital/Analog VOIP Systems

The MVP2400/2410 digital MultiVOIP unit is compatible with analog VOIPs. In many cases, digital and analog VOIP units will appear in the same telephony/IP system. In addition to MVP-210/410/810 MultiVOIP units (Series II units), legacy analog VOIP units (Series I units made by MultiTech) may be included in the system, as well. When legacy VOIP units are included, the VOIP administrator must handle two styles of phonebooks in the same VOIP network. The diagram below shows a small-scale system of this kind: one digital VOIP (the MVP2400) operates with two Series II analog VOIPs (an MVP210 and an MVP410), and two Series I legacy VOIPs (two MVP200 units).

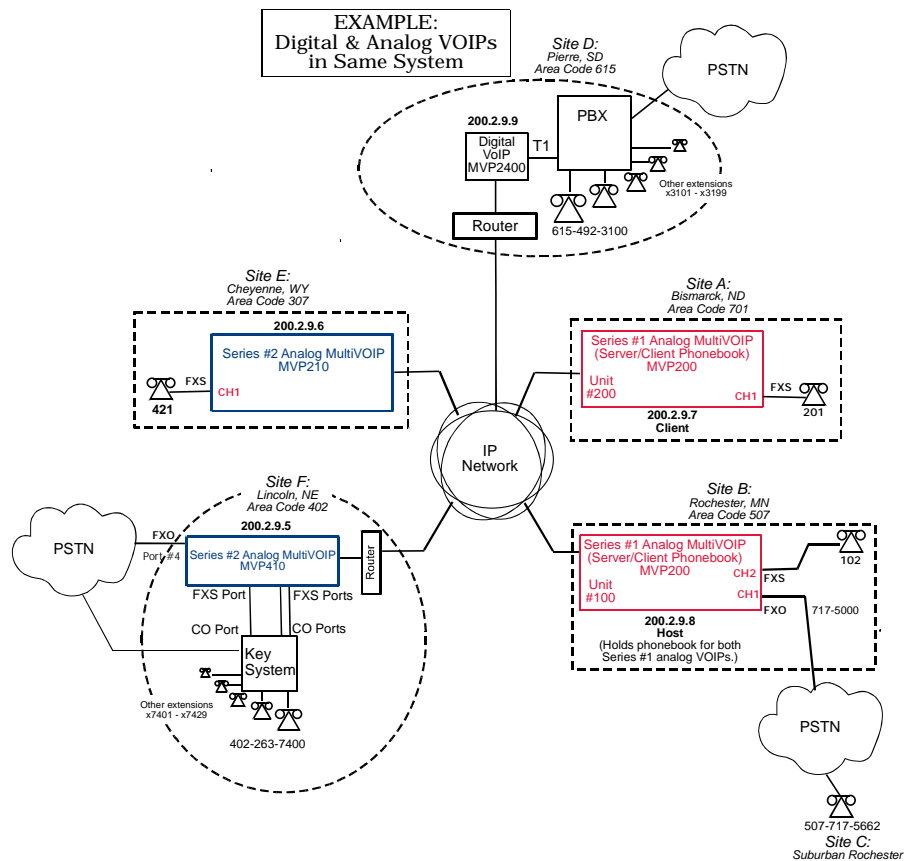

The Series I analog VOIP phone book resides in the “Host” VOIP unit at Site B. It applies to both of the Series I analog VOIP units.

Each of the Series II analog MultiVOIPs (the MVP210 and the MVP410) requires its own inbound and outbound phonebooks. The MVP2410 digital MultiVOIP requires its own inbound and outbound phonebooks, as well.

These seven phone books are shown below.

Phone Book for Series I Analog VOIP Host Unit (Site B)			
VOIP Dir # -OR- Destination Pattern	IP Address	Channel	Comments
102	200.2.9.8	2	Site B, FXS channel.
101	200.2.9.8	1	Site B, FXO channel.
421	200.2.9.6	0	Site E FXS channel.
201	200.2.9.7	1	Site A, FXS channel.
1615 xxx xxxx	200.2.9.9	0 (Note 2.)	Gives remote voip users access to local PSTN of Site D (Pierre, SD, area code 615).
3xxx (Note 1.)	200.2.9.9	0	Allows remote voip users to call all PBX extensions at Site D (Pierre, SD) using only four digits.
1402	200.2.9.5	0	Gives remote voip users access to local PSTN of Site F (Lincoln, NE; area code 402).
140226374 (Note 1) (Note 3)	200.2.9.5	0	Gives remote voip users access to key phone system extensions at Site F (Lincoln).

Note 1. The “x” is a wildcard character.

Note 2. By specifying “Channel 0,” we instruct the MVP2400/2410 to choose any available data channel to carry the call.

Note 3. Note that Site F key system has only 30 extensions (x7400-7429). This destination pattern (140226374) actually directs calls to 402-263-7430 through 402-263-7499 into the key system, as well. This means that such calls, which belong on the PSTN, cannot be completed. In some cases, this might be inconsequential because an entire exchange (fully used or not) might have been reserved for the company or it might be unnecessary to reach those numbers. However, to specify only the 30 lines actually used by the key system, the destination pattern 140226374 would have to be replaced by three other destination patterns, namely 1402263740, 1402263741, and 1402263742. In this way, calls to 402-263-7430 through 402-263-7499 would be properly directed to the PSTN. In the Site D outbound phonebook, the 30 lines are defined exactly, that is, without making any adjacent phone numbers unreachable through the voip system.

Outbound Phone Book for MVP2400 Digital VOIP (Site D)				
Destin. Pattern	Remove Prefix	Add Prefix	IP Address	Comment
201			200.2.9.7	To originate calls to Site A (Bismarck).
1507	1507	101# Note 3.	200.2.9.8	To originate calls to Rochester local PSTN using the FXO channel (channel #1) of the Site B VOIP.
102			200.2.9.8	To originate calls to phone connected to FXS port (channel #2) of the Site B VOIP.
421			200.2.9.6	Calls to Site E (Cheyenne).
1402			200.2.9.5	Calls to Lincoln area local PSTN (via FXO channel, CH4, of the Site F VOIP).
1402 263 740			200.2.9.5	Calls to extensions (thirty) of key system at Site F (Lincoln). Human operator or auto-attendant is needed to complete these calls.
1402 263 741			200.2.9.5	
1402 263 742			200.2.9.5	
Note 3. The pound sign (“#”) is a delimiter separating the VOIP number from the standard telephony phone number.				

Inbound Phonebook for MVP2400/2410 Digital VOIP (Site D)			
Remove Prefix	Add Prefix	Channel Number	Comment
1615	9, Note 4. Note 5.	0	Allows phone users at remote voip sites to call non-toll numbers within the Site D area code (615; Pierre, SD) over the VOIP network.
1615 49231	31	0	Allows voip calls directly to employees at Site D (at extensions x3101 to x3199).
<p>Note 4. "9" gives PBX station users access to outside line.</p> <p>Note 5. The comma represents a one-second pause, the time required for the user to receive a dial tone on the outside line (PSTN). The comma is only allowed in the Inbound phonebook.</p>			

Outbound Phone Book for MVP410 Analog VOIP (Site F)				
Destin. Pattern	Remove Prefix	Add Prefix	IP Address	Comment
201			200.2.9.7	To originate calls to Site A (Bismarck).
1507	1507	101# Note 3.	200.2.9.8	To originate calls to any PSTN phone in Rochester area using the FXO channel (channel #1) of the Site B VOIP.
102			200.2.9.8	To originate calls to phone connected to FXS port (channel #2) of the Site B VOIP (Rochester).
421			200.2.9.6	Calls to Site E (Cheyenne).
1615			200.2.9.9	Calls to Pierre area PSTN via Site D PBX.
31		1615 492	200.2.9.9	Calls to Pierre PBX extensions with four digits.
Note 3. The pound sign (“#”) is a delimiter separating the VOIP number from the standard telephony phone number.				

Inbound Phonebook for MVP410 Analog VOIP (Site F)			
Remove Prefix	Add Prefix	Channel Number	Comment
1402		4	Access to Lincoln local PSTN by users at remote VOIP locations via FXO port at Site F.
1402 263740	740	0	Gives remote voip users access to extension of key phone system at Site F (Lincoln). Because call is completed at key system, abbreviated dialing (4 digits) is not workable. Human operator or auto-attendant is needed to complete these calls.
1402 263741	741	0	
1402 263742	742	0	

Outbound Phone Book for MVP210 Analog VOIP (Site E)				
Destin. Pattern	Remove Prefix	Add Prefix	IP Address	Comment
201			200.2.9.7	To originate calls to Site A.
1507	1507	101# Note 3.	200.2.9.8	To originate calls to any PSTN phone in Rochester area using the FXO channel (channel #1) of the Site B VOIP.
102			200.2.9.8	To originate calls to phone connected to FXS port (channel #2) of the Site B VOIP.
1402			200.2.9.5	Calls to Lincoln area PSTN (via FXO channel, CH4, of the Site F VOIP).
7		1402 263	200.2.9.5	Calls to Lincoln key extensions with four digits.
1615			200.2.9.9	Calls to Pierre area PSTN via Site D PBX.
31		1615 492	200.2.9.9	Calls to Pierre PBX extensions with four digits.
Note 3. The pound sign (“#”) is a delimiter separating the VOIP number from the standard telephony phone number.				

Inbound Phonebook for MVP210 Analog VOIP (Site E)			
Remove Prefix	Add Prefix	Channel Number	Comment
421		1	

Call Completion Summaries

Site A calling Site C, Method 1

1. Dial 101.
2. Hear dial-tone from Site B.
3. Dial 7175662.
4. Await completion. Talk.

Site A calling Site C, Method 2

1. Dial 101#7175662
2. Await completion. Talk.

Note: Some analog VOIP gateways will allow completion by Method 2. Others will not.

Site C calling Site A

1. Dial 7175000.
2. Hear dial-tone from Site B VOIP.
3. Dial 201.
4. Await completion. Talk.

Site D calling Site C

1. Dial 9,15077175662.
2. “9” gets outside line. On some PBXs, an “8” may be used to direct calls to the VOIP, while “9” directs calls to the PSTN. However, some PBX units can be programmed to identify the destination patterns of all calls to be directed to the VOIP.
3. PBX at Site D is programmed to divert all calls made to the 507 area code and exchange 717 into the VOIP network. (It would also be possible to divert all calls to all phones in area code 507 into the VOIP network, but it may not be desirable to do so.)
4. The MVP2400/2410 removes the prefix “1507” and adds the prefix “101#” for compatibility with the analog MultiVOIP’s phonebook scheme. The “#” is a delimiter separating the analog VOIP’s phone number from the digits that the analog VOIP must dial onto its local PSTN to complete the call. The digits “101#7175662” are forwarded to the Site B analog VOIP.
5. The call passes through the IP network (in this case, the Internet).
6. The call arrives at the Site B VOIP. This analog VOIP receives this dialing string from the MVP2400/2410: 101#7175662. The analog VOIP, seeing the “101” prefix, uses its own channel #1 (an FXO port) to connect the call to the PSTN. Then the analog VOIP dials its local phone number 7175662 to complete the call.

Site D calling Site F

A voip call from Pierre PBX to extension 7424 on the key telephone system in Lincoln, Nebraska.

A. The required entry in the Pierre Outbound Phonebook to facilitate origination of the call, would be 1402263742. The call would be directed to the Lincoln voip's IP address, 200.2.9.5.

(Generally on such a call, the caller would have to dial an initial "9." But typically the PBX would not pass the initial "9" to the voip. If the PBX *did* pass along that "9" however, its removal would have to be specified in the local Outbound Phonebook.)

B. The corresponding entry in the Lincoln Inbound Phonebook to facilitate completion of the call would be

1402263742	for calls within the office at Lincoln
1402	for calls to the Lincoln local calling area (PSTN).

Call Event Sequence

1. Caller at Pierre dials 914022637424.
2. Pierre PBX removes "9" and passes 14022637424 to voip.
3. Pierre voip passes remaining string, 14022637424 on to the Lincoln voip at IP address 200.2.9.5.
4. The dialed string matches an inbound phonebook entry at the Lincoln voip, namely 1402263742.
5. The Lincoln voip rings one of the three FXS ports connected to the Lincoln key phone system.
6. The call will be routed to extension 7424 either by a human receptionist/
operator or to an auto-attendant (which allows the caller to specify the extension to which they wish to be connected).

Site F calling Site D

A voip call from a Lincoln key extension to extension 3117 on the PBX in Pierre, South Dakota.

A. The required entry in the Lincoln Outbound Phonebook to facilitate origination of the call, would be “31”. The string “1615492” would have to be added as a prefix. The call would be directed to the Pierre voip’s IP address, 200.2.9.9.

B. The corresponding entry in the Pierre Inbound Phonebook to facilitate completion of the call would be 1615492.

1. Caller at Lincoln picks up phone receiver, presses button on key phone set. This button has been assigned to a particular voip channel (any one of the three FXS ports).
2. The caller at Lincoln hears dial tone from the Lincoln voip.
3. The caller at Lincoln dials 3117.
4. The Lincoln voip adds the prefix 1615492 and sends the entire dialing string, 16154923117, to the Pierre voip at IP address 200.2.9.9.
5. The Pierre voip matches the called digits 16154923117 to its Inbound Phonebook entry “1615492” .
6. The Pierre PBX dials extension 3117 in the office at Pierre.

Variations in PBX Characteristics

The exact dialing strings needed in the Outbound and Inbound Phonebooks of the MVP2400/2410 will depend on the capabilities of the PBX. Some PBXs require trunk access codes (like an “8” or “9” to access an outside line or to access the VOIP network). Other PBXs can automatically distinguish between intra-PBX calls, PSTN calls, and VOIP calls.

Some PBX units can also insert digits automatically when they receive certain dialing strings from a phone station. For example, a PBX may be programmable to insert automatically the three-digit VOIP identifier strings into calls to be directed to analog VOIPs.

The MVP2400/2410 offers complete flexibility for inter-operation with PBX units so that a coherent dialing scheme can be established to connect a company’s multiple sites together in a way that is convenient and intuitive for phone users. When working together with modern PBX units, the presence of the MVP2400/2410 can be completely transparent to phone users within the company.

Chapter 8: E1 Phonebook Configuration

(European Telephony Standards)

MVP3010 Inbound and Outbound MultiVOIP Phonebooks

Important Definition:	The MultiVOIP's Outbound phonebook lists the phone stations it can call; its Inbound phonebook describes the dialing sequences that can be used to call that MultiVOIP and how those calls will be directed.
-----------------------	--

When a VOIP serves a PBX system, the operation of the VOIP should be transparent to the telephone end user and savings in long-distance calling charges should be enjoyed. Use of the VOIP should not require the dialing of extra digits to reach users elsewhere on the VOIP network. On the contrary, VOIP service more commonly reduces dialed digits by allowing users (served by PBXs in facilities in distant cities) to dial their co-workers with 3-, 4-, or 5-digit extensions -- as if they were in the same facility. More importantly, the VOIP system should be configured to maximize savings in long-distance calling charges. To achieve both of these objectives, ease of use and maximized savings, the VOIP phonebooks must be set correctly.

NOTE: VOIPs are commonly used for another reason, as well: VOIPs allow an organization to integrate phone and data traffic onto a single network. Typically these are private networks.

Free Calls: One VOIP Site to Another

The most direct use of the VOIP system is making calls between the offices where the VOIPs are located. Consider, for example, the Wren Clothing Company. This company has VOIP-equipped offices in London, Paris, and Amsterdam, each served by its own PBX. VOIP calls between the three offices completely avoid international long-distance charges. These calls are free. The phonebooks can be set up to allow all Wren Clothing employees to contact each other using 3-, 4-, or 5-digit numbers, as though they were all in the same building.

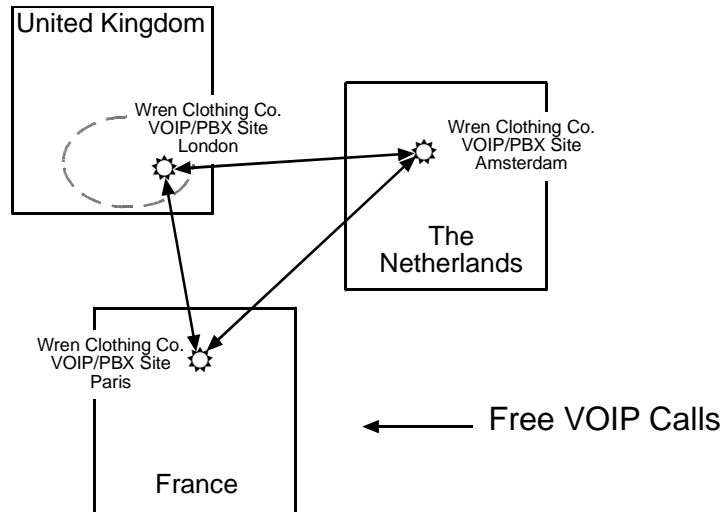

Local Rate Calls: Within Local Calling Area of Remote VOIP

In the second use of the VOIP system, the local calling area of each VOIP location becomes accessible to all of the VOIP system's users. As a result, international calls can be made at local calling rates. For example, suppose that Wren Clothing buys its zippers from The Bluebird Zipper Company in the western part of metropolitan London. In that case, Wren Clothing personnel in both Paris and Amsterdam could call the Bluebird Zipper Company without paying international long-distance rates. Only London local phone rates would be charged. This applies to calls completed anywhere in London's local calling area (which includes both Inner London and Outer London). Generally, local calling rates apply only within a single area code, and, for all calls outside that area code, national rates apply. There are, however, some European cases where local calling rates extend beyond a single area code. Local rates between Inner and Outer London are one example of this. (It is also possible, in some locations, that calls within an area code may be national calls. But this is rare.)

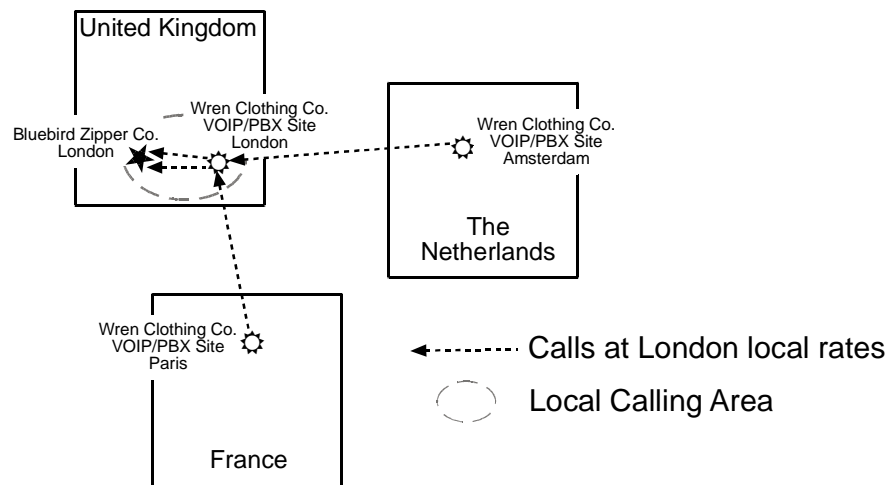

Similarly, the VOIP system allows Wren Clothing employees in London and Amsterdam to call anywhere in Paris at local rates; it allows Wren Clothing employees in Paris and London to call anywhere in Amsterdam at local rates.

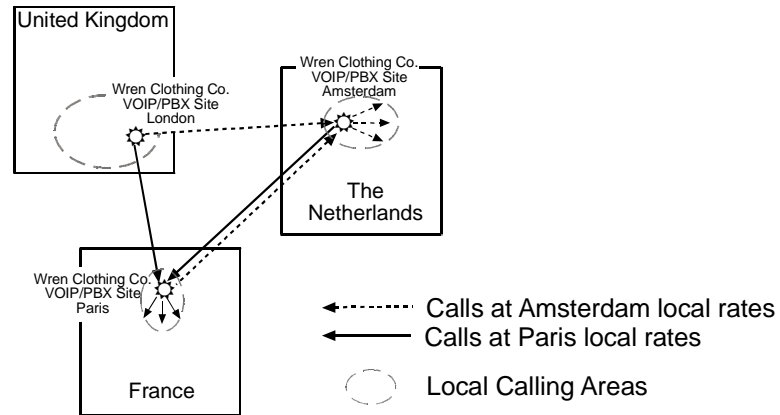

National Rate Calls: Within Nation of Remote VOIP Site

In the third use of the VOIP system, the national calling area of each VOIP location becomes accessible to all of the VOIP system's users. As a result, international calls can be made at national calling rates. Again, significant savings are possible. For example, suppose that the Wren Clothing Company buys its buttons from the Chickadee Button Company in the Dutch city of Rotterdam. In that case, Wren Clothing personnel in both London and Paris could call the Chickadee Button Company without paying international long-distance rates; only Dutch national calling rates would be charged. This applies to calls completed anywhere in The Netherlands.

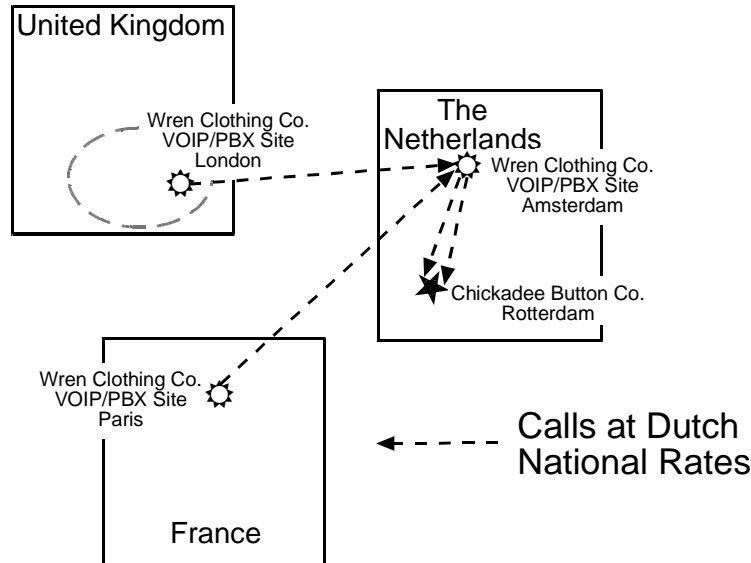

Similarly, the VOIP system allows Wren Clothing employees in London and Amsterdam to call anywhere in France at French national rates; it allows Wren Clothing employees in Paris and Amsterdam to call anywhere in the United Kingdom at its national rates.

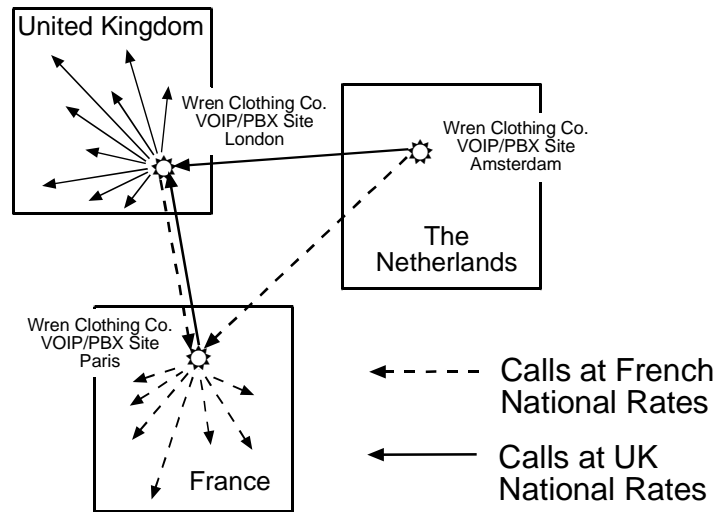

Inbound versus Outbound Phonebooks

To make the VOIP system transparent to phone users and to allow all possible free and reduced-rate calls, the VOIP administrator must configure the “Outbound” and “Inbound” phone-books of each VoIP in the system.

The “Outbound” phonebook for a particular VOIP unit describes the dialing sequences required for a call to originate locally (typically in a PBX in a particular facility) and reach any of its possible destinations at remote VOIP sites, including calls terminating at points beyond the remote VOIP site.





The “Inbound” phonebook for a particular VOIP unit describes the dialing sequences required for a call to originate remotely from any other VOIP sites in the system, and to terminate on that particular VOIP.

Briefly stated, *the MultiVOIP’s Outbound phonebook lists the phone stations it can call; its Inbound phonebook lists the dialing sequences that can be used to call that MultiVOIP.* (Of course, the phone numbers are not literally “listed” individually.) The phone stations that can originate or complete calls over the VOIP system are described by numerical rules called “destination patterns.” These destination patterns generally consist of country codes, area codes or city codes, and local phone exchange numbers.

In order for any VOIP phone call to be made, there must be both an Inbound Phonebook entry and an Outbound Phonebook entry that describe the end-to-end connection. The phone station originating the call must be connected to the VOIP system. The Outbound Phonebook for that VOIP unit must have a destination pattern entry that includes the 'called' phone (that is, the phone completing the call). The Inbound Phonebook of the VOIP where the call is completed must have a destination pattern entry that includes the digit sequence dialed by the originating phone station.

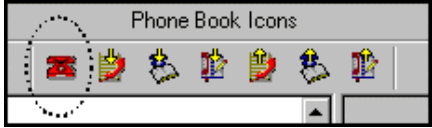
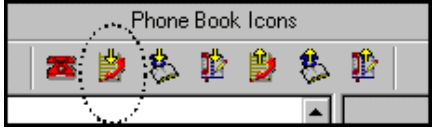
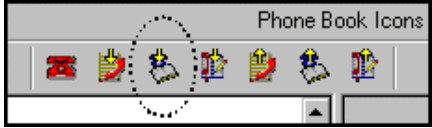
The PhoneBook Configuration procedure below is brief, but it is followed by an example case. For many people, the example case may be easier to grasp than the procedure steps. Configuration is not difficult, but all phone number sequences, destination patterns, and other information must be entered exactly; otherwise connections will not be made.

Phonebook configuration screens can be accessed using icons or the sidebar menu.

Phonebook Icons	Description
 <p>The image shows a horizontal menu titled "Phone Book Icons" containing seven icons. The first icon, which is a red telephone handset, is circled with a dashed line.</p>	Phonebook Configuration
 <p>The image shows a horizontal menu titled "Phone Book Icons" containing seven icons. The second icon, which is a red telephone handset with a plus sign, is circled with a dashed line.</p>	Inbound Phonebook Entries List
 <p>The image shows a horizontal menu titled "Phone Book Icons" containing seven icons. The third icon, which is a blue telephone handset with a plus sign, is circled with a dashed line.</p>	Add Inbound Phonebook Entry
 <p>The image shows a horizontal menu titled "Phone Book Icons" containing seven icons. The fourth icon, which is a blue telephone handset with a plus sign and a gear, is circled with a dashed line.</p>	Edit selected Inbound Phonebook Entry
 <p>The image shows a horizontal menu titled "Phone Book Icons" containing seven icons. The fifth icon, which is a red telephone handset with a plus sign, is circled with a dashed line.</p>	Outbound Phonebook Entries List
 <p>The image shows a horizontal menu titled "Phone Book Icons" containing seven icons. The sixth icon, which is a blue telephone handset with a plus sign, is circled with a dashed line.</p>	Add Outbound Phonebook Entry
 <p>The image shows a horizontal menu titled "Phone Book Icons" containing seven icons. The seventh icon, which is a blue telephone handset with a plus sign and a gear, is circled with a dashed line.</p>	Edit selected Outbound Phonebook Entry

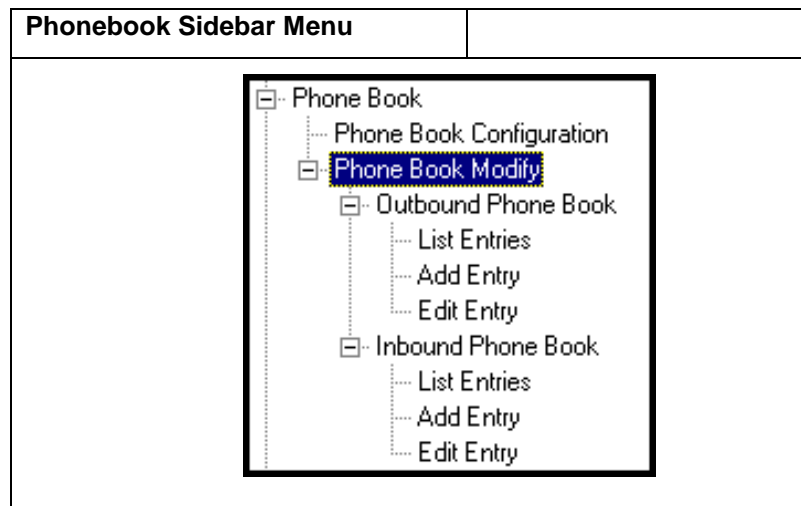

Phonebook Configuration Procedure

1. Go to the **PhoneBook Configuration** screen (using either the sidebar menu, drop-down menu, or icon).

Phone Book Configuration

Gateway Name : **London Office**

Q.931 Parameters

Use Fast Start

Call Signaling Port : **1720**

Register with GateKeeper

Gatekeeper RAS Parameters

Gatekeeper /Clear Channel IP Address : **200 . 2 . 10 . 3**

Port Number : **1719**

Gatekeeper Prefix : **65**

Gatekeeper Name : **London Office - Main**

Gateway H323 ID :

Enable Proxy

Proxy Parameters

Proxy Server IP Address : **0 . 0 . 0 . 0**

Port Number : **0**

H323 Version 4 Options

Q.931 Multiplexing [Mux] H.245 Tunneling [Tun]

Parallel H.245 [FS+Tun] Annex -E [AE]

OK

Cancel

Help

In consultation with your VOIP administrator, enter the Gateway Name and values for Q.931 parameters and Gatekeeper RAS parameters. Determine whether your voip system will operate with a proxy server. Determine which H.323 version 4 functions you will implement. (They are not always applicable. See field description for each parameter.)

The table below describes all fields in the **PhoneBook Configuration** screen.

PhoneBook Configuration Parameter Definitions		
Field Name	Values	Description
Gateway Name	Y/N	This field allows you to specify a name for this MultiVOIP. When placing a call, this name is sent to the remote MVP3000 for display in Call Progress listings, Logs, etc.
Q.931 Parameters		
Use Fast Start	Y/N	Enables the H.323 Fast Start procedure. May need to be enabled/disabled for compatibility with third-party VOIP gateways.
Call Signalling Port	port number	Default: 1720 (H.323)
GateKeeper RAS Parameters		
IP Address		IP address of the GateKeeper.
Port Number		Well-known port number for GateKeepers. Must match port number of GateKeeper, 1719.
Gateway Prefix		This number becomes registered with the GateKeeper. Call requests sent to the gatekeeper and preceded by this prefix will be routed to the VOIP gateway.
Gatekeeper Name	<i>alpha-numeric string</i>	Optional. The name of the GateKeeper with which this MultiVOIP is trying to register.
H.323 ID		The H.323 ID is used to register this particular MultiVOIP with the GateKeeper. H.323 ID is an alias entry sent to the GateKeeper, made of alpha-numeric characters. For NetMeeting endpoints, numbers are preferred over letters. The H.323 ID identifies the IP calling sequence that the GateKeeper must 'dial' to contact the remote VOIP.

PhoneBook Configuration Parameter Definitions (cont'd)		
Field Name	Values	Description
Proxy Server Parameters		
Enable Proxy	Y/N	
Proxy Server IP Address	n.n.n.n where n=0-255	Network address of the proxy server that the voip is using.
Port Number		Logical port number for proxy communications.
H.323 Version 4 Parameters		
Q.931 Multiplexing (Mux)	Y/N	Signalling for multiple phone calls can be carried on a single port rather than opening a separate signalling port for each call. This conserves bandwidth resources.
H.245 Tunneling (Tun)	Y/N	H.245 messages are encapsulated within the Q.931 call signalling channel. Among other things, the H.245 messages let the two endpoints tell each other what their technical capabilities are and determine who, during the call, will be the client and who the server. Tunneling is the process of transmitting these H.245 messages through the Q.931 channel. The same TCP/IP socket (or logical port) already being used for the Call Signalling Channel is then also used by the H.245 Control Channel. This encapsulation reduces the number of logical ports (sockets) needed and reduces call setup time.

PhoneBook Configuration Parameter Definitions (cont'd)		
Field Name	Values	Description
H.323 Version 4 Parameters		
Parallel H.245 (FS + Tun)	Y/N	FS (Fast Start or Fast Connect) is a Q.931 feature of H.323v2 to hasten call setup as well as 'pre-opening' the media channel before the CONNECT message is sent. This pre-opening is a requirement for certain billing activities. Under Parallel H.245 FS + Tun, this Fast Connect feature can operate simultaneously with H.245 Tunneling (see description above).
Annex -E (AE)	Y/N	Multiplexed UDP call signalling transport. Annex E is helpful for high-volume voip system endpoints. Gateways with lesser volume can afford to use TCP to establish calls. However, for larger volume endpoints, the call setup times and system resource usage under TCP can become problematic. Annex E allows endpoints to perform call signalling functions under the UDP protocol, which involves substantially streamlined overhead. (This feature should not be used on the public Internet because of potential problems with security and bandwidth usage.)

2. Select **PhoneBook Modify** and then select **Outbound Phone Book/List Entries**.

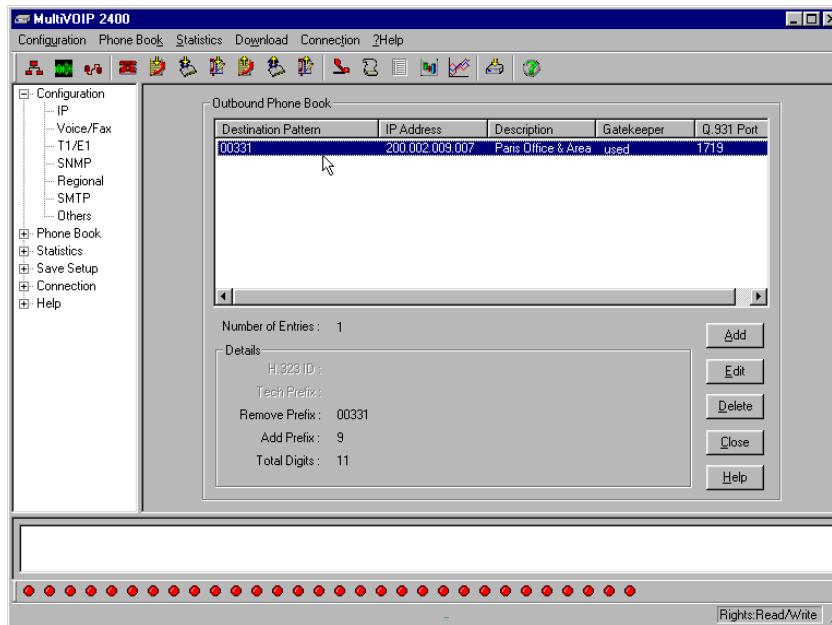

Click **Add**.

3. The Add/Edit Outbound PhoneBook screen appears.

The screenshot displays the MultiVOIP 3000 configuration window. The left sidebar shows a tree view with 'Phone Book' expanded to 'Outbound Phone Book', where 'Add Entry' is selected. The main window is titled 'Add/Edit Outbound Phone Book' and contains the following fields and controls:

- Phone Number Details:**
 - Destination Pattern: 00334
 - Total Digits: 12
 - Remove Prefix: 00334
 - Add Prefix: 9
- Buttons: OK, Cancel, Help
- IP Address: 200 . 002 . 009 . 007
- Description: Access to Lyon area
- Protocol Type: SIP, H.323
- H.323 section:
 - Use Gatekeeper
 - Gateway H323 ID: []
 - Gateway Prefix: []
 - Q.931 Port Number: 1720
- SIP section:
 - Use Proxy
 - Transport Protocol: TCP, UDP
 - SIP Port Number: 5060
 - SIP URL: []
- Advanced button

Enter Outbound PhoneBook data for your MVP3010. Note that the Advanced button gives access to the Alternate IP Routing feature, if needed. Alternate IP Routing can be implemented in a secondary screen (as described after the primary screen field definitions below).

The fields of the **Add/Edit Outbound Phone Book** screen are described in the table below.

Add/Edit Outbound Phone Book: Field Definitions		
Field Name	Values	Description
Destination Pattern	prefixes, area codes, exchanges, line numbers, extensions	Defines the beginning of dialing sequences for calls that will be connected to another VOIP in the system. Numbers beginning with these sequences are diverted from the PTSN and carried on Internet or other IP network.
Total Digits	as needed	number of digits the phone user must dial to reach specified destination
Remove Prefix	dialed digits	portion of dialed number to be removed before completing call to destination
Add Prefix	dialed digits	digits to be added before completing call to destination
IP Address	n.n.n.n for = 0-255	the IP address to which the call will be directed if it begins with the destination pattern given
Description	alpha-numeric	Describes the facility or geographical location at which the call will be completed.
Protocol Type	SIP or H.323	Indicates protocol to be used in outbound transmission.

Add/Edit Outbound Phone Book: Field Definitions (cont'd)		
Field Name	Values	Description
H.323 fields		
Use Gatekeepr	Y/N	Indicates whether or not gatekeeper is used.
H.323 ID		The H.323 ID assigned to the destination MultiVOIP. Only valid if "Use Gatekeeper" is enabled for this entry.
Gateway Prefix		This number becomes registered with the GateKeeper. Call requests sent to the gatekeeper and preceded by this prefix will be routed to the VOIP gateway.
Q.931 Port Number Q.931 Port Number	1720	Q.931 is the call signalling protocol for setup and termination of calls (aka ITU-T Recommendation I.451). H.323 employs only one "well-known" port (1720) for Q.931 signalling. If Q.931 message-oriented signalling protocol is used, the port number 1720 must be chosen.

Add/Edit Outbound Phone Book: Field Definitions (cont'd)		
Field Name	Values	Description
SIP Fields		
Use Proxy	Y/N	Select if proxy server is used.
Transport Protocol	TCP or UDP	Voip administrator must choose between UDP and TCP transmission protocols. UDP is a high-speed, low-overhead connectionless protocol where data is transmitted without acknowledgment, guaranteed delivery, or guaranteed packet sequence integrity. TCP is slower connection-oriented protocol with greater overhead, but having acknowledgment and guarantees delivery and packet sequence integrity.
SIP Port Number	5060 or other *See RFC3087 ("Control of Service Context using SIP Request-URI," by the Network Working Group).	The SIP Port Number is a UDP logical port number. The voip will "listen" for SIP messages at this logical port. If SIP is used, 5060 is the default, standard, or "well known" port number to be used. If 5060 is not used, then the port number used is that specified in the SIP Request URI (Universal Resource Identifier).
SIP URL	<i>sip.userphone</i> @ <i>hostserver</i> , where "userphone" is the telephone number and "hostserver" is the domain name or an address on the network	Looking similar to an email address, a SIP URL identifies a user's address. In SIP communications, each caller or callee is identified by a SIP url: sip:user_name@host_name. The format of a sip url is very similar to an email address, except that the "sip:" prefix is used.

Advanced button	--	Gives access to secondary screen where an Alternate IP Route can be specified for backup or redundancy of signal paths. See discussion on next page.
---------------------------	----	--

Clicking on the **Advanced** button brings up the **Alternate Routing** secondary screen. This feature provides an alternate path for calls if the primary IP network cannot carry the traffic. Often in cases of failure, call traffic is temporarily diverted into the PSTN. However, this feature could also be used to divert traffic to a redundant (backup) unit in case one voip unit fails. The user must specify the IP address of the alternate route for each destination pattern entry in the Outbound Phonebook.

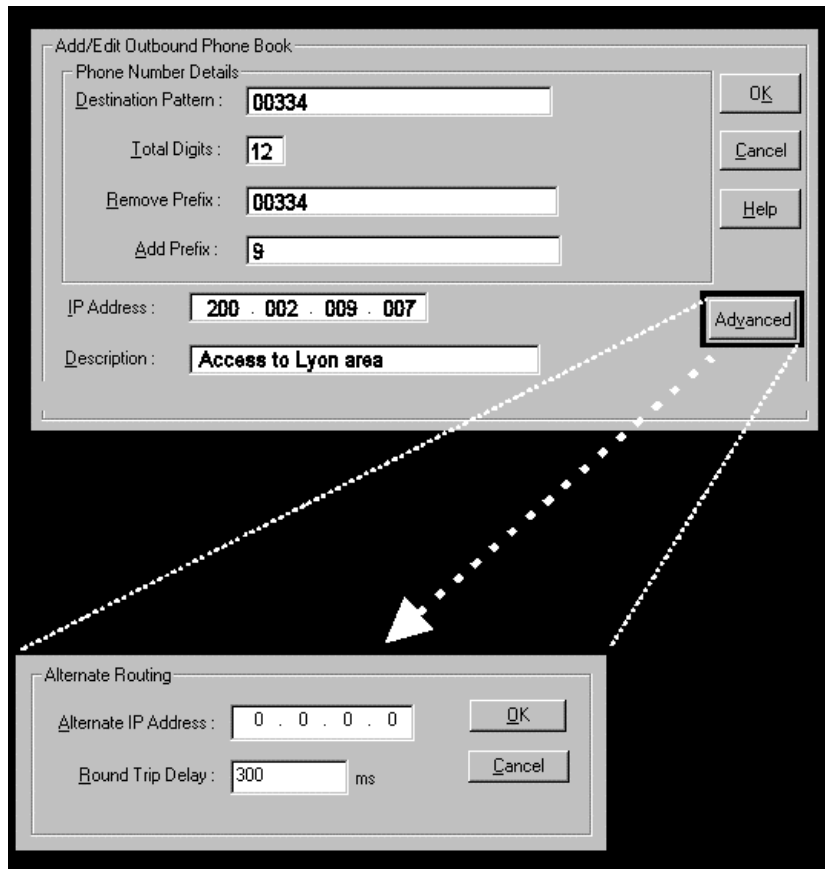

Alternate Routing Field Definitions		
Field Name	Values	Description
Alternate IP Address	n.n.n.n where n= 0-255	Alternate destination for outbound data traffic in case of excessive delay in data transmission.
Round Trip Delay	milliseconds	The Round Trip Delay is the criterion for judging when a data pathway is considered blocked. When the delay exceeds the threshold specified here, the data stream will be diverted to the alternate destination specified as the Alternate IP Address.

4. Select **PhoneBook Modify** and then select **Inbound PhoneBook/List Entries**.

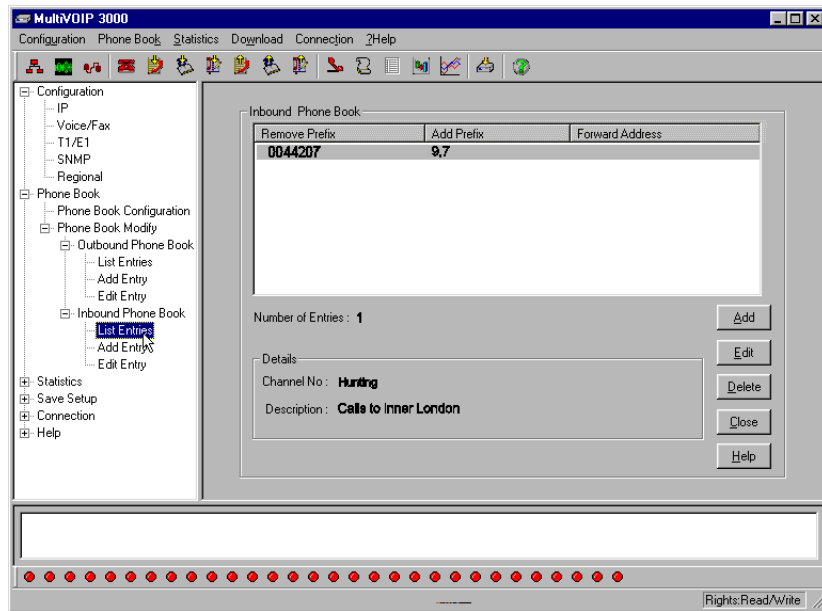

5. The **Add/Edit Inbound PhoneBook** screen appears.

The screenshot displays the 'Add/Edit Inbound Phone Book' configuration window. It contains the following fields and controls:

- Remove Prefix:** Text input field containing '0044207'.
- Add Prefix:** Text input field containing '8,7'.
- Channel Number:** Dropdown menu set to 'Hunting'.
- Description:** Text input field containing 'Access to Inner London'.
- Call Forward:** A sub-section containing:
 - Enable** checkbox.
 - Forward Condition:** Radio buttons for 'Unconditional' (selected), 'Busy', and 'No Response'.
 - Forward Address / Number:** Empty text input field.
 - Ring Count:** Text input field containing '0'.

Buttons for 'OK', 'Cancel', and 'Help' are located on the right side of the window.

Enter Inbound PhoneBook data for your MVP3010. The fields of the Add/Edit Inbound PhoneBook screen are described in the table below.

Add/Edit Inbound Phone Book: Field Definitions		
Field Name	Values	Description
Remove Prefix	dialed digits	portion of dialed number to be removed before completing call to destination (often a local PBX)
Add Prefix	dialed digits	digits to be added before completing call to destination (often a local PBX)
Channel Number	1-30, or "Hunting"	E1 channel number to which the call will be assigned as it enters the local telephony equipment (often a local PBX). "Hunting" directs the call to any available channel.

Add/Edit Inbound Phone Book: Field Definitions (cont'd)		
Field Name	Values	Description
Description	--	Describes the facility or geographical location at which the call originated.
Call Forward Parameters		
Enable	Y/N	Click the check-box to enable the call-forwarding feature.
Forward Condition	Uncondit.; Busy No Resp.	Unconditional. When selected, all calls received will be forwarded. Busy. When selected, calls will be forwarded when station is busy. No Response. When selected, calls will be forwarded if called party does not answer after a specified number of rings, as specified in Ring Count field.
Forward Address/ Number	IP addr. or phone number	Phone number or IP address to which calls will be directed.
Ring Count	integer	When No Response is condition for forwarding calls, this determines how many unanswered rings are needed to trigger the forwarding.

6. When your Outbound and Inbound PhoneBook entries are completed, click on **Save Setup** in the sidebar menu to save your configuration.

You can change your configuration at any time as needed for your system.

Remember that the initial MVP3010 setup must be done locally using the MultiVOIP program. However, after the initial configuration is complete, all of the MVP3010 units in the VOIP system can be configured, re-configured, and updated from one location using the MultiVoipManager software program.

E1 Phonebook Examples

To demonstrate how Outbound and Inbound PhoneBook entries work in an international VOIP system, we will re-visit our previous example in greater detail. It's an international company with offices in London, Paris, and Amsterdam. In each office, a MVP3010 has been connected to the PBX system.

3 Sites, All-E1 Example

The VOIP system will have the following features:

1. Employees in all cities will be able to call each other over the VOIP system using 4-digit extensions.
2. Calls to Outer London and Inner London, greater Amsterdam, and greater Paris will be accessible to all company offices as local calls.
3. Vendors in Guildford, Lyon, and Rotterdam can be contacted as national calls by all company offices.

Note that the phonebook entries for Series II analog MultiVOIP used in Euro-type telephony settings will be the same in format as entries for the MVP3010.

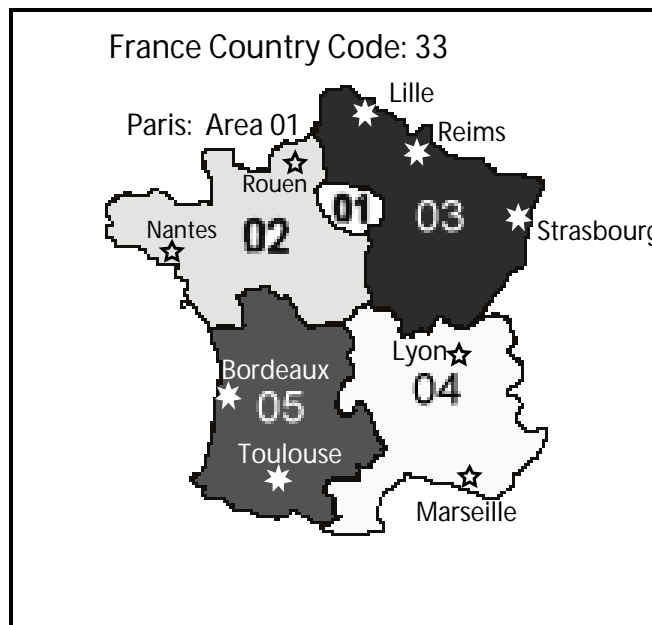
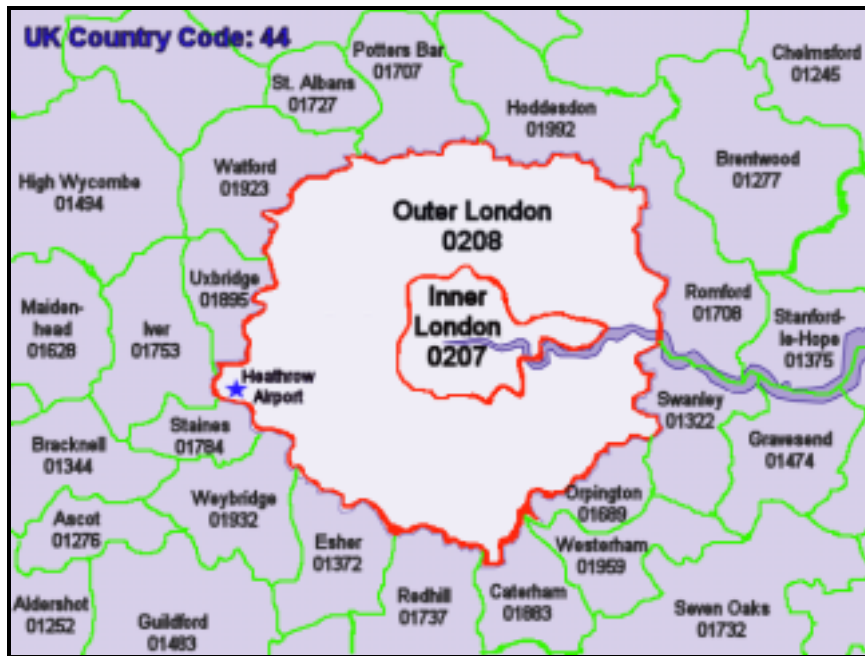



An outline of the equipment setup in these three offices is shown below.

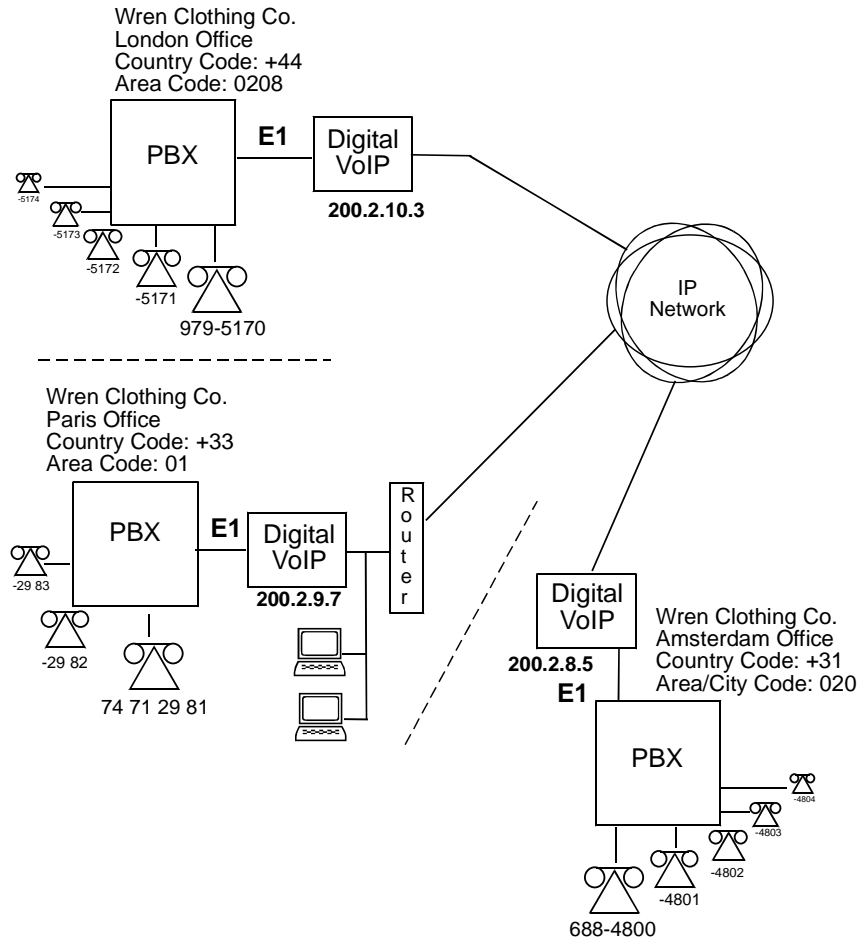

The screen below shows Outbound PhoneBook entries for the VOIP located in the company's London facility

Outbound PhoneBook { London VOIP Unit }

Dest Pattern	IP Address	Description
00331	200.002.008.007	Paris
00334	200.002.008.007	Lyon
003120	200.002.008.005	Amsterdam
003110	200.002.008.005	Rotterdam
2	200.002.008.007	Paris (company office, empl. extensions)
4	200.002.008.005	Amsterdam (company office, employees)

Number of Entries : 6

Details:

H.323 ID :

Remove Prefix :

Add Prefix :

Total Digits : 13

Add

Edit

Delete

Cancel

The Inbound PhoneBook for the London VOIP is shown below.

Inbound PhoneBook { London VOIP Unit }

From Prefix	Add Prefix
0044207	9,7
0044208	9,8
00441483	9,01483
00442089795	5
5	5

Number of Entries : 5

Details:

Channel No : 0

Description : Inner London access for Paris & Amst employees

Add

Edit

Delete

Cancel

NOTE: Commas are allowed in the Inbound Phonebook, but **not** in the Outbound Phonebook. Commas denote a brief pause for a dial-tone, allowing time for the PBX to get an outside line.

The screen below shows Outbound PhoneBook entries for the VOIP located in the company's Paris facility.

{ Paris VOIP Unit }

Outbound PhoneBook

Dest Pattern	IP Address	Description
003120	200.002.008.005	Amsterdam
003110	200.002.008.005	Rotterdam
0044207	200.002.010.003	London (Inner)
0044208	200.002.010.003	London (Outer)
00441483	200.002.010.003	Guildford
5	200.002.010.003	London (company office, empl extensions)
4	200.002.008.005	Amsterdam (company office, employees)

Number of Entries : 7

Details:

H.323 ID :

Remove Prefix :

Add Prefix :

Total Digits : 13

The Inbound PhoneBook for the Paris VOIP is shown below.

{ Paris VOIP Unit }

Inbound PhoneBook

Plan Prefix	Add Prefix
2	2
00331	9
00334	9,0

Number of Entries : 3

Details:

Channel No : 0

Description : Access to Lyon for London & Amsterdam employees

The screen below shows Outbound PhoneBook entries for the VOIP in the company's Amsterdam facility.

{ Amsterdam VOIP Unit }

Outbound PhoneBook

Dest Pattern	IP Address	Description
0044208	200.002.010.003	London (outer)
0044207	200.002.010.003	London (inner)
00441483	200.002.010.003	Guildford
00331	200.002.009.007	Paris
00334	200.002.009.007	Lyon
5	200.002.010.003	London (company office, employ. ext.)
2	200.002.009.007	Paris (company office, employee ext.)

Number of Entries : 3

Details:

H.323 ID :

Remove Prefix :

Add Prefix :

Total Digits : 14

The Inbound PhoneBook for the Amsterdam VOIP is shown below.

{ Amsterdam VOIP Unit }

Inbound PhoneBook

Rem Prefix	Add Prefix
4	4
003120	9
003110	9,010
0031206884	4

Number of Entries : 4

Details:

Channel No : 0

Description : Access to Amsterdam office by London & Paris employees

Configuring Digital & Analog VOIPs in Same System

The MVP3010 digital MultiVOIP unit is compatible with analog VOIPs. In many cases, digital and analog VOIP units will appear in the same telephony/IP system. In addition to MVP-210/410/810 MultiVOIP units (Series II units), legacy analog VOIP units (Series I units made by MultiTech) may be included in the system, as well. When legacy VOIP units are included, the VOIP administrator must handle two styles of phonebooks in the same VOIP network. The diagram below shows a small-scale system of this kind: one digital VOIP (the MVP3010) operates with two Series II analog VOIPs (an MVP210 and an MVP410), and two Series I legacy VOIPs (two MVP200 units).

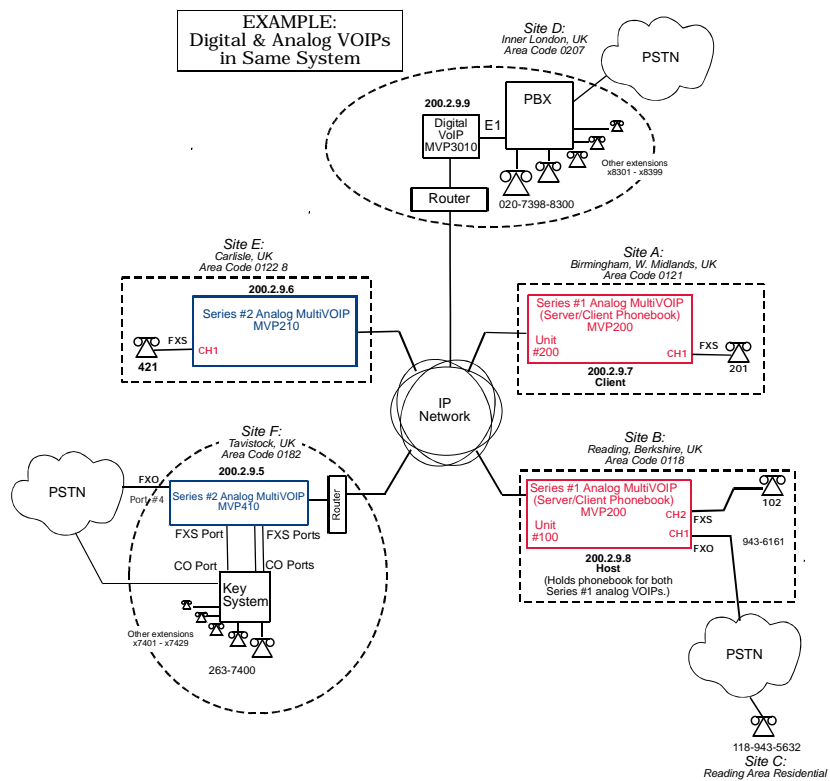

The Series I analog VOIP phone book resides in the “Host” VOIP unit at Site B. It applies to both of the Series I analog VOIP units.

Each of the Series II analog MultiVOIPs (the MVP210 and the MVP410) requires its own inbound and outbound phonebooks. The MVP3010 digital MultiVOIP requires its own inbound and outbound phonebooks, as well.

These **seven** phone books are shown below.

Phone Book for Analog VOIP Host Unit (Site B)			
VOIP Dir # -OR- Destination Pattern	IP Address	Channel	Comments
102	200.2.9.8	2	Site B, FXS channel. (Reading, UK)
101	200.2.9.8	1	Site B, FXO channel. (Reading, UK)
201	200.2.9.7	1	Site A, FXS channel. (Birmingham)
421	200.2.9.6	0	Site E, FXS channel. (Carlisle, UK)
018226374 Note 3.	200.2.9.5	0	Gives remote voip users access to key phone system extensions at Tavistock office (Site F). The key system might be arranged either so that calls go through a human operator or through an auto-attendant (which prompts user to dial the desired extension).
0182	200.2.9.5	4	Gives remote voip users access to Tavistock PSTN via FXO port (#4) at Site F.
3xx	200.2.9.9	0 (Note 1.)	Allows remote voip users to call all PBX extensions at Site D (Inner London) using only three digits.
0207 xxx xxxx	200.2.9.9	0 (Note 2.)	Gives remote voip users access to phone numbers in 0207 area code (Inner London) in which Site D is located.

0208 xxx xxxx	200.2.9.9	0 (Note 2.)	Gives remote voip users access to phone numbers in 0208 area code (Outer London) for which calls are local from Site D (Inner London).
<p>Note 1. The “x” is a wildcard character.</p> <p>Note 2. By specifying “Channel 0,” we instruct the MVP3010 to choose any available data channel to carry the call.</p> <p>Note 3. Note that Site F key system has only 30 extensions (x7400-7429). This destination pattern (018226374) actually directs calls to 402-263-7430 through 402-263-7499 into the key system, as well. This means that such calls, which belong on the PSTN, cannot be completed. In some cases, this might be inconsequential because an entire exchange (fully used or not) might have been reserved for the company or it might be unnecessary to reach those numbers. However, to specify only the 30 lines actually used by the key system, the destination pattern 018226374 would have to be replaced by three other destination patterns, namely 0182263740, 0182263741, and 0182263742. In this way, calls to 0182-263-7430 through 0182-263-7499 would be properly directed to the PSTN. In the Site D outbound phonebook, the 30 lines are defined exactly, that is, without making any adjacent phone numbers unreachable through the voip system.</p>			

The Outbound PhoneBook of the MVP3010 is shown below.

Outbound Phone Book for MVP3010 Digital VOIP (Site D)				
Destin. Pattern	Remove Prefix	Add Prefix	IP Address	Comment
201			200.2.9.7	To originate calls to Site A (Birmingham).
901189	901189	101# Note 3.	200.2.9.8	To originate calls to any PSTN phone in Reading area using the FXO channel (channel #1) of the Site B VOIP (Reading, UK).
421	--	--	200.2.9.6	Calls to Site E (Carlisle).
90182				Calls to Tavistock local PSTN (Site F) could be arranged by operator or possibly by auto-attendant.
90182 263 740	9	--	200.2.9.5	Calls to extensions of key phone system at Tavistock office.
90182 263 741	9	--	200.2.9.5	
90182 263 742	9	--	200.2.9.5	
102			200.2.9.8	To originate calls to phone connected to FXS port (channel #2) of the Site B VOIP (Reading).
Note 3. The pound sign (“#”) is a delimiter separating the VOIP number from the standard telephony phone number.				

The Inbound PhoneBook of the MVP3010 is shown below.

Inbound Phone Book for MVP3010 Digital VOIP (Site D)			
Remove Prefix	Add Prefix	Channel Number	Comments
0207	9,7 Note 4. Note 5.	0	Allows phone users at remote voip sites to call local numbers (those within the Site D area code, 0207, Inner London) over the VOIP network.
0208	9,8 Note 4. Note 5.	0	Allows phone users at remote voip sites to call local numbers (those in Outer London) over the VOIP network.
0207 39883	3	0	Allows phone users at remote voip sites to call extensions of the Site D PBX using three digits, beginning with "3" .
<p>Note 4. "9" gives PBX station users access to outside line. Note 5. The comma represents a one-second pause, the time required for the user to receive a dial tone on the outside line (PSTN). Commas can be used in the Inbound Phonebook, but not in the Outbound Phonebook.</p>			

Outbound Phone Book for MVP410 Analog VOIP (Site F)				
Destin. Pattern	Remove Prefix	Add Prefix	IP Address	Comment
201			200.2.9.7	To originate calls to Site A (Birmingham).
01189	0118	101# Note 3.	200.2.9.8	To originate calls to any PSTN phone in Reading area using the FXO channel (channel #1) of the Site B VOIP.
102			200.2.9.8	To originate calls to phone connected to FXS port (channel #2) of the Site B VOIP (Reading).
421			200.2.9.6	Calls to Site E (Carlisle).
0207			200.2.9.9	Calls to Inner London area PSTN via Site D PBX.
0208			200.2.9.9	Calls to Inner London area PSTN via Site D PBX.
3	--	0207 398 8	200.2.9.9	Calls to Inner London PBX extensions with three digits.
Note 3. The pound sign (“#”) is a delimiter separating the VOIP number from the standard telephony phone number.				

Inbound Phonebook for MVP410 Analog VOIP (Site F)			
Remove Prefix	Add Prefix	Channel Number	Comment
01822	2	4	Calls to Tavistock local PSTN through FXO port (Port #4) at Site F.
0182 263 740	740.	0	Gives remote voip users, access to extensions of key phone system at Tavistock office.
0182 263 741	741.	0	Because call is completed at key system, abbreviated dialing (3-digits) is not workable.
0182 263 742	742	0	Human operator or auto-attendant is needed to complete these calls.

Outbound Phone Book for MVP210 Analog VOIP (Site E)				
Destin. Pattern	Remove Prefix	Add Prefix	IP Address	Comment
201			200.2.9.7	To originate calls to Site A (Birmingham).
01189	0118	101# Note 3.	200.2.9.8	To originate calls to any PSTN phone in Reading area using the FXO channel (channel #1) of the Site B VOIP.
102			200.2.9.8	To originate calls to phone connected to FXS port (channel #2) of the Site B VOIP (Reading).
01822	01822	--	200.2.9.5	Calls to Tavistock area PSTN (via FXO channel of the Site F VOIP).
0182 26374			200.2.9.5	Calls to Tavistock key system operator or auto-attendant.
0207	0207		200.2.9.9	Calls to London area PSTN via Site D PBX.
8		0207 398	200.2.9.9	Calls to London PBX extensions with four digits.
Note 3. The pound sign (“#”) is a delimiter separating the VOIP number from the standard telephony phone number.				

Inbound Phonebook for MVP210 Analog VOIP (Site E)			
Remove Prefix	Add Prefix	Channel Number	Comment
421		1	

Call Completion Summaries

Site A calling Site C, Method 1

1. Dial 101.
2. Hear dial-tone from Site B.
3. Dial 9435632.
4. Await completion. Talk.

Site A calling Site C, Method 2

5. Dial 101#9435632
6. Await completion. Talk.

Note: Some analog VOIP gateways will allow completion by Method 2. Others will not.

Site C calling Site A

1. Dial 9436161.
2. Hear dial-tone from Site B VOIP.
3. Dial 201.
4. Await completion. Talk.

Site D calling Site C

1. Dial 901189435632.
2. “9” gets outside line. On some PBXs, an “8” may be used to direct calls to the VOIP, while “9” directs calls to the PSTN. However, some PBX units can be programmed to identify the destination patterns of all calls to be directed to the VOIP.
3. PBX at Site D is programmed to divert all calls made to the 118 area code and exchange 943 into the VOIP network. (It would also be possible to divert *all* calls to all phones in area code 118 into the VOIP network, but it may not be desirable to do so.)
4. The MVP3010 removes the prefix “0118” and adds the prefix “101#” for compatibility with the analog MultiVOIP’s phonebook scheme. The “#” is a delimiter separating the analog VOIP’s phone number from the digits that the analog VOIP must dial onto its local PSTN to complete the call. The digits “101#9435632” are forwarded to the Site B analog VOIP.
5. The call passes through the IP network (in this case, the Internet).
6. The call arrives at the Site B VOIP. This analog VOIP receives this dialing string from the MVP3010: 101#9435632. The analog VOIP, seeing the “101” prefix, uses its own channel #1 (an FXO port) to connect the call to the PSTN. Then the analog VOIP dials its local phone number 9435632 to complete the call.

NOTE: In the case of Reading, Berkshire,, England, both “1189” and “1183” are considered local area codes. This is, in a sense however, a matter of terminology. It simply means that numbers of the form 9xx-xxxx and 3xx-xxxx are both local calls for users at other sites in the VOIP network.

Site D calling Site F

A voip call from Inner London PBX to extension 7424 on the key telephone system in Tavistock, UK.

A. The required entry in the London Outbound Phonebook to facilitate origination of the call, would be 90182263742. The call would be directed to the Tavistock voip's IP address, 200.2.9.5. (Generally on such a call, the caller would have to dial an initial "9". But typically the PBX would not pass the initial "9" dialed to the voip. If the PBX *did* pass along that "9" however, its removal would have to be specified in the local Outbound Phonebook.)

B. The corresponding entry in the Tavistock Inbound Phonebook to facilitate completion of the call would be

0182263742 for calls within the office at Tavistock

01822 for calls to the Tavistock local calling area (PSTN).

Call Event Sequence

1. Caller in Inner London dials 901822637424.
2. Inner London voip removes "9" .
3. Inner London voip passes remaining string, 01822637424on to the Tavistock voip at IP address 200.2.9.5.
4. The dialed string matches an inbound phonebook entry at the Tavistock voip, namely 0182263742.
5. The Tavistock voip rings one of the three FXS ports connected to the Tavistock key phone system.
6. The call will be routed to extension 7424 either by a human receptionist/ operator or to an auto-attendant (which allows the caller to specify the extension to which they wish to be connected).

Site F calling Site D

A voip call from a Tavistock key extension to extension 3117 on the PBX in Inner London.

A. The required entry in the Tavistock Outbound Phonebook to facilitate origination of the call, would be “3”. The string 02073988 is added, preceding the “3”. The call would be directed to the Inner London voip’s IP address, 200.2.9.9.

B. The corresponding entry in the Inner-London Inbound Phonebook to facilitate completion of the call would be 020739883.

1. The caller in Tavistock picks up the phone receiver, presses a button on the key phone set. This button has been assigned to a particular voip channel.
2. The caller in Tavistock hears dial tone from the Tavistock voip.
3. The caller in Tavistock dials 02073983117.
4. The Tavistock voip sends the entire dialed string to the Inner-London voip at IP address 200.2.9.9.
5. The Inner-London voip matches the called digits 02073983117 to its Inbound Phonebook entry “020739883,” which it removes. Then it adds back the “3” as a prefix.
6. The Inner-London PBX dials extension 3117 in the office in Inner London.

Variations in PBX Characteristics

The exact dialing strings needed in the Outbound and Inbound Phonebooks of the MVP3010 will depend on the capabilities of the PBX. Some PBXs require trunk access codes (like an “8” or “9” to access an outside line or to access the VOIP network). Other PBXs can automatically distinguish between intra-PBX calls, PSTN calls, and VOIP calls.

Some PBX units can also insert digits automatically when they receive certain dialing strings from a phone station. For example, a PBX may be programmable to insert automatically the three-digit VOIP identifier strings into calls to be directed to analog VOIPs.

The MVP3010 offers complete flexibility for inter-operation with PBX units so that a coherent dialing scheme can be established to connect a company’s multiple sites together in a way that is convenient and intuitive for phone users. When working together with modern PBX units, the presence of the MVP3010 can be completely transparent to phone users within the company.

International Telephony Numbering Plan Resources

Due to the expansion of telephone number capacity to accommodate pagers, fax machines, wireless telephony, and other new phone technologies, numbering plans have been changing worldwide. Many new area codes have been established; new service categories have been established (for example, to accommodate GSM, personal numbering, corporate numbering, etc.). Below we list several web sites that present up-to-date information on the telephony numbering plans used around the world. While we find these to be generally good resources, we would note that URLs may change or become nonfunctional, and we cannot guarantee the quality of information on these sites.

URL	Description
http://phonebooth.interocitor.net/wtng	The World Telephone Numbering Guide presents excellent international numbering info that is both broad and detailed. This includes info on re-numbering plans carried out world-wide in recent years to accommodate new technologies.
http://www.oftel.gov.uk/numbers/number.htm	UK numbering plan from the Office of Telecommunications, the UK telephony authority.
http://www.itu.int/home/index.html	The International Telecommunications Union is an excellent source and authority on international telecom regulations and standards. National and international number plans are listed on this site.

URL	Description
http://kropla.com/phones.htm	Guide to international use of modems.
http://www.numberplan.org/	National and international numbering plans based on direct input from regulators worldwide. Includes lists of telecom carriers per country.
http://www.eto.dk/	European Telecommunications Office. Primarily concerned with mobile/wireless radiotelephony, GSM, etc.
http://www.eto.dk/ETNS.htm	European Telephony Numbering Space. Resources for pan-European telephony services, standards, etc. Part of ETO site.
http://www.regtp.de/en/reg_tele/start/fs_05.html	List of European telecom regulatory agencies by country (from German telecom authority).

Chapter 9: Analog Phonebook Configuration

Phonebooks for Series II analog MultiVOIP units (MVP210, MVP410, and MVP810) are, in principle, configured the same as phonebooks for digital MultiVOIP products that would operate in the same environment (under either North American or European telephony standards, T1 or E1).

Therefore, if you are operating an analog MultiVOIP unit in a North American telephony environment, you will find useful phonebook instructions and examples in *Chapter 7: T1 Phonebook Configuration*. If you are operating an analog MultiVOIP unit in a European telephony environment, you will find useful phonebook instructions and examples in *Chapter 8: E1 Phonebook Configuration*.

Most of the examples in Chapters 7 and 8 describe systems containing both digital and analog MultiVOIP units.

You will also find useful information in *Chapter 2: Quick Start Guide*. See especially these sections:

- Phonebook Starter Configuration

- Phonebook Tips

- Phonebook Example (One Common Situation)

Chapter 2 also contains a “Phonebook Worksheet” section. You may want to print out several worksheet copies. Paper copies can be very helpful in comparing phonebooks at multiple sites at a glance. This will assist you in making the phonebooks clear and consistent and will reduce ‘surfing’ between screens on the configuration program.

Chapter 10: Operation and Maintenance

Operation and Maintenance

Although most Operation and Maintenance functions of the software are in the **Statistics** group of screens, an important summary appears in the **System Information** of the **Configuration** screen group.

System Information screen

This screen presents vital system information at a glance. Its primary use is in troubleshooting. This screen is accessible via the **Configuration** pulldown menu, the **Configuration** sidebar menu, or by the keyboard shortcut **Ctrl + Alt + Y**.

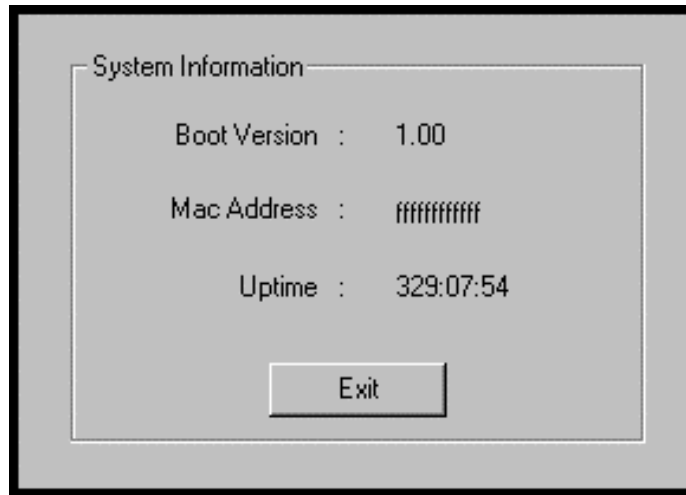

System Information Parameter Definitions		
Field Name	Values	Description
Boot Code Version	nn.nn	Indicates the version of the code that is used at the startup (booting) of the voip. The boot code version is independent of the software version.
Mac Address	alpha-numeric	Denotes the number assigned as the voip unit's unique Ethernet address.
Up Time	hours: mm:ss	Indicates how long the voip has been running since its last booting.

The frequency with which the System Information screen is updated is determined by a setting in the Logs screen

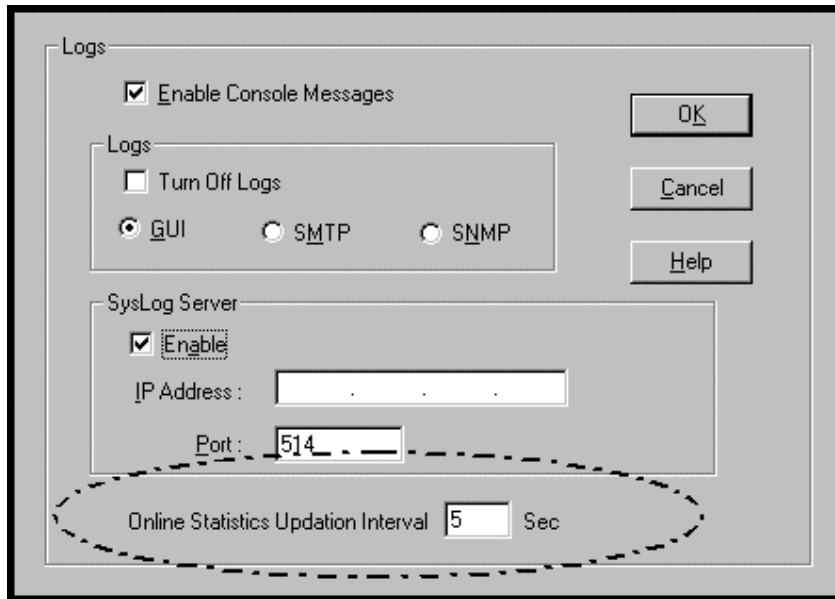

The screenshot displays the 'Logs' configuration window. At the top, there is a checkbox for 'Enable Console Messages' which is checked. Below this is a sub-section titled 'Logs' containing a 'Turn Off Logs' checkbox (unchecked) and three radio buttons: 'GUI' (selected), 'SMTP', and 'SNMP'. To the right of these options are three buttons: 'OK', 'Cancel', and 'Help'. Below the 'Logs' section is the 'SysLog Server' section, which includes an 'Enable' checkbox (checked), an 'IP Address' field, and a 'Port' field containing the value '514'. At the bottom of the window, the 'Online Statistics Update Interval' is set to '5' seconds. This specific setting is highlighted with a dashed oval.

Statistics Screens

Ongoing operation of the MultiVOIP, whether it is in a MultiVOIP/PBX setting or MultiVOIP/telco-office setting, can be monitored for performance using the Statistics functions of the MultiVOIP software.

About Call Progress

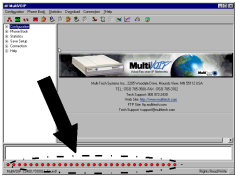
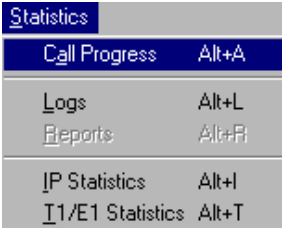
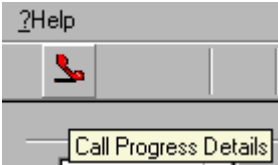
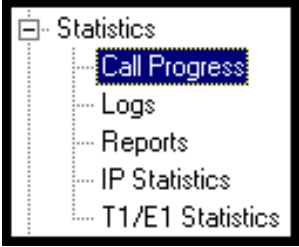
Accessing Call-Progress Statistics	
Channel Icons (Main Screen Lower Left)	
<p>Channel icons are green when data traffic is present, red when idle.</p> 	
Pulldown	Icon
	
Shortcut	Sidebar
<p>Alt + A</p>	

The Call Progress Details Screen

Call Progress Details

Channel: Channel 27

Call Details

Duration: -

Mode: -

Voice Coder: -

Packets Sent: -

Packets Rcvd: -

Bytes Sent: -

Bytes Rcvd: -

Packets Lost: -

Outbound Digits: -

Prefix Matched: -

Disconnect

Exit

Help

From->To Details

From ----> To: -

Gateway Name: -

IP Address: 0 . 0 . 0 . 0 0 . 0 . 0 . 0

Options: -

SC - Silence Compression FEC - Forward Error Correction

Supplementary Services Status

Call On Hold: -

Call Waiting: -

Caller Id: -

Call Status: On Hook

Call Control Status: -

Call Progress Details: Field Definitions		
Field Name	Values	Description
Channel	1-n	Number of data channel or time slot on which the call is carried. This is the channel for which call-progress details are being viewed.
Call Details		
Duration	Hours: Minutes: Seconds	The length of the call in hours, minutes, and seconds (hh:mm:ss).
Mode	Voice or FAX	Indicates whether the call being described was a voice call or a FAX call.
Voice Coder	G.723, G.729, G.711, etc.	The voice coder being used on this call.
Packets Sent	integer value	The number of data packets sent over the IP network in the course of this call.
Packets Rcvd	integer value	The number of data packets received over the IP network in the course of this call.
Bytes Sent	integer value	The number of bytes of data sent over the IP network in the course of this call.
Bytes Rcvd	integer value	The number of bytes of data received over the IP network in the course of this call.
Packets Lost	integer value	The number of voice packets from this call that were lost after being received from the IP network.
Outbound Digits	0-9, #, *	The digits transmitted by the MultiVOIP to the PBX/telco for this call.
Prefix Matched		Displays the dialed digits that were matched to a phonebook entry.

Call Progress Details: Field Definitions (cont'd)		
From – To Details		Description
Gateway Name	alphanumeric string	Identifier for the VOIP gateway that handled this call.
IP Address	x.x.x.x, where x has a range of 0 to 255	IP address from which the call was received.
Options	SC, FEC	Displays VOIP transmission options in use on the current call. These may include Forward Error Correction or Silence Compression.
Silence Compression	SC	“SC” stands for Silence Compression. With Silence Compression enabled, the MultiVOIP will not transmit voice packets when silence is detected, thereby reducing the amount of network bandwidth that is being used by the voice channel.
Forward Error Correction	FEC	“FEC” stands for Forward Error Correction. Forward Error Correction enables some of the voice packets that were corrupted or lost to be recovered. FEC adds an additional 50% overhead to the total network bandwidth consumed by the voice channel. Default = Off

Call Progress Details: Field Definitions (cont'd)		
Field Name	Values	Description
Supplementary Services Status		
Call on Hold	alphanumeric	Describes held call by its IP address source, location/gateway identifier, and hold duration. Location/gateway identifiers comes from Gateway Name field in Phone Book Configuration screen of remote voip.
Call Waiting	alphanumeric	Describes waiting call by its IP address source, location/gateway identifier, and hold duration. Location/gateway identifiers comes from Gateway Name field in Phone Book Configuration screen of remote voip.

Call Progress Details: Field Definitions (cont'd)		
Field Name	Values	Description
Supplementary Services Status		
Caller ID	There are four values: "Calling Party + <i>identifier</i> "; "Alerting Party + <i>identifier</i> "; "Busy Party + <i>identifier</i> "; and "Connected Party + <i>identifier</i> "	This field shows the identifier and status of a remote voip (which has Call Name Identification enabled) with which this voip unit is currently engaged in some voip transmission. The status of the engagement (Connected, Alerting, Busy, or Calling) is followed by the identifier of a specific channel of a remote voip unit. This identifier comes from the "Caller Id" field in the Supplementary Services screen of the remote voip unit.
Status	hangup, active	Shows condition of current call.
Call Control Status	Tun, FS + Tun, AE, Mux	Displays the H.323 version 4 features in use for the selected call. These include tunneling (Tun), Fast Start with tunneling (FS + Tun), Annex E multiplexed UDP call signalling transport (AE), and Q.931 Multiplexing (Mux). See Phonebook Configuration Parameters (in T1 or E1 chapters) for more on H.323v4 features.

About Logs

Accessing "Statistics: Logs"	
Pulldown	Icon
Shortcut	Sidebar
<p>Alt + L</p>	

The Logs Screen

Logs

Event	StartDate.Time	Duration	Status	Mode	From	To
1	0:0:0 0:0:0	00:00:15	Succ...	Voice		
2	0:0:0 0:0:0	00:00:16	Succ...	Voice		
3	29:8:2001 13:38:16	00:00:15	Succ...	Voice		
4	29:8:2001 14:30:6	00:00:00	Succ...	Voice		
5	29:8:2001 14:30:17	00:00:00	Succ...	Voice		
6	29:8:2001 14:31:39	00:00:10	Succ...	Voice		

Call details

Packets sent : 210	Packets recvd : 377	Last
Bytes sent : 12,600	Bytes recvd : 13,572	Exit
Packets loss : 39	Outbound digits : -	Help
Voice coder : G.723.1 @ 6.3 kbps		Delete File

<p>From details</p> <p>Gateway Name: _____</p> <p>IP Address: <input type="text"/></p> <p>Options: _____</p>	<p>To details</p> <p>Gateway Name: _____</p> <p>IP Address: <input type="text"/></p> <p>Options: _____</p>
--	--

SC - Silence Compression FEC - Forward Error Correction

Supplementary Services Info

Call Transferred To:

Call Forwarded To: CT Ph#: _____

Logs Screen Details: Field Definitions		
Field Name	Values	Description
Event # column	1 or higher	All calls are assigned an event number in chronological order, with the most recent call having the highest event number.
Start Date, Time column	dd:mm:yyyy hh:mm:ss	The starting time of the call (event). The date is presented as a day expression of one or two digits, a month expression of one or two digits, and a four-digit year. This is followed by a time-of-day expression presented as a two-digit hour, a two-digit minute, and a two-digit seconds value. (statistics, logs) field
Duration column	hh:mm:ss	This describes how long the call (event) lasted in hours, minutes, and seconds.
Status column	success or failure	Displays the status of the call, i.e., whether the call was completed successfully or not.
Mode column	voice or FAX	Indicates whether the (event) being described was a voice call or a FAX call.
From column	gateway name	Displays the name of the voice gateway that originates the call.
To column	gateway name	Displays the name of the voice gateway that completes the call.
Special Buttons		
Last		Displays last log entry.
Delete File		Deletes selected log file.
Call Details		
Packets sent	integer value	The number of data packets sent over the IP network in the course of this call.
Bytes sent	integer value	The number of bytes of data sent over the IP network in the course of this call.



Logs Screen Details: Field Definitions (cont'd)		
Field Name	Values	Description
Call Details (cont'd)		
Packets loss (lost)	integer value	The number of voice packets from this call that were lost after being received from the IP network.
Voice coder	G.723, G.729, G.711, etc.	The voice coder being used on this call.
Packets received	integer value	The number of data packets received over the IP network in the course of this call.
Bytes received	integer value	The number of bytes of data received over the IP network in the course of this call.
Outbound digits	0-9, #, *	The digits transmitted by the MultiVOIP to the PBX/telco for this call.
FROM Details		
Gateway Name	alphanumeric string	Identifier for the VOIP gateway that originated this call.
IP Address	x.x.x.x, where x has a range of 0 to 255	IP address of the VOIP gateway from which the call was received.
Options	FEC, SC	Displays VOIP transmission options used by the VOIP gateway originating the call. These may include Forward Error Correction or Silence Compression.
TO Details		
Gateway Name	alphanumeric string	Identifier for the VOIP gateway that completed (terminated) this call.
IP Address	x.x.x.x, where x has a range of 0 to 255	IP address of the VOIP gateway at which the call was completed (terminated).
Options		Displays VOIP transmission options used by the VOIP gateway terminating the call. These may include Forward Error Correction or Silence Compression.

Logs Screen Details: Field Definitions (cont'd)		
Supplementary Services Info		
Call Transferred To	phone number string	Number of party called in transfer.
Call Forwarded To	phone number string	Number of party called in forwarding.
CT Ph#	phone number string	Call Transfer phone number.

About Reports

This feature not implemented as of this writing.

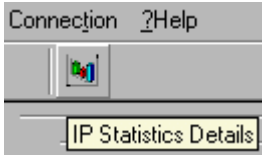
About IP Statistics

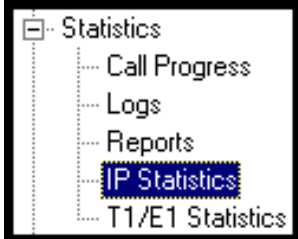
Accessing IP Statistics	
Pulldown	Icon
 <p>Statistics Call Progress Alt+A Logs Alt+L Reports Alt+R IP Statistics Alt+I T1/E1 Statistics Alt+T</p>	 <p>Connection ?Help  IP Statistics Details</p>
Shortcut	Sidebar
<p>Alt + I</p>	 <p>Statistics Call Progress Logs Reports IP Statistics T1/E1 Statistics</p>

IP Statistics Screen

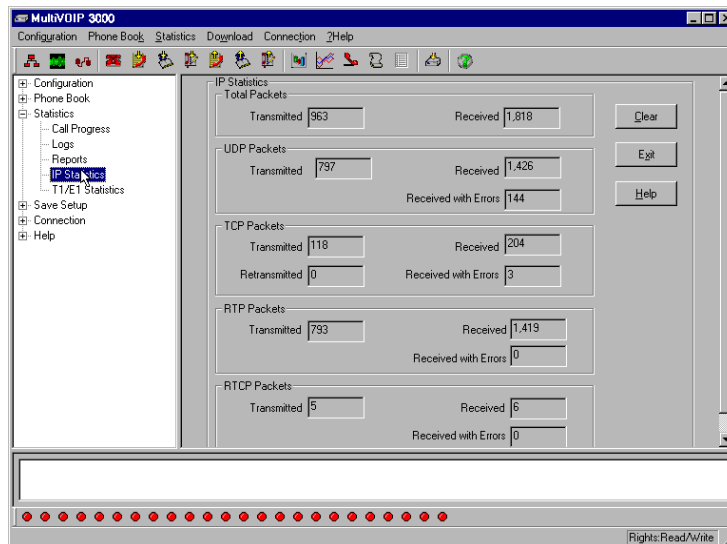



IP Statistics: Field Definitions		
Field Name	Values	Description
		<p>UDP versus TCP. (User Datagram Protocol versus Transmission Control Protocol). UDP provides unguaranteed, connectionless transmission of data across an IP network. By contrast, TCP provides reliable, connection-oriented transmission of data.</p> <p>Both TCP and UDP split data into packets called "datagrams." However, TCP includes extra headers in the datagram to enable retransmission of lost packets and reassembly of packets into their correct order if they arrive out of order. UDP does not provide this. Lost UDP packets are unretrievable; that is, out-of-order UDP packets cannot be reconstituted in their proper order..</p> <p>Despite these obvious disadvantages, UDP packets can be transmitted much faster than TCP packets -- as much as three times faster. In certain applications, like audio and video data transmission, the need for high speed outweighs the need for verified data integrity. Sound or pictures often remain intelligible despite a certain amount of lost or disordered data packets (which appear as static).</p>
"Clear" button	--	Clears packet tallies from memory.
Total Packets		Sum of data packets of all types.
Transmitted	integer value	Total number of packets transmitted by this VOIP gateway since the last "clearing" or resetting of the counter within the MultiVOIP software.
Received	integer value	Total number of packets received by this VOIP gateway since the last "clearing" or resetting of the counter within the MultiVOIP software.

IP Statistics: Field Definitions (cont'd)		
Field Name	Values	Description
Total Packets (cont'd)		Sum of data packets of all types.
Received with Errors	integer value	Total number of error-laden packets received by this VOIP gateway since the last "clearing" or resetting of the counter within the MultiVOIP software.
UDP Packets		User Datagram Protocol packets.
Transmitted	integer value	Number of UDP packets transmitted by this VOIP gateway since the last "clearing" or resetting of the counter within the MultiVOIP software.
Received	integer value	Number of UDP packets received by this VOIP gateway since the last "clearing" or resetting of the counter within the MultiVOIP software.
Received with Errors	integer value	Number of error-laden UDP packets received by this VOIP gateway since the last "clearing" or resetting of the counter within the MultiVOIP software.
TCP Packets		Transmission Control Protocol packets.
Transmitted	integer value	Number of TCP packets transmitted by this VOIP gateway since the last "clearing" or resetting of the counter within the MultiVOIP software.
Received	integer value	Number of TCP packets received by this VOIP gateway since the last "clearing" or resetting of the counter within the MultiVOIP software.
Received with Errors	integer value	Number of error-laden TCP packets received by this VOIP gateway since the last "clearing" or resetting of the counter within the MultiVOIP software.

IP Statistics: Field Definitions (cont'd)		
RTP Packets		Voice signals are transmitted in Realtime Transport Protocol packets. RTP packets are a type or subset of UDP packets.
Transmitted	integer value	Number of RTP packets transmitted by this VOIP gateway since the last "clearing" or resetting of the counter within the MultiVOIP software.
Received	integer value	Number of RTP packets received by this VOIP gateway since the last "clearing" or resetting of the counter within the MultiVOIP software.
Received with Errors	integer value	Number of error-laden RTP packets received by this VOIP gateway since the last "clearing" or resetting of the counter within the MultiVOIP software.
RTCP Packets		Realtime Transport Control Protocol packets convey control information to assist in the transmission of RTP (voice) packets. RTCP packets are a type or subset of UDP packets.
Transmitted	integer value	Number of RTCP packets transmitted by this VOIP gateway since the last "clearing" or resetting of the counter within the MultiVOIP software.
Received	integer value	Number of RTCP packets received by this VOIP gateway since the last "clearing" or resetting of the counter within the MultiVOIP software.
Received with Errors	integer value	Number of error-laden RTCP packets received by this VOIP gateway since the last "clearing" or resetting of the counter within the MultiVOIP software.

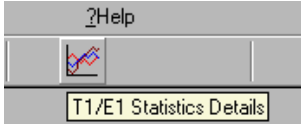
About T1/E1 Statistics

Accessing T1 Statistics	
Pulldown	Icon
	
Shortcut	Sidebar
<p>Alt + T</p>	

The T1 and E1 Statistics screens are only accessible and applicable for the MVP2400, MVP2410, and MVP3010.

T1 Statistics Screen

T1 Statistics

Red Alarm:	<input type="text" value="0"/>	Yellow Alarm:	<input type="text" value="0"/>	<input type="button" value="Clear"/> <input type="button" value="Exit"/> <input type="button" value="Help"/>
Blue Alarm:	<input type="text" value="0"/>	Frame Search Restart Flag:	<input type="text" value="0"/>	
Loss of Frame Alignment:	<input type="text" value="0"/>	Loss of MultiFrame Alignment:	<input type="text" value="0"/>	
Excessive Zeros:	<input type="text" value="0"/>	Transmit Slip:	<input type="text" value="0"/>	
Status Freeze Signalling Active:	<input type="text" value="0"/>	Pulse Density Violation:	<input type="text" value="0"/>	
Line Loopback Deactivation Signal:	<input type="text" value="0"/>	Line Loopback Activation Signal:	<input type="text" value="0"/>	
Transmit Line Short:	<input type="text" value="0"/>	Transmit Line Open:	<input type="text" value="0"/>	
Transmit Data Overflow:	<input type="text" value="0"/>	Transmit Data Underrun:	<input type="text" value="0"/>	
Transmit Slip Positive:	<input type="text" value="0"/>	Transmit Slip Negative:	<input type="text" value="0"/>	

T1 Statistics: Field Definitions		
Field Name	Values	Description
Red Alarm	Integer tally of alarms counted since last reset.	The alarm condition declared when a device receives no signal or cannot synchronize to the signal being received. A Red Alarm is generated if the incoming data stream has no transitions for 176 consecutive pulse positions.
Blue Alarm	Tally since last reset.	Alarm signal consisting of all 1's (including framing bit positions) which indicates disconnection or failure of attached equipment.
Loss of Frame Alignment	Tally since last reset.	Loss of data frame synchronization.
Excessive Zeroes	Tally since last reset.	Displayed value will increment if consecutive zeroes beyond a set threshold are detected. I.e., tally increments if more than 7 consecutive zeroes in the received data stream are detected under B8ZS line coding, or if 15 consecutive zeroes are detected under AMI line coding.
Status Freeze Signalling Active		Signaling has been frozen at the most recent values due to loss of frame alignment, loss of multiframe alignment or due to a receive slip.
Line Loopback Deactivation Signal		Line loopback deactivation signal has been detected in the receive bit stream.
Transmit Line Short		A short exists between the transmit pair for at least 32 consecutive pulses.
Transmit Data Overflow		For use by MTS Technical Support personnel.
Transmit Slip Positive		The frequency of the transmit clock is less than the frequency of the transmit system interface working clock. A frame is repeated.

T1 Statistics: Field Definitions (cont'd)		
Field Name	Values	Description
Yellow Alarm	Tally since last reset.	The alarm signal sent by a remote T1/E1 device to indicate that it sees no receive signal or cannot synchronize on the receive signal.
Frame Search Restart Flag		[To be supplied.]
Loss of MultiFrame Alignment	Tally since last reset.	In D4 or ESF mode, displayed value will increment if multiframe alignment has been lost or if loss of frame alignment has been detected.
Transmit Slip	Tally since last reset.	Slip in transmitted data stream. Slips indicate a clocking mismatch (or lack of synchronization) between T1/E1 devices. When slips occur, data may be lost or repeated.
Pulse Density Violation		The pulse density of the received data stream is below the requirement defined by ANSI T1.403 or more than 15 consecutive zeros are detected.
Line Loopback Activation Signal		The line loopback activation signal has been detected in the received bit stream.
Transmit Line Open		At least 32 consecutive zeros were transmitted.
Transmit Data Underrun		For use by MTS Technical Support Personnel.
Transmit Slip Negative		The frequency of the transmit clock is greater than the frequency of the transmit system interface working clock. A frame is skipped.

T1 Statistics: Field Definitions (cont'd)		
Field Name	Values	Description
Bipolar Violation	Integer tally of violation count since last reset.	Two successive pulses of the same polarity have been received and these pulses are not part of zero substitution. On an AMI-encoded line, this represents a line error. On a B8ZS line, this may represent the substitution for a string of 8 zeroes.
Receive Slip	Tally since last reset.	A receive slip (positive or negative) has occurred. Slips indicate a clocking mismatch (or lack of synchronization) between T1/E1 devices. When slips occur, data may be lost or repeated.

E1 Statistics Screen

E1 Statistics

Red Alarm: <input style="width: 80px;" type="text" value="145,388"/>	Yellow Alarm: <input style="width: 80px;" type="text" value="0"/>	<input type="button" value="Clear"/>
Blue Alarm: <input style="width: 80px;" type="text" value="0"/>	Status Freeze Signalling Active: <input style="width: 80px;" type="text" value="0"/>	<input type="button" value="Exit"/>
Loss of Frame Alignment: <input style="width: 80px;" type="text" value="145,388"/>	Loss of MultiFrame Alignment: <input style="width: 80px;" type="text" value="145,388"/>	<input type="button" value="Help"/>
Receive Timeslot 16 Remote Alarm: <input style="width: 80px;" type="text" value="0"/>	Receive Timeslot 16 Loss of Signal: <input style="width: 80px;" type="text" value="0"/>	
Receive Timeslot 16 Alarm Indication Signal: <input style="width: 80px;" type="text" value="0"/>	Receive Timeslot 16 Loss of Multiframe Alignment: <input style="width: 80px;" type="text" value="145,388"/>	
Transmit Line Short: <input style="width: 80px;" type="text" value="0"/>	Transmit Line Open: <input style="width: 80px;" type="text" value="0"/>	
Transmit Data Overflow: <input style="width: 80px;" type="text" value="0"/>	Transmit Data Underrun: <input style="width: 80px;" type="text" value="0"/>	
Transmit Slip Positive: <input style="width: 80px;" type="text" value="145,388"/>	Transmit Slip Negative: <input style="width: 80px;" type="text" value="145,388"/>	

E1 Statistics: Field Definitions		
Field Name	Values	Description
Red Alarm	Integer tally of alarms counted since last reset.	The alarm condition declared when a device receives no signal or cannot synchronize to the signal being received. A Red Alarm is generated if the incoming data stream has no transitions for 176 consecutive pulse positions.
Blue Alarm	Tally since last reset.	Alarm signal consisting of all 1's (including framing bit positions) which indicates disconnection or failure of attached equipment.
Loss of Frame Alignment	Tally since last reset.	Loss of data frame synchronization.

E1 Statistics: Field Definitions (cont'd)		
Field Name	Values	Description
Receive Timeslot 16 Alarm Indication Signal		Detected alarm indication signal in timeslot 16 according to ITU-T G.775. Indicates the incoming time slot 16 contains less than 4 zeros in each of two consecutive time slot 16 multiframe periods.
Transmit Line Short		A short exists between the transmit pair for at least 32 consecutive pulses.
Transmit Data Overflow		For use by MTS personnel.
Transmit Slip Positive		The frequency of the transmit clock is less than the frequency of the transmit system interface working clock. A frame is repeated.
Yellow Alarm	Tally since last reset.	The alarm signal sent by a remote T1/E1 device to indicate that it sees no receive signal or cannot synchronize on the receive signal.
Status Freeze Signalling Active		Signaling has been frozen at the most recent values due to loss of frame alignment, loss of multiframe alignment or due to a receive slip.
Loss of MultiFrame Alignment	Tally since last reset.	In D4 or ESF mode, displayed value will increment if multiframe alignment has been lost or if loss of frame alignment has been detected.
Receive Timeslot 16 Loss of Signal		The time slot 16 data stream contains all zeros for at least 16 contiguously received time slots.

E1 Statistics: Field Definitions (cont'd)		
Field Name	Values	Description
Receive Timeslot 16 Loss of MultiFrame Alignment		The framing pattern '0000' in 2 consecutive CAS multiframes were not found or in all time slot 16 of the previous multiframe all bits were reset.
Transmit Line Open		At least 32 consecutive zeroes were transmitted.
Transmit Data Underrun		For use by MTS Technical Support Personnel.
Transmit Slip Negative		The frequency of the transmit clock is greater than the frequency of the transmit system interface working clock. A frame is skipped.
Bipolar Violation	Integer tally of violation count since last reset.	Bipolar Violation (or BPV) refers to two successive pulses of the same polarity on the E1 line. On an AMI-encoded line, this represents a line error. On a B8ZS line, this may represent the substitution for a string of 8 zeroes.
Excessive Zeroes	Tally since last reset.	Displayed value will increment if consecutive zeroes beyond a set threshold are detected. I.e., tally increments if more than 7 consecutive zeroes in the received data stream are detected under B8ZS line coding, or if 15 consecutive zeroes are detected under AMI line coding.
Transmit Slip	Tally since last reset.	Slip in transmitted data stream. Slips indicate a clocking mismatch (or lack of synchronization) between T1/E1 devices. When slips occur, data may be lost or repeated.
Receive Slip	Tally since last reset.	Slip in received data stream. Slips indicate a clocking mismatch (or lack of synchronization) between T1/E1 devices. When slips occur, data may be lost or repeated.

MultiVoip Program Menu Items

After the MultiVoip program is installed on the PC, it can be launched from the **Programs** group of the Windows **Start** menu (**Start** | **Programs** | **MultiVOIP** ____ | ...). In this section, we describe the software functions available on this menu.

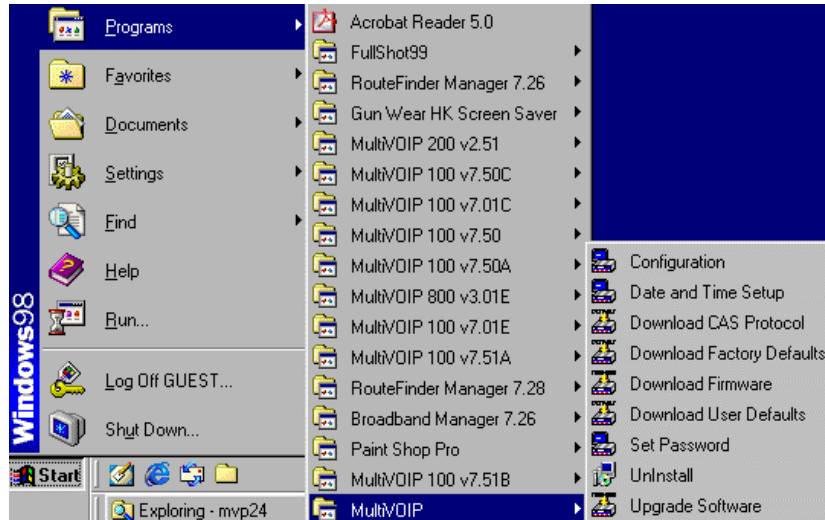

Several basic software functions are accessible from the MultiVoip software menu, as shown below.

MultiVOIP Program Menu	
Menu Selection	Description
Configuration	Select this to enter the Configuration program where values for IP, telephony, and other parameters are set.
Date and Time Setup	Select this for access to set calendar/clock used for data logging.
Download CAS Protocol	Telephony CAS files are for Channel Associated Signalling. There are many CAS files, some labeled for specific functionality, others for countries or regions where certain telephony attributes are standard.

MultiVOIP Program Menu (cont'd)	
Menu Selection	Description
Download Factory Defaults	Select this to return the configuration parameters to the original factory values.
Download Firmware	Select this to download new versions of firmware as enhancements become available.
Download User Defaults	To be used after a full set of parameter values, values specified by the user, have been saved (using Save Setup). This command loads the saved user defaults into the MultiVOIP.
Set Password	Select this to create a password for access to the MultiVOIP software programs (Program group commands, Windows GUI, web browser GUI, & FTP server). Only the FTP Server function <i>requires</i> a password for access. The FTP Server function also requires that a UserName be established along with the password.
Uninstall	Select this to uninstall the MultiVOIP software (most, but not all components are removed from computer when this command is invoked).
Upgrade Software	Loads firmware (including H.323 stack) and factory default settings from the controller PC to the MultiVOIP unit.

“Downloading” here refers to transferring program files from the PC to the nonvolatile “flash” memory of the MultiVOIP. Such transfers are made via the PC’s serial port. This can be understood as a “download” from the perspective of the MultiVOIP unit.

When new versions of the MultiVoip software become available, they will be posted on MultiTech’s web or FTP sites. Although transferring updated program files from the MultiTech web/FTP site to the user’s PC can generally be considered a download (from the perspective of the PC), this type of download cannot be initiated from the MultiVoip software’s Program menu command set.

Generally, updated firmware must be downloaded from the MultiTech web/FTP site to the PC before it can be loaded from the PC to the MultiVOIP.

Date and Time Setup

The dialog box below allows you to set the time and date indicators of the MultiVOIP system.

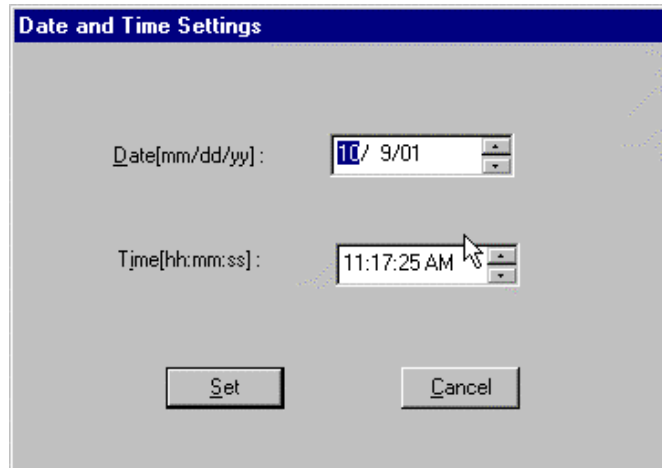

Obtaining Updated Firmware

Generally, updated firmware must be downloaded from the MultiTech web/FTP site to the user's PC before it can be downloaded from that PC to the MultiVOIP.

Note that the structure of the MultiTech web/FTP site may change without notice. However, firmware updates can generally be found using standard web techniques. For example, you can access updated firmware by doing a search or by clicking on **Support**.



If you conduct a search, for example, on the word “MultiVoip,” you will be directed to a list of firmware that can be downloaded.

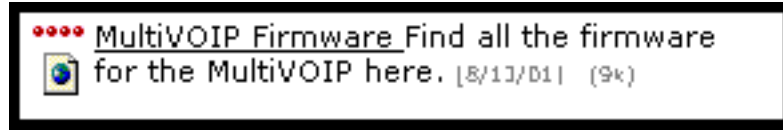

If you choose **Support**, you can select “MultiVoip” in the **Product Support** menu and then click on **Firmware** to find MultiVOIP resources.



Once the updated firmware has been located, it can be downloaded from the web/ftp site using normal PC/Windows procedures. While the next 3 screens below pertain to the MVP3010, similar screens will appear for any MultiVOIP model described in this manual.

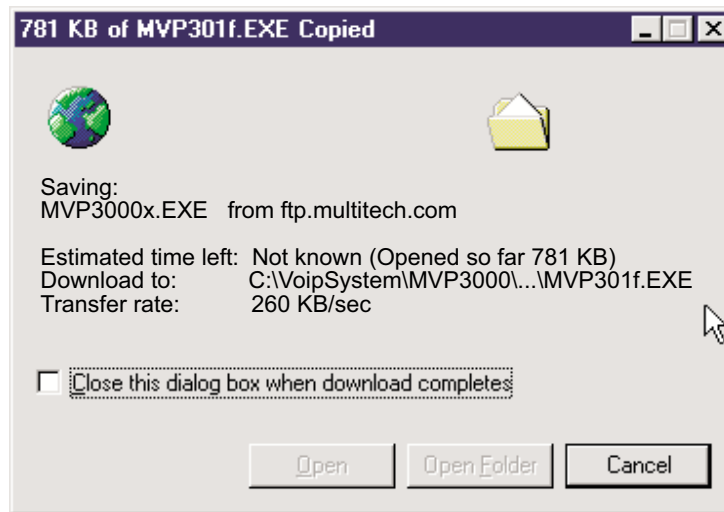
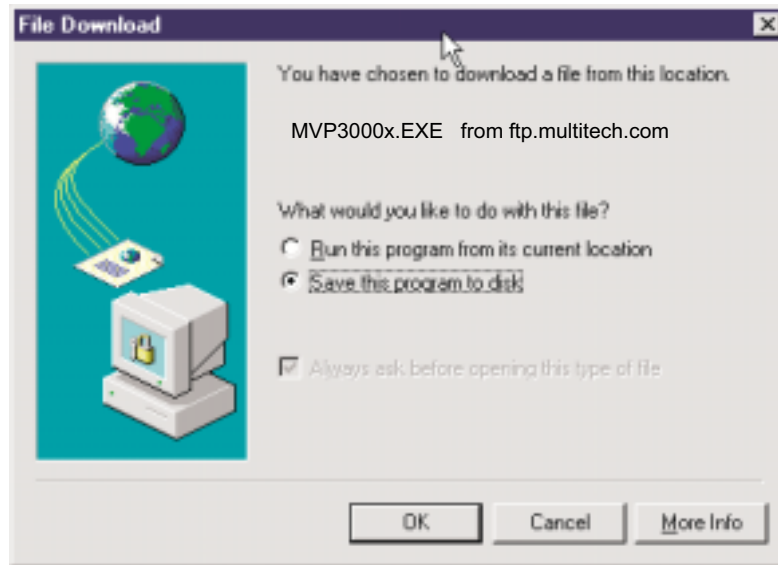

Generally, the firmware file will be a self-extracting compressed file (with .zip extension), which must be expanded (decompressed, or “unzipped”) on the user’s PC in a user-specified directory.

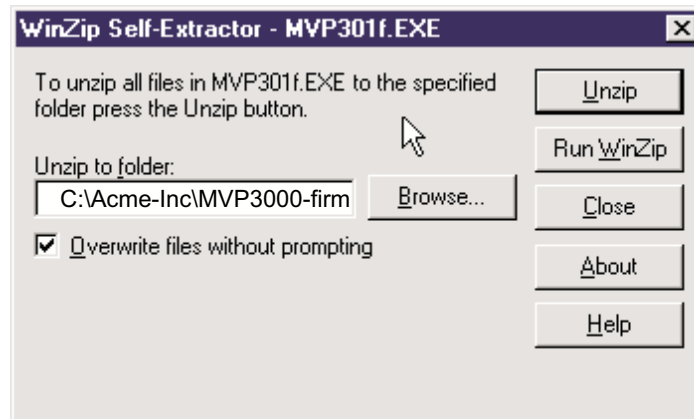

Implementing a Software Upgrade

Beginning with the 4.03/6.03 software release, MultiVOIP software can be upgraded locally using a single command at the MultiVOIP Windows GUI, namely **Upgrade Software**. This command downloads firmware (including the H.323 stack), and factory default settings from the controller PC to the MultiVOIP unit.

When using the MultiVOIP Windows GUI, firmware and factory default settings can also be transferred from controller PC to MultiVOIP piecemeal using separate commands.

When using the MultiVOIP web browser GUI to control/configure the voip remotely, upgrading of software must be done on a piecemeal basis using the FTP Server function of the MultiVOIP unit.

When performing a piecemeal software upgrade (whether from the Windows GUI or web browser GUI), follow these steps in order:

1. Identify Current Firmware Version
2. Download Firmware
3. Download Factory Defaults

When upgrading firmware, the software commands “Download Firmware,” and “Download Factory Defaults” must be implemented in order, else the upgrade is incomplete.

Identifying Current Firmware Version

Before implementing a MultiVOIP firmware upgrade, be sure to verify the firmware version currently loaded on it. The firmware version appears in the MultiVoip Program menu. Go to **Start | Programs | MultiVOIP ____ x.xx**. The final expression, x.xx, is the firmware version number. In the illustration below, the firmware version is 4.00a, made for the E1 MultiVOIP (MVP3010).



When a new firmware version is installed, the MultiVOIP software can be upgraded in one step using the **Upgrade Software** command, or piecemeal using the **Download Firmware** command and the **Download Factory Defaults** command.

Download Firmware transfers the firmware (including the H.323 protocol stack) in the PC's MultiVOIP directory into the nonvolatile flash memory of the MultiVOIP.

Download Factory Defaults sets all configuration parameters to the standard default values that are loaded at the MultiTech factory.

Upgrade Software implements both the **Download Firmware** command and the **Download Factory Defaults** command.

Downloading Firmware

1. The MultiVoip Configuration program must be off when invoking the **Download Firmware** command. If it is on, the command will not work.
2. To invoke the Download Factory Defaults command, go to **Start | Programs | MVP____ x.xx | Download Firmware**.

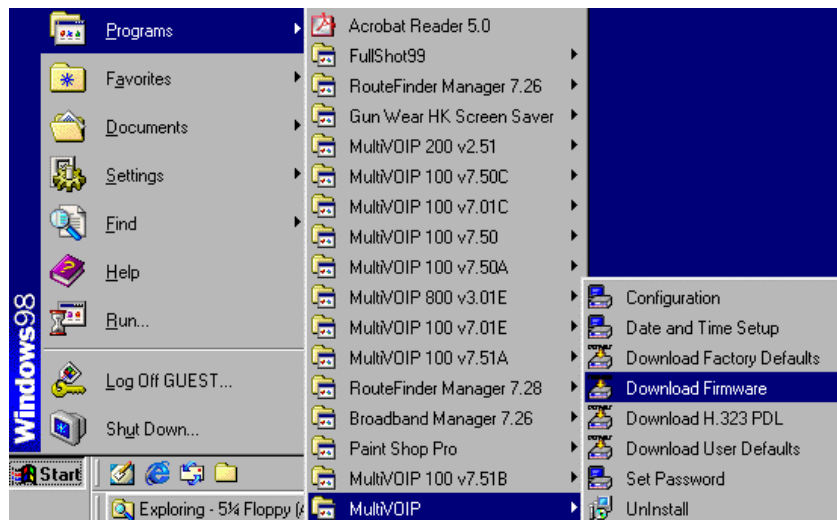

3. If a password has been established, the **Password Verification** screen will appear.

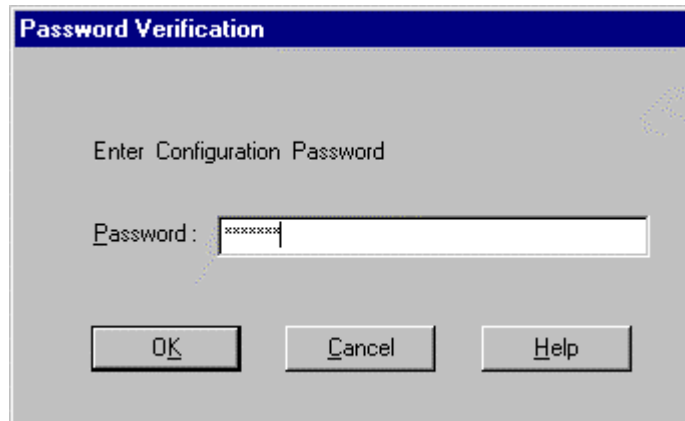

Type in the password and click **OK**.

4. The **MultiVOIP ___ - Firmware** screen appears saying "MultiVOIP [*model number*] is up. Reboot to Download Firmware?"

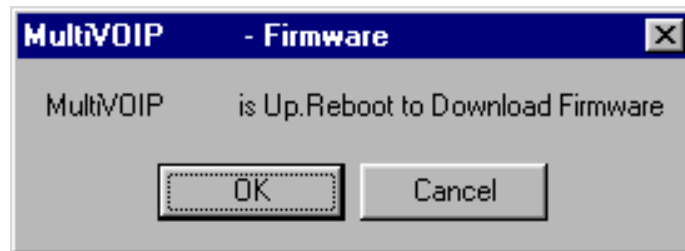

Click **OK** to download the firmware.

The "Boot" LED on the MultiVOIP will light up and remain lit during the file transfer process.

- The program will locate the firmware “.bin” file in the MultiVOIP directory. Highlight the correct (newest) “.bin” file and click **Open**.

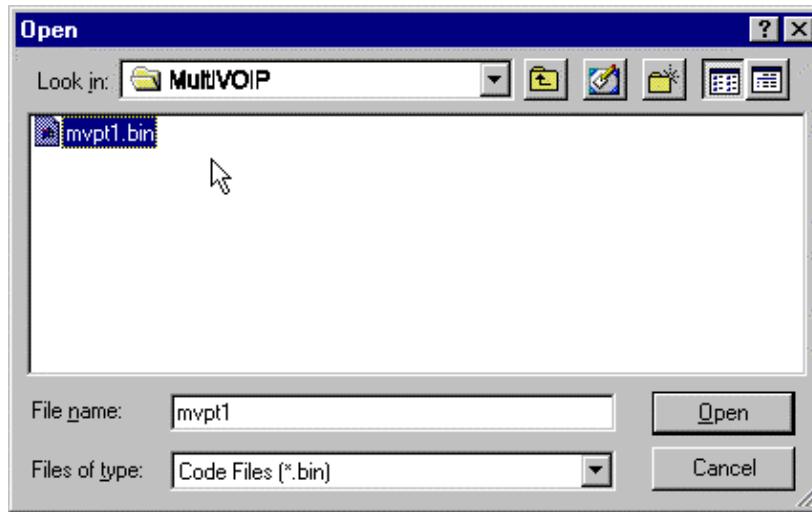

- Progress bars will appear at the bottom of the screen during the file transfer.

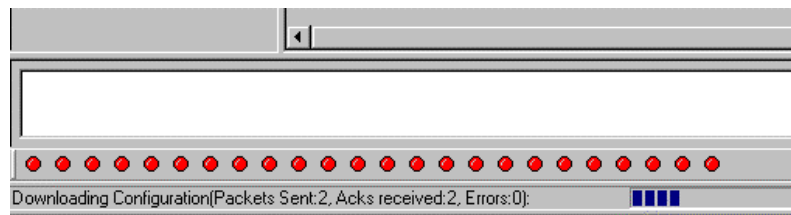

The MultiVOIP's "Boot" LED will turn off at the end of the transfer.

- The **Download Firmware** procedure is complete.

Downloading CAS Protocol

1. The MultiVoip Configuration program must be off when invoking the **Download CAS Protocol** command. If it is on, the command will not work.
2. To invoke the **Download H.323 PDL** command, go to **Start | Programs | MVP___ x.xx | Download H.323 PDL**.

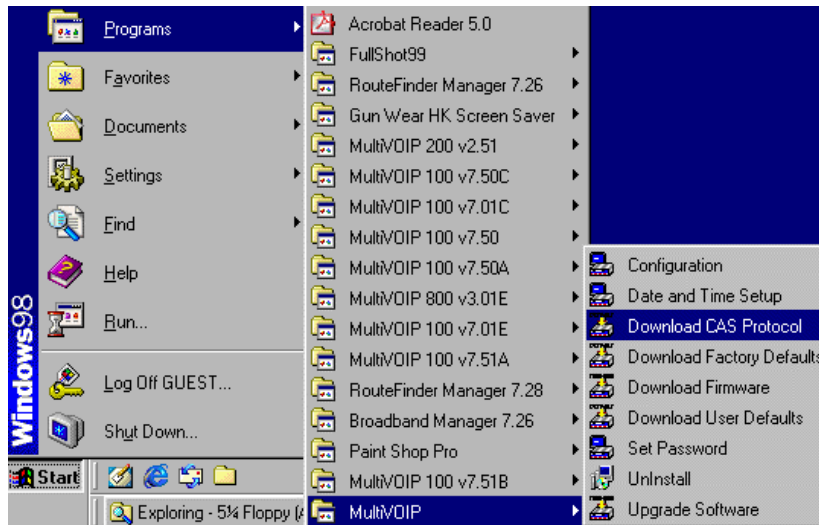

3. If a password has been established, the **Password Verification** screen will appear.

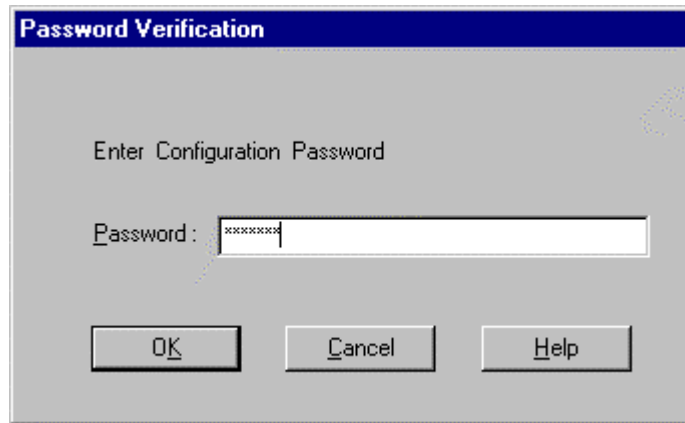

Type in password and click **OK**.

4. The **MultiVOIP ____ - Firmware** screen appears saying "MultiVOIP [model number] is up. Reboot to Download Firmware?"

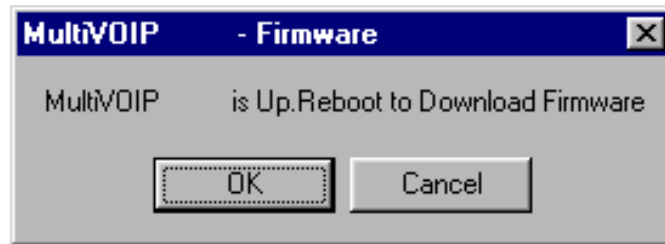

Click **OK** to download the CAS Protocol file(s) to the MultiVOIP.

The "Boot" LED on the MultiVOIP will light up and remain lit during the file transfer process.

5. The program will locate the CAS protocol file in the MultiVOIP directory. Highlight the correct (newest) file and click **Open**.
6. Progress bars will appear at the bottom of the screen during the file transfer.

The MultiVOIP's "Boot" LED will turn off at the end of the transfer.
7. The **Download CAS Protocol** procedure is complete.

Downloading Factory Defaults

1. The MultiVoip Configuration program must be off when invoking the **Download Factory Defaults** command. If it is on, the command will not work.
2. To invoke the **Download Factory Defaults** command, go to **Start | Programs | MVP ____ x.xx | Download Factory Defaults**.

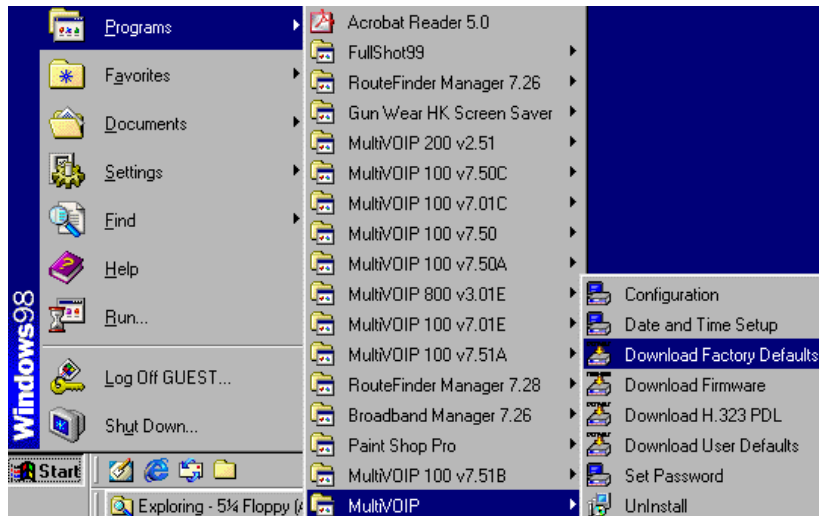

3. If a password has been established, the **Password Verification** screen will appear.

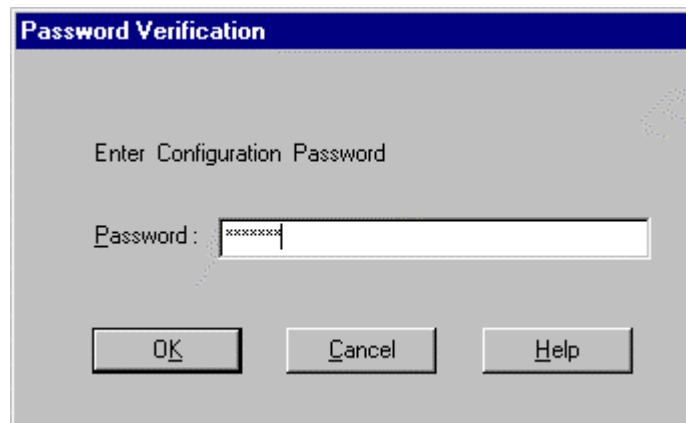

Type in the password and click **OK**.

4. The **MVP_____ - Firmware** screen appears saying “MultiVOIP [model number] is up. Reboot to Download Firmware?”

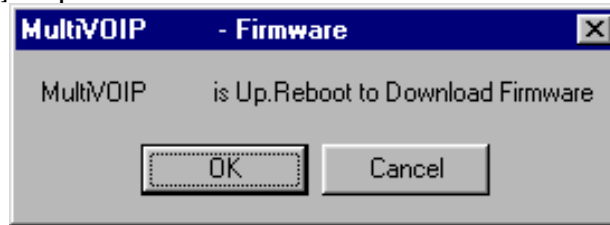

Click **OK** to download the factory defaults.

The “Boot” LED on the MultiVOIP will light up and remain lit during the file transfer process.

5. After the PC gets a response from the MultiVOIP, the **Dialog - IP Parameters** screen will appear.

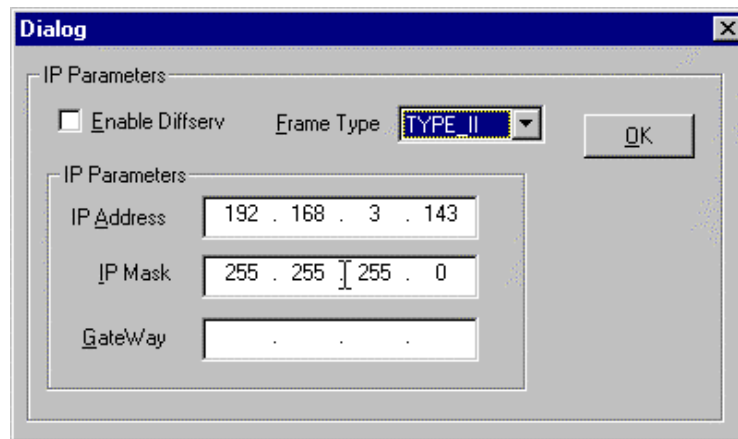

The user should verify that the correct IP parameter values are listed on the screen and revise them if necessary. Then click **OK**.

6. Progress bars will appear at the bottom of the screen during the data transfer.

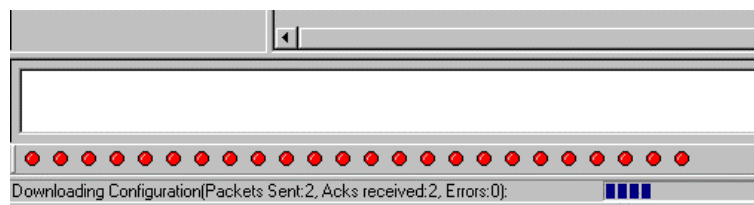

The MultiVOIP’s “Boot” LED will turn off at the end of the transfer.

7. The **Download Factory Defaults** procedure is complete.

Setting and Downloading User Defaults

The **Download User Defaults** command allows you to maintain a known working configuration that is specific to your VOIP system. You can then experiment with alterations or improvements to the configurations confident that a working configuration can be restored if necessary.

1. Before you can invoke the Download User Defaults command, you must first save a set of configuration parameters by using the **Save Setup** command in the sidebar menu of the MultiVOIP software.



2. Before the setup configuration is saved, you will be prompted to save the setup as the User Default Configuration. Select the checkbox and click **OK**.

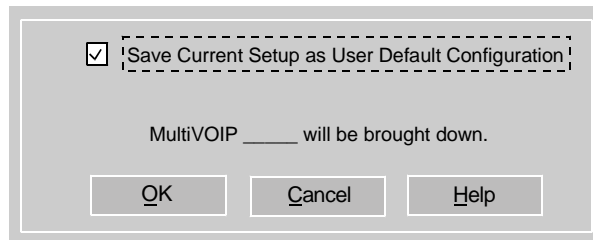

A user default file will be created.

3. The **MVP_____ - Firmware** screen appears saying “MultiVOIP [*model number*] is up. Reboot to Download Firmware?”

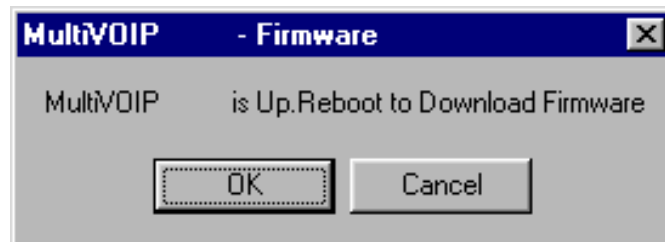

Click **OK** to download the factory defaults. The “Boot” LED on the MultiVOIP will light up and remain lit during the file transfer process.

4. Progress bars will appear during the file transfer process.

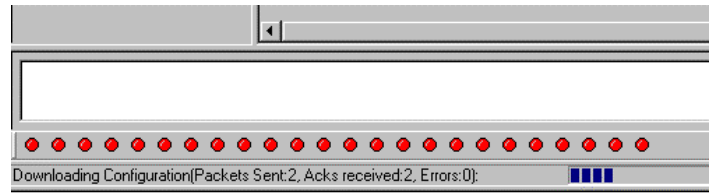

5. When the file transfer process is complete, the **Dialog-- IP Parameters** screen will appear.

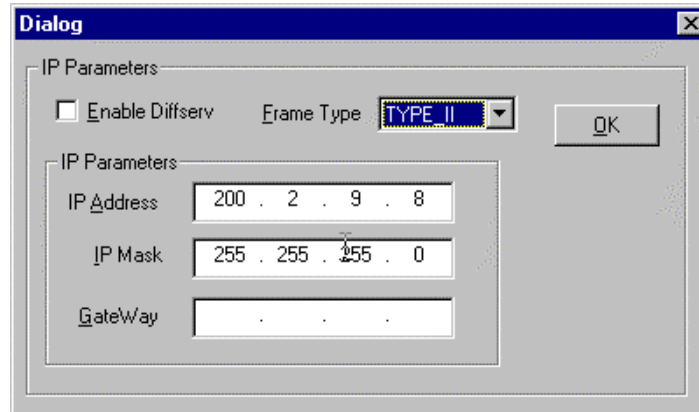

6. Set the IP values per your particular VOIP system. Click **OK**. Progress bars will appear as the MultiVOIP reboots itself.

Setting a Password (Windows GUI)

After a user name has been designated and a password has been set, that password is required to gain access to any functionality of the MultiVOIP software. Only one user name and password can be assigned to a voip unit. The user name will be required when communicating with the MultiVOIP via the web browser GUI.

NOTE: Record your user name and password in a safe place. If the password is lost, forgotten, or unretrievable, the user must contact MultiTech Tech Support in order to resume use of the MultiVOIP unit.

1. The MultiVoip configuration program must be off when invoking the **Set Password** command. If it is on, the command will not work.
2. To invoke the **Set Password** command, go to **Start | Programs | MVP___ x.xx | Set Password**.

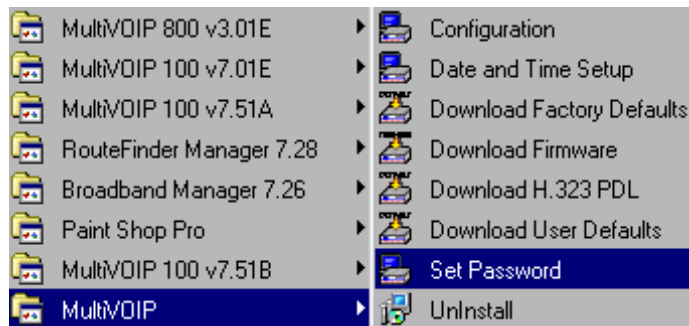

3. You will be prompted to confirm that you want to establish a password, which will entail rebooting the MultiVOIP (which is done automatically).

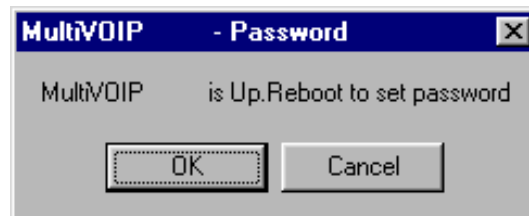

Click **OK** to proceed with establishing a password.

- The **Password** screen will appear. If you intend to use the FTP Server function that is built into the MultiVOIP, enter a user name. (A User Name is not needed to access the local Windows GUI, the web browser GUI, or the commands in the **Program** group.) Type your password in the **Password** field of the **Password** screen. Type this same password again in the **Confirm Password** field to verify the password you have chosen.

NOTE: Be sure to write down your password in a convenient but secure place. If the password is forgotten, contact MultiTech Technical Support for advice.

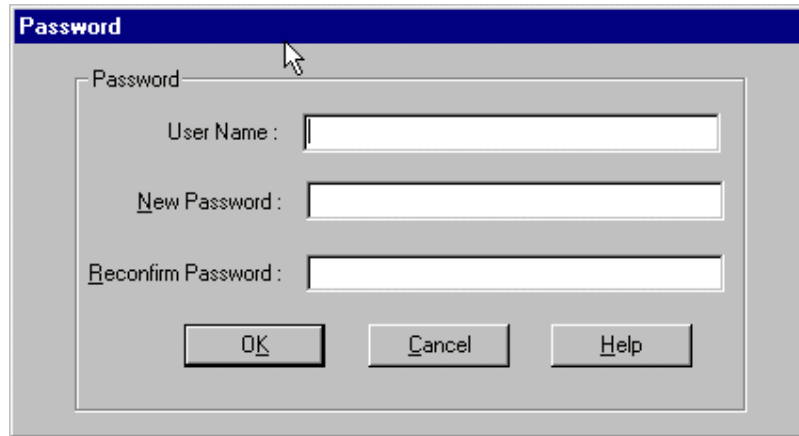

Click **OK**.

- A message will appear indicating that a password has been set successfully.

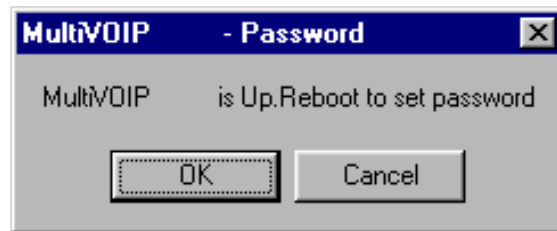

After the password has been set successfully, the MultiVOIP will reboot itself and, in so doing, its **BOOT** LED will light up.

6. After the password has been set, the user will be required to enter the password to gain access to the web browser GUI and any part of the MultiVOIP software listed in the **Program** group menu. User Name and Password are both needed for access to the FTP Server residing in the MultiVOIP.

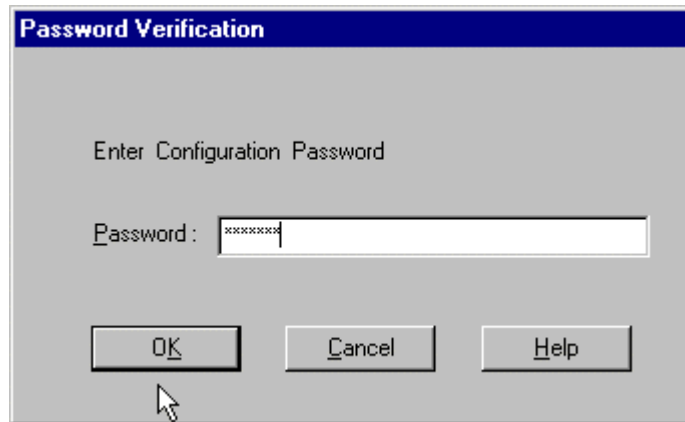

When MultiVOIP program asks for password at launch of program, the program will simply shut down if **CANCEL** is selected.

The MultiVOIP program will produce an error message if an invalid password is entered.



Setting a Password (Web Browser GUI)

Setting a password is optional when using the MultiVOIP web browser GUI. Only one password can be assigned and it works for all MultiVOIP software functions (Windows GUI, web browser GUI, FTP server, and all Program menu commands, e.g., Upgrade Software – only the FTP Server function requires a User Name in addition to the password). After a password has been set, that password is required to access the MultiVOIP web browser GUI.

NOTE: Record your user name and password in a safe place. If the password is lost, forgotten, or unretrievable, the user must contact MultiTech Tech Support in order to resume use of the MultiVOIP web browser GUI.

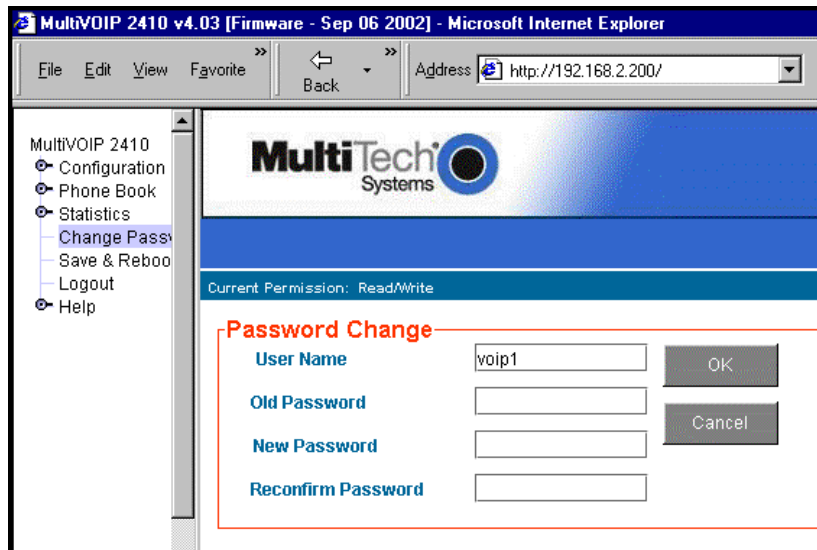

The screenshot shows a Microsoft Internet Explorer browser window displaying the MultiVOIP 2410 v4.03 web browser GUI. The address bar shows the URL <http://192.168.2.200/>. The page features the MultiTech Systems logo and a navigation menu on the left with options: Configuration, Phone Book, Statistics, Change Password, Save & Reboot, Logout, and Help. The main content area displays the "Password Change" form, which includes the following fields and buttons:

- User Name:** A text input field containing "voip1" and an "OK" button.
- Old Password:** A text input field and a "Cancel" button.
- New Password:** A text input field.
- Reconfirm Password:** A text input field.

The current permission is listed as "Read/Write".

Un-Installing the MultiVOIP Software

1. To un-install the MultiVOIP configuration software, go to **Start | Programs** and locate the MultiVOIP entry. Select **Uninstall MVP____vx.xx** (versions may vary).

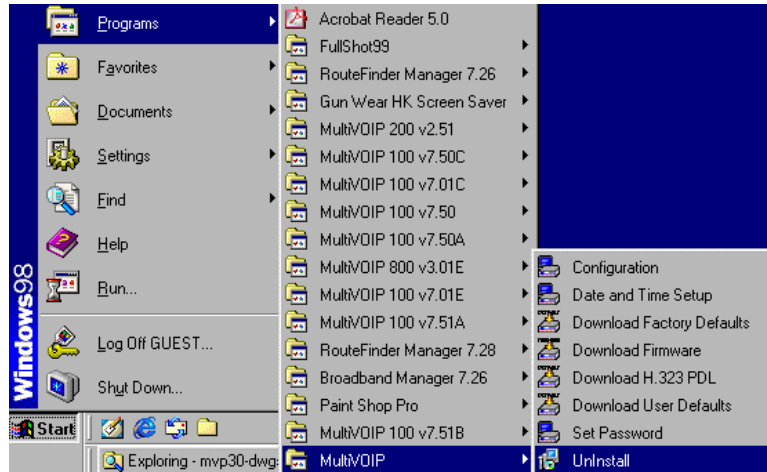

2. Two confirmation screens will appear. Click **Yes** and **OK** when you are certain you want to continue with the uninstallation process.

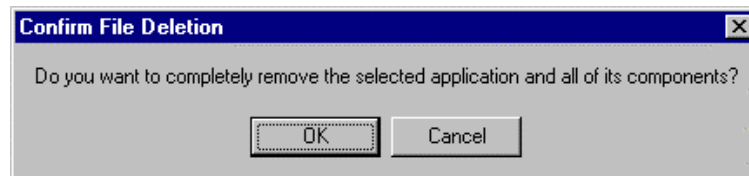
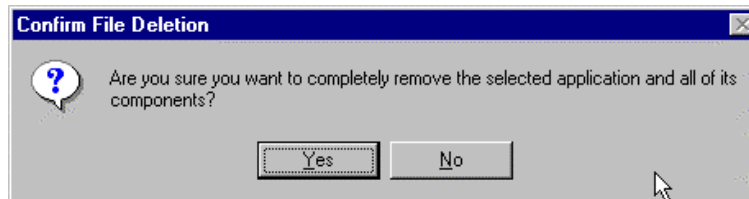

3. A special warning message similar to that shown below may appear for the MultiVOIP software's ".bin" file. Click **Yes**.

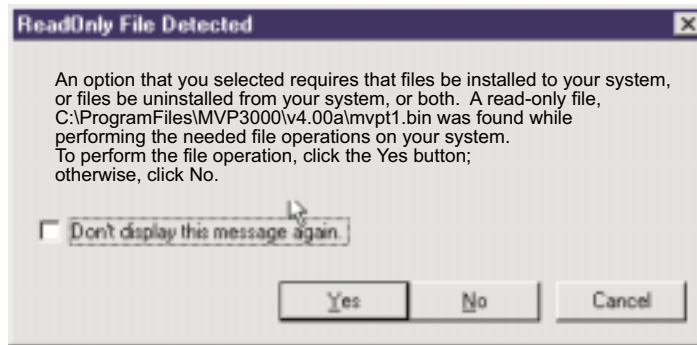

4. A completion screen will appear.



Click **Finish**.

Upgrading Software

As noted earlier (see the section *Implementing a Software Upgrade* above), the Upgrade Software command transfers, from the controller PC to the MultiVOIP unit, firmware (including the H323 stack) and factory default configuration settings. As such, **Upgrade Software** implements the functions of both **Download Firmware** and **Download Factory Defaults** in a single command.

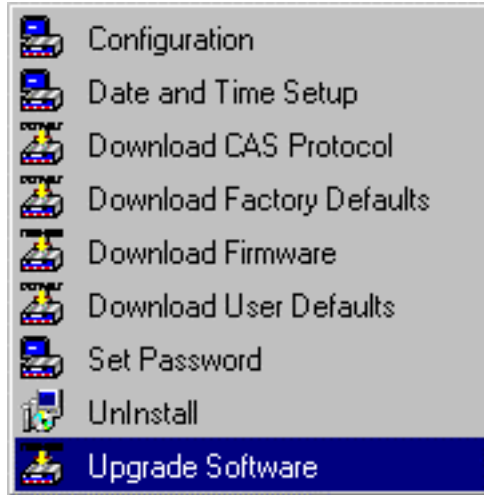

FTP Server File Transfers (“Downloads”)

With the 4.03/6.03 software release, MultiTech has built an FTP server into the MultiVOIP unit. Therefore, file transfers from the controller PC to the voip unit can be done using an FTP client program or even using a browser (e.g., Internet Explorer or Netscape, used in conjunction with Windows Explorer).

The terminology of “downloads” and “uploads” gets a bit confusing in this context. File transfers from a client to a server are typically considered “uploads.” File transfers from a large repository of data to machines with less data capacity are considered “downloads.” In this case, these metaphors are contradictory: the FTP server is actually housed in the MultiVOIP unit, and the controller PC, which is actually the repository of the info to be transferred, uses an FTP client program. In this situation, we have chosen to call the transfer of files from the PC to the voip “downloads.” (Be aware that some FTP client programs may use the opposite terminology, i.e., they may refer to the file transfer as an “upload.”)

You can download firmware, CAS telephony protocols, default configuration parameters, and phonebook data for the MultiVOIP unit with this FTP functionality. These downloads are done over a network, not by a local serial port connection. Consequently, voips at distant locations can be updated from a central control point.

The phonebook downloading feature greatly reduces the data-entry required to establish inbound and outbound phonebooks for the voip units within a system. Although each MultiVOIP unit will require some unique phonebook entries, most will be common to the entire voip system. After the phonebooks for the first few voip units have been compiled, phonebooks for additional voips become much simpler: you copy the common material by downloading and then do data entry for the few phonebook items that are unique to that particular voip unit or voip site.

To transfer files using the FTP server functionality in the MultiVOIP, follow these directions.

1. Establish Network Connection and IP Addresses. Both the controller PC and the MultiVOIP unit(s) must be connected to the same IP network. An IP address must be assigned for each.

IP Address of Control PC	_____ . _____ . _____ . _____
IP Address of voip unit #1	_____ . _____ . _____ . _____
⋮	⋮ ⋮ ⋮ ⋮
IP address of voip unit #n	_____ . _____ . _____ . _____

2. Establish User Name and Password. You must establish a user name and (optionally) a password for contacting the voip over the IP network. (When connection is made via a local serial connection between the PC and the voip unit, no user name is needed.)

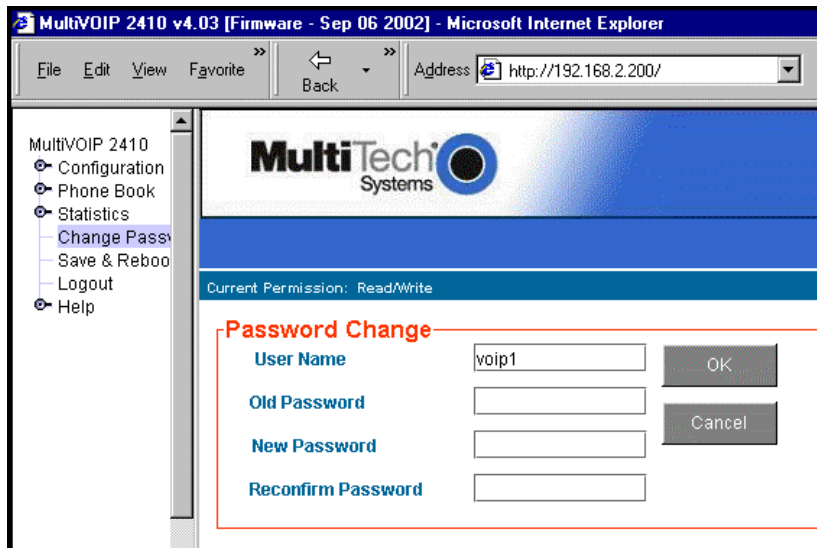

As shown above, the username and password can be set in the web GUI as well as in the Windows GUI.

3. Install FTP Client Program or Use Substitute. You *should* install an FTP client program on the controller PC. FTP file transfers can be done using a web browser (e.g., Netscape or Internet Explorer) in conjunction with a local Windows browser (e.g., Windows Explorer), but this approach is somewhat clumsy (it requires use of two application programs rather than one) and it limits downloading to only one VOIP unit at a time. With an FTP client program, multiple voips can receive FTP file transmissions in response to a single command (the transfers may occur serially however).

Although MultiTech does not provide an FTP client program with the MultiVOIP software or endorse any particular FTP client program, we remind our readers that adequate FTP programs are readily available under retail, shareware and freeware licenses. (Read and observe any End-User License Agreement carefully.) Two examples of this are the “WSFTP” client and the “SmartFTP” client, with the former having an essentially text-based interface and the latter having a more graphically oriented interface, as of this writing. User preferences will vary. Examples here show use of both programs.

4. Enable FTP Functionality. Go to the **IP Parameters** screen and click on the “FTP Server: Enable” box.

IP Parameters

Enable Diffserv Frame Type: TYPE-II

IP Parameters

Enable DHCP

IP Address: 192 . 168 . 2 . 200

IP Mask: 255 . 255 . 255 . 0

Gateway: . . .

DNS

Enable DNS

DNS Server IP Address: . . .

FTP Server

Enable

OK

Cancel

Help

5. Identify Files to be Updated. Determine which files you want to update. Six types of files can be updated using the FTP feature. In some cases, the file to be transferred will have “Ftp” as the part of its filename just before the suffix (or extension). So, for example, the file “mvpt1Ftp.bin” can be transferred to update the bin file (firmware) residing in the MultiVOIP. Similarly, the file “fxo_loopFtp.cas” could be transferred to enable use of the FXO Loop Start telephony interface in one of the analog voip units and the file “r2_brazilFtp.cas” could be transferred to enable a particular telephony protocol used in Brazil.

File Type	File Names	Description
firmware “bin” file	mvpt1Ftp.bin	This is the MultiVOIP firmware file. Only one file of this type will be in the directory.
factory defaults	fdefFtp.cnf	This file contains factory default settings for user-changeable configuration parameters. Only one file of this type will be in the directory.
CAS file	fxo_loopFtp.cas, em_winkFtp.cas, r2_brazilFtp.cas r2_chinaFtp.cas	These telephony files are for Channel Associated Signalling. The directory contains many CAS files, some labeled for specific functionality, others for countries or regions where certain attributes are standard.
H323 PDL file		This file is specific to the particular version of the H.323 standard being used. This file rarely needs to be updated.
inbound phonebook	InPhBk.tmr	This file updates the inbound phonebook in the MultiVOIP unit.
outbound phonebook	OutPhBk.tmr	This file updates the outbound phonebook in the MultiVOIP unit.

6. Contact MultiVOIP FTP Server. You must make contact with the FTP Server in the voip using either a web browser or FTP client program. Enter the IP address of the MultiVOIP's FTP Server. If you are using a browser, the address must be preceded by "ftp://" (otherwise you'll reach the web GUI within the MultiVOIP unit).



7. **Log In.** Use the User Name and password established in item #2 above. The login screens will differ depending on whether the FTP file transfer is to be done with a web browser (see first screen below) or with an FTP client program (see second screen below).

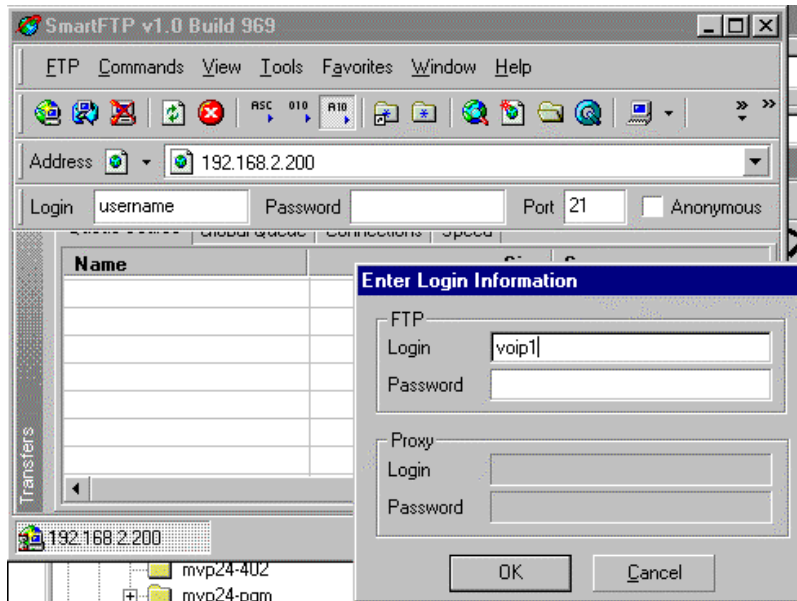
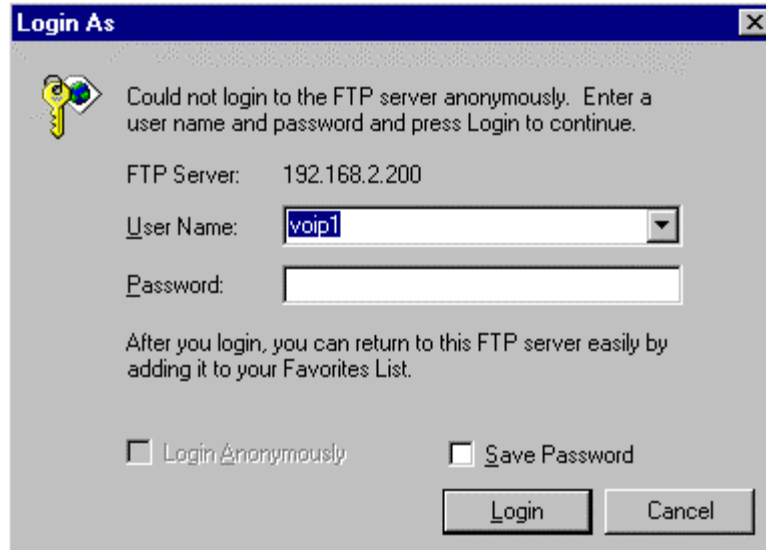

8. Invoke Download. Downloading can be done with a web browser or with an FTP client program.

8A. Download with Web Browser.

8A1. In the local Windows browser, locate the directory holding the MultiVOIP program files. The default location will be C:\Program Files \Multi-Tech Systems \MultiVOIP xxxx yyyy (where x and y represent MultiVOIP model numbers and software version numbers).

8A2. Drag-and-drop files from the local Windows browser (e.g., Windows Explorer) to the web browser.

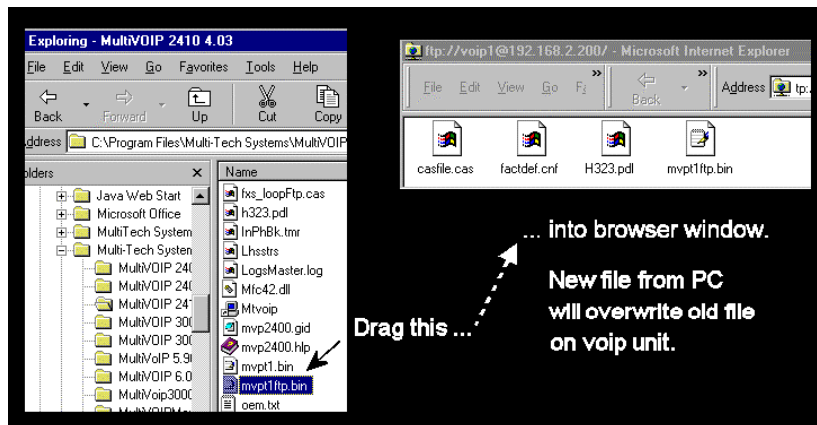

You may be asked to confirm the overwriting of files on the MultiVOIP. Do so.

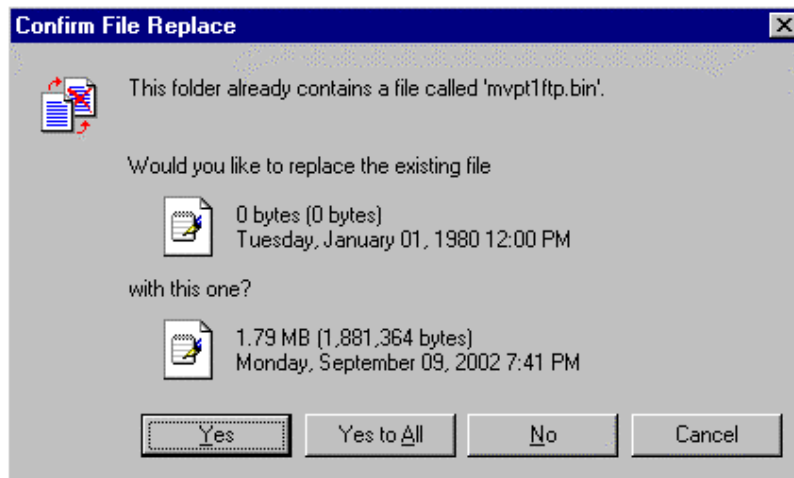

File transfer between PC and voip will look like transfer within voip directories.

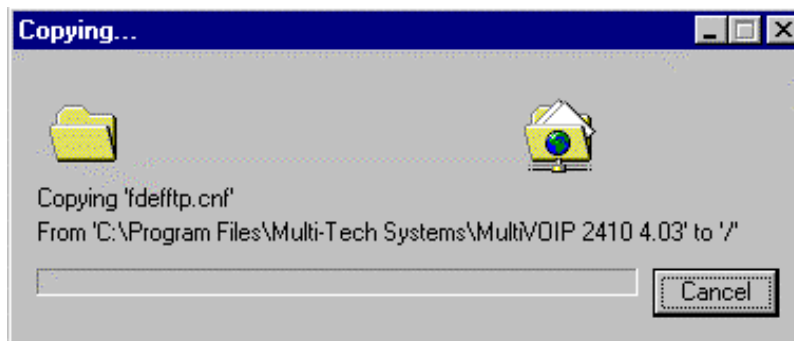

8B. Download with FTP Client Program.

- 8B1.** In the local directory browser of the FTP client program, locate the directory holding the MultiVOIP program files. The default location will be C:\Program Files \Multi-Tech Systems \MultiVOIP xxxx yyyy (where x and y represent MultiVOIP model numbers and software version numbers).
- 8B2.** In the FTP client program window, drag-and-drop files from the local browser pane to the pane for the MultiVOIP FTP server. FTP client GUI operations vary. In some cases, you can choose between immediate and queued transfer. In some cases, there may be automated capabilities to transfer to multiple destinations with a single command.

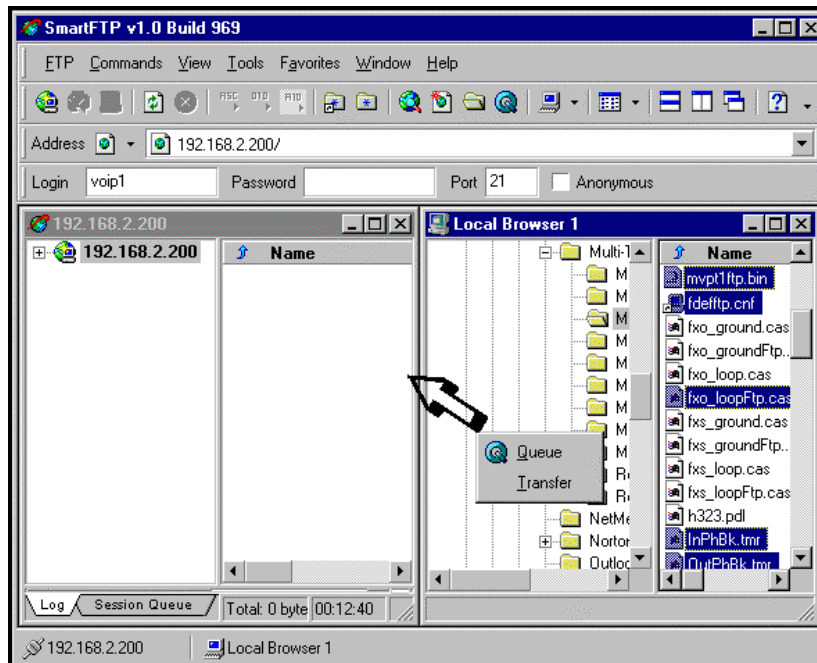

Some FTP client programs are more graphically oriented (see previous screen), while others (like the “WS-FTP” client) are more text oriented.

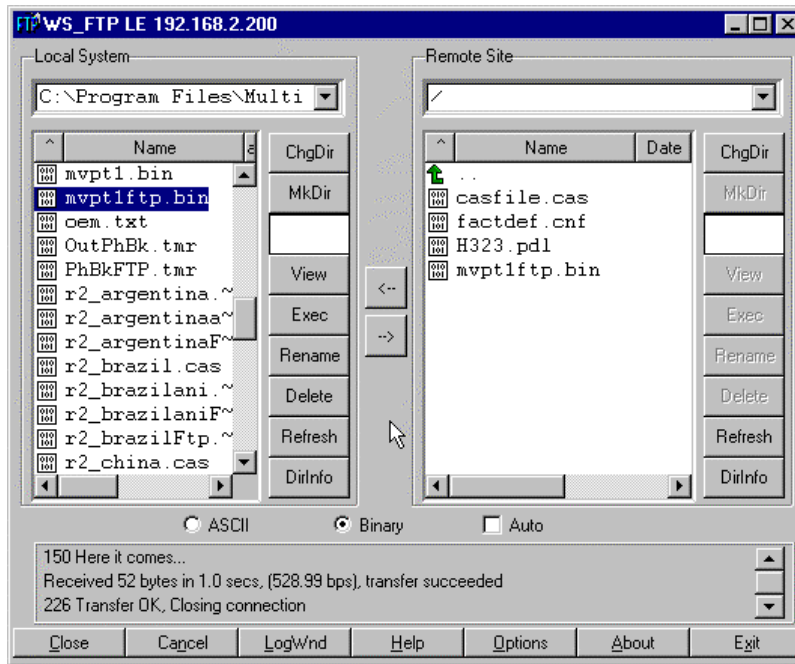

9. Verify Transfer. The files transferred will appear in the directory of the MultiVOIP.

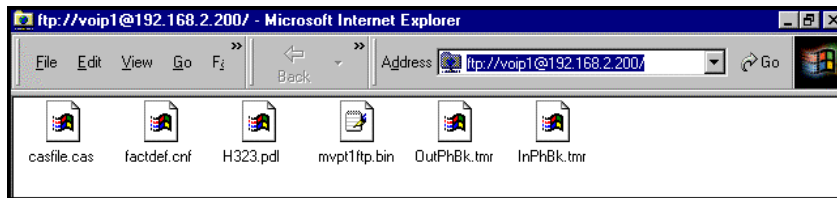

10. Log Out of FTP Session. Whether the file transfer was done with a web browser or with an FTP client program, you *must* log out of the FTP session before opening the MultiVOIP Windows GUI.

Web Browser Interface

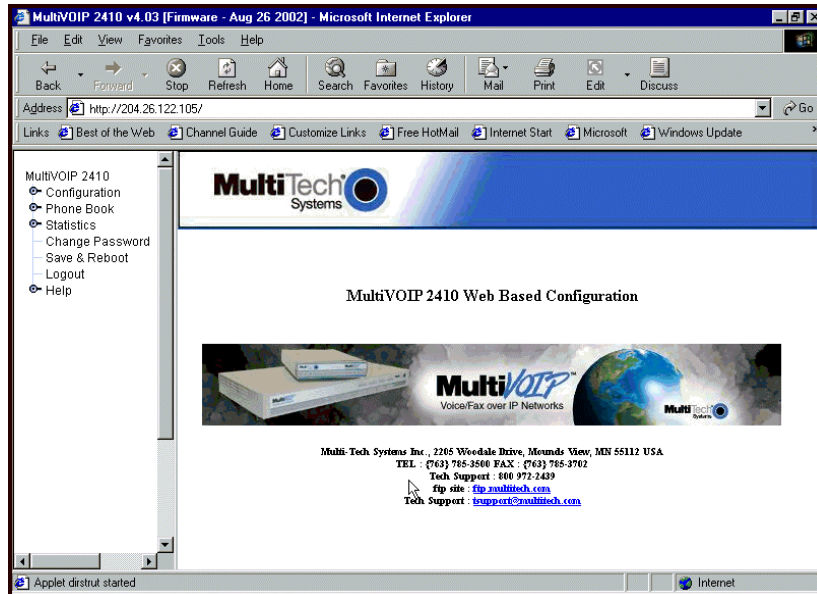

Beginning with the 4.03/6.03 software release, you can control the MultiVOIP unit with a graphic user interface (GUI) based on the common web browser platform. Qualifying browsers are Internet Explorer 6 and Netscape 6.

MultiVOIP Web Browser GUI Overview	
Function	Remote configuration and control of MultiVOIP units.
Configuration Prerequisite	Local Windows GUI must be used to assign IP address to MultiVOIP.
Browser Version Requirement	Internet Explorer 6.0 or higher Netscape 6.0 or higher
Java Requirement	Java Runtime 1.0 or higher (application program included with MultiVOIP)
Video Useability	large video monitor recommended

The initial configuration step of assigning the voip unit an IP address must still be done locally using the Windows GUI. However, all additional configuration can be done via the web GUI.

The content and organization of the web GUI is directly parallel to the Windows GUI. For each screen in the Windows GUI, there is a corresponding screen in the web GUI. The fields on each screen are the same, as well.

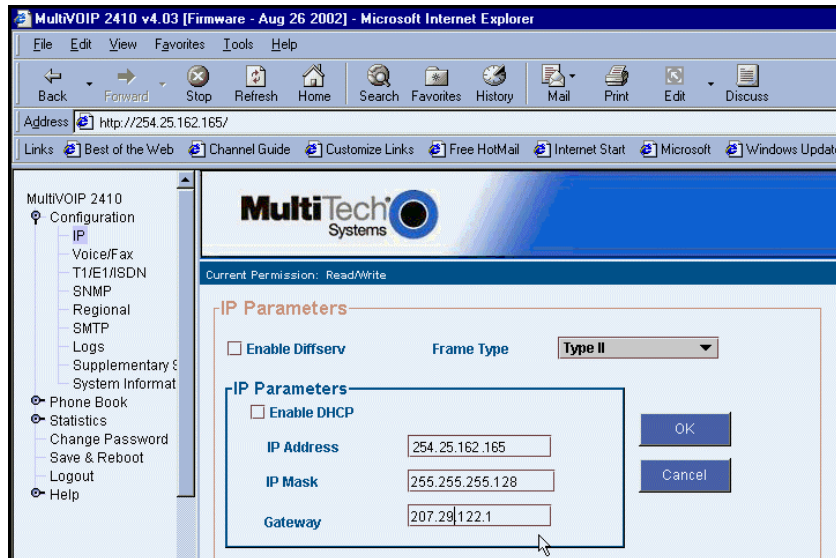

The Windows GUI gives access to commands via icons and pulldown menus whereas the web GUI does not.

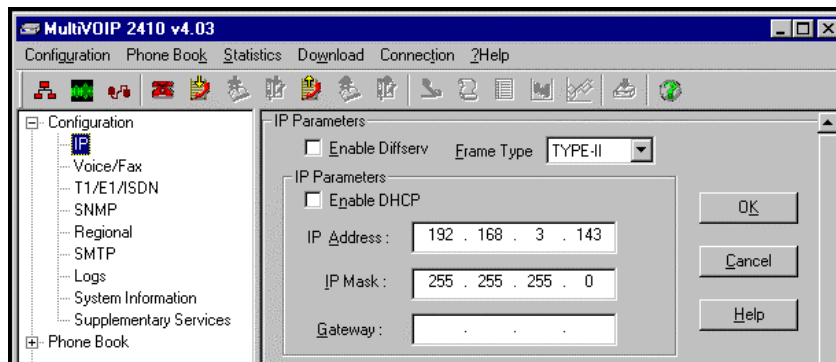

The web GUI, however, cannot perform logging in the same direct mode done in the Windows GUI. However, when the web GUI is used, logging can be done by email (SMTP).

The graphic layout of the web GUI is also somewhat larger-scale than that of the Windows GUI. For that reason, it's helpful to use as large of a video monitor as possible.

The primary advantage of the web GUI is remote access for control and configuration. The controller PC and the MultiVOIP unit itself must both be connected to the same IP network and their IP addresses must be known.

In order to use the web GUI, you must also install a Java application program on the controller PC. This Java program is included on the MultiVOIP product CD. Java is needed to support drop-down menus and multiple windows in the web GUI.

To install the Java program, go to the **Java** directory on the MultiVOIP product CD. Double-click on the EXE file to begin the installation. Follow the instructions on the Install Shield screens.

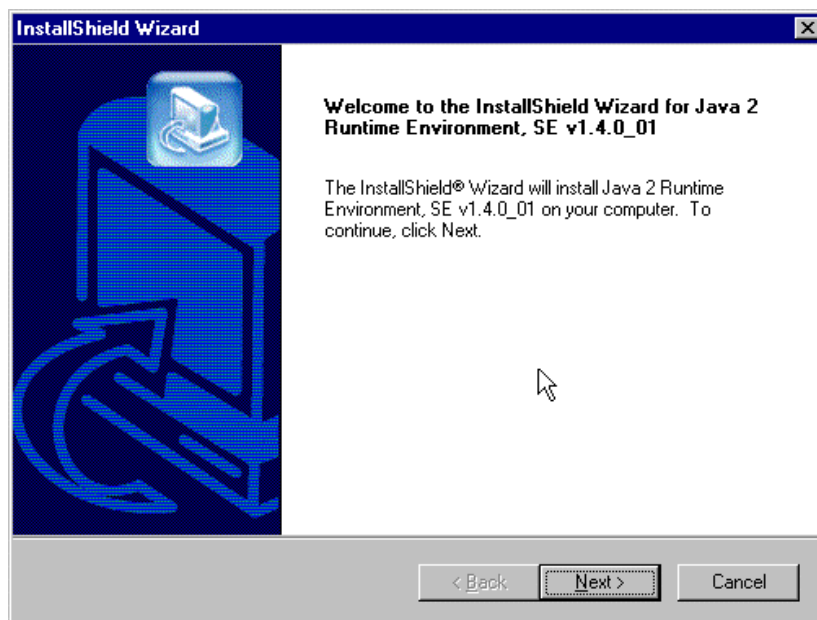

During the installation, you must specify which browser you'll use in the **Select Browsers** screen.

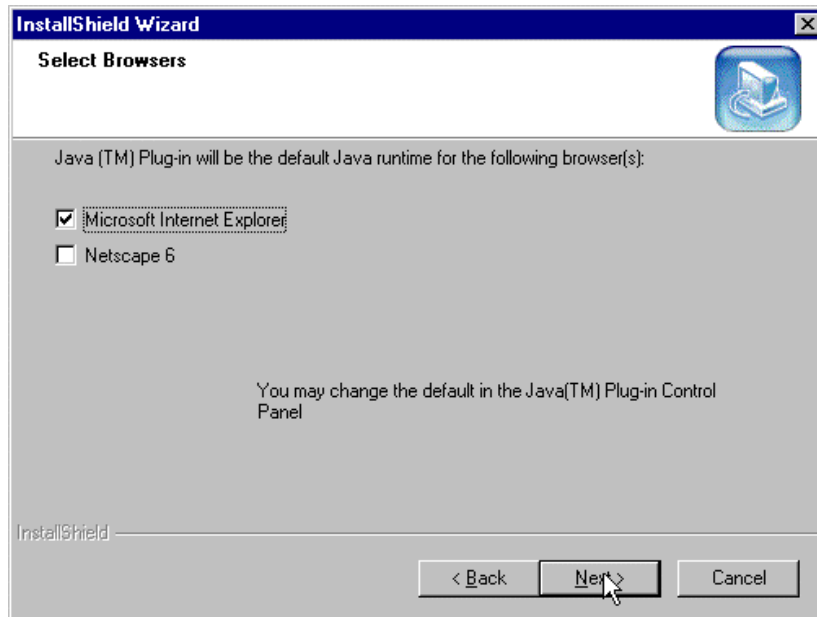

When installation is complete, the Java program becomes accessible in your **Start | Programs** menu (Java resources are readily available via the web). However, the Java program runs automatically in the background as a plug-in supporting the MultiVOIP web GUI. No overt user actions are required.

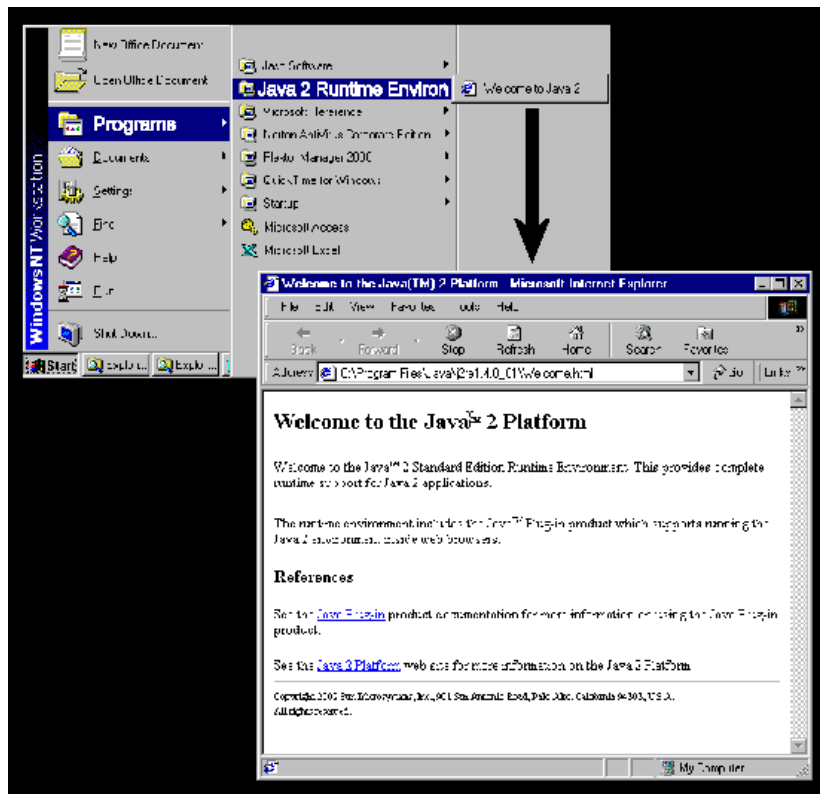

After the Java program has been installed, you can access the MultiVOIP using the web browser GUI. Close the MultiVOIP Windows GUI. Start the web browser. Enter the IP address of the MultiVOIP unit. Enter a password when prompted. (A password is needed here only if password has been set for the local Windows GUI or for the MultiVOIP's FTP Server function. See "Setting a Password -- Web Browser GUI" earlier in this chapter.) The web browser GUI offers essentially the same control over the voip as can be achieved using the Windows GUI. As noted earlier, logging functions cannot be handled via the web GUI. And, because network communications will be slower than direct communications over a serial PC cable, command execution will be somewhat slower over the web browser GUI than with the Windows GUI.

SysLog Server Functions

Beginning with the 4.03/6.03 software release, we have built SysLog server functionality into the software of the MultiVOIP units. SysLog is a *de facto* standard for logging events in network communication systems.

The SysLog Server resides in the MultiVOIP unit itself. To implement this functionality, you will need a SysLog client program (sometimes referred to as a “daemon”). SysLog client programs, both paid and freeware, can be obtained from Kiwi Enterprises, among other firms. Read the End-User License Agreement carefully and observe license requirements. See www.kiwisyslog.com. SysLog client programs essentially give you a means of structuring console messages for convenience and ease of use.

MultiTech Systems does not endorse any particular SysLog client program. SysLog client programs by qualified providers should suffice for use with MultiVOIP units. Kiwi’s brief description of their SysLog program is as follows:

“Kiwi Syslog Daemon is a freeware Syslog Daemon for the Windows platform. It receives, logs, displays and forwards Syslog messages from hosts such as routers, switches, Unix hosts and any other syslog enabled device. There are many customisable options available.”

Before a SysLog client program is used, the SysLog functionality must be enabled within the MultiVOIP in the **Logs** menu under **Configuration**.

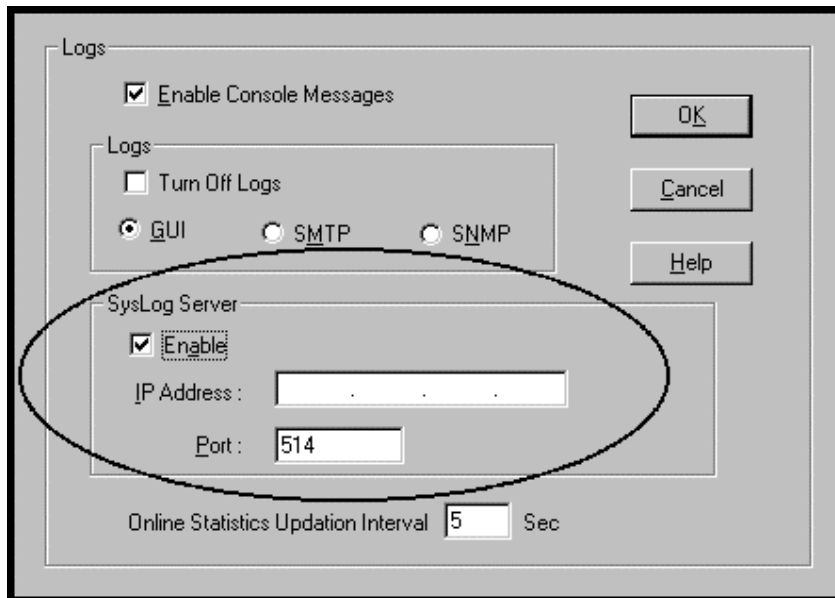

The IP Address used will be that of the MultiVOIP itself.

In the **Port** field, entered by default, is the standard ('well-known') logical port, 514.

Configuring the SysLog Client Program. Configure the SysLog client program for your own needs. In various SysLog client programs, you can define where log messages will be saved/archived, opt for interaction with an SNMP system (like MultiVoipManager), set the content and format of log messages, determine disk space allocation limits for log messages, and establish a hierarchy for the seriousness of messages (normal, alert, critical, emergency, etc.). A sample presentation of SysLog info in the Kiwi daemon is shown below. SysLog programs will vary in features and presentation.

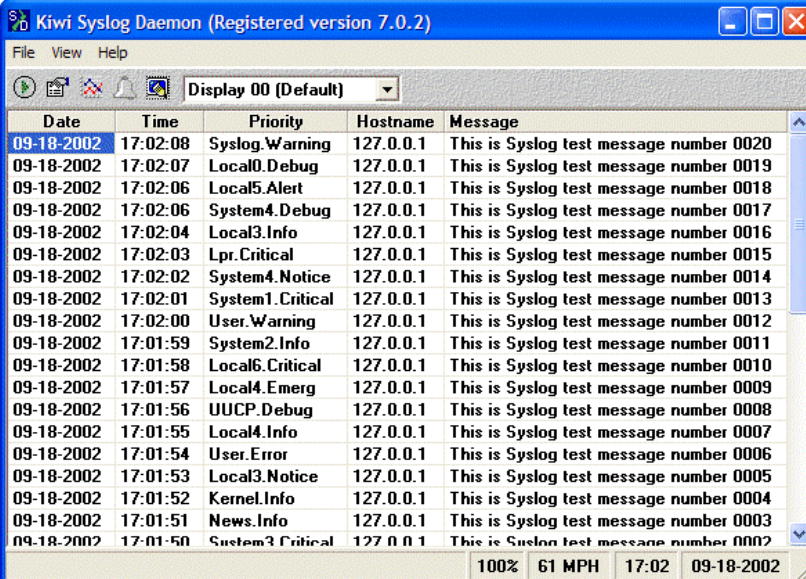

The screenshot shows the Kiwi Syslog Daemon application window. The title bar reads "Kiwi Syslog Daemon (Registered version 7.0.2)". The menu bar includes "File", "View", and "Help". Below the menu bar is a toolbar with several icons and a dropdown menu set to "Display 00 (Default)". The main area is a table with the following columns: "Date", "Time", "Priority", "Hostname", and "Message". The table contains 20 rows of log entries, all from the date 09-18-2002 and hostname 127.0.0.1. The messages are "This is Syslog test message number" followed by a number. The priorities vary, including Syslog.Warning, Local0.Debug, Local5.Alert, System4.Debug, Local3.Info, Lpr.Critical, System4.Notice, System1.Critical, User.Warning, System2.Info, Local6.Critical, Local4.Emerg, UUCP.Debug, Local4.Info, User.Error, Local3.Notice, Kernel.Info, News.Info, and System3.Critical. At the bottom of the window, there is a status bar showing "100%", "61 MPH", "17:02", and "09-18-2002".

Date	Time	Priority	Hostname	Message
09-18-2002	17:02:08	Syslog.Warning	127.0.0.1	This is Syslog test message number 0020
09-18-2002	17:02:07	Local0.Debug	127.0.0.1	This is Syslog test message number 0019
09-18-2002	17:02:06	Local5.Alert	127.0.0.1	This is Syslog test message number 0018
09-18-2002	17:02:06	System4.Debug	127.0.0.1	This is Syslog test message number 0017
09-18-2002	17:02:04	Local3.Info	127.0.0.1	This is Syslog test message number 0016
09-18-2002	17:02:03	Lpr.Critical	127.0.0.1	This is Syslog test message number 0015
09-18-2002	17:02:02	System4.Notice	127.0.0.1	This is Syslog test message number 0014
09-18-2002	17:02:01	System1.Critical	127.0.0.1	This is Syslog test message number 0013
09-18-2002	17:02:00	User.Warning	127.0.0.1	This is Syslog test message number 0012
09-18-2002	17:01:59	System2.Info	127.0.0.1	This is Syslog test message number 0011
09-18-2002	17:01:58	Local6.Critical	127.0.0.1	This is Syslog test message number 0010
09-18-2002	17:01:57	Local4.Emerg	127.0.0.1	This is Syslog test message number 0009
09-18-2002	17:01:56	UUCP.Debug	127.0.0.1	This is Syslog test message number 0008
09-18-2002	17:01:55	Local4.Info	127.0.0.1	This is Syslog test message number 0007
09-18-2002	17:01:54	User.Error	127.0.0.1	This is Syslog test message number 0006
09-18-2002	17:01:53	Local3.Notice	127.0.0.1	This is Syslog test message number 0005
09-18-2002	17:01:52	Kernel.Info	127.0.0.1	This is Syslog test message number 0004
09-18-2002	17:01:51	News.Info	127.0.0.1	This is Syslog test message number 0003
09-18-2002	17:01:50	System3.Critical	127.0.0.1	This is Syslog test message number 0002

Chapter 11: Warranty, Service, and Tech Support

Limited Warranty

Multi-Tech Systems, Inc. (“MTS”) warrants that its products will be free from defects in material or workmanship for a period of two years from the date of purchase, or if proof of purchase is not provided, two years from date of shipment. MTS MAKES NO OTHER WARRANTY, EXPRESSED OR IMPLIED, AND ALL IMPLIED WARRANTIES OF MERCHANTABILITY AND FITNESS FOR A PARTICULAR PURPOSE ARE HEREBY DISCLAIMED. This warranty does not apply to any products which have been damaged by lightning storms, water, or power surges or which have been neglected, altered, abused, used for a purpose other than the one for which they were manufactured, repaired by the customer or any party without MTS’s written authorization, or used in any manner inconsistent with MTS’s instructions.

MTS’s entire obligation under this warranty shall be limited (at MTS’s option) to repair or replacement of any products which prove to be defective within the warranty period, or, at MTS’s option, issuance of a refund of the purchase price. Defective products must be returned by Customer to MTS’s factory—transportation prepaid.

MTS WILL NOT BE LIABLE FOR CONSEQUENTIAL DAMAGES AND UNDER NO CIRCUMSTANCES WILL ITS LIABILITY EXCEED THE PURCHASE PRICE FOR DEFECTIVE PRODUCTS.

Repair Procedures for U.S. and Canadian Customers

In the event that service is required, products may be shipped, freight prepaid, to our Mounds View, Minnesota factory:

Multi-Tech Systems, Inc.
2205 Woodale Drive
Mounds View, MN 55112
Attn: Repairs, Serial # _____

A Returned Materials Authorization (RMA) is not required. Return shipping charges (surface) will be paid by MTS.

Please include, inside the shipping box, a description of the problem, a return shipping address (it must be a street address, not a P.O. Box number), your telephone number, and if the product is out of warranty, a check or purchase order for repair charges.

For out-of-warranty repair charges, go to www.multitech.com/documents/warranties

Extended two-year overnight replacement service agreements are available for selected products. Please call MTS at (888) 288-5470, extension 5308, or visit our web site at www.multitech.com/programs/orc for details on rates and coverages.

Please direct your questions regarding technical matters, product configuration, verification that the product is defective, etc., to our Technical Support department at (800) 972-2439 or email tsupport@multitech.com. Please direct your questions regarding repair expediting, receiving, shipping, billing, etc., to our Repair Accounting department at (800) 328-9717 or (763) 717-5631, or email mtsrepair@multitech.com.

Repairs for damages caused by lightning storms, water, power surges, incorrect installation, physical abuse, or used-caused damages are billed on a time-plus-materials basis.

Technical Support

Multi-Tech Systems has an excellent staff of technical support personnel available to help you get the most out of your Multi-Tech product. If you have any questions about the operation of this unit, or experience difficulty during installation you can contact Tech Support via the following:

Contacting Technical Support

Country	By E-mail	By telephone
France	support@multitech.fr	(33) 1-64 61 09 81
India	support@ multitechindia.com	(91) 124-340778
U.K.	support@ multitech.co.uk	(44) 118 959 7774
U.S. & Canada	tsupport@ multitech.com	(800) 972-2439
Rest of World	support@ multitech.com	(763) 785-3500

Internet: http://www.multitech.com/_forms/email_tech_support.htm

Please have your product information available, including model and serial number.

Chapter 12: Regulatory Information



EMC, Safety, and R&TTE Directive Compliance

The CE mark is affixed to this product to confirm compliance with the following European Community Directives:

Council Directive 89/336/EEC of 3 May 1989 on the approximation of the laws of Member States relating to electromagnetic compatibility,
and

Council Directive 73/23/EEC of 19 February 1973 on the harmonization of the laws of Member States relating to electrical equipment designed for use within certain voltage limits,
and

Council Directive 1999/5/EC of 9 March 1999 on radio equipment and telecommunications terminal equipment and the mutual recognition of their conformity.

FCC Declaration

NOTE: This equipment has been tested and found to comply with the limits for a **Class A** digital device, pursuant to Part 15 of the FCC Rules. These limits are designed to provide reasonable protection against harmful interference when the equipment is operated in a commercial environment. This equipment generates, uses and can radiate radio frequency energy, and if not installed and used in accordance with the instructions, may cause harmful interference to radio communications. Operation of this equipment in a residential area is likely to cause harmful interference in which case the user will be required to correct the interference at his own expense.

This device complies with Part 15 of the FCC rules.

Operation is subject to the following two conditions:

- (1) This device may not cause harmful interference.
- (2) This device must accept any interference that may cause undesired operation.

Warning: Changes or modifications to this unit not expressly approved by the party responsible for compliance could void the user's authority to operate the equipment.

Industry Canada

This Class A digital apparatus meets all requirements of the Canadian Interference-Causing Equipment Regulations.

Cet appareil numérique de la classe A respecte toutes les exigences du Règlement Canadien sur le matériel brouilleur.

FCC Part 68 Telecom

1. This equipment complies with part 68 of the Federal Communications Commission Rules. On the outside surface of this equipment is a label that contains, among other information, the FCC registration number. This information must be provided to the telephone company.
2. As indicated below, the suitable jack (Universal Service Order Code connecting arrangement) for this equipment is shown. If applicable, the facility interface codes (FIC) and service order codes (SOC) are shown.
3. An FCC compliant telephone cord and modular plug is provided with this equipment. This equipment is designed to be connected to the telephone network or premises wiring using a compatible modular jack that is Part 68 compliant. See installation instructions for details.
4. If this equipment causes harm to the telephone network, the telephone company will notify you in advance that temporary discontinuance of service may be required. If advance notice is not practical, the telephone company will notify the customer as soon as possible.
5. The telephone company may make changes in its facilities, equipment, operation, or procedures that could affect the operation of the equipment. If this happens, the telephone company will provide advance notice to allow you to make necessary modifications to maintain uninterrupted service.
6. If trouble is experienced with this equipment (the model of which is indicated below), please contact Multi-Tech Systems, Inc. at the address shown below for details of how to have repairs made. If the equipment is causing harm to the network, the telephone company

may request you to remove the equipment from the network until the problem is resolved.

7. No repairs are to be made by you. Repairs are to be made only by Multi-Tech Systems or its licensees. Unauthorized repairs void registration and warranty.

8. Manufacturer: Multi-Tech Systems, Inc.
Trade name: MultiVOIP
Model number: MVP2400
FCC registration number: US: AU7DDNAN46050
Modular jack (USOC): RJ-48C
Service center in USA: Multi-Tech Systems, Inc.
2205 Woodale Drive
Mounds View, MN 55112
Tel: (763) 785-3500
FAX: (763) 785-9874

Canadian Limitations Notice

Notice: The Industry Canada label identifies certified equipment. This certification means that the equipment meets certain telecommunications network protective, operational and safety requirements. The Department does not guarantee the equipment will operate to the user's satisfaction.

Before installing this equipment, users should ensure that it is permissible to be connected to the facilities of the local telecommunications company. The equipment must also be installed using an acceptable method of connection. The customer should be aware that compliance with the above conditions may not prevent degradation of service in some situations.

Repairs to certified equipment should be made by an authorized Canadian maintenance facility designated by the supplier. Any repairs or alterations made by the user to this equipment, or equipment malfunctions, may give the telecommunications company cause to request the user to disconnect the equipment.

Users should ensure for their own protection that the electrical ground connections of the power utility, telephone lines and internal metallic water pipe system, if present, are connected together. This precaution may be particularly important in rural areas.

Caution: Users should not attempt to make such connections themselves, but should contact the appropriate electric inspection authority, or electrician, as appropriate.

Appendix A: Expansion Card Installation (MVP24-48 & MVP30-60)

Installation

Both the MVP2410 and the MVP3010 use the same mechanical chassis. This chassis accommodates a second MultiVOIP circuit card or motherboard module. The add-on module for the MVP2410 is the MVP24-48 product; the add-on module for the MVP3010 is the MVP30-60 product.

To install an expansion card into an MVP2410 or MVP3010, you must:

1. Power down and unplug the MVP2410/3010 unit.
2. Using a Phillips or star-bit screwdriver, remove the blank plate at the rear of the MVP2410/3010 chassis (see Figure A-1). Save the screw.

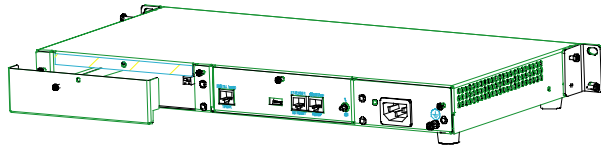

Figure A-1: Remove Plate Covering Expansion Slot

3. A power cable for the expansion card (+5V) is already present within the MVP2410/3010 unit. This power cable has a two-pin “molex” connector. When the rear cover plate has been removed, the cable is accessible from the rear at the right side of the expansion slot. Locate this connector within the MVP2410/3010. See Figure A-2.

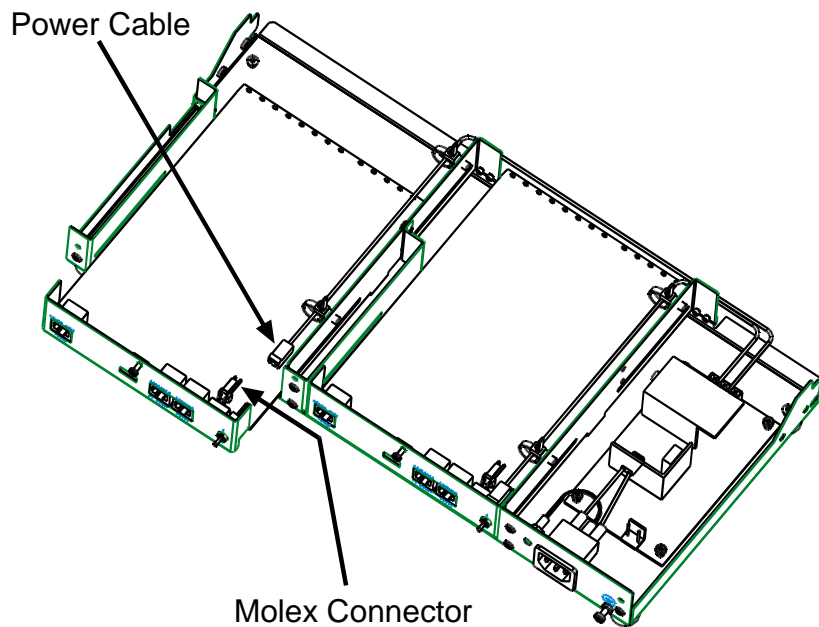

Figure A-2: MVP2410/3010 Chassis (top/rear view)

4. While keeping the power cable out of the way, fit the MVP24-48 or MVP30-60 card into the grooves of the expansion slot. Push it in far enough to allow connection of the power cable to the receptacle on the vertical plate of the expansion card. (See Figure A-2.) Connect the power cable.
5. Push the expansion card fully into the chassis. See Figure A-3.

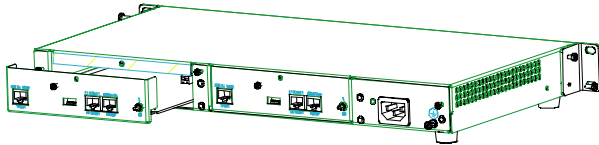

Figure A-3: Sliding Expansion Card into Chassis

Secure the vertical plate of the expansion card to the chassis with a screw.

Operation

The MVP2410/3010 front panel has two sets of identical LEDs. In the MVP2410/3010 without an expansion card, only the left-hand set of LEDs is functional. However, when the MultiVOIP unit has been upgraded with an MVP24-48 or MVP30-60 expansion card, the right-hand set of LEDs will also become active.

Remember that the expansion card must be configured as though it were simply another complete MultiVOIP unit: it requires its own T1/E1 line; it requires its own connection to a computer running the MultiVOIP configuration software. All of the procedures and operations that apply to the original motherboard of the MVP2410/3010 will also apply to the expansion card. See applicable User Guide chapters for details.

Appendix B: Cable Pinouts

Appendix B: Cable Pinouts

Command Cable

RJ-45 Connector

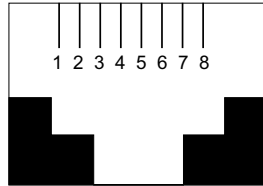

End-to-End Pin Info

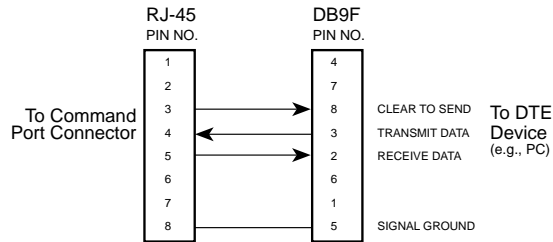

RJ-45 connector plugs into Command Port of MultiVOIP.

DB-9 connector plugs into serial port of command PC (which runs MultiVOIP configuration software).

Ethernet Connector

The functions of the individual conductors of the MultiVOIP's Ethernet port are shown on a pin-by-pin basis below.

RJ-45 Ethernet Connector	Pin	Circuit Signal Name
	1	TD+ Data Transmit Positive
	2	TD- Data Transmit Negative
	3	RD+ Data Receive Positive
	6	RD- Data Receive Negative

T1/E1 Connector

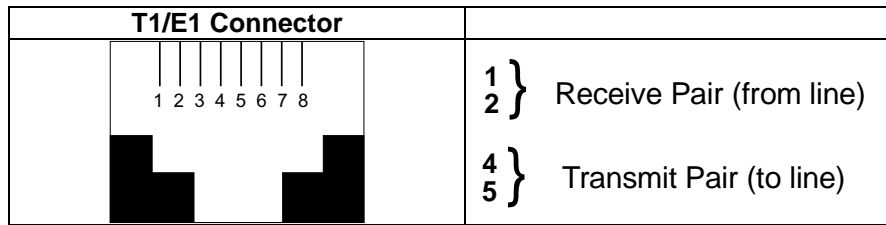

Voice/Fax Channel Connectors

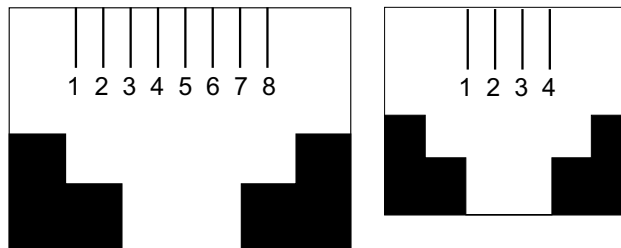

Pin Functions (E&M Interface)		
Pin	Descr	Function
1	M	Input
2	E	Output
3	T1	4-Wire Output
4	R	4-Wire Input, 2-Wire Input
5	T	4-Wire Input, 2-Wire Input
6	R1	4-Wire Output
7	SG	Signal Ground (Output)
8	SB	Signal Battery (Output)

Pin Functions (FXS/FXO Interface)			
FXS Pin	Description	FXO Pin	Description
2	N/C	2	N/C
3	Ring	3	Tip
4	Tip	4	Ring
5	N/C	5	N/C

Appendix C: TCP/UDP Port Assignments

Well Known Port Numbers

The following description of port number assignments for Internet Protocol (IP) communication is taken from the Internet Assigned Numbers Authority (IANA) web site (dubyadubyadubya.iana.org).

“The Well Known Ports are assigned by the IANA and on most systems can only be used by system (or root) processes or by programs executed by privileged users. Ports are used in the TCP [RFC793] to name the ends of logical connections which carry long term conversations. For the purpose of providing services to unknown callers, a service contact port is defined. This list specifies the port used by the server process as its contact port. The contact port is sometimes called the "well-known port". To the extent possible, these same port assignments are used with the UDP [RFC768]. The range for assigned ports managed by the IANA is 0-1023.”

Well-known port numbers especially pertinent to MultiVOIP operation are listed below.

Port Number Assignment List

Well-Known Port Numbers

Function	Port Number
telnet	23
tftp	69
snmp	161
snmp tray	162
gatekeeper registration	1719
H.323	1720
SIP	5060
SysLog	514

Appendix D: Installation Instructions for MVP428 Upgrade Card

Installation Instructions for MVP428 Upgrade Card

In this procedure, you will install an additional circuit board into the MVP410, converting it from a 4-channel voip to an 8-channel voip.

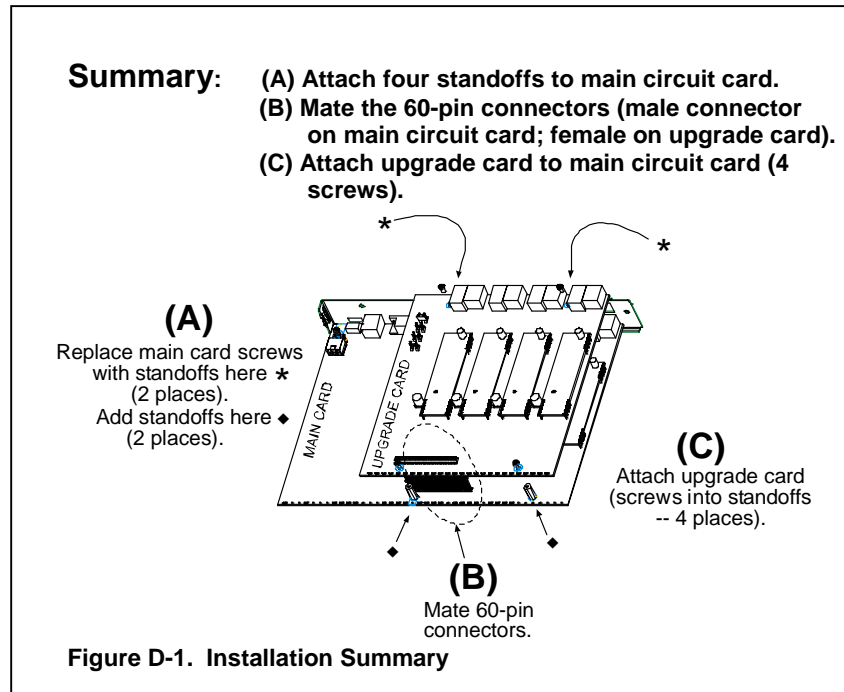

Procedure in Detail

1. Power down and unplug the MVP410 unit.
2. Using a Phillips driver, remove the blank cover plate at the rear of the MVP410 chassis. Save the screws.

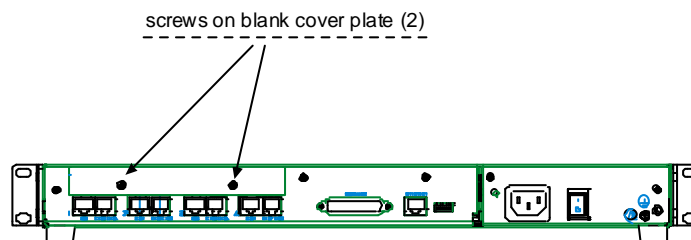

Figure D-2: Removing screws from blank cover plate

- Using a Phillips driver, remove the three screws that secure the main circuit board and back panel assembly to the chassis.

NOTE:
Follow standard ESD precautions to protect the circuit board from static electricity damage.

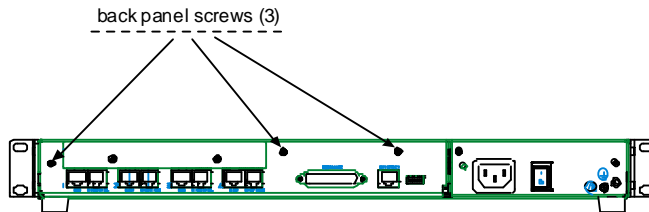

Figure D-3: Removing screws from back panel

- Slide the main circuit board out of the chassis far enough to unplug the power connector.

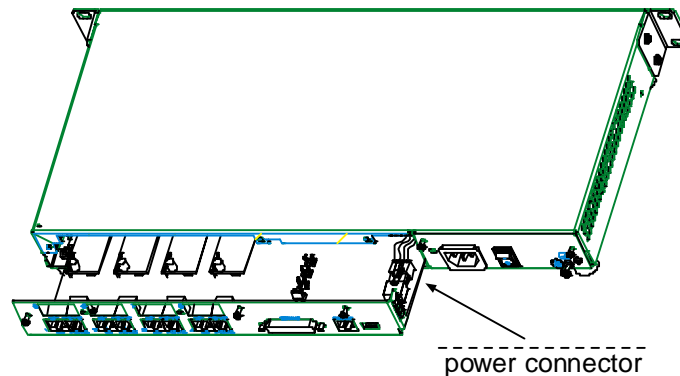

Figure D-4: Accessing power connector

- Unplug the power connector from the main circuit board.
- Slide the main circuit board completely out of the chassis and place on a non-conductive, static-safe table-top surface.
- Remove mounting hardware (2 screws, 2 nuts, and 4 standoffs) from its package.

8. On the phone-jack side of the circuit card, three screws attach the circuit card to the back panel. Two of these screws are adjacent to the four phone-jack pairs. Remove these two screws.

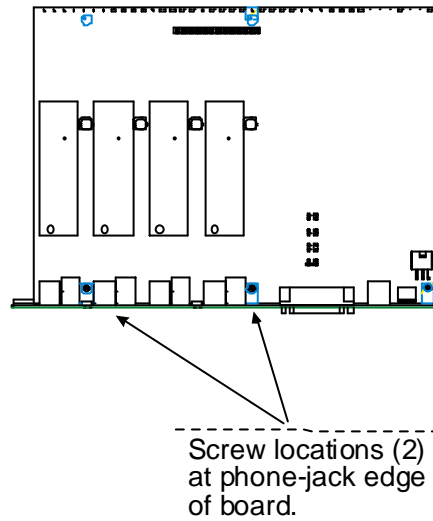

Figure D-5: Screws to be removed and replaced with standoffs (phone-jack edge of board; top view)

9. Replace these two screws with standoffs.
 10. There are two copper-plated holes at the LED edge of the circuit card. Place a nut beneath each hole (lockwasher side should be in contact with board) and attach a standoff to each location\.

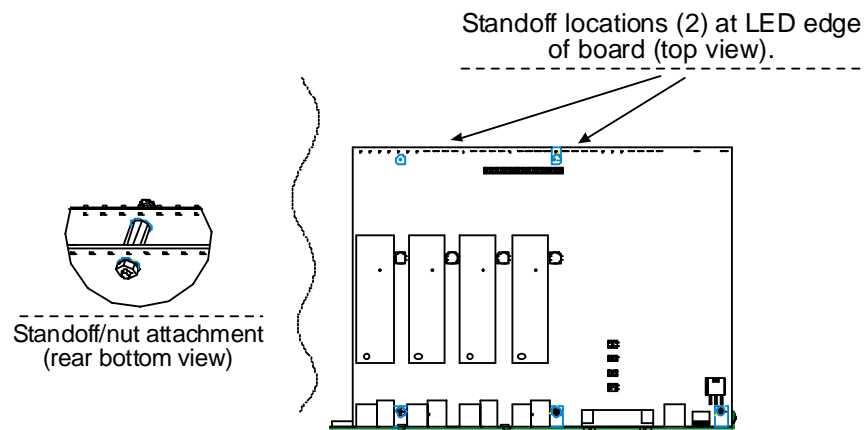
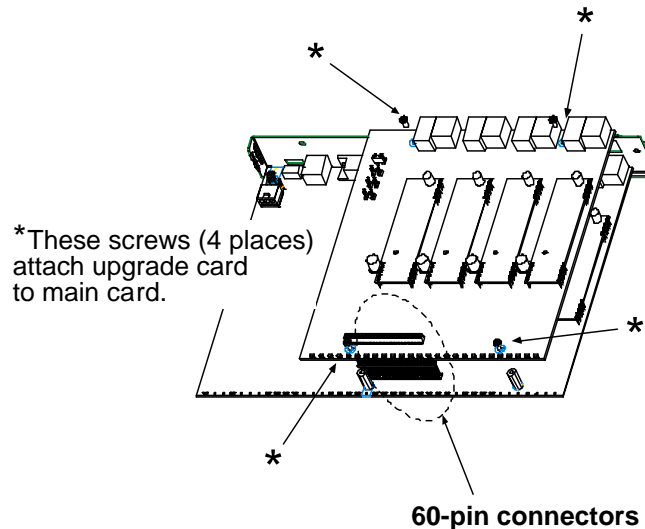

Figure D-6: Standoffs at LED edge of board (top view)

11. Locate the male 60-pin vertical connector near the LED edge of the main circuit card. Check that pins are straight and evenly spaced. If not, then correct for straightness and spacing. Locate the 60-pin female connector on the upgrade circuit card.
12. Set the upgrade circuit card on top of the main circuit card. Align the upgrade card's 4 pairs of phone-jacks with the 4 pairs of holes in the backplane of the main card. Slide the phone jacks into the holes.
13. Mate the upgrade card's 60-pin female connector with the main card's 60-pin male connector.



**Figure D-7. Attaching upgrade card to main circuit card
(secure 4 Phillips screws; mate 60-pin connectors)**

14. There are four copper-plated attachment holes, two each at the front and rear edges of the upgrade card. Attach the upgrade card to the main card using 4 Phillips screws. The upgrade card should now be firmly attached to the main card.
15. Slide the main circuit card back into the chassis far enough to allow re-connection of power cable.
16. Re-connect power cable.
17. Slide the main circuit card fully into the chassis.
18. Re-attach the backplane of the main circuit card to the chassis with 3 screws.

Index

INDEX

A

- abbreviated dialing, inter-office
 - E1 276
 - T1 237
- access codes, PBX 42
- access codes, types
 - PBX 47
 - PSTN 47
 - special 47
- access digits, PBX42. *See* phonebook
 - digits, types used
- access to network
 - analog 202
 - T1/E1 128
- access to remote PSTN
 - E1 14
 - T1 10
- accessing Statistics, Logs screen
 - 331
- accessing Call Progress (Statistics)
 - screen 325
- accessing configuration parameter
 - groups
 - analog 173
 - T1/E1 98
- accessing interface parameters 188
- accessing IP Parameters screen
 - analog 174
 - T1/E1 99
- accessing IP Statistics screen 335
- accessing Logs (Statistics) screen
 - 331
- accessing logs screen
 - analog 216
 - T1/E1 142
- accessing Regional Parameters
 - analog 203
 - T1/E1 129
- accessing SMTP parameters
 - analog 210
 - T1/E1 136
- accessing SNMP parameters
 - analog 200
 - T1/E1 126
- accessing Supplementary Services
 - screen
 - analog 219
 - T1/E1 145
- accessing System Information screen
 - analog 231
 - T1/E1 157
- accessing T1 Statistics screen 339
- accessing T1/E1/ISDN Parameters
 - screen 113
- accessing Voice/FAX Parameters
 - screen 103, 178
- Add Inbound Phonebook Entry icons
 - E1 282
 - T1 238
- Add Outbound Phonebook Entry icon
 - E1 282
 - T1 238
- Add Prefix (inbound) field
 - E1 296
 - T1 252
- Add Prefix (outbound) field
 - E1 290
 - T1 246
- Add/Edit Inbound Phonebook field
 - definitions
 - E1 296, 297
 - T1 252, 253
- Add/Edit Inbound Phonebook screen
 - E1 296
 - T1 252
- Add/Edit Inbound Phonebook screen
 - fields (E1)
 - Add Prefix 296
 - Channel Number 296
 - Description (callee location) 297
 - Enable (Call Forwarding) 297
 - Forward Address/Number 297
 - Forward Condition 297
 - Remove Prefix 296
 - Ring Count 297
- Add/Edit Inbound Phonebook screen
 - fields (T1)

- Add Prefix..... 252
- Channel Number 252
- Description (callee location) 253
- Enable (Call Forwarding) 253
- Forward Address/Number..... 253
- Forward Condition..... 253
- Remove Prefix 252
- Ring Count..... 253
- Add/Edit Outbound Phonebook field definitions
 - E1 290, 291, 292
 - T1 246, 247, 248
- Add/Edit Outbound Phonebook fields (E1)
 - Add Prefix..... 290
 - Advanced button 292
 - Description..... 290
 - destination pattern..... 290
 - Gateway Prefix 291
 - H.323 ID 291
 - IP Address..... 290
 - Protocol Type..... 290
 - Q.931 Port Number..... 291
 - Remove Prefix 290
 - SIP Port Number..... 292
 - SIP URL..... 292
 - Total Digits 290
 - Transport Protocol (SIP)..... 292
 - Use Gatekeeper 291
 - Use Proxy (SIP) 292
- Add/Edit Outbound Phonebook fields (T1)
 - Add Prefix..... 246
 - Advanced button 248
 - Description..... 246
 - destination pattern..... 246
 - Gateway Prefix 247
 - H.323 ID 247
 - IP Address..... 246
 - Protocol Type..... 246
 - Q.931 Port Number..... 247
 - Remove Prefix 246
 - SIP Port Number..... 248
 - SIP URL..... 248
 - Total Digits 246
 - Transport Protocol (SIP)..... 248
 - Use Gatekeeper 247
 - Use Proxy (SIP) 248
- Add/Edit Outbound Phonebook screen
 - E1 289
 - T1 245
- add-on module (analog, 4-to-8 channel), installation 408
- add-on module (T1/E1)
 - operation 400
- add-on module (T1/E1), installation 398
- Address (SNMP) field
 - analog 202
 - T1/E1 128
- Advanced button, Outbound Phonebook
 - E1 293
 - T1 249
- Advanced Features field group
 - analog 184
 - T1/E1 109
- airflow 66
- Alerting Party
 - Supplementary Services (analog) 226, 227, 228
 - Supplementary Services (T1/E1) 152, 153, 154
- Allowed Name Type (analog)
 - Alerting Party 226, 227, 228
 - Calling Party 225
- Allowed Name Type (T1/E1)
 - Alerting Party 152, 153, 154
 - Calling Party 151
- Allowed Name Types, Call Name ID (analog)
 - Alerting Party 226
 - Busy Party 227
 - Calling Party 225
 - Connected Party 228
- Allowed Name Types, Call Name ID (T1/E1)
 - Alerting Party 152
 - Busy Party 153
 - Calling Party 151
 - Connected Party 154
- Alternate IP Address field
 - E1 294
 - T1 250
- Alternate IP Routing
 - E1 289

- T1..... 245
- Alternate Routing field definitions
 - E1..... 294
 - T1..... 250
- Alternate Routing field definitions (E1)
 - Alternate IP Address..... 294
 - Round Trip Delay 294
- Alternate Routing field definitions (T1)
 - Alternate IP Address..... 250
 - Round Trip Delay 250
- analog phonebook..... 321
 - using T1 & E1 examples for 321
- analog phonebook examples..... 162
- analog telephony interface parameters 166
- Annex E field
 - E1..... 287
 - T1..... 243
- area codes 46
- Auto Call Enable field
 - analog..... 184
 - T1/E1 109
- Auto Disconnect field group
 - analog..... 187
 - T1/E1 112
- Automatic Disconnection field
 - analog..... 187
 - T1/E1 112
- Avaya Magix PBX (FXO) and Message Waiting Light 195
- Avaya Magix PBX (FXS Ground Start) and Message Waiting Light 192
- Avaya Magix PBX (FXS Loop Start) and Message Waiting Light 191
- B**
- bandwidth
 - coder (analog)..... 183
 - coder (T1/E1)..... 108
- battery caution 60
- baud rate, default (MultiVOIP software connection)
 - T1/E1 156
 - analog..... 230
- baud rate, fax
 - analog..... 182
 - T1/E1 107
- baud rate, setting
 - analog..... 230
 - T1/E1 156
- Bipolar Violation (E1 stats) field ..346
- Bipolar Violation (T1 stats) field..343
- Blue Alarm (E1 stats) field 344
- Blue Alarm (T1 stats) field 341
- Boot Code Version
 - System Info (analog)..... 232
 - System Info (T1/E1)..... 158, 323
- Boot LED
 - analog models 21
 - MVP-210..... 73
 - MVP-410/810 71
 - on MVP-2400..... 70
 - on MVP-2410/3010..... 69
- booting time
 - analog..... 21
 - E1 16
 - T1 13
- box contents
 - verifying..... 61
- busy tone, custom
 - analog..... 207, 208
 - T1/E1 133, 134
- busy-tones
 - analog..... 207
 - T1/E1 133
- Bytes Received (call progress) field 327
- Bytes Received (SMTP logs) field
 - analog..... 213
 - T1/E1 139
- Bytes received (statistics, logs) field 333
- Bytes Sent (call progress) field 327
- Bytes Sent (SMTP logs) field
 - analog..... 213
 - T1/E1 139
- Bytes sent (statistics, logs) field.... 332
- C**
- cable length, maximum span
 - E1 121
 - T1 116
- cabling diagram, quick

- analog models 33, 34
- E1 models 33
- MVP210..... 34
- MVP2400..... 34
- MVP2410..... 33
- MVP3010..... 33
- MVP410..... 33
- MVP810..... 33
- T1 models 33, 34
- cabling problem, fixing
 - analog models 173
 - T1/E1 models 98
- cabling procedure
 - MVP2400..... 69
 - MVP2410..... 68
 - MVP3010..... 68
 - MVP410..... 70, 72
 - MVP810..... 70
- Cadence 1 (custom) field
 - analog..... 209
 - T1/E1 135
- Cadence 2 (custom) field
 - analog..... 209
 - T1/E1 135
- Cadence 3 (custom) field
 - analog..... 209
 - T1/E1 135
- Cadence 4 (custom) field
 - analog..... 209
 - T1/E1 135
- Cadence field
 - analog..... 206
 - T1/E1 132
- cadences, custom
 - analog..... 207
 - T1.E1 135, 209
 - T1/E1 133
- cadences, signaling
 - analog..... 203
 - T1/E1 129
- Call Control Status
 - Call Progress Details (statistics)
 - field..... 330
- Call Control Status (call progress)
 - field..... 330
- Call Duration field
 - analog..... 187
 - T1/E1 112
- Call Forward Parameters (inbound phonebook)
 - E1 297
 - T1 253
- Call Forwarded To
 - logs (statistics) field 334
- Call Hold (analog)..... 220
- Call Hold (T1/E1) 146
- Call Hold Enable
 - analog..... 223
 - T1/E1 149
- Call Mode (SMTP logs) field
 - analog..... 213
 - T1/E1 139
- Call Name Identification (analog)
 - Alerting Party 226, 227, 228
 - Calling Party 225
- Call Name Identification (T1/E1)
 - Alerting Party 152, 153, 154
 - Calling Party 151
- Call Name Identification (analog)..... 220
- Call Name Identification (T1/E1) . 146
- Call On Hold
 - Call Progress Details (statistics)
 - field 327, 329
- Call on Hold (call progress) field.. 329
- Call Progress (Statistics) 325
- Call Progress Details (statistics)
 - screen field
 - Call On Hold 327
 - Call Waiting 327
 - Caller ID..... 327
 - Call On Hold 329
 - Call Waiting 329
 - Caller ID..... 330
- Call Progress Details (statistics)
 - screen fields
 - Channel 327
 - Duration 327
 - Mode 327
 - Voice Coder 327
 - Packets Sent 327
 - Packets Received..... 327
 - Bytes Sent 327
 - Bytes Received..... 327
 - Packets Lost 327
 - Outbound Digits 327
 - Prefix Matched 327

- Gateway Name..... 328
- IP Address..... 328
- Options..... 328
- Silence Compression..... 328
- Forward Error Correction 328
- Status 330
- Call Control Status..... 330
- Call Signalling Port field
 - E1 285
 - T1 241
- Call Status (SMTP logs) field
 - analog..... 214
 - T1/E1 140
- Call Transfer (analog)..... 220
- Call Transfer (T1/E1) 146
- Call Transfer Enable
 - analog..... 222
 - T1/E1 148
- Call Transferred To
 - logs (statistics) field 334
- Call Waiting
 - Call Progress Details (statistics)
 - field..... 327, 329
- Call Waiting (analog)..... 220
- Call Waiting (call progress) field.. 329
- Call Waiting (T1/E1) 146
- Call Waiting Enable
 - analog..... 223
 - T1/E1 149
- Caller ID
 - Call Progress Details (statistics)
 - field..... 327, 330
- Caller ID (analog) 220
- Caller ID (call progress) field 330
- Caller ID (Supplementary Services)
 - field
 - analog..... 229
 - T1/E1 155
- Caller ID (T1/E1)..... 147
- Caller Name Identification Enable
 - analog..... 224
 - T1/E1 150
- calling area codes..... 46
- Calling Party
 - Supplementary Services (analog)
 - 225
 - Supplementary Services (T1/E1)
 - 151
- Canadian Class A requirements 395
- Canadian Limitations Notice
 - (regulatory)..... 396
- CAS Protocol field
 - E1 122
 - T1 117
- CAS Protocols, downloading 357
- CAS vs. CCS
 - T1 117, 122
- CCS vs. CAS
 - T1 117, 122
- CD
 - MultiVOIP 26
- Channel (call progress) field 327
- channel capacity 8
 - analog 18
 - E1 14
 - T1 10
- Channel Number (inbound) field
 - E1 296
 - T1 252
- Channel Number (SMTP logs) field
 - analog 213
 - T1/E1 139
- city codes 46
- Clear (IP Statistics) button 336
- Clocking field
 - E1 124
 - T1 119
- coder (analog)
 - bandwidth, max 183
 - G.711 183
 - G.723.1 183
 - G.726 183
 - G.727 183
 - G.729 183
 - Net Coder 183
- Coder (SMTP logs) field
 - analog 213
 - T1/E1 139
- coder (T1/E1)
 - bandwidth, max 108
 - G.711 108
 - G.723.1 108
 - G.726 108
 - G.727 108
 - G.729 108
 - Net Coder 108

Coder field	
analog.....	183
T1/E1	108
Coder Parameters field group	
analog.....	183
T1/E1	108
COL LED	
analog models	21
COM port	
on command PC.....	80
COM port (analog models)	
conflict, resolving	172
error message	172
COM port (T1/E1 models)	
conflict, resolving	97
error message	97
COM port allocation	
analog.....	230
T1/E1	156
COM port assignments	
analog.....	230
T1/E1	156
COM port conflict	
error message	80
COM Port Setup screen	80
COM Port Setup screen (analog models)	172
COM Port Setup screen (T1/E1 models)	97
comma	
meaning/use in phonebook	48
comma use	
and second dial tone.....	48
command cable pinout	402
command PC	
COM port assignment (detailed).	80
COM port requirement.....	32
demands upon	32
non-dedicated use	32
operating system	32
settings	32
specifications	32
Command PC	
COM port requirement.....	22
non-dedicated use of	22
operating system	22
community (voip) defined	
analog.....	202
T1/E1	128
Community Name 1 (SNMP) field	
analog.....	202
T1/E1	128
compatibility, Fast Start	
E1	285
T1	241
compatibility, H.450 with H.323, not with SIP	
analog.....	19, 219
E1	15
T1	11
T1/E1	145
compression standard	
E1	124
T1	119
compression, silence	
analog.....	184
T1/E1	109
Compression, Silence (SMTP logs)	
analog.....	214
T1/E1	140
computer requirements.....	22
configuration of voip (analog)	
local versus remote.....	163
configuration of voip (T1/E1)	
local versus remote.....	87, 88
Configuration option (MultiVOIP program menu).....	347
Configuration Parameter Groups,	
accessing	
analog.....	173
T1/E1	98
configuration procedure, local	
detailed, analog	169
detailed, T1/E1	94
summary, analog	168
summary, T1/E1	93
configuration, local	
analog.....	165
T1/E1	89
configuration, phonebook	
E1	281
starter.....	39
T1	237
configuration, saving	
analog.....	233
T1/E1	159

- user..... 362
- configuration, starter
 - phone/IP 36
- configuration, technical
 - saving..... 38
- configuration, user default
 - analog..... 234
 - T1/E1 160
- Configuring MultiVOIP phonebooks,
 - general
 - E1 275
 - T1 236
- confirming connectivity 57
- conflicts
 - COM port..... 80
- Connection Problems, Solving
 - analog..... 172
 - T1/E1 97
- connectivity
 - confirmation of 57
 - confirming with remote voip 31, 39
 - pinging and 58
- connectivity test 54
- Consecutive Packets Lost field
 - analog..... 187
 - T1/E1 112
- console messages 38, 54, 56, 57
- console messages, enabling
 - analog..... 217
 - T1/E1 143
- contacting technical support 392
- coordinated phonebook entries
 - E1 281
 - T1 237
- Copy Channel command
 - analog..... 180
 - T1/E1 105
- Copy Channel field
 - analog..... 181
 - T1/E1 106
- Copy Channel, Supplementary
 - Services command
 - analog..... 221
 - T1/E1 147
- Copy Channel, Supplementary
 - Services field
 - analog..... 229
 - T1/E1 155
- country
 - ISDN type and..... 125
 - switch type and ISDN 125
- Country (ISDN) field
 - E1/ISDN..... 123
- country codes 46
- Country field (ISDN)
 - T1/ISDN..... 118
- Country/Region (tone schemes) field
 - analog..... 205
 - T1/E1 131
- CRC and ESF frame format (T1).. 116
- CRC Check field
 - T1 116
- Creating a User Default Configuration
 - analog..... 234
 - T1/E1 160
- CT Ph#
 - logs (statistics) field 334
- Current Loss (FXO disconnect
 - criteria) field..... 196
- Current Loss field
 - FXS Ground Start..... 193
 - FXS Loop Start 191
- Custom (tones, Regional)field
 - analog..... 206
 - T1/E1 132
- custom cadences
 - analog..... 209
 - T1/E1 135
- custom DTMF
 - analog..... 207, 208
 - T1/E1 133, 134
- Custom Fields (SMTP) definitions
 - analog..... 213, 214
 - T1/E1 139, 140
- Custom Fields, SMTP log email
 - (analog)
 - Bytes Received..... 213
 - Bytes Sent 213
 - Call Mode..... 213
 - Call Status 214
 - Channel Number 213
 - Coder..... 213
 - Options 214
 - Options 214
 - Description (callee) 214
 - Description (caller) 214

- Duration 213
- From Gateway Number 214
- From IP Address 214
- Outbound Digits..... 214
- Packets Lost..... 213
- Packets Received 213
- Packets Sent..... 213
- Prefix Matched..... 214
- Select All 213
- Start Date, Time..... 213
- To Gateway Number..... 214
- To IP Address 214
- Custom Fields, SMTP log email (T1/E1)
 - Bytes Received 139
 - Bytes Sent 139
 - Call Mode 139
 - Call Status..... 140
 - Channel Number..... 139
 - Coder 139
 - Options..... 140
 - Options..... 140
 - Description (callee)..... 140
 - Description (caller) 140
 - Duration 139
 - From Gateway Number 140
 - From IP Address 140
 - Outbound Digits..... 140
 - Packets Lost..... 139
 - Packets Received 139
 - Packets Sent..... 139
 - Prefix Matched..... 140
 - Select All 139
 - Start Date, Time..... 139
 - To Gateway Number..... 140
 - To IP Address 140
- Custom Tone-Pair Settings (analog)
 - fields
 - Cadence 1..... 209
 - Cadence 2..... 209
 - Cadence 3..... 209
 - Cadence 4..... 209
- Custom Tone-Pair Settings (T1/E1)
 - fields
 - Cadence 1..... 135
 - Cadence 2..... 135
 - Cadence 3..... 135
 - Cadence 4..... 135
- Custom Tone-Pair Settings definitions
 - analog..... 208, 209
 - T1/E1 134, 135
- Custom Tone-Pair Settings fields (analog)
 - Frequency 1..... 208
 - Frequency 2..... 208
 - Gain 1..... 208
 - Gain 2..... 208
 - Tone Pair..... 208
- Custom Tone-Pair Settings fields (T1/E1)
 - Frequency 1..... 134
 - Frequency 2..... 134
 - Gain 1..... 134
 - Gain 2..... 134
 - Tone Pair..... 134
- custom tones, setting
 - analog..... 207
 - T1/E1 133
- customized log email
 - analog..... 213, 214
 - T1/E1 139, 140
- D**
- data capacity..... 8
 - analog..... 18
 - E1 14
 - T1 10
- Date & Time Setup (program menu option), command 349
- Date and Time Setup option (MultiVOIP program menu) 347
- debugging messages
 - analog..... 218
 - T1/E1 143
- Default (Supplementary Services)
 - field
 - analog..... 229
 - T1/E1 155
- Default (Voice/FAX) field
 - analog..... 181
 - T1/E1 106
- default baud rate (MultiVOIP software connection)
 - analog..... 230
 - T1/E1 156
- default configuration, user

- analog..... 234
- T1/E1 160
- default values, software 360
- delay, packets
 - analog..... 185
 - T1/E1 110
- delay, versus voice quality
 - analog..... 186
 - T1/E1 111
- Delete File button
 - Logs (Statistics) screen 332
- Description (callee location)
 - E1 297
 - T1 253
- Description (callee, outbound phonebook)
 - E1 290
 - T1 246
- Description, From Details (SMTP logs) field
 - analog..... 214
 - T1/E1 140
- Description, To Details (SMTP logs) field
 - analog..... 214
 - T1/E1 140
- Destination Pattern (outbound) field
 - E1 290
 - T1 246
- destination patterns
 - digits used 46
 - tips about..... 46
- destination patterns, discussion
 - E1 280
 - T1 236
- dial tone, custom
 - analog..... 207, 208
 - T1/E1 133, 134
- dial tone, second
 - and comma use..... 48
 - pausing for 48
- Dialing Options (FXO) fields 195, 196
- dialing patterns
 - digits used 46
 - inbound/outbound matching 48
 - tips about..... 46
- dial-tones
 - analog..... 207
 - T1/E1 133
- DID
 - and FXO interface 195
 - FXS Ground Start..... 192
 - FXS Loop Start 191
- digits in phonebook
 - specialized codes..... 47
 - types 46
- dimensions
 - analog models 25
 - E1 models..... 24
 - T1 models..... 23
- Direct Inward Dialing
 - FXS Ground Start..... 191, 192
- Disconnect on Call Progress Tone (FXO) field..... 197
- Disconnect Tone Sequence (FXO) field 197
- disconnection criteria, FXO .. 196, 197
- DNS Server IP Address
 - analog..... 176
 - T1/E1 101
- Download CAS Protocol (program menu option) , command..... 357
- Download CAS Protocol option (MultiVOIP program menu) 347
- Download Factory Defaults (program menu option) , command..... 360
- Download Factory Defaults option (MultiVOIP program menu) 348
- Download Firmware (program menu option), command 353, 354
- Download Firmware option
 - description (MultiVOIP program menu) 348
- Download User Defaults (program menu option) , command..... 362
- Download User Defaults option
 - description (MultiVOIP program menu) 348
- downloading firmware, machine perspective 348, 371
- downloading user defaults..... 362
- downloads vs. uploads (FTP)..... 371
- dropping digits, in phonebook..... 47
- DTMF
 - extended 197
 - standard 197

- DTMF frequency chart 197
- DTMF Gain (High Tones) field
 analog..... 181
 T1/E1 106
- DTMF Gain (Low Tones) field
 analog..... 181
 T1/E1 106
- DTMF Gain field
 analog..... 181
 T1/E1 106
- DTMF In/Out of Band field
 analog..... 182
 T1/E1 107
- DTMF inband
 analog..... 182
 T1/E1 107
- DTMF out of band
 analog..... 182
 T1/E1 107
- DTMF Parameters
 T1/E1 106
- DTMF, custom tone pairs
 analog..... 207, 208
 T1/E1 133, 134
- Duration (call progress) field..... 327
- Duration (DTMF) field
 analog..... 182
 T1/E1 107
- Duration (SMTP logs) field
 analog..... 213
 T1/E1 139
- Duration (statistics, logs) field..... 332
- Dynamic Jitter Buffer field
 analog..... 185
 T1/E1 110
- Dynamic Jitter field group
 analog..... 185
 T1/E1 110
- Dynamic Jitter fields
 analog..... 186
 T1/E1 111
- E**
- E&M interface (MVP210)
 matching telco trunk line 73
 uses of 73
- E&M interface (MVP-410/810)
 matching telco trunk line 71
 uses of 71
- E&M Interface Parameter fields
 Interface 199
 Pass Through..... 199
 Signal 199
 Type 199
 Wink Timer 199
- E&M Parameter definitions 199
- E&M Parameters..... 198
- E1 Parameter definitions 121, 122, 124
 Clocking 124
 Line Build-Out 124
 Line Coding..... 124
 PCM Law 124
 Pulse Shape Level 124
- E1 Parameter fields
 CAS Protocol 122
 CRC Check 122
 Frame Format 122
 Long-Haul Mode..... 122
- E1 Parameters screen 120
- E1 Statistics field definitions 344, 345,
 346
- E1 Statistics fields
 Bipolar Variation..... 346
 Blue Alarm..... 344
 Excessive Zeroes..... 346
 Loss of Frame Alignment..... 344
 Loss of MultiFrame Alignment. 345
 Receive Slip 346
 Receive Timeslot 16 Alarm
 Indication Signal 345
 Receive Timeslot 16 Loss of
 MultiFrame Alignment..... 346
 Receive Timeslot 16 Loss of Signal
 345
 Red Alarm 344
 Status Freeze Signalling Active 345
 Transmit Data Overflow..... 345
 Transmit Data Underrun 346
 Transmit Line Open 346
 Transmit Line Short 345
 Transmit Slip..... 346
 Transmit Slip Negative 346
 Transmit Slip Positive 345
 Yellow Alarm..... 345
- E1 telephony parameters..... 91
- E1/ISDN Parameter definitions..... 123

E1/ISDN Parameter fields	T1/E1	148
Country	Enable Call Waiting	
Enable ISDN-PRI	analog.....	223
Operator	T1/E1	149
Terminal Network.....	Enable Caller Name Identification	
Echo Cancellation field	analog.....	224
analog.....	T1/E1	150
T1/E1	Enable Console Messages field	
echo, removing	analog.....	218
analog.....	T1/E1	143
T1/E1	Enable Diffserv field	
Edit selected Inbound Phonebook	analog.....	176
Entry icon	T1/E1	101
E1	Enable DNS field	
T1.....	analog.....	176
Edit selected Outbound Phonebook	T1/E1	101
Entry icon	Enable ISDN-PRI field	
E1	E1/ISDN.....	123
T1.....	T1/ISDN.....	118
email account for voip unit	Enable Proxy field	
analog.....	E1	286
T1/E1	T1	242
email address for voip	Enable SMTP field	
analog.....	analog.....	211
quick	T1/E1	137
T1/E1	Enable SNMP Agent.....	126, 200
email log reports	Enable SNMP Agent field	
analog.....	analog.....	202
quick	T1/E1	128
recipient	enabling SMTP	
reply-to address.....	analog.....	210
subject line	T1/E1	136
T1/E1	enabling web browser GUI	
email logs, illustration	analog.....	36, 177
analog.....	T1/E1	102
T1/E1	Error Correction (SMTP logs)	
EMC, Safety, R&TTE Directive	analog.....	214
Compliance	T1/E1	140
emergency phone numbers	error correction, forward	
caution about.....	analog.....	184
Enable (Call Fwdg)	T1/E1	109
E1	error message	
T1.....	COM port conflict.....	80
Enable Call Hold	COM port conflict (T1/E1)	172
analog.....	error message (analog models)	
T1/E1	MultiVOIP Not Found	173
Enable Call Transfer	Phone Database Not Read.....	173
analog.....	error message (T1/E1 models)	

- MultiVOIP Not Found 98
- Phone Database Not Read..... 98
- ESF and CRC frame format (T1).. 116
- ethernet cable pinout..... 402
- Ethernet interface
 - analog..... 18
- Ethernet LEDs (analog)
 - COL 21
 - LNK 21
 - RCV 21
 - XMT 21
- European Community Directives.. 394
- Event # (statistics, logs) field..... 332
- Excessive Zeroes (E1 stats) field .. 346
- Excessive Zeroes (T1 stats) field .. 341
- exchanges, phone
 - dedicated 47
 - institutional 47
 - local 47
 - non-local 47
 - organizational 47
- expansion card (analog, 4-to-8 channel) installation..... 408
- expansion card (T1/E1) installation 398
- expansion card (T1/E1)operation.. 400
- F**
- factory default software settings ... 360
- factory defaults, downloading..... 360
- factory repair for customers U.S. & Canada 390
- fast busy (unobtainable) tones
 - analog..... 133, 207
- Fast Connect*See* Fast Start. *See* Fast Start
 - E1 287
 - T1 243
- Fast Start compatibility
 - E1 285
 - T1 241
- Fast Start plus H.245 Tunneling field
 - E1 287
 - T1 243
- fax baud rate, default
 - analog..... 182
 - T1/E1 107
- Fax Enable field
 - analog..... 182
 - T1/E1 107
- fax machine
 - connecting to analog voip (MVP210) 73
 - connecting to analog voip (MVP-410/810) 71
- FAX Parameters
 - analog..... 182
 - T1/E1 107
- fax tones, output level
 - analog..... 182
 - T1/E1 107
- Fax Volume field
 - analog..... 182
 - T1/E1 107
- FCC Declaration 394
- FCC Part 68 Telecom rules 395
- FCC registration number..... 396
- FCC rules, Part 15..... 394
- firmware upgrade, implementing .. 353
- firmware version, identifying..... 353
- firmware, downloading 354
- firmware, obtaining updated 349
- Flash Hook Timer field 195
- forgotten password..... 364, 367
- Forward Address/Number
 - E1 297
 - T1 253
- Forward Condition (Call Fwdg)
 - E1 297
 - T1 253
- Forward Error Correction (call progress) field 328
- Forward Error Correction (SMTP logs)
 - analog..... 214
 - T1/E1 140
- Forward Error Correction field
 - analog..... 184
 - T1/E1 109
- forward on busy
 - T1 253, 297
- Forward upon No Response
 - E1 297
 - T1 253
- Frame Format field
 - E1 121

- T1..... 116
- frame relay, and fax
 - analog..... 182
 - T1/E1 107
- Frame Search Restart Flag (T1 stats)
 - field..... 342
- Frame Type field
 - analog..... 176
 - T1/E1 101
- free calls
 - E1 276
 - T1..... 236
- frequencies, touch tone 197
- Frequency 1 (custom tone) field
 - analog..... 208
 - T1/E1 134
- Frequency 1 (tone pair scheme)
 - analog..... 205
 - T1/E1 131
- Frequency 2 (custom tone) field
 - analog..... 208
 - T1/E1 134
- Frequency 2 (tone pair scheme)
 - analog..... 205
 - T1/E1 131
- frequency, power
 - analog models 25
 - E1 models 24
 - T1 models 23
- FRF11
 - analog..... 182
 - T1/E1 107
- From (gateway, statistics, logs) field
 - 332
- front panel
 - analog models 21
 - E1 16
 - MVP2400..... 13
 - MVP2410..... 13
 - MVP3010..... 16
 - T1 13
- FTP client program 371
- FTP client program, obtaining 373
- FTP client programs
 - graphic vs. textual orientation... 380
- FTP file transfers
 - using FTP client program..... 373
 - using web browser 373
- FTP Server Enable field
 - analog..... 176
 - T1/E1 101
- FTP Server function
 - as added feature..... 371
 - enabling..... 373
- FTP Server, contacting..... 375
- FTP Server, invoking
 - download/transfer
 - using FTP client program..... 379
 - using web browser 377
- FTP Server, logging in 376
- FTP Server, logging out 380
- FTP transfers
 - file types..... 371, 374
 - phonebooks 371
 - server location 371
- FXO Current Detect Timer field ... 196
- FXO Disconnect On fields 196, 197
- FXO disconnection criteria 196
- FXO disconnection, triggering of 196, 197
- FXO interface (MVP210)
 - uses of 73
- FXO Interface Parameter definitions
 - 195, 196
- FXO Interface Parameter Definitions
 - 197
- FXO Interface Parameter fields
 - Disconnect on Call Progress Tone
 - 197
 - Disconnect Tone Sequence 197
 - Ring Count 197
 - Silence Detection 197
 - Silence Timer 197
- FXO interface(MVP-410/810)
 - uses of 71
- FXO Parameter fields
 - Current Loss 196
 - Flash Hook 196
 - FXO Current Detect Timer 196
 - Inter Digit Regeneration Timer . 196
 - Inter Digit Timer (dialing) 195
 - Message Waiting Light 196
 - Regeneration (dialing)..... 195
 - Tone Detection..... 196
- FXO Parameters 194

- FXS Ground Start Interface parameter definitions 192
- FXS Ground Start Parameter fields
- Inter Digit Timer 192
 - Message Waiting Light 192
- FXS Ground Start Parameters 192
- FXS interface(MVP210)
- uses of 73
- FXS interface(MVP-410/810)
- uses of 71
- FXS Loop Start Interface parameter definitions 190
- FXS Loop Start Parameter fields
- Current Loss 191
 - Inter Digit Timer 190
 - Message Waiting Light 190
 - Ring Count 191
- FXS Loop Start Parameters 190
- FXS/FXO connector
- MVP-210 72
 - MVP-410/810 71
- G**
- Gain 1 (custom tone) field
- analog 208
 - T1/E1 134
- Gain 1 (tone pair scheme)
- analog 205
 - T1/E1 131
- Gain 2 (custom tone) field
- analog 208
 - T1/E1 134
- Gain 2 (tone pair scheme)
- analog 205
 - T1/E1 131
- gatekeeper interaction
- analog models 19
 - E1 models 15
 - T1 models 11, 19
- Gatekeeper Name field
- E1 285
 - T1 241
- GateKeeper RAS Parameters
- T1 241
- Gateway (IP Parameters) field
- analog 176
 - T1/E1 101
- Gateway Name (call progress) field 328
- Gateway Name (callee, statistics, logs) field 333
- Gateway Name (caller, statistics, logs) field 333
- Gateway Name field
- E1 285
 - T1 241
- Gateway Number, From Details (SMTP logs) field
- analog 214
 - T1/E1 140
- Gateway Number, To Details (SMTP logs) field
- analog 214
 - T1/E1 140
- Gateway Prefix (Gatekeeper) field
- E1 285
 - T1 241
- Gateway Prefix (outbound phonebook) field
- E1 291
 - T1 247
- grounding
- in rack installations 66
 - MVP210 73
 - MVP410 71
 - MVP810 71
- grounding screw, diagrams (MVP-410/810/2410/3010) 33
- GUI (log reporting type) button
- analog 218
 - T1/E1 143
- H**
- H.245 Tunneling field
- E1 286
 - T1 242
- H.323
- compatibility (analog models) 18
 - compatibility (E1 models) 14
 - compatibility (T1 models) 10
- H.323 Annex E field
- E1 287
 - T1 243
- H.323 coder
- analog 183

- T1/E1 108
- H.323 fields (Outbound Phonebook)
 - E1 291
 - T1 247
- H.323 ID (Gatekeeper) field
 - E1 285
 - T1 241
- H.323 ID (Outbound Phonebook) field
 - T1 247, 291
- H.323 version 4 features
 - E1 14
 - T1 10, 19
- H.323 Version 4 Parameters
 - E1 286, 287
 - T1 242, 243
- H.450 features, incompatible with SIP
 - analog 19, 219
 - E1 15
 - T1 11
 - T1/E1 145
- H.450 functionality
 - logs for 334
- Hold Sequence
 - analog 223
 - T1/E1 149
- Hold Sequence (analog) 220
- Hold Sequence (T1/E1) 146
- hookup
 - MVP210 34
 - MVP2400 34
 - MVP2410 33
 - MVP3010 33
 - MVP410 33
 - MVP810 33
- HyperTerminal program
 - and connectivity testing 54, 55
- I**
- IANA 406
- icon
 - variable version 9, 77
- icons, phonebook
 - E1 282
 - T1 238
- identifying current firmware version
 - 353
- implementing firmware upgrade... 353
- in band, DTMF
 - analog 182
 - T1/E1 107
- inbound phonebook
 - example 49
- Inbound Phonebook Entries List icon
 - E1 282
 - T1 238
- Inbound Phonebook entries, list
 - E1 295
 - T1 251
- inbound phonebook example
 - quick 43
- inbound vs. outbound phonebooks
 - E1 280
 - T1 236
- Industry Canada requirements 395
- info sources
 - analog telephony details 30, 166
 - E1 details 30
 - E1 telephony details 91
 - IP details 29
 - IP details (analog system) 165
 - IP details (T1/E1 system) 89
 - SMTP details 31
 - T1 details 29
 - T1 telephony details 90
 - voip email account 31
- info sources (analog models)
 - SMTP details 167
 - voip email account 167
- info sources (T1/E1 models)
 - SMTP details 92
 - voip email account 92
- Input Gain field
 - analog 181
 - T1/E1 106
- installation
 - airflow 66
 - analog prerequisites 165, 166
 - E1 prerequisites 30, 91
 - expansion card (analog, 4-to-8 channel) 408
 - expansion card (T1/E1) 398
 - full summary 28
 - in a nutshell 26
 - in rack 65
 - IP prerequisites 29, 30

- log reports by email (analog models) 167
- log reports by email (T1/E1 models) 92
- software (detailed) 75
- T1 prerequisites..... 29, 90
- T1/E1 prerequisites..... 89
- upgrade card (analog, 4-to-8 channel)..... 408
- upgrade card (T1/E1) 398
- voip email account(analog models) 167
- voip email account(T1/E1 models) 92
- installation preparations (optional)
 - log reports by email 31
 - voip email account 31
- installation, mechanical
 - analog models 18
 - E1 models 14
 - T1 models 10
- installation, quick
 - log reports by email 31
 - voip email account 31
- installing Java vis-a-vis web GUI. 383
- integrated phone/data networks 275
- Inter Digit Regeneration Time field 196
- Inter Digit Timer (dialing) field
 - FXO 195
 - FXS Ground Start 192
 - FXS Loop Start 190
- Interface field (E&M) 199
- interface parameters, accessing..... 188
- interface parameters, setting 188
- interfaces
 - analog telephony 33
- inter-office dialing
 - E1 276
 - T1 237
- inter-operation (analog)
 - with T1/E1 voips..... 18
- inter-operation with phone system
 - analog models 18
 - E1 models 14
 - T1 models 10
- IP Address (call progress) field..... 328
- IP Address (callee, statistics, logs)
 - field 333
- IP Address (caller, statistics, logs)
 - field 333
- IP Address (Gatekeeper) field
 - E1 285
 - T1 241
- IP Address (outbound phonebook)
 - E1 290
 - T1 246
- IP Address field
 - analog 176
 - T1/E1 101
- IP Address, From Details (SMTP logs) field
 - analog 214
 - T1/E1 140
- IP address, SysLog Server
 - analog 218
 - T1/E1 144
- IP Address, To Details (SMTP logs) field
 - analog 214
 - T1/E1 140
- IP Mask field
 - analog 176
 - T1/E1 101
- IP parameter definitions
 - analog 176
 - T1/E1 101
- IP Parameter fields (analog)
 - DNS Server IP Address..... 176
 - Enable Diffserv 176
 - Enable DNS..... 176
 - Frame Type 176
 - FTP Server Enable 176
 - Gateway 176
 - IP Address 176
 - IP Mask 176
- IP Parameter fields (T1/E1)
 - DNS Server IP Address..... 101
 - Enable Diffserv 101
 - Enable DNS..... 101
 - Frame Type 101
 - FTP Server Enable 101
 - Gateway 101
 - IP Address 101
 - IP Mask 101

- IP Parameters screen, accessing
 - analog..... 174
 - T1/E1 99
- IP startup configuration 36
- IP Statistics field definitions . 335, 337
- IP Statistics fields
 - Clear..... 335
 - Received (RTCP Packets)..... 338
 - Received (RTP Packets) 338
 - Received (TCP Packets) 337
 - Received (Total Packets) 335
 - Received (UDP Packets)..... 337
 - Received with errors (RTCP Packets)..... 338
 - Received with errors (RTP Packets) 338
 - Received with errors (TCP Packets) 337
 - Received with errors (Total Packets)..... 337
 - Received with errors (UDP Packets)..... 337
 - Transmitted (RTCP Packets) 338
 - Transmitted (RTP Packets)..... 338
 - Transmitted (TCP Packets)..... 337
 - Transmitted (Total Packets)..... 335
 - Transmitted (UDP Packets) 337
- IP Statistics function 335
- ISDN parameters, setting 125
- ISDN-PRI
 - types supported 125
- ISDN-PRI implementations 125
- J**
- Java
 - installing 383
 - web GUI and 383
- jitter buffer
 - analog..... 185
 - T1/E1 110
- Jitter Value (Fax) field
 - analog..... 182
 - T1/E1 107
- Jitter Value field
 - analog..... 187
 - T1/E1 112
- jitter, dynamic
 - analog..... 185
- T1/E1 110
- K**
- key system
 - connecting to analog voip (MVP210) 73
 - connecting to analog voip (MVP-410/810) 71
- L**
- lab voip network
 - use in setup..... 48
- Last button
 - Logs (Statistics) screen 332
- LED definitions
 - analog models 21
 - E1 16
 - MVP2400..... 13
 - MVP2410..... 13
 - MVP3010..... 16
 - T1 13
- LED definitions (analog)
 - Boot..... 21
 - COL..... 21
 - Ethernet 21
 - LNK 21
 - Power 21
 - RCV (channel)..... 21
 - RCV (Ethernet) 21
 - RSG..... 21
 - XMT (channel) 21
 - XMT (Ethernet)..... 21
 - XSG..... 21
- LED definitions (E1)
 - Boot..... 16
 - COL..... 16
 - E1 17
 - IC 17
 - LC 17
 - LNK 16
 - LS..... 17
 - ONL 17
 - Power 16
 - PRI 17
 - RCV 16
 - XMT..... 16
- LED definitions (T1)
 - Boot..... 13

COL	13	detailed, T1/E1	94
IC	13	summary, analog	168
LC	13	summary, T1/E1	93
LNK	13	local exchange numbers	47
LS	13	local voip configuration (analog) ..	163
ONL	13	local voip configuration (T1/E1).....	87
Power	13	local Windows GUI vs. web GUI	
PRI	13	comparison	382
RCV	13	local-rate access (E1)	
T1	13	to remote PSTN.....	14
XMT	13	local-rate calls to remote voip sites	
LED indicators		E1	277
E1	16	log report email, customizing	
T1	12	analog.....	213, 214
LED indicators (analog)		T1/E1	139, 140
channel operation.....	20	log report email, triggering	
general operation.....	20	analog.....	212
LED indicators, active		T1/E1	138
analog.....	20	log reporting method, setting	
E1	16	analog	216
T1	12	T1/E1	142
LED sets (T1/E1), left and right ...	400	log reports	
LED types		analog models	167
analog models	20	T1/E1 models	92
lifting		log reports & SMTP	
precaution about.....	60	analog.....	210
limitations notice (regulatory),		T1/E1	136
Canadian	396	log reports and SMTP	
limited warranty.....	390	quick.....	37
Line Build Out field		log reports by email	
E1	124	analog.....	210
T1	119	quick.....	37
Line Coding field		T1/E1	136
E1	124	log reports, quick.....	31
T1	119	logging options	
Line Loopback Activation Signal (T1		analog	217
stats) field.....	342	T1/E1	143
Line Loopback Deactivation Signal		logging update interval	
(T1 stats) field.....	341	analog	217
lithium battery caution	60	T1/E1	143
LNK LED		logging, web GUI and.....	382
analog models	21	Login Name (SMTP) field	
loading of weight in rack	66	analog.....	211
local configuration		T1/E1	137
analog.....	165	Logs (Statistics) fields	
T1/E1	89	Bytes received.....	333
local configuration procedure		Bytes Sent	332
detailed, analog	169	Call Forwarded to.....	334

- Call Transferred to 334
 - CT Ph# 334
 - Duration 332
 - Event # 332
 - From (gateway) 332
 - Gateway Name (callee) 333
 - Gateway Name (caller) 333
 - H.450 functionality 334
 - IP Address (callee) 333
 - IP Address (caller) 333
 - Mode 332
 - Options (caller) 333
 - Options callee 333
 - Outbound digits 333
 - Packets Lost 333
 - Packets received 333
 - Packets Sent 332
 - Start Date, Time 332
 - Status 332
 - Supplementary Services info 334
 - To (gateway) 332
 - Voice coder 333
 - Logs (Statistics) function 331
 - Logs (Statistics) screen
 - Delete File button 332
 - Last button 332
 - logs and web browser GUI
 - analog 217
 - T1/E1 143
 - logs by email, illustration
 - analog 215
 - T1/E1 141
 - Logs screen definitions
 - analog 217
 - T1/E1 143
 - Logs screen field definitions
 - analog 218
 - T1/E1 143
 - Logs screen parameters (analog)
 - Enable Console Messages 218
 - GUI 218
 - IP Address (SysLog Server) 218
 - Online Statistics Updation Interval 218
 - Port (SysLog Server) 218
 - SMTP 218
 - SNMP 218
 - SysLog Server Enable 218
 - Turn Off Logs 218
 - Logs screen parameters (T1/E1)
 - Enable Console Messages 143
 - GUI 143
 - IP Address (SysLog Server) 143
 - Online Statistics Updation Interval 143
 - Port (SysLog Server) 143
 - SMTP 143
 - SNMP 143
 - SysLog Server Enable 143
 - Turn Off Logs 143
 - logs screen, accessing
 - analog 216
 - T1/E1 142
 - long distance call savings
 - T1 236
 - long-distance call savings
 - E1 275
 - Long-Haul Mode field
 - E1 121
 - T1 116
 - Loss of Frame Alignment (E1 stats)
 - field 344
 - Loss of Frame Alignment (T1 stats)
 - field 341
 - Loss of MultiFrame Alignment (E1 stats)
 - field 345
 - Loss of MultiFrame Alignment (T1 stats)
 - field 342
 - lost packets, consecutive
 - analog 187
 - T1/E1 112
 - lost password 364, 367
- M**
- Mac Address
 - System Info (analog) 232
 - System Info (T1/E1) 158, 323
 - mail criteria (SMTP), records
 - analog 212
 - T1/E1 138
 - Mail Server IP Address (SMTP) field
 - analog 211
 - T1/E1 137
 - Mail Type (SMTP logs) field
 - analog 212
 - T1/E1 138

- mains frequency
 - analog models 25
 - E1 models 24
 - T1 models 23
- management (analog)
 - local 19
 - remote (SNMP)..... 19
 - remote (web browser GUI) 19
- management (E1 models)
 - local 15
 - remote (SNMP)..... 15
 - remote (web browser GUI) 15
- management (T1 models)
 - local 11
 - remote (SNMP)..... 11
 - remote (web browser GUI) 11
- management of voips, remote
 - analog..... 200
 - T1/E1 126
- Max bandwidth (coder)
 - analog..... 183
 - T1/E1 108
- Max Baud Rate field
 - analog..... 182
 - T1/E1 107
- maximum cable span
 - E1 121
 - T1 116
- Maximum Jitter Value field
 - analog..... 186
 - T1/E1 111
- Message Waiting Light (FXO)
 - and Avaya Magix PBX 195
 - and DID 195
- Message Waiting Light (FXS Ground Start)
 - and Avaya Magix PBX 192
 - and DID 192
- Message Waiting Light (FXS Loop Start)
 - and Avaya Magix PBX 191
 - and DID 191
- Message Waiting Light field
 - FXO 195
 - FXS Ground Start 192
 - FXS Loop Start 191
- Minimum Jitter Value field
 - analog..... 185
 - T1/E1 110
- Mode (call progress) field 327
- Mode (Fax) field
 - analog 182
 - T1/E1 107
- Mode (statistics, logs) field 332
- model descriptions
 - E1 14
- mounting
 - analog models 18
 - E1 models..... 14
 - T1 models..... 10
- mounting in rack 65
 - procedure for 67
 - safety 60, 66
- mounting options..... 8
- mounting, physical
 - quick..... 32
- Multiplexed UDP field
 - E1 287
 - T1 243
- MultiVOIP configuration software .35
 - analog 19
 - E1 models..... 15
 - T1 models..... 11
- MultiVOIP Program Menu items ..347
- MultiVOIP Program Menu options
 - Configuration 347
 - Date & Time Setup 347
 - Download CAS Protocol..... 347
 - Download Factory Defaults 348
 - Download Firmware..... 348
 - Set Password 348
 - Uninstall 348
 - Upgrade Software 348
- MultiVOIP program menu, option
 - descriptions 347, 348
- MultiVOIP software
 - installing..... 75
 - location of files..... 78
 - program icon location 79
 - uninstalling..... 82, 368
- MultiVOIP software (analog)
 - moving around in 173
- MultiVOIP software (T1/E1)
 - moving around in 98
- MultiVoipManager..... 9
 - analog..... 163

T1/E1 88

MultiVoipManager software

- analog..... 19
- E1 models 15
- T1 models 11

MVP210

- grounding 73
- unpacking..... 64

MVP2400

- cabling procedure..... 69
- unpacking..... 62

MVP2410

- cabling procedure..... 68
- unpacking..... 61

MVP3010

- cabling procedure..... 68
- unpacking..... 61

MVP410

- cabling procedure..... 70, 72
- grounding 71
- unpacking..... 63

MVP810

- cabling procedure..... 70
- grounding 71
- unpacking..... 63

N

national-rate calls to foreign voip sites

- E1 279

network access

- analog..... 202
- T1/E1 128

Network Disconnection field

- analog..... 187
- T1/E1 112

network/terminal settings, voip and PBX

- E1/ISDN 123
- T1/ISDN 118

Number of Days (email log criteria)

- analog..... 212
- T1/E1 138

Number of Records (email log criteria)

- analog..... 212
- T1/E1 138

numbering plan resources 318

O

obtaining updated firmware 349

official phone numbers

- caution about 48

Online Statistics Updation Interval field (Logs)

- analog 218
- T1/E1 144

operating system 22

operating temperature 66

operating voltage

- analog models 25
- T1 models..... 23, 24

operation

- expansion card (T1/E1)..... 400

Operator (ISDN) field

- E1/ISDN..... 123
- T1/ISDN..... 118

Optimization Factor field

- analog 186
- T1/E1 111

Options (call progress) field..... 328

Options (callee, statistics, logs) field

- 333

Options, From Details (SMTP logs) field

- analog..... 214
- T1/E1 140

Options, To Details (SMTP logs) field

- analog..... 214
- T1/E1 140

out of band, DTMF

- analog 182
- T1/E1 107

Outbound Digits (call progress) field

- 327

Outbound Digits (SMTP logs) field

- analog..... 214
- T1/E1 140

Outbound digits (statistics, logs) field

- 333

outbound phonebook

- example 49

Outbound Phonebook Entries List icon

- E1 282
- T1 238

Outbound Phonebook entries, list

- E1 288
- T1 244
- outbound phonebook example
 - quick 39
- outbound vs. inbound phonebooks
 - E1 280
 - T1 236
- Output Gain field
 - analog 181
 - T1/E1 106
- output level, fax tones
 - analog 182
 - T1/E1 107
- outside line, access to 47, 49
- P**
- Packets Lost (call progress) field .. 327
- Packets Lost (SMTP logs) field
 - analog 213
 - T1/E1 139
- Packets lost (statistics, logs) field . 333
- Packets Received (call progress) field
 - 327
- Packets Received (SMTP logs) field
 - analog 213
 - T1/E1 139
- Packets received (statistics, logs) field
 - 333
- Packets Sent (call progress) field .. 327
- Packets Sent (SMTP logs) field
 - analog 213
 - T1/E1 139
- Packets sent (statistics, logs) field 332
- packets, consecutive lost
 - analog 187
 - T1/E1 112
- Parallel H.245 field
 - E1 287
 - T1 243
- Pass Through (E&M) field 199
- Password (SMTP) field
 - analog 211
 - T1/E1 137
- password, lost/forgotten 364, 367
- password, setting 364
 - web browser GUI 367
- patents 2
- patterns, destination
 - tips about 46
- PBX characteristics, variations in
 - E1 317
 - T1 273
- PBX interaction
 - analog models 18
 - E1 models 14
 - T1 models 10
- PC, command
 - COM port assignment (detailed) . 80
 - COM port requirement 32
 - demands upon 32
 - non-dedicated use 32
 - operating system 32
 - settings 32
 - specifications 32
- PCM Law field
 - E1 124
 - T1 119
- Permissions (SNMP) field
 - analog 202
 - T1/E1 128
- personnel requirement
 - for rack installation 66
 - to lift during installation 67
 - to lift unit during installation 60
- phone exchanges
 - dedicated 47
 - institutional 47
 - local 47
 - non-local 47
 - organizational 47
- Phone Number (Auto Call) field
 - analog 184
- Phone Number (Auto Call)field
 - T1/E1 109
- Phone Signaling Tones & Cadences
 - analog 203
 - T1/E1 129
- phone startup configuration 36
- phone switch types
 - ISDN implementations in 125
- phone/IP details
 - importance of writing down 28
 - importance of writing down
 - (analog) 165
 - importance of writing down
 - (T1/E1) 89

- phonebook
 - FTP remote file transfers 371
- phonebook configuration
 - starter 39
- phonebook configuration (analog) 162, 321
- phonebook configuration (remote) 371
- phonebook configuration (T1/E1) .. 87
- Phonebook Configuration icon
 - E1 282
 - T1 238
- Phonebook Configuration Parameter definitions
 - E1 285, 286, 287
 - T1 241, 242, 243
- Phonebook Configuration procedure
 - T1 237
- Phonebook Configuration Procedure
 - E1 281
- Phonebook Configuration screen
 - E1 284
 - T1 237
- Phonebook Configuration screen fields (E1)
 - Annex E (H.323, UDP multiplexing)..... 287
 - Call Signalling Port..... 285
 - Enable Proxy..... 286
 - Gatekeeper Name..... 285
 - Gateway Name..... 285
 - Gateway Prefix 285
 - H.245 Tunneling 286
 - H.323 ID 285
 - IP Address (Gatekeeper) Name 285
 - Parallel H.245 (Tunneling with Fast Start) 287
 - Port Number (Gatekeeper)..... 285
 - Port Number (proxy server)..... 286
 - Proxy Server IP Address..... 286
 - Q.931 Multiplexing..... 286
 - Use Fast Start..... 285
- Phonebook Configuration screen fields (T1)
 - Annex E (H.323, UDP multiplexing)..... 243
 - Call Signalling Port..... 241
 - Enable Proxy..... 242
 - Gatekeeper Name..... 241
 - Gateway Name 241
 - Gateway Prefix..... 241
 - H.245 Tunneling 242
 - H.323 ID 241
 - IP Address (Gatekeeper) Name. 241
 - Parallel H.245 (Tunneling with Fast Start)..... 243
 - Port Number (Gatekeeper) 241
 - Port Number (proxy server) 242
 - Proxy Server IP Address 242
 - Q.931 Multiplexing..... 242
 - Use Fast Start 241
- phonebook destination patterns 46
- phonebook dialing patterns 46
- phonebook digits
 - dropping 47
 - leading 47
 - non-PSTN type..... 47
 - specialized codes..... 47
 - types used..... 46
- phonebook entries, coordinating
 - E1 281
 - T1 237
- phonebook examples
 - analog..... 162
 - mixed digital/analog..... 49
- phonebook icons
 - E1 282
 - T1 238
- phonebook objectives & considerations
 - E1 280
- phonebook sidebar menu
 - E1 283
 - T1 239
- phonebook tips 46
- phonebook worksheet 52, 53
- phonebook, analog voips..... 321
- phonebook, inbound
 - example 49
 - example, quick 43
- phonebook, outbound
 - example 49
 - example, quick 39
- phonebooks, inbound vs. outbound
 - E1 280
 - T1 236

- phonebooks, objectives & considerations
 - T1..... 236
 - Phonebooks, objectives & considerations
 - E1..... 275
 - phonebooks, sample..... 51
 - physical mounting, quick..... 32
 - pinging and connectivity..... 58
 - pinout
 - command cable 402
 - ethernet cable 402
 - T1/E1 connector..... 403
 - Voice/FAX connector 403
 - placement (physical), quick 32
 - Port field, SysLog Server
 - analog..... 218
 - T1/E1 144
 - Port Number (Gatekeeper) field
 - E1 285
 - T1 241
 - Port Number (proxy server)
 - E1 286
 - T1 242
 - Port Number (SMTP) field
 - analog..... 211
 - T1/E1 137
 - port number (SNMP) field
 - analog..... 202
 - T1/E1 128
 - power consumption
 - analog models 25
 - E1 models 24
 - T1 models 23
 - power frequency
 - analog models 25
 - E1 models 24
 - T1 models 23
 - Power LED
 - analog models 21
 - Prefix Matched (call progress) field
 - 327
 - Prefix Matched (SMTP logs) field
 - analog..... 214
 - T1/E1 140
 - prerequisites
 - for technical configuration (analog)
 - 165
 - for technical configuration (T1/E1)
 - 89
 - prerequisites for installation
 - E1 info..... 30
 - IP info..... 29
 - T1 info..... 29
 - PRI
 - ISDN implementations..... 125
 - product CD..... 26
 - use in software installation.... 35, 75
 - Product CD
 - analog..... 19
 - E1 models..... 15
 - T1 models..... 11
 - product family 8, 9
 - product groups 8
 - Program Menu items 347
 - Protocol Type (outbound phonebook)
 - E1 290
 - T1 246
 - Proxy Server IP Address
 - E1 286
 - T1 242
 - Proxy Server Parameters
 - E1 286
 - T1 242
 - Pulse Density Violation (T1 stats)
 - field 342
 - Pulse Generation Ratio (analog) field
 - 206
 - Pulse Shape Level field
 - E1 124
 - T1 119
- ## Q
- Q.931 Multiplexing field
 - E1 286
 - T1 242
 - Q.931 Parameters
 - T1 241
 - Q.931 Port Number (outbound phonebook) field
 - E1 291
 - T1 247
- ## R
- rack mounting
 - grounding 66

- safety..... 60, 66
- rack mounting instructions..... 65
- rack mounting procedure 67
- rack, equipment
 - weight capacity of..... 66
- rack-mountable voip models..... 60
- RCV (channel) LED
 - analog models..... 21
- RCV (Ethernet) LED
 - analog models 21
- Receive Slip (E1 Stats) field 346
- Receive Slip (T1 Stats) field 343
- Receive Timeslot 16 Alarm Indication Signal (E1 stats) field..... 345
- Receive Timeslot 16 Loss of MultiFrame Alignment (E1 stats) field..... 346
- Receive Timeslot 16 Loss of Signal (E1 stats) field..... 345
- Received (RTCP Packets, IP Stats) field..... 338
- Received (RTP Packets, IP Stats) field 338
- Received (TCP Packets, IP Stats) field 337
- Received (Total Packets, IP Stats) field..... 336
- Received (UDP Packets, IP Stats) field..... 337
- Received with Errors (RTCP Packets, IP Stats) field 338
- Received with Errors (RTP Packets, IP Stats) field 338
- Received with Errors (TCP Packets, IP Stats) field 337
- Received with Errors (Total Packets, IP Stats) field 337
- Received with Errors (UDP Packets, IP Stats) field 337
- Recipient Address (email logs) field T1/E1 138
- Recipient Address (email logs)field analog..... 212
- recovering voice packets
 - analog..... 184
 - T1/E1 109
- Red Alarm (E1 stats) field 344
- Red Alarm (T1 stats) field 341
- Regeneration (dialing, FXO) field 195
- Regional Parameter definitions
 - analog..... 205, 206
 - T1/E1 131, 132
- Regional Parameter fields (analog)
 - Cadence..... 206
 - Custom (tones)..... 206
 - Pulse Generation Ratio..... 206
- Regional Parameter fields (T1/E1)
 - Cadence..... 132
 - Country/Region (tone schemes) 131
 - Custom (tones)..... 132
 - Frequency 1..... 131
 - Frequency 2..... 131
 - Gain 1..... 131
 - Gain 2..... 131
 - type (of tone)..... 131
- regional parameters, setting
 - analog..... 203
 - T1/E1 129
- remote control/configuration
 - web GUI and 383
- remote phonebook configuration .. 371
- remote voip
 - using to confirm configuration 31, 39
- remote voip configuration (analog) 163
- remote voip configuration (T1/E1) .87
- Remote Voip Management
 - analog..... 200
 - T1/E1 126
- Remove Prefix (inbound) field
 - E1 296
 - T1 252
- Remove Prefix (outbound) field
 - E1 290
 - T1 246
- repair procedures for customers U.S. & Canada 390
- Reply-To Address (email logs) field T1/E1 138
- Reply-To Address (email logs)field analog..... 212
- Reports function..... 334
- Retrieve Sequence
 - analog..... 223
 - T1/E1 149

Retrieve Sequence (analog)	220
Retrieve Sequence (T1/E1).....	146
RFC768.....	406
RFC793.....	406
ring cadences, custom	
analog.....	207, 209
T1/E1	133, 135
Ring Count (FXO) field.....	197
Ring Count field	
FXS Ground Start	193
FXS Loop Start.....	191
Ring Count forwarding condition	
E1.....	297
T1.....	253
ring tone, custom	
analog.....	207, 208
T1/E1	133, 134
ring-tones	
analog.....	207
T1/E1	133
Round Trip Delay field	
E1.....	294
T1.....	250
RSG LED	
analog models.....	21
S	
Safety Recommendations for Rack	
Installations.....	66
safety warnings	60
Safety Warnings Telecom	60
sample phonebooks.....	51
Save Setup command	
analog.....	233
T1/E1	159
saving configuration	
analog.....	233
T1/E1	159
user.....	362
saving tech configuration.....	38
Saving the MultiVOIP Configuration	
analog.....	233
T1/E1	159
savings on toll calls	
E1.....	275
T1.....	236
scale-ability	
E1.....	14
T1	10
second dial tone	
and comma use.....	48
Select All (SMTP logs) field	
analog.....	213
T1/E1	139
Select Channel field	
analog.....	181
T1/E1	106
Select Channel, Supplementary	
Services field	
analog.....	222
T1/E1	148
Selected Coder field	
analog.....	183
T1/E1	108
Set Baud Rate	
analog.....	230
T1/E1	156
Set Custom Tones & Cadences	
analog.....	207
T1/E1	133
Set ISDN Parameters	125
Set Log Reporting Method	
analog.....	216
T1/E1	142
Set Password (program menu option) ,	
command.....	364
Set Password (web browser GUI) ,	
command.....	367
Set Password option description	
(MultiVOIP program menu)	348
Set Regional Parameters	
analog.....	203
T1/E1	129
Set SMTP Parameters	
analog.....	210
T1/E1	136
Set SNMP Parameters	
analog.....	200
T1/E1	126
Set Supplementary Services	
Parameters	
analog.....	219
T1/E1	145
Set T1/E1/ISDN Parameters	113
Set Telephony Interface Parameters	
.....	188

-
- Set Voice/FAX Parameters
 - analog..... 178
 - T1/E1 103
 - setting IP parameters
 - analog..... 174
 - T1/E1 99
 - setting password..... 364
 - web browser GUI..... 367
 - setting user defaults 362
 - setup, saving
 - analog..... 233
 - T1/E1 159
 - user..... 362
 - setup, saving user values..... 362
 - Signal (type, E&M) field 199
 - signaling cadences
 - analog..... 203
 - T1/E1 129
 - signaling parameters (analog telephony) 188
 - signaling tones
 - analog..... 203
 - T1/E1 129
 - signaling types
 - analog telephony 33
 - analog telephony (MVP210)..... 73
 - analog telephony (MVP-410/810) 71
 - Silence Compression (call progress)
 - field..... 328
 - Silence Compression (SMTP logs)
 - analog..... 214
 - T1/E1 140
 - Silence Compression field
 - analog..... 184
 - T1/E1 109
 - Silence Detection (FXO) field 197
 - Silence Timer (FXO) field..... 197
 - simulated voip network
 - use in startup 48
 - SIP
 - compatibility
 - analog models 19
 - E1 models 15
 - T1 models 11
 - SIP Fields (Outbound Phonebook)
 - E1 292
 - T1 248
 - SIP incompatibility with H.450
 - Supplementary Services
 - analog..... 19, 219
 - E1 15
 - T1 11
 - T1/E1 145
 - SIP Port Number field
 - E1 292
 - T1 248
 - SIP port number, standard
 - E1 292
 - T1 248
 - SIP URL field
 - E1 292
 - T1 248
 - SMTP
 - quick setup 37
 - SMTP (log reporting type) button
 - analog..... 218
 - T1/E1 144
 - SMTP logs by email, illustration
 - analog..... 215
 - T1/E1 141
 - SMTP Parameters definitions
 - analog..... 211
 - T1/E1 137
 - SMTP Parameters fields (analog)
 - Enable SMTP 211
 - Login Name..... 211
 - Mail Server IP Address 211
 - Mail Type..... 212
 - Number of Days 212
 - Number of Records 212
 - Password 211
 - Port Number 211
 - Recipient Address 212
 - Reply-To Address 212
 - Subject..... 212
 - SMTP Parameters fields (T1/E1)
 - Enable SMTP 137
 - Login Name..... 137
 - Mail Server IP Address 137
 - Mail Type..... 138
 - Number of Days 138
 - Number of Records 138
 - Password 137
 - Port Number 137
 - Recipient Address 138
-

Reply-To Address	138	software	
Subject	138	control	35
SMTP parameters, accessing		uninstalling (detailed)	82
analog.....	210	updates (analog)	163
T1/E1	136	updates (T1/E1).....	88
SMTP parameters,setting		software (MultiVOIP)	
analog.....	210	uninstalling.....	368
T1/E1	136	software configuration	
SMTP port, standard		summary.....	75
analog	211	software installation	
T1/E1	137	detailed.....	75
SMTP prerequisites		quick.....	35
analog models	167	software loading.....	75
quick	31	software loading, quick	35
T1/E1 models.....	92	software version numbers	77
SMTP, enabling		software, MultiVOIP (analog)	
analog.....	210	screen-surfing in.....	173
T1/E1	136	software, MultiVOIP (T1/E1)	
SNMP (log reporting type) button		moving around in	98
analog.....	218	screen-surfing in.....	98
T1/E1	144	software, MultiVOIP(analog)	
SNMP agent program		moving around in	173
analog.....	163	software, on command PC	35
T1/E1	88	Solving Common Connection	
SNMP agent, enabling		Problems	
analog.....	200	analog.....	172
T1/E1	126	T1/E1	97
SNMP Parameter Definitions		sound quality, improving	
T1/E1	128	analog	184
SNMP Parameter fields (analog)		T1/E1	109
Address	202	specialized codes, in dialing.....	47
Community Name (2)	202	specifications	
Community Name 1	202	analog models	25
Enable SNMP Agent.....	202	E1 models.....	24
Permissions (1)	202	T1 models.....	23
Permissions (2)	202	Start Date, Time (SMTP logs) field	
Port Number.....	202	analog.....	213
SNMP Parameter fields (T1/E1)		T1/E1	139
Address	128	Start Date,Time (statistics, logs) field	
Community Name (2)	128	332
Community Name 1	128	starter configuration	
Enable SNMP Agent.....	128	inbound phonebook.....	43
Permissions (1)	128	outbound phonebook.....	39
Permissions (2)	128	phone/IP	36
Port Number.....	128	startup tasks.....	28
SNMP Parameters, setting		Options (caller.....	333
analog.....	200	Status (call progress) field.....	330
T1/E1	126	Status (statistics, logs) field.....	332

- Status Freeze Signalling Active (E1 stats) field..... 345
- Status Freeze Signalling Active (T1 stats) field..... 341
- Subject (email logs) field
 - analog..... 212
 - T1/E1 138
- supervisory signaling
 - analog telephony 33
- supervisory signaling (analog) 189
- supervisory signaling parameters (analog telephony) 188
- supervisory signaling types
 - MVP210..... 73
 - MVP-410/810 71
- Supplementary Services (analog)
 - Alerting Party..... 226, 227, 228
 - Call Hold..... 220
 - Call Hold Enable..... 223
 - Call Name Identification..... 220
 - Call Transfer 220
 - Call Waiting..... 220
 - Call Waiting Enable..... 223
 - Caller Name Identification Enable 224
 - Calling Party 225
 - Enable Call Hold..... 223
 - Enable Call Transfer 222
 - Enable Call Waiting..... 223
 - Enable Caller Name Identification 224
 - Hold Sequence 223
 - Retrieve Sequence..... 223
 - Select Channel 222
 - Transfer Sequence..... 222
- Supplementary Services (T1/E1)
 - Alerting Party..... 152, 153, 154
 - Call Hold..... 146
 - Call Hold Enable..... 149
 - Call Name Identification..... 147
 - Call Transfer 146
 - Call Transfer Enable 148, 222
 - Call Waiting..... 146
 - Call Waiting Enable..... 149
 - Caller Name Identification Enable 150
 - Calling Party 151
 - Enable Call Hold..... 149
 - Enable Call Transfer 148
 - Enable Call Waiting 149
 - Enable Caller Name Identification 150
 - Hold Sequence 149
 - Retrieve Sequence..... 149
 - Select Channel..... 148
 - Transfer Sequence..... 148
- Supplementary Services Info
 - logs for 334
- Supplementary Services Parameter buttons (analog)
 - Copy Channel..... 229
 - Default..... 229
- Supplementary Services Parameter buttons (T1/E1)
 - Copy Channel..... 155
 - Default..... 155
- Supplementary Services Parameter Definitions
 - analog..... 222, 223, 224, 225, 226, 227, 228, 229
 - T1/E1..... 148, 149, 150, 151, 152, 153, 154, 155
- Supplementary Services Parameter fields (analog)
 - Call Transfer Enable 222
 - Call Waiting Enable 223
 - Hold Sequence 223
 - Retrieve Sequence..... 223
 - Transfer Sequence..... 222
- Supplementary Services Parameter fields (analog)
 - Alerting Party 226
 - Allowed Name Types..... 225, 226, 227, 228
 - Busy Party 227
 - Call Hold Enable 223
 - Call Name Identification Enable..... 224
 - Caller ID..... 229
 - Calling Party 225
 - Connected Party 228
 - Select Channel..... 222
- Supplementary Services Parameter fields (T1/E1)
 - Call Transfer Enable 148
 - Call Waiting Enable 149
 - Hold Sequence 149

- Retrieve Sequence..... 149
 - Transfer Sequence..... 148
 - Supplementary Services Parameter fields (T1/E1)
 - Alerting Party..... 152
 - Allowed Name Types 151, 152, 153, 154
 - Busy Party..... 153
 - Call Hold Enable..... 149
 - Call Name Identification Enable 150
 - Caller ID 155
 - Calling Party 151
 - Connected Party 154
 - Select Channel 148
 - Supplementary Services Parameters
 - screen, accessing
 - analog..... 219
 - T1/E1 145
 - Supplementary Services parameters, setting
 - analog..... 219
 - T1/E1 145
 - Supplementary Services, incompatible with SIP
 - analog..... 19, 219
 - E1 15
 - T1 11
 - T1/E1 145
 - support, technical 392
 - switch types (phone) and ISDN-PRI 125
 - SysLog client programs
 - availability 386
 - features & presentation types.... 388
 - SysLog Server Enable field
 - analog..... 218
 - T1/E1 144
 - SysLog Server function
 - as added feature 386
 - capabilities of..... 388
 - enabling..... 387
 - location of..... 386
 - SysLog Server IP Address field
 - analog..... 218
 - T1/E1 144
 - SysLog Server, enabling
 - analog..... 217
 - T1/E1 143
 - System Information screen
 - for op & maint..... 323
 - System Information screen, accessing
 - analog 231
 - T1/E1 157
 - System Information update interval, setting
 - analog 231
 - for op & maint..... 324
 - T1/E1 157
- T**
- T1 model descriptions 10
 - T1 Parameter definitions 116, 117, 119
 - Clocking 119
 - Line Build-Out 119
 - Line Coding..... 119
 - PCM Law 119
 - Pulse Shape Level 119
 - Yellow Alarm Format 119
 - T1 Parameter fields
 - CAS Protocol 117
 - CRC Check 116
 - Frame Format 116
 - Long-Haul Mode..... 116
 - T1/E1/ISDN 116
 - T1 Parameters screen 115
 - T1 Statistics field definitions 342, 343
 - T1 Statistics fields
 - Bipolar Violation..... 343
 - Frame Search Restart Flag 342
 - Line Loopback Activation Signal 342
 - Loss of MultiFrame Alignment. 342
 - Pulse Density Violation..... 342
 - Receive Slip 343
 - Transmit Data Underrun 342
 - Transmit Line Open 342
 - Transmit Slip..... 342
 - Transmit Slip Negative 342
 - Yellow Alarm..... 342
 - T1 telephony parameters 90
 - T1/E1 connector pinout..... 403
 - T1/E1 Statistics function 339
 - T1/E1/ISDN field
 - E1 121
 - T1 116

- T1/E1/ISDN Parameters screen,
 accessing 113
T1/E1/ISDN parameters, setting ... 113
T1/ISDN Parameter definitions 118
T1/ISDN Parameter fields
 Country 118
 Enable ISDN-PRI 118
 Operator 118
 Terminal Network 118
table-top voip models 60
TCP/UDP compared
 E1 292
 IP Statistics context 336
 T1 248
tech configuration
 saving 38
technical configuration
 startup 36
technical configuration (analog)
 prerequisites to 165
 summary 162
technical configuration (T1/E1)
 prerequisites to 89
 summary 87
technical configuration procedure
 detailed, analog 169
 detailed, T1/E1 94
 summary, analog 168
 summary, T1/E1 93
technical support 392
telco authorities and ISDN 125
telecom safety warnings 60
telephony interface parameters,
 setting 188
telephony interfaces
 uses of 71, 73
telephony interfaces, analog 33
telephony signaling cadences
 analog 203
 T1/E1 129
telephony signaling tones
 analog 203
 T1/E1 129
telephony startup configuration 36
telephony toning schemes
 analog 207
 T1/E1 132
temperature
 operating 66
Terminal Network field
 E1/ISDN 123
 T1/ISDN 118
terminal/network settings, voip and
 PBX
 E1/ISDN 123
 T1/ISDN 118
tips, phonebook 46
To (gateway, statistics, logs) field. 332
toll-call savings
 E1 275
 T1 236
toll-free access (T1)
 to remote PSTN 10
 within voip network 10
toll-free access (within voip network)
 E1 14
 T1 10
Tone Detection (FXO disconnect
 criteria) field 196
Tone Pair (custom) field
 analog 208
 T1/E1 134
tone pairs, custom
 analog 207
 T1/E1 133
tones, signaling
 analog 203
 T1/E1 129
Total Digits (outbound) field
 E1 290
 T1 246
touch tone frequencies 197
Transfer Sequence
 analog 222
 T1/E1 148
Transfer Sequence (analog) 220
Transfer Sequence (T1/E1) 146
Transmit Data Overflow (E1 stats)
 field 345
Transmit Data Overflow (T1 stats)
 field 341
Transmit Data Underrun (E1 stats)
 field 346
Transmit Data Underrun (T1 stats)
 field 342

- Transmit Line Open (E1 stats) field 346
 - Transmit Line Open (T1 stats) field 342
 - Transmit Line Short (E1 stats) field 345
 - Transmit Line Short (T1 stats) field 341
 - Transmit Slip (E1 stats) field 346
 - Transmit Slip (T1 stats) field 342
 - Transmit Slip Negative (E1 stats) field 346
 - Transmit Slip Negative (T1 stats) field 342
 - Transmit Slip Positive (E1 stats) field 345
 - Transmit Slip Positive (T1 stats) field 341
 - Transmitted (RTCP Packets, IP Stats) field 338
 - Transmitted (RTP Packets, IP Stats) field 338
 - Transmitted (TCP Packets, IP Stats) field 337
 - Transmitted (Total Packets, IP Stats) field 336
 - Transmitted (UDP Packets, IP Stats) field 337
 - Transport Protocol (SIP) field
 - E1 292
 - T1 248
 - trap manager parameters (SNMP)
 - T1/E1 128
 - triggering log report email
 - analog 212
 - T1/E1 138
 - troubleshooting 58
 - Turn Off Logs field
 - analog 218
 - T1/E1 143
 - Type (E&M type) field 199
 - Type (of tone) field
 - analog 205
 - T1/E1 131
- U**
- UDP multiplexed (H.323 Annex E) field
 - E1 287
 - T1 243
 - UDP/TCP compared
 - E1 292
 - IP Statistics context 336
 - T1 248
 - unconditional forwarding
 - E1 297
 - T1 253
 - Uninstall (program menu option) , command 368
 - Uninstall option description (MultiVOIP program menu) 348
 - uninstalling MultiVOIP software82, 368
 - unobtainable tone, custom
 - analog 207, 208
 - T1/E1 133, 134
 - unobtainable tones
 - analog 133, 207
 - unpacking
 - MVP210 64
 - MVP2410 61, 62
 - MVP3010 61
 - MVP410 63
 - MVP810 63
 - Up Time
 - System Info (analog) 232
 - System Info (T1/E1) 158, 323
 - update interval (logging)
 - analog 217
 - T1/E1 143
 - updated firmware, obtaining 349
 - upgrade
 - E1 14
 - T1 10
 - upgrade card (analog, 4-to-8 channel) installation 408
 - upgrade card (T1/E1) installation.. 398
 - Upgrade Software option description
 - MultiVOIP program menu 348
 - upgrade, firmware 353
 - uploads vs. downloads (FTP) 371
 - Use Fast Start (Q.931) field
 - E1 285
 - T1 241
 - Use Gatekeeper (Outbound Phonebook) field

- E1 291
- T1 247
- Use Proxy (SIP) field
 - E1 292
 - T1 248
- user default configuration, creating
 - analog 234
 - T1/E1 160
- user defaults, downloading 362
- user defaults, setting 362
- user name
 - Windows GUI 364
- user values (software), saving 362
- V**
- variations in PBX characteristics
 - E1 317
 - T1 273
- version numbers 9
- version numbers (software) 77
- version, firmware 353
- Voice Coder (call progress) field.. 327
- Voice coder (statistics, logs) field. 333
- voice delay
 - analog 185, 186
 - T1/E1 110, 111
- Voice Gain field
 - analog 181
 - T1/E1 106
- voice packets (analog)
 - recovering lost/corrupted 184
- voice packets (T1/E1)
 - recovering lost/corrupted 109
- voice packets, consecutive lost
 - analog 187
 - T1/E1 112
- voice packets, delayed
 - analog 185, 186
 - T1/E1 110, 111
- voice packets, re-assembling
 - analog 182
- voice packets, re-assembly
 - T1/E1 107
- voice quality, improving
 - analog 184
 - T1/E1 109
- voice quality, versus delay
 - analog 186
 - T1/E1 111
- Voice/FAX connector pinout 403
- Voice/FAX Parameter definitions
 - analog 186, 187
 - T1/E1 111, 112
- Voice/FAX Parameter Definitions
 - analog 181, 182, 183, 184, 185
 - T1/E1 106, 107, 108, 109, 110
- Voice/FAX Parameter fields (analog)
 - Auto Call Enable 184
 - Automatic Disconnection 187
 - Call Duration 187
 - Consecutive Packets Lost 187
 - Copy Channel 181
 - Default 181
 - DTMF Gain 181
 - DTMF Gain (High Tones) 181
 - DTMF Gain (Low Tones) 181
 - DTMF In/Out of Band 181
 - Duration (DTMF) 181
 - Dynamic Jitter Buffer 185
 - Echo Cancellation 184
 - Fax Enable 182
 - Fax Volume 182
 - Forward Error Correction 184
 - Input Gain 181
 - Jitter Value 187
 - Jitter Value (Fax) 182
 - Max Baud Rate (Fax) 182
 - Maximum Jitter Value 186
 - Minimum Jitter Value 185
 - Mode (Fax) 182
 - Network Disconnection 187
 - Optimization Factor 186
 - Output Gain 181
 - Phone Number (Auto Call) 184
 - Select Channel 181
 - Silence Compression 184
 - Voice Gain 181
- Voice/FAX Parameter fields (T1/E1)
 - Auto Call Enable 109
 - Automatic Disconnection 112
 - Call Duration 112
 - Consecutive Packets Lost 112
 - Copy Channel 106
 - Default 106
 - DTMF Gain 106
 - DTMF Gain (High Tones) 106

- DTMF Gain (Low Tones)..... 106
- DTMF In/Out of Band 106
- Duration (DTMF) 106
- Dynamic Jitter Buffer 110
- Echo Cancellation 109
- Fax Enable 107
- Fax Volume 107
- Forward Error Correction 109
- Input Gain 106
- Jitter Value..... 112
- Jitter Value (Fax) 107
- Max Baud Rate 107
- Maximum Jitter Value 111
- Minimum Jitter Value 110
- Mode (Fax) 107
- Network Disconnection 112
- Optimization Factor 111
- Output Gain 106
- Phone Number (Auto Call) 109
- Select Channel 106
- Silence Compression..... 109
- Voice Gain 106
- Voice/FAX Parameters screen,
 - accessing
 - analog..... 178
 - T1/E1 103
- Voice/FAX parameters, setting
 - analog..... 178
 - T1/E1 103
- voip dialing digits
 - non-PSTN type 47
 - types used..... 46
- voip email account
 - analog..... 211
 - T1/E1 137
- voip management, remote
 - analog..... 200
 - T1/E1 126
- voip network, lab/simulated
 - use in startup 48
- voip protocols
 - H.323 31
 - SIP 31
 - uniformity in network 31
- voip software
 - host PC..... 22, 32
- voip software (analog)
 - host PC..... 163
- voip software (T1/E1)
 - host PC 88
- voip system example, conceptual (E1)
 - calls to remote PSTN 277
 - foreign calls, national rates..... 279
 - voip site to voip site 276
- voip system example, digital & analog, with phonebook details
 - E1 305
 - T1 260
- voip system example, digital only, with phonebook details
 - E1 298
 - T1 254
- voip(E1)
 - basic functions of 15
- voip(T1)
 - basic functions of 11
- voltage, operating
 - analog models 25
 - E1 models..... 24
 - T1 models..... 23
- W**
- warnings, safety 60
- warranty 390
- web browser GUI and logs
 - analog..... 217
 - T1/E1 143
- web browser GUI, enabling
 - analog..... 36, 177
 - T1/E1 102
- web browser interface
 - browser version requirement 381, 384
 - general..... 381
 - Java requirement 381
 - prerequisite local assigning of IP address..... 382
 - video useability 381
- web GUI
 - Java and..... 383
 - remote control/configuration and 383
- web GUI vs. local Windows GUI
 - comparison 382
- web GUI, logging and 382
- weight

- analog models 25
- E1 models 24
- T1 models 23
- weight loading
 - in rack 66
- weight of unit
 - lifting precaution..... 60
 - personnel requirement..... 60
- Well Known Ports..... 406
- well-known port number, SMTP
 - analog 211
 - T1/E1 137
- well-known port, gatekeeper registration
 - E1 285
 - T1 241
- well-known port, Q.931 params, H.323
 - E1 285, 291
 - T1 241, 247
- well-known port, SIP
 - E1 292
- T1 248
- well-known port, SNMP
 - analog 202
 - T1/E1 128
- wink signaling (E&M) 199
- Wink Timer (E&M) field 199
- worksheet
 - phonebook..... 52, 53
- X**
- XMT (channel) LED
 - analog models 21
- XMT (Ethernet) LED
 - analog models 21
- XSG LED
 - analog models 21
- Y**
- Yellow Alarm (E1 stats) field 345
- Yellow Alarm (T1 stats) field 342
- Yellow Alarm Format field (T1)... 119



S000249C

Free Manuals Download Website

<http://myh66.com>

<http://usermanuals.us>

<http://www.somanuals.com>

<http://www.4manuals.cc>

<http://www.manual-lib.com>

<http://www.404manual.com>

<http://www.luxmanual.com>

<http://aubethermostatmanual.com>

Golf course search by state

<http://golfingnear.com>

Email search by domain

<http://emailbydomain.com>

Auto manuals search

<http://auto.somanuals.com>

TV manuals search

<http://tv.somanuals.com>