

# Murphy W-Series Engine Panels General Installation Instructions



Read the following information before installing. These installation instructions are typical for a variety of W-Series engine panels and may not reflect the exact configuration for your panel assembly. It is assumed that the installer is familiar with engine operations and has basic mechanical and electrical skills. If additional assistance is needed, please call your Murphy dealer or contact one of our offices at the numbers listed on this instruction sheet. A visual inspection for any damage which may have occurred during shipping is recommended.

## GENERAL INFORMATION

/ **WARNING** \

**BEFORE BEGINNING INSTALLATION OF THIS MURPHY PRODUCT**

- ✓ Disconnect all electrical power to the machine.
- ✓ Make sure the machine cannot operate during installation.
- ✓ Follow all safety warnings of the machine manufacturer.
- ✓ Read and follow all installation instructions.



WD300-LV

### Description

Generally, pressure and temperature Swichgage® contacts are wired to a central nerve center called a Magnetic Switch or Tattletale® annunciator. This nerve center is essentially a relay and, when signaled by a Swichgage contact operation, it either makes or breaks a circuit to operate an alarm or engine shutdown device. Various nerve centers are used

depending upon the operation to be performed, the type of electrical power available and the type of alarm or shutdown device used. Typical wiring diagrams for the popular Tattletale annunciators and magnetic switches are included in this instructions. If a drawing of the specific model number is enclosed, refer to that drawing for specific wiring.



**CAUTION:** Certain dangers to human safety and to equipment may occur if some equipment is stopped without pre-warning. It is recommended that monitored functions be limited to alarm only or to alarm before shutdown.

## INSTALLATION INFORMATION

### Mounting the Panel



**WARNING:** Perform mounting operation with power source OFF. Disable the engine so it cannot start. Remove the battery ground cable.

1. Select a suitable mounting location on or near the engine. The location should provide easy access to the panel and provide unobstructed viewing of the Swichgage instruments.
2. The mounting location should avoid shock and vibration to the extent possible. Generally, a location low on the engine is preferred. Avoid mounting on top of the engine if possible. Shockmounts are suggested where possible to dampen shock and vibration.

**IMPORTANT:** Use of improper shockmounts can accelerate the shock and vibration effects. Consult the factory if you are in doubt.

**NOTE:** If shockmounts are used, it is suggested that a separate ground wire be attached to the panel assembly and to the engine. This assures electrical continuity between the Swichgage contacts and the battery ground across the shockmounts (see mounting detail below).

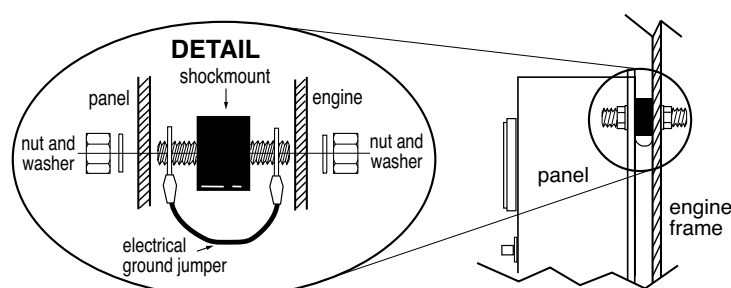

### Connecting the Pressure Swichgage

1. Pressure tubing is generally not provided. Use of good quality flexible pressure tubing/hose and fittings is strongly suggested. Use at least 3/16 in. (5 mm) I.D. tubing. If using copper or rigid tubing, install at least 12 in. (305 mm) flexible hose from the pressure Swichgage instrument to the rigid tubing. This prevents damaging vibration from reaching the Swichgage instrument.
2. Connect the pressure tubing to the 1/8-27 NPT pressure port of the pressure Swichgage instrument. Use of a non-hardening thread sealing compound is recommended although the thread is "dry seal". Be sure that thread sealant does not foul the pressure orifice.

**NOTE:** The orifice can be removed for cleaning.

3. Connect the pressure tubing to the pressure galley of the engine. Generally this is at the oil filter housing. Use of non-hardening thread sealant is recommended. Avoid droops or sink traps in routing of the pressure line.

### Installation Accessories

Tools and equipment needed:

- Thread sealant or Teflon® tape.
- Straight edge screwdriver (medium).
- Wire stripping and terminal crimping tools.
- Electrical wire for use on power connections.
- Adjustable wrench or open end wrench set.

**Connecting High Temperature Swichgase Instrument**

**LIQUID COOLED ENGINES:**

1. Drain engine coolant to a level below the temperature sensing connection/plug. This connection is on the engine side of the thermostat generally near the thermostat housing. *Consult your engine manual.*
2. Remove adapter nut from temperature sensing bulb and union nut.
3. Apply a non-hardening thread sealant to the adapter nut and screw securely into the water jacket opening on the engine.
4. Route the temperature capillary away from hot surfaces such as exhaust manifolds.
5. Place the sensing bulb into the adapter nut and observe that the sensing bulb does not "bottom" in the water jacket nor are there other obstructions in the water jacket opening. Secure sensing bulb into the adapter nut with the <sup>5</sup>/<sub>8</sub>-18 union nut. *See mounting detail below.*

 **CAUTION:** Do NOT cut or bend the temperature capillary at a sharp angle. Excess capillary must be carefully coiled and secured. The temperature sensing bulb must be immersed directly into the water jacket flow to sense coolant temperature. Do NOT install into a tee or other fitting. Use only Murphy adapter nuts.

6. Coil excess temperature capillary into a 2 in. (51 mm) diameter minimum coil. Tie the coil to prevent excessive movement.

**Sensing Bulb Mounting Detail**

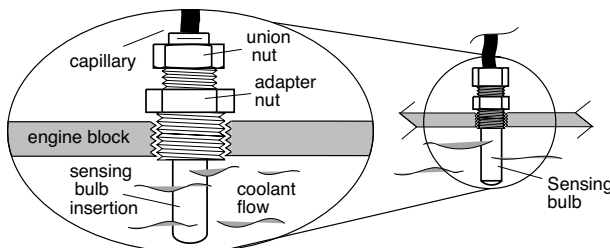

**AIR COOLED ENGINES:**

Temperature for air cooled engine can be measured in the cylinder head or in the lubricating oil. Oil temperature will give a more uniform reading than cylinder head since the oil circulates throughout the engine. Refer to specific instructions supplied, if any, for your specific application.

1. *Oil Temperature*
  - a. The Swichgase sensing probe must be fully immersed in the oil pan, oil filter housing, oil cooler, etc. depending on engine model and configuration.
  - b. Observe all precautions for liquid cooled engines.
2. *Cylinder Head Temperature*
  - a. Generally the cylinder head must already have a hole drilled and tapped for insertion of the temperature sensing probe.
  - b. If a hole is not provided in the cylinder head and no provision is made to drill and tap one, it may be possible to install an external bolt on heat sink such as the Murphy HS7.
  - c. Coat the temperature sensing probe with a high temperature grease. A mixture of silicone and graphite flakes is recommended although grease alone can be used.

 **CAUTION:** Do NOT apply too much grease. If grease is pushed out of the hole when temperature probe is inserted, remove some grease.

- d. Observe all precautions for liquid cooled engines.

**Installing the Engine Stop Device or Alarm**  
*Follow instructions provided with the stop device or alarm.*

 **CAUTION:** The Swichgase contacts are "pilot duty". Generally a nerve center/magnetic switch or relay is required between the Swichgase contacts and the shutdown or alarm device. Failure to use a nerve center/magnetic switch will result in contact failure in the Swichgase and failure of the shutdown or alarm device to operate.

**Electric Wiring**

1. Disconnect the battery ground cable or otherwise disconnect electric power from the engine and panel.
2. See the appropriate typical or specific wiring diagram for the nerve center/magnetic switch in your panel.
3. Generally you will only be required to wire the battery or other electrical power to the nerve center/magnetic switch and the output circuit from the nerve center/magnetic switch to the alarm or shutdown device.
4. Ammeters should be direct wired according to the wiring included with this panel. Use minimum 10 AWG cable.
5. Be sure that the connected load(s) does not exceed the voltage and current ratings of the nerve center/magnetic switch or Swichgase.

 **CAUTION:** Never check for voltage by shorting a wire or terminal to ground. This will ALWAYS damage the electrical components.

**Placing Into Operation**

1. Refill oil and coolant to proper levels.
2. Reconnect electrical power.
3. Service the engine as required by the engine manufacturer before attempting to start the engine.

**To Start the Engine**

1. Fully depress the red or black push button of the nerve center/magnetic switch on the panel face. Hold in the button while cranking the engine. This overrides the engine shutdown to allow starting. When the oil pressure pointer moves away from the pointer contact (or when pressure exceeds the preset low trip point) release the push button. The engine should be operating. If the push button is red, it should remain depressed. If the push button is black, it should return to an extended position.

 **CAUTION:** If the pressure Swichgase is equipped with a face mounted lockout push button, be sure that pressure has been established and that the lockout mechanism has disengaged. Failure to disengage will prevent the Swichgase control from operating on low pressure.

2. Allow the engine to warm up and the thermostat to open. Slightly loosen the <sup>5</sup>/<sub>8</sub>-18 union nut on the temperature sensing bulb to allow trapped air to escape from the cooling system. Retighten the nut.

 **WARNING:** Perform this operation using appropriate protection. Trapped air and coolant may cause skin burns.

3. Loosen the oil line fitting slightly at the pressure Swichgase to allow trapped air to escape from the tubing. Retighten the fitting.

**To Stop the Engine**

1. Return the engine to idle speed and unload any driven equipment.

 **CAUTION:** You should stop the engine in a normal manner. Turn off the power switch, pull shutoff cable, etc. Do NOT use the Swichgase control instrument as a normal shutoff.

2. **DISTRIBUTOR IGNITION** engine panels may have an Emergency Stop Button, a start key switch or other power on/off switch. Operate that switch or button. The nerve center/Magnetic Switch will trip and open the ignition circuit to stop the engine.
3. **DIESEL ENGINES** may be equipped with "energized to RUN" or "energized to STOP" devices. For "energized to RUN" devices such as Murphy SV series fuel valves or RP-type solenoids, operation is identical to above for distributor ignition engines. The "energized to RUN" device is de-energized and the engine stops. For "energized to STOP" devices the nerve center/magnetic switch applies battery power to the stop device. Power is removed after a short time delay depending on the specific nerve center/magnetic switch. See instructions supplied with the shutdown or alarm device. *For normal stop, pull the manual stop cable.*

## Setting the SWICHGAGE® contacts

1. Face mounted contacts are set using a 1/16 in. hex wrench.
2. Some models such as 20PE, 20TE, etc. may not have field adjustment. *Consult the factory if in doubt.*
3. Observe the “normal operating” oil pressure and coolant temperature readings. Set the oil pressure Swichgauge contact slightly **below** the minimum reading observed or slightly **above** the minimum pressure recommended by the engine manufacturer.



**WARNING:** If the pressure Swichgauge instrument has a lockout push button on the face, a contact setting higher than the factory setting will make the lockout device inoperative.

4. Set the temperature Swichgauge contact slightly **above** the “normal operating” temperature reading observed or slightly **below** the maximum temperature recommended by the engine manufacturer.

**NOTE:** More detailed instructions are contained in Installation Sheet P-95033N for pressure Swichgauge instruments and T-8446N for Temperature Swichgauge instruments.

## Testing the Swichgauge Instruments

**For face mounted contacts (20P, 20T, 20PW7, etc.):**

1. With the engine running; use a 1/16 in. hex wrench to rotate the contact until it touches the gauge pointer. **Do NOT force the contact against the pointer.** Engine should shut down and/or alarm should operate. *Reset the contact.*
2. An alternative method of testing the shutdown circuit is to place a coin or other metal object between the contact adjustment and the bezel.

**NOTE:** This method does NOT test the actual contact pair. It does test the circuit beyond the contact.

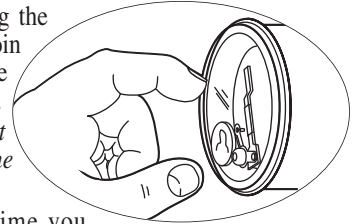

3. **VERY IMPORTANT** Each time you start the engine, observe that the Swichgauge instruments are indicating pressure or temperature, etc. Visual inspection and regular testing should be normal procedure to ensure proper operation and to achieve maximum results from your Swichgauge system.

## TYPICAL WIRING DIAGRAM WITH 117PH MAGNETIC SWITCH



**CAUTION:** This wiring is typical for Murphy W-Series small engine panels. Items shown may or may not be included in your panel; however, the circuit is typical of how the component will be wired if it is included. Refer to installation instructions for the specific component if included. For off-panel items such as shutdown devices, see specific instructions supplied with the device.

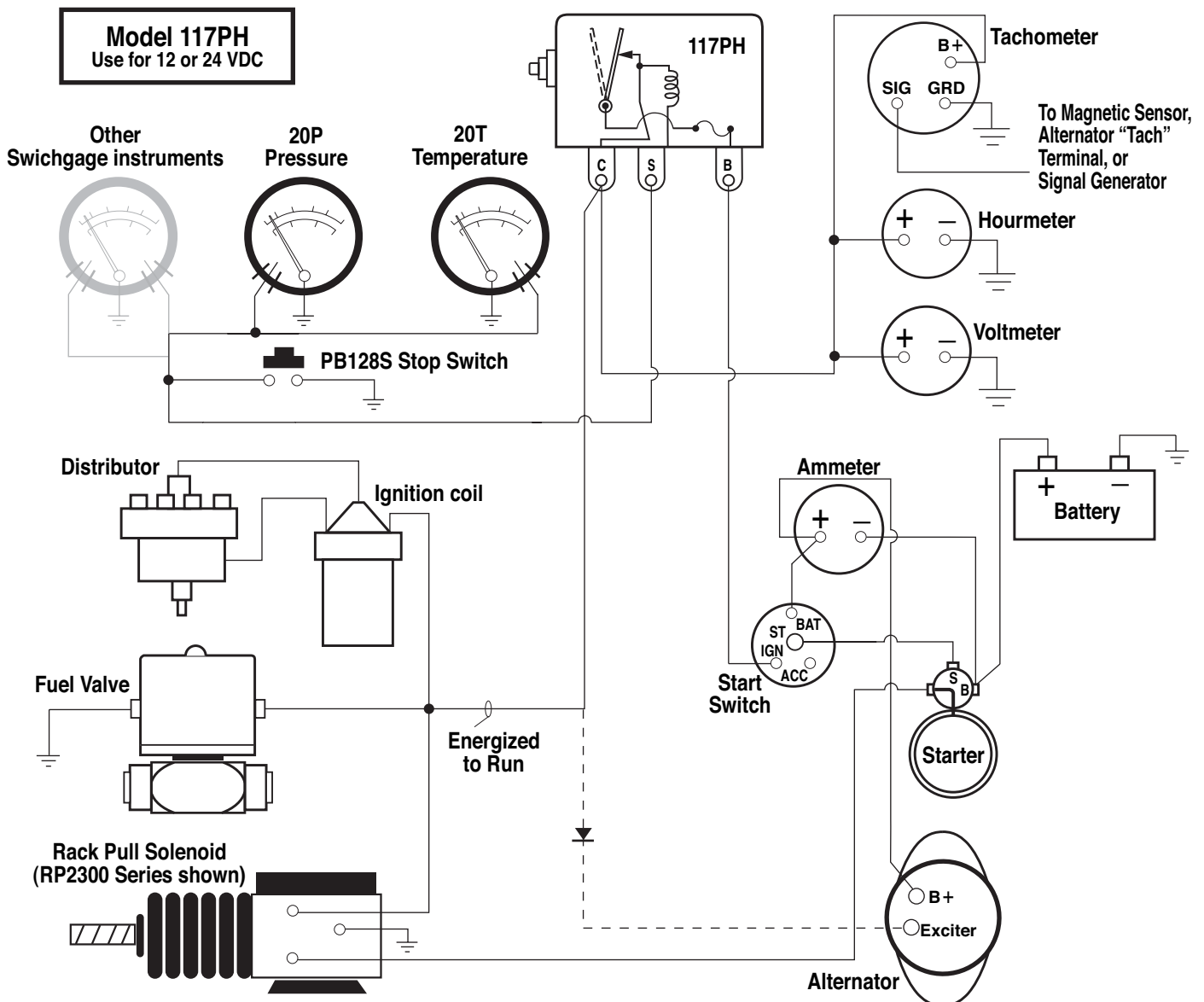

# TYPICAL WIRING WITH 518PH TATTLETALE CLOSED LOOP



**CAUTION:** This wiring is typical for Murphy W-Series small engine panels. Items shown may or may not be included in your panel; however, the circuit is typical of how the component will be wired if it is included. Refer to installation instructions for the specific component if included. For off-panel items such as shutdown devices, see specific instructions supplied with the device.

## 518PH WIRED CLOSED LOOP MUST specify 12 or 24 VDC

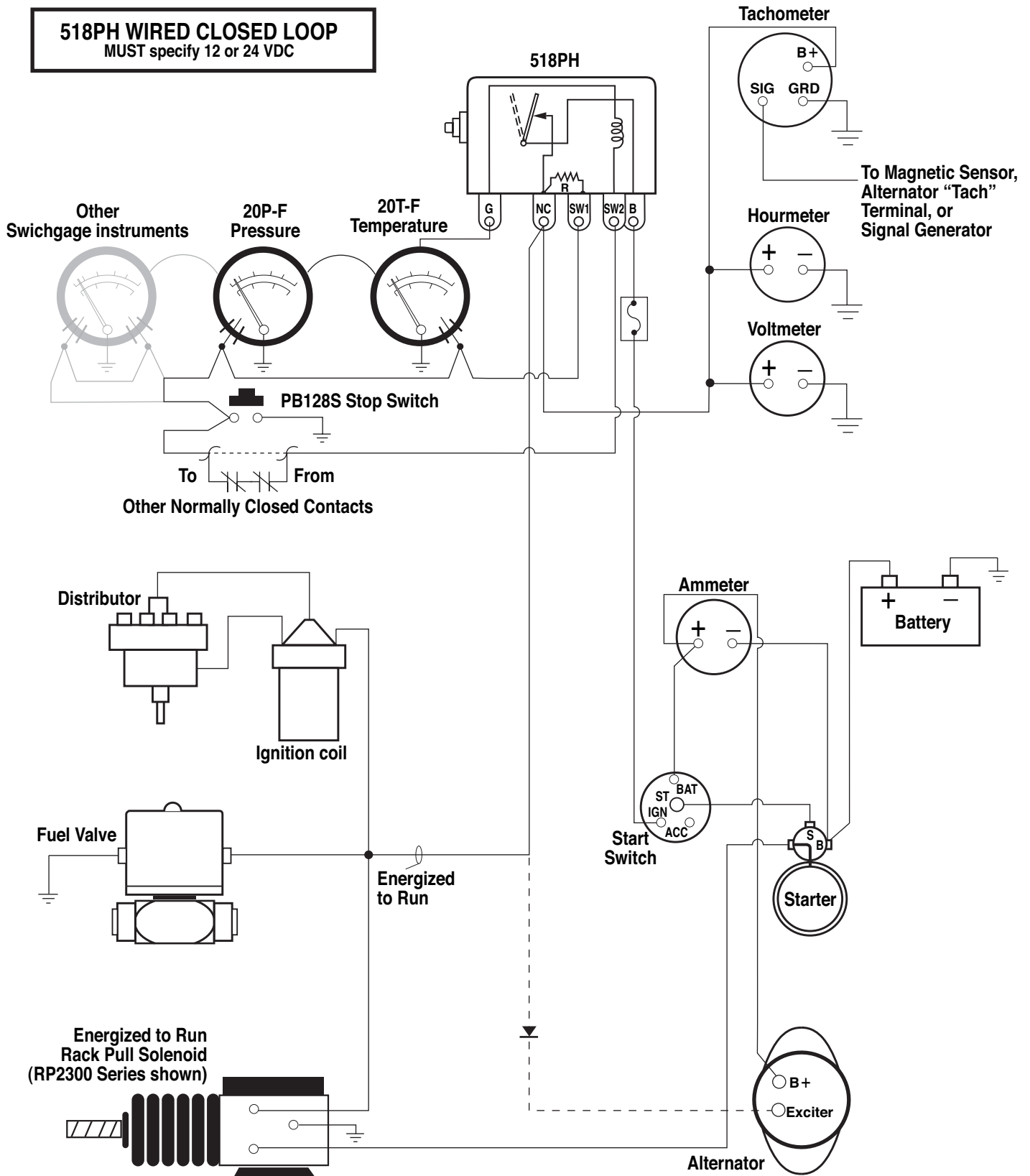

# TYPICAL WIRING DIAGRAM WITH 518PH TATTLETALE JUMPERED



**CAUTION:** This wiring is typical for Murphy W-Series small engine panels. Items shown may or may not be included in your panel; however, the circuit is typical of how the component will be wired if it is included. Refer to installation instructions for the specific component if included. For off-panel items such as shutdown devices, see specific instructions supplied with the device.

**518PH WIRED WITH JUMPER**  
Must specify 12 or 24 VDC

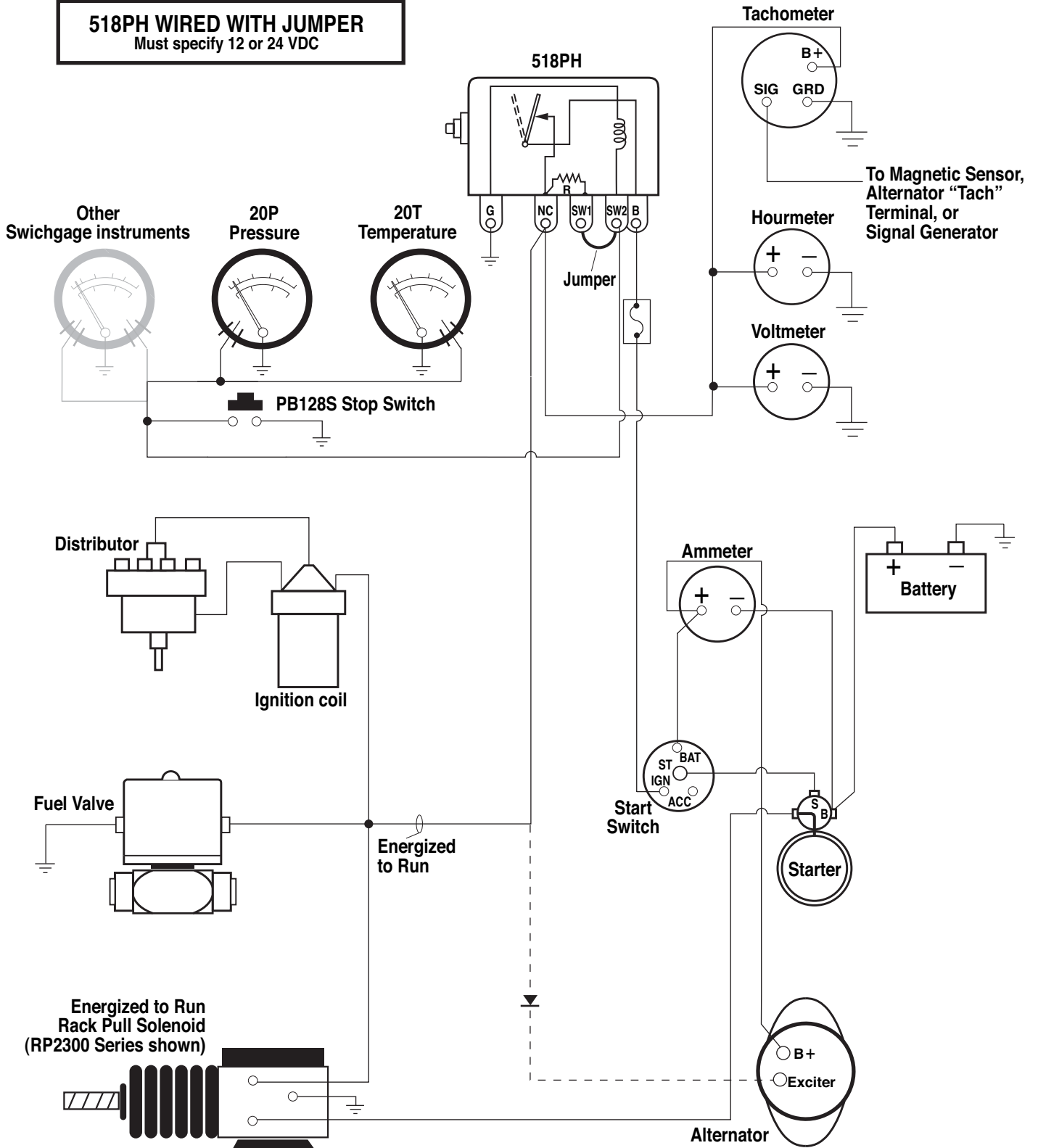

# TYPICAL WIRING DIAGRAM WITH 760A AND 761APH



**CAUTION:** This wiring is typical for Murphy W-Series small engine panels. Items shown may or may not be included in your panel; however, the circuit is typical of how the component will be wired if it is included. Refer to installation instructions for the specific component if included. For off-panel items such as shutdown devices, see specific instructions supplied with the device.

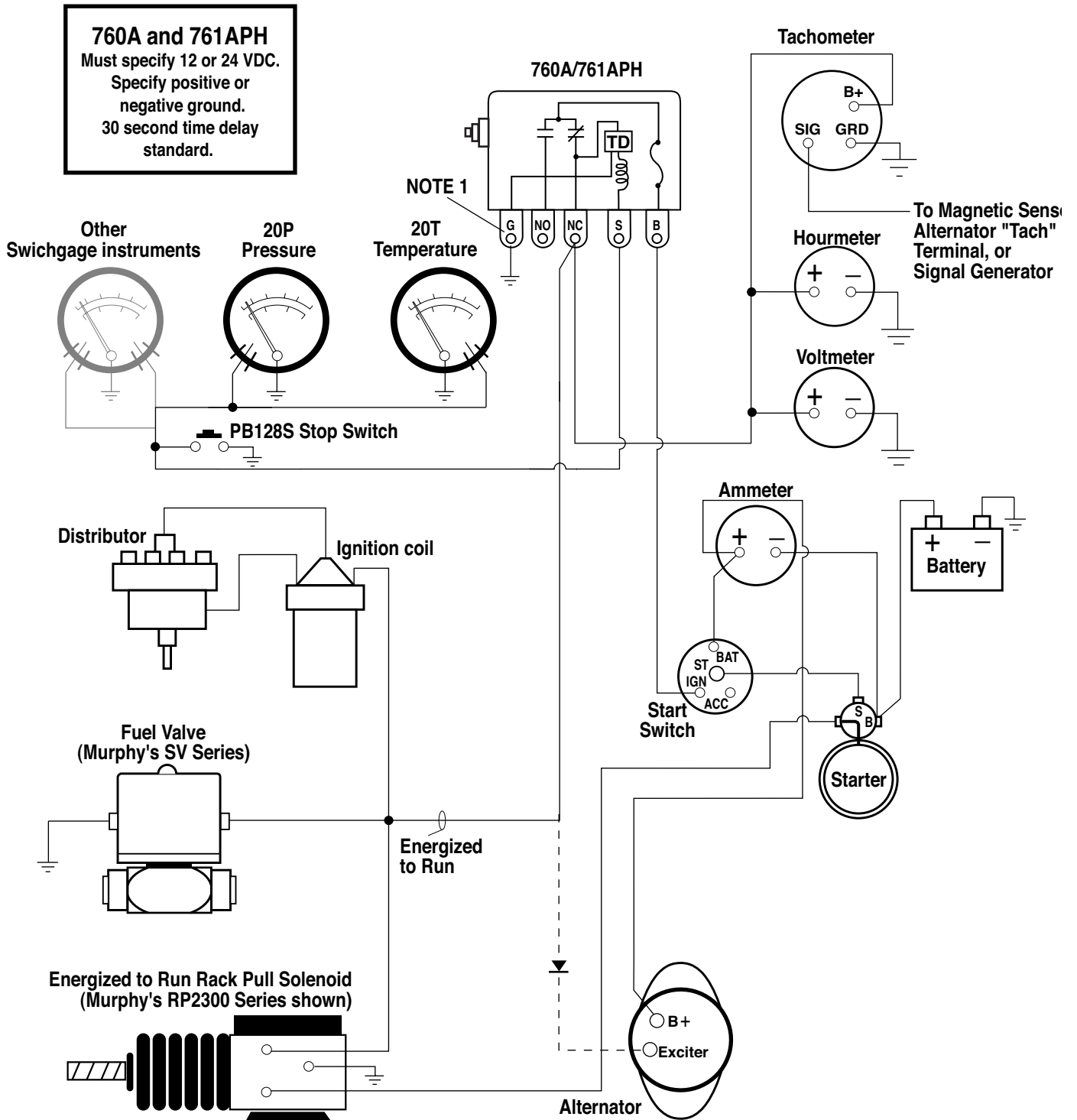



## TROUBLESHOOTING TIPS



**Make sure the voltage and current requirements are within the W-Series ratings.** Determine the polarity for the application. Use appropriate wire size for voltage and current.

These instructions will assist in the correction of most problems which you may encounter with the panel. Before checking the list, first refer to the wiring connections and operation procedures and make sure the panel is properly installed. If problems persist after making the following checks, consult any Murphy facility.

SYMPTOM	PROBABLE CAUSE	CORRECTIVE ACTION
Engine will not start.	<ol style="list-style-type: none"> <li>1. Blown fuse at magnetic switch.</li> <li>2. Accidental ground to (S) or (C) terminals.</li> <li>3. Overload circuit due to accessories.</li> <li>4. Open circuit in 518PH wiring.</li> </ol>	<ol style="list-style-type: none"> <li>1. Replace fuse.</li> <li>2. Check for ground and correct.</li> <li>3. Re-route accessory circuits.</li> <li>4. Repair circuit.</li> </ol>
Pointer burned in two.	Overload of pointer contact due to excessive load or short circuit.	Remove or reduce load; remove short circuit and replace Swichgage instrument.
False shutdown.	<ol style="list-style-type: none"> <li>1. Wire from Swichgage instrument is grounded or shorted to contact.</li> <li>2. Closed Loop circuit has intermittent open or short.</li> <li>3. Excessive shock or vibration causes magnetic switch to trip.</li> <li>4. Lack of coolant around temperature sensing bulb causes "hot spot".</li> <li>5. Temperature capillary routed too close to exhaust manifold.</li> </ol>	<ol style="list-style-type: none"> <li>1. Remove ground or short.</li> <li>2. Check all wiring and repair.</li> <li>3. Isolate panel from shock/vibration.</li> <li>4. Check coolant level; loosen the union nut to allow trapped air to escape.</li> <li>5. Reroute temperature capillary.</li> </ol>
SWICHGAGE® contact closes but does not trip the magnetic switch to stop the engine.	Incomplete circuit.	Locate open circuit and repair; turn the contact adjustment against the pointer causing them to "wipe" against each other. Be sure magneto is providing power to primary terminal post. CD type magnetic switch used with magneto.
Inaccurate readings.	<ol style="list-style-type: none"> <li>1. Pressure orifice plugged with thread sealant.</li> <li>2. Temperature capillary rerouted too close to exhaust manifold.</li> <li>3. Broken or crushed temperature capillary.</li> </ol>	<ol style="list-style-type: none"> <li>1. Remove and clean pressure orifice.</li> <li>2. Reroute capillary.</li> <li>3. Replace Swichgage instrument.</li> </ol>
Engine does not stop immediately.	Fuel shutoff valve used on diesel engine.	Be sure all fittings are air tight; use check valve in bypass line; use rack puller in place fuel valve.
Magnetic Switch trips but engine does not stop.	Feedback from alternator.	Install diode in excitation circuit.

### Warranty

A limited warranty on materials and workmanship is given with this FW Murphy product.  
A copy of the warranty may be viewed or printed by going to [www.fwmurphy.com/support/warranty.htm](http://www.fwmurphy.com/support/warranty.htm)

  
**MURPHY**  
[www.fwmurphy.com](http://www.fwmurphy.com)

918.317.4100 Email: [sales@fwmurphy.com](mailto:sales@fwmurphy.com)

In order to consistently bring you the highest quality, full featured products, we reserve the right to change our specifications and designs at any time. MURPHY, the Murphy logo, and Swichgage® are registered and/or common law trademarks of Murphy Industries, Inc. This document, including textual matter and illustrations, is copyright protected by Murphy Industries, Inc., with all rights reserved. (c) 2006 Murphy Industries, Inc.

In order to consistently bring you the highest quality, full featured products, we reserve the right to change our specifications and designs at any time.

## Free Manuals Download Website

<http://myh66.com>

<http://usermanuals.us>

<http://www.somanuals.com>

<http://www.4manuals.cc>

<http://www.manual-lib.com>

<http://www.404manual.com>

<http://www.luxmanual.com>

<http://aubethermostatmanual.com>

Golf course search by state

<http://golfingnear.com>

Email search by domain

<http://emailbydomain.com>

Auto manuals search

<http://auto.somanuals.com>

TV manuals search

<http://tv.somanuals.com>