

NAD

T550

DVD/ VIDEO CD/ CD Player



GB OWNER'S MANUAL

Safety Precautions

For U.S.A

TO THE USER

This equipment has been tested and found to comply with the limits for a Class B digital device, pursuant to Part 15 of the FCC Rules. These limits are designed to provide reasonable protection against interference in a residential area. This device generates and uses radio frequency energy and if not installed and used in accordance with the instructions, it may cause interference to radio or TV reception. If this unit does cause interference with TV or radio reception you can try to correct the interference by one or more of the following measures :

- a) Reorient or relocate the receiving antenna.
- b) Increase the separation between the equipment and the receiver.
- c) Plug the equipment into a different outlet so that it is not on the same circuit as the receiver. If necessary, consult the dealer or an experienced radio/TV technician for additional suggestions.

CAUTION

Changes or modifications to this equipment not expressly approved by NAD Electronics for compliance could void the user's authority to operate this equipment.

For CANADA

AC POWER CORD CONNECTION

CAUTION :

TO PREVENT ELECTRIC SHOCK, MATCH WIDE BLADE OF PLUG TO WIDE SLOT, FULLY INSERT.

Pour le CANADA

CORDE DE CONNEXION CA

ATTENTION :

POUR ÉVITER LES CHOCS ÉLECTRIQUES, INTRODUIRE LA LAME LA PLUS LARGE DE LA FICHE DANS LA BORNE CORRESPONDANTE DE LA PRISE ET POUSSER JUSQU'AU FOND.

IMPORTANT (for U.K. Customers)

DO NOT cut off the mains plug from this equipment. If the plug fitted is not suitable for the power points in your home or the cable is too short to reach a power point, then obtain an appropriate safety approved extension lead or consult your dealer.

If nonetheless the mains plug is cut off, remove the fuse and dispose of the plug immediately, to avoid a possible shock hazard by inadvertent connection to the mains supply.

If this product is not provided with a mains plug, or one has to be fitted, then follow the instructions given below:

IMPORTANT. DO NOT make any connection to the larger terminal which is marked with the letter E or by the safety earth symbol \perp or coloured GREEN or GREEN-and-YELLOW.

The wires in the mains lead on this product are coloured in accordance with the following code :

BLUE - NEUTRAL
BROWN - LIVE

As these colours may not correspond with the coloured markings identifying the terminals in your plug proceed as follows:

The wire which is coloured BLUE must be connected to the terminal which is marked with the letter N or coloured BLACK.

The wire which is coloured BROWN must be connected to the terminal which is marked with the letter L or coloured RED.

When replacing the fuse only a correctly rated approved type should be used and be sure to re-fit the fuse cover.

IF IN DOUBT — CONSULT A COMPETENT ELECTRICIAN.

The equipment draws nominal non-operating power from the AC outlet with its POWER switch in the STANDBY position.

Obs! nätströmställaren skiljer ej hela apparaten från nätet.

WARNING: TO PREVENT FIRE OR SHOCK HAZARD, DO NOT EXPOSE THIS APPLIANCE TO RAIN OR MOISTURE.



CAUTION
RISK OF ELECTRIC SHOCK
DO NOT OPEN



CAUTION: TO REDUCE THE RISK OF ELECTRIC SHOCK, DO NOT REMOVE COVER (OR BACK). NO USER-SERVICEABLE PARTS INSIDE. REFER SERVICING TO QUALIFIED SERVICE PERSONNEL.



THE LIGHTNING FLASH WITH ARROWHEAD SYMBOL, WITHIN AN EQUILATERAL TRIANGLE, IS INTENDED TO ALERT THE USER TO THE PRESENCE OF UNINSULATED "DANGEROUS VOLTAGE" WITHIN THE PRODUCT'S ENCLOSURE THAT MAY BE OF SUFFICIENT MAGNITUDE TO CONSTITUTE A RISK OF ELECTRIC SHOCK TO PERSONS.



THE EXCLAMATION POINT WITHIN AN EQUILATERAL TRIANGLE IS INTENDED TO ALERT THE USER TO THE PRESENCE OF IMPORTANT OPERATING AND MAINTENANCE (SERVICING) INSTRUCTIONS IN THE LITERATURE ACCOMPANYING THE APPLIANCE.

Table of Contents

Introduction

- Safety Precautions2
- Table of Contents3
- IMPORTANT SAFETY INSTRUCTIONS4 ~ 5
- Precautions6
- For Proper and Long Use7 ~ 8
- Features9
- Identification of Contents10 ~ 13
 - Front Panel/Display window10
 - Rear panel11
 - Remote Control12
 - Preparing the Remote Control13
 - Operating with the Remote Control13

Connections

- Connecting to a TV14
- Connecting to an Audio System15
- Connecting to Optional Equipment16 ~ 19
 - Enjoying Dolby Digital Sound16
 - Enjoying Dolby Digital (5.1 CH) Sound17
 - Enjoying Dolby Pro Logic Surround Sound ...18
 - Enjoying 2 Channel Digital Stereo Sound19
 - Enjoying DTS Sound19

Basic Operation

- Basic Playback20 ~ 23
 - Playing DVDs, CDs & Video CDs20
 - Stopping Playing & Switching Power Off21
 - Skipping forward or back21
 - Scanning forward or back.....21
 - Viewing a still frame22
 - Slow Playback-Viewing a slow picture22
 - Playing Frame by Frame22
 - Resuming Playback from the Same Location ..23

Advanced Operation

- Viewing Information about DISPLAY24
- Using a title menu/ DVD menu25
- Changing subtitle language26
- Viewing from another angle27
- Repeat Play28
- Storing markers in memory to be viewed (listened to) again29
- Zooming Feature/ Random Play30
- Program Play31
- INTRO Play31

Initial SETUP Operation

- Common procedures of initial settings32
- SET UP Menu CLEAR32
- Selecting Display mode33
- Selecting Audio Output34
- Selecting rating level and Password-Parental Control35
- Selecting Disc Language36

Reference

- Disc Requirements/Copyright Information37
- Troubleshooting38
- Specifications39

IMPORTANT SAFETY INSTRUCTIONS

CAUTION : PLEASE READ AND OBSERVE ALL WARNINGS AND INSTRUCTIONS IN THIS OWNER'S MANUAL AND THOSE MARKED ON THE UNIT. RETAIN THIS BOOKLET FOR FUTURE REFERENCE.

This set has been designed and manufactured to assure personal safety. Improper use can result in electric shock or fire hazard. The safeguards incorporated in this unit will protect you if you observe the following procedures for installation, use and servicing.

DO NOT REMOVE THE CABINET COVER, OR YOU MAY BE EXPOSED TO DANGEROUS VOLTAGE. REFER SERVICING TO QUALIFIED SERVICE PERSONNEL ONLY.

1. Read owner's manual

When shipping the DVD player, always use the original shipping carton and packing materials. For maximum protection, repack the unit as it was originally packed at the factory.

2. Power Sources

This product should be operated only from the type of power source indicated on the marking label. If you are not sure of the type of power supply in your home, consult your product dealer or local power company.

3. Grounding or Polarization (North America versions only)

This product is equipped with a polarized alternating current line plug (a plug having one blade wider than the other). This plug will fit into the power outlet only one way. This is a safety feature. If you are unable to insert the plug fully into the outlet, try reversing the plug. If the plug should still fail to fit, contact your electrician to replace your obsolete outlet. Do not defeat the safety purpose of the polarized plug.

4. Heat

The product should be situated away from heat sources such as radiators, stoves, or other products (including amplifiers) that produce heat.

5. Water and Moisture

Do not use this product near water—for example, near a bath-tub, wash bowl, kitchen-sink, or laundry tub; in a wet basement; or near a swimming pool and the like.

6. Cleaning

Unplug this product from the wall outlet before cleaning. Do not use liquid cleaners or aerosol cleaners. Use a damp cloth for cleaning.

7. Power-Cord Protection

Power-supply cords should be routed so that they are not likely to be walked on or pinched by items placed upon or against them, paying particular attention to cords at plugs, convenience receptacles, and the point where they exit from the product.

8. Overloading

Do not overload wall outlets, extension cords, or integral convenience receptacles as this can result in a risk of fire or electric shock.

9. Lightning

For added protection of this product during storms, or when it is left unattended and unused for long periods of time, unplug it from the wall outlet. This will prevent damage to the product due to lightning and power-line surges.

10. Object and Liquid Entry

Never push objects of any kind into this product through openings as they may touch dangerous voltage points or short-out parts that could result in a fire or electric shock. Never spill liquid of any kind on the product.

11. Attachments

Do not use attachments not recommended by the product manufacturer as they may cause hazards.

12. Accessories

Do not place this product on an unstable cart, stand, tripod, bracket, or table. The product may fall, causing serious injury to a child or adult, and serious damage to the product. Use only with a cart, stand, tripod, bracket, or table recommended by the manufacturer, or sold with the product. Any mounting of the product should follow the manufacturer's instructions, and should use a mounting accessory recommended by the manufacturer. A product and cart combination should be moved with care. Quick stops, excessive force, and uneven surfaces may cause the product and cart combination to overturn.



PORTABLE CART WARNING

13. Disc Tray

Keep your fingers well clear of the disc tray as it is closing. It may cause serious personal injury.

IMPORTANT SAFETY INSTRUCTIONS

14. Burden

Do not place a heavy object on or step on the product. The object may fall, causing serious personal injury and serious damage to the product.

15. Connecting

When you connect the product to other equipment, turn off the power and unplug all of the equipment from the wall outlet. Failure to do so may cause an electric shock and serious personal injury. Read the owner's manual of the other equipment carefully and follow the instructions when making any connections.

16. Sound Volume

Reduce the volume to the minimum level before you turn on the product. Otherwise, sudden high volume sound may cause hearing or speaker damage.

17. Sound Distortion

Do not allow the product to output distorted sound for a long time. It may cause speaker overheating and fire.

18. Headphones

When you use the headphones, keep the volume at a moderate level. If you use the headphones continuously with high volume sound, it may cause hearing damage.

NOTE: Items 16, 17 and 18 are applicable to the product (i.e., amplifier, surround sound receiver) where the T550 is connected.

19. Laser Beam

Do not look into the opening of the disc tray or ventilation opening of the product to see the source of the laser beam. It may cause sight damage.

20. Disc

Do not use a cracked, deformed, or repaired disc. These discs are easily broken and may cause serious personal injury and product malfunction.

21. Damage Requiring Service

Unplug this product from the wall outlet and refer servicing to qualified service personnel under the following conditions:

- a) When the power-supply cord or plug is damaged.
- b) If liquid has been spilled, or objects have fallen into the product.
- c) If the product has been exposed to rain or water.
- d) If the product does not operate normally by following the operating instructions. Adjust only those controls that are covered by the operating instructions as an improper adjustment of other controls may result in damage and will often require extensive work by a qualified technician to restore the product to its normal operation.
- e) If the product has been dropped or damaged in any way.
- f) When the product exhibits a distinct change in performance—this indicates a need for service.

22. Servicing

Do not attempt to service this product yourself as opening or removing covers may expose you to dangerous voltage or other hazards. Refer all servicing to qualified service personnel.

23. Replacement parts

When replacement parts are required, be sure the service technician has used replacement parts specified by the manufacturer or have the same characteristics as the original part. Unauthorized substitutions may result in fire, electric shock, or other hazards.

24. Safety Check

Upon completion of any service or repairs to this product, ask the service technician to perform safety checks to determine that the product is in proper operating condition.

Precautions

Notes on handling

- When shipping the DVD player, always use the original shipping carton and packing materials. For maximum protection, repack the unit as it was originally packed at the factory.
- Do not use volatile liquids, such as insect spray, near the DVD player. Do not leave rubber or plastic products in contact with the DVD player for a long time. They will leave marks on the finish.
- The top and rear panels of the DVD player may become warm after a long period of use. This is normal and not a malfunction.
- When the DVD player is not in use, be sure to remove the disc and turn off the power.

Notes on Locating

- When you place this DVD player near a TV, radio, or VCR, the playback picture may become poor and the sound may be distorted. In this case, move the DVD player away from the TV, radio, or VCR.

Notes on Cleaning

Use a soft, dry cloth for cleaning.

- For stubborn dirt, soak the cloth in a weak detergent solution, wring well and wipe. Use a dry cloth to wipe it dry. Do not use any type of solvent, such as thinner and benzene, as they may damage the surface of the DVD player.
- If you use a chemical saturated cloth to clean the unit, follow that product's instructions.

Warning : Cleaning and adjustment of lenses and/or other components of playback mechanism should be performed by a qualified service technician.

To Obtain a Clear Picture

The DVD player is a high technology, precision device. If the optical pick-up lens and disc drive parts are dirty or worn down, the picture quality becomes poor. To obtain a clear picture, we recommend regular inspection and maintenance (cleaning or parts replacement) every 1,000 hours of use depending on the operating environment. For details, contact your nearest dealer.

Notes on Moisture Condensation

Moisture condensation damages the DVD player. Please read the following carefully.

- Moisture condensation occurs, for example, when you pour a cold drink into a glass on a warm day. Drops of water form on the outside of the glass. In the same way, moisture may condense on the optical pick-up lens inside this unit, one of the most crucial internal parts of the DVD player.

Moisture condensation occurs during the following cases.

- When you bring the DVD player directly from a cold place to a warm place.
- When you use the DVD player in a room where you just turned on the heater, or a place where the cold wind from the air conditioner directly hits the unit.
- In summer, when you use the DVD player in a hot and humid place just after you move the unit from an air conditioned room.
- When you use the DVD player in a humid place.

Do not use the DVD player when moisture condensation may occur.

- If you use the DVD player in such a situation, it may damage discs and internal parts. Connect the power cord of the DVD player to the wall outlet, turn on the DVD player and leave it "ON" for two or three hours. If a disc is present inside the machine, remove it immediately. After two or three hours, the DVD player will have warmed up and evaporated any moisture. Keep the DVD player connected to the wall outlet and moisture condensation will seldom occur.

For Proper and Long Use

■ DO NOT MOVE THE UNIT DURING PLAYBACK

During playback, the disc rotates at high speed. Do NOT lift or move the unit during playback. Doing so may damage the disc.

■ WHEN MOVING THIS UNIT

When changing places of installation or packing the unit for moving, be sure to remove the disc and return the disc table to its original position in the player. Then, press the POWER button on the remote control or on the front panel and then disconnect the power cord. Moving this unit with the disc loaded may result in damage to this unit.

■ INSTALLATION

- Select a stable place to the side of a TV set or stereo system to be connected to the unit.
- When using the unit with a stereo system, install the speakers a little bit away from the TV if these are not magnetically shielded.
- Do NOT install the unit on top of a TV or color monitor. Install the unit away from equipment that may be affected by magnetism, such as a cassette deck.

■ AVOID INSTALLING IN A PLACE THAT IS:

- Exposed to direct sunlight
- Exposed to humidity or where ventilation is poor
- Extremely hot or cold
- Exposed to vibration
- Exposed to dust
- Exposed to oily smoke, steam or heat (for example, a kitchen)

■ DO NOT PLACE AN OBJECT ON TOP

Do NOT place an object on the unit.

■ DO NOT BLOCK VENTS

Do NOT use the player on top of a long-fibre carpet, bed or sofa, and do not cover it with a cloth etc. This will prevent heat radiation and could result in damage.

■ AVOID HEAT

Do NOT place the unit on equipment generating heat, such as an amplifier.

When installing the unit in a rack, place it on the lowest shelf possible (however, not where it is exposed to dust) and separated from the amplifier to avoid the heat generated by the amplifier or other audio equipment.

■ CAUTION : WHEN PLACING THE UNIT IN A STEREO RACK WITH GLASS DOORS

Be sure there is ample space between the unit and the glass doors when opening the disc table using the remote control. If the disc table opens against strong resistance, such as a closed glass door, damage to the unit may result.

■ CONDENSATION

Moisture will form in the operating section of the player if the player is brought from cool surroundings into a warm room or if the temperature of the room rises suddenly. When this happens, player's performance will be impaired. To prevent this, let the player stand in its new surroundings for about an hour before switching it on, or make sure that the room temperature rises gradually.

Condensation may also form during the summer if the player is exposed to the breeze from an air conditioner. In such cases, change the location of the player.

■ SWITCH POWER OFF WHEN NOT USING THE UNIT

Depending on the strength of the TV or radio broadcast signal, having the TV or radio ON while power to the unit is ON may result in stripes on the TV screen or noise. However, this is not a malfunction of this unit or the TV or radio. In such a case, switch the power of the unit OFF.

■ POWER-CORD CAUTION

Handle the power cord by the plug. Do not pull out the plug by tugging the cord and never touch the power cord when your hands are wet as this could cause a short circuit or electric shock. Do not place the unit, a piece of furniture, etc., on the power cord, or pinch the cord. Never make a knot in the cord or tie it with other cords. The power cords should be routed in such a way that they are not likely to be stepped on. A damaged power cord can cause a fire or give you an electrical shock. Check the power cord once in a while. When you find it damaged, ask your nearest service center or your dealer for a replacement.

For Proper and Long Use

On Handling Discs

- Do not touch the playback side of the disc.

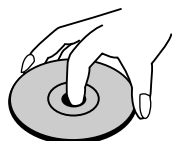

- Do not attach paper or tape to discs.



On Storing Discs

- Do not store discs in a place subject to direct sunlight or near heat sources.
- Do not store discs in places subject to moisture and dust such as a bathroom or near a humidifier.
- Store discs vertically in a case. Stacking or placing objects on discs outside of their case may cause warping.

On Cleaning Discs

- Fingerprints and dust on the disc cause picture and sound deterioration. Wipe the disc from the center outward with a soft cloth. Always keep the disc clean.
- If you cannot wipe off the dust with a soft cloth, wipe the disc lightly with a slightly moistened soft cloth and finish with a dry cloth.
- Do not use any type of solvents such as thinner, benzene, commercially available cleaners or anti-static for vinyl LPs. They may damage the disc.

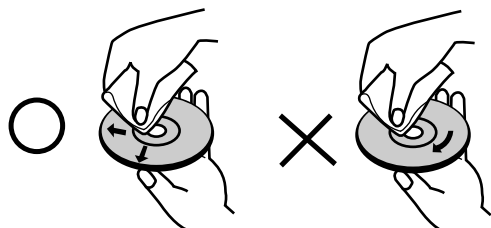

About This Owner's Manual

- This owner's manual explains the basic instructions of this DVD player.
- Some DVD video discs have functions that may not be explained in this owner's manual. Therefore, some instructions may differ from this owner's manual, and there may be extra instructions. In this case, follow the instructions displayed on the TV screen or package.
- “  ” may appear on the TV screen during operation. This icon means the function explained in this owner's manual is not available on that specific DVD video disc.

Features

- DVD : a completely new dimension in video entertainment
- Subtitles may be displayed in one of maximum of 32 languages.
- The audio soundtrack can be heard in up to 8 languages.
- The multi-angle function allows you to choose the viewing angle of the scenes which were shot from a number of different angles. (Limited to DVD recorded with multiple camera angles.)

■ High Quality digital audio

With the linear PCM sound of a 48 kHz/ 16 bit through 96 kHz/ 24 bit, Digital to Analog Converter (DAC) audio quality exceeding that of CDs is possible.

■ Main convenient features

- DISPLAY Menu Icons show the disc information or player information and provide access to many major functions of this unit.
- Reproducing stereo system is connected. [Dolby Digital 5.1CH DVD encoded software only]
- Programming of up to 5 scenes in memory (markers).
- Parental lock settings to prevent play of discs unsuitable for some audiences [DVD only]

■ Compatible with CD as well as DVD

■ Disc formats supported by this player

This unit can play back discs bearing any of the following marks:



DVD
[3" (8 cm) disc/ 5" (12 cm) disc]



CD
[3" (8 cm) disc/ 5" (12 cm) disc]



VIDEO CD
[3" (8 cm) disc/ 5" (12 cm) disc]

Note

If no command from either the remote control or front panel is given for more than 8 minutes in stop mode, the unit will turn off automatically to STANDBY. If you wish to temporarily interrupt viewing for more than 8 minutes and resume later, press the PAUSE button.

Identification of Controls

Front Panel

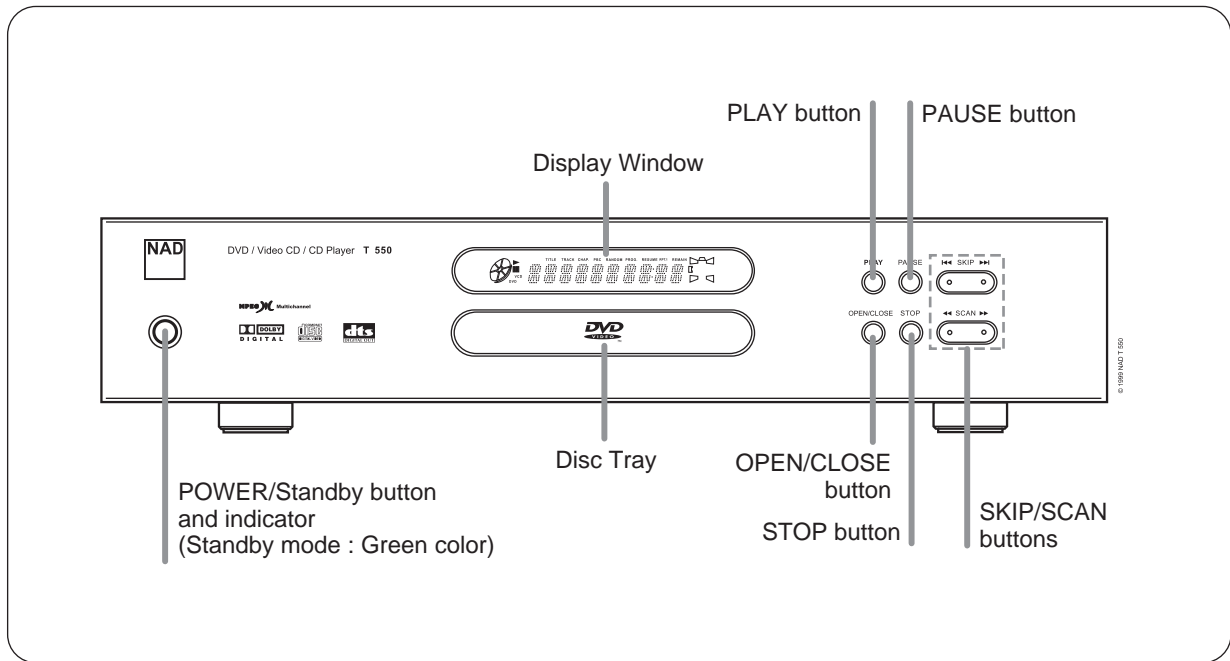

Display Window

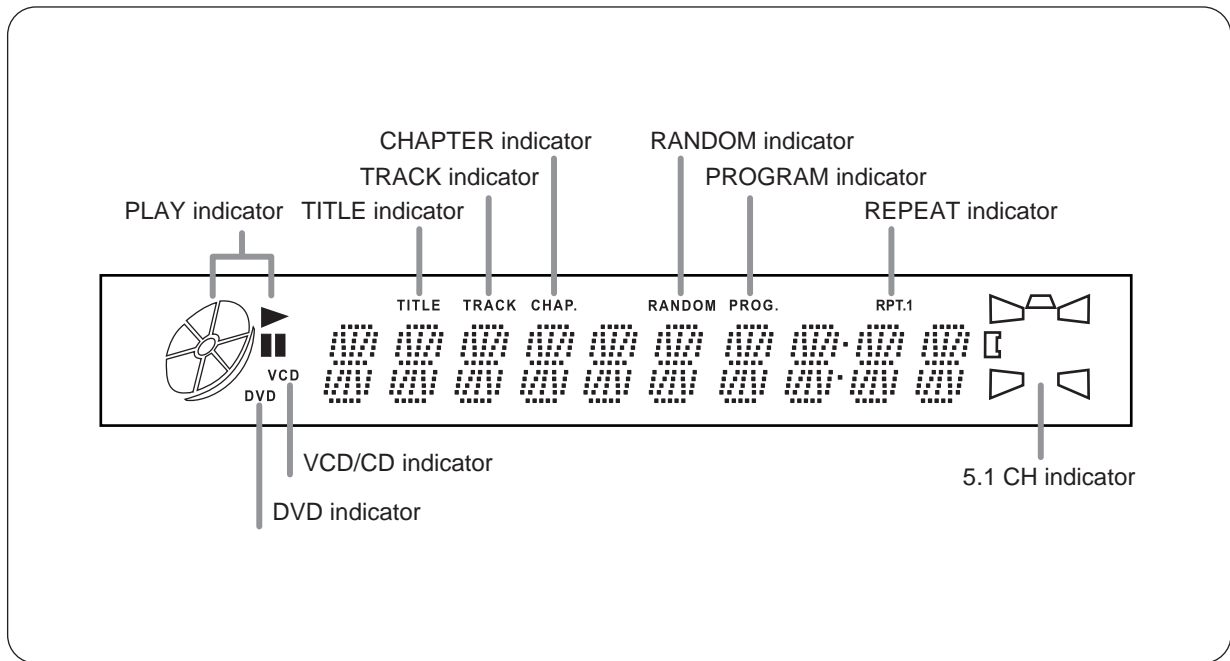

Identification of Controls

Rear Panel

[USA/CANADA Version]

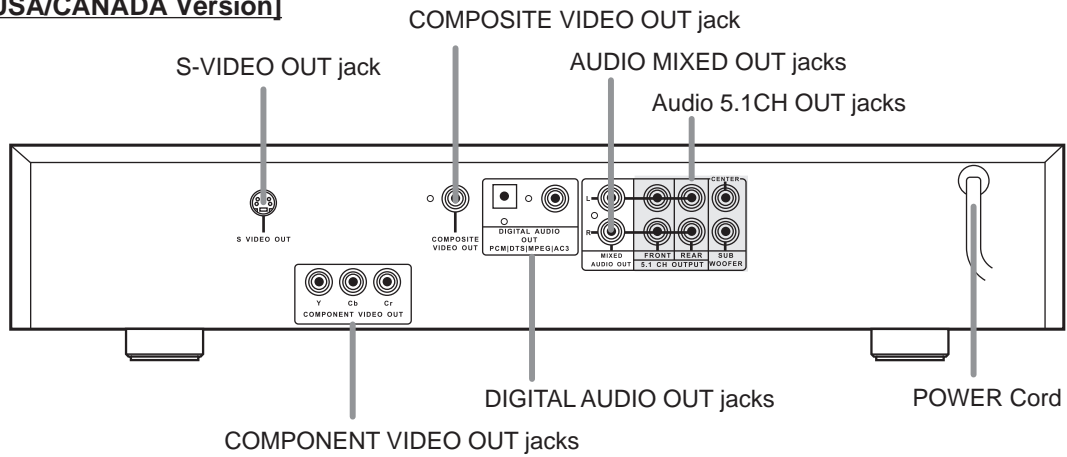

[EUR Version]

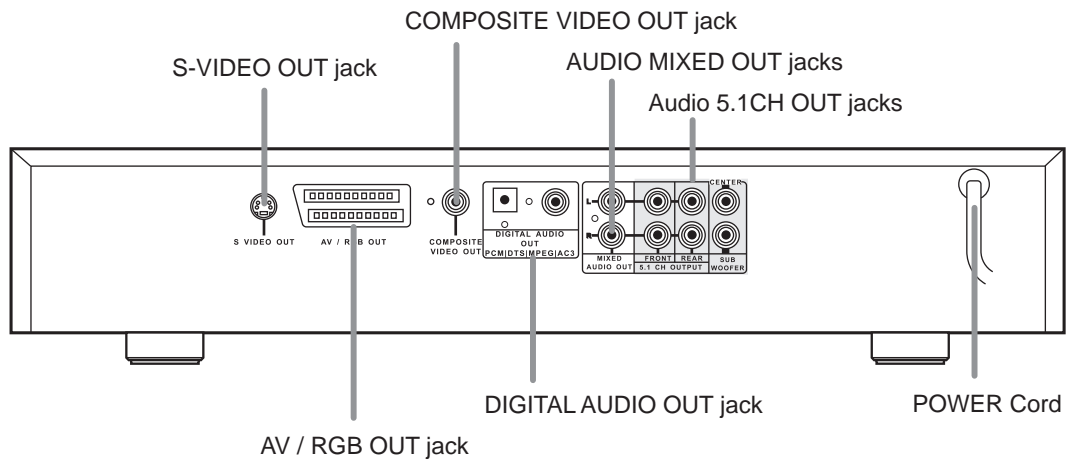

OPTICAL DIGITAL AUDIO OUT jack

Remove the dust protection cap from the connector and connect the optical digital cable (not supplied) firmly so that the configurations of both the cable and the connector match. Keep the dust protection cap and always reattach the cap when not using the connector to protect against dust.

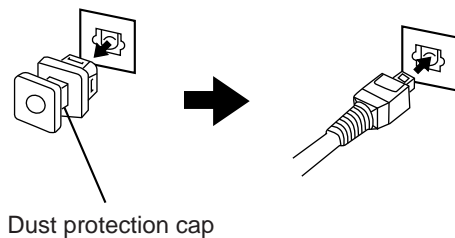

Identification of Controls

REMOTE CONTROL

You will find instructions for each of the remote control functions in the appropriate sections of this instruction manual.

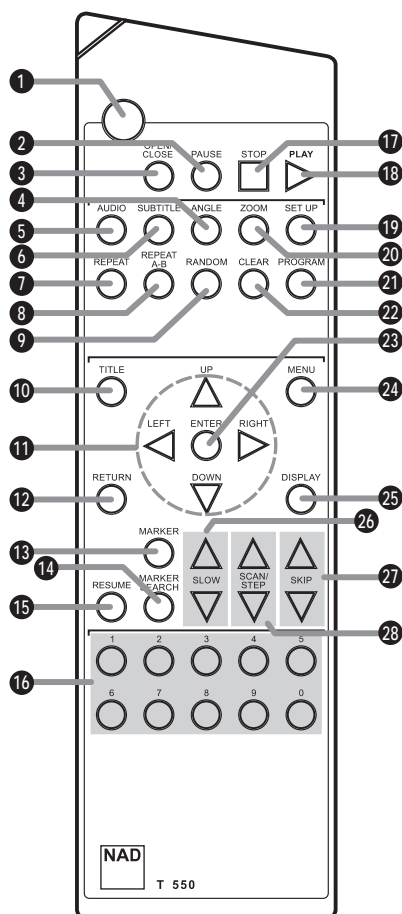

1. POWER button
2. PAUSE button
3. OPEN/CLOSE button
4. ANGLE button
5. AUDIO button
6. SUBTITLE button
7. REPEAT button
8. REPEAT A-B button
9. RANDOM button
10. *TITLE button
11. **ARROW buttons
12. RETURN button
13. MARKER button
14. MARKER SEARCH button
15. RESUME button
16. Numeric buttons

17. STOP button
18. PLAY button
19. SET UP button
20. ZOOM button
21. PROGRAM button
22. CLEAR button
23. ENTER button
24. ***MENU button
25. DISPLAY button
26. SLOW buttons
27. FWD/REV SKIP buttons
28. SCAN/STEP buttons

*TITLE button

Use the TITLE button to display the title screen included on DVD video discs. To operate a menu screen, follow the instructions in "Using a Title Menu".

**Directional Arrow buttons

(up, down, left, right) for use in highlighting a selection on a DISPLAY menu screen, TITLE and MENU screen.

***MENU button

Use the MENU button to display the menu screen included on DVD video discs. To operate a menu screen, follow the instructions in "Using a DVD Menu".

Identification of Controls

Preparing the Remote Control

Insert the batteries into the remote control so you can use it to operate the DVD player.

1 Open the battery cover.

2 Insert batteries (AAA size).

- Make sure to match the + and - on the batteries to the marks inside the battery compartment.

3 Close the cover.

Notes

- Improper use of batteries may cause battery leakage and corrosion.
- To operate the remote control correctly, follow the instructions below.
- Do not insert the batteries into the remote control in the wrong direction.
- Do not charge, heat, open, or short-circuit the batteries. Do not throw the batteries into fire.
- Do not leave dead or exhausted batteries in the remote control.
- Do not use different types of batteries together, or mix old and new batteries.
- If you do not use the remote control for a long period of time, remove the batteries to avoid possible damage from battery corrosion.
- If the remote control does not function correctly or if the operating range becomes reduced, replace all batteries with new ones.
- If battery leakage occurs, wipe the battery liquid from the battery compartment, then insert new batteries.
- The batteries should last about one year with normal use.

Operating with the Remote Control

This section shows you how to use the remote control.

Point the remote control at the remote sensor and press the buttons

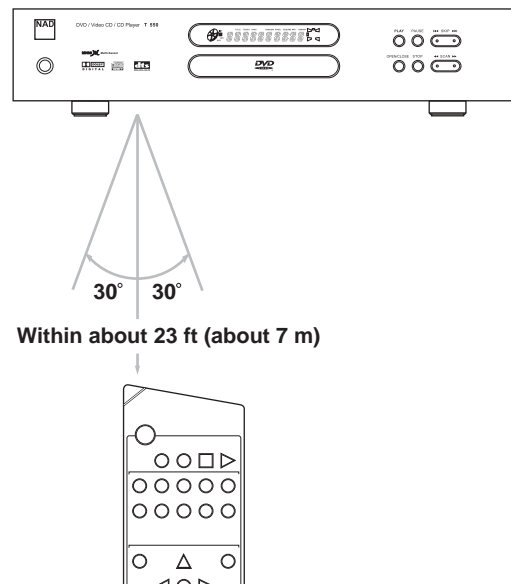

Distance : About 23 ft (7 m) from the front of the remote sensor.

Angle : About 30° in each direction of the front of the remote sensor.

- Do not expose the remote sensor of the DVD player to a strong light source such as direct sunlight or illumination. If you do so, you may not be able to operate the DVD player with the remote control.

Notes on the remote control

- Direct the remote control at the remote sensor of the DVD player.
- Do not drop or give the remote control a shock.
- Do not leave the remote control near extremely hot or humid place.
- Do not spill water or put anything wet on the remote control.
- Do not open the remote control.

Connecting to a TV

Connect the DVD player to your TV

If the player is connected to the TV through a video cassette recorder, the picture may not be played back normally with some DVDs. So we strongly recommended you not to connect the DVD player to your video cassette recorder when setting up your home entertainment system.

To view pictures from the video cassette recorder, set the player to the standby mode.

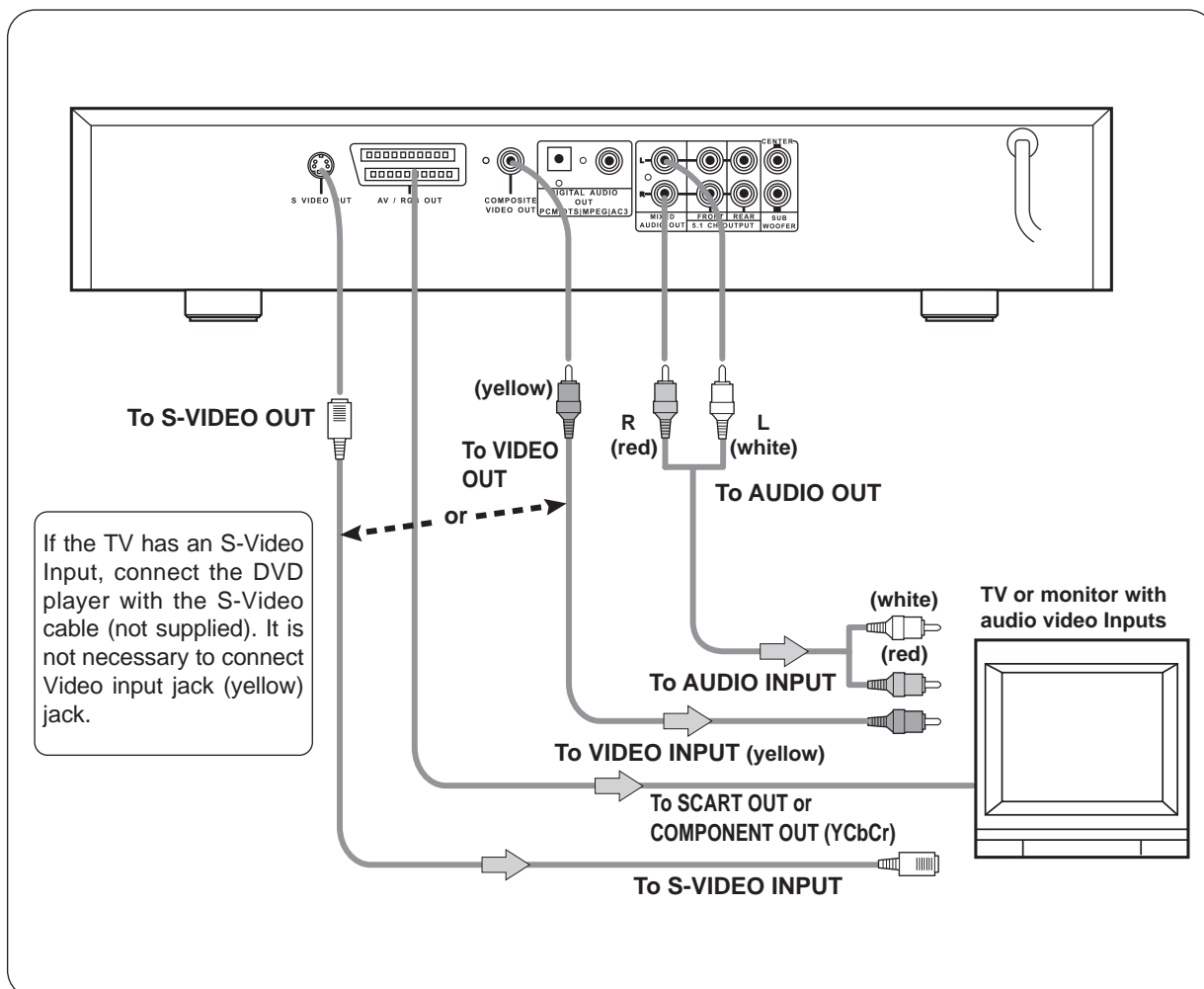

Notes

- Refer to the owner's manual of your TV as well.
- When you connect the DVD player to your TV, be sure to turn off the power and unplug both units from the wall outlet before making any connections.
- If your television set has one audio input, connect the DVD player to a Y cable adapter (not supplied) and then connect to your TV.
- Connect the DVD player to your TV directly. If you connect the DVD player to a VCR, the playback picture will be distorted because DVD video discs are copy protected.
- Change the setting of speaker output in Initial Setup, from Multi-channel to Two channel. (Refer to page 34)
- The North American version is also equipped with Component Video Out sockets. Connect these if your TV has Component Video In sockets. Make sure that the TV also uses the Y-Cb-Cr Component Video system. Make sure to connect all three sockets to the matching sockets on the TV.
- Do not connect the T550 to the SCART input and COMPOSITE VIDEO input of the TV at the same time.

Connecting to an Audio System

You can listen to the sound of audio CDs and DVD video discs in stereo.

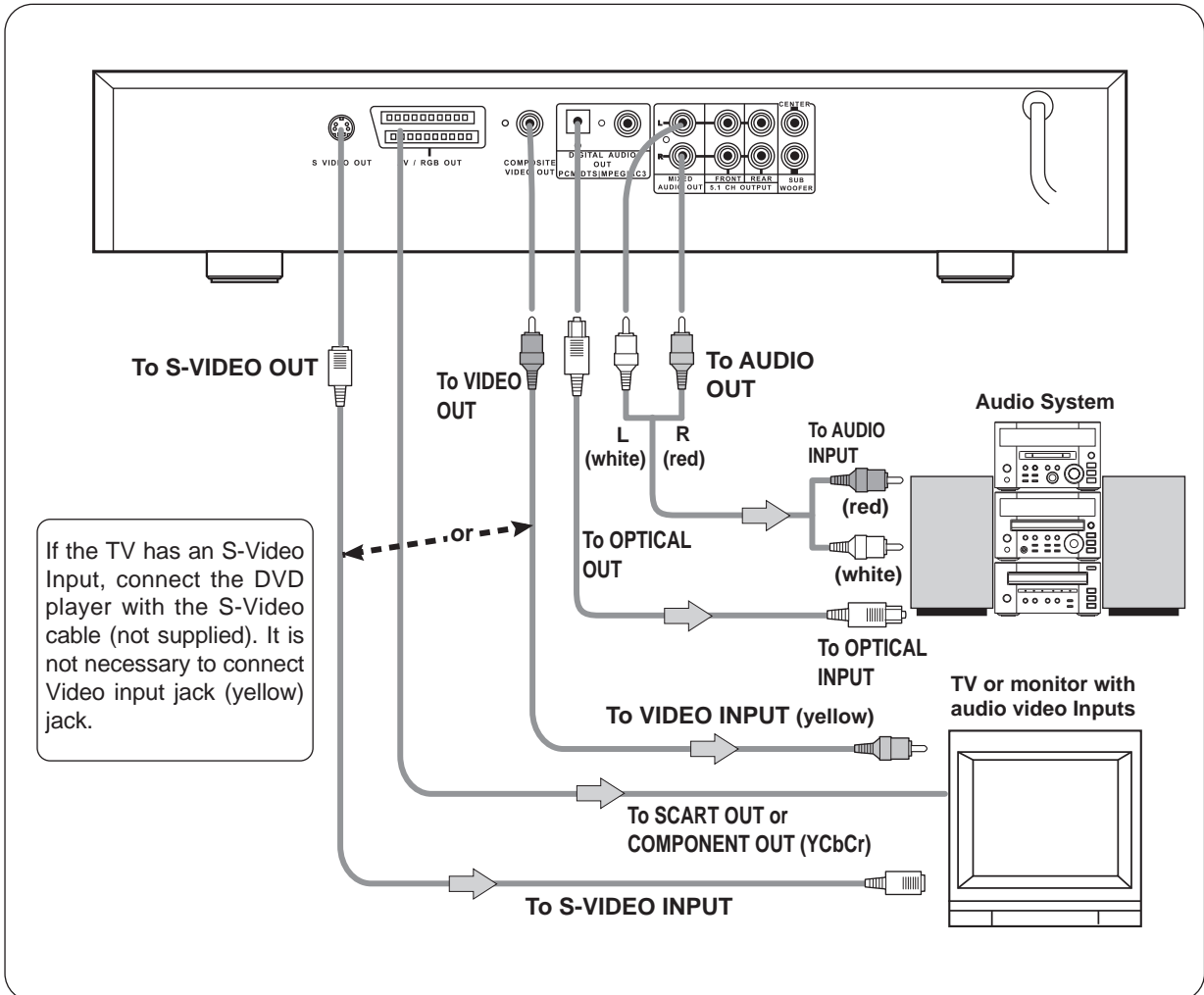

Notes

- Refer to the owner's manual of your audio system as well.
- When you connect the DVD player to other equipment, be sure to turn off the power and unplug all of the equipment from the wall outlet before making any connections.
- If you place the DVD player near a tuner or radio, the radio broadcast sound might be distorted. In this case, move the DVD play away from the tuner and radio.
- The output sound of the DVD player has a wide dynamic range. Be sure to adjust the receiver's volume to a moderate listening level. Otherwise, the speakers may be damaged by a sudden high volume sound.
- Turn off the receiver before you connect or disconnect the DVD player's power cord. If you leave the receiver power on, the speakers may be damaged.
- Change the setting of speaker output in Initial Setup, from Multichannel to Two channel. (Refer to page 34)

⚠ Warning

Do not set the Audio Output of this DVD player to "Stream/PCM" unless you are connecting either the coaxial or optical digital audio jack of this DVD player to an AV decoder that has the Dolby Digital (AC-3) decoding function. Do not connect both the coaxial and optical sockets to the same decoder. High volume sound may damage your hearing as well as the speakers.

Connecting to Optional Equipment

Enjoying Dolby Digital Sound

You can enjoy the high quality dynamic sound of Dolby Digital Dolby Pro Logic, and 2 Channel Digital Stereo.

Dolby Digital

Dolby Digital is the surround sound technology used in the theaters showing the latest movies, and is now available to reproduce this realistic effect in the home. You can enjoy motion picture and live concert DVD video discs with this dynamic realistic sound by connecting the DVD player to a 6 channel amplifier equipped with a Dolby Digital decoder or Dolby Digital processor.

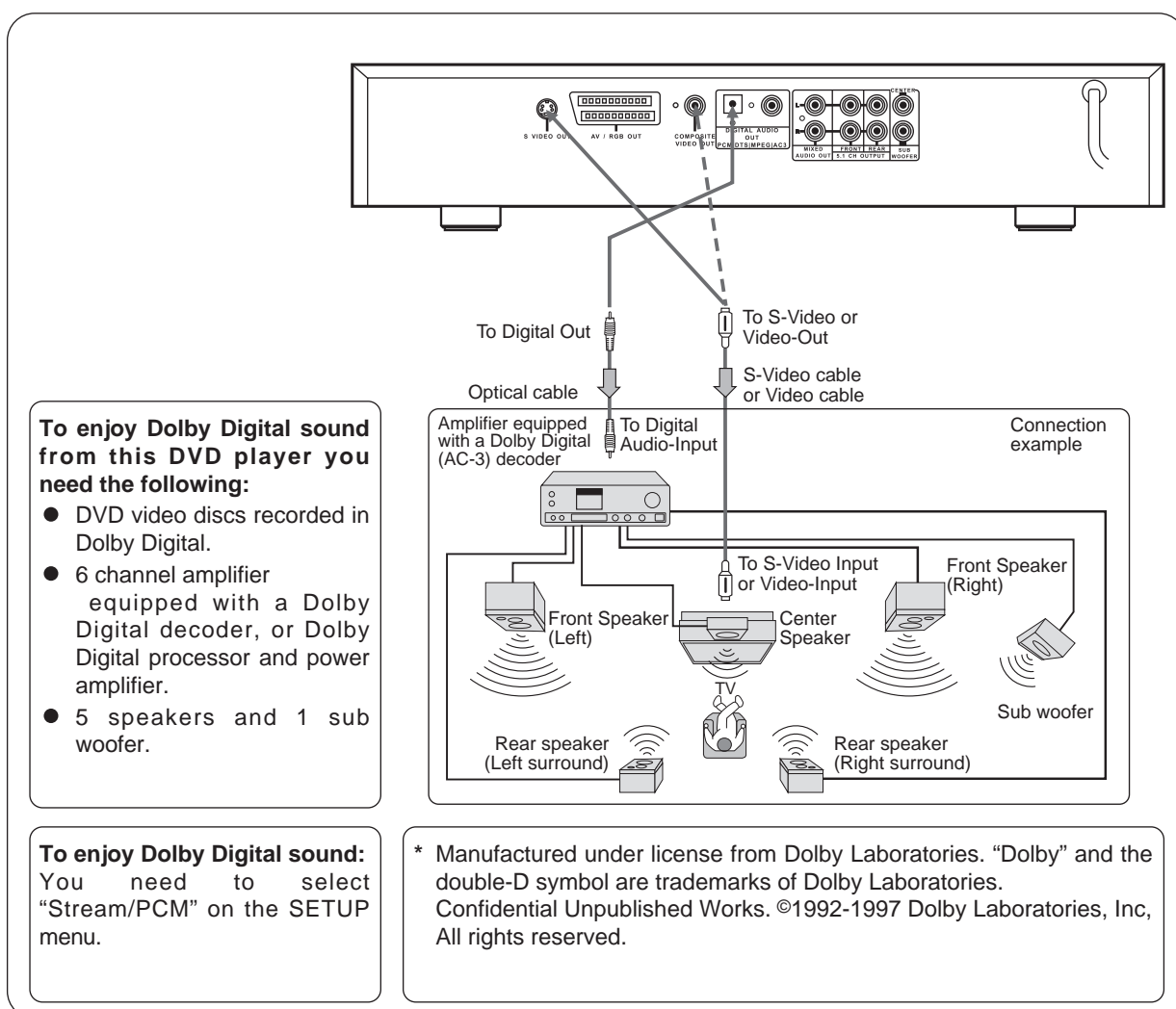

Notes

- Refer to the owner's manual of your audio equipment as well.
- When you connect the DVD player to other equipment, be sure to turn off the power and unplug all of the equipment from the wall outlet before making any connections.
- The output sound of the DVD player has a wide dynamic range. Be sure to adjust the receiver's volume to a moderate listening level. Otherwise, the speakers may be damaged by a sudden high volume sound.
- Turn off the amplifier before you connect or disconnect the DVD player's power cord. If you leave the amplifier power on, the speakers may be damaged.

Connecting to Optional Equipment

Enjoying Dolby Digital (5.1 CH) Sound

Dolby Digital Surround (5.1 CH)

Dolby Digital (AC-3) is a six-channel digital surround sound technology developed by Dolby Laboratories for theater-like surround sound reproduction. DVDs supporting Dolby Digital (AC-3) technology feature the logo. You can enjoy realistic, theater-like surround sound from DVD movie or music disc featuring this logo. Two front, one center and two rear speakers plus a subwoofer make up the “5.1-channel” audio system that Dolby Digital (AC-3) uses.

Hook-ups

Connect an amplifier with 5.1 channel inputs to the player and to the speakers. See the figure below.

Note :

Make sure that the setting of speaker output in Initial Setup is Multichannel. (Refer to page 34)

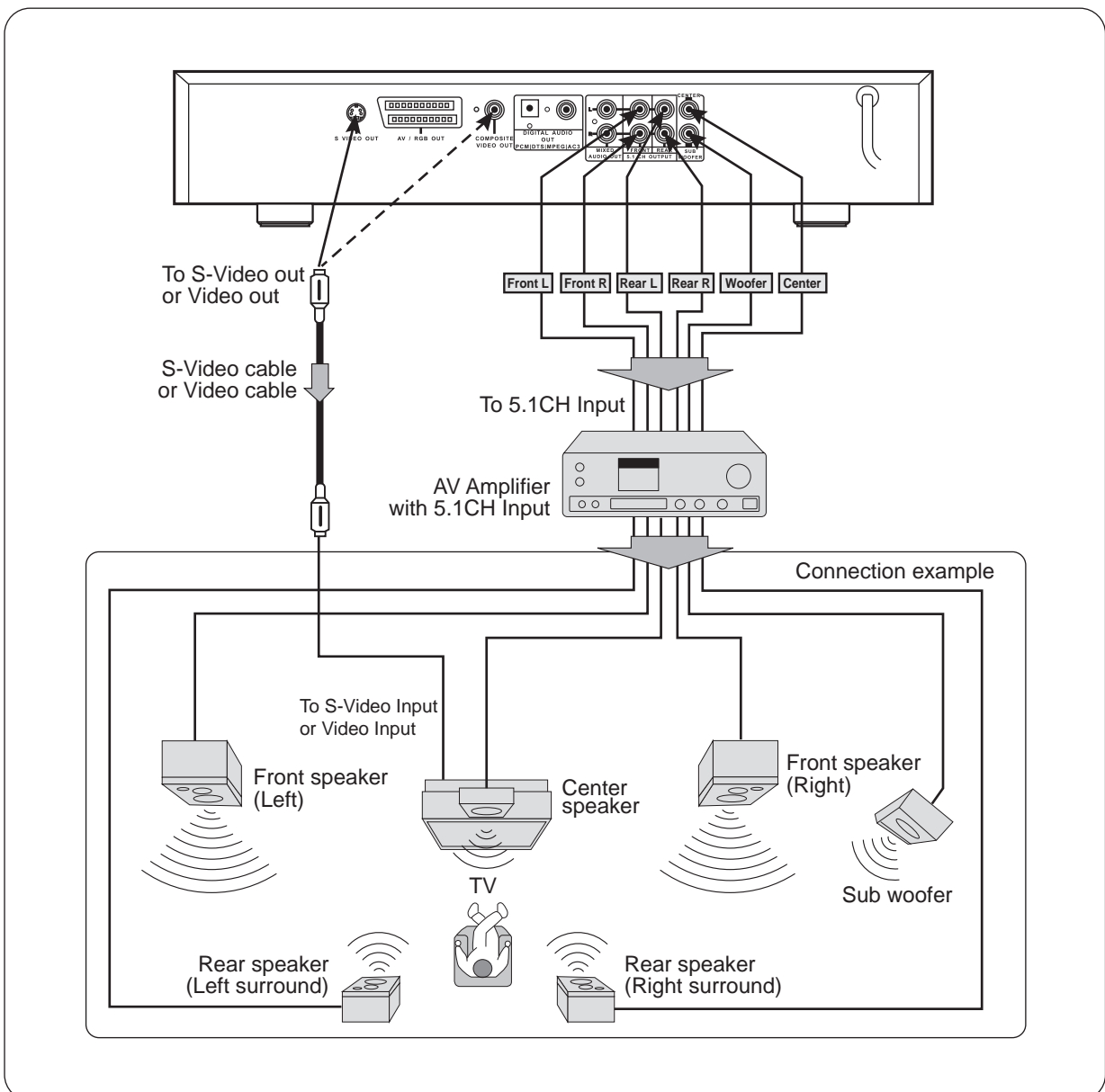

Connecting to Optional Equipment

Enjoying Dolby Pro Logic Surround Sound

Dolby Pro Logic Surround

You can still enjoy the excitement of Surround Sound even if your A/V receiver does not offer Dolby Digital (AC-3) decoding. If you A/V receiver has a Dolby Pro Logic decoder. Refer to the following connecting diagram.

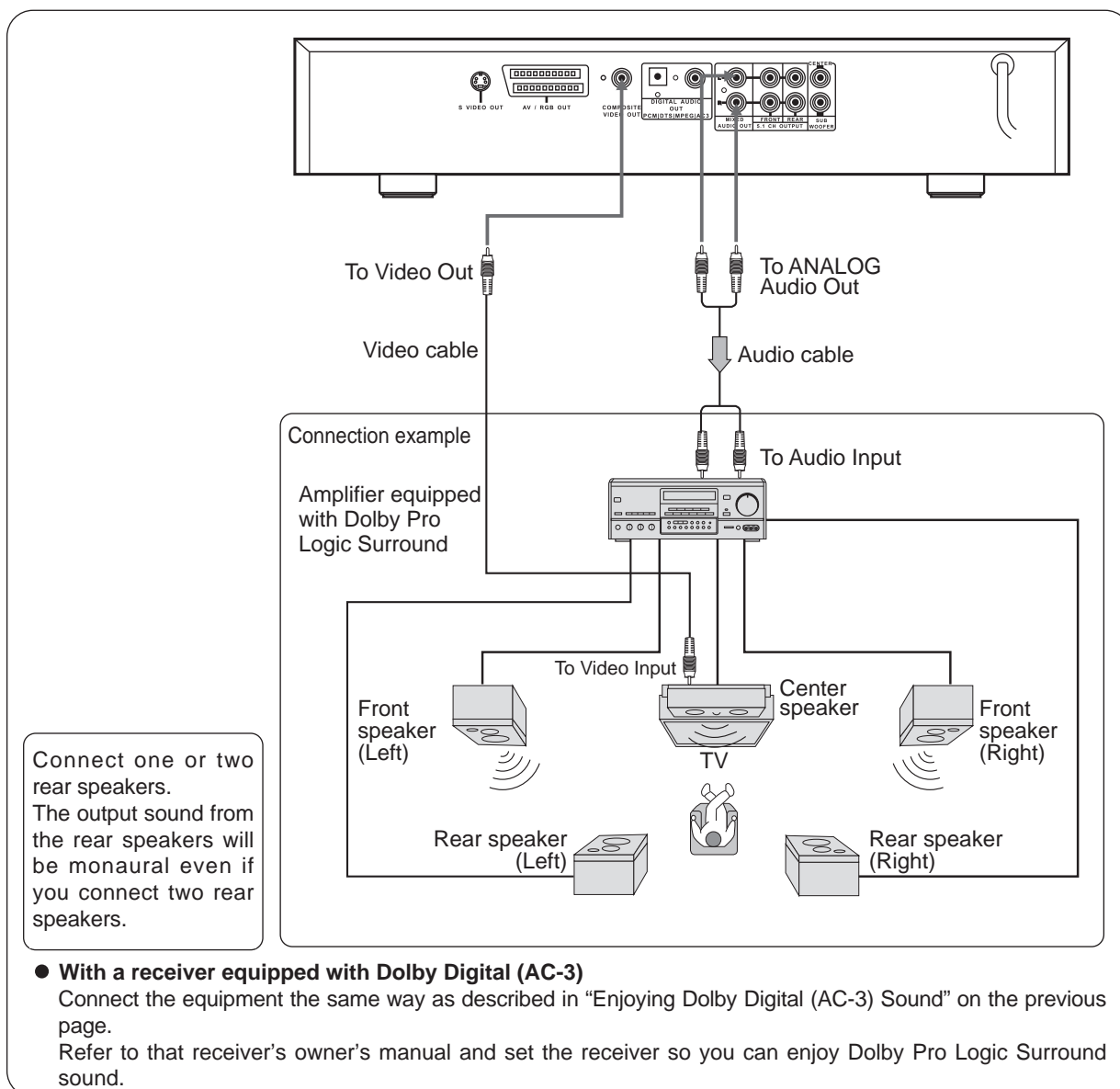

Note

- Change the setting of speaker output in Initial Setup, from Multichannel to Two channel. (Refer to page 34)

⚠ Warning

Do not set the Audio Output of this DVD player to “Stream/PCM” unless you are connecting either the coaxial or optical digital audio jack of this DVD player to an AV decoder that has the Dolby Digital (AC-3) decoding function. Do not connect both the coaxial and optical sockets to the same decoder. High volume sound may damage your hearing as well as the speakers.

Connecting to Optional Equipment

Enjoying 2 Channel Digital Stereo Sound

2 Channel Digital Stereo

You can enjoy the dynamic sound of 2 Channel Digital Stereo by connecting this DVD player to a receiver equipped with a digital audio input and speaker system (right and left front speakers).

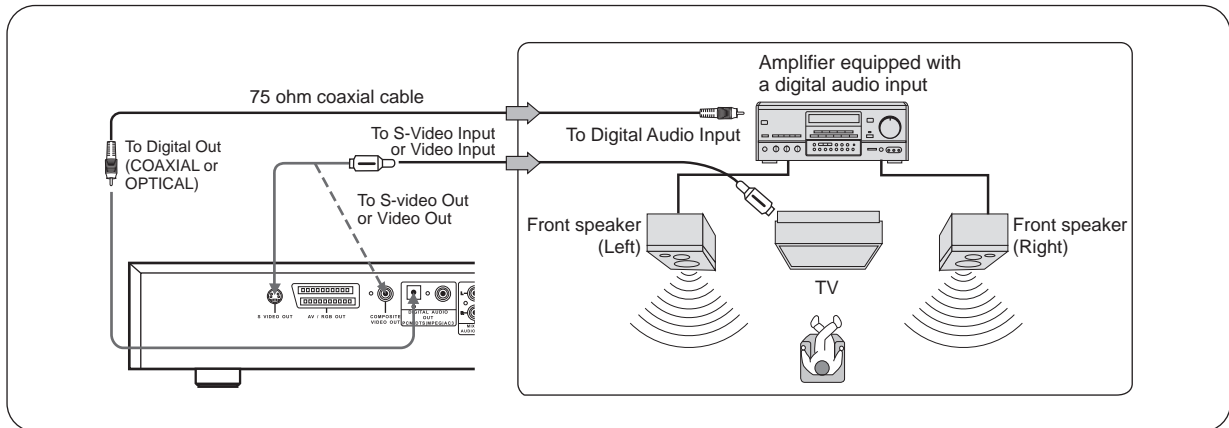

DTS Sound

Like Dolby Digital, DTS is a multichannel digital format with 6 discrete channels of sound. Some DVDs are encoded using the DTS system. Although the NAD T550 doesn't decode a DTS encoded DVD, it will pass on the DTS digital signal through either the coaxial or optical digital output.

Connect either the coaxial or optical digital output to a decoder or receiver (such as the NAD T760) capable of decoding DTS signals.

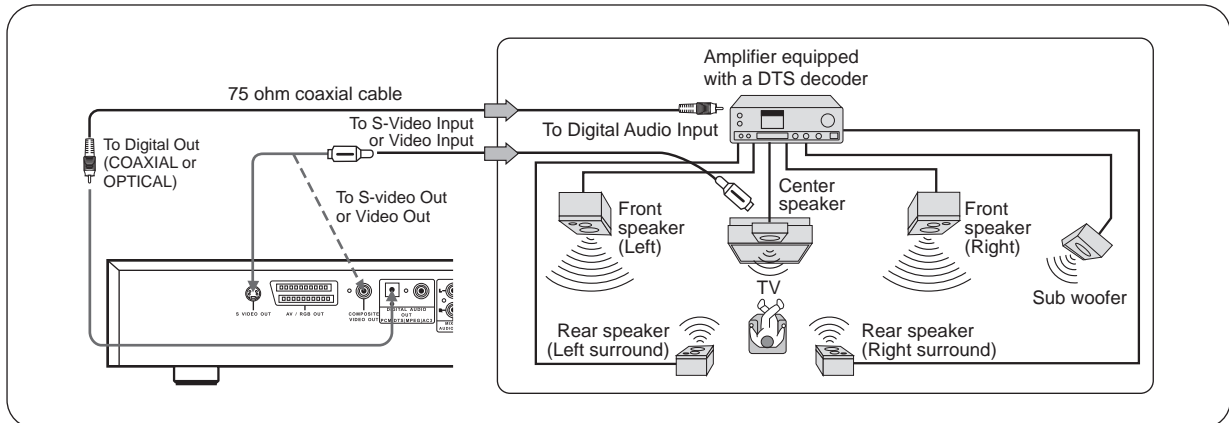

“DTS” and “DTS Digital Surround” are trademarks of Digital Theater Systems, Inc.

Notes

- Refer to the owner's manual of your audio receiver as well.
- When you connect the DVD player to other equipment, be sure to turn off the power and unplug all of the equipment from the wall outlet before making any connections.
- The output sound of the DVD player has a wide dynamic range. Be sure to adjust the receiver's volume to a moderate listening level. Otherwise, the speakers may be damaged by a sudden high volume sound.
- Turn off the receiver before you connect or disconnect the DVD player's power cord. If you leave the receiver power on, the speakers may be damaged.
- To listen to the DTS audio CDs, you have to select AUDIO mode to “Stereo”. (Refer to page 24)

Basic Playback



Playing DVDs, CDs and Video CDs

- Turn the TV's power on and set its input to a position for DVD viewing (VIDEO etc.).
- When this unit is connected to a stereo, turn the power of the stereo components on and select the appropriate input.

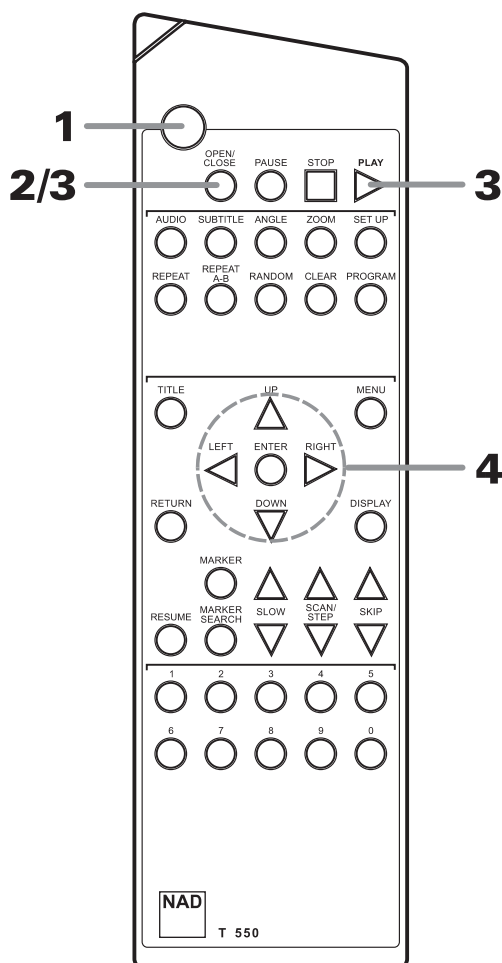

1 Press the POWER switch.
When the STANDBY is on, you can power on with the remote control.

2 Press the OPEN/CLOSE (▲) button.

- Press the OPEN/CLOSE (▲) button on the remote control unit.
- The disc table comes out.

3 Load a disc with the label side facing up, using the disc table guide to align the disc.

- Press PLAY button. The disc table will close and playback will begin. Depending on the disc, a menu is displayed. If a menu is displayed, refer to step 4.
- Alternatively, press the OPEN button on the remote control or OPEN/CLOSE button on the front panel. The disc table will close, and depending on the disc, playback begins automatically.

4 Select the item you want to view. (DVD only)

Select the item with the ▲/▼/◀/▶ buttons, then press the ENTER button.

TITLE MENU	
1	POP
2	JAZZ
3	COUNTRY
4	R&B
5	CLASSIC

Ex: When a DVD that has menu screens is loaded

To return to the menu screen

- Although this differs depending on the disc, pressing the TITLE button, the MENU button or the RETURN button during DVD playback will return the screen to the menu screen.

Basic Playback

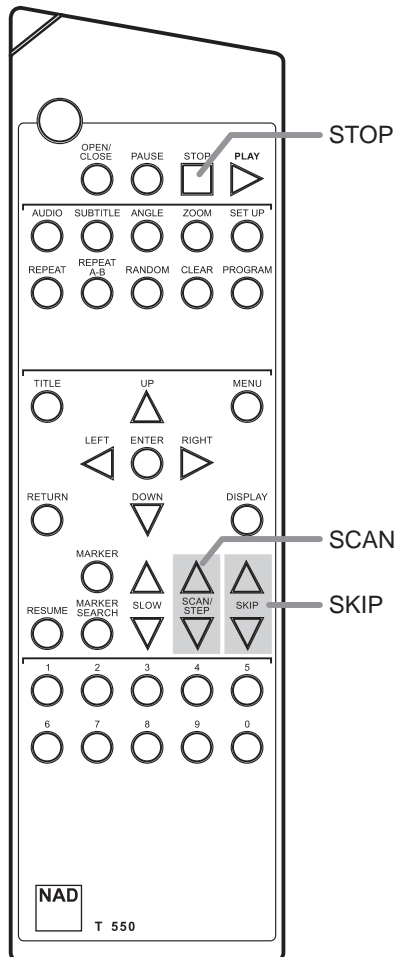

Stopping Playback & Switching Power Off

- 1** Press the **STOP** (■) button.
Playback stops.
- 2** Press the **OPEN/CLOSE** (▲) button.
 - The disc table comes out.
- 3** Remove the disc.
- 4** Press the **POWER** button.
 - The disc table goes back in, the unit enters standby mode, and the STANDBY indicator lights.

Skipping forward or back

Skipping forward to the next chapter (track)

Press **SKIP** ▲ on remote control unit or ►► button on the front panel.

Skipping back to the previous chapter (track)

Press **SKIP** ▼ on remote control unit or ◀◀ button on the front panel.

Scanning forward or back

Fast forward

Press **SCAN** ▲ on remote control unit or ►► button on the front panel.

Fast reverse

Press **SCAN** ▼ on remote control unit or ◀◀ button on the front panel.

To increase the scanning speed (forward or reverse), press the buttons once more.

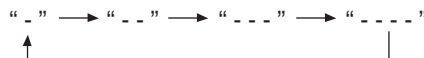

To return to normal playback, press **PLAY** button.

Notes

- The DVD player does not playback sound during the fast reverse and forward playback of DVDs and VCDs however, the DVD player playback sound during fast forward or fast reverse playback of audio CDs.

Basic Playback

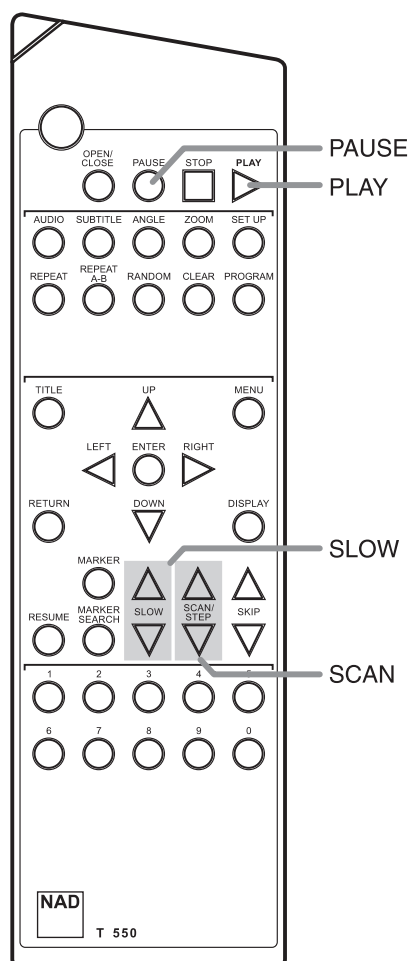

Viewing a still frame

Press **PAUSE** button.

To return to normal playback, press **PLAY** or **PAUSE** button.

Slow Playback-Viewing a slow picture

Press or hold **SLOW ▼** or **SLOW ▲** during playback.

- During slow playback, the playback speed and direction can be selected with **SLOW ▼** or **SLOW ▲**.
- To increase the playback speed, press the one button as the playback direction.
- To reverse the playback direction, press the other button opposite to the playback direction.
- With Video CD, reverse play is not possible.

To return to normal playback, press **PLAY** button.

Playing Frame by Frame

1 Press the **PAUSE** button.

2 Press the **SCAN ▲** or **SCAN ▼** button.

- **▲** : The picture will be advanced by one frame each time the button is pressed.
- **▼** : The picture will be backed up frame by frame each time the button is pressed. (DVD only)

Notes

- There is no sound when viewing still frames or slow playback, or when advancing one frame at a time.
- Pause, slow playback, or frame advance playback may not be possible with certain titles. In this case, the “▶||, ||◀” mark is displayed.

Basic Playback

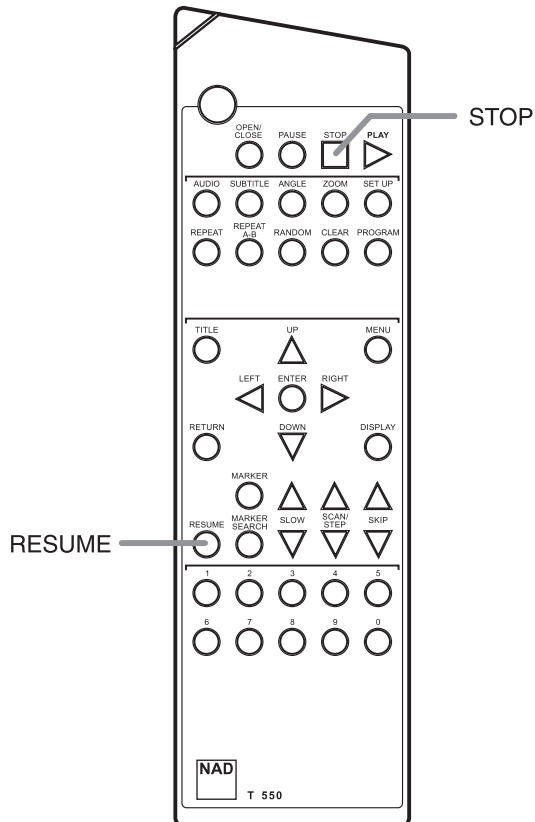

Resuming Playback from the same location

You can stop playback and resume playback later from the same location on the disc.

1 Press STOP at the location where you want to interrupt playback.

- The DVD player memorizes the location where you stopped playback.
- The DVD player stores that location in its memory, unless you turn off the player or open the disc tray.
- Opening the disc tray or switching to standby cancels this function.

2 Press RESUME. The DVD player resumes playback slightly before the location where you stopped playback.

Notes

- The Resume function is cancelled if the DVD player is disconnected from the wall outlet, or if power is interrupted.
- The DVD player resumes playback from the place of the stopped chapter.
- The resume function will work up to 8 minutes if no other commands are received by the unit. After 8 minutes the unit will automatically switch to standby. If you want to continue playing after an interruption of more that 8 minutes you can use the PAUSE function.

Viewing Information about DISPLAY

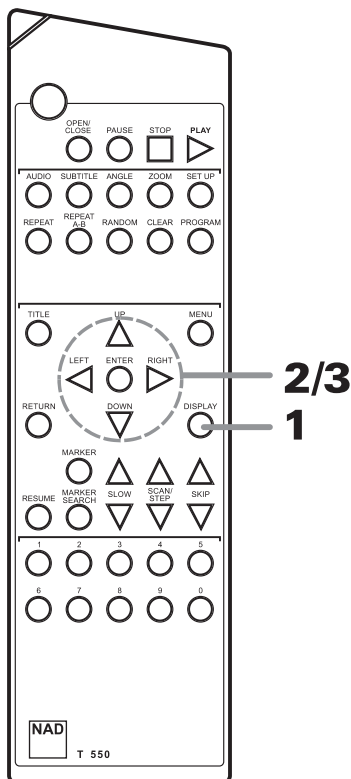

1 Press DISPLAY during playback.

- The DISPLAY is displayed on the TV:
- **Title, Chapter, Track** : Total numbers of Title, Chapter and Track that are recorded on the disc.
- **Time, Audio, Subtitle, Sound, Angle** : the information of the current playback location and mode.

2 Select the desired position or items using the ▲/▼/◀/▶ buttons.

- **Time Search (DVD/VCD)** : input the time using numeric buttons.

3 Press the ENTER button.

To clear the display window of disc information, press RETURN or DISPLAY.

Display window would be cleared automatically, if no other command is given for 5 seconds.

★ SOUND function is not provided.

DVD DISPLAY

	TITLE	1/1
	CHAPTER	2/15
	TIME	0 : 05 : 34
	AUDIO	English AC3 6CH
	SUBTITLE	OFF
	SOUND	NORMAL
	ANGLE	1/2

CD DISPLAY

	TRACK	2/15
	TIME	05 : 34
	AUDIO	Stereo
	SOUND	NORMAL

Using a title menu/DVD menu



Using a title Menu

Some movie discs may contain two or more titles. If the disc has a title menu recorded on it, the TITLE button can be used to select the movie title. (The details of operation differ depending on the disc used.)

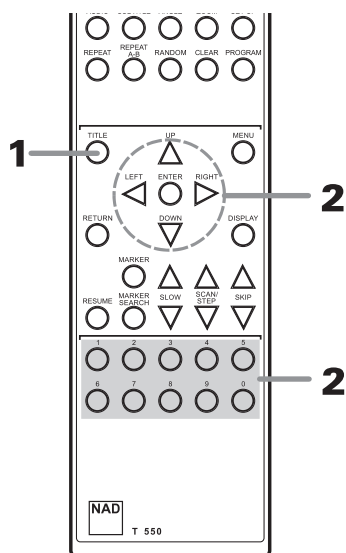

1 Press TITLE.

A list of the current titles is displayed.

(1)

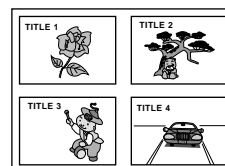

(2)



The details of operation differ depending on the disc used.

2 Press and press ENTER, to select desired title.

The selected title now starts playing.

Using a DVD Menu

Some DVDs have unique menu structures called DVD menus. For example, DVDs programmed with complex contents provided guide menus, and those recorded with various languages provided menus for audio and subtitle language. Although the DVD menu's contents and operation differ from disc, the following explains the basic operation when this feature is used.

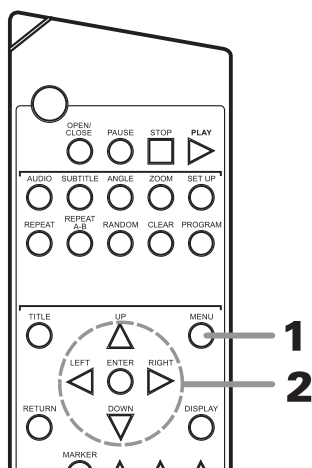

1 Press MENU during play.

The DVD menu available on the disc is now displayed.

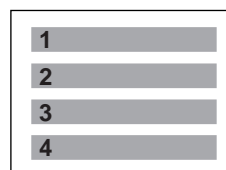

Pressing RETURN again resumes play from the scene when MENU was first pressed.

2 Press /// and press ENTER, to select desired item.

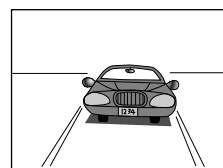

The selected item is now executed.

Changing subtitle language



It is possible to change the subtitle language to a different language from the one selected at the initial settings.

This operation works only with discs on which multiple subtitle languages are recorded.

- 1 Press SUBTITLE during playback.**
When no subtitles are recorded, "OFF" will be displayed instead of the language.

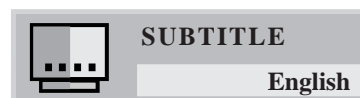

- 2 Press repeatedly </> button until the desired language or "off" is selected.**

- 3 Press the ENTER button.**

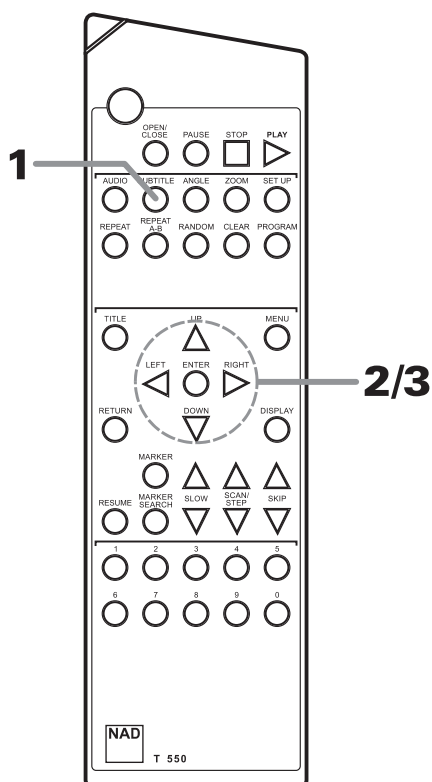

Notes

- In some cases, the subtitle language is not changed to the selected one immediately.
- When a disc supporting the closed caption is played, the subtitle and the closed caption may overlap each other on the TV screen. In this case, turn the subtitle off.
- When the desired language is not selected even after pressing the button several times, it means that the language is not available on the disc.
- When the power is turned on or the disc is replaced, subtitles appears in the language selected at the initial settings. If this language is not recorded on the disc, the disc's priority language appears.

Viewing from another angle



Some DVDs may contain scenes which have been shot simultaneously from a number of different angles. For these discs, the same scene can be viewed from each of these different angles using the ANGLE button. (The recorded angles differ depending on the disc used.)

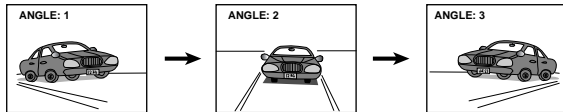

1 Press ANGLE during playback.



2 Press ◀▶, ANGLE repeatedly until the desired angle is selected.

3 Press ENTER button.

Notes

- This function only works for discs having scenes recorded at different angles.
- The angle number can be programmed beforehand; the angle will be switched to the selected number when the ANGLE indicator lights up.

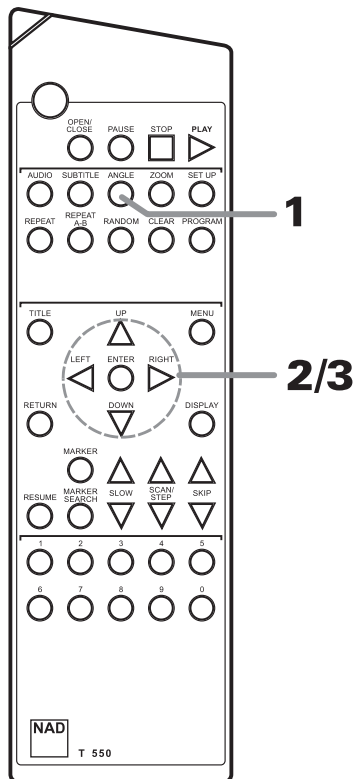

Repeat Play



- Press REPEAT during playback.
Press ◀▶ to select the Repeat mode.

● DVD

Repeat of chapter being played



Repeat of title being played



Cancel repeat mode (normal play)



● CD

Repeat of track being played



Repeat of entire disc contents



Cancel repeat mode (normal play)



Press the ENTER button to select the desired item.

To return to normal play

Press ◀▶ several times until "OFF" is displayed.

Note

- VIDEO CD 2.0 disc can not repeat playback.

Repeating sections between two specific points (A-B repeat)

- 1 Press A-B during play at the point where repeat play is to start (A).



Repeat indicator (RPT.) is blinking on the Display window (Refer to page 10).

- 2 Press A-B during play at the point where repeat play is to be concluded (B).



Repeat play of the selection between points A and B starts.

To return to normal play

Press A-B once "OFF" is displayed.
Repeat indicator is "OFF".



Storing markers in memory to be viewed (listened to) again



Storing a MARKER in the DVD memory is similar to marking your page in a book. It allows you to quickly return to any point on the disc.

Storing a marker in the memory

Press **MARKER** during play at the starting point to be viewed (listened to) again.



Indicates "MARKER 1/5" is stored in the memory. Up to 5 markers can be stored in the memory.

Recalling/Clearing a marker

1 Press **MARKER SEARCH** during playback.

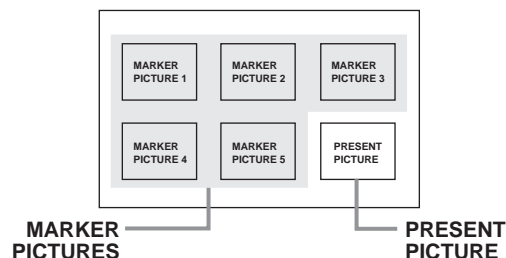

2 Press **▲/▼/◀/▶** to select the marker to be recalled/cleared.

3 Press **PLAY** or **ENTER** button to play from marker's point.
Press **CLEAR** to clear a marker.

Play resumes from the point corresponding to the selected marker, or the selected marker is cleared.

- **MARKER** and **MARKER SEARCH** can only be engaged with the DVD playing. The markers are not retained when pressing **OPEN/CLOSE** or after the unit was switched to standby.

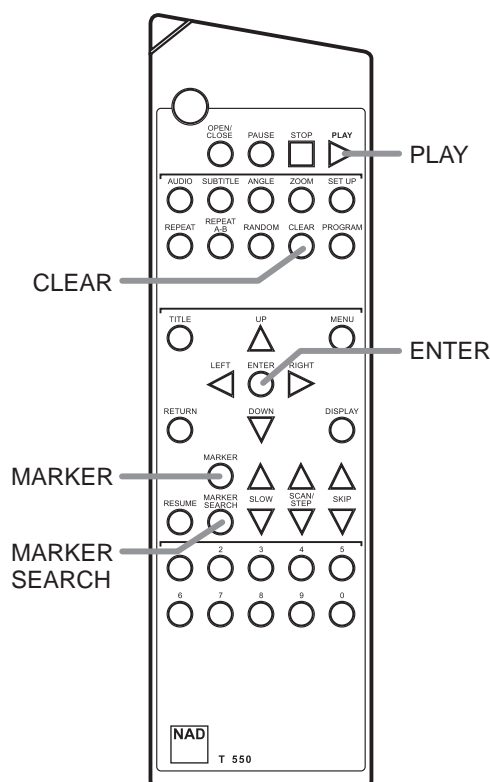

Notes

- These operations work only with discs for which the elapsed playing time appears in the DVD display window during playback.
- Some subtitles recorded around the marker may fail to appear (DVD).
- All the markers are cleared when the power is turned off or the disc is removed.

Zooming Feature/Random play



Zooming Feature (DVD only)

The Zoom feature allows you to “ZOOM-IN” and enlarge the picture on the screen to either 4 times (X4) or 16 times (X16) its normal size.

First select the amount of zoom, then shift the square over the area you wish to enlarge.

1 Press ZOOM during normal playback, still or slow motion playback.

Each press of the ZOOM button changes the TV screen in the following sequence.

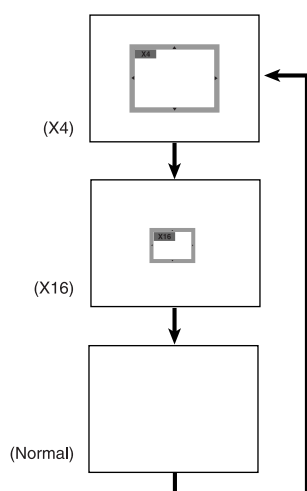

The magnification level will be displayed in the upper left corner of the zoom area.

If you press the ARROW buttons (▲/▼/◀/▶), the zoom point shifts.

2 Press ENTER.

The selected frame is displayed in full size on the TV screen.

3 To resume normal playback

Press ZOOM again to cancel Zoom feature and resume normal playback, still or slow play mode.

Random play (CD)

The player plays the tracks in the disc in random order.

1 Press RANDOM and PLAY in stop mode.

The random track number appears on the TV screen.

Random can also be engaged during play mode. Press RANDOM to engage; after current track is finished, the next track will be selected at random.

Random On

2 To resume normal playback Press RANDOM during random playback.

The display in play mode will change “Random OFF”.

Random Off

Notes

- Random playback may not be possible on certain discs.
- Random play function only works with audio CDs.

Notes

- Some discs may not respond to Zoom feature.
- During some scenes, the buttons may not work in the right column.
- Zoom does not work on menus included on DVD video discs.

Program play



Note : Program play function is possible only with audio CDs. It does not work with DVD movie discs.

The player plays the tracks in the disc in an order you specify.

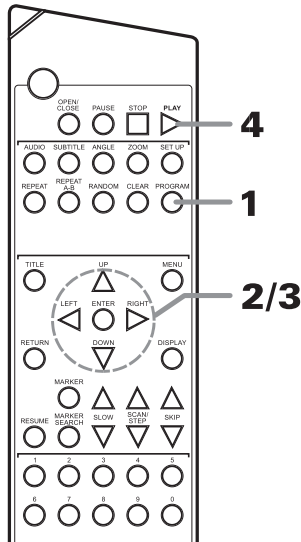

- 1** Press **PROGRAM** during stop mode.
The program screen appears on the TV screen.
- 2** Press **◀▶** or numeric key to select the desired track number and press **ENTER** button.
- 3** Repeat step 2 until all desired tracks have been entered.
 - To clear all programmed tracks, press **CLEAR** button. Use the (skip up/down) buttons to review program entered.
- 4** Press **PLAY** button, to play in the program order.

INTRO play



Note : Intro play function is possible only with audio CDs. It does not work with DVD movie discs.

- 1** Press **DISPLAY** during stop mode.
The Intro playback screen appears on the TV screen.
- 2** Press numeric key according to the desired intro play time.
- 3** Press **ENTER** button, then the player plays sequentially the intro parts in tracks.
- 4** To stop the intro play function, press **STOP** button.

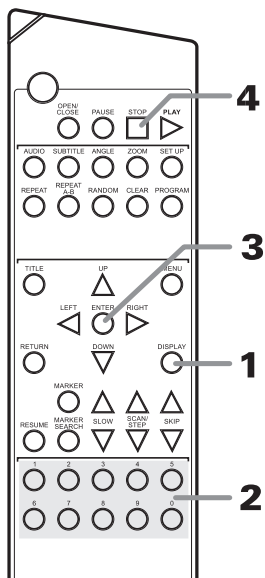

Common procedures of initial settings

Once the initial settings have been completed, the player can always be operated under the same conditions (especially with DVD discs).

The settings will be retained in the memory until they are changed, even if the power is switched off.

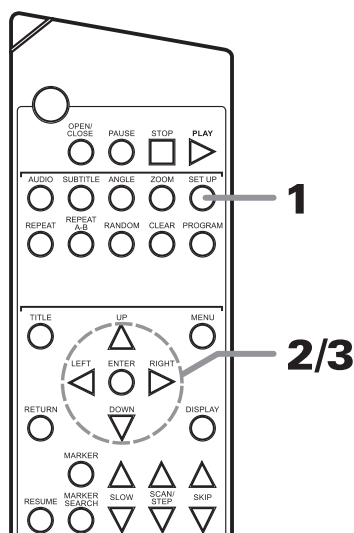

- 1 Press SET UP in the stop mode.**
The SET UP menu is displayed.

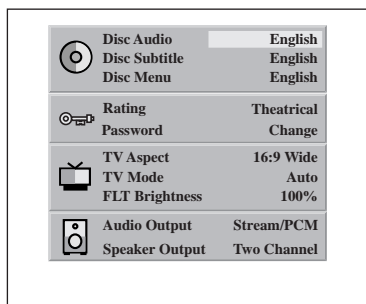

- 2 Press ▲/▼ to select the desired item.**
The screen will show the current setting for the selected item.
- 3 Press ◀/▶ to select the desired setting.**
Some items require additional steps.
(See the relevant page.)

● To exit SET UP menu

Press SET UP again or press RETURN.
(Return to the stop mode.)

SET UP Menu CLEAR

Before setting up the DVD player initially, it is advised to restore the unit's default settings.

To set player to the factory default setting, follow instructions below:

- 1 Open tray.**
- 2 Press the buttons "CLEAR, 2, 5, 8, 0 and CLEAR" in this exact sequence on the remote control.**
Be sure that the intervals between each press of a button does not exceed 1 second.
- 3 The display will show: "CFG INIT".**
Repeat 2 if "CFG INIT" isn't displayed.
- 4 The unit has now been set to factory default settings. The SET UP menu looks like this:**

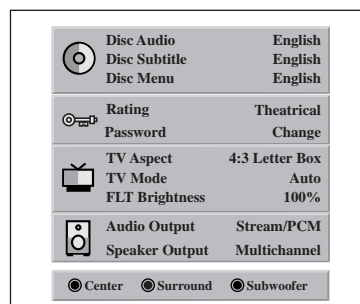

- 5 The factory default password number is "1, 2, 3, 4".**

Selecting Display Mode



● Selecting Display mode

Select the appropriate screen type according to your TV set; conventional size screen (4:3) or wide-screen (16:9).

● Selecting FLD Brightness

Select the FLD brightness in front panel to your desired.

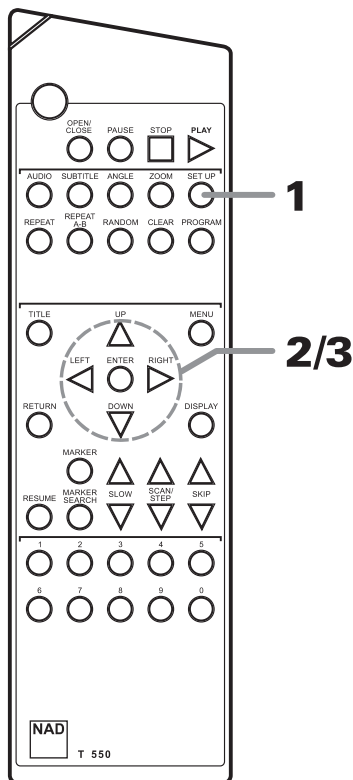

At the SET UP screen

1 Press the SET UP button, during stop mode.

2 Press ▲/▼ to select TV Aspect mode.

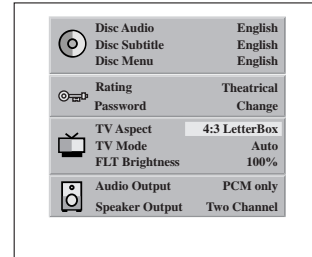

4:3 Letterbox : The video material not formatted in the Pan & Scan style is played back in the letterbox style (black bands appear at top and bottom of screen).

4:3 PanScan : Select when a conventional TV set is connected. The video material formatted in the Pan-Scan style is played back in that style (the left and right edges are cut off).

16:9 Wide : Select when a wide-screen TV set is connected. Played in "FULL" size. (Setting the wide-screen TV to "FULL" mode is also necessary.)

● Note

TV mode selection function is not provided at this time.

3 Press ▲/▼ to select FLD Brightness and press ◀/▶ to select the desired value and press ENTER button.

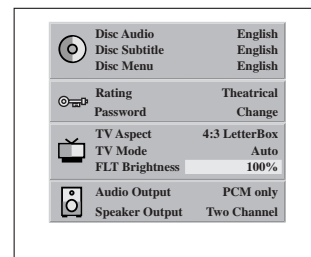

4:3 Letterbox

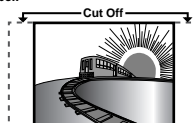

4:3 PanScan



16:9 Wide

● To exit SET UP menu

Press RETURN or SETUP button.

Selecting Audio Output

Selecting Audio Output

If you have an audio system that has only 2 speakers L/R input, you must change the setting of speaker output, from Multichannel to Two channel.

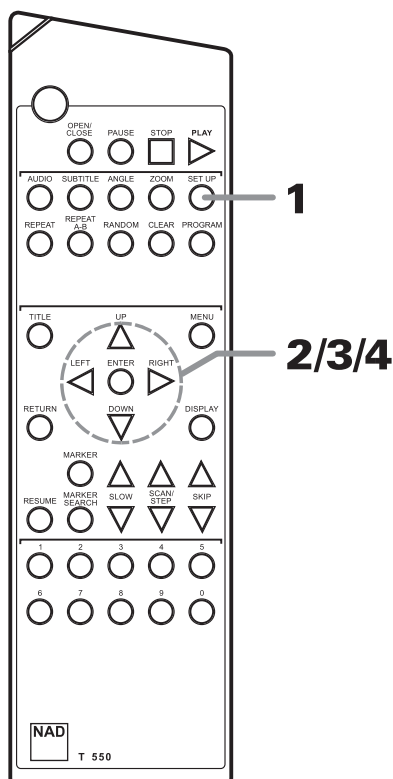

At the SET UP screen

- 1** Press the SET UP button, during stop mode.
- 2** Press ▲/▼ to select Audio Output and press ◀/▶ to select “PCM only” or “Stream/PCM”.

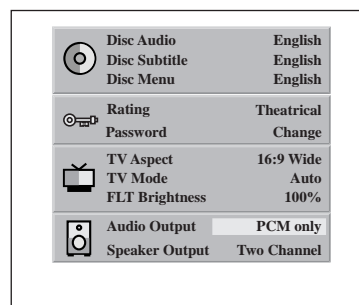

- 3** Press ▲/▼ to select Speaker Output and press ◀/▶ to select “Multichannel” or Two channel.

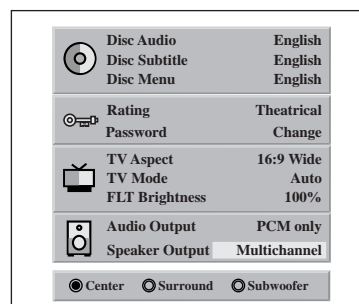

Each DVD disc has a variety of audio output options. Set the player's DIGITAL AUDIO output according to the type of audio system you use.

PLAYBACK DISC	OUTPUT	
	Stream/PCM	PCM
96 kHz LINEAR PCM DVD	PCM	PCM
DTS DVD	DTS bit Stream	DTS bit Stream
DOLBY DIGITAL DVD	DOLBY DIGITAL bit Stream	PCM
MPEG DVD Video CD	MPEG bit Stream	PCM
Audio CD	PCM	PCM
DTS Audio CD	DTS bit Stream	DTS bit Stream

If you have a receiver equipped with a Dolby Digital Decoder, you can listen to Dolby Digital Sound using the “Stream/PCM” setting.

- 4** When you select the “Multichannel”, select Center speaker, Surround speakers, Subwoofer on or off.

Press ◀/▶ to move the cursor to desired speaker and press “ENTER” to toggle the speaker output.

● To exit SET UP menu

Press RETURN or SETUP button.

Note

- When connected through Digital Audio Output and “PCM only” is selected at the Audio Output set-up, Speaker Output should be set to “Two Channel”. Otherwise, center and surround channels' sound will not be heard when playing discs recorded in multichannel such as Dolby Digital 5.1 and DTS.

Selecting rating level and Password-Parental Control (DVD only)



This is to prohibit the playing of specified DVDs which are unsuitable for children.

- Some DVD discs contain a restriction level which enables parents to remove scenes or prevent playback of discs by children. DVD players are equipped with a password designed to prevent children changing the level.

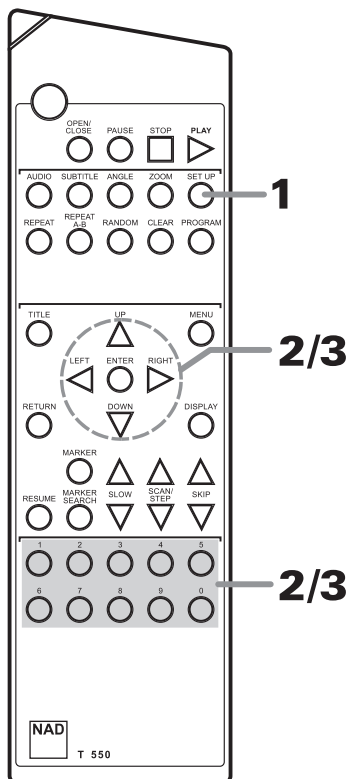

- DVD Video discs has the rating level with 8 steps that be (from 1 to 8).
If the setting is **“Adult”**, the player could play all rating discs.
If the setting is **“Kids”**, the player could only play a disc whose rating is 1.
If the setting is **“Theatrical”**, the player could play the disc which has a rating level from 1 to 5.

You cannot play DVD video discs rated higher than the level you selected unless you cancel the rating level (parental lock function).

For example, when you select kids, discs rated higher than kids are blocked and cannot be played.

If you change the level and enter a password, playback of all DVDs with ratings higher than you selection will be blocked, unless the correct password is entered again.

Selecting rating level (DVD only)

At the SET UP screen

- Press the SET UP button, during stop mode.
- Press ▲/▼ to select Rating, and ◀/▶ to select the Adult, Kids or Theatrical .

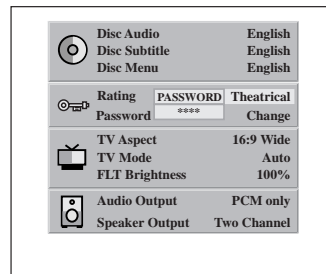

If password is locked, press the password and ENTER button.

- Press ▲/▼ to select “password”, and press ◀/▶ to select “Change” or “Clear”, and press ENTER button.

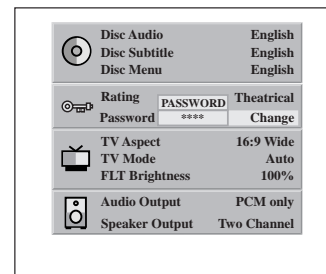

- To change the password, press the old password and ENTER button, then press the new password and ENTER button.
- To clear the password, press the password and ENTER button.
- The rating is locked. Any discs whose rating is higher than the setting cannot be played back unless the correct password is entered.**
- If you have forgotten your password, you can restore the factory default settings with password set to “1, 2, 3, 4”. Note that after having restored the factory default settings, all other settings are to be reset again. Refer also to page 32, “Advanced Operation”, “SETUP MENU Clear”.

Selecting disc language (DVD only)



This is to select the audio soundtrack language, subtitle language and the language used in title menus or DVD menus which will always be used for every disc to be played back.

When you play back a DVD video disc, the DVD player automatically displays the pre-selected subtitle language if it is included on the disc.

If the disc do not include the multi language, then this function cannot operate.

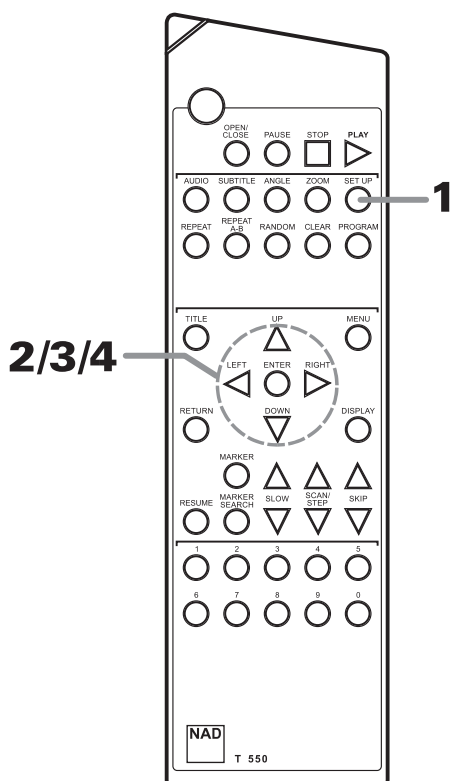

At the SET UP screen

- 1** Press the SET UP button, during the stop.
- 2** Press ▲/▼ to select Disc Audio and press ◀/▶ to select Language.

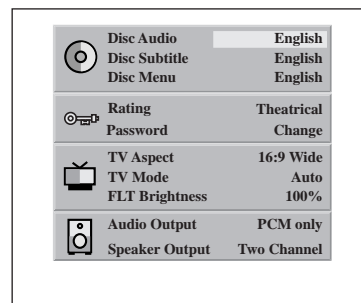

- 3** Press ▲/▼ to select Disc Subtitle and press ◀/▶ to select language.

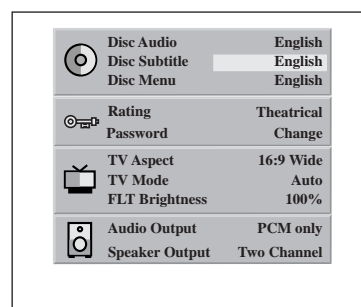

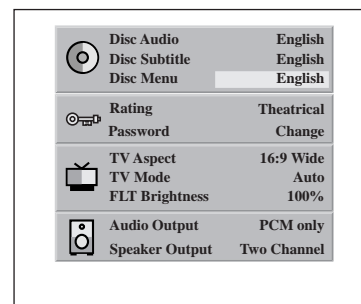

- 4** Press ▲/▼ to select Disc menu language and press ◀/▶ to select Disc menu language.



Disc Requirements/Copyright Information

Playable Discs

This DVD player can play back the following discs.

	Disc mark	Contents	Disc size	Maximum playback time
DVD video discs		Audio + Video (moving picture)	12 cm	Approx. 4 hours (single sided disc)
				Approx. 8 hours (double sided disc)
			8 cm	Approx. 80 minutes (single sided disc)
				Approx. 160 minutes (double sided disc)
Audio CDs		Audio	12 cm	74 minutes
			8 cm	20 minutes
Video CDs		Audio + Video	12 cm	74 minutes
			8 cm	20 minutes

You cannot playback discs other than those listed above. (CD-ROM, CD-Extra, CD-G, photo CD, and CD-i discs can not be played on this DVD player.)

This DVD player uses the NTSC color system (USA/CANADA/JAPAN), PAL (EUR) color system.

Region Management Information

Region Management Information: This DVD/CD Player is designed and manufactured to respond to the Region Management Information that is recorded on a DVD disc. If the Region number described on the DVD disc does not correspond to the Region number of this DVD/CD player, this DVD/CD player cannot play that disc.

The Region number of your player is displayed on the back panel, for instance : 1.
(USA/CANADA)



Notes on Unauthorized Discs

You may not be able play back some DVD video discs on this player if they were purchased from outside your geographic area or made for business purposes.

When you try to play back an unauthorized disc, “**Invalid Regional Disc**” appears on the TV screen.

Notes on Copyright

It is forbidden by law to copy, broadcast, show, broadcast on cable, play in public, and rent copyrighted material without permission.

DVD video discs are copy protected, and any recordings made from these discs will be distorted.

This product incorporates copyright protection technology that is protected by method claims of certain U.S. patents and other intellectual property rights owned by Macrovision Corporation and other rights owners. Use of this copyright protection technology must be authorized by Macrovision Corporation, and is intended for home and other limited viewing uses only, unless otherwise authorized by Macrovision Corporation. Reverse engineering or disassembly is prohibited.

Troubleshooting

Check the following guide for the possible cause of a problem before contacting service.

	Symptom	Possible cause
Operations	Playback is not possible.	<ul style="list-style-type: none"> • The disc is dirty or warped. • The disc is not placed properly on the disc table. • Region No. does not conform with this unit. • The operating section of the player collects dew. • The disc has been loaded upside down.
Picture	 mark appears on screen.	<ul style="list-style-type: none"> • The selected function does not operate for that disc.
	Picture playback stops and the operation button can not be used.	<ul style="list-style-type: none"> • First stop the disc (press the STOP button), then start playback again.
	Settings are cancelled.	<ul style="list-style-type: none"> • When the power is turned off by power failure or unplugging of the power cord, settings will be cancelled. When unplugging the power cord, please be sure to do so after first cancelling the Display window "STANDBY" indicator by pressing the STANDBY/ON button on the main unit or the remote control unit.
	No picture.	<ul style="list-style-type: none"> • Connection is incorrect. • Operation (settings) of TV or AV amplifier is not appropriate.
	The screen is stretched or aspect does not change.	<ul style="list-style-type: none"> • The multi aspect setting is not appropriate.
	Picture disturbance during playback or dark.	<ul style="list-style-type: none"> • This player is compatible with Macro-Vision System copy guard. Some discs include a copy prevention signal, and when this type of disc is played back, stripes etc., may appear on some sections of the picture depending on the TV. (This is not a malfunction.)
	When recorded on a VCR there is disturbance in the playback picture.	<ul style="list-style-type: none"> • This player is compatible with analog copy protect technology copy guard. Some discs include a copy prevention signal and the copy guard system will prevent proper playback.
Remote Control	Remote control operation is not possible.	<ul style="list-style-type: none"> • The remote control is too far from the player, or the angle with the remote sensor is too sharp. • The batteries are exhausted.
	Some TVs sometimes malfunction.	<ul style="list-style-type: none"> • Some TVs that have wireless remote control functions may be operated with this remote control.
Audio	No audio output or audio is distorted.	<ul style="list-style-type: none"> • The disc is dirty. • The connection plugs are not inserted fully into the terminals or are not connected. • The connection plug or terminal is dirty. • Audio cable connection is wrong. • Connection is made to the stereo amplifier's PHONO input terminal. • The pause mode is engaged. • Stereo amplifier operation is wrong. (Check input (CD, AUX etc.) selector) • The DVD playing is recorded in DTS audio.

Specifications

DVD player	Power supply	AC 120 V, 60 Hz (US/CANADA) / AC 230 V, 50 Hz (EUR)
	Power consumption	22 W
	External dimensions (W x H x D)	435 x 95 x 313 mm
	Weight (net)	3.75 kg
	Signal system	NTSC (US/CANADA) / PAL (EUR)
	Laser	Semiconductor laser, wavelength 650 nm
	Frequency range (digital audio)	2 Hz to 22 kHz
	Signal-to-noise rating (digital audio)	More than 105 dB (EIAJ)
	Audio dynamic range (digital audio)	More than 92 dB (EIAJ)
	Harmonic distortion (digital audio)	0.008%
	Wow and flutter	Below measurable level (less than + 0.001% (W.PEAK)) (EIAJ)
	Operating conditions	Temperature: 41°F to 95°F, Operation status: Horizontal
	Outputs	Video output
S-video output		(Y) 1.0 V (p-p), 75 Ω, negative sync., Mini DIN 4-pin x 1 (C) 0.286 V (p-p) 75 Ω
Audio output (digital audio)		0.5 V (p-p), 75 Ω, RCA jack x 1
Audio output (analog audio)		2.0 Vrms (1 kHz, 0 dB), RCA jack x1
Accessories	Remote Control Unit.....	1
	Operator's manual.....	1
	Audio Signal Cable.....	2
	Video Signal Cable.....	1
	Battery.....	2

- Designs and specifications are subject to change without notice.



WWW.NAD.CO.UK

©1999 NAD ELECTRONICS LTD
LONDON ENGLAND

All rights reserved. No part of this publication may be reproduced, stored or transmitted in any form without the written permission of NAD Electronics Limited

T550 Manual (GB) Printed in Korea

Free Manuals Download Website

<http://myh66.com>

<http://usermanuals.us>

<http://www.somanuals.com>

<http://www.4manuals.cc>

<http://www.manual-lib.com>

<http://www.404manual.com>

<http://www.luxmanual.com>

<http://aubethermostatmanual.com>

Golf course search by state

<http://golfingnear.com>

Email search by domain

<http://emailbydomain.com>

Auto manuals search

<http://auto.somanuals.com>

TV manuals search

<http://tv.somanuals.com>