



L 53

DVD Receiver



Owner's Manual
Manuel d'Installation
Bedienungsanleitung
Gebruikershandleiding

ENGLISH
FRANÇAIS
DEUTSCH
NEDERLANDS

IMPORTANT SAFETY INSTRUCTIONS

WARNING

TO REDUCE THE RISK OF FIRE OR ELECTRIC SHOCK, DO NOT EXPOSE THIS PRODUCT TO RAIN OR MOISTURE.

CAUTION

TO PREVENT ELECTRIC SHOCK, MATCH WIDE BLADE OF PLUG TO WIDE SLOT, FULLY INSERT.

CAUTION

This Digital Video Disc Player employs a Laser System. To ensure proper use of this product, please read this owner's manual carefully and retain for future reference. Should the unit require maintenance, contact an authorized service location. (See service procedure). Use of controls, adjustments or the performance of procedures other than those specified may result in exposure to laser radiation. To prevent direct exposure to laser beam, do not try to open the enclosure. Visible laser radiation when the enclosure is opened.

DO NOT STARE INTO BEAM.

FCC NOTICE

This equipment has been tested and found to comply with the limits for a Class B digital device, pursuant to part 15 of the FCC Rules. These limits are designed to provide reasonable protection against harmful interference in a residential installation.

This equipment generates, uses and can radiate radio frequency energy and if not installed and used in accordance with the instructions, may cause harmful interference to radio communications.

However, there is no guarantee that interference will not occur in a particular installation. If this equipment does cause harmful interference to radio or television reception, which can be determined by turning the equipment off and on, the user is encouraged to try to correct the interference by one or more of the following measures:

- Reorient or relocate the receiving antenna.
- Increase the separation between the equipment and receiver.
- Connect the equipment into an outlet on a circuit different from that to which the receiver is connected.
- Consult the dealer or an experienced radio/TV technician for help.

EXAMPLE OF ANTENNA GROUNDING AS PER NATIONAL ELECTRICAL CODE INSTRUCTIONS CONTAINED IN ARTICLE 810 - RADIO AND TELEVISION EQUIPMENT.

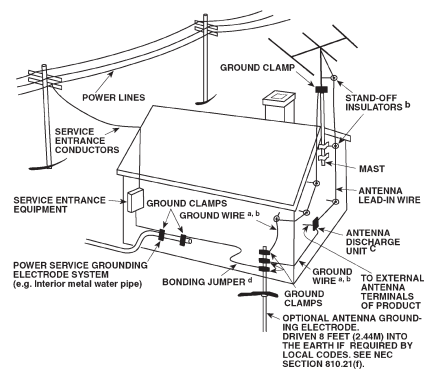

NOTE TO CATV SYSTEM INSTALLER: This reminder is provided to call the CATV system installer's attention to Article 820-40 of the National Electrical Code that provides guidelines for proper grounding and, in particular, specifies that the ground cable ground shall be connected to the grounding system of the building, as close to the point of cable entry as practical.

FCC WARNING

Changes or modifications not expressly approved by the party responsible for compliance could void the user's authority to operate the equipment.

INDUSTRY CANADA REQUIREMENT

This Class B digital apparatus meets all requirements of the Canadian Interference-Causing Equipment Regulations.

IMPORTANT SAFETY INSTRUCTIONS

WARNING

TO PREVENT FIRE OR SHOCK HAZARD, DO NOT EXPOSE THIS APPLIANCE TO RAIN OR MOISTURE.



THE LIGHTNING FLASH WITH ARROWHEAD SYMBOL, WITHIN AN EQUILATERAL TRIANGLE, IS INTENDED TO ALERT THE USER TO THE PRESENCE OF UNINSULATED "DANGEROUS VOLTAGE" WITHIN THE PRODUCT'S ENCLOSURE THAT MAY BE OF SUFFICIENT MAGNITUDE TO CONSTITUTE A RISK OF ELECTRIC SHOCK TO PERSONS.



THE EXCLAMATION POINT WITHIN AN EQUILATERAL TRIANGLE IS INTENDED TO ALERT THE USER TO THE PRESENCE OF IMPORTANT OPERATING AND MAINTENANCE (SERVICING) INSTRUCTIONS IN THE LITERATURE ACCOMPANYING THE APPLIANCE

The equipment draws its nominal non-operational power from the AC outlet with its POWER switch in the STANDBY position.

CAUTION

Changes or modifications to this equipment not expressly approved by NAD Electronics for compliance could void the user's authority to operate this equipment.

CAUTION REGARDING PLACEMENT

To maintain proper ventilation, be sure to leave a space around the unit (from the largest outer dimensions including projections) equal to, or greater than, shown below.

Left and Right Panels: 10 cm
Rear Panel: 10 cm
Top Panel: 50 cm

IMPORTANT INFORMATION FOR UK CUSTOMERS

DO NOT cut off the mains plug from this equipment. If the plug fitted is not suitable for the power points in your home or the cable is too short to reach a power point, then obtain an appropriate safety approved extension lead or consult your dealer. If, nonetheless, the mains plug is cut off, **REMOVE THE FUSE** and dispose of the **PLUG** immediately, to avoid possible shock hazard by inadvertent connection to the mains supply. If this product is not provided with a mains plug, or one has to be fitted, then follow the instructions given below:

IMPORTANT

DO NOT make any connection to the larger terminal which is marked with the letter 'E' or by the safety earth symbol or coloured GREEN or GREEN AND YELLOW.

The wires in the mains lead on this product are coloured in accordance with the following code:

BLUE - NEUTRAL
BROWN - LIVE

As these colours may not correspond with the coloured markings identifying the terminals in your plug, proceed as follows:

The BLUE wire must be connected to the terminal marked with the letter 'N' or coloured BLACK.
The BROWN wire must be connected to the terminal marked with the letter 'L' or coloured RED

When replacing the fuse, only a correctly rated and approved type should be used, and be sure to re-fit the fuse cover.

IF IN DOUBT CONSULT A COMPETENT ELECTRICIAN

NOTES ON ENVIRONMENTAL PROTECTION

At the end of its useful life, this product must not be disposed of with regular household waste but must be returned to a collection point for the recycling of electrical and electronic equipment. The symbol on the product, user's manual and packaging, point this out.

The materials can be reused in accordance with their markings. Through re-use, recycling of raw materials, or other forms of recycling of old products, you are making an important contribution to the protection of our environment.

Your local administrative office can advise you of the responsible waste disposal point.



Introduction

IMPORTANT SAFETY INSTRUCTIONS

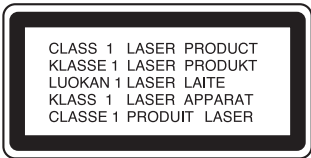

CAUTION

THIS DVD PLAYER EMPLOYS A LASER SYSTEM. TO ENSURE PROPER USE OF THIS PRODUCT, PLEASE READ THIS OWNER'S MANUAL CAREFULLY AND RETAIN FOR FUTURE REFERENCE. SHOULD THE UNIT REQUIRE MAINTENANCE, CONTACT AN AUTHORISED SERVICE LOCATION.

USE OF CONTROLS, ADJUSTMENTS TO MODIFY PERFORMANCE OF PROCEDURES OTHER THAN THOSE SPECIFIED MAY RESULT IN HAZARDOUS RADIATION EXPOSURE.

TO PREVENT DIRECT EXPOSURE TO LASER BEAM, DO NOT TRY TO OPEN THE ENCLOSURE. VISIBLE LASER RADIATION EXISTS WHEN THE ENCLOSURE IS OPENED. DO NOT STARE INTO BEAM.

THE APPARATUS SHOULD NOT BE EXPOSED TO DRIPPING OR SPLASHING LIQUIDS. OBJECTS FILLED WITH LIQUIDS, SUCH AS VASES, SHOULD NOT BE PLACED ON THE APPARATUS.

Do not place this unit on an unstable cart, stand or tripod, bracket or table. The unit may fall, causing serious injury to a child or adult and serious damage to the unit. Use only with a cart, stand, tripod, bracket or table recommended by the manufacturer or sold with the unit. Any mounting of the device on a wall or ceiling should follow the manufacturer's instructions and should use a mounting accessory recommended by the manufacturer.

An appliance and cart combination should be moved with care. Quick stops, excessive force and uneven surfaces may cause the appliance and cart combination to overturn.

WARNING: CHANGES OR MODIFICATIONS NOT EXPRESSLY APPROVED BY THE PARTY RESPONSIBLE FOR COMPLIANCE COULD VOID THE USER'S AUTHORITY TO OPERATE THE EQUIPMENT.

NOTE

The L53 is not an auto voltage DVD-receiver. Connect only to the prescribed AC outlet, i.e., 120V 60Hz or 230V 50Hz.

The model and serial number of your new DVD-receiver are located on the back of the cabinet. For your future convenience, we suggest that you record these numbers here:

RECORD YOUR MODEL NUMBER (NOW, WHILE YOU CAN SEE IT)

The model and serial number of your new DVD-receiver are located on the back of the DVD-receiver cabinet. For your future convenience, we suggest that you record these numbers here:

MODEL NO.: _____
SERIAL NO.: _____

INTRODUCTION

Important Safety Instructions	2-4
Warning	2
Caution	2
Important Safety Instructions for UK Customers	3
Table of contents	5
Getting the most from the NAD L53	6-7
Unpacking and setup	6
About the L53	6
SRS 3D audio from surround encoded material	6
Ease of Use	7
About the HTR L53 System Remote Control	7
Quickstart	7

IDENTIFICATION OF CONTROLS

Front Panel/Display Window	8-9
Rear Panel	10-11

SETUP

Setting up the L53	12-13
Getting Started	12
Dealing With Hum and Noise	12
Factory Default Settings	12
About the On-Screen Displays (OSD) and Front-Panel Readout ..	13
Displaying the L53 DVD OSD	13
Navigating the DVD OSD and Making Changes	13
Input Setup	13
SRS SURROUND MODE	14
LEFT & RIGHT (Balance Adjust) Setup	14
Adjusting the Tone Controls	14
Adjusting SUBWOOFER LEVEL TRIM "On the Fly"	14

OPERATION

Using the L53	15
Adjusting the Volume	15
Muting the Sound	15
Selecting Sources	15
Using the L53's DVD/VCD/CD player	16-18
About DVD/VCD/CD	16
Region management information	16
Transport Control Buttons	16
Title and Menu Buttons	17
OSD Navigation	17

Video Setup	17
OSD Language	17
DISC Video OSD	18
DISC Audio OSD	18
DISC Language	18
Parental Control	19

Playing CD, VCD, SVCD, DVD19**Playing MP3 WMA and JPEG CD-R/CD-RW**20**Using the L53's AM/FM radio**21-22

About Antennas	21
Selecting the Radio	21
Tuning Stations	21
Setting Radio Presets	21
Selecting Radio Presets	21
Deleting a Stored Preset	21
Choosing the FM Mute / Mode	22
About RDS	22
Viewing RDS Text	22

Using the HTR L53 remote control23-28

Specifications	23
Controlling the L53	23
Learning Codes From Other Remotes	24
Punch-Through	24
Copy a Command From Another Button	25
Macro Commands	25
Recording Macros	25
Executing Macros	26
Button-Illumination Timeout	26
Factory Reset	26
Delete Mode	27

Loading Code-Libraries27-28

Summary of HTR L53 Modes	28
--------------------------------	----

REFERENCE

Notes	29
Troubleshooting	30
Specifications	31

THANK YOU FOR CHOOSING NAD

The L53 AV Stereo DVD Receiver is a technologically advanced and highly capable product-yet we have invested great effort in making it simple and easy to use. The L53 delivers a range of genuinely useful options for Stereo and stereo listening alike, using powerful digital signal processing and superbly accurate digital-audio circuitry. However, we have also been careful to ensure that the receiver is as musically transparent and spatially accurate as possible, incorporating much of what we've learned from a quarter-century's experience designing audio and home-theatre components. As with all our products, NAD's "Music First" design philosophy guided the L53's design, such that it can confidently promise you both state-of-the-art surround home-theatre and audiophile-quality music listening for years to come.

We encourage you to take a few minutes now to read right through this manual. Investing a little time here at the outset might save you a good deal of time later, and is by far the best way to ensure that you make the most of your investment in the NAD L53, and get the most from this powerful and flexible home-theatre component.

One more thing: We urge you to register your L53 ownership on the NAD Worldwide Web site:

<http://NADelectronics.com/w/Registration.html>

For warranty information contact your local distributor.

UNPACKING AND SETUP

WHAT'S IN THE BOX

Packed with your L53 receiver you will find:

- An AM loop antenna
- An FM ribbon-wire antenna with balun
- The HTR L53 remote control with 4 (four) AAA batteries
- This owner's manual

SAVE THE PACKAGING

Please save the box and all of the packaging in which your L53 arrived. Should you move or otherwise need to transport your receiver, this is by far the safest container in which to do so. We've seen too many otherwise perfect components damaged in transit for lack of a proper shipping carton, so please: Save that box!

CHOOSING A LOCATION

Choose a location that is well ventilated (with at least several inches to both sides and behind), and that will provide a clear line of sight, within 25 feet/8 meters, between the receiver's front panel and your primary listening/viewing position-this will ensure reliable infrared remote control communications. The L53 generates a modest amount of heat, but nothing that should trouble adjacent components. It is perfectly possible to stack the L53 atop other components, but the reverse usually should be avoided. Nonetheless, it is generally preferable that the L53 stands alone. It is especially important that sufficient ventilation be provided; if you are contemplating locating the L53 within a cabinet or other furniture, consult your NAD audio/video specialist for advice on providing adequate airflow.

ABOUT THE L53

Though the L53 is among the most technically sophisticated integrated AV Stereo DVD receivers, we worked hard to make it one of the most musically transparent home-theatre components available as well; this is what we mean by NAD's "Music First" design philosophy. Here are just a few examples:

- The L53 incorporates a high quality DVD player with exceptional playability. The player has support for DVD video, VCD, SVCD with playback control (PBC), CD audio such as CD-RW as well as MP3.
- Gold-surfaced connectors are employed throughout to ensure maximum signal integrity.



SRS 3D AUDIO FROM SURROUND ENCODED MATERIAL

SRS (Sound Retrieval System), the leading 3D Sound technology in the world, is the result of many years of research based on the psychoacoustics of sound and the dynamics of the human hearing system. SRS retrieves the spatial information that is lost during the recording and playback process and restores the original three dimensional sound-field. As a result, the reproduced sound is much closer to what the artist originally intended and to that of a live performance. SRS 3D also eliminates the "sweet spot", filling the listening environment with full rich sound. SRS 3D also delivers this same powerful 3D audio experience over headphones.

SRS SURROUND MODE NOTES

- *The SRS surround mode was intended for the playback of surround encoded material, such as Dolby ProLogic movies, with only two loudspeakers in a standard stereo configuration. When used in conjunction with this type of recorded material, the result is a large spacious sound with enhanced directional cues.*
- *Using the SRS mode for the playback of normal stereo music recordings is not recommended, as the results can be unpredictable and may sound distorted.*
- *This 3D Surround effect may not be available from some sources, such as those recorded with a mono audio sound-track.*
- *Turn off the TV surround sound when using this 3D surround effect.*
- *For best 3D Surround effect it is recommended that the two speakers be positioned approximately 2m to 2.5m apart, and the listening position should be 2m to 2.5m away from the speakers.*

SRS (Sound Retrieval System®) 3D Sound and the SRS symbol, are registered trademarks of SRS Labs, Inc. in the U.S. and selected foreign countries. SRS 3D Sound™ is a trademark of SRS Labs, Inc

EASE OF USE

Despite the effort NAD has invested in the L53 receiver's sonic performance, we expended no less in making it powerfully easy to use. Its design is uniquely simple for so sophisticated a component, and the HTR L53 universal remote control is equally understandable, as are the L53's own front-panel and on-screen displays (OSD).

ABOUT THE HTR L53 SYSTEM REMOTE CONTROL

Packed with your L53 is the NAD HTR L53 remote control, a full-system remote especially designed to be easy to use and easy to understand. Be sure to read the section "Using the HTR L53 Remote Control," to familiarize yourself with the remote's layout and operations before proceeding to setup your receiver.

Chances are, you will want to use your HTR L53 as your primary way to command your entire AV system. The HTR L53 can be employed to operate additional NAD or other-brand components such as a second DVD/CD player, television, satellite/HDTV tuner, VCR, or virtually anything else that operates via standard infrared remote control.

QUICKSTART

In case you simply cannot wait to experience the performance of your new NAD L53 DVD/Receiver, we provide the following "Quickstart" instructions to get you underway. The steps below connect your L53 to a TV/monitor; be sure to read "Input Setup".

PLAY A CD OR DVD MOVIE

- Connect the L53's composite video or S-Video "MONITOR OUT" jack to your TV/monitor's corresponding input.
- Connect your left and right front speakers to the L53's "FRONT L and R" outputs, being sure to connect red to red ("+") and black to black ("-"), with care to avoid stray wires or strands crossing between terminals. If your system includes a powered subwoofer, connect the L53's "SUBWOOFER PRE-OUT" jack to its line input.
- Plug the AC mains plug into the AC; the LED on the front panel will be lit blue indicating the L53 is in standby mode ready to accept commands from either the front panel power switch or the HTR L53 remote.
- To start playback of the DVD player; press the HTR L53 remote's "DVD" Device Selector button, and then its transport button "OPEN/CLOSE" to select the DVD, insert the media and press the transport  play button to start playing. You should hear stereo sound, and see an image on the TV/monitor. (If one or the other fails to appear, you may need to use either the L53's DVD on-screen menu systems to check assignment of audio and video inputs; see "Input Setup".

Enjoy the movie or music, but be sure to set aside time to read this manual thoroughly, and to set up, calibrate, and configure your L53 carefully and completely.

Identification of controls

FRONT PANEL

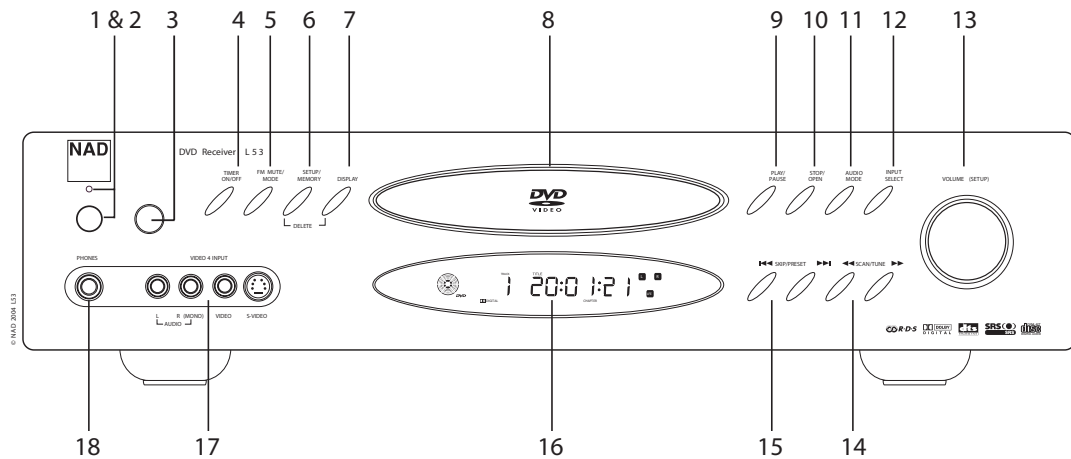

- 1 "Power":** When the L53 is first plugged into the AC power, the L53's clock will light in the main VFL display showing the time of day. Press in to switch the receiver from standby, changing the standby indicator from bright blue to dark, and illuminating the VFL display. Pressing the power switch again turns the unit back to standby. It is usual (and perfectly acceptable) to leave the L53 in standby mode in between normal viewing and listening sessions. Pressing the "OPEN CLOSE" button on the front-panel, or the HTR L53 remote's "ON" button, will switch the receiver on, making it operational. Press the remote's "OFF" button to return to standby. Note that when you do choose to switch off to standby using the front panel Power button, the L53's memory back-up system will store channel level, tuner preset, and other settings for several weeks while the unit is switched off, or even unplugged from AC power altogether.
- 2 INDICATOR:** When the L53 is in standby the LED will light bright blue, the VFL in the L53 will display the L53's internal clock. This indicator will extinguish itself when the power cable is unplugged from the AC supply.
- 3 REMOTE SENSOR:** Point the remote control at the remote sensor and press the buttons. Do not expose the remote sensor of the receiver to a strong light source such as direct sunlight or illumination. If you do so, you may not be able to operate the receiver with the remote control.
Distance: About 23 ft (7 m) from the front of the remote sensor
Angle: About 30° in each direction of the front of the remote sensor
- 4 TIMER ON/OFF:** Press and hold to set the internal clock, ON/OFF timer, and display of the clock's time. A red "clock face" will appear in the fluorescent display when the timer is activated. To set the internal clock, press and hold the "TIMER ON/OFF" button for more than 4 seconds. Use the "MEMORY" button to toggle between the hours and minutes. Use the "SKIP/PRESET" buttons to change the hours and minutes. There are two timers, one for when the L53 powers on, the other for when the unit powers off; these too are programmed in the same way.
- 5 FM MUTE/MODE:** In the normal Mute position, only the stations with a strong signal can be listened to, and the noise between stations is muted. Pressing the "FM MUTE/MODE" button allows distant (and potentially noisy) stations to be received. (See "Listening to Radio".
- 6 SETUP/MEMORY:** Use to store tuned stations to the L53's 60 preset-memory locations. (See "Listening to Radio")
When DVD is selected, use this button for setting the DVD-player's options as shown on the On Screen Display (OSD). (See "Using the L53's DVD/CD/CD player")
- 7 DISPLAY:** Use this multifunction button to toggle between RDS PS, RDS RT and station frequency in FM Tuner mode (see "Listening to Radio"). When in either CABLESAT or VCR mode, this "DISPLAY" button will toggle between Optical or Coaxial and analog inputs. You can assign either Optical or Analog input to VCR, and either Coaxial or Analog input to CABLE/SAT. When in DVD mode, pressing "DISPLAY" will toggle between the two DVD navigation menus as well.

- 8 DISC TRAY** With the DISC TRAY open insert DVD, VCD, and CD media face down onto the tray.
- 9 PLAY/PAUSE:** Press this button to toggle between Play and Pause of a DVD/VCD/CD.
- 10 STOP/OPEN:** Press this button to open and close the DVD/CD drawer and simultaneously select the internal DVD/VCD/CD player. When in standby, this button will also power On the L53. Press this button to stop playing of a DVD/VCD/CD.
- 11 AUDIO MODE:** Press to toggle between SRS ON, SRS OFF, Treble level, Bass level, LEFT level balance, and RIGHT level balance. Use the "VOLUME (SETUP)" knob or HTR L53's volume buttons to adjust the settings.
- 12 INPUT SELECT:** Use to select an audio/video input along with its assigned analog or digital inputs (see "Input Setup"). Toggle to select between:
Internal DVD → CABLE/SAT → VCR → VIDEO 4 → Internal AM tuner → Internal FM tuner → then back to Internal DVD
- 13 VOLUME(SETUP):** Turn clockwise to increase the master-volume setting; counter clockwise to lower it. The VFL and on-screen displays show the setting, displayed as increments between -61 through to +17. The VOLUME knob is also used to increment/decrement the Bass, Treble and LEFT/RIGHT balance levels.
- 14 SCAN/TUNE** Pressing momentarily the ►► or ◀◀ button will manually scan the AM or FM band. Press and hold the ►► or ◀◀ for more than 2 seconds to search up or down; the L53's tuner will stop at the next sufficiently strong signal it encounters. Note that this function, too, "wraps," and will continue searching up or down from one end of the AM or FM band to the other.
- 15 SKIP/PRESET** Press to step up or down between radio presets or searching channels; 30 FM and 30 AM station presets are available. Note that this function "wraps": Pressing ►► or ◀◀ will step from Preset 30 to Preset 1, or vice versa. "Unused" presets are skipped over.
- 16 VFL DISPLAY:** The Vacuum Fluorescent Display (VFL Display) provides visual information on all of the L53's important modes, settings, and functions.
- 17 VIDEO 4 INPUT:** Use these convenience jacks for occasional sources, such as a camcorder, portable MP3 or tape player, or a videogame console, or any other analog audio, or composite or S-Video video source. Select the Video 4 input using the HTR L53 remote, or the front-panel "INPUT SELECT" button.
- 18 PHONES:** Accepts stereo headphone using a standard 1/4-inch stereo phone plug (use a suitable adaptor for headphones equipped with a smaller plug). Plugging in headphones automatically mutes output from the speakers (but not from the AUDIO OUT jacks of the VCR).

Identification of controls

REAR PANEL

ATTENTION!

Please make all connections to your L53 receiver with the unit unplugged. (It is also advisable to power-down or unplug all associated components while making or breaking any signal or AC power connections.)

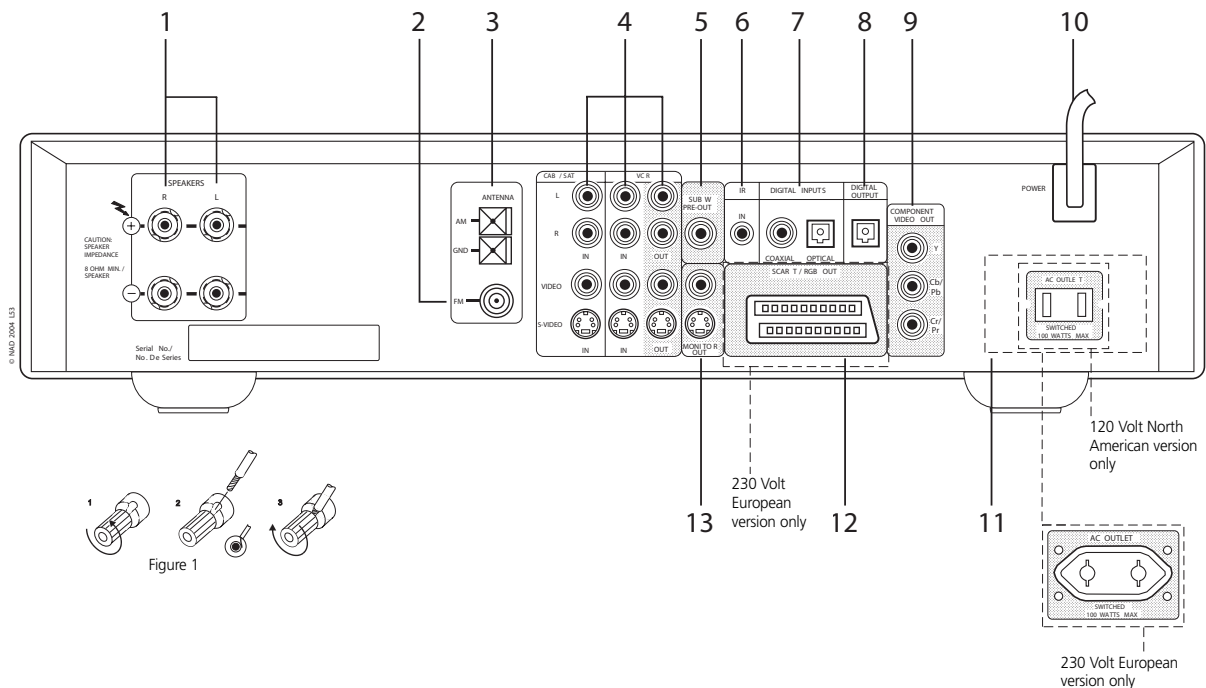

1 SPEAKERS: Connect the left and right to the corresponding loudspeakers. Each output's "+" (red) terminal and "-" (black) terminal must be connected to the corresponding "+" and "-" terminals of the loudspeaker. Use extra care to ensure that no stray wires or strands cross between posts or terminals at either end. (See Figure 1 above)

NOTE

- Use stranded wire of at least 16-gauge (AWG); specialized speaker cable may be valuable (consult your NAD audio specialist). Connections to the L53 can be made with banana-type plugs, or using bare wire, or pins, by loosening the terminal's plastic nut, making a clean, neat connection, and re-tightening carefully (use the transverse hole through the post for bare-wire or pin connections). To minimize the danger of short-circuits, ensure that only 1/2-inch of exposed wire or pin is employed in connecting.
- This unit is designed to produce optimum sound quality when connected to speakers with impedances within the receiver's operating range. Please check that front speakers are rated to be 8 Ohms min. per speaker.

2 FM ANTENNA: The supplied wire "dipole" FM antenna will connect to the FM connector using the supplied "balun" adaptor. It will usually work best when mounted on a vertical surface such as a wall, with arms fully outstretched forming a horizontal "T" perpendicular to the origin point of the signal. Experiment with placement and orientation of to yield the clearest sound and lowest background noise. In areas of difficult FM reception an external FM antenna can yield dramatic gains in quality; consult your NAD audio specialist or a professional antenna installer.

3 AM ANTENNA: The AM loop antenna supplied with the L53 (or a suitable replacement) is required for AM reception. Open the clip terminal lever; insert the wire and close, ensuring that the lever locks

the wire in place. Testing different positions for the antenna may improve reception; vertical orientation will usually produce the best results. Antenna proximity to large metal objects (appliances; radiators) may impair reception, as will attempts to lengthen the wire to the loop.

NOTE

An external AM antenna can improve long-distance reception substantially; consult your NAD audio specialist or a professional antenna installer. Do not connect anything other than a loop antenna to the AM ANTENNA terminal.

4 CABLE/SAT & VCR: These comprise the L53's principal inputs. Connect S-Video, composite video, and analog stereo audio from source components such as HDTV/satellite tuners. VCR may be used with recording components such as videocassette or DVD-recorders; connect the L53 S-Video/composite video OUT jacks to these components' record-input. (Note that VCR may freely be used for play-only components, in which case their IN jacks would remain unconnected.)

5 PRE-OUT SUBWOOFER: Connect this output to a powered ("active") subwoofer (or to a power amplifier channel driving a passive system).

6 IR IN: This input is connected to the output of an IR (infrared) repeater (Xantech or similar), or the IR output of another component to allow control of the L53 from a remote location. Ask your dealer or custom installer for further details.

7 OPTICAL & COAXIAL IN: Connect to the coaxial/optical S/PDIF-format digital output of sources such as VCRs, HDTV or satellite tuners, or other components; connect IN OPTICAL/COAXIAL to an S/PDIF-format digital output. We recommend your source material be set to PCM 2-channel format for these digital inputs.

NOTE

- During power-on from standby, there may be a momentary mute of audio if CD/DVD-media is present in the L53's DVD tray, and either Coaxial or Optical inputs are in use. This feature is normal operation that allows the L53 to load the media's tables of contents and title menus into memory. To avoid this momentary mute of audio, remove the media from the L53's DVD tray before switching to standby.

8 OPTICAL OUT: Connect the OUT OPTICAL port to the corresponding S/PDIF digital input of a recording component such as a CD recorder, DAT deck, or computer soundcard.

9 COMPONENT VIDEO OUT: Connect the L53's "COMPONENT VIDEO OUT" to the component-video input of a compatible video monitor/TV. Be sure to observe consistency in connecting the Y/Cr/Cb jacks (some source and TV components label these Y/Pb/Pr) to the corresponding sources/inputs; do not rely purely on the colour coding of the jacks, which may not always be consistent among brands. The routing of the component-video output is fixed: "COMPONENT VIDEO OUT" jack will only display the internal DVD video signals.

NOTE

- *The L53's component-video output is a fully wide-band output, compatible with all HDTV formats. The L53 will display its on- screen menus on its component-video output.*

10 AC POWER CORD: Connect AC power cord to the Voltage according to the model, 120 V for US and 240 V for Euro models.

11 SWITCHED AC OUTLET: This convenience jack can supply switched power to another component or accessory. It is powered on and off by the front panel POWER button (or the HTR L53's ON and OFF buttons).

NOTE

- *The total draw of all devices connected to this jack must not exceed 100 watts.*

12 SCART/RGB VIDEO OUT (PAL only): Connect the L53's "SCART/RGB VIDEO OUT" to the SCART/RGB video input of a compatible video monitor/TV. Be sure to observe the correct orientation of the SCART/RGB plug. The routing of the SCART/RGB input is fixed: the SCART/RGB VIDEO OUT" plug will only display the internal DVD video signals.

13 MONITOR OUT: Connect to video input of the monitor/television, using quality RCA and/or S-Video cables designed for video signals. In general, the S-Video connection is superior and should be used if your TV/monitor provides the corresponding input.

GETTING STARTED

Before you make the first connection to your L53, you should have the arrangement of your listening room/home theatre components and furniture mapped out, at least initially. Unfortunately, a discussion of the vital questions of loudspeaker placement and listening/viewing positions is beyond our scope here. Suffice it to say that these two questions will influence your system's ultimate performance every bit as powerfully as your selection of electronics and speakers. Your NAD audio specialist dealer will be happy to advise you, and to recommend reference materials.

NOTE

- *It is not absolutely necessary but one may find it easier to use the HTR L53 remote handset in conjunction with the front panel buttons to configure your L53. See "Using the HTR L53 Remote".*

DEALING WITH HUM AND NOISE

Hum and noise sometimes prove a challenge in complex, multichannel audio systems. Note these considerations to help prevent hum and noise problems:

- Power your system's entire audio components from AC outlets originating from the same circuit of your house wiring. As far as possible, power all audio components from the same outlet, or adjacent outlets on the same circuit. It may be useful to power video displays (and computers!) from outlets on another circuit, especially if that circuit is supplied from the other "leg" of the house wiring.
- Do not bundle analog audio cables with AC power cables, or with coaxial digital-audio cables. It is best if they cross at right angles if they must be in close proximity.
- Employ high-quality, well-shielded audio cable throughout, and ensure that all connections are secure.
- A pencil-eraser can be used to burnish copper- and gold-plated contacts to ensure good, low-resistance contact; specialized contact-cleaners can also be useful. Avoid unnecessary unplugging and re-plugging, since the gold (or copper) contact plating of typical cable connectors, even very high-quality ones, is very thin and easily worn.

Track down hum/noise problems one component at a time, working backwards from the receiver. That is: Connect the speakers to the receiver only, and check for hum. Then connect one component only (a VCR, for example) alone, with no other components connected and check for hum. Connect additional components, one at a time, to the receiver and check for hum. At each stage, if hum/noise appears, examine the audio cabling and AC-power routing of the new component. In some cases, moving the new component's AC cord to a different outlet, or installing a ground-lift (3-to-2-prong adaptor) on its power cord, will eliminate the hum.

FACTORY DEFAULT SETTINGS

Sometimes power spikes and drop-outs may from time to time, cause some inadvertent functionality. The procedure below will set the L53 to factory default settings:

- 1) Place the L53 into FM mode.
- 2) Press quickly the three front panel buttons; "PLAY/PAUSE" then "STOP/OPEN" then "DISPLAY", holding the "DISPLAY" button for more than 7 seconds. The L53 will switch itself off then back on to DVD mode.

NOTE

- *Please note that setting the L53 to factory default settings will delete all AM and FM presets.*

ABOUT THE ON-SCREEN DISPLAYS (OSD) AND FRONT-PANEL READOUT

The L53 receiver employs a self-explanatory on-screen display "menu" for the internal DVD player. This "menu" will appear on the connected video monitor/TV and is required during the setup process (useful in day-to-day operation); so be sure to connect the monitor/TV before proceeding with setup.

DISPLAYING THE L53 DVD OSD

While in DVD mode, press the L53's "SETUP/MEMORY" button momentarily for the DVD's OSD. With the use of the HTR L53's navigation buttons, you may select various menus. If the OSD does not appear, check your "MONITOR OUT" connections either "COMPOSITE" or "S-VIDEO" outputs.

NOTE

- For convenience, the receiver's OSD will appear on the L53's component-video (NTSC/PAL), SCART/RGB (PAL) output, and on the VCR record-outputs.

NAVIGATING THE DVD OSD AND MAKING CHANGES

Press the "SETUP/MEMORY" button on the front panel of the L53 as described above in "Displaying the L53 DVD OSD". Use the ▲/▼ buttons of the HTR L53 to move up or down among the Setup menu's list of items; use "ENTER" to select a menu item, and use the ENTER button to change the parameter-value of any item.

Select either "Save and Exit" or "Do Not Save and Exit" to store the selected values. Selecting "EXIT" from the main setup menu exits the OSD altogether, retaining parameter-value changes, if any, made previously.

NOTE

- When playing any DVD, VCD, or CD the L53's DVD OSD can be activated at any time. This convenient feature allows one to change audio and video settings "on-the-fly" without the need to stop or pause the media.

INPUT SETUP

The L53 is equipped with 3 inputs; audio-video inputs labelled "CAB/SAT", "VCR", and "VIDEO 4" (VIDEO 4 on the front panel) These will become active whenever that input is selected.

NOTE

- Incoming digital and audio signals present at either digital coaxial, optical or analogue are assigned to their fixed inputs CAB/Sat and VCR. Assign Coaxial or Analogue to the CABLE/SAT input and Optical or Analogue to the VCR input by toggling the L53's "DISPLAY" button through the choices shown in the L53's fluorescent display.

INPUT SELECT

- From the front panel, press the "INPUT SELECT" button to toggle from DVD, CABLE/SAT, VCR, VCR, VIDEO-4, AM Tuner, FM Tuner, and then back to DVD.

NOTE

- It is not necessary to have an analog audio input connected for every video input you employ. In fact, in some cases-for example for a CABLE/SAT-it may be preferable to make only a coaxial digital audio link to the L53 for audio playback. This avoids possible confusion, and ensures that the L53's high-performance digital audio circuitry will always be employed.
- If you set the input to "ANALOG", no incoming digital signal will be selected by that input. (Set an input's digital input to "ANALOG" only if you wish to ensure that that input will not play an incoming digital bit stream, even if one is present.)
- The combination of analog-audio input and digital input assigned above will always be recalled whenever that input is selected via the front-panel INPUT SELECT, or the HTR L53 remote's input-select buttons.
- That signals from digital inputs are not available on the analog VCR OUT jacks.

SRS SURROUND MODE

From the front panel or HTR L53 remote, select "AUDIO MODE". Toggle through to SRS ON/OFF. Toggle the SRS to on or off via the L53's volume knob or the HTR L53 volume ▲/▼ arrows

LEFT & RIGHT (BALANCE ADJUST) SETUP

Adjusting the relative balance of your system's loudspeakers ensures that surround-sound recordings, whether music or film, will present the balance of effects, music, and dialog that the artists intended. Additionally, if your system incorporates a subwoofer it establishes a correct relationship between the volume of the subwoofer and the other speakers, and thus of low-frequencies (bass) to other sonic elements. From the front L53's front panel or HTR L53 remote select "AUDIO MODE". Toggle from "LEFT" and "RIGHT" level adjustment, fine tune the level of each channel with the volume knob or remote's volume buttons.

ADJUSTING THE TONE CONTROLS

The L53 bass and treble controls are adjusted using the front panel's "AUDIO MODE" button in conjunction with the "VOLUME (SETUP)" knob; see "Front Panel".

NOTE

- Bass/treble settings affect only the front left/right channels, not the subwoofer.
- The AUDIO MODE is "global"; that is, it remains in force with all inputs and in SRS mode.

ADJUSTING SUBWOOFER LEVEL TRIM "ON THE FLY"

You can make changes to the relative level of the subwoofer output. This may prove useful in a number of circumstances; for example, to reduce excessive deep bass (or enhance deep bass) by lowering (raising) the subwoofer level

TO ADJUST LEVEL TRIM

Use the HTR L53 remote's "SUB" ▲/▼ buttons for direct-access level adjustment of this channel, over a range of ±12 dB.

NOTE

- Channel Level changes made via the HTR L53 are retained even if you cycle the receiver through standby.

You may operate the L53 DVD Stereo Receiver from its front panel or via the HTR L53 remote control. Since the remote will be the primary controller for most cases, we will focus on remote-controlled operations. Be sure also to read the section, "Front Panel".

ADJUSTING THE VOLUME

Use the HTR L53 remote's "VOL" ▲/▼ buttons to adjust the "master volume" of the L53, raising or lower all three channels together.

NOTE

- A momentary buttonpress will change the master volume by 1 unit increments; if you hold down "VOL" ▲/▼ buttons the master-volume change will "run-on" until the button is released.

Since recordings vary considerably in overall average level, there is no imperative to listen at any particular master-volume setting. A setting of 20 may sound "as loud" from one CD or DVD as 10 does from another.

- If muting has been activated, adjusting master-volume via the HTR L53 remote or the front-panel knob automatically releases the mute function.
- The L53 will power-up from standby mode at whatever master volume setting was last used; however, if the prior setting was greater than -10 the L53 will power up to -10. This prevents inadvertently beginning a session at excessive volume.

MUTING THE SOUND

Use the HTR L53 remote's "MUTE" button to silence all channels completely. Muting is always available, regardless of source selection.

NOTE

- Cycling through standby or powering off releases muting; the L53 will return from standby with muting off if standby was invoked with muting on.
- A changing input releases muting.
- Adjusting the master-volume via the HTR L53 or the front-panel volume knob automatically releases the mute function.

SELECTING SOURCES

With the HTR L53's remote's "AMP" device selected, the remote's numeric-button section directly selects the receiver's internal DVD and tuner "TUNER", as well as the other inputs, refer to the orange labels directly above each button.

- When a source other than the internal DVD is selected, the video signal at the monitor output is either a black background, or the input video if present.
- When you change sources, the VFL will display the new input

When you want to play back DVD videodiscs, turn on the TV and select the L53's DVD player. When you want to experience the three dimensional sound-field of DVD videodiscs, VCDs, or audio CDs from the L53, press the "AUDIO MODE" button on the L53 and select the SRS ON or OFF.

The HTR L53 Device Selector button "DVD" will enable the transport buttons beneath the HTR L53 navigation buttons. The source selector button "INPUT SELECT" on the L53 can also select DVD as well. If the L53 is in standby mode, the "OPEN/CLOSE" button will also automatically select DVD mode.

Set the playback picture size according to the aspect ratio of the connected TV in the "SETUP/MEMORY" OSD menus.

PRESS "OPEN/CLOSE"; THE DISC TRAY OPENS.

- You can open the disc tray by pressing this button even if the L53 is in standby mode. The power indicator will turn from blue to dark. Place a disc on the disc tray with the playback side down.
- There are two different disc sizes. Place the disc in the correct guide on the disc tray. If the disc is out of the guide, it may damage the disc and cause the L53 to malfunction.
- Press "PLAY/PAUSE", the disc tray is automatically closed and playback begins.
- If the disc is placed in upside down (and it is a single sided disc), 'NO DISC' appears on both the L53's display and the TV/monitor screen.
- If you insert an audio CD or VCD, the total tracks and time will appear.
- If you insert a SVCD videodisc, the PBC symbol (Play Back Control) will appear in the L53's display and OSD. The "TITLE" button on the HTR L53 will toggle on and off PBC.
- After playing back all of the chapters in the title, L53's DVD player automatically stops and returns to the menu screen.

Press the HTR L53's navigation buttons then and press "ENTER", or press the numeric button(s), to select the desired item. Play of the selected item now begins.

For further information, also refer to the jacket or case of the disc you are playing.

NOTES

- Do not move the L53 during playback. Doing so may damage the disc and the L53.
- Do not push the disc tray while it is moving. Doing so may cause the L53 to malfunction.
- Do not push up the disc tray or put any objects other than discs on the disc tray. Doing so may cause the L53 to malfunction.
- Keep your fingers well clear of the disc tray as it is closing. Be especially careful with children's fingers around the closing disc tray, as there is a risk of personal injury.
- Depending on the DVD disc, some operations may be different or restricted. Refer to the jacket or case of the disc you are playing.

ABOUT DVD/SVCD/VCD/CD

The L53's internal DVD/SVCD/VCD/CD player will play DVDs, SVCD with or without PBC (Play Back Control), VCDs, and CDs including CD-R, CD-RW, and MP3. To turn on or off PBC, toggle the "TITLE" button on the HTR L53.

NOTE

- You cannot playback discs other than those listed above such as Video CD-CD-ROM, CD-Extra, CD-G, photo-CD, and CD-i data discs. To do so may render the L53 permanently inoperable.















REGION MANAGEMENT INFORMATION

This DVD Player is designed and manufactured to respond to the Region Management Information that is recorded on a DVD disc. If the Region number described on the DVD disc does not correspond to the Region number of this DVD player, this DVD player cannot play that disc.

NOTE

- There are two regions for the L53, Region 1 and Region 2 as shown on the back of the L53.

TRANSPORT CONTROL BUTTONS

These buttons are found on both on the L53 front panel and HTR L53. On the L53 they are the "Stop/Open", "Play/Pause", , , , and  buttons. On the HTR L53 these transport buttons are , , , , , , , , , and .

TITLE AND MENU BUTTONS

Both these buttons are only found on the HTR L53. Both "TITLE" and "MENU" buttons are used to display via OSD, the title headings and menus of the DVD and MP3 CD media when available.

Some movie discs may contain two or more titles. If the disc has a title menu recorded on it, the "TITLE" button can be used to select the movie title. (The details of operation differ depending on the disc used.)

NOTE

- Selecting a title may not be possible on certain DVD discs.
- Press "TITLE"; a list of the titles on the disc is displayed. Press "TITLE" again to resume play from the scene when "TITLE" was first pressed
- Press "ENTER", "PLAY", or the numeric button(s), to select desired title. The selected title now starts playing.
- Depending on the DVD-A disc, some operations may be different or restricted. Refer to the jacket or case of the disc you are playing.

Some DVDs have unique menu structures called DVD menus. For example, DVDs programmed with complex contents provide guide menus, and those recorded with various languages provide menus for audio and subtitle language. Although the DVD menu's contents and operation differ from disc to disc, the following explains the basic operation when this feature is used.

Press "MENU" during play; the DVD menu available on the disc is now displayed. Pressing "MENU" again resumes play from the scene when MENU was first pressed.

OSD NAVIGATION

Perform the L53's DVD OSD navigation by using the L53's "SETUP/MEMORY", and the HTR L53's navigation ▲/▼/◀/▶, buttons with the "ENTER" button; before performing OSD navigation connect the L53 to a TV/monitor.

During playback of DVD, VCD, and CD media the HTR L53's display button "DISP" will enable an OSD for navigation of time/tracks/chapters (media specific), audio language (DVD, and SVCD only), subtitle language (DVD only), angles (DVD only), and surround sound configuration.

NOTE

- The display feature may not be available for all disc media and is media dependent.
- The HTR L53's Display button toggles between time/track/chapters and subtitle/angles/surround sound configuration for (DVD only).

VIDEO SETUP

VIDEO SETUP MENU

Select this menu to enter the DVD-player's options menu

OSD LANGUAGE

Select this menu to enter the OSD language menu.

EXIT

Select this to exit the OSD.

OSD LANGUAGE

To select the OSD language for the L53. From the OSD menu select 'OSD Language' and then toggle through to the required language; English, French, German, Spanish, Italian, and Portuguese. To save the setting select "Save and Exit"



Operation

USING THE L53'S DVD/VCD/CD PLAYER

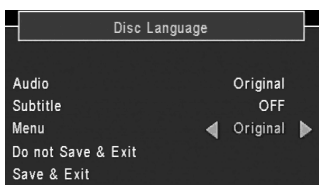
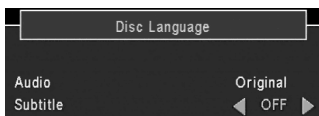
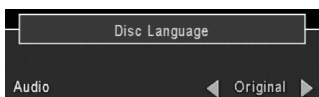
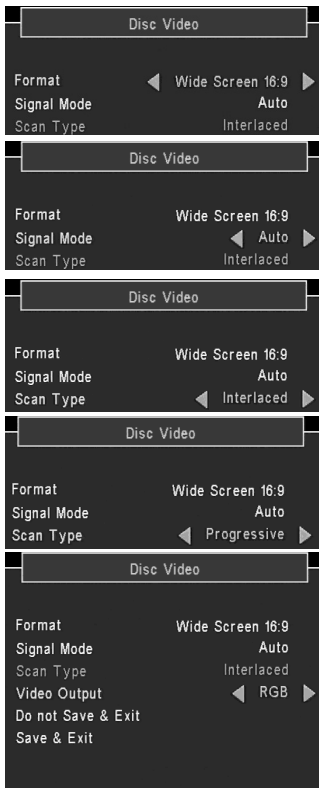

DISC VIDEO OSD

To select the appropriate screen type according to your TV set, one selects the "SETUP/MEMORY" button from the L53's front panel. Choose "DISC VIDEO" and select choices that best fit your TV set.

FORMAT

Select between Letter Box 4:3, Pan Scan 4:3, and Wide Screen 16:9 using either the navigation, or the "ENTER" buttons to select. To save the setting select "Save and Exit"

SIGNAL MODE

Use the navigation or the "ENTER" buttons to select between NTSC, PAL or AUTO depending on your TV/monitor configuration/type. To save the setting select "Save and Exit"

SCAN TYPE

Use the navigation or the "ENTER" buttons to select between "Interlaced" and "Progressive" scan types, depending on your TV/monitor configuration/type. To save the setting select "Save and Exit"

NOTE

- One can also use the L53's front panel "DISPLAY:" button to toggle between Progressive and Interlaced scan. Hold in the "DISPLAY" button for greater than 8 seconds to toggle between the scan types.
- Progressive scan is not available for RGB output.

VIDEO OUTPUT (230V ONLY)

Use the navigation or the "ENTER" buttons to select between RGB (SCART Video Out) and YUV (Component Video Out) depending on your TV/monitor configuration. To save the setting select "Save and Exit"

NOTE

- RGB is not available when Progressive scan is selected.

DISC AUDIO OSD

Depending on the media played, audio may not be present unless the "AUDIO OUT" is set to either "PCM" or "Bitstream". Please refer to your DVD/CD media documentation for the correct settings.

DIGITAL OUT

Select between "PCM" and "Bitstream" at the L53's "DIGITAL OUT" to other audio/video equipment using the navigation or the "ENTER" buttons to select. To save the setting select "Save and Exit"

PCM FORMAT

Select between "96kHz" or "96kHz > 48kHz" using the navigation or the "ENTER" buttons to select. To save the setting select "Save and Exit"

DISC LANGUAGE

Depending on the DVD media, only those languages recorded on the DVD media are available. When these settings are chosen, they will become default settings, unless the DVD media overrides the settings.

AUDIO

Select between English, French, German, Dutch, Spanish, Italian, Portuguese, Swedish and Original for the DVD disc audio using the navigation or the "ENTER" button to select. To save the setting select "Save and Exit"

SUBTITLE

Select between English, French, German, Dutch, Spanish, Italian, Portuguese, Swedish, and OFF for the DVD disc subtitles using the navigation or the "ENTER" button to select. To save the setting select "Save and Exit"

MENU

Select between English, French, German, Dutch, Spanish, Italian, Portuguese, Swedish, and Original for the DVD disc menus using the navigation or the "ENTER" button to select. To save the setting select "Save and Exit"

PARENTAL CONTROL

PASSWORD

Select PASSWORD to change a four digit password, using the numeric buttons on the HTR L53's remote control. The first time you input a password, use the factory default password 1234.

RATING LEVEL

Select between 1 to 8 or "Unlock" to limit the viewing of DVD media only, by using the "ENTER" button to select. The value of "Unlock" represents full access to all rating types of DVDs; the value of 1 represents total restriction of DVDs limited to family entertainment. To save the setting select "Save and Exit"

NOTE:

- If you have forgotten your password, see "TROUBLESHOOTING" to restore factory default password.

PLAYING CD, VCD, SVCD, DVD

PROGRAMMING (CD VCD SVCD)

When programming a sequence of tracks or chapters, the L53 must be in stop mode. To program the sequence; press the HTR L53's "PROGRAM" button to enter program mode, then use the number buttons to source the file, then "ENTER" to load the file into the program. Load up to 100 CD-tracks or chapters into a program sequence. Press the "CLEAR" button to clear the last track or chapter. Press the "PLAY" button to lock and start the program sequence.

RANDOM PLAY (CD VCD SVCD)

Press the HTR L53's "RANDOM" button for random playback of CD-tracks or chapters. The random feature will clear any program sequence.

NOTE

- For SVCD, and VCD with PBC, turn off the PBC using the "TITLE" button on the HTR L53 to enable the random function.

REPEAT (CD VCD SVCD DVD)

Press the HTR L53's "REPEAT" button; once for repeating a single CD-track or chapters, a second time to repeat the all tracks or chapters, and a third time to turn off repeat. The OSD and VFD will display the repeat mode. The repeat feature will clear the program sequence.

REPEAT A-B (CD VCD SVCD DVD)

Press the HTR L53's "REPEAT A-B" button once to set the start of the repeat function. Press it a second time to set the end point of the repeat function. Press it a third time to cancel the repeat function.

NOTE

- For SVCD, and VCD with PBC, turn off the PBC using the "TITLE" button on the HTR L53 to enable the repeat function.

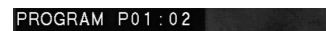
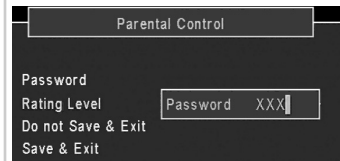
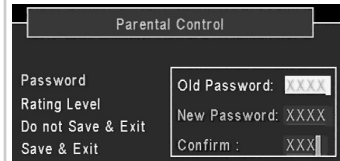

Operation

USING THE L53'S DVD/VCD/CD PLAYER



PLAYING MP3 WMA AND JPEG CD-R/CD-RW

Load CD. The OSD will display the folders or files as a list. For each file type; MP3, WMA, and JPEG, the L53's VFD will display the file type. You may mix any of the file types on the CD. When playing the media, the HTR-L53's "DISP" button toggles the time display between "Chapter Elapsed", "Chapter Remain", and "OFF."

When in stop mode, pressing the "DISP" button will open a "PROPERTIES" menu for the each media type. Press the "DISP" button a second time to close the "PROPERTIES" menu.

-- PROPERTIES --	
MP3 01 GOOD MUSIC 1	
File Size	: 5280 KBytes
Bitrate	: 192 Kbps
Sample Freq.	: 44 KHz
Audio Mode	: Stereo
Total playing time	: 03:45
File Created	: 2003/06/27 22:33:04

-- PROPERTIES --	
01 TRACK 1	
File Size	: 3830 KBytes
Total playing time	: 02:43
File Created	: 2003/06/27

-- PROPERTIES --	
HOME_7	
File Size	: 628 KBytes
File Created	: 2003/06/27

RANDOM PLAY

Press the HTR L53's "RANDOM" button for random playback of files or CD-tracks. The random feature will clear any program sequence.

NOTE

- For SVCD, and VCD with PBC, turn off the PBC using the "TITLE" button on the HTR L53 to enable the random function.

REPEAT

Press the HTR L53's "REPEAT" button; once for repeating a single file or CD-track, a second time to repeat the entire file folder or all tracks on a CD, and a third time to turn off repeat. The OSD and VFD will display the repeat mode. The repeat feature will clear the program sequence.

NOTE

- For SVCD, and VCD with PBC, turn off the PBC using the "TITLE" button on the HTR L53 to enable the repeat function.

SLIDE SHOW MODE (JPEG)

There are 12 transition modes for photo images. Press the "RTN" button on the HTR L53 to select the transition between scenes. The last transition mode is a random selection of slide show modes.

The L53's internal AM/FM tuner offers very high quality sound from radio broadcasts. Note that reception and sound quality will always be dependent to a degree on the type of antenna(s) used, as well as proximity to the broadcast origin, geography, and weather conditions.

ABOUT ANTENNAS

The supplied ribbon -wire FM antenna can be connected to the rear-panel FM-antenna input using the 'balun' included adaptor, and should be fully extended to form a "T". This folded-dipole antenna will usually work best oriented vertically, with the arms of its "T" full outstretched and arranged perpendicular to the origin of the desired broadcast. There are no 'rules,' however, and experimenting freely with antenna placement and orientation may yield the clearest sound and lowest background noise. In areas of poor FM reception, an exterior FM antenna can improve performance dramatically. If radio listening is important to you, consider consulting an antenna installation professional to optimise your system.

The supplied AM 'loop' antenna will usually provide adequate reception. However, an exterior AM antenna can be used to improve reception; consult an antenna professional for more information.

SELECTING THE RADIO

Press the "INPUT SELECT" button on the L53 front panel, the HTR L53's orange "TUNER" (the numeric 5 button), or the yellow "AM" and "FM" buttons to select the receiver's radio mode. Each subsequent press of either button will toggle the unit between its FM and AM bands.

TUNING STATIONS

Press "INPUT SELECT" on the front panel to select FM or AM frequencies. Press and hold "SCAN TUNE ◀◀ ▶▶" for more than 2 seconds to search up or down; the L53's tuner will stop at the next sufficiently strong signal it encounters. Pressing the "SCAN TUNE ◀◀ ▶▶" buttons momentarily during the search process will stop the search.

NOTE

- As well as from the front panel, one can perform the Scan function from the HTR L53 remote using the "TUNE ◀◀ ▶▶" buttons.

SETTING RADIO PRESETS

The L53 can store as many as 60 of your favourite radio stations for immediate recall; 30 FM stations and 30 AM. To store a radio preset, first tune the desired frequency (see above), then press the front panel "MEMORY" button. Press the "PRESET ,◀◀ ▶▶" button to select the preset number. Then press the "MEMORY" button once again.

NOTE

- The Radio Presets must be stored from the front panel; this setup function is not accessible from the HTR L53 remote.

SELECTING RADIO PRESETS

Press "PRESET ▲/▼" on the front panel to step up or down between presets; press and hold "PRESET ▲/▼" to scroll continuously up or down. The HTR L53 remote's "PRESET ▲/▼" buttons work similarly.

DELETING A STORED PRESET

You can empty a preset by deleting the stored information.

- Select the preset to be emptied.
- Simultaneously press the front panel buttons DISPLAY and SETUP/MEMORY in the following order.
- First press the DISPLAY button and hold it in. While holding in the DISPLAY button press the SETUP/MEMORY button for about one half second, then release the SETUP/MEMORY button.
- Release the DISPLAY button.
- The preset will then be deleted and "DELETED" scrolls on the display.

NOTE

- Empty presets will be skipped during preset tuning.

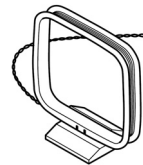
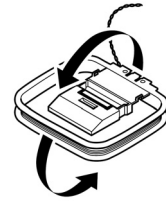

AM Loop Antenna

CHOOSING THE FM MUTE / MODE

The front-panel "FM MUTE / MODE" button is a dual-purpose control. First, it "toggles" the L53 between stereo mute and unmuted mono reception (assuming that a multiplex-stereo station of sufficient strength is tuned). FM Mute eliminates noise from "empty" FM frequencies but also mutes very weak or distant stations. Toggling off the FM Mute will result in reduced noise if the FM station signal level is less than the FM Stereo threshold (since mono FM is inherently less noise-prone), though at the sacrifice of the stereo effect.

NOTE

Toggling between FM Mute on or off also defeats the L53's FM muting circuit. If you wish to listen to a particularly weak or distant broadcast, toggle off the FM Mute and tune it manually.

ABOUT RDS

The Radio Data System (RDS) permits compatible FM receivers to display text determined by the broadcaster. The L53 supports two RDS modes, station-name (PS mode) and radio-text (RT mode). However, not every FM station incorporates RDS in its broadcast signal; in most areas you will find from one to several RDS-enabled stations, but it is by no means impossible that your favourite stations will not be broadcasting RDS data.

VIEWING RDS TEXT

When an RDS-enabled FM broadcast is tuned, after a brief delay the "RDS" symbol will light in the L53's front-panel readout and the readout's character section will show its station-name (PS) text: "ROCK101," for example. Press the front-panel "DISPLAY" button to toggle the readout between this and the station's radio-text (RT) readout, if any, which might scroll song- or artist-name, or any other text of the station's choosing.

SPECIFICATIONS

- Controls up to 8 devices
- 44 function buttons
- Learns up to 352 commands
- Records up to 44 macros with a maximum of 64 commands each
- Configurable punch-through
- Button illumination with programmable timeout
- Upgradable
- Contains pre-programmed library of NAD remote codes for the L53.

The NAD HTR L53 is ready to operate the L53 receiver right out of the box, but it is really eight remotes in one. Each of the 8 Device Selector buttons at the top of the handset can call up a new "page" of remote-control codes to be transmitted by the remaining 44 buttons. You may "teach" codes from any infrared-remote-controlled component, regardless of brand, to any or all of these. Obviously, the most logical system is that you teach the codes from your DVD player to the "DVD" Device Selector "page," your television's codes to the "TV" "page," and so on, but there is no required scheme: You may load any commands to any button on any page (see "Learning Codes From Other Remotes," below).

The HTR L53 is already preprogrammed with a full complement of commands for the L53 receiver on its "AMP", "TUNER" and "DVD" Device Selector page, and as well as with library commands to operate most NAD-brand DVD, CD, or TAPE components on the corresponding Device Selector "pages." These default commands are permanent: Even if you teach the HTR L53 new commands to take their place, the underlying library commands remain in place and can easily be recalled should you add an NAD component to your system later (see "Delete Mode," below).

NOTE

- For use with the L53, it should not be necessary to re-program any buttons on the HTR L53 "AMP" and "DVD" page. However, in order for the HTR L53 to control your specific NAD-brand components you may need to load one or more different code-libraries; see "Loading Code Libraries," below.

CONTROLLING THE L53

The HTR L53 is divided into two main sections. Eight Device Selector buttons at the top-"AMP", "DVD," "TV," and so on-set the handset's remaining buttons to a "page" of commands to control a particular component. A Device Select button determines only what component the HTR L53 will command; it does not perform any function on the receiver. All of the remaining buttons are function buttons that can "learn" control codes from virtually any infrared remote controller, allowing you to teach the codes of your equipment, regardless of brand, to the HTR L53.

However, the HTR L53 is already preprogrammed to operate the L53. All of the function buttons on the "AMP", "TUNER" and "DVD" Device Selector "page" perform L53 functions. (The HTR L53 can also command many other NAD components, from its "CD" and "TAPE" pages.)

It is important to note that certain HTR L53 buttons perform different functions depending on the selected Device Selector "page." The colour of the Device Selector button-labelling corresponds to the labelling of the function buttons. Most centrally, the orange "AMP" Device Selector "page" corresponds to the orange input-select labelling adjacent to the numeric buttons: When the HTR L53's "AMP" Device Selector page is active, these buttons select the receiver inputs. Similarly, the red "DVD" Device Selector "page" corresponds to several red labels, the green "TV" page to green labels, and so on.

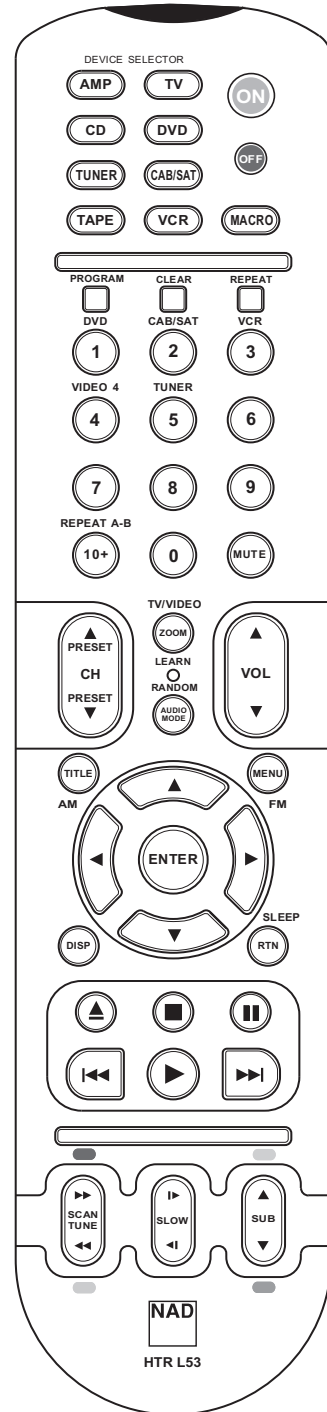

ENGLISH

LEARNING CODES FROM OTHER REMOTES

Begin by positioning the HTR L53 "nose-to-nose" with the source remote so the two devices' infrared windows are about 2 inches apart.

- Enter Learning Mode: On the HTR L53, simultaneously press-and-hold for 3 seconds both a Device Selector button and the ▲ "OPEN/CLOSE" button (just below the "DISP" button), until the Learn LED at the centre of the HTR L53 turns steady green.
- Press the HTR L53's function button you wish to teach a command; the Learn LED will turn amber.
- Press-and-hold the function button on the source remote: The HTR L53's Learn LED will flicker amber for a second or two, then turn solid green. The command is learned.
- Press the HTR L53's Device Selector button again to exit the learning mode.

If the Learn LED does not flicker amber you may need to vary the distance between the remotes. If the Learn LED turns red rather than green, that particular command of that source remote command could not be learned.

CANCEL OPERATION

You can cancel configuring a button, by pressing the active Device Selector button before the learn process is complete; the Learn LED will turn red.

Example: Learning "VCR Pause":

Position the HTR L53 and your VCR player's remote as described above.

- On the HTR L53, simultaneously press-and-hold "VCR" and ▲ ; the Learn LED turns steady green.
- Press the HTR L53's || (pause) button; the Learn LED turns amber.
- Press-and-hold the VCR player's remote's pause button; the HTR L53's Learn LED flickers amber and then turns solid green. The command is learned.
- Press "VCR" again to exit the learning mode.

PUNCH-THROUGH

The HTR L53's "punch-through" function allows you to retain a function button from one Device Select "page" on another, so that, for example, the AMP "SURR MODE" function might still control the L53 when the DVD Device Selector page is active

NOTE

- *The HTR L53's "VOL" and "MUTE" buttons are pre-programmed as "punched-through" for all Device Select pages: "VOL" will operate the L53's master-volume regardless of the currently selected device. The "SURR," "CENTER," and "SUB" Channel Volume controls similarly are pre-programmed as punched-through.*

To set a punch through, after entering the Learning Mode, and pressing the desired button to be punched-through, simply press the device button twice of the device to punch through to. The status LED will turn green; press the Device Selector button again to exit Learning Mode.



Example: Punch-through the from the DVD "page" to the AMP "SURR MODE" button:

- On the HTR L53, simultaneously press-and-hold "DVD" and ▲ (OPEN/CLOSE); the Learn LED turns steady green.
- Press "SURR MODE"; the Learn LED turns amber.
- Press "AMP" twice; the Learn LED turns green.
- Press "DVD" again to exit the learning mode.

COPY A COMMAND FROM ANOTHER BUTTON

You may copy a command from any HTR L53 button to any other. To copy a button function, after entering the Learning Mode, and pressing the desired button to be copied to, simply press the device button from which you wish to copy, having first pressed its Device Selector button if it resides on another "page." The status LED will turn green; press the Device Selector button again to exit Learning Mode.

Example: Copy the Pause command from the DVD page to the AMP  button:

- On the HTR L53, simultaneously press-and-hold "AMP" and  (OPEN/CLOSE); the Learn LED turns steady green.
- Press  (pause); the Learn LED turns amber.
- Press "CD"; press  (pause); the Learn LED turns green.
- Press "AMP" again to exit the learning mode.

NOTE

- *The copy and punch-through functions are similar. However, if you copy a command and then subsequently delete, or over-write the original (source-button) command, the copied-to button's command remains unchanged. If you punch-through to a command and then delete or over-write the original button, the punched-through functions also change accordingly.*

MACRO COMMANDS

A "macro" command is a series of two or more remote codes issued automatically from a single buttonpress. You might use a macro to automate a simple command sequence, such as, "Turn on the DVD player and then press 'play.'" Or you might compose an elaborate macro to power up an entire system, select a source, choose a SURROUND MODE, and begin playback-again, all from a single buttonpress. The HTR L53 can store one macro on each of its function buttons (these exclude the Device Selector buttons).

NOTE

- *Macros are independent of the currently selected device.*

RECORDING MACROS

To record a macro, simultaneously press-and-hold for 3 seconds both the "MACRO" button and the HTR L53 function button to which you wish to assign the macro, until the status LED turns green. The macro button will also light up. Press the sequence of function buttons to be recorded into the macro, being sure to first press the requisite Device Selector button for each function (you may switch devices while recording the macro as many times as necessary), allowing you to create macro containing commands from more than one Device Selector "page." When you have finished entering the desired command sequence, press "MACRO" again to store the macro; the Learn LED and "MACRO" button illumination will turn off.

NOTE

- *Each macro can store a maximum of 64 command steps. If you exceed this number, the macro will be stored automatically after the 64th command is added.*

Example: Record a Macro to the "0" button to Turn on the L53, Select the DVD Input, and Commence Playback:

- On the HTR L53, simultaneously press-and-hold "MACRO" and "0" (numeric zero); the Learn LED turns steady green.
- Press "AMP"; press "ON"; press "1" (orange "DVD"); press "DVD"; press "play" (the Learn LED blinks as each step is added).
- Press "MACRO" again to exit the macro-record mode.

To clear a macro, perform the above steps without entering any functions.

EXECUTING MACROS

To execute a macro, press and release "MACRO"; its button illumination lights for 5 seconds. While it remains lit, press an HTR L53 button to which a macro has previously been stored. The corresponding macro will run; as each step executes, its "parent" Device Selector's button flashes lights briefly; when execution is finished, the "MACRO" button illumination goes out. Pressing any other HTR L53 button while a macro is executing will abort the macro. Remember that you must hold the HTR L53 so that its infrared emitter can activate the target components.

NOTE

- *When a macro executes, a 1 second delay is automatically inserted between its commands. If you need more than a 1 second delay between particular commands—for example, to permit a component to power up completely—you can record "empty" steps into the macro by changing Device Selector "pages" without entering actual command functions.*

BUTTON-ILLUMINATION TIMEOUT

The HTR L53's button-illumination can be set to remain lit for 0-9 seconds. The default value is 5 seconds.

To set the illumination timeout, simultaneously press-and-hold for 3 seconds both the HTR L53's "DISP" and the "0-9" button, with the digit corresponding to the desired timeout duration; the Learn LED will flash twice to confirm the new setting. When set to zero, the illumination will not turn on at all.

NOTE

- *Button illumination is the biggest drain on the HTR L53's batteries. A short button-illumination timeout will extend battery life appreciably; turning it off altogether (set it to 0 seconds) will lengthen it still further.*

FACTORY RESET

The HTR L53 can be reset to its factory state, deleting all learned commands, copied and punched-through buttons, macros, and other setup information, reverting all buttons to their pre-programmed library commands. To perform a factory reset simultaneously press-and-hold for **10** seconds the HTR L53's "ON" and "RTN" buttons; the Learn LED will start to flash green. Release "ON" and "RTN" before the second flash is complete; the Learn LED will turn red, indicate the remote has been reset.

NOTE

- *You must release "ON" and "RTN" before the second flash goes out, otherwise the unit will not reset; should this occur, repeat the full procedure.*

USING THE HTR L53 REMOTE CONTROL

DELETE MODE

The HTR L53 can store learned, copied, and "default library" commands on any single button. (The default library commands are the pre-programmed NAD codes, such as the native L53 commands on the "AMP" "page.") You can delete commands by layers back "down" to the default library command on any button, removing learned commands, punched-through functions, and copied buttons.

NOTE

- *The default library commands cannot be deleted, so you need not worry that using Delete Mode might cause irreparable changes.*

To enter Delete Mode, simultaneously press-and-hold for 3 seconds both the desired button's Device Selector button and the "RTN" button, until the Learn LED turns green. Press the function button whose command you wish to delete; the Learn LED flashes; the number of times indicates which type of function has become active-see the table below. Press the active Device Selector button again to exit Delete Mode.

NOTE

- *You may delete multiple function-button commands on the same Device Selector "page," but to delete from more than one Device Selector page you must exit Delete Mode and then re-enter it on the required page.*

Flashes	Command Type
1	Default Library Command
2	Copied Library Command
3	Learned Command

LOADING CODE-LIBRARIES

The HTR L53 can store a different library of default NAD codes for each of its Device Selector "pages." If the original default library does not control your NAD CD player, tape deck, DVD player, or other component, follow the procedure below to change the code-library.

Begin by ensuring that the component you wish the HTR L53 to control is plugged in and powered-up ("on," not merely in standby). To enter the HTR L53's Library Mode, simultaneously press-and-hold for 3 seconds both the desired Device Selector button and the "PROGRAM" button, until the Learn LED turns green. While keeping the HTR L53 pointed toward the component, enter the first appropriate three-digit code-library number from the table below. If the component turns off, press "ENTER" to accept that code-library number and exit the Library Mode. If the component does not turn off, enter the next three-digit code-library number from the table. When you enter the correct number the component will turn off; press "ENTER" to accept that code-library number and exit the Library Mode.

NAD-brand component	HTR L53 code-library numbers
CD Player (new)	200
CD Player (old)	201
DVD T562	600
DVD T550, L55	601
DVD T531, T571	602
DVD T512, T532, T572	602
L56	604
DVD T513, T533	605

SEARCH MODE

If none of the codes from the table turn off the component, and if you are quite sure you have followed the above procedure completely and carefully, you may want to try the "search" method as follows:

Enter Library Mode by simultaneously pressing-and-holding for 3 seconds both the desired Device Selector button and the "PROGRAM" button, until the Learn LED turns green. Now press-and-hold the HTR L53's ▲ or ▼ button; the remote will step through all the available codes at a rate of approximately 1 per second. When the component turns off, immediately release the cursor button; press "ENTER" to accept that code-library and exit the Library Mode. Try a few commands; should you prove to have stepped past the needed code-library, re-enter the Library Mode and use the cursor button to step back to it.

NOTE

- *It is possible that search mode will find code-libraries that operate, at least partially, some other-brand (non-NAD) components. You may certainly exploit such capabilities as you find them. However, since we can only ensure the completeness or accuracy of NAD code-libraries, we cannot support the HTR L53's operation with other-brand components.*

CHECKING CODE-LIBRARY NUMBER

You can check the current code-library on any Device Selector button as follows. Enter Library Mode by simultaneously pressing-and-holding for 3 seconds both the desired component's Device Selector button and the "PROGRAM" button, until the Learn LED turns green. Press the "DISP" button; the HTR L53 indicates the current code-library by flashing its "TAPE", "VCR", and "MACRO" buttons. For example, to indicate code-library #501 the HTR L53 will flash "TAPE" 5 times, pause, and then flash "MACRO" once. You might wish to make a note of your components' code-library numbers.

SUMMARY OF HTR L53 MODES

Mode	Buttons To Press (for 3 seconds)
Learn/Copy/Punch Through	Device Button + OPEN/CLOSE Button
Delete Mode	Device Button + Return Button
Macro Record	Macro Button + Function Button
Library Mode	Device Button + Program Button
Back Light Timeout	Display Button + Digit Button
Factory Reset	(see "Factory Reset")

Reference

TROUBLESHOOTING

CONDITION	POSSIBLE CAUSE(S)	POSSIBLE SOLUTIONS(S)
NO SOUND FROM ALL CHANNELS	<ul style="list-style-type: none"> AC power unplugged Power not switched on Outlet is unpowered 	<ul style="list-style-type: none"> Check AC cable, connection, and outlet
NO SOUND FROM SOME CHANNELS	<ul style="list-style-type: none"> Faulty/missing cables; "AUDIO MODE" settings channel(s) set to "-80" Power-amp or speaker-connections faulty 	<ul style="list-style-type: none"> Check cables Check "AUDIO MODE" VFD menu Check power amp, cabling, and speakers
NO SOUND FROM SUBWOOFER	<ul style="list-style-type: none"> Subwoofer is off, unpowered, or improperly connected Subwoofer level set too low "-12" 	<ul style="list-style-type: none"> Power-up subwoofer, check sub's AC outlet, or check connections Correct subwoofer level by adjusting "SUB" from the HTR L53 "SUB" button.
NO SOUND FROM SRS 3D	<ul style="list-style-type: none"> SRS set to "OFF" on "AUDIO MODE" VFD menu 	<ul style="list-style-type: none"> Correct "AUDIO MODE" set to "ON"
L53 DOES NOT RESPOND TO HTR L53 REMOTE	<ul style="list-style-type: none"> Batteries are flat or incorrectly inserted IR transmitter window on remote, or IR receiver window on L53 is obstructed L53 front panel is in very bright sunlight or ambient light 	<ul style="list-style-type: none"> Check batteries Check IR windows and ensure clear line-of-sight from remote to L53 Reduce sunlight/room lighting
L53 DOES NOT RESPOND TO FRONT-PANEL COMMANDS	<ul style="list-style-type: none"> Microprocessor error L53 may have over-heated 	<ul style="list-style-type: none"> Power-down the L53 via the front-panel Power button and unplug it from the AC outlet Wait five minutes, re-connect and power up
THE POWER IS ON, BUT THE DVD PLAYER DOES NOT WORK	<ul style="list-style-type: none"> No disc is inserted. 	<ul style="list-style-type: none"> Insert a disc (Check that the DVD or, audio CD indicator in the display is lit)
NO PICTURE	<ul style="list-style-type: none"> The TV is not set to receive DVD signal The video cable is not connected securely The connected TV power is turned off 	<ul style="list-style-type: none"> Select the appropriate video input mode on the TV so that the picture from the DVD player appears on the TV screen output. Connect the video cable into the jacks securely. Power on the TV
NO SOUND	<ul style="list-style-type: none"> The Digital Audio Input is set to the wrong position 	<ul style="list-style-type: none"> Set the Digital Audio Input to the correct position
THE PLAYBACK PICTURE IS POOR	<ul style="list-style-type: none"> The disc is dirty 	<ul style="list-style-type: none"> Clean the disc
THE DVD PLAYER DOES NOT START PLAYBACK	<ul style="list-style-type: none"> No disc is inserted An unplayable disc is inserted The disc is placed upside down. The disc is not placed within the guide A menu is on the TV screen The disc is dirty 	<ul style="list-style-type: none"> Insert a disc (Check that the DVD, or audio CD indicator in the DVD display is lit) Insert a playable disc (Check the disc type colour system and Regional code) Place the disc with the playback side down Place the disc on the disc tray correctly inside the guide Press SETUP to turn off the menu screen Clean the disc
PARENTAL CONTROL CANNOT BE CHANGED	<ul style="list-style-type: none"> The password entered was wrong. Password was forgotten. 	<ul style="list-style-type: none"> Enter the correct password. Set the L53 to factory default settings. <ol style="list-style-type: none"> Place the L53 into FM mode. Press quickly the three front panel buttons; "PLAY/PAUSE" then "STOP/OPEN" then "DISPLAY", holding the "DISPLAY" button for more than 7 seconds. The L53 will switch itself off then back on to DVD mode.

NOTE

Default password is 1234.

AMPLIFIER SECTION

Power output Stereo Mode ¹		2 x 50W
Total harmonic distortion at rated power		0.08%
IM distortion at rated power		0.08%
Damping factor 8 ohms		> 60
Frequency response		20 to 20,000 Hz ±0.5 dB
Signal/noise ratio ²		>99 dB
Signal/noise ratio ³		>85 dB
Remote control		HTR L53

TUNER SECTION

Input sensitivity	Mono	16.1 dBf
	50dB Stereo	36.1 dBf
Harmonic Distortion	FM Mono	0.2%
	FM Stereo	0.5%
Signal / noise	Mono	69 dB
	Stereo	64 dB
Stereo separation at 1 kHz		40 dB
Frequency Response; ± 1.5 dB		30 Hz - 15 kHz

OUTPUTS

Video output		1.0 V (p-p), 75 ohms, negative sync., RCA jack x 2
Component out		RCA x 3
S-video output		(Y) 1.0 V (p-p), 75 ohms, negative sync., Mini DIN 4-pin x 2
SCART video output (EUR only)		(C) 0.286 V (p-p), 75 ohms
		CVBS 1.0 V (p-p), 75 ohms, negative sync., (RGB) 0.63 V (p-p), 75 ohms
Audio output (optical audio)		Optical connector x 1
Audio output (analog audio)		2.0 Vrms(1 KHz, 0 dB), 330 ohms, RCA jack (L, R) x 2
Speaker terminals		(+, -) x 2

INPUTS

Audio input (optical audio)		Optical connector x 1
Audio input (coaxial audio)		Coaxial connector x 1
Audio input (analog audio)		2.0 Vrms(1 KHz, 0 dB), 330 ohms, RCA jack (L, R) x 6, (5.1) x 5
Component input		RCA jack x3

DVD SECTION

Signal system		PAL/NTSC/AUTO)
Laser		Semiconductor laser, wavelength 650 nm
Frequency range (audio)		4 Hz to 20 kHz
Signal-to-noise ratio (audio)		More than 100 dB (EIA)
Dynamic range (audio)		More than 95 dB (EIA)
Harmonic distortion (audio)		0.008 %
JPEG		Baseline < 5120 x 3840 pixels Progressive < 2048 x 1536 pixels

PHYSICAL SPECIFICATIONS

Dimensions (W x H x D)		17 1/8 x 4 1/8 x 14 3/4"
		(435 x 105 x 375mm)
Net Weight		18.5 lbs (8.4 kg)
Shipping Weight		23 lbs (10.5 kg)

¹ 8 ohms within rated distortion
² Ref rated power / 8 ohms (A-WTD)
³ Ref 1W / 8 ohms (A-WTD)

Specifications are subject to change without notice. For updated documentation and features please log onto www.nadelectronics.com for the latest information about your L53.



www.NADelectronics.com

**©2005 NAD ELECTRONICS INTERNATIONAL
A DIVISION OF LENBROOK INDUSTRIES LIMITED**

All rights reserved. No part of this publication may be reproduced, stored or transmitted in any form without the written permission of NAD Electronics International

L53 Manual 07/05 China

Free Manuals Download Website

<http://myh66.com>

<http://usermanuals.us>

<http://www.somanuals.com>

<http://www.4manuals.cc>

<http://www.manual-lib.com>

<http://www.404manual.com>

<http://www.luxmanual.com>

<http://aubethermostatmanual.com>

Golf course search by state

<http://golfingnear.com>

Email search by domain

<http://emailbydomain.com>

Auto manuals search

<http://auto.somanuals.com>

TV manuals search

<http://tv.somanuals.com>