

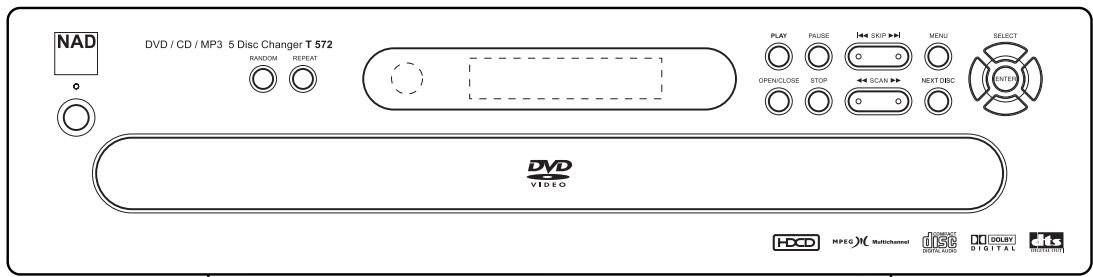

T 572

DVD / CD / MP3 Player



GB

Owner's Manual

Safety Precautions



WARNING
RISK OF ELECTRIC SHOCK
DO NOT OPEN



WARNING: TO REDUCE THE RISK OF ELECTRIC SHOCK DO NOT REMOVE COVER (OR BACK) NO USER-SERVICEABLE PARTS INSIDE REFER SERVICING TO QUALIFIED SERVICE PERSONNEL.



This lightning flash with arrowhead symbol within an equilateral triangle is intended to alert the user to the presence of uninsulated dangerous voltage within the product's enclosure that may be of sufficient magnitude to constitute a risk of electric shock to persons.



The exclamation mark within an equilateral triangle is intended to alert the user to the presence of important operating and maintenance (servicing) instructions in the literature accompanying the product.

WARNING: TO REDUCE THE RISK OF FIRE OR ELECTRIC SHOCK, DO NOT EXPOSE THIS PRODUCT TO RAIN OR MOISTURE.

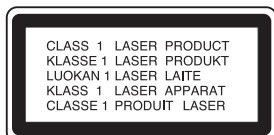

CAUTION:

This Digital Video Disc Player employs a Laser System.

To ensure proper use of this product, please read this owner's manual carefully and retain for future reference, should the unit require maintenance, contact an authorized service location-see service procedure.

Use of controls, adjustments or the performance of procedures other than those specified herein may result in hazardous radiation exposure.

To prevent direct exposure to laser beam, do not try to open the enclosure. Visible laser radiation when open. **DO NOT STARE INTO BEAM.**

CAUTION: The apparatus shall not be exposed to water (dripping or splashing) and that no objects filled with liquids, such as vases, shall be placed on the apparatus.



This product is manufactured to comply with the radio interference requirements of EEC DIRECTIVE 89/336/EEC, 93/68/EEC and 73/23/EEC.



Notes on copyrights:

It is forbidden by law to copy, broadcast, show, broadcast via cable, play in public, or rent copyright material without permission.

This product features the copy protection function developed by Macrovision. Copy protection signals are recorded on some discs. When recording and playing the pictures of these discs on a VCR, the picture noise will appear.

This product incorporates copyright protection technology that is protected by method claims of certain U.S. patents and other intellectual property rights owned by Macrovision Corporation and other rights owners. Use of this copyright protection technology must be authorized by Macrovision Corporation, and is intended for home and other limited viewing uses only unless otherwise authorized by Macrovision Corporation. Reverse engineering or disassembly is prohibited.

SERIAL NUMBER: The serial number is found on the back of this unit. This number is unique to this unit and not available to others. You should record requested information here and retain this guide as a permanent record of your purchase.

Model No. _____

Serial No. _____

Table of Contents

Introduction

Safety Precautions	2
Table of Contents	3
Before Use	4-5
Playable Discs	4
Precautions	5
Notes on Discs	5
About Symbols	5
Front Panel and Display Window	6
Remote Control	7
Rear Panel	8

Preparation

Connections	9-10
Connecting to a TV	9
Connecting to Optional Equipment	10
Before Operation	11-14
General Explanation	11
On-Screen Display	11
Initial Settings	12-14
• Initial Settings General Operation	12
• Language	12
• Picture	12
• Sound	13
• Others	13
• Parental Control	14

Operation

Operation with DVD, Video CD and Audio CD. 15-18	
Playing a DVD, Video CD and Audio CD	15
• Exchanging discs during playback	15
• Skipping discs	15
• Exchanging the disc and starting playback	15
General Features	16
• Moving to another TITLE	16
• Moving to another CHAPTER/TRACK	16
• Still Picture and Frame-by-Frame Playback	16
• Pause	16
• Slow Motion	16
• Search	16
• Random	16
• Repeat	17
• Repeat A-B	17
• Time Search	17
• Selecting the sound enhancement	17
• Zoom	17
• Marker Search	18
Special DVD Features	18
• Title Menu	18
• Disc Menu	18
• Camera Angle	18
• Changing the Audio Language	18
• Changing the Audio Channel	18
• Subtitles	18

Programmed Playback with Video CD and Audio CD	19
Programmed Playback with Video CD and Audio CD	19
• Repeat Programmed Tracks/All	19
• Erasing a Track from Program List	19
• Erasing the Complete Program List	19
Operation with MP3 Disc	20
Playing an MP3 Disc	20
• Pause	20
• Moving to another Track	20
• Repeat Track/All/Off	20
Notes on MP3 Discs	20
Programmed Playback with MP3 Disc	21
Programmed Playback with MP3 Disc	21
• Repeat Programmed Tracks/All	21
• Erasing a Track from Program List	21
• Erasing the Complete Program List	21
Additional Information	22
Last Condition Memory	22
Screen Saver	22
Video Mode Setting	22
HDCD Playback	22

Reference

Troubleshooting	23
Language Code List	24
Country Code List	25
Specifications	26

About the symbols for instructions

 Indicates hazards likely to cause harm to the unit itself or other material damage.



 Indicates special operating features of this unit.

 Indicates tips and hints for making the task easier.



Before Use

Playable Discs

	DVD Video (8 cm / 12 cm disc)
	Video CD (VCD) (8 cm / 12 cm disc)
	Audio CD (8 cm / 12 cm disc)

In addition, this unit can play a HDCD, CD-R or CD-RW that contains audio titles or MP3 files.

Notes

- Depending on the conditions of the recording equipment or the CD-R/RW disc itself, some CD-R/RW discs cannot be played on this unit.
- This unit cannot play CD-R/RW discs that do not contain any data, or contain different kinds of formatted data other than MP3 and CD-DA data.
- Do not attach any seal or label to either side (the labeled side or the recorded side) of a disc.
- Do not use irregularly shaped CDs (e.g., heart-shaped or octagonal). It may result in malfunctions.

Notes on DVDs and Video CDs

Some playback operations of DVDs and Video CDs may be intentionally fixed by software manufacturers. As this unit plays DVDs and Video CDs according to disc content designed by the software manufacturer, some playback features of the unit may not be available, or other functions may be added. Refer also to the instructions supplied with the DVDs and Video CDs. Some DVDs made for business purposes may not be playable on this unit.

Regional code of the DVD player and DVDs

This DVD player is designed and manufactured for playback of region “2” encoded DVD software. The region code on the labels of some DVD discs indicates which type of player can play those discs. This unit can play only DVD discs labeled “2” or “ALL”. If you try to play any other discs, the message “Check Regional Code” will appear on the TV screen. Some DVD discs may not have a region code label even though their playback is prohibited by area limits.



Note on DTS-encoded CDs

To avoid possible damage to the audio system, turn down the volume before playing back such discs. Adjust the volume gradually to personal preference. To enjoy DTS Digital Surround™ playback, an external 5.1 channel DTS Digital Surround™ decoder system must be connected to the digital output of the player.

Disc-related terms

Title (DVD only)

The main film content or accompanying feature content or additional feature content, or music album. Each title is assigned a title reference number enabling you to locate it easily.

Chapter (DVD only)

Sections of a picture or a musical piece that are smaller than titles.

A title is composed of one or several chapters. Each chapter is assigned a chapter number, enabling you to locate the chapter you want. Chapter numbers may not be recorded on all discs.

Track (Video CD and audio CD only)

Sections of a picture or a musical piece on a video CD or an audio CD. Each track is assigned a track number, enabling you to locate the track you want.

Scene

On a video CD with PBC (Playback control) functions, moving pictures and still pictures are divided into sections called “Scenes”. Each scene is displayed in the menu screen and assigned a scene number, enabling you to locate the scene you want.

A scene is composed of one or several tracks.

Types of video CDs

There are two types of video CDs:

Video CDs equipped with PBC (Version 2.0)

PBC (Playback control) functions allow you to interact with the system via menus, search functions, or other typical computer-like operations. Moreover, still pictures of high resolution can be played if they are included in the disc.

Video CDs not equipped with PBC (Version 1.1)

Operated in the same way as audio CDs, these discs allow playback of video pictures as well as sound, but they are not equipped with PBC.

HDCD (High Definition Compatible Digital®)

HDCD® (High Definition Compatible Digital®) is a recording system that has improved audio CD sound in dynamic range, sound field reproducibility and vocal acoustics.

This DVD player is equipped with an HDCD decoder. The HDCD indicator illuminates when playing an HDCD-encoded audio CD.

Before Use (Continued)

Precautions

Handling the unit

When shipping the unit

The original shipping carton and packing materials come in handy. For maximum protection, re-pack the unit as it was originally packed at the factory.

When setting up the unit

The picture and sound of a nearby TV, VCR, or radio may be distorted during playback. In this case, position the unit away from the TV, VCR, or radio, and turn off the unit after removing the disc.

To keep the exterior surfaces clean

Do not use volatile liquids, such as insecticide spray, near the unit. Do not allow rubber or plastic products to contact the unit for a long period of time. They will leave marks on the surface.

To move the unit

When you move the player, take out any discs. If you don't, the discs may be damaged or drop into the internal workings of the DVD player.

Cleaning the unit

To clean the cabinet

Use a soft, dry cloth. If the surfaces are extremely dirty, use a soft cloth lightly moistened with a mild detergent solution. Do not use strong solvents, such as alcohol, benzene, or thinner, as these might damage the surface of the unit.

To obtain a clear picture

The DVD player is a high-tech, precision device. If the optical pick-up lens and disc drive parts are dirty or worn down, the picture quality will be poor. Regular inspection and maintenance are recommended after every 1,000 hours of use. (This depends on the operating environment.) For details, please contact your nearest dealer.

Notes on Discs

Handling discs

Do not touch the playback side of the disc.
Hold the disc by the edges so that fingerprints will not get on the surface.
Do not stick paper or tape on the disc.



Storing discs

After playing, store the disc in its case. Do not expose the disc to direct sunlight or sources of heat, or leave it in a parked car exposed to direct sunlight, as there may be a considerable temperature build-up inside the car.

Cleaning discs

Fingerprints and dust on the disc can cause poor picture quality and sound distortion. Before playing, clean the disc with a clean cloth. Wipe the disc from the center out.

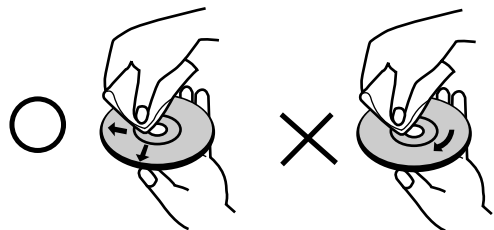

Do not use strong solvents such as alcohol, benzene, thinner, commercially available cleaners, or anti-static spray intended for older vinyl records.





About Symbols

About the symbol display

“” may appear on the TV screen during operation. This icon means the function explained in this owner's manual is not available on that specific DVD video disc.

About the disc symbols for instructions

When a section in this manual includes the following icons, the data provided herein is applicable only to the software represented by that icon.

-  DVD DVD
-  VCD2.0 Video CDs with the PBC (playback control) function.
-  VCD1.1 Video CDs without the PBC (playback control) function.
-  CD Audio CDs.
-  MP3 MP3 disc.

Front Panel and Display Window

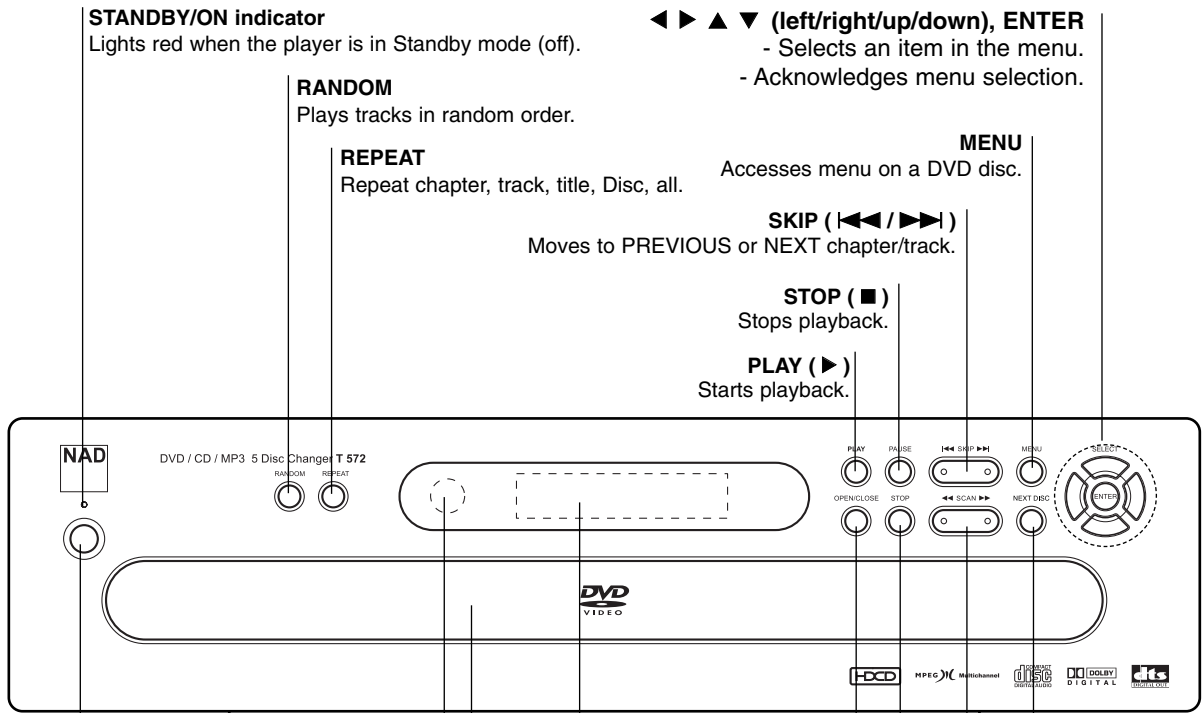

STANDBY/ON indicator

Lights red when the player is in Standby mode (off).

RANDOM

Plays tracks in random order.

REPEAT

Repeat chapter, track, title, Disc, all.

◀ ▶ ▲ ▼ (left/right/up/down), ENTER

- Selects an item in the menu.
- Acknowledges menu selection.

MENU

Accesses menu on a DVD disc.

SKIP (◀◀ / ▶▶)

Moves to PREVIOUS or NEXT chapter/track.

STOP (■)

Stops playback.

PLAY (▶)

Starts playback.

NAD

DVD / CD / MP3 5 Disc Change T 572



Display window

Shows the current status of the player.

Remote Sensor

Point the DVD Player remote control here.

Disc Tray

Insert a disc here.

OPEN/CLOSE (▲)

Opens or closes the disc tray.

STOP (■)

Stops playback.

SCAN (◀◀ / ▶▶)

Press for fast reverse search or forward search.

POWER

Switches the player ON and OFF.

NEXT DISC

Moves to the next available disc tray.

ANGLE Lights when multi angles are present.

A light will appear if a disc is in the disc tray. The current disc tray flashes.

DVD DVD inserted

CD Audio CD inserted

VCD Video CD inserted

HD CD HDCD disc inserted

MP3 MP3 disc inserted

Indicates current player function: Playback, Pause, etc.

TITLE Indicates current title number

CHP/TRK Indicates current chapter or track number

Indicates total playing time/elapsed time

PROG. Programmed playback active

RANDOM RANDOM playback active

Indicates repeat mode

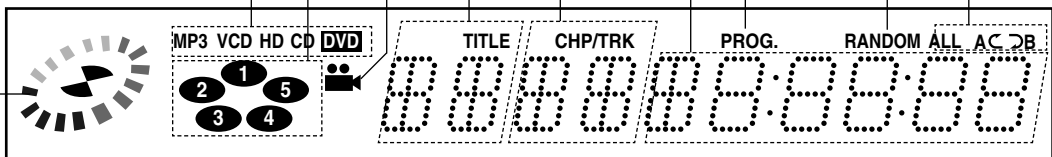

Remote Control

POWER
Switches DVD Player ON and OFF.

SETUP •
Accesses or removes setup menu.

REPEAT •
Repeat chapter, track, title, all.

A-B •
Repeat sequence.

RANDOM •
Plays tracks in random order.

TITLE
Displays the discs Title menu, if available.

◀ ▶ ▲ ▼ (left/right/up/down)
Selects an item in the menu.

DISPLAY
Accesses On-Screen display

ZOOM •
Enlarges video image.

MARKER •
Marks any point during playback.

SEARCH •
Displays MARKER SEARCH menu.

NEXT DISC •
Moves to the next available disc tray.

PAUSE/STEP (II) •
Pauses playback temporarily/ press repeatedly for frame-by-frame playback.

Reverse SLOW (◀) •
Reverse slow playback.

Forward SLOW (▶) •
Forward slow playback.

CLEAR
Removes a track number on the program menu or a mark on the MARKER SEARCH menu.

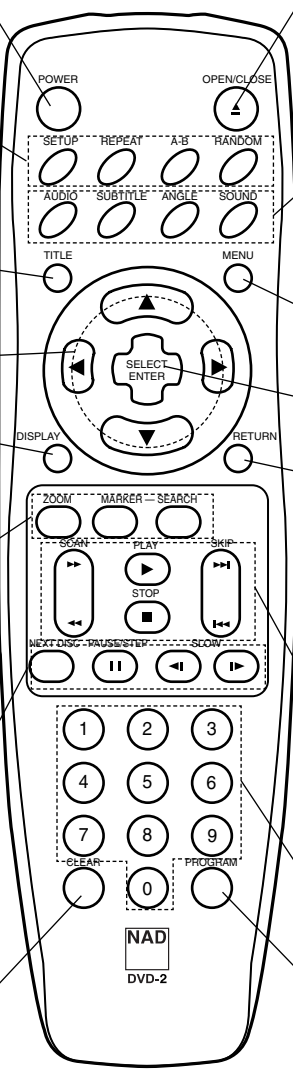

OPEN/CLOSE
Opens and closes the disc tray.

• AUDIO
Selects an audio language (DVD) or an audio channel (CD).

• SUBTITLE
Selects a subtitle language.

• ANGLE
Selects a DVD camera angle if available.

• SOUND
Selects sound mode during disc playback.

MENU
Accesses menu on a DVD disc.

SELECT/ENTER
Acknowledges menu selection.

RETURN
- Removes the setup menu.
- Displays the menu of a video CD with PBC.

• SCAN (◀◀ / ▶▶)
Press for fast reverse search or forward search.

• PLAY (▶)
Starts playback.

• STOP (■)
Stops playback.

• SKIP (◀◀ / ▶▶)
Moves to PREVIOUS or NEXT chapter/track.

0-9 number buttons
Selects numbered items in a menu.

PROGRAM
Accesses or removes program menu.

Remote Control Operation Range

Point the remote control at the remote sensor and press the buttons.

- **Distance:** About 23 ft (7 m) from the front of the remote sensor
- **Angle:** About 30° in each direction of the front of the remote sensor

Remote control battery installation

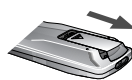

Detach the battery cover on the rear of the remote control, and insert two R03 (size AAA) batteries with ⊕ and ⊖ aligned correctly.



⚠ Caution
Do not mix old and new batteries. Never mix different types of batteries (standard, alkaline, etc.).



Rear Panel

TO TV (SCART) Jack
Connect to a TV with SCART jack.

VIDEO OUTPUT Switch
Select either S-VIDEO OUT or SCART's RGB signal, depending on how you connected the DVD Player to the TV.

S-VIDEO OUT
Connect to a TV with S-Video inputs.

VIDEO OUT
Connect to a TV with video inputs.

***System Select switch**

12V TRIGGER IN
By connecting this DVD player to another NAD audio component or system controller equipped with a 12V trigger output, you can remotely operate the T572 power ON/OFF.

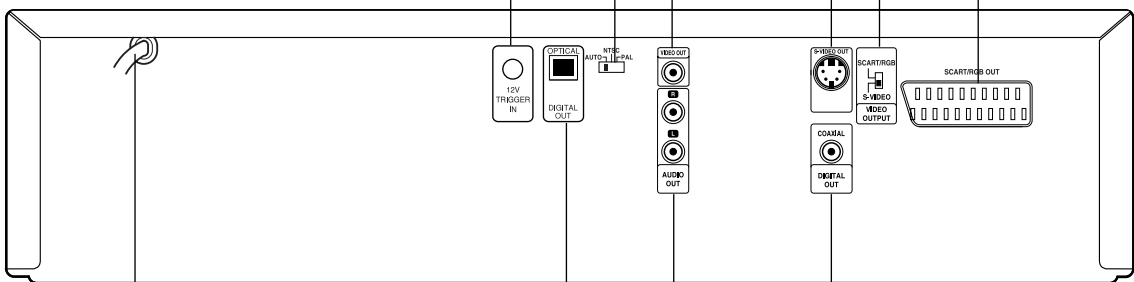

AC Power Cord
Plug into the power source.

OPTICAL (Digital audio out jack)
Connect to digital (optical) audio equipment.

ANALOG AUDIO OUT (Left/Right)
Connect to an amplifier, receiver or stereo system.

COAXIAL (Digital audio out jack)
Connect to digital (coaxial) audio equipment.

Dust protection cap

Remove the dust protection cap from the OPTICAL DIGITAL OUT jack and connect the optical digital cable (not supplied) securely so that the configurations of both the cable and the connector match. Keep the dust protection cap and always reattach the cap when not using the connector to protect against dust intrusion.

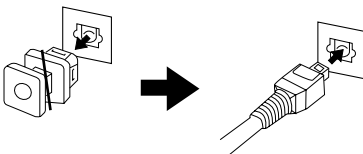

Do not touch the inner pins of the jacks on the rear panel. Electrostatic discharge may cause permanent damage to the unit.

* System Select switch

You can enjoy NTSC or PAL discs by using System Select switch to choose the appropriate system.

PAL: Select when DVD player is connected with PAL-TV.

NTSC: Select when DVD player is connected with NTSC-TV.

AUTO: Select when DVD player is connected with Multi system TV.

- When the selected System Select switch does not coincide with the system of your TV, normal color picture may not be displayed.
- Set System Select switch when the power is turned off.

Connections

Tips

- Depending on your TV and other equipment you wish to connect, there are various ways you could connect the player. Use only one of the connections described below.
- Please refer to the manuals of your TV, VCR, Stereo System or other devices as necessary to make the best connections.
- For better sound reproduction, connect the player's AUDIO OUT jacks to the audio in jacks of your amplifier, receiver, stereo or audio/video equipment. See "Connecting to optional equipment" on page 10.

Caution

- Make sure the DVD Player is connected directly to the TV. Select the TV to the corresponding video input.
- Do not connect the DVD Player's AUDIO OUT jack to the phono in jack (Turntable) of your audio system.
- Do not connect your DVD Player via your VCR. The DVD image could be distorted by the copy protection system.

Connecting to a TV

- Make one of the following connections, depending on the capabilities of your existing equipment.
- When using the SCART's RGB signal, set the Video Output Select switch to COMPONENT. When using the S-VIDEO OUT jack, set the Video Output Select switch to S-VIDEO.

Video connection (Good)

1 Connect the VIDEO OUT jack on the DVD Player to the video in jack on the TV using the video cable supplied (**V**).

2 Connect the Left and Right AUDIO OUT jacks of the DVD Player to the audio left/right in jacks on the TV (**A**) using the supplied audio cables.

S-Video connection (Better)

1 Connect the S-VIDEO OUT jack on the DVD Player to the S-Video in jack on the TV using an optional S-Video cable (**S**).

2 Connect the Left and Right AUDIO OUT jacks of the DVD Player to the audio left/right in jacks on the TV (**A**) using the supplied audio cables.

SCART connection

Connect the TO TV scart jack on the DVD Player to the corresponding in jacks on the TV using the scart cable (**T**).

Note

For using SCART's RGB signal, set the Video Output Select switch to "COMPONENT".

Rear of TV

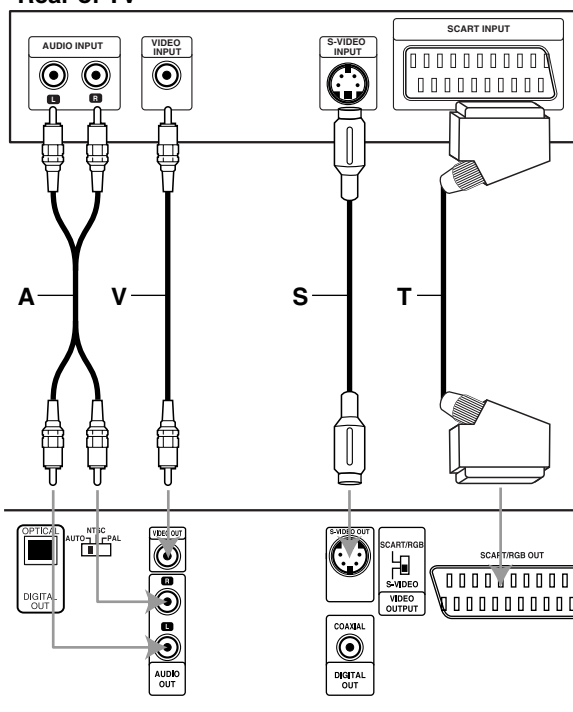

Rear of DVD player

Note

If the TV has an S-video input, connect the DVD player with the S-video cable. When using an S-video cable, do not connect the yellow video cable.

Connections (Continued)

Connecting to Optional Equipment

Connecting to an amplifier equipped with two channel analog stereo or Dolby Surround

Connect the Left and Right AUDIO OUT jacks on the DVD Player to the audio left and right in jacks on your amplifier, receiver or stereo system, using the supplied audio cables (A).

Connecting to an amplifier equipped with two channel digital stereo (PCM) or to an Audio/Video receiver equipped with a multi-channel decoder (Dolby Digital™, MPEG 2 or DTS)

1 Connect one of the DVD Player's DIGITAL AUDIO OUT jacks (OPTICAL O or COAXIAL X) to the corresponding in jack on your amplifier. Use an optional digital (optical O or coaxial X) audio cable.

2 You will need to activate the player's digital output. (See "Digital Audio Output" on page 13).

T Digital Multi-channel sound

A digital multi-channel connection provides the best sound quality. For this you need a multi-channel Audio/Video receiver that supports one or more of the audio formats supported by your DVD Player (MPEG 2, Dolby Digital and DTS). Check the receiver manual and the logos on the front of the receiver.

N Notes

- If the audio format of the digital output does not match the capabilities of your receiver, the receiver will produce a strong, distorted sound or no sound at all.
- Six Channel Digital Surround Sound can only be obtained if your receiver is equipped with a Digital Multi-channel surround sound decoder.
- To confirm the audio format of the current DVD selection display, press AUDIO.
- Repeated pressing of the AUDIO button may allow you to select between various audio formats available on the disc.

Rear of DVD player

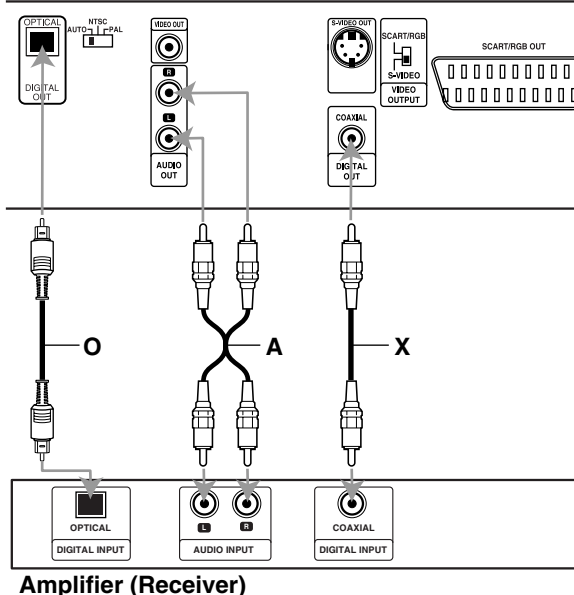

N Note

This player does not perform internal (2 channel) decoding of a DTS sound track. To enjoy DTS multi channel surround, you must connect this player to a DTS compatible receiver via one of this player's digital audio outputs.

Before Operation

General Explanation

This manual gives basic instructions for operating the DVD Player. Some DVDs require specific operation or allow only limited operation during playback. When this occurs, the symbol  appears on the TV screen, indicating that the operation is not permitted by the DVD Player or is not available on the disc.









On-Screen Display

General playback status can be displayed on the TV screen. Some items can be changed on the menu.

On-screen display operation

- 1** Press DISPLAY during playback.
- 2** Press ▲ or ▼ to select an item.
The selected item will be highlighted.
- 3** Press ◀ or ▶ to change the setting of an item.
The number buttons can be also be used for setting numbers (e.g., title number). For some functions, press SELECT/ENTER to execute the setting.







Repeat mode Icons

-  Repeat Title
-  Repeat Chapter
-  Repeat Track (non-PBC Video CDs and Audio CD only)
-  Repeat All Tracks (non-PBC Video CDs and Audio CD only)
-  Repeat A-B
-  Repeat Off
-  Resume play from this point
-  Action prohibited or not available





Notes

- Some discs may not provide all of the features included on the on-screen display example shown below.
- If no button is pressed for 10 seconds, the on-screen display disappears.

DVD

Items		Function (Press ▲/▼ to select desired item)	Selection Method
Title Number	 1/3	Displays the current title number and total number of available titles, and skips to a desired title number.	◀ / ▶, or Numbers, SELECT/ENTER
Chapter Number	 1/12	Displays the current chapter number and total number of available chapters, and skips to a desired chapter number.	◀ / ▶, or Numbers, SELECT/ENTER
Time search	 0:16:57	Displays the elapsed playing time, and searches a point identified by its elapsed time.	Numbers, SELECT/ENTER
Audio language and Digital Audio Output mode	 1 ENG □□□ 6 CH	Displays the current audio soundtrack language, encoding method and channel number, and any changes you make to the setting.	◀ / ▶
Subtitle language	 OFF	Displays the current subtitles language, and any changes you make to the setting.	◀ / ▶
Angle	 1/1	Displays the current angle number and total number of angles, and any changes you make to the angle number.	◀ / ▶
Sound	 NORM.	Displays the current sound mode, and any changes you make to the setting.	◀ / ▶

VCD2.0 VCD1.1 CD

Items		Function (Press ▲/▼ to select desired item)	Selection Method
Track Number	 1/4	Displays the current track number, total number of tracks and PBC On mode, and skips to the desired track number.	◀ / ▶, or Numbers, SELECT/ENTER
Time	 0:16:57	Displays the elapsed playing time (Display only)	-
Audio Channel	 STER.	Displays the audio channel, and changes you make to the audio channel.	◀ / ▶
Sound	 NORM.	Displays the current sound mode, and any changes you make to the setting.	◀ / ▶

Before Operation (Continued)

Initial Settings

You can install your own Personal Preferences.

Initial Settings General Operation

- 1 Press SETUP.**
The setup menu appears.



- 2 Press ▲/▼ to select the desired item.**
The screen will display the current setting for the selected item, as well as alternate setting(s).
- 3 While the desired item is displayed, press ►, then ▲/▼ to select the desired setting.**
- 4 Press SELECT/ENTER to confirm your selection.**
Some items require additional steps.
- 5 Press SETUP, RETURN or PLAY to exit the setup menu.**

Language

Disc Language **DVD**

Select a language for the disc's Menu, Audio and Subtitle.

Original : The original language included on the disc is selected.

Other : To select another language, enter the 4-digit number corresponding to the language code list on page 24. If you enter the wrong language code, press CLEAR.



Menu Language

Select a language for the setup menu. This is the menu you see when you press SETUP.

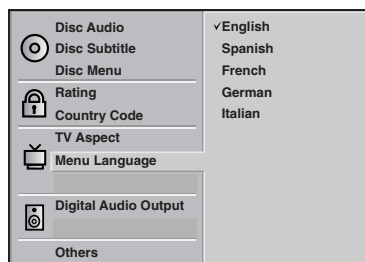

Picture

TV Aspect **DVD**

4:3 Letterbox: Select when a standard 4:3 TV is connected. Displays theatrical images with masking bars above and below the picture.

4:3 Panscan: Select when a standard 4:3 TV is connected. Displays pictures cropped to fill your TV screen. Both side of the original picture may be cut off.

16:9 Wide: Select when a 16:9 wide TV is connected.

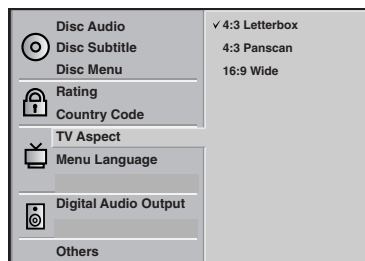

Before Operation (Continued)

Sound

Digital Audio Output

Each DVD disc may have a variety of audio output options. Set the player's Digital Audio Output according to the type of audio system you use.

DOLBY DIGITAL/PCM: Select "DOLBY DIGITAL/PCM" if you connect the DVD Player's DIGITAL OUT jack to a Dolby Digital decoder (or an amplifier or other equipment with a Dolby Digital decoder).

Stream/PCM: Select "Stream/PCM" if you connect the DVD Player's DIGITAL OUT jack to an amplifier or other equipment with a DTS decoder, Dolby Digital decoder or MPEG decoder.

PCM: Select when connected to a 2 channel digital stereo amplifier. The DVD player outputs sounds in the PCM 2ch format when you play a DVD video disc recorded on the Dolby Digital, MPEG1 or MPEG2 recording system.

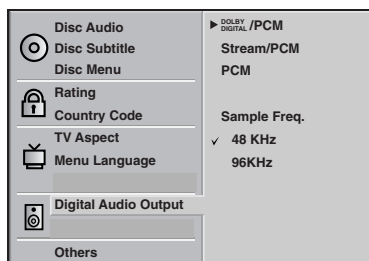

Sample Frequency

To change the Sample Frequency setting, first select the desired Digital Audio Output as indicated above. If your receiver or amplifier is NOT capable of handling 96KHz signals, select 48KHz. When this choice is made, this unit will automatically convert any 96KHz signals to 48KHz so your system can decode them. If your receiver or amplifier is capable of handling 96KHz signals, select 96KHz. When this choice is made, this unit will pass all signals through without down conversion, or processing.

Others

The DRC, Vocal and PBC settings can be changed.

- Press ▲/▼ to select the desired item and press SELECT/ENTER. The setting of the selected item alternates between On and Off.

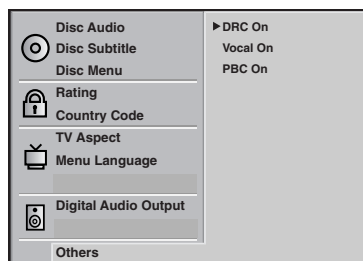

Dynamic Range Control (DRC)

With the DVD format, you can hear a program's soundtrack in the most accurate and realistic presentation possible, thanks to digital audio technology. However, you may wish to compress the dynamic range of the audio output (the difference between the loudest sounds and the quietest ones). Then, you may listen to a movie at a lower volume without losing clarity of sound. Set DRC to On for this effect.

Vocal

Set Vocal to On only when a multi-channel karaoke DVD is playing. The karaoke channels on the disc will mix into normal stereo sound.

PBC

Set Playback Control (PBC) to On or Off.

On: Video CDs with PBC are played according to the PBC.

Off: Video CDs with PBC are played the same way as Audio CDs.

Before Operation (Continued)

Parental Control

Rating **DVD**

Movies on DVDs may contain scenes not suitable for children. Therefore, discs may contain Parental Control information that applies to the complete disc or to certain scenes on the disc. These scenes are rated from 1 to 8, and alternatively, more suitable scenes are available for selection on some discs. Ratings are country-dependent. The Parental Control feature allows you to prevent discs from being played by your children or to have certain discs played with alternative scenes.

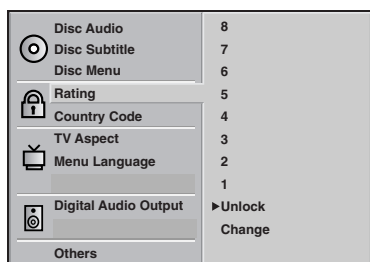

1 Select "Rating" on the Setup menu using the ▲ and ▼ buttons.

2 While "Rating" is displayed, press ▶.

3 When you have not entered a password yet; Install a 4-digit password using the number buttons to create a personal 4-digit security password, then press SELECT/ENTER. Enter the 4-digit password again and press SELECT/ENTER to verify.
When you have already entered a password; Install your 4-digit password using the number buttons to confirm the personal 4-digit security password, then press SELECT/ENTER.

If you make a mistake before pressing SELECT/ENTER, press CLEAR and install your 4-digit security password again.

4 Select a rating from 1 to 8 using the ▲/▼ buttons. One (1) has the least playback restrictions. Eight (8) has the most playback restrictions.

Unlock: If you select Unlock, Parental Control is not active. The disc will play without restrictions.
Ratings 1 to 8: Some discs contain scenes not suitable for children. If you set a rating for the player, all disc scenes with the same rating or lower will be played. Higher rated scenes will not be played unless an alternative scene is available on the disc. The alternative must have the same rating or a lower one. If no suitable alternative is found, playback will stop. You must enter your 4-digit password or change the rating level in order to play the disc.

5 Press SELECT/ENTER to confirm your rating selection, then press SETUP to exit the menu.

Country Code **DVD**

Enter the code of a country/area whose standards were used to rate the DVD video disc, referring to the list (See "Country Code List", page 25.).

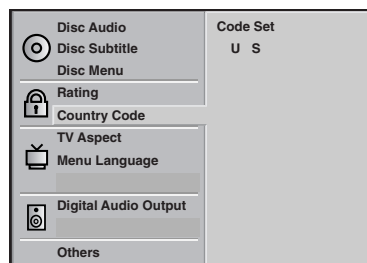

1 Select Country Code using the ▲/▼ buttons on the setup menu.

2 While Country Code is selected, press ▶.

3 Follow step 3 of "Rating" on left.

4 Select the first character using the ▲/▼ buttons.

5 Shift the cursor using ◀▶ buttons and select the second character using ▲/▼ buttons.

6 Press SELECT/ENTER to confirm your country code selection, then press SETUP to exit the menu.

Note

Confirmation of your 4-digit password is necessary when the code is changed (see "Changing the 4-digit code" below).

Changing the 4-digit code

- 1 Follow Steps 1-2 as shown above to the left (Rating).
- 2 Install your old code, then press SELECT/ENTER.
- 3 Select Change using the ▲/▼ buttons then press SELECT/ENTER.
- 4 Install the new 4-digit code, then press SELECT/ENTER.
- 5 Install exactly the same code a second time and verify by pressing SELECT/ENTER.
- 6 Press SETUP to exit the menu.

If you forget your 4-digit code

If you forget your password, to clear the current password, follow the procedure below.

- 1 Press SETUP to display the setup menu.
- 2 Use the Number buttons to enter the 6-digit number "210499."
The 4-digit password is cleared. "P CLR" appears on the display. The message will appear if the disc tray is closed. It will be on the display until you try another feature.
- 3 Enter a new code as shown above to the left (Rating).

Playing a DVD, Video CD and Audio CD

Playback Setup **DVD** **VCD2.0** **VCD1.1** **CD**

- Turn on the TV and select the video input source corresponding to the DVD player.
- Audio system: Turn on the audio system and select the input source connected to the DVD player.

1 Press OPEN/CLOSE to open the disc tray.

2 Load your disc in the tray, with the label facing up.

When a double-sided DVD is inserted, make sure the side you want to play is facing down.

- Discs can be loaded one at a time by pressing NEXT DISC to rotate the carousel.

3 Press OPEN/CLOSE to close the tray. READING appears on the TV screen, and playback starts automatically. If playback does not start, press PLAY.

In some cases, the disc menu may appear instead.

If a disc menu screen is displayed

The menu screen may be displayed first after loading a DVD or Video CD that contains a menu.

DVD

Use the ◀ ▶ ▲ ▼ buttons to select the title/chapter and additional selections you want, then press SELECT/ENTER to start playback. Press TITLE or MENU to return to the disc menu screen.

VCD2.0

- Use the number buttons to select the track you want to view. Press RETURN to return to the disc menu screen.
- Menu setting and the exact operating procedures for using the disc menu may differ depending on the disc. Follow the instructions on each menu screen. You also may set PBC to Off under setup. See page 13.

Notes

- If Parental Control is set and the disc is not within the Rating settings (not authorized), the 4-digit code must be entered and/or the disc must be authorized (see “Parental Control”, on page 14).
- DVDs may have a region code.
- Your player will not play discs that have a region code different from your player. The region code for this player is 2 (two).

Exchanging discs during playback

- Press OPEN/CLOSE on the front panel during playback to open the disc tray.
- Press NEXT DISC to rotate the disc trays to the desired position. The carousel will rotate clockwise by one disc increments.
- Exchange the discs and press OPEN/CLOSE to close the disc tray.

Note

- The disc tray presently loaded in the play position can not be exchanged.

Skipping discs

Press NEXT DISC during play or when playback is stopped.

Notes

- When NEXT DISC is pressed, the disc tray rotates and playback begins from the beginning of the next disc.
- If there is no disc on the next disc tray, the following disc tray will be selected.
- When NEXT DISC is pressed during playback of disc 5, playback of disc 1 will start.

Exchanging the disc and starting playback

1. Press OPEN/CLOSE during playback or when playback is stopped. Play stops (if pressed during playback), the disc tray opens and the disc that was in the play position comes to the front.
2. Exchange the disc.
3. Press OPEN/CLOSE or PLAY again. The tray closes and playback begins (with the disc that was in front).

Operation with DVD, Video CD and Audio CD (Continued)

General Features

Note

Unless stated otherwise, all operations described use the remote control. Some features may also be available from the Setup menu.

Moving to another TITLE





When a disc has more than one title, you can select to another title as follows:

- Press DISPLAY when playback is stopped. From the title function, press the appropriate numbered button (0-9) to select a title number.

Moving to another CHAPTER/TRACK



When a title on a disc has more than one chapter or a disc has more than one track, you can move to another chapter/track as follows:

- Press SKIP  or  briefly during playback to select the next chapter/track or to return to the beginning of the current chapter/track.
- Press SKIP  twice briefly to step back to the previous chapter/track.
- To go directly to any chapter during DVD playback, press DISPLAY. Then, press / to select C (chapter) (or for a Video CD and Audio CD, select T for track). Then, enter the chapter/track number using the numbered buttons (0-9).

Note

For two-digit numbers, press the buttons in rapid succession.

Still Picture and Frame-by-frame playback















- 1 Press PAUSE/STEP during playback.
The player will now go into PAUSE mode.
- 2 You can advance the picture frame by frame by pressing PAUSE/STEP repeatedly on the remote control.

Pause

- 1 Press PAUSE/STEP during playback.
- 2 To return to playback, press PLAY or press PAUSE/STEP again.



















Slow Motion

- 1 Press SLOW  or  during playback.
The player will enter SLOW mode.
- 2 Use the SLOW  or  to select the required speed:  1/16,  1/8,  1/4 or  1/2 (reverse), or  1/16,  1/8,  1/4 or  1/2 (forward).
- 3 To exit slow motion mode, press PLAY.

Note

Slow motion playback in reverse is not available from a Video CD.



Search

- 1 Press SCAN  or  during playback.
The player will now go into SEARCH mode.
- 2 Press SCAN  or  repeatedly to select the required speed: X2, X4, X16, X100 (backward) or X2, X4, X16, X100 (forward).
With a Video CD and Audio CD, the Search speed changes: X2, X4, X8 (backward) or X2, X4, X8 (forward).
- 3 To exit SEARCH mode, press PLAY.

Random

- 1 Press RANDOM during playback or in stop mode.
The unit automatically begins Random Playback and "RANDOM (1-3)" appears on the TV screen.
 - RANDOM1: Plays all the tracks on a single disc in random order and then stops.
 - RANDOM2: Plays all the tracks on current disc in random order and then plays all the tracks on each succeeding disc in random order and then stops.
 - RANDOM3: Plays 2 tracks randomly from a disc and then plays 2 tracks randomly from a different disc until all tracks on all discs have been played.
- 2 To return to normal playback, press RANDOM until "RANDOM" disappears on the display window.

Tip

By pressing SKIP  or  during Random playback, the unit selects another title (track) and resumes Random playback.

Note

This function works only with Compact Discs, Karaoke discs and video CD without PBC.

Operation with DVD, Video CD and Audio CD (Continued)

General Features (cont'd)

Repeat



DVD Video Discs - Repeat Chapter/Title/Off

- 1 To repeat the chapter currently playing, press REPEAT. The Repeat Chapter icon appears on the TV screen.
- 2 To repeat the title currently playing, press REPEAT a second time. The Repeat Title icon appears on the TV screen.
- 3 To exit Repeat mode, press REPEAT a third time. The Repeat Off icon appears on the TV screen.

Video CDs and Audio CDs - Repeat Track/Disc/All/Off

- 1 To repeat the track currently playing, press REPEAT. The Repeat Track icon appears on the TV screen.
- 2 To repeat the disc currently playing, press REPEAT a second time. The Repeat Disc icon appears on the TV screen.
- 3 To Repeat of entire all disc contents, press REPEAT a third time. The Repeat All icon appears on the TV screen.
- 4 To exit Repeat mode, press REPEAT a fourth time. The Repeat Off icon appears on the TV screen.

Note

On a Video CD with PBC, you must set PBC to Off on the setup menu to use the Repeat function. See page 13.

Repeat A-B



To repeat a sequence in a title:

- 1 Press A-B at your chosen starting point. A- appears briefly on the TV screen.
- 2 Press A-B again at your chosen end point. A-B appears briefly on the TV screen, and the repeat sequence begins (a-b repeat appears on the player's display).
- 3 To cancel the sequence, press A-B.

Time Search 0:16:57

The Time Search function allows you to start playing at any elapsed time location on the disc.

- 1 Press DISPLAY during playback. The on-screen display appears on the screen. The Time Search box shows the elapsed playing time of the current disc.
- 2 Within 10 seconds, press ▲/▼ to select the Time Search icon in the on-screen display. The “-:-:-:-” appears in the Time Search box.
- 3 Within 10 seconds, use the number buttons to enter the required start time. Enter hours, minutes and seconds from left to right in the box. If you enter the wrong numbers, press CLEAR to remove the numbers you entered. Then enter the correct numbers.
- 4 Within 10 seconds, press SELECT/ENTER to confirm the start time. Playback starts from the selected time on the disc. If you enter an invalid time, playback will continue from the current point.

3D Surround

This unit can produce a 3D Surround effect, which simulates multi-channel audio playback from two conventional stereo speakers, instead of the five or more speakers normally required to listen to multi-channel audio from a home theater system.

- 1 Press SOUND to select “3D SUR” during playback.
- 2 To turn off the 3D Surround effect, press SOUND again to select “NORM”.

Zoom

The Zoom function allows you to expand the video image and to move the focus point of zoomed image.

- 1 Press ZOOM during playback or still playback to activate the Zoom function. If you press ZOOM repeatedly, the magnification level increases up to six times.
- 2 Use the ◀▶/▲/▼ buttons to move the focus point off the zoomed image.
- 3 Press CLEAR to resume normal playback or return to the paused image.

Notes

- The zoom function may not work for some DVDs.
- The zoom function may not work on multi-angle scenes.

Operation with DVD, Video CD and Audio CD (Continued)

General Features (cont'd)

Marker Search **DVD** **VCD2.0** **VCD1.1** **CD**



You can start playback from a memorized point. Up to nine points can be memorized.

To enter a mark, follow these steps.

- 1 During disc playback, press MARKER at the location you want to memorize.

The Marker icon will appear on the TV screen briefly.

- 2 Repeat step 1 to enter up to nine Marker points on a disc.

To Recall a Marked Scene

- 1 During disc playback, press SEARCH.
The MARKER SEARCH menu will appear on the screen.
- 2 Within 10 seconds, press ◀▶ to select a Marker number that you want to recall.
- 3 Press SELECT/ENTER.
Playback will start from the Marked scene.
- 4 To remove the MARKER SEARCH menu, press SEARCH.

To clear a Marked Scene

- 1 During disc playback, press SEARCH.
The MARKER SEARCH menu will appear on the screen.
- 2 Press ◀▶ to select the Marker number that you want to erase.
- 3 Press CLEAR.
The Marker number will be erased from the list.
- 4 Repeat steps 2 and 3 to erase additional Marker numbers.
- 5 To remove the MARKER SEARCH menu, press SEARCH.

Note

All disc markers are cleared when the power is turned off or the disc is removed.

Special DVD Features **DVD**

Checking the contents of DVD Video discs: Menus

DVDs may contain menus that allow you to access special features. To access the disc menu, press MENU.

Then, press the appropriate number button to select an option. Or, use the ◀▶/▲/▼ buttons to highlight your selection, then press SELECT/ENTER.

Title Menu **DVD**

- 1 Press TITLE.
If the current title has a menu, that menu will appear on the screen. Otherwise, the disc menu may appear.
- 2 The menu can list camera angles, spoken language and subtitle options, and chapters for the title.
- 3 To remove the title menu, press TITLE again.

Disc Menu **DVD**

- 1 Press MENU.
The disc menu is displayed.
- 2 To exit the disc menu, press MENU again.

Camera Angle **DVD**

If the disc contains scenes recorded at different camera angles, you can change to a different camera angle during playback.

- Press ANGLE repeatedly during playback to select a desired angle.
The number of the current angle appears on the display.

Changing the Audio Language **DVD**



Press AUDIO repeatedly during playback to hear different audio languages or audio tracks available on the disc.

Changing the Audio Channel

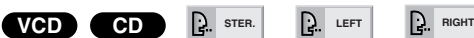

Press AUDIO repeatedly during playback to hear a different audio channel (STEREO, LEFT or RIGHT).

Subtitles **DVD**

Press SUBTITLE repeatedly during playback to view the different subtitle languages available on the disc.

Note

If  appears, the feature is not available on the disc.

Programmed Playback with Video CD and Audio CD

Programmed Playback with Video CD and Audio CD

N Note

On a Video CD with PBC, you must set PBC to Off on the setup menu to use the Program function. See page 13.

1 Insert a Video CD or Audio CD and close the tray.

2 Press PROGRAM while playback is stopped. The Program menu will appear.

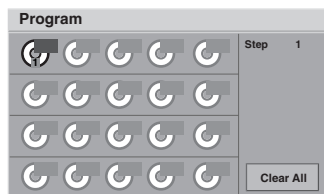

N Note

Press PROGRAM or RETURN to exit the Program menu.

3 Enter the disc number using the numerical keys (1-5) and then press SELECT/ENTER.

4 Enter the track number using the numerical keys (0-9) and then press SELECT/ENTER. The next area is selected.

5 Repeat steps 3 to 4. Up to 20 tracks can be programmed.

6 Press PLAY to exit the menu. The selected tracks are stored in the player memory and playback begins with the first programmed sequence.

7 After playback of all programmed tracks is completed, playback is stopped

T Tip

After playback of all programmed tracks is completed, playback is stopped.

Repeat Programmed Tracks/All

- To repeat the track currently playing, press REPEAT. The Repeat Track icon appears on the menu screen.
- To repeat all tracks on the program list, press REPEAT a second time. The Repeat All icon appears on the menu screen.
- To cancel Repeat mode, press REPEAT a third time. The Repeat Off icon appears on the menu screen.

To resume normal playback from programmed playback

Press and hold PROGRAM until "PROG." indicator disappears in the display window.

Erasing a Track from Program List

- 1 Press PROGRAM while playback is stopped. The Program menu will appear.
- 2 Use ◀▶/▲▼ to select the track that you wish to erase from the Program list.
- 3 Press CLEAR. The track will be erased from the Program list.

Erasing the Complete Program List

- 1 Press PROGRAM while playback is stopped. The Program menu will appear.
- 2 Use ◀▶/▲▼ to select "Clear All", then press SELECT/ENTER. The complete Program for the disc will be erased. The programs are also cleared when the disc is removed.

Operation with MP3 Disc

Playing an MP3 disc

The DVD Player can play MP3 formatted recordings on CD-ROM, CD-R or CD-RW discs.

Before playing MP3 recordings, read the notes on MP3 Recordings on right.

- 1** Insert a disc and close the tray.
The menu appears on the TV screen.

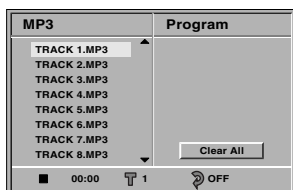

MP3 menu

- 2** Press ▲/▼ to select a track then press PLAY.
Playback starts.
During playback, the current track's elapsed playing time will appear on the display.
Playback will stop at the end of the disc.

- 3** To stop playback at any other time, press STOP.

Pause **MP3**

- 1 Press PAUSE/STEP during playback.
- 2 To return to playback, press PLAY or press PAUSE/STEP again.

Moving to another Track **MP3**

- Press SKIP ◀◀ or ▶▶ once during playback to advance to the next track or to return to the beginning of the current track.
- Press SKIP ◀◀ twice briefly to step back to the previous track.

Repeat Track/All/Off **MP3**

- 1 To repeat the track currently playing, press REPEAT.
The Repeat Track icon appears on the menu screen.
- 2 To repeat all tracks on a disc, press REPEAT a second time.
The Repeat All icon appears on the menu screen.
- 3 To cancel Repeat mode, press REPEAT a third time.
The Repeat Off icon appears on the menu screen.

Notes on MP3 Discs

About MP3

- An MP3 file is audio data compressed by using the MPEG1 audio layer-3 file-coding scheme. We call files that have the ".mp3" file extension "MP3 files".
- The player can not read an MP3 file that has a file extension other than ".mp3".
- The player can not read a non MP3 encoded file that has a file extension ".mp3".

MP3 Disc compatibility with this player is limited as follows:

1. Sampling Frequency / only at 44.1kHz
2. Bit rate / within 32 - 320kbps
3. CD-R physical format should be "ISO 9660"
4. If you record MP3 files using the software which cannot create a FILE SYSTEM, for example "Direct-CD" etc., it is impossible to playback MP3 files. We recommend that you use "Easy-CD Creator", which creates an ISO9660 file system.
5. A single session disc requires MP3 files in the first track. If there is no MP3 file in the 1st track, it cannot playback MP3 files. If you wish to playback MP3 files, format all the data in the disc or use a new one.
6. We do not recommend using CD-RW discs. Please use finished CD-R discs only.
7. File names should be named using 8 letters or less and must incorporate ".mp3" extension e.g. "*****.MP3".
8. Do not use special letters such as "_?!><+*}{^[@];:;V.," etc.
9. Total number of files on the disc should be less than 200.
10. Use 74 minute CD-R discs (650M), Do not use 80 minute CD-R (700M) software

This DVD player requires discs/recordings to meet certain technical standards in order to achieve optimal playback quality. Pre-recorded DVDs are automatically set to these standards. There are many different types of recordable disc formats (including CD-R containing MP3 files). That require certain pre-existing conditions (see above) to insure compatible playback.

Customers should also note that permission is required in order to download MP3 files and music from the Internet. NAD cannot grant such permission. Permission should always be sought from the copyright owner.

Programmed Playback with MP3 Disc

Programmed Playback with MP3 Disc

Program allows you to store your favorite tracks for a particular disc in the player memory.

Program can contain 60 tracks.

1 Insert the disc and close the tray.

The menu is displayed on the TV screen.

2 Press PROGRAM during playback or in the stop mode to enter the Program Edit mode.

The  mark will appear to the right of the word Program on the right side of the menu screen.

Note

Press PROGRAM to exit the Program Edit mode; the  mark will disappear.

3 Press ▲/▼ to select a track then press SELECT/ENTER to place the selected track on the Program list.

4 Repeat step 3 to place additional tracks on the Program list.

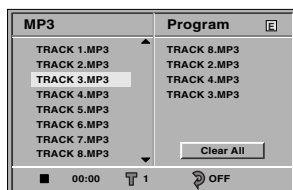

MP3 menu

5 Press ►.

The programmed track you selected last is highlighted on the program list.

6 Press ▲/▼ to select the track you want to start playing.

Press TITLE to move to the next page.
Press MENU to move to the previous page.

7 Press PLAY to start.

Playback begins in the order in which you programmed the tracks and "PROG." appears in the display window.
Playback stops after all of the tracks on the Program list have played once.

Note

The programmed tracks are cleared when the power is turned off or the disc is removed.

Repeat Programmed Tracks/All

- To repeat the track currently playing, press REPEAT. The Repeat Track icon appears on the menu screen.
- To repeat all tracks on the program list, press REPEAT a second time. The Repeat All icon appears on the menu screen.
- To cancel Repeat mode, press REPEAT a third time. The Repeat Off icon appears on the menu screen.

Erasing a Track from Program List

- 1 Press PROGRAM during playback or in the stop mode to enter the Program Edit mode. The  mark will appear.
- 2 Press ► to move to the Program list.
- 3 Use ▲/▼ to select the track that you wish to erase from the Program list.
- 4 Press CLEAR. The track will be erased from the Program list.

Erasing the Complete Program List

- 1 Follow steps 1-2 of "Erasing a Track from Program List" as above.
- 2 Use ▲/▼ to select "Clear All", then press SELECT/ENTER. The complete Program for the disc will be erased. The programs are also cleared when the disc is removed.

To resume normal playback from programmed playback

Press and hold PROGRAM for 3 seconds until "PROG." indicator disappears in the display window.

Additional Information

Last Condition Memory

DVD **CD** **VCD1.1**

This player memorizes the last condition for the last disc you have watched. Settings remain in memory even if you remove the disc from the player or switch off the player. If you load a disc that has its settings memorized, the latest stop position is automatically recalled.

Notes

- Settings are stored in memory for use any time.
- This player does not memorize settings of a disc if you switch off the player before commencing playback.

Screen Saver

A screen saver image appears when you leave the DVD Player in stop mode for about five minutes.

After the Screen Saver has been engaged for about five minutes, the DVD Player will automatically turn itself off.

Video Mode Setting **DVD** **VCD2.0** **VCD1.1**

- With certain discs, the playback picture may be flickering or Dot Crawl is shown on straight lines. That means Vertical interpolation or De-interlace is not perfectly matched with the disc. In this case, the picture quality may be improved by changing the video mode.
- To change the video mode, press and hold DISPLAY about 3 seconds during disc playback. The new video mode number selected is displayed on the TV screen. Check whether the video quality has improved. If not, repeat the above procedure until picture quality is improved.
- Video mode change sequence:
MODE1 → MODE2 → MODE3 → MODE4 →
MODE5 → MODE1
- If you turn off the power, the video mode will return to initial default state (Auto).

HDCC Playback

HDCC is a process that increases the fidelity of both specially encoded HDCC discs and standard CD audio discs. When an HDCC-encoded disc is playing, the special decoder is automatically activated and the HDCC Indicator lights. No user intervention is required.

To enjoy the benefits of HDCC, your DVD Player must be connected to your A/V receiver via the Analog Audio Outputs. However, if your A/V receiver or surround processor is equipped with built-in HDCC decoding, you may also use a Coaxial or Optical digital audio connection so that the HDCC processing is done there.

Troubleshooting

Check the following guide for the possible cause of a problem before contacting service.

Symptom	Cause	Correction
No power.	<ul style="list-style-type: none"> The power cord is disconnected. 	<ul style="list-style-type: none"> Plug the power cord into the wall outlet securely.
The power is on, but the DVD player does not work.	<ul style="list-style-type: none"> No disc is inserted. 	<ul style="list-style-type: none"> Insert a disc. (Check that the DVD or, audio CD indicator in the display window is lit.)
No picture.	<ul style="list-style-type: none"> The TV is not set to receive DVD signal output. 	<ul style="list-style-type: none"> Select the appropriate video input mode on the TV so the picture from the DVD player appears on the TV screen.
	<ul style="list-style-type: none"> The video cable is not connected securely. 	<ul style="list-style-type: none"> Connect the video cable into the jacks securely.
	<ul style="list-style-type: none"> The connected TV power is turned off. 	<ul style="list-style-type: none"> Turn on the TV.
No sound.	<ul style="list-style-type: none"> The equipment connected with the audio cable is not set to receive DVD signal output. 	<ul style="list-style-type: none"> Select the correct input mode of the audio receiver so you can listen to the sound from the DVD player.
	<ul style="list-style-type: none"> The audio cables are not connected securely. 	<ul style="list-style-type: none"> Connect the audio cable into the jacks securely.
	<ul style="list-style-type: none"> The power of the equipment connected with the audio cable is turned off. 	<ul style="list-style-type: none"> Turn on the equipment connected with the audio cable.
	<ul style="list-style-type: none"> The Digital Audio Output is set to the wrong position. 	<ul style="list-style-type: none"> Set the Digital Audio Output to the correct position, then turn on the DVD player again by pressing POWER.
The playback picture is poor.	<ul style="list-style-type: none"> The disc is dirty. 	<ul style="list-style-type: none"> Clean the disc.
The DVD player does not start playback.	<ul style="list-style-type: none"> No disc is inserted. 	<ul style="list-style-type: none"> Insert a disc. (Check that the DVD, or audio CD indicator in the DVD display is lit.)
	<ul style="list-style-type: none"> An unplayable disc is inserted. 	<ul style="list-style-type: none"> Insert a playable disc. (Check the disc type, color system and Regional code.)
	<ul style="list-style-type: none"> The disc is placed upside down. 	<ul style="list-style-type: none"> Place the disc with the playback side down.
	<ul style="list-style-type: none"> The disc is not placed within the guide. 	<ul style="list-style-type: none"> Place the disc on the disc tray correctly inside the guide.
	<ul style="list-style-type: none"> The disc is dirty. 	<ul style="list-style-type: none"> Clean the disc.
	<ul style="list-style-type: none"> The Rating level is set. 	<ul style="list-style-type: none"> Cancel the Rating function or change the rating level.
The remote control does not work properly.	<ul style="list-style-type: none"> The remote control is not pointed at the remote sensor of the DVD player. 	<ul style="list-style-type: none"> Point the remote control at the remote sensor of the DVD player.
	<ul style="list-style-type: none"> The remote control is too far from the DVD player. 	<ul style="list-style-type: none"> Operate the remote control within about 23 ft (7 m).
	<ul style="list-style-type: none"> There is an obstacle in the path of the remote control and the DVD player. 	<ul style="list-style-type: none"> Remove the obstacle.
	<ul style="list-style-type: none"> The batteries in the remote control are exhausted. 	<ul style="list-style-type: none"> Replace the batteries with new ones.

Language Code List

Enter the appropriate code number for the initial settings "Disc Audio", "Disc Subtitle" and/or "Disc Menu"
(See page 12).

Code	Language	Code	Language	Code	Language	Code	Language
6565	Afar	7079	Faroese	7678	Lingala	8375	Slovak
6566	Abkhazian	7082	French	7679	Laothian	8376	Slovenian
6570	Afrikaans	7089	Frisian	7684	Lithuanian	8377	Samoan
6577	Ameharic	7165	Irish	7686	Latvian, Lettish	8378	Shona
6582	Arabic	7168	Scots Gaelic	7771	Malagasy	8379	Somali
6583	Assamese	7176	Galician	7773	Maori	8381	Albanian
6588	Aymara	7178	Guarani	7775	Macedonian	8382	Serbian
6590	Azerbaijani	7185	Gujarati	7776	Malayalam	8385	Sudanese
6665	Bashkir	7265	Hausa	7778	Mongolian	8386	Swedish
6669	Byelorussian	7273	Hindi	7779	Moldavian	8387	Swahili
6671	Bulgarian	7282	Croatian	7782	Marathi	8465	Tamil
6672	Bihari	7285	Hungarian	7783	Malay	8469	Telugu
6678	Bengali; Bangla	7289	Armenian	7784	Maltese	8471	Tajik
6679	Tibetan	7365	Interlingua	7789	Burmese	8472	Thai
6682	Breton	7378	Indonesian	7865	Nauru	8473	Tigrinya
6765	Catalan	7383	Icelandic	7869	Nepali	8475	Turkmen
6779	Corsican	7384	Italian	7876	Dutch	8476	Tagalog
6783	Czech	7387	Hebrew	7879	Norwegian	8479	Tonga
6789	Welsh	7465	Japanese	7982	Oriya	8482	Turkish
6865	Danish	7473	Yiddish	8065	Panjabi	8484	Tatar
6869	German	7487	Javanese	8076	Polish	8487	Twi
6890	Bhutani	7565	Georgian	8083	Pashto, Pushto	8575	Ukrainian
6976	Greek	7575	Kazakh	8084	Portuguese	8582	Urdu
6978	English	7576	Greenlandic	8185	Quechua	8590	Uzbek
6979	Esperanto	7577	Cambodian	8277	Rhaeto-Romance	8673	Vietnamese
6983	Spanish	7578	Kannada	8279	Rumanian	8679	Volapük
6984	Estonian	7579	Korean	8285	Russian	8779	Wolof
6985	Basque	7583	Kashmiri	8365	Sanskrit	8872	Xhosa
7065	Persian	7585	Kurdish	8368	Sindhi	8979	Yoruba
7073	Finnish	7589	Kirghiz	8372	Serbo-Croatian	9072	Chinese
7074	Fiji	7665	Latin	8373	Singhalese	9085	Zulu

Country Code List

Enter the appropriate code number for the initial setting "Country Code" (See page 14).

Code	Country	Code	Country	Code	Country	Code	Country
AD	Andorra	ER	Eritrea	LC	Saint Lucia	SC	Seychelles
AE	United Arab Emirates	ES	Spain	LI	Liechtenstein	SD	Sudan
AF	Afghanistan	ET	Ethiopia	LK	Sri Lanka	SE	Sweden
AG	Antigua and Barbuda	FI	Finland	LR	Liberia	SG	Singapore
AI	Anguilla	FJ	Fiji	LS	Lesotho	SH	Saint Helena
AL	Albania	FK	Falkland Islands	LT	Lithuania	SI	Slovenia
AM	Armenia	FM	Micronesia	LU	Luxembourg	SJ	Svalbard and Jan Mayen Islands
AN	Netherlands Antilles	FO	Faroe Islands	LV	Latvia	SK	Slovak Republic
AO	Angola	FR	France	LY	Libya	SL	Sierra Leone
AQ	Antarctica	FX	France (European Territory)	MA	Morocco	SM	San Marino
AR	Argentina	GA	Gabon	MC	Monaco	SN	Senegal
AS	American Samoa	GB	Great Britain	MD	Moldavia	SO	Somalia
AT	Austria	GD	Grenada	MG	Madagascar	SR	Suriname
AU	Australia	GE	Georgia	MH	Marshall Islands	ST	Saint Tome and Principe
AW	Aruba	GF	French Guyana	MK	Macedonia	SU	Former USSR
AZ	Azerbaijan	GH	Ghana	ML	Mali	SV	El Salvador
BA	Bosnia-Herzegovina	GI	Gibraltar	MM	Myanmar	SY	Syria
BB	Barbados	GL	Greenland	MN	Mongolia	SZ	Swaziland
BD	Bangladesh	GM	Gambia	MO	Macau	TC	Turks and Caicos Islands
BE	Belgium	GN	Guinea	MP	Northern Mariana Islands	TD	Chad
BF	Burkina Faso	GP	Guadeloupe (French)	MQ	Martinique (French)	TF	French Southern Territories
BG	Bulgaria	GQ	Equatorial Guinea	MR	Mauritania	TG	Togo
BH	Bahrain	GR	Greece	MS	Montserrat	TH	Thailand
BI	Burundi	GS	S. Georgia & S. Sandwich Isls.	MT	Malta	TJ	Tadjikistan
BJ	Benin	GT	Guatemala	MU	Mauritius	TK	Tokelau
BM	Bermuda	GU	Guam (USA)	MV	Maldives	TM	Turkmenistan
BN	Brunei Darussalam	GW	Guinea Bissau	MW	Malawi	TN	Tunisia
BO	Bolivia	GY	Guyana	MX	Mexico	TO	Tonga
BR	Brazil	HK	Hong Kong	MY	Malaysia	TP	East Timor
BS	Bahamas	HM	Heard and McDonald Islands	MZ	Mozambique	TR	Turkey
BT	Bhutan	HN	Honduras	NA	Namibia	TT	Trinidad and Tobago
BV	Bouvet Island	HR	Croatia	NC	New Caledonia (French)	TV	Tuvalu
BW	Botswana	HT	Haiti	NE	Niger	TW	Taiwan
BY	Belarus	HU	Hungary	NF	Norfolk Island	TZ	Tanzania
BZ	Belize	ID	Indonesia	NG	Nigeria	UA	Ukraine
CA	Canada	IE	Ireland	NI	Nicaragua	UG	Uganda
CC	Cocos (Keeling) Islands	IL	Israel	NL	Netherlands	UK	United Kingdom
CD	Central African Republic	IN	India	NO	Norway	UM	USA Minor Outlying Islands
CG	Congo	IO	British Indian Ocean Territory	NP	Nepal	US	United States
CH	Switzerland	IQ	Iraq	NR	Nauru	UY	Uruguay
CI	Ivory Coast	IR	Iran	NU	Niue	UZ	Uzbekistan
CK	Cook Islands	IS	Iceland	NZ	New Zealand	VA	Vatican City State
CL	Chile	IT	Italy	OM	Oman	VC	Saint Vincent & Grenadines
CM	Cameroon	JM	Jamaica	PA	Panama	VE	Venezuela
CN	China	JO	Jordan	PE	Peru	VG	Virgin Islands (British)
CO	Colombia	JP	Japan	PF	Polynesia (French)	VI	Virgin Islands (USA)
CR	Costa Rica	KE	Kenya	PG	Papua New Guinea	VN	Vietnam
CS	Former Czechoslovakia	KG	Kyrgyzstan	PH	Philippines	VU	Vanuatu
CU	Cuba	KH	Cambodia	PK	Pakistan	WF	Wallis and Futuna Islands
CV	Cape Verde	KI	Kiribati	PL	Poland	WS	Samoa
CX	Christmas Island	KM	Comoros	PM	Saint Pierre and Miquelon	YE	Yemen
CY	Cyprus	KN	Saint Kitts & Nevis Anguilla	PN	Pitcairn Island	YT	Mayotte
CZ	Czech Republic	KP	North Korea	PR	Puerto Rico	YU	Yugoslavia
DE	Germany	KR	South Korea	PT	Portugal	ZA	South Africa
DJ	Djibouti	KW	Kuwait	PW	Palau	ZM	Zambia
DK	Denmark	KY	Cayman Islands	PY	Paraguay	ZR	Zaire
DM	Dominica	KZ	Kazakhstan	QA	Qatar	ZW	Zimbabwe
DO	Dominican Republic	LA	Laos	RE	Reunion (French)		
DZ	Algeria	LB	Lebanon	RO	Romania		
EC	Ecuador			RU	Russian Federation		
EE	Estonia			RW	Rwanda		
EG	Egypt			SA	Saudi Arabia		
EH	Western Sahara			SB	Solomon Islands		

REFERENCE

Specifications

General

Power requirements	AC 120V , 60 Hz
Power consumption	16W
Dimensions (approx.)	430 X 118 X 408 mm (16.9 x 4.7 x 16.1 inches) (w x h x d)
Mass (approx.)	5.7 kg (12.6 lbs)
Operating temperature	5°C to 40°C (41°F to 104°F)
Operating humidity	5 % to 90 %

System

Laser	Semiconductor laser, wavelength 650 nm
Signal system	PAL/NTSC
Frequency response	DVD (PCM 96 kHz): 8 Hz to 44 kHz DVD (PCM 48 kHz): 8 Hz to 22 kHz CD: 8 Hz to 20 kHz
Signal-to-noise ratio	More than 100dB (ANALOG OUT connectors only)
Harmonic distortion	Less than 0.008%
Dynamic range	More than 100 dB (DVD) More than 95 dB (CD)

Outputs

VIDEO OUT	1 Vp-p 75 Ω, sync negative, RCA jack x 1/SCART(TO TV)
S-VIDEO OUT	(Y) 1.0 V (p-p), 75 Ω, negative sync., Mini DIN 4-pin x 1 (C) 0.3 V (p-p) 75 Ω
Audio output (digital audio)	0.5 V (p-p), 75 Ω, RCA jack x 1
Audio output (optical audio)	5 V (p-p), 75 Ω, Optical connector x 1
Audio output (analog audio)	2.0 Vrms (1 KHz, 0 dB), 330 Ω, RCA jack (L, R) x 1/SCART(TO TV)

Accessory

Video cable	1
Audio cable	1
Remote control	1
Batteries	2

- Design and specifications are subject to change without notice.

Manufactured under license from Dolby Laboratories. "Dolby", and the double-D symbol are trademarks of Dolby Laboratories. Confidential unpublished works. Copyright 1992-1997 Dolby Laboratories. All rights reserved.

"DTS" and "DTS Digital Out" are trademarks of Digital Theater Systems, Inc.



Free Manuals Download Website

<http://myh66.com>

<http://usermanuals.us>

<http://www.somanuals.com>

<http://www.4manuals.cc>

<http://www.manual-lib.com>

<http://www.404manual.com>

<http://www.luxmanual.com>

<http://aubethermostatmanual.com>

Golf course search by state

<http://golfingnear.com>

Email search by domain

<http://emailbydomain.com>

Auto manuals search

<http://auto.somanuals.com>

TV manuals search

<http://tv.somanuals.com>