

NAD[®] T585

Digital Disc Player

ENGLISH

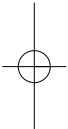

Owner's Manual



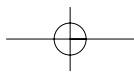

Introduction

IMPORTANT SAFETY INSTRUCTIONS

ENGLISH



IMPORTANT SAFETY INSTRUCTIONS

- Save these instructions for later use.
- Follow all warnings and instructions marked on the audio equipment.

1 Read instructions - All the safety and operating instructions should be read before the product is operated.

2 Retain instructions - The safety and operating instructions should be retained for future reference.

3 Heed Warnings - All warnings on the product and in the operating instructions should be adhered to.

4 Follow Instructions - All operating and use instructions should be followed.

5 Cleaning - Unplug this product from the wall outlet before cleaning. Do not use liquid cleaners or aerosol cleaners. Use a damp cloth for cleaning.

6 Attachments - Do not use attachments not recommended by the product manufacturer as they may cause hazards.

7 Water and Moisture - Do not use this product near water-for example, near a bath tub, wash bowl, kitchen sink, or laundry tub; in a wet basement; or near a swimming pool; and the like.

8 Accessories - Do not place this product on an unstable cart, stand, tripod, bracket, or table. The product may fall, causing serious injury to a child or adult, and serious damage to the product. Use only with a cart, stand, tripod, bracket, or table recommended by the manufacturer, or sold with the product. Any mounting of the product should follow the manufacturer's instructions, and should use a mounting accessory recommended by the manufacturer.

9 A product and cart combination should be moved with care. Quick stops, excessive force, and uneven surfaces may cause the product and cart combination to overturn.

10 Ventilation - Slots and openings in the cabinet are provided for ventilation and to ensure reliable operation of the product and to protect it from overheating, and these openings must not be blocked or covered. The openings should never be blocked by placing the product on a bed, sofa, rug, or other similar surface. This product should not be placed in a built-in installation such as a bookcase or rack unless proper ventilation is provided or the manufacturer's instructions have been adhered to.

11 Power Sources - This product should be operated only from the type of power source indicated on the marking label. If you are not sure of the type of power supply to your home, consult your product dealer or local power company.

- **Main Power Disconnect;** When the power switch is in the Off position, the T585 is not completely disconnected from the main power. The primary method of isolating the T585 from the mains supply is to disconnect the mains plug. Ensure that the mains plug remains accessible at all times. When installing the product, ensure that the plug is easily accessible.

- **Non-use Period;** Unplug the AC power cord from the AC outlet if the unit will not be used for a long period of time such as several months or more.

- **CLASS 1 Products;** The T585 shall be connected to a **MAINS** socket outlet with a protective earthing connection.

12 Power-Cord Protection - Power-supply cords should be routed so that they are not likely to be walked on or pinched by items placed upon or against them, paying particular attention to cords at plugs, convenience receptacles, and the point where they exit from the product.

13 Outdoor Antenna Grounding - If an outside antenna or cable system is connected to the product, be sure the antenna or cable system is grounded so as to provide some protection against voltage surges and built-up static charges. Article 810 of the National Electrical Code, ANSI/NFPA 70, provides information with regard to proper grounding of the mast and supporting structure, grounding of the lead-in wire to an antenna discharge unit, size of grounding conductors, location of antenna discharge unit, connection to grounding electrodes, and requirements for the grounding electrode.

NOTE TO CATV SYSTEM INSTALLER

- *This reminder is provided to call the CATV system installer's attention to Section 820-40 of the NEC which provides guidelines for proper grounding and, in particular, specifies that the cable ground shall be connected to the grounding system of the building, as close to the point of cable entry as practical.*

14 Lightning - For added protection for this product during a lightning storm, or when it is left unattended and unused for long periods of time, unplug it from the wall outlet and disconnect the antenna or cable system. This will prevent damage to the product due to lightning and power-line surges.

15 Power Lines - An outside antenna system should not be located in the vicinity of overhead power lines or other electric light or power circuits, or where it can fall into such power lines or circuits. When installing an outside antenna system, extreme care should be taken to keep from touching such power lines or circuits as contact with them might be fatal.

16 Overloading - Do not overload wall outlets, extension cords, or integral convenience receptacles as this can result in a risk of fire or electric shock.

17 Object and Liquid Entry - Never push objects of any kind into this product through openings as they may touch dangerous voltage points or short-out parts that could result in a fire or electric shock. Never spill liquid of any kind on the product.

WARNING

18 Transportation - Transport the T585 in the shipping containers supplied. Do not transport the T585 using one shipping container; to do so may result in damage to either the T585 or personnel.

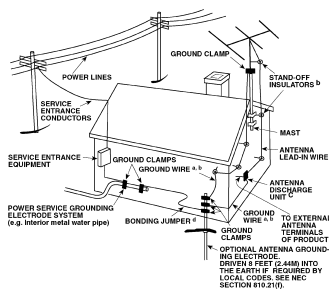

Introduction

IMPORTANT SAFETY INSTRUCTIONS

19 Damage Requiring Service - Unplug this product from the wall outlet and refer servicing to qualified service personnel under the following conditions:

- a) When the power-supply cord or plug is damaged.
- b) If liquid has been spilled, or objects have fallen into the product.
- c) If the product has been exposed to rain or water.
- d) If the product does not operate normally by following the operating instructions. Adjust only those controls that are covered by the operating instructions as an improper adjustment of other controls may result in damage and will often require extensive work by a qualified technician to restore the product to its normal operation.
- e) If the product has been dropped or damaged in any way.
- f) When the product exhibits a distinct change in performance-this indicates a need for service.

20 Replacement Parts - When replacement parts are required, be sure the service technician has used replacement parts specified by the manufacturer or have the same characteristics as the original part. Unauthorized substitutions may result in fire, electric shock, or other hazards.

21 Safety Check - Upon completion of any service or repairs to this product, ask the service technician to perform safety checks to determine that the product is in proper operating condition.

22 Wall or Ceiling Mounting - The product should be mounted to a wall or ceiling only as recommended by the manufacturer.

WARNING

TO PREVENT FIRE OR SHOCK HAZARD, DO NOT EXPOSE THIS APPLIANCE TO RAIN OR MOISTURE. THE LIGHTNING FLASH WITH ARROWHEAD SYMBOL, WITHIN AN EQUILATERAL TRIANGLE, IS INTENDED TO ALERT THE USER TO THE PRESENCE OF UNINSULATED "DANGEROUS VOLTAGE" WITHIN THE PRODUCT'S ENCLOSURE THAT MAY BE OF SUFFICIENT MAGNITUDE TO CONSTITUTE A RISK OF ELECTRIC SHOCK TO PERSONS.

THE EXCLAMATION POINT WITHIN AN EQUILATERAL TRIANGLE IS INTENDED TO ALERT THE USER TO THE PRESENCE OF IMPORTANT OPERATING AND MAINTENANCE (SERVICING) INSTRUCTIONS IN THE LITERATURE ACCOMPANYING THE APPLIANCE

CAUTION

Changes or modifications to this equipment not expressly approved by NAD Electronics for compliance could void the user's authority to operate this equipment.

CAUTION REGARDING PLACEMENT

To maintain proper ventilation, be sure to leave a space around the unit (from the largest outer dimensions including projections) equal to, or greater than, shown below.

Left and Right Panels : 10 cm

Rear Panel : 10 cm

Top Panel : 50 cm

IMPORTANT INFORMATION FOR UK CUSTOMERS

DO NOT cut off the mains plug from this equipment. If the plug fitted is not suitable for the power points in your home or the cable is too short to reach a power point, then obtain an appropriate safety approved extension lead or consult your dealer. If, nonetheless, the mains plug is cut off, REMOVE THE FUSE and dispose of the PLUG immediately, to avoid possible shock hazard by inadvertent connection to the mains supply. If this product is not provided with a mains plug, or one has to be fitted, then follow the instructions given below:

IMPORTANT

DO NOT make any connection to the larger terminal which is marked with the letter 'E' or by the safety earth symbol or coloured GREEN or GREEN AND YELLOW.

The wires in the mains lead on this product are coloured in accordance with the following code:

BLUE - NEUTRAL

BROWN - LIVE

As these colours may not correspond with the coloured markings identifying the terminals in your plug, proceed as follows:

The BLUE wire must be connected to the terminal marked with the letter 'N' or coloured BLACK.

The BROWN wire must be connected to the terminal marked with the letter 'L' or coloured RED

When replacing the fuse, only a correctly rated and approved type should be used, and be sure to re-fit the fuse cover.

IF IN DOUBT CONSULT A COMPETENT ELECTRICIAN

This product is manufactured to comply with the radio interference requirements of EEC DIRECTIVE 89/68/EEC and 73/23/EEC

NOTES ON ENVIRONMENTAL PROTECTION

At the end of its useful life, this product must not be disposed of with regular household waste but must be returned to a collection point for the recycling of electrical and electronic equipment. The symbol on the product, user's manual and packaging, point this out. The materials can be reused in accordance with their markings. Through re-use, recycling of raw materials, or other forms of recycling of old products, you are making an important contribution to the protection of our environment. Your local administrative office can advise you of the responsible waste disposal point.

Model No. : _____ Serial No. : _____

ENGLISH



CE



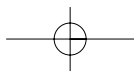

Introduction

TABLE OF CONTENTS

ENGLISH

INTRODUCTION	
Important Safety Instructions	2
IDENTIFICATION OF CONTROLS	
Front Panel/Display window	6
Rear Panels	7-8
Preparing The Remote Control	9
Remote Control	10
Operation Of The T585 With The Remote Control	11
OPERATION	
Operation of the T585	12
Introduction	12
Special Playback	13-14
Screen Save	13
Automatic Power Off Function	13
Stopping Play	13
Resume Play	13
Still Picture	13
Frame Advance	13
Skipping chapters and tracks	13
Scanning at High Speed	14
Playing in Slow-Motion	14
OSD Operation	15
Display/Titles/Menus/Subtitles	15
Viewing From Another Angle	16
Repeat Play	16
Storing Markers in Memory	17
Zoom Feature	17
Random Play	18
Program Play	18
Playback Audio with CD, VCD, and DVD	19



Introduction

TABLE OF CONTENTS

SETUP

Connecting to Surround Sound System19-25

 SACD/DVD-A 19

 Dolby Digital Sound 20

 Dolby Pro Logic Surround Sound 21

 2-Channel Digital Stereo Sound 22

 DTS Sound 23

Connecting to an Analogue Stereo System24

Connecting to a TV Directly25

Initial Setup Settings26-31

 Selecting Languages 26

 Selecting Video Aspect and Picture Mode 27

 Selecting Signal Mode 28

 Selecting Gamma Setting 28

 Selecting Black Level 28

 Selecting Brightness Level 29

 Selecting Contrast Level 29

 Selecting Saturation Level 29

 Selecting Video Adjustment Options 30

 Selecting Digital and Audio Output and Other Settings 31

REFERENCE

Notes on Discs31

Playable Discs32

Disc Requirements32

Table of Languages and Their Abbreviations33

Trouble Shooting34

Specifications35

Copyright Information/Macrovision Product Notice36

Notes37

 Video Output Scan Types 37

ENGLISH

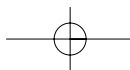

Identification of Controls

FRONT PANEL

ENGLISH

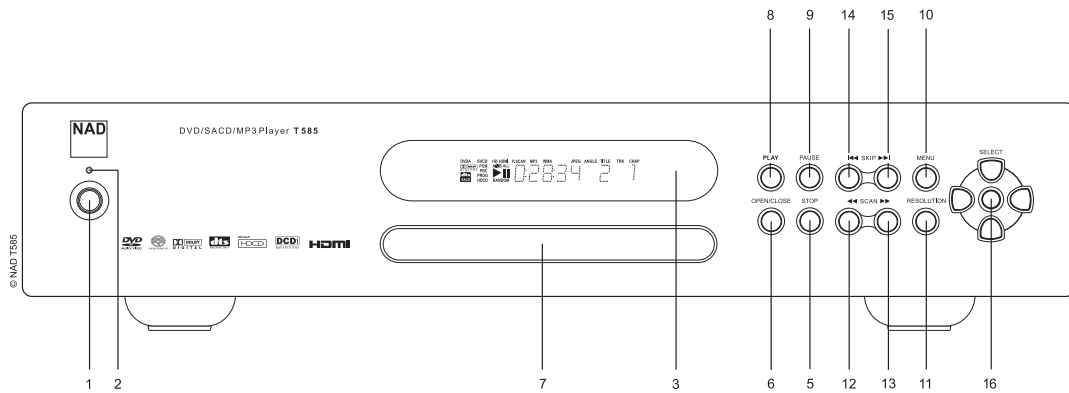

- 1-2 Power button and On/Standby indicator
- 3 Display window
- 4 Select/Enter/Navigation buttons
- 5 STOP button
- 6 OPEN/CLOSE button
- 7 DVD/CD tray
- 8 PLAY button
- 9 PAUSE button

- 10 MENU button
- 11 RESOLUTION button
- 12 SCAN backward button
- 13 SCAN forward button
- 14 SKIP backward button
- 15 SKIP forward button
- 16 SELECT (navigation and Enter) buttons

DISPLAY WINDOW

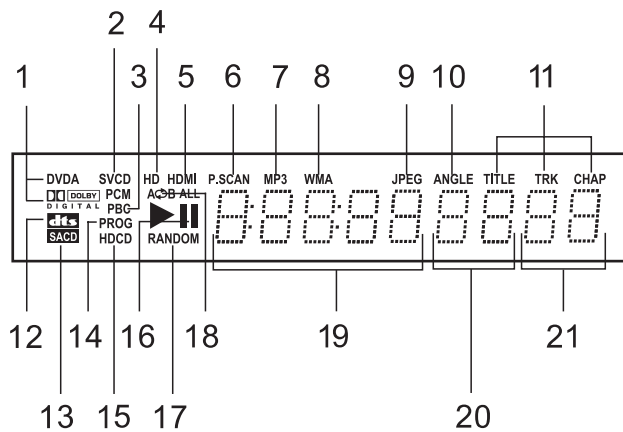

- 1 DVD-Audio and Dolby Digital multi-channel output indicator
- 2 CD, VCD and SVCD indicator
- 3 PBC indicator for VCD and SVCD
- 4 HD (Hi Definition) indicator
- 5 HDMI indicator
- 6 P. SCAN (Progressive Scan) indicator
- 7 MP3 indicator
- 8 WMA indicator
- 9 JPEG Indicator
- 10 ANGLE Indicator
- 11 TITLE, TRK, and CHAP indicators
- 12 DTS indicator

- 13 SAGD (2-channel or multi-channel) indicator
- 14 PROGRAM indicator
- 15 HDCC indicator
- 16 Play and Pause indicators
- 17 RANDOM play indicator
- 18 Repeat, repeat ALL, repeat A-B indicator
- 19 Total playing time display
- 20 Title number display
- 21 Track number display

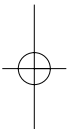

Identification of Controls

REAR PANEL (NORTH AMERICAN VERSION)

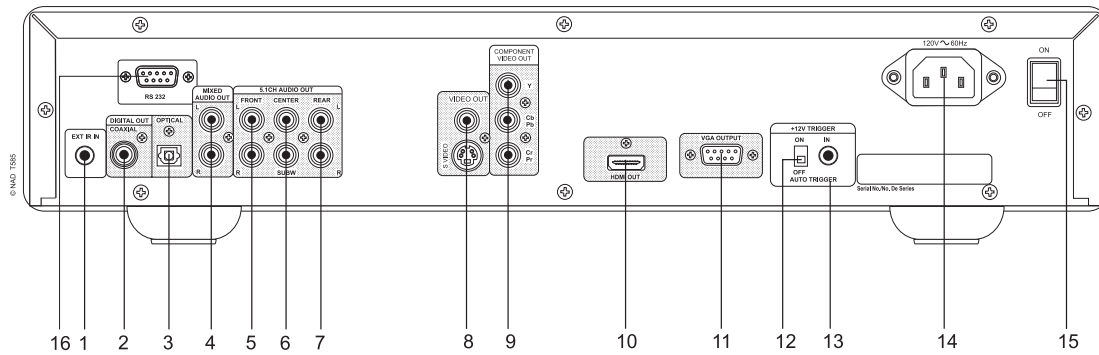

- | | |
|---|---|
| <p>1 IR IN Jack</p> <p>2 DIGITAL OUT COAXIAL Jack</p> <p>3 DIGITAL OUT OPTICAL jack</p> <p>4 MIXED AUDIO OUT (L & R) Jacks</p> <p>5 5.1 CH AUDIO OUT FRONT L & R Jacks</p> <p>6 5.1 CH AUDIO OUT CENTER and SUBW (Subwoofer) Jacks</p> <p>7 5.1 CH AUDIO OUT SURR (Surround Sound) L & R Jacks</p> <p>8 S-VIDEO & Composite VIDEO OUT Jacks (480i/576i video resolutions)</p> <p>9 COMPONENT VIDEO OUT Jacks (480i/576i, 480p/576p, and 1080i video resolutions)</p> | <p>10 HDMI OUT Jack (480/576, 720p, and 1080i video resolutions)</p> <p>11 VGA OUT Jack (480/576, 720p, and 1080i video resolutions)</p> <p>12 AUTO TRIGGER ON/OFF Switch</p> <p>13 +12V TRIGGER IN jack</p> <p>14 Power cord socket</p> <p>15 POWER ON/OFF</p> <p>16 RS 232 In/Out Jack</p> |
|---|---|

NOTES

Connect the optical digital cable (not supplied) firmly so that the configurations of both the cable and the connector match.

The **+12V TRIGGER IN** jack is a 3.5mm monotype miniature phone jack with the centre pin the 12V signal-sense. We recommend that you use a good quality cable with shield when attaching the 3.5mm monotype plug so as to prevent false triggering of the amplifier due to electromagnetic interference from nearby electronic equipment. The **+12V-IN TRIGGER** allows you to have an external 12V signal to turn ON the NAD T585 from standby. This 12V signal must be a continuous 12V signal in order to keep the T585 in the ON state. Once you remove the 12V signal the T585 will return to standby. Check the specifications of the trigger input terminal the other components to ensure these are compatible with the T585. All 12V-TRIGGER inputs and outputs on other NAD components with a 12V-TRIGGER feature are fully compatible with the NAD T585's 12V-TRIGGER IN. Before making any connections to any 12V-TRIGGER IN make sure all components are disconnected from the AC mains. If in doubt over the connections, installation and/or operation of the 12V-TRIGGER IN connection, consult your NAD dealer or sales representative. Failure to observe the above may result in damage to the NAD T585 and/or any ancillary components attached to it.

The **IR IN** jack is connected to the output of an IR (infrared) repeater (Xantech or similar), or the IR output of another component to allow control of the T585 from a remote location. Ask your dealer or custom installer for further details

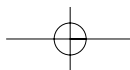

Identification of Controls

REAR PANEL (EUROPEAN VERSION)

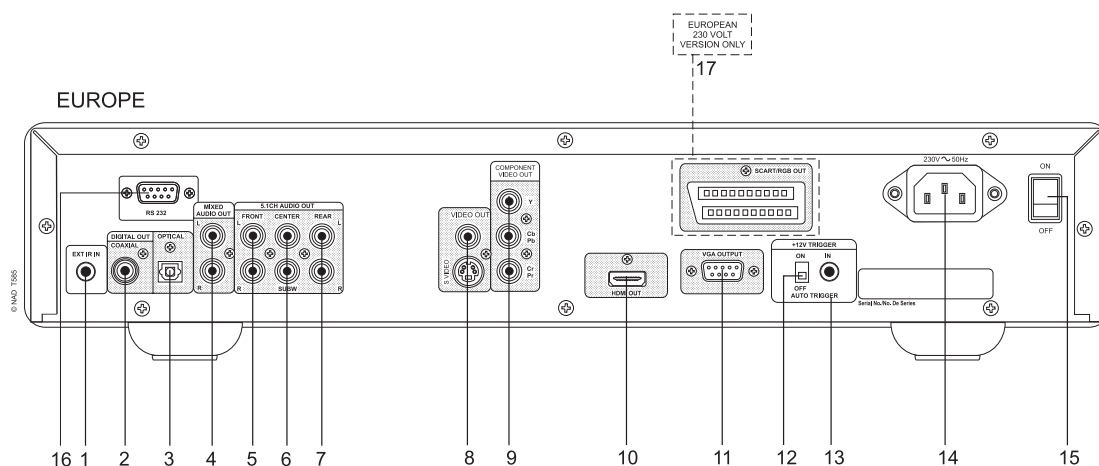

- | | |
|--|--|
| <p>1 IR IN Jack</p> <p>2 DIGITAL OUT COAXIAL Jack</p> <p>3 DIGITAL OUT OPTICAL jack</p> <p>4 MIXED AUDIO OUT (L & R) Jacks</p> <p>5 5.1 CH AUDIO OUT FRONT L & R Jacks</p> <p>6 5.1 CH AUDIO OUT CENTER and SUBW (Subwoofer) Jacks</p> <p>7 5.1 CH AUDIO OUT SURR (Surround Sound) L & R Jacks</p> <p>8 S-VIDEO & Composite VIDEO OUT Jacks (480i/576i video resolutions)</p> <p>9 COMPONENT VIDEO OUT Jacks (480i/576i, 480p/576p, and 1080i video resolutions)</p> | <p>10 HDMI OUT Jack (480/576, 720p, and 1080i video resolutions)</p> <p>11 VGA OUT Jack (480/576, 720p, and 1080i video resolutions)</p> <p>12 AUTO TRIGGER ON/OFF Switch</p> <p>13 +12V TRIGGER IN jack</p> <p>14 SCART/RGB OUT Jack (480/576, video resolutions)</p> <p>15 Power cord socket</p> <p>16 POWER ON/OFF</p> <p>17 RS 232 In/Out Jack</p> |
|--|--|

NOTES

Connect the optical digital cable (not supplied) firmly so that the configurations of both the cable and the connector match.

The **+12V TRIGGER IN** jack is a 3.5mm monotype miniature phone jack with the centre pin the 12V signal-sense. We recommend that you use a good quality cable with shield when attaching the 3.5mm monotype plug so as to prevent false triggering of the amplifier due to electro-magnetic interference from nearby electronic equipment. The **+12V-IN TRIGGER** allows you to have an external 12V signal to turn ON the NAD T585 from standby. This 12V signal must be a continuous 12V signal in order to keep the T585 in the ON state. Once you remove the 12V signal the T585 will return to standby. Check the specifications of the trigger input terminal the other components to ensure these are compatible with the T585. All 12V-TRIGGER inputs and outputs on other NAD components with a 12V-TRIGGER feature are fully compatible with the NAD T585's 12V-TRIGGER IN. Before making any connections to any 12V-TRIGGER IN make sure all components are disconnected from the AC mains. If in doubt over the connections, installation and/or operation of the 12V-TRIGGER IN connection, consult your NAD dealer or sales representative. Failure to observe the above may result in damage to the NAD T585 and/or any ancillary components attached to it.

The **IR IN** jack is connected to the output of an IR (infrared) repeater (Xantech or similar), or the IR output of another component to allow control of the T585 from a remote location. Ask your dealer or custom installer for further details



Identification of Controls

PREPARING THE REMOTE CONTROL

Insert the batteries into the remote control so you can use it to operate the T585.

- 1 Open the battery cover
- 2 Insert two batteries (AA size)
- 3 Make sure to match the + and - on the batteries to the marks inside the battery compartment.
- 4 Close the cover

NOTES ON BATTERIES

Improper use of batteries may cause battery leakage and corrosion.

- *To operate the remote control correctly, follow the instructions.*
- *Do not insert the batteries into the remote control in the wrong direction.*
- *Do not charge, heat, open or short-circuit the batteries.*
- *Do not throw the batteries into fire.*
- *Do not leave dead or exhausted batteries in the remote control.*
- *Do not use different types of batteries together, or mix old and new batteries.*
- *If you do not use the remote control for a long period of time, remove the batteries to avoid possible damage from battery corrosion.*
- *If the remote control does not function correctly or if the operating range becomes reduced, replace all batteries with new ones.*
- *If battery leakage occurs, wipe the battery liquid from the battery compartment, then insert new batteries.*
- *The batteries should last about one year with normal use.*

OPERATION OF THE T585 WITH THE REMOTE CONTROL

This section shows you how to use the remote control. Point the remote control at the remote control sensor and press the buttons.

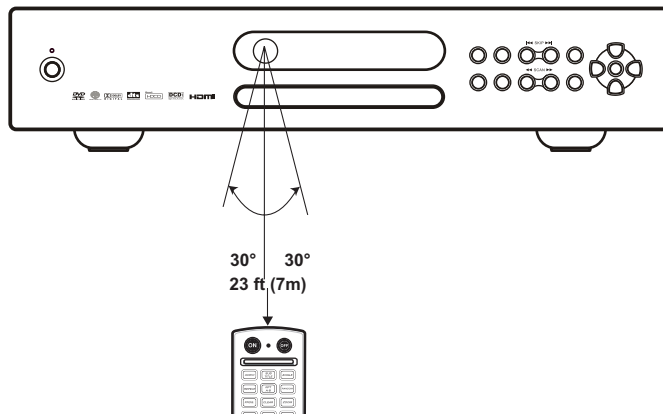

Distance: About 23 ft (7 m) from the front of the remote sensor

Angle: About 30 degrees in each direction of the front of the remote sensor

NOTES ON THE REMOTE CONTROL

- *Do not expose the remote sensor of the T585 to a strong light source such as direct sunlight or illumination. If you do so, you may not be able to operate the T585 with the remote control.*
- *Point the remote control at the remote sensor on the T585.*
- *Do not drop or give the remote control a shock.*
- *Do not leave the remote control near an extremely hot or humid place.*
- *Do not spill water or put anything wet on the remote control.*
- *Do not disassemble the remote control.*

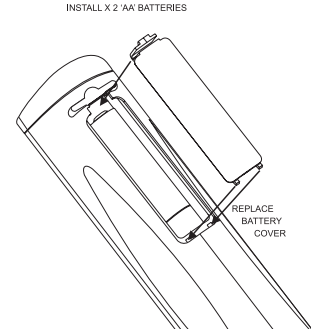
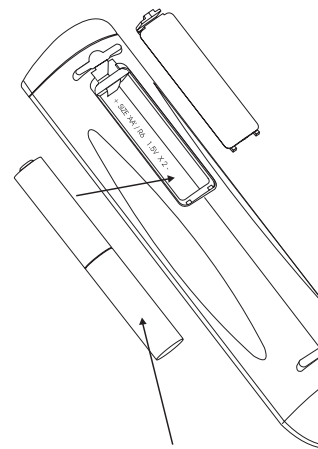
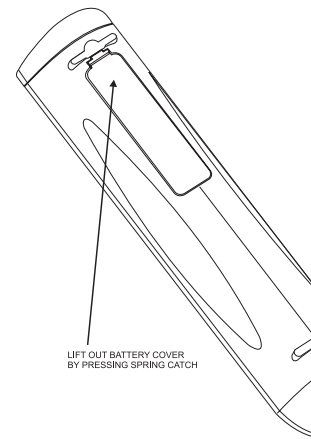

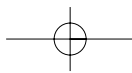

Identification of Controls

REMOTE CONTROL

ENGLISH

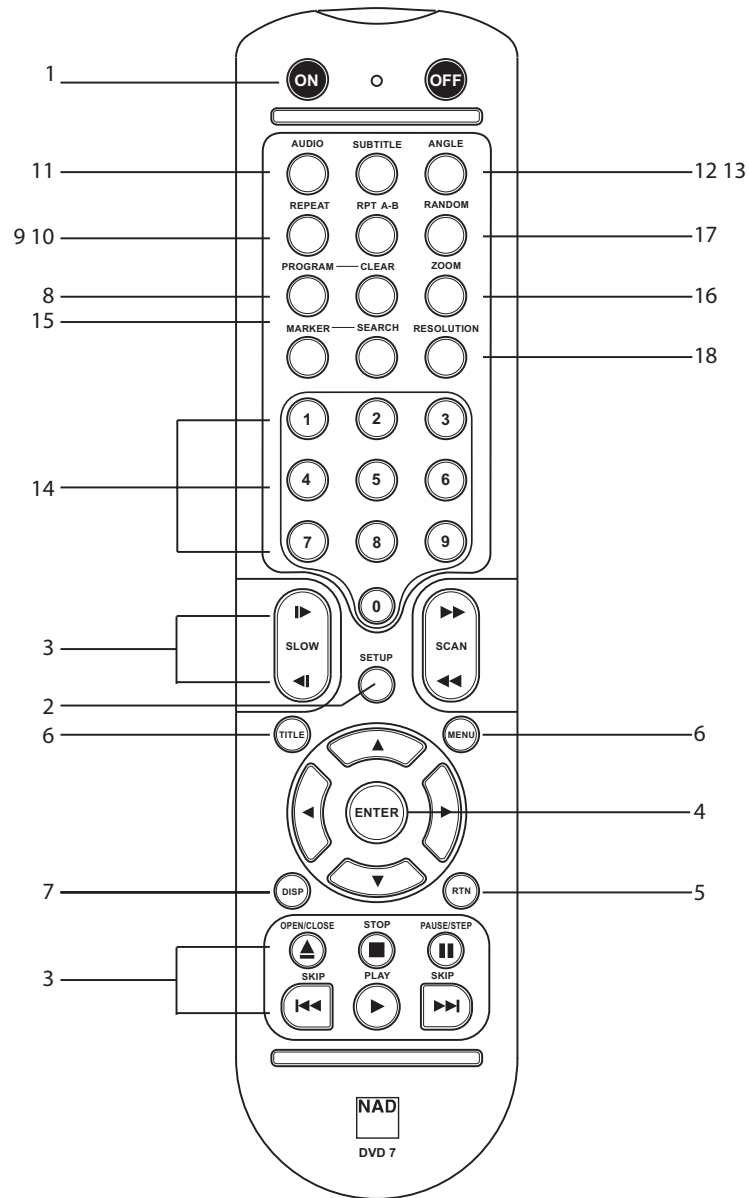

- | | |
|--|--|
| <ul style="list-style-type: none"> 1 POWER ON, POWER OFF 2 SETUP 3 Transport control keys OPEN/CLOSE, STOP, PAUSE, STEP, PLAY, SKIP, SCAN, SLOW 4 ENTER and navigation buttons 5 RETURN 6 TITLE, MENU 7 DISPLAY 8 PROGRAM, CLEAR 9 REPEAT | <ul style="list-style-type: none"> 10 REPEAT A-B 11 AUDIO 12 SUBTITLE 13 ANGLE 14 Numerical buttons 15 MARKER, SEARCH 16 ZOOM 17 RANDOM 18 RESOLUTION |
|--|--|

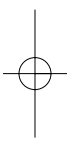
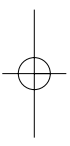

Identification of Controls

REMOTE CONTROL

- 1 The power buttons labelled **ON** and **OFF** will toggle the T585 from standby to the on-position, only if the **POWER** rocker switch on the left rear of the T585 is in the **ON** position.
- 2 The **SETUP** button is used in conjunction with the television monitor's On Screen Display (OSD) connected to the T585, (see the section on 'Initial Set-up Settings') to edit the DVD's OSD.
- 3 There are ten transport control buttons that allows one to directly control the DVD/VCD/CD media. These buttons handle the basic operations of; Open/Close ▲ of the media tray, Stop ■, Pause ||, Skip forward and back ◀▶, Play ▶, Scan tracks ◀▶, and Slow scan tracks ◀|▶.
- 4 The navigation buttons ◀▶/▲/▼ in conjunction with the **ENTER** button allows one to navigate the OSD, title and menu screens.
- 5 The **RTN** button is used for back up navigation of various DVD and SETUP menus.
- 6 The **TITLE** and **MENU** buttons are used to display via OSD, the title headings and menus of the DVD, VCD/S VCD with PBC and MP3 CD media when available.
- 7 The **DISPLAY** button will show an OSD for advanced DVD/VCD/CD player configuration, when the T585 is in play or pause mode.
- 8 The **PROGRAM**, **CLEAR**, buttons are used for programming the tracks on CD media.
- 9 The **REPEAT** button when pressed once, repeats an audio CD track or DVD chapter. If the button is pressed twice the entire audio CD is repeated or the DVD chapters are repeated.
- 10 The **REPEAT A-B** button is used to repeat a specific start to stop section of an audio CD or DVD/VCD. During play mode of the media, press the button once to store the start point of the T585 in memory. When pressed a second time the stop point of the media is stored. The T585 will play the selected section(s) until **REPEAT A-B** button is pressed a third time.
- 11 The **AUDIO** button will allow one to switch the audio language of the DVD media only if the DVD media supports the **AUDIO** button feature.
- 12 The **SUBTITLE** button will allow one to switch on or off the various types of subtitles for the DVD media being viewed, only if the DVD media supports the **SUBTITLE** button feature.
- 13 The **ANGLE** button will allow one to select various viewing angles of each movie scene only if the DVD media supports this feature.
- 14 The number buttons are used for inputting numeric values when navigating the menu, title, and display OSDs or when directly selecting media tracks.
- 15 The **MARKER** and **SEARCH** buttons allows one to set up to 9 bookmarks on a DVD, VCD and CD for quick reference. After each marker is stored one then presses the **SEARCH** then navigation buttons to play the bookmark.
- 16 The **ZOOM** button allows one to expand the viewed image up to 32 times. To clear the zoom menu, press the **CLEAR** button.
- 17 The **RANDOM** button allows one to randomly play audio CD media. In conjunction with the **REPEAT** buttons the audio CD would randomly play all tracks on an audio CD. This feature is not available on most DVD/VCDs.
- 18 The **RESOLUTION** button allows one to select 480/576, 720p, and 1080i video resolutions from the Component-YUV, VGA, SCART and HDMI output.

NOTE: Not all resolutions are available on all outputs. See chart on page 37

Operation

OPERATION OF THE T585

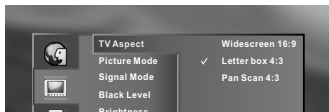

ENGLISH

INTRODUCTION

When you want to play back DVD video discs and DVD-Audio or audio CDs, turn on your AV audio system and the TV and then select the video input source connected to the DVD player.

Set the playback picture size according to the aspect ratio of the connected TV in the setup OSD menus.

Switch ON the POWER rocker switch, then the front panel Standby button. The T585-power indicator turns amber, and then blue.

Press OPEN/CLOSE. The disc tray opens.

- You can open the disc tray by pressing this button even if the DVD player is in standby mode. The power indicator will turn from amber to green.

Place a disc on the disc tray with the playback side down.

- There are two different disc sizes. Place the disc in the correct guide on the disc tray. If the disc is out of the guide, it may damage the disc and cause the T585 to malfunction. Press **PLAY**. The disc tray is automatically closed and playback begins.
- If the disc is placed in upside down (and it is a single sided disc), NO DISC will appear on the T585's display and 'NO DISC' appears on the TV screen.
- If you insert an audio CD, the total tracks and time will appear.
- After playing back all of the chapters in the title, T585 automatically stops and returns to the menu screen.

Press the navigation keys then and press ENTER, or press the numeric button(s), to select the desired item. Play of the selected item now begins.

- For further information, also refer to the jacket or case of the disc you are playing.

AFTER OPERATION

When the unit is not in use, remove the disc and press the **OFF** button on the remote to switch the T585 to standby. If the T585 is left unattended for any length of time such as during a vacation, then switch off the T585 by depressing the black rocker switch marked **POWER ON/OFF** found on the rear of the T585.

NOTES

- Do not move the DVD player during playback. Doing so may damage the disc and the T585.
- Use the **OPEN/CLOSE** button on the T585 or  on the remote control to open and close the disc tray.
- Do not push or pull the disc tray while it is moving. Doing so may cause the T585 to malfunction.
- Do not push up the disc tray or put any objects other than discs on the disc tray. Doing so may cause the T585 to malfunction.
- Keep your fingers well clear of the disc tray as it is closing. Be especially careful with children's fingers around the closing disc tray, as there is a risk of personal injury.
- Depending on the DVD disc, some operations may be different or restricted. Refer to the jacket or case of the disc you are playing.

Operation

SPECIAL PLAYBACK

SCREEN SAVE

The screen saver is useful to prevent your display from becoming damaged. The screen saver picture appears when you leave the T585 in pause or stop mode for about 8 minutes.

AUTOMATIC POWER OFF FUNCTION

The T585 can be powered to standby by the **12V-TRIGGER IN**. Also, the T585 will automatically turn itself to standby mode after the Screen Saver has been engaged for about 8 minutes.

STOPPING PLAY

Press STOP during playback either on the remote or the T585.

RESUME PLAY

When play is stopped, the unit records the point where STOP was pressed and the TV OSD will display 'STOP-RESUME POSSIBLE'.

Press the PLAY button either on the remote or the T585 and play will resume from this point.

NOTE

Resume function will be cleared when the STOP is pressed twice. Resume function will be cleared when the power is turned off and then on. Opening the disc tray cancels Resume function. The Resume function may not be available on some DVD/VCD discs.

STILL PICTURE (PAUSE)

Press PAUSE during playback. For a DVD, the T585 will be placed in the still picture mode. For a CD the player will be placed in the pause mode.

FRAME ADVANCE (DVD ONLY)

Press PAUSE during still playback (each time you press PAUSE, the picture advances one frame). To resume normal playback, press PLAY

SKIPPING CHAPTERS AND TRACKS

SKIPPING FORWARD

Press SKIP (or SKIP FORWARD icon) during playback

A chapter (DVD) or a track (CD) is skipped each time the button is pressed.

SKIPPING BACK

Press SKIP (or SKIP BACK icon) during playback. When the button is pressed once midway through a chapter/track, the player returns to the start of that chapter/track. When it is pressed again, a chapter/track is skipped each time the button is pressed.



ENGLISH



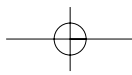

Operation

SPECIAL PLAYBACK

ENGLISH

SCANNING AT HIGH SPEED (DVD, CD, VCD)

You can play back discs at various speeds. To scan at fast-forward or fast-reverse during playback, press the Scan buttons ◀◀, or ▶▶ during playback.

The speed of advance (reverse) is relatively slow at first. When the button is pressed again, the speed becomes faster. (Each time the button is pressed, the speed increases up to 5 steps for DVD, 2 steps for CD and VCD). The speed will be retained even after the button is released. To return to normal playback, press **PLAY**.

NOTES

- The DVD player does not play back sound during the high-speed reverse and forward playback of DVD VCD video discs as well as CD video discs.
- Not all media support maximum speeds for scanning.

PLAYING IN SLOW-MOTION (DVD, CD, VCD)

Press the SLOW buttons during playback. The playback speed becomes slower than the normal speed.

The speed of slow motion is fast at first. When the button is pressed again, the speed becomes slower. Each time the button is pressed, the speed decreases up to 8 times.

The speed will be retained even after the button is released.

To return to normal playback, press **PLAY**.

NOTES

- The sound is muted during slow-motion playback.
- not all media support maximum slowness speeds.

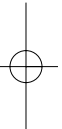
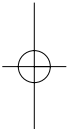

Operation

OSD OPERATION

DISPLAY/TITLES/MENUS/SUBTITLES

Examples of GUI (Graphical User Interface) MENU Icons
(The screens may differ depending on the disc contents.)

OPERATION USING MENU ICONS

Press DISPLAY during playback [TV screen] DVD GUI

To show the current title number, press the DISPLAY button, and navigate to the desired title number or type in the numeric number directly and press ENTER. To show the current chapter number and to jump to the desired chapter number, press DISPLAY and navigate to the Chapter menu and enter the desired numeric value. To show the current audio (Stereo, Left, Right) and to select to the desired audio channel, toggle through the audio selections by pressing the AUDIO button repeatedly.

- 1 Press AUDIO during playback. Each time this button is pressed, the TV screen displays changes.
- 2 Press AUDIO repeatedly until the desired sound is selected.

Some movie discs may contain two or more titles. If the disc has a title menu recorded on it, the TITLE button can be used to select the movie title. (The details of operation differ depending on the disc used.)

NOTE

Selecting a title may not be possible on certain DVD discs.

- 1 Press TITLE. A list of the titles on the disc is displayed. Press TITLE again to resume play from the scene when TITLE was first pressed.
- 2 Press ENTER, PLAY, or press the numeric button(s), to select desired title. The selected title now starts playing.

Some DVDs have unique menu structures called DVD menus. For example, DVDs programmed with complex contents provide guide menus, and those recorded with various languages provide menus for audio and subtitle language. Although the DVD menu's contents and operation differ from disc to disc, the following explains the basic operation when this feature is used.

- 1 Press MENU during play. The DVD menu available on the disc is now displayed. Pressing MENU again resumes play from the scene when MENU was first pressed.
 - Resume play may not be possible on certain discs.
- 2 Press ENTER, or press the numeric button(s), to select desired item. The selected item is now executed.

It is possible to change the subtitle language to a different language from the one selected at the initial settings. This operation works only with discs on which multiple subtitle languages are recorded.

- 1 Press SUBTITLE during playback. When no subtitles are recorded, 'OFF' will be displayed instead of the language number.
- 2 Press SUBTITLE repeatedly until the desired language is selected. Number of the subtitle language being played back is shown. To eliminate the On Screen Subtitles, press SUBTITLE repeatedly to select 'OFF' at step 2.

NOTES

- In some cases, the subtitle language is not changed to the selected one immediately.
- When a disc supporting the closed caption is played, the subtitle and the closed caption may overlap each other on the TV screen. In this case, turn the subtitle off.
- When the desired language is not selected even after pressing the button several times, it means that the language is not available on the disc.
- When the power is turned on or the disc is removed, subtitles appear in the language selected at the initial settings. If this language is not recorded on the disc, the disc's priority language appears.

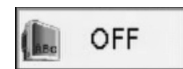
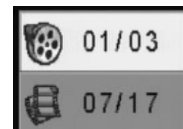
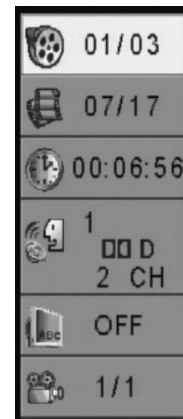

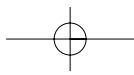

Operation

VIEWING FROM ANOTHER ANGLE

Some DVDs may contain scenes, which have been shot simultaneously from a number of different angles. For these discs, the same scene can be viewed from each of these different angles using the ANGLE button. (The recorded angles differ depending on the disc used.)

- 1 Press ANGLE during playback. Angle number will display being played back.
- 2 Press ANGLE repeatedly until the desired angle is selected.

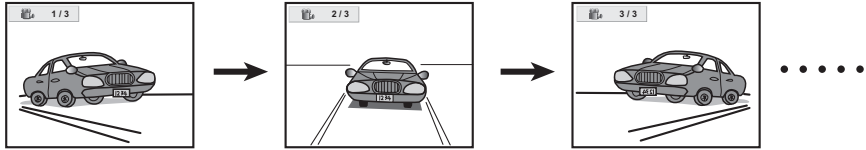

FOR YOUR REFERENCE

The ANGLE Icon will light in the M15's VFD at scenes recorded at different angles to indicate that angle switching is possible. The angle will be switched to the selected number when the ANGLE indicator lights.

NOTE

This function only works for discs having scenes recorded at different angles.

REPEAT PLAY

Press REPEAT during playback. Each time this button is pressed, the TV screen changes as shown below and the disc will repeat a chapter or title (DVD) or a track (CD).

DVD

- Repeat of chapter being played
- Repeat of title being played
- Cancel repeat mode (normal play)

CD

- Repeat of entire disc contents
- Repeat of track being played
- Cancel repeat mode (normal play)

TO PROGRAM REPEAT PLAY (CD)

If REPEAT is pressed during program play, repeat play is operated as below.

- Repeat of the current programmed track
- Repeat of all programs
- Cancel repeat mode by pressing the REPEAT button several times until REPEAT OFF is displayed

REPEATING SECTIONS BETWEEN TWO SPECIFIC POINTS (A-B REPEAT)

- 1 Press A-B during play at the point where repeat play is to start (A).
- 2 Press A-B during play at the point where repeat play is to be concluded (B). Repeat play of the selection between points A and B starts.

To return to normal play

Press A-B button once, 'REPEAT OFF' is displayed.

NOTES

- Repeat play works only with discs for which the elapsed playing time appears in the DVD display window during playback.
- Repeat play may not work correctly with some DVDs.
- A-B repeat play works only within a title DVD or a track CD.
- Some subtitles recorded around point A or B may fail to appear (DVD).
- Repeat and Play may not work with MP-3 encoded CD-R and CD-RW.



Operation

STORING MARKERS IN MEMORY

Storing a MARKER in the T585's memory is similar to marking your page in a book. It allows you to quickly return to any point on the disc.

1 Press MARKER during play at the starting point to be viewed (listened to) again

Indicates 1/9 is stored in the memory. Up to 9 markers can be stored in the memory.

RECALLING/CLEARING A MARKER

2 Press SEARCH during playback

3 Use the navigation buttons to select the marker to be recalled/cleared.

4 Press ENTER to recall a marker. Or press CLEAR to clear a marker.

Play resumes from the point corresponding to the selected marker, or the selected marker is cleared.

NOTE

- These operations work only with discs for which the elapsed playing time appears in the DVD display window during playback or stop.
- Some subtitles recorded around the marker may fail to appear (DVD).
- All the markers are cleared when the power is turned off or the disc is removed.
- A marker is not stored when the DVD or title menu is displayed on the TV screen.

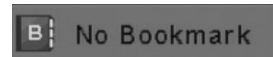

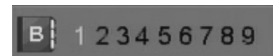

ENGLISH

ZOOM FEATURE

The ZOOM feature allows you to zoom-in and enlarges the picture on the screen to 32 times its normal size.





1 Press ZOOM during normal playback or pause.

Each press of the ZOOM button changes the TV screen. The magnification level will be displayed in the upper right corner of the zoom area.

2 To resume normal playback. Press ZOOM repeatedly until the normal picture is restored. The OSD will display 'Zoom Off'. Pressing CLEAR will also restore normal picture.

NOTE

- Some discs may not respond to the Zoom feature.
- Zoom does not work on subtitles or menus included on DVD video discs.

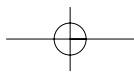

Operation

RANDOM PLAY (CD)

- 1 Press **RANDOM** during normal playback or stop mode. The T585 automatically starts random playback and the **PROG** indicator will appear in the T585's display.
- 2 To resume normal playback, press **RANDOM**.

NOTE

- This function only works with audio CD discs. Random does not work with DVD movies. You can playback titles or tracks in random order. (Random playback)
- Random playback may not be possible on certain discs.
- If you press the **SKIP** button during random playback, the DVD player goes to another track randomly and starts playback.

PROGRAM PLAY (CD)

The player plays the tracks on the disc in the order you specify.

- 1 Press **PROGRAM** during stop mode. The program playback screen appears on the TV screen. To exit the screen, press **PLAY** or **PROGRAM**.
- 2 Press the numeric button(s) to select the desired track number. Press **ENTER** to store the track. Repeat step 2 to select another track. Up to 20 tracks can be programmed.
- 3 Press **PROGRAM** or **PLAY** to exit the screen. The selected track is stored in the memory and play now begins in the programmed sequence.
If you press **PROGRAM** to exit the screen, the selected tracks are memorized. If you press **PROGRAM** after clearing 'Resume Play' the selected programmed tracks are cleared.

NOTE

*After playback of all programmed tracks, play is stopped.
Program play function is possible only with audio CDs. It does not work with DVD movie discs*

CLEARING THE PROGRAM

To clear the programmed tracks one by one
Press navigation buttons to select the unwanted number and then press **CLEAR**.
Press **PROGRAM** to exit the screen (The programs are also cleared when the power is turned off or the disc removed.)

Operation

PLAYBACK AUDIO WITH CD, VCD, SACD, AND DVD

CD/SACD

- 1 Press AUDIO during play.
- 2 Press AUDIO/MENU repeatedly until the desired sound/track is selected.

VCD

- 1 Press AUDIO during play.
- 2 Press AUDIO repeatedly until the desired sound is selected.

DVD

- 1 Press AUDIO during play. Number of the audio soundtrack language being played back.
- 2 Press AUDIO repeatedly until the desired language (or encoding method, channel number) is selected.

NOTES

- When the desired language is not selected even after pressing the button several times, it means that the language is not available on the disc.
- When the power is turned on or the disc is removed, the language heard is the one selected at the initial settings. If this language is not recorded on the disc, only the available language on the disc will be heard.
- Some discs may not respond to Audio feature.

CONNECTING TO A MULTI-CHANNEL SOUND SYSTEM (SACD/DVD-A)

Connect the audio outputs to your integrated amplifier as shown below. Then set up the speaker bass response and configuration as per the 5.1 SPEAKER SETUP.

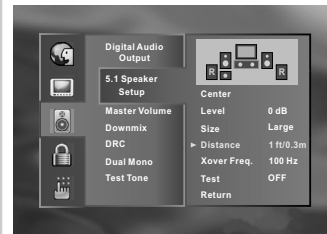
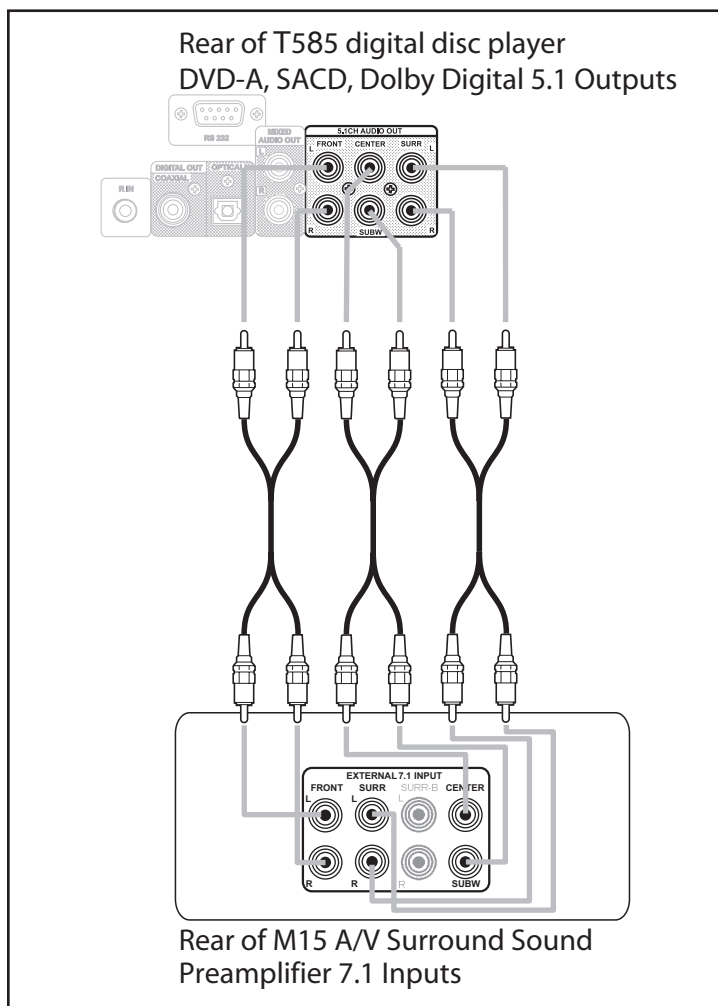

ENGLISH

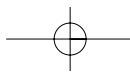

Setup

CONNECTING TO A SURROUND SOUND SYSTEM

DOLBY DIGITAL SOUND

One can enjoy the high quality dynamic sound of Dolby Digital, Dolby Pro Logic and 2 Channel Digital Stereo.

ABOUT DOLBY DIGITAL SOUND

Dolby Digital is the surround sound technology used in theatres showing the latest movies, and is now available to reproduce this realistic effect in the home. You can enjoy motion picture and live concert DVD video discs by connecting the T585 to a 5.1 channel AV receiver equipped with a Dolby Digital decoder (AC-3) or Dolby Digital processor.

ENGLISH

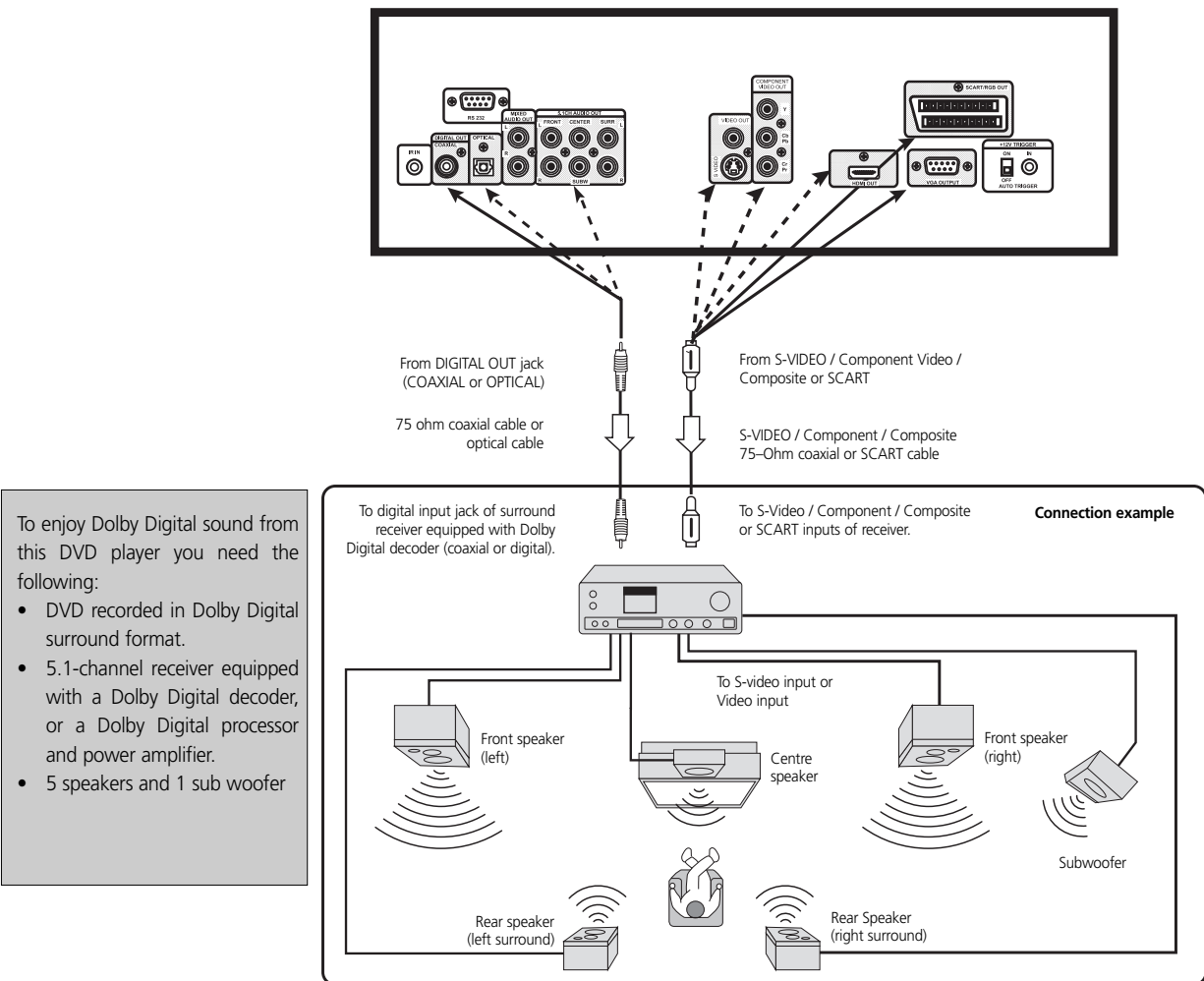

TO ENJOY DOLBY DIGITAL SOUND

You need to select from the OSD drop down menu of the T585, Audio, 'Dolby Digital/PCM' and 'Sample Freq.', '96 kHz' or '48 kHz'. If uncertain, leave the default 'Stereo/PCM' and '48 kHz' from the menu. Do not connect the Digital Audio Output of this DVD player to your receiver unless you are connecting the DIGITAL OUT jack of this DVD player to an AV decoder that has the Dolby Digital or DTS decoding function. High volume sound may damage your hearing as well as the speakers (Refer to Selecting Digital Audio Output. (Refer to Initial Setup Settings, Audio).

NOTE

Refer to the owner's manual of your audio equipment as well. Depending on your Dolby Digital surround sound decoder, the decode rate may be 96 or 48K. When you connect the T585 to other equipment, be sure to turn off the power and unplug all of the equipment from the wall outlet before making any connections. The output sound of the T585 has a wide dynamic range. Be sure to adjust the receiver's volume to a moderate listening level. Otherwise, the speakers may be damaged by a sudden high volume sound. Turn off the receiver before you connect or disconnect the T585's power cord. If you leave the receiver power on, the speakers may be damaged.



Setup

CONNECTING TO A SURROUND SOUND SYSTEM

DOLBY PRO LOGIC SURROUND SOUND

One can enjoy the high quality sound of Dolby Pro Logic Surround Sound if your AV receiver is equipped with a Dolby Pro Logic Surround Sound processor or decoder.

To enjoy Dolby Pro Logic sound from this DVD player you need the following:

- DVD recorded in Dolby Pro Logic format.
- Dolby Pro Logic AV receiver equipped with a Dolby Pro Logic decoder, or Dolby Pro Logic decoder and power amplifier
- 5 speakers

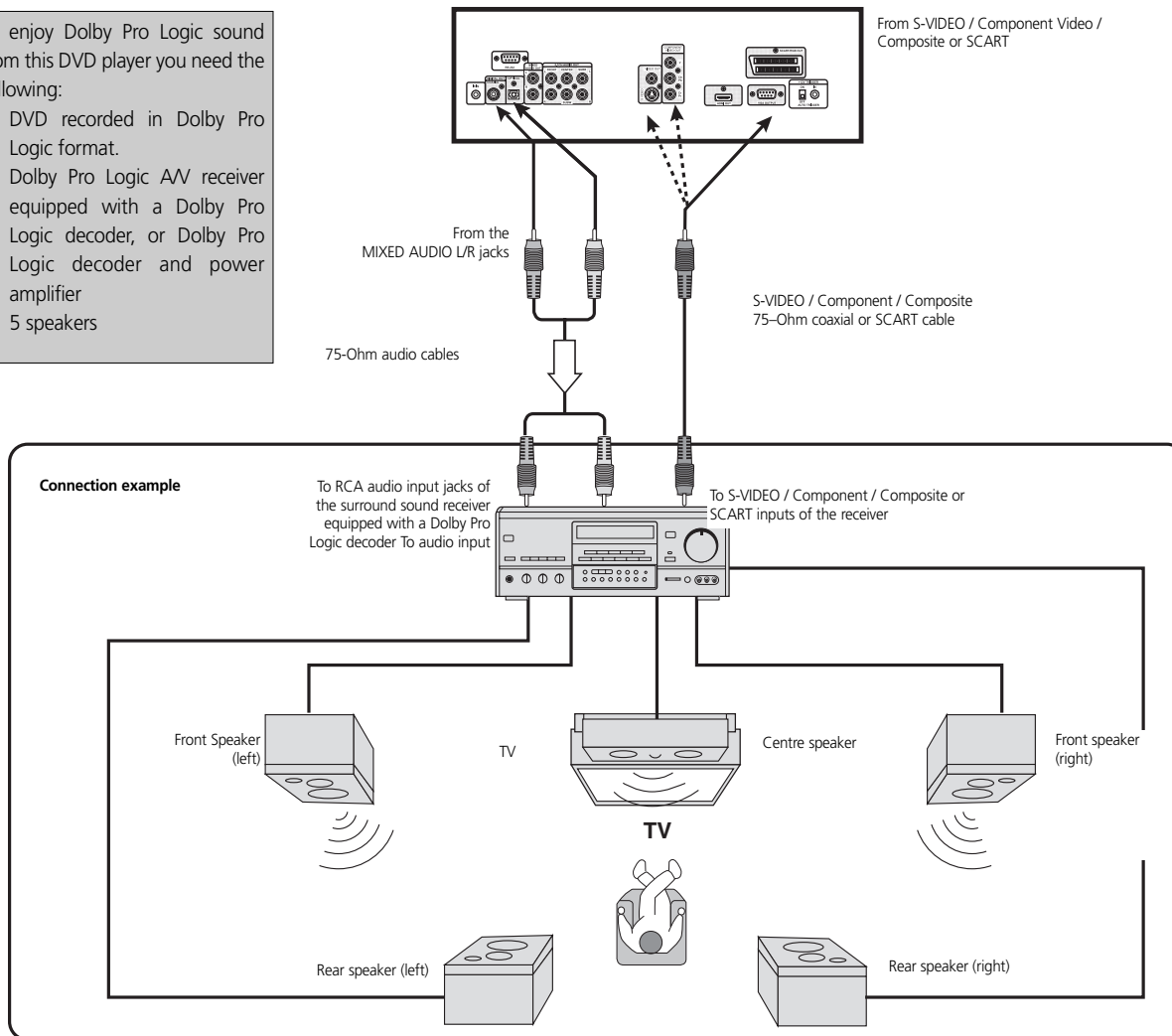
**WITH A RECEIVER EQUIPPED WITH A DOLBY DIGITAL DECODER**

Connect the equipment the same way as described in Enjoying Dolby Digital Sound. Refer to that AV receiver's owner's manual and set the receiver so you can enjoy Dolby Pro Logic Surround sound.

WARNING

Do not connect the Digital Audio Output of this DVD player to your receiver unless you are connecting the DIGITAL OUT jack of this DVD player to an AV decoder that has the Dolby Digital or DTS decoding function. High volume sound may damage your hearing as well as the speakers (Refer to Initial Setup Settings, Audio)

NOTE

Refer to the owner's manual of your audio equipment as well. Depending on your Dolby Digital surround sound decoder, the decode rate may be 96 or 48K. When you connect the T585 to other equipment, be sure to turn off the power and unplug all of the equipment from the wall outlet before making any connections. The output sound of the T585 has a wide dynamic range. Be sure to adjust the receiver's volume to a moderate listening level. Otherwise, the speakers may be damaged by a sudden high volume sound. Turn off the receiver before you connect or disconnect the T585's power cord. If you leave the receiver power on, the speakers may be damaged.

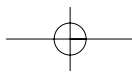

Setup

CONNECTING TO A SURROUND SOUND SYSTEM

2 CHANNEL DIGITAL STEREO SOUND

You can enjoy the dynamic sound of 2 Channel Digital Stereo by connecting this DVD player to a receiver equipped with a digital audio input and speaker system (right and left front speakers).

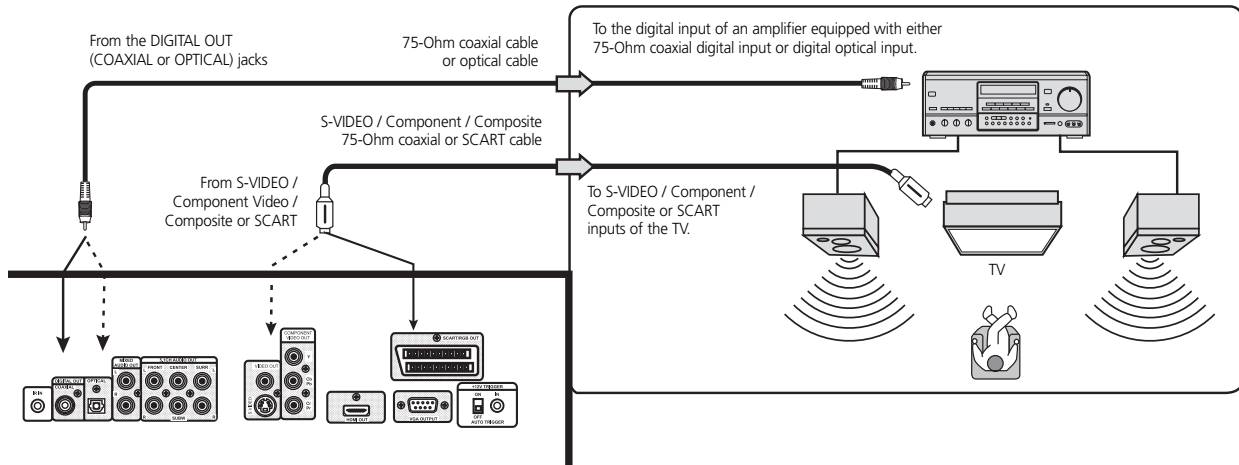

TO ENJOY DIGITAL SOUND

You need to select from the OSD drop down menu, Audio, 'Digital Audio Output', and any of the 'PCM' settings, '96 kHz' or '48 kHz'. If uncertain, leave the default 'Stereo/PCM' and '48 kHz' from the menu. (Refer to Initial Setup Settings, Audio)

NOTES

- Refer to the owner's manual of your receiver as well.
- Before you connect the T585 to other equipment, be sure to turn off the power and unplug all of the equipment from the wall outlet before making any connections.
- Depending on your Digital sound decoder, the decode rate may be 96 or 48K.
- The output sound of the T585 has a wide dynamic range. Be sure to adjust the receiver's volume to a moderate listening level. Otherwise, the speakers may be damaged by a sudden high volume sound.
- Turn off the receiver before you connect or disconnect the T585's power cord. If you leave the receiver power on, the speakers may be damaged.

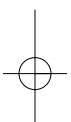
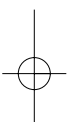

Setup

CONNECTING TO A SURROUND SOUND SYSTEM

DTS SOUND

In order to enjoy DTS sound your AV Receiver or processor must be equipped with a DTS Decoder. The digital output of the T585 must be set to 'Stream/PCM' and the disc must have a DTS soundtrack. There is no analogue output of the T585 for DTS soundtrack.

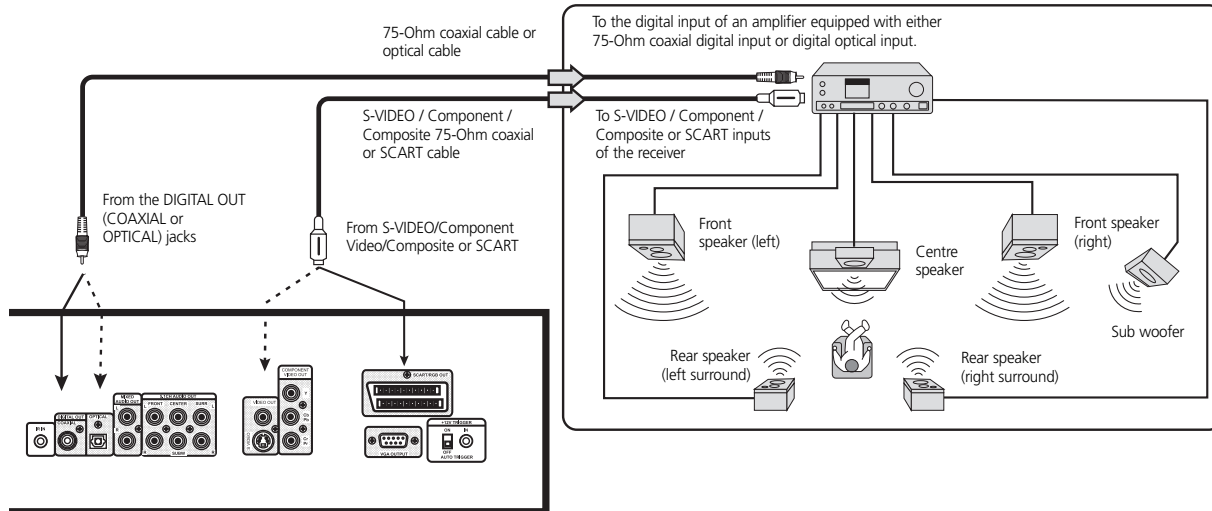
**TO ENJOY DTS SOUND**

You need to select from the OSD drop down menu of the T585, Audio, 'Stream/PCM' and 'Sample Freq.', '96 kHz' or '48 kHz'. If uncertain, select 'Stream/PCM' and 'Sample Freq' of '48 kHz' menu.

WARNING

Do not connect the Digital Audio Output of this DVD player to your receiver unless you are connecting the DIGITAL OUT jack of this DVD player to an AV decoder that has the Dolby Digital or DTS decoding function. High volume sound may damage your hearing as well as the speakers (Refer to Initial Setup Settings, Audio).

NOTES

- Refer to the owner's manual of your receiver as well.
- Before you connect the T585 to other equipment, be sure to turn off the power and unplug all of the equipment from the wall outlet before making any connections.
- Depending on your Digital sound decoder, the decode rate may be 96 or 48K.
- The output sound of the T585 has a wide dynamic range. Be sure to adjust the receiver's volume to a moderate listening level. Otherwise, the speakers may be damaged by a sudden high volume sound.
- Turn off the receiver before you connect or disconnect the T585's power cord. If you leave the receiver power on, the speakers may be damaged.

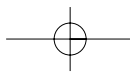

Setup

CONNECTING TO AN ANALOGUE STEREO SYSTEM

Good quality sound of 2-Channel Stereo system can be achieved by connecting this DVD player to a receiver equipped with a two analogue audio inputs (right and left) and speaker system (right and left front speakers).

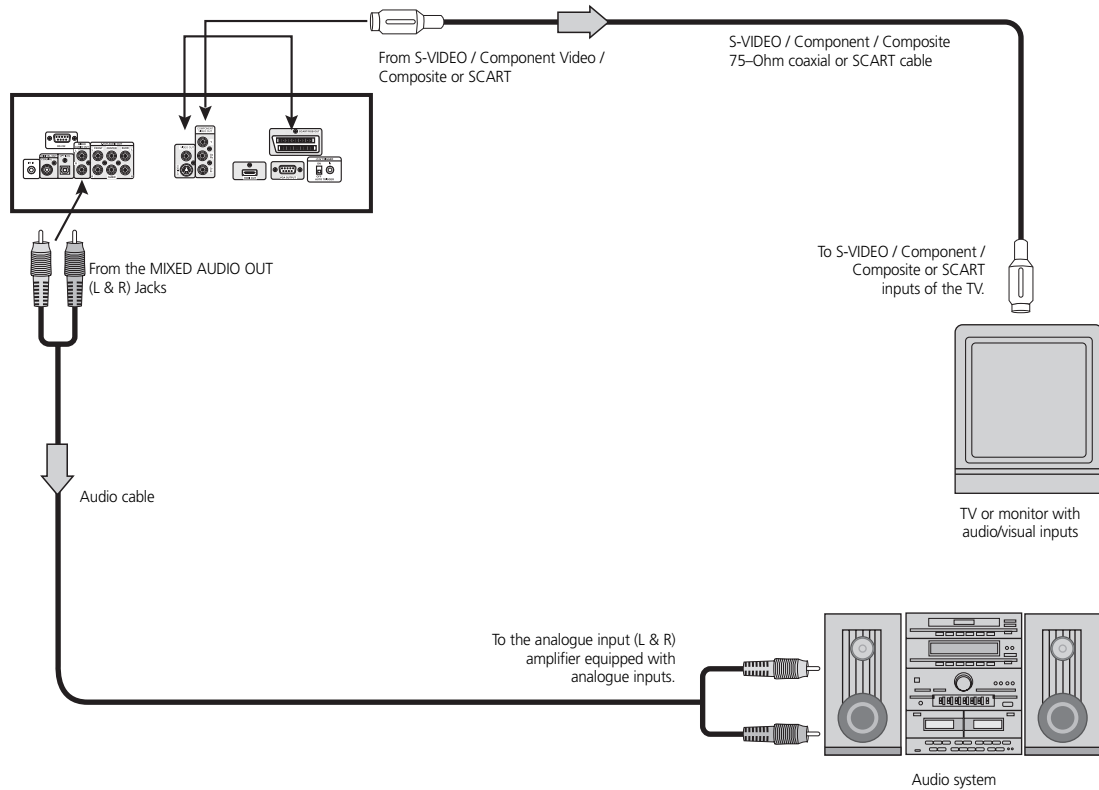

TO ENJOY GOOD QUALITY SOUND

You need to select from the OSD drop down menu, Audio, Downmix, and then 'Stereo'.

NOTES

- Refer to the owner's manual of your receiver as well.
- Before you connect the T585 to other equipment, be sure to turn off the power and unplug all of the equipment from the wall outlet before making any connections.
- Depending on your Digital sound decoder, the decode rate may be 96 or 48K.
- The output sound of the T585 has a wide dynamic range. Be sure to adjust the receiver's volume to a moderate listening level. Otherwise, the speakers may be damaged by a sudden high volume sound.
- Turn off the receiver before you connect or disconnect the T585's power cord. If you leave the receiver power on, the speakers may be damaged.

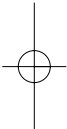

Introduction

CONNECTING TO A TV DIRECTLY

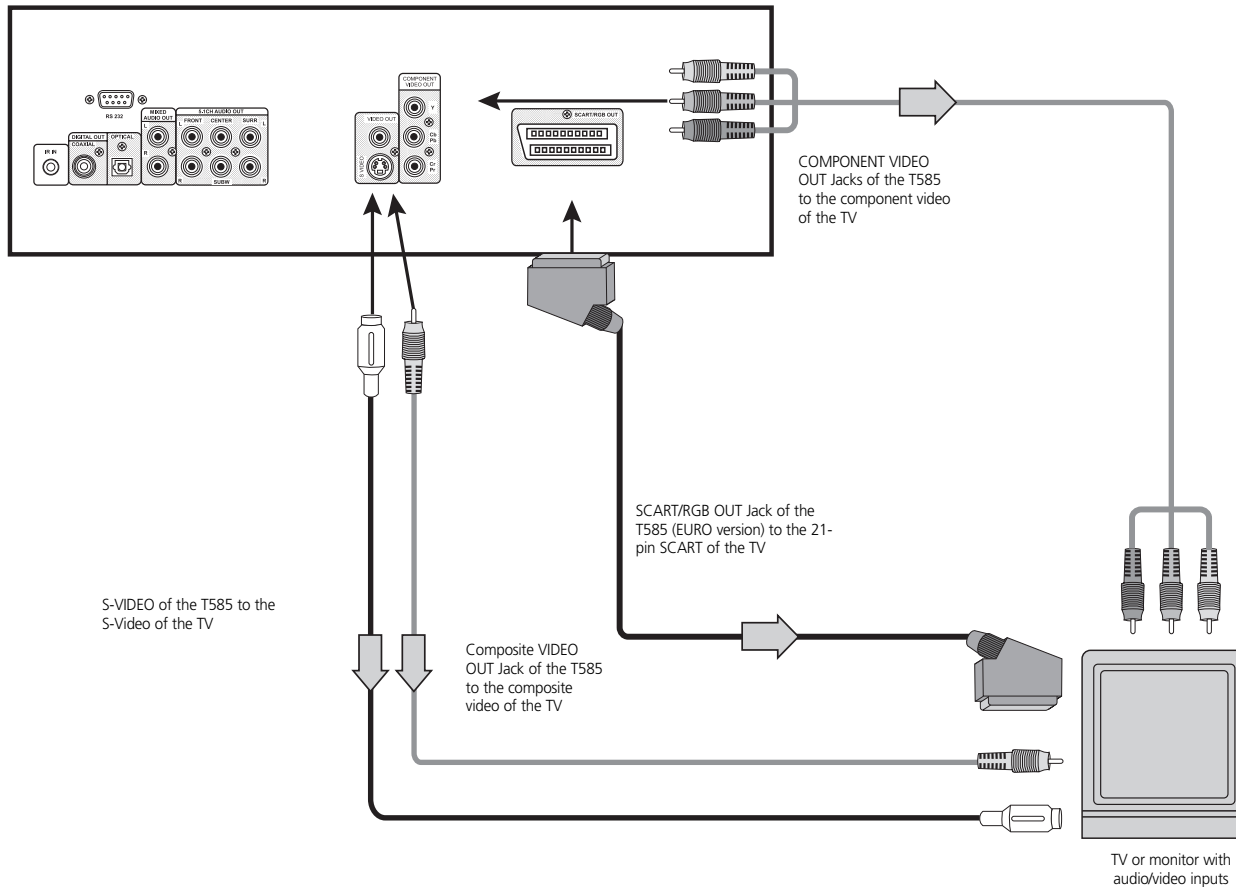

NOTE

75-Ohm video and audio cables are supplied with the T585. SCART and S-Video cables can be purchased from your local NAD retailer.

WARNING

Do not connect the Digital Audio Output of this DVD player to your receiver unless you are connecting the DIGITAL OUT jack of this DVD player to an AV decoder that has the Dolby Digital or DTS decoding function. High volume sound may damage your hearing as well as the speakers or (Refer to Initial Setup Settings, Audio).

NOTES

- Refer to the owner's manual of your receiver as well.
- Before you connect the T585 to other equipment, be sure to turn off the power and unplug all of the equipment from the wall outlet before making any connections.
- Depending on your Digital sound decoder, the decode rate may be 96 or 48K.
- The output sound of the T585 has a wide dynamic range. Be sure to adjust the receiver's volume to a moderate listening level. Otherwise, the speakers may be damaged by a sudden high volume sound.
- Turn off the receiver before you connect or disconnect the T585's power cord. If you leave the receiver power on, the speakers may be damaged.

Setup

INITIAL SETUP SETTINGS

ENGLISH



The player can always be operated under the same conditions (especially with DVD discs), once the initial settings have been completed. The settings will be retained in the memory until they are changed, even if the power is switched off.

- 1 Press SETUP in the stop or playback mode. The 'Setup', 'Video' and 'Audio' menus are displayed.
- 2 Press the navigation keys to select the desired setting and press ENTER. Some items require additional steps. When the RETURN or SETUP key is pressed the screen returns to the Initial Settings display.
- 3 To exit SETUP menu press RETURN, SETUP, PLAY, or OPEN/CLOSE buttons.

SELECTING LANGUAGES

To select language for DVD audio, DVD menus and OSDs on the TV. Do the following.

- 1 From the T585 remote control, press SETUP to select the Settings menu. A drop-down menu for 'OSD', 'Audio', 'Subtitle', 'Menu', and 'Text' will display.
- 2 Use the navigation keys to select the desired Language and then press the ENTER button on the T585 remote to store the selection.



NOTE

The Audio, Subtitle, Menu, and Text OSD are media specific. Not all media support the various language options. Refer to the specific media documentation for available features. Refer to the section 'REFERENCE', 'Table of Languages and Their Abbreviations' for available languages and their codes.

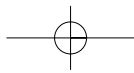

Setup

INITIAL SETUP SETTINGS

SELECTING VIDEO TV ASPECT AND PICTURE MODE

To select the appropriate display mode according to your TV set, one selects the SETUP menu form the remote. Choose 'Video', 'Display Mode', then the three choices that best fit your TV set.

- 1 From the drop-down menu of the OSD screen, use the navigation arrows to select 'Video' and press ENTER on the remote.
- 2 Use the navigation keys to select the desired 'Display Mode' and press ENTER on the remote

'Widescreen 16:9': Select when a wide-screen TV set is connected. Played in FULL size. (Setting the wide-screen TV to FULL mode is also necessary)

'Letterbox 4:3': The video material not formatted in the Pan & Scan style is played back in the letterbox style (black bands appear at top and bottom of screen).

'Pan Scan 4:3': Select when a conventional TV set is connected. The video material formatted in the Pan & Scan style is played back in that style (the left and right edges are cut off).

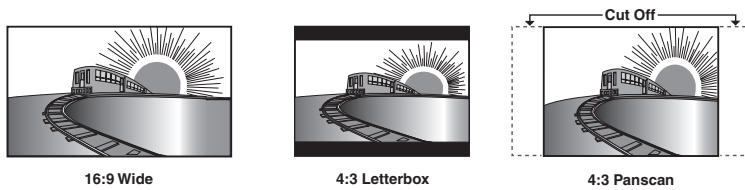

NOTES

- Each screen shows an example when the video material for a widescreen is played. (This setting does not affect the video material for conventional size.)

Select Picture mode depending on the format; video or film. AUTO will switch between the two formats during playback.

NOTE

- For best performance, select AUTO when ever the format is unknown.

SELECTING SCAN TYPE

To select the appropriate scan type according to your TV set, one toggles the RES. (resolution) button on the M3 remote control. For each signal mode, NTSC or PAL there are four choices available. For NTSC the choices are: 480, 720p, and 1080i. For PAL, the four choices are: 576, 720p, and 1080i. See chart below for scan type availability.

- 1 Observe the choices on the VFD.
- 2 Observe the choices on the video outputs as OSD.

There are four modes for scanning depending on your TV set, two are Progressive scan, the other two are interlaced scan. Select the scan type that best suites your TV set.

NOTES

Progressive scan is available in NTSC and PAL, but may be limited or prohibited by copy protection on some media.

When VGA is set to ON, only 480i/576i will be available on the Component Output

Refer to page 37 for scan types available for each video output

Not all monitors will be able to display VGA settings of 1080i. Please refer to your monitor's instruction manual for scan type settings and compatibility.



HDMI = 480P

VGA = 480P

COMPONENT = 480P

HDMI = 576P

VGA = 576P

COMPONENT = 576P

HDMI = 720P

VGA = 720P

COMPONENT = 720P

HDMI = 1080I

VGA = 1080I

COMPONENT = 1080I

ENGLISH

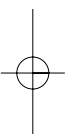
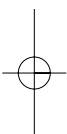

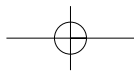

Setup

INITIAL SETUP SETTINGS

ENGLISH



SELECTING SIGNAL MODE

To select the appropriate signal mode according to your TV set, one selects the **SETUP** menu from the remote. Choose the video icon, 'Signal Mode', then one of the four choices that best fit your TV set.

- 1 From the drop-down menu of the OSD screen, use the navigation arrows to select 'Signal Mode' on the remote.
- 2 Use the navigation keys to select the 'Signal Mode' and press **ENTER** on the remote
- 3 Four options will be available; 'Auto', 'NTSC', 'PAL' and, 'PAL-60'

OPTIONS

The 'Auto' setting will detect automatically the media being played and display it.

The other three settings 'NTSC', 'PAL', and 'PAL-60' can be selected to force the output of the T585 to the desired format. For example one can load a PAL media and display it in the NTSC format. Similarly one can load an NTSC media and display it in the PAL format.

Depending on the type of TV set you own, select the signal mode you wish to watch the DVD/VCD. The default or automatic setting is "Auto".

SELECTING GAMMA SETTING

To select the appropriate gamma according to your video monitor, one selects the Setup menu from the remote. Choose "Gamma", then select from the choices that are available.

- 1 From the drop-down menu of the OSD screen, use the navigation keys to select the video icon, and press the **ENTER** on the remote
- 2 Using the navigation arrows, select "Gamma" and then press **ENTER**. Choose the colour/intensity linearity for your video monitor and press **ENTER**. The default setting is 1.000



NOTES

- Each monitor or display device has a Gamma setting. Please refer to your owner's manual for your TV/monitor for the optimum Gamma setting. If you do not know your setting, use the default of 1.000.
- Please refer to the Reference section video adjustment chart on pages 28 and 33 regarding the features available on each video output.

SELECTING BLACK LEVEL

Personal taste may require the adjustment of the black level for the DVD disc you are viewing to either "0" or "+7.5" IRE. This adjustment sets the reference level for absolute black as seen on your TV set. To select the appropriate Black Level according to your signal mode, one selects the Setup menu from the remote. Choose 'Video', 'Black Level', then either of the two choices that are available.

- 1 From the Drop-down menu of the OSD screen, use the navigation keys to select video icon, and press **ENTER** on the Remote
- 2 Using the navigation arrows, select "Black Level" and press **ENTER**
- 3 Using the navigation arrows, select either '0' or '+7.5' IRE and press **ENTER**

NOTES

- The black level defaults are different for each type of T585; NTSC T585 is +7.5 IRE, PAL T585 is 0 IRE.
- Setting the black level incorrectly may result in poor contrast when displaying dark scenes.
- Please refer to the Reference section video adjustment chart on pages 28 and 33 regarding the features available on each video output.



Setup

INITIAL SETUP SETTINGS

SELECTING BRIGHTNESS LEVEL

Depending on the settings of your monitor, you may wish to adjust the brightness of the viewed media from your T585 instead of the monitor. The brightness can be fine tuned to your video monitor.

- 1 From the drop-down menu of the OSD screen, use the navigation keys to select the video icon, and press the **ENTER** on the remote
- 2 Using the navigation arrows, select "Brightness" and then press **ENTER**. Choose the level of brightness for your video monitor and press **ENTER**. The default setting is "0"

NOTE

- Please refer to the Reference section video adjustment chart on pages 28 and 33 regarding the features available on each video output.

SELECTING CONTRAST LEVEL

Depending on the settings of your monitor, you may wish to adjust the contrast of the viewed media from your T585 instead of the monitor. The contrast can be fine tuned to your video monitor.

- 1 From the drop-down menu of the OSD screen, use the navigation keys to select the video icon, and press the **ENTER** on the remote
- 2 Using the navigation arrows, select "Contrast" and then press **ENTER**. Choose the level of Contrast for your video monitor and press **ENTER**. The default setting is "0".

NOTE

- Please refer to the Reference section video adjustment chart on pages 28 and 33 regarding the features available on each video output.

SELECTING SATURATION LEVEL

Both NTSC, PAL/PAL-60 allow SATURATION (colour level) adjustments to fine tune your monitor's colour balance.

- 1 From the drop-down menu of the OSD screen, use the navigation keys to select the video icon, and press the **ENTER** on the remote.
- 2 Using the navigation arrows, select "Saturation" and then press **ENTER**. With this adjustment, you may set different colour levels for your video monitor and press **ENTER**. The default setting is 0.

NOTE

- Please refer to the Reference section video adjustment chart on pages 28 and 33 regarding the features available on each video output.



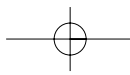

Setup

INITIAL SETUP SETTINGS

SELECTING VIDEO ADJUSTMENT OPTIONS

	Black Level	Brightness	Contrast	Saturation	Sharpness	Gamma
HDMI						
480/576		●	●	●		
720p		●	●	●		
1080i		●	●	●		
VGA						
480/576		●	●	●		
720p		●	●	●		
1080i		●	●	●		
Component YPbPr						
480p/576p		●	●	●	●	●
720p		●	●	●	●	●
Component YCbCr						
480i/576i	●	●		●		
1080i		●	●	●	●	●
CVBS						
480i/576i	●	●		●		
S-Video						
480i/576i	●	●		●		
SCART/RGB						
480i/576i		●		●		

Note: For European version T585, see page 37 for available video output options.

Setup

INITIAL SETUP SETTINGS

SELECTING DIGITAL AUDIO OUTPUT AND OTHER SETTINGS

DIGITAL AUDIO OUTPUT

Each DVD disc has a variety of audio output options. Set the player's digital audio output according to the type of audio system you use.

- From the drop-down menu of the OSD screen, press the navigation buttons to select the audio icon and then use the navigation buttons on the remote to select the options. Then press ENTER

Formats	Sample Frequency
Dolby Digital/PCM	48KHz
Stream/PCM	96KHz
PCM	192KHz HDMI

NOTES

A Sample Frequency of 192KHz is available on the HDMI output only.

If an active digital audio output signal is supplied to a receiver or other equipment without a corresponding digital decoding capability, a very loud noise may be produced which could permanently damage the speakers.

The DTS DVD disc sound is played back only when the DVD player is connected to a receiver with a DTS decoder.

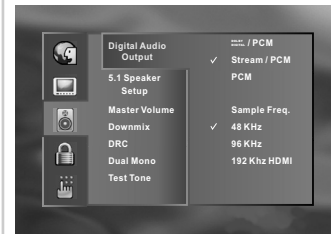

ENGLISH

NOTES ON DISCS

ON HANDLING DISCS

- Do not touch the playback side of the disc.
- Do not attach paper or tape to discs. To do so may cause the discs to jam inside the machine

ON CLEANING DISCS

- Fingerprints and dust on the disc cause picture and sound deterioration. Wipe the disc from the centre outward with a soft cloth. Always keep the disc clean.
- If you cannot wipe off the dust with a soft cloth, wipe the disc lightly with a slightly moistened soft cloth and finish with a dry cloth wiping from the centre outward, not in a spiral rotation.
- Do not use any type of solvents such as thinner, benzene, commercially available cleaners or anti-static spray for vinyl LPs. They may damage the disc.
- The T585's OSD may display "ERROR: DISC MINOR - CLEAN ME". If it does, clean the disc as mentioned above.

ON STORING DISCS

- Do not store discs in a place subject to direct sunlight or near heat sources.
- Do not store discs in places subject to moisture and dust such as a bathroom or near a humidifier.
- Store discs vertically in a case. Stacking or placing objects on discs outside of their case may cause warping.

ABOUT THIS OWNER'S MANUAL

This owner's manual explains the basic instructions of this T585. Some DVD/VCD/CD media have functions that may not be explained in this owner's manual. Therefore, some instructions may differ from the T585 owner's manual, and there may be extra instructions. In this case, follow the instructions displayed on the media package or displayed on the OSD during operation

NOTE

- Refer to the owner's manual of your audio equipment as well. When you connect the T585 to other equipment, be sure to turn off the power and unplug all of the equipment from the wall outlet before making any connections. The output sound of the T585 has a wide dynamic range. Be sure to adjust the receiver's volume to a moderate listening level. Otherwise, the speakers may be damaged by a sudden high volume sound. Turn off the receiver before you connect or disconnect the T585's power cord. If you leave the receiver power on, the speakers may be damaged.

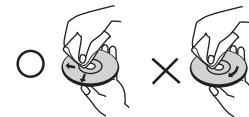

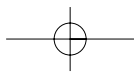



Reference

PLAYABLE DISCS

The T585 can play back the following discs.

	Disc Mark	Contents	Disc size	Maximum playback time
DVD video DVD audio discs		Audio+ Video (moving pictures)	12 cm	Approx. 4 hours (single sided disc)
				Approx. 8 hours (double sided disc)
			8 cm	Approx. 80 minutes (single sided disc)
				Approx. 160 minutes (double sided disc)
Audio CDs SACDs		Audio	12 cm	74 minutes
			8 cm	20 minutes

In addition this unit can play back a CD-R or CD-RW that contains audio titles or MP3 files

You cannot playback discs other than those listed above such as; CD-ROM, CD-Extra, CD-G, and CD-i discs. To do so may render the T585 permanently inoperable.

REGION MANAGEMENT INFORMATION

Region Management Information: This DVD Player is designed and manufactured to respond to the Region Management Information that is recorded on a DVD disc. If the Region number described on the DVD disc does not correspond to the Region number of this DVD player, this DVD player cannot play that disc. Please contact your dealer for the region number for your T585.

NOTES ON UNAUTHORIZED DISCS

You may not be able to play back some DVD video discs on this player if they were purchased from outside your geographic area or made for business purposes. When you try to play back an unauthorized disc, "**Check Regional Code**" appears on the TV screen.

ENGLISH

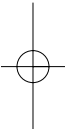
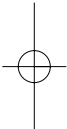

Reference

TABLE OF LANGUAGES AND THEIR ABBREVIATIONS

Enter the appropriate code number in the Settings' drop-down-menu, 'Other' for "Audio", "Subtitle", "Menu" and/or "Text". Be aware that this is a media specific feature that may not be available for all DVDs and VCDs.

Code	Language	Code	Language	Code	Language	Code	Language
6565	Afar	7079	Faroese	7678	Lingala	8375	Slovak
6566	Abkhazian	7082	French	7679	Laothian	8376	Slovenian
6570	Afrikaans	7089	Frisian	7684	Lithuanian	8377	Samoaan
6577	Ameharic	7165	Irish	7686	Latvian, Lettish	8378	Shona
6582	Arabic	7168	Scots Gaelic	7771	Malagasy	8379	Somali
6583	Assamese	7176	Galician	7773	Maori	8381	Albanian
6588	Aymara	7178	Guarani	7775	Macedonian	8382	Serbian
6590	Azerbaijani	7185	Gujarati	7776	Malayalam	8385	Sudanese
6665	Bashkir	7265	Hausa	7778	Mongolian	8386	Swedish
6669	Byelorussian	7273	Hindi	7779	Moldavian	8387	Swahili
6671	Bulgarian	7282	Croatian	7782	Marathi	8465	Tamil
6672	Bihari	7285	Hungarian	7783	Malay	8469	Telugu
6678	Bengali; Bangla	7289	Armenian	7784	Maltese	8471	Tajik
6679	Tibetan	7365	Interlingua	7789	Burmese	8472	Thai
6682	Breton	7378	Indonesian	7865	Nauru	8473	Tigrinya
6765	Catalan	7383	Icelandic	7869	Nepali	8475	Turkmen
6779	Corsican	7384	Italian	7876	Dutch	8476	Tagalog
6783	Czech	7387	Hebrew	7879	Norwegian	8479	Tonga
6789	Welsh	7465	Japanese	7982	Oriya	8482	Turkish
6865	Danish	7473	Yiddish	8065	Panjabi	8484	Tatar
6869	German	7487	Javanese	8076	Polish	8487	Twi
6890	Bhutani	7565	Georgian	8083	Pashto, Pushto	8575	Ukrainian
6976	Greek	7575	Kazakh	8084	Portuguese	8582	Urdu
6978	English	7576	Greenlandic	8185	Quechua	8590	Uzbek
6979	Esperanto	7577	Cambodian	8277	Rhaeto-Romance	8673	Vietnamese
6983	Spanish	7578	Kannada	8279	Rumanian	8679	Volapük
6984	Estonian	7579	Korean	8285	Russian	8779	Wolof
6985	Basque	7583	Kashmiri	8365	Sanskrit	8872	Xhosa
7065	Persian	7585	Kurdish	8368	Sindhi	8979	Yoruba
7073	Finnish	7589	Kirghiz	8372	Serbo-Croatian	9072	Chinese
7074	Fiji	7665	Latin	8373	Singhalese	9085	Zulu

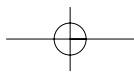

Reference

TROUBLESHOOTING

SYMPTOMS AND CORRECTION

Check the following guide for the possible cause of a problem before contacting service.

SYMPTOM	CAUSE	CORRECTION
No power	<ul style="list-style-type: none"> The power cord is disconnected 	<ul style="list-style-type: none"> Plug the power cord into the wall outlet securely.
The power is on, but the DVD player does not work	<ul style="list-style-type: none"> No disc is inserted. 	<ul style="list-style-type: none"> Insert a disc (Check that the DVD or VCD indicator in the T585's display is lit).
No picture	<ul style="list-style-type: none"> The TV is not set to receive DVD signal output. 	<ul style="list-style-type: none"> Select the appropriate video input mode on the TV so that the picture from the DVD player appears on the TV screen. See page 34 for correct scan types.
	<ul style="list-style-type: none"> The video cable is not connected securely. 	<ul style="list-style-type: none"> Connect the video cable into the jacks securely.
	<ul style="list-style-type: none"> The connected TV power is turned off. 	<ul style="list-style-type: none"> Turn on the TV.
No sound	<ul style="list-style-type: none"> The equipment connected with the audio cable is not set to receive DVD signal output. 	<ul style="list-style-type: none"> Select the correct input mode of the audio receiver so you can listen to the sound from the DVD player.
	<ul style="list-style-type: none"> The audio cables are not connected securely. 	<ul style="list-style-type: none"> Connect the audio cable into the jacks securely.
	<ul style="list-style-type: none"> The power of the equipment connected with the audio cable is turned off. 	<ul style="list-style-type: none"> Turn on the equipment connected with the audio cable.
	<ul style="list-style-type: none"> The Audio output settings are incorrect. 	<ul style="list-style-type: none"> Select the digital and analog output settings depending on your hardware configuration. See page 29 for setup.
The playback picture is poor	<ul style="list-style-type: none"> The disc is dirty. 	<ul style="list-style-type: none"> Clean the disc.
The DVD player does not start playback	<ul style="list-style-type: none"> No disc is inserted. 	<ul style="list-style-type: none"> Insert a disc (Check that the DVD or VCD indicator in the T585's display is lit).
	<ul style="list-style-type: none"> An unplayable disc is inserted. 	<ul style="list-style-type: none"> Insert a playable disc (Check the disc type, colour system and Regional code).
	<ul style="list-style-type: none"> The disc is placed upside down. 	<ul style="list-style-type: none"> Place the disc with the playback side down.
	<ul style="list-style-type: none"> The disc is not placed within the guide. 	<ul style="list-style-type: none"> Place the disc on the disc tray correctly inside the guide.
	<ul style="list-style-type: none"> The disc is dirty. 	<ul style="list-style-type: none"> Clean the disc.
	<ul style="list-style-type: none"> A menu is on the TV screen. 	<ul style="list-style-type: none"> Press the SETUP button to turn off the menu screen.
	<ul style="list-style-type: none"> The remote control is not pointed at the remote sensor of the DVD player. 	<ul style="list-style-type: none"> Point the remote control at the remote sensor of the DVD player.
The remote control does not work properly	<ul style="list-style-type: none"> The remote control is too far from the DVD player. 	<ul style="list-style-type: none"> Operate the remote control within about 23 ft (7 m).
	<ul style="list-style-type: none"> There is an obstacle in the path of the remote control and the DVD player. 	<ul style="list-style-type: none"> Remove the obstacle.
	<ul style="list-style-type: none"> The batteries in the remote control are exhausted. 	<ul style="list-style-type: none"> Replace the batteries with new ones.

Reference

SPECIFICATIONS

Video DAC	3 x 12-Bit 256MHz DAC 6 x 10-Bit 27MHz DAC
Video output	HDMI Component Video (Y/CrPr/CbPb) Composite Video S-Video (Y/C) VGA (15pin) Euro SCART with RGB & Composite HD Progressive scan 720P
Digital Zoom	Still & Moving Picture
TV Type Setup	PAL/PAL-60/ NTSC
Audio DAC	192 KHz/24 Bit
MPEG-2 Multi channel	MPEG-2 Decoder Built in
MP3 Decoder	Digital Output, Stereo on downmix output
SACD	5.1 Channel support on digital output 5.1 Channel support on analogue output
DVD-Audio	5.1 Channel support on digital output 5.1 Channel support on analogue output
Dolby Digital	5.1 Channel support on digital output 5.1 Channel support on analogue output 2 Channel downmix analogue
HDCD	5.1 Digital support on digital output 2 channel analogue
DTS	5.1 Digital support on digital output
Down mix	Stereo Left & Right or Lt & Rt Channel Mono, Mono Left, Mono Right, & Stereo
Digital Audio Output	Coaxial Output Optical Output
Others	Dolby/PCM, bit stream/PCM, PCM
Shipping Weight Net	8.63 kg (19 lb)
Shipping Weight Gross	15.2 kg (33.5 lb)
Unit Dimensions (W x H x D)*	Net 435 mm x 100 mm x 300 mm Gross 435 mm x 114 mm x 305 mm

ENGLISH

*Gross dimensions include feet, disc tray, and rear connections

Specifications are subject to change without notice. For updated documentation and features please log onto www.nadelectronics.com for the latest information about your T585.

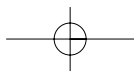

Reference

COPYRIGHT INFORMATION

ENGLISH

COPYRIGHT INFORMATION/MACROVISION PRODUCT NOTICE

MACROVISION PRODUCT NOTICE

This product incorporates copyright protection technology that is protected by method claims of certain U.S. patents and other intellectual property rights owned by Macrovision Corporation and other rights owners. Use of this copyright protection technology must be authorized by Macrovision Corporation, and is intended for home and other limited viewing uses only unless otherwise authorized by Macrovision Corporation. Reverse engineering or disassembly is prohibited.

CONSUMERS SHOULD NOTE THAT NOT ALL HIGH DEFINITION TELEVISION SETS ARE FULLY COMPATIBLE WITH THIS PRODUCT AND MAY CAUSE ARTIFACTS TO BE DISPLAYED IN THE PICTURE. IN CASE OF T585 PROGRESSIVE SCAN PICTURE PROBLEMS, IT IS RECOMMENDED THAT THE USER SWITCH THE CONNECTION TO THE STANDARD DEFINITION INTERLACE OUTPUT. IF THERE ARE QUESTIONS REGARDING YOUR TV SET COMPATIBILITY WITH THIS PRODUCT MODEL T585 DVD PLAYER, PLEASE CONTACT NAD ELECTRONICS INTERNATIONAL CUSTOMER SERVICE, +1 905 831 0799.

It is forbidden by law to copy, broadcast, show, broadcast on cable, play in public, and rent copyrighted material without permission. DVD video discs are copy protected, and any recordings made from these discs will be distorted. This product incorporates copyright protection technology that is protected by method claims of certain U.S. patents and other intellectual property rights owned by Macrovision Corporation and other rights owners. Use of this copyright protection technology must be authorized by Macrovision Corporation, and is intended for home and other limited viewing uses only, unless otherwise authorized by Macrovision Corporation. Reverse engineering or disassembly is prohibited.

DOLBY LABORATORIES NOTICE

This product is manufactured under license from Dolby Laboratories. Dolby, Pro Logic, and the double-D symbol are trademarks of Dolby Laboratories. Confidential Unpublished works. Copyright 1992-1997 Dolby Laboratories. All rights reserved.

DIGITAL THEATER SYSTEMS NOTICE

"DTS" and "DTS Digital Surround" are registered trademarks of Digital Theater Systems, Inc.

SUPER AUDIO COMPACT DISC (SACD)

SACD, the SACD logo, and Super Audio Compact Disc are trademarks or registered trademarks of Sony Corporation and Royal Philips Electronics.

HI-DEFINITION MULTIMEDIA INTERFACE

HDMI, the HDMI logo and High-Definition Multimedia Interface are trademarks or registered trademarks of HDMI Licensing, LLC.



Reference**NOTES****VIDEO OUTPUT SCAN TYPES (EUROPEAN)**

	480I/576I	480P/576P	720P	1080I
HDMI		■	■	■
VGA		■	■	■
SCART/RGB	■			
Component YPbPr				
Component YCbCr	■			
CVBS	■			
S-Video	■			

VIDEO OUTPUT SCAN TYPES (NORTH AMERICAN)

	480I/576I	480P/576P	720P	1080I
HDMI		■	■	■
VGA		■	■	■
Component YPbPr		■	■	
Component YCbCr	■			■
CVBS	■			
S-Video	■			

ENGLISH

Reference

ADDENDUM

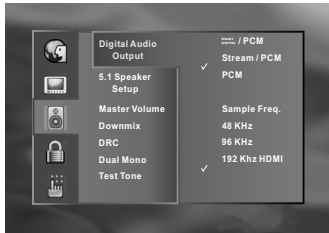

HIGH RESOLUTION DVD-AUDIO STEREO 192KHZ 24-BIT DISCS

When playing 192KHz 24-bit High resolution DVD-audio stereo discs through the **MIXED AUDIO OUT**, it is necessary to select the option 192 kHz HDMI in the Digital Audio Output OSD menu.

Please note: Do not forget to revert this setting to 48kHz or 96kHz for normal playback of other types of media.

DIGITAL OUT (COAXIAL AND OPTICAL) VERSES MEDIA FORMAT

	DVD-Audio (96 kHz/24-bit)	DVD-LPCM (48/96 kHz)	Dolby Digital	DTS	CD
48 kHz	■	■	■	■	■
96 kHz	■	■	■	■	■
192 kHz		■	■	■	■

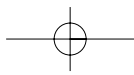

ENGLISH

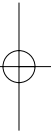
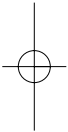

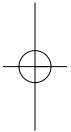
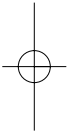
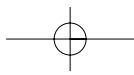

www.NADelectronics.com

**©2006 NAD ELECTRONICS INTERNATIONAL
A DIVISION OF LENBROOK INDUSTRIES LIMITED**

All rights reserved. No part of this publication may be reproduced, stored or transmitted in any form without the written permission of NAD Electronics International

T585 Manual 02/06



Free Manuals Download Website

<http://myh66.com>

<http://usermanuals.us>

<http://www.somanuals.com>

<http://www.4manuals.cc>

<http://www.manual-lib.com>

<http://www.404manual.com>

<http://www.luxmanual.com>

<http://aubethermostatmanual.com>

Golf course search by state

<http://golfingnear.com>

Email search by domain

<http://emailbydomain.com>

Auto manuals search

<http://auto.somanuals.com>

TV manuals search

<http://tv.somanuals.com>