

NAD®

HTR-5

LCD TOUCH SCREEN PREPROGRAMMED
AND LEARNING REMOTE CONTROL



ENG

ENG

Introduction4
Battery Installation5
Summary of Operations6
LCD Screen and Button Layout7
Getting Ready with System Setting10
Programming the Remote Control11
 Preprogramming Method11
 Learning method14
 Erasing the learned buttons16
System and Operations Set Up18
 Setting up the system18
 Macro and Punch Through Programming19
 Programming Punch Through Functions21
To Edit the Buttons on LCD22
 To Move buttons22
 To Copy buttons23
 To Delete buttons24
 To Insert buttons25
 To Change buttons26
 To Edit a text27
Clock Setting28
Loading Programs with PC28
LCD Screen Alignment29
LCD Screen Contrast29
Caution on LCD Screen30
Memory Lock30
Erasing all the Programs30
Warranty30
Specifications31
Appendix A. Set up Function Table32 - 43
Appendix B. Set up code Table44 - 57

INTRODUCTION

Thank you for choosing the NAD HTR-5 Home Theater Remote Control. The HTR-5 is one of the most powerful and flexible remote controllers on the market today, allowing you to have complete control of up to twelve different components (devices). Powerful "macros" are available to send a complex series of commands which allow you to automate the process of turning on and selecting the correct inputs and proper settings of all your audio and video components.

The HTR-5 includes a LCD touch panel that features a "paged" display with 4 pages for each of the 12 devices. This keeps operation simple by only showing the buttons needed for operating the chosen device. Pressing the "page" button sequentially shows all the available functions for the selected device. Frequently used buttons like Volume and Channel are always available.

The remote commands and custom button layouts for all NAD products are already programmed into the HTR-5. Other components (your TV and Satellite Receiver, for example) can be easily programmed, either from the included pre-programmed code library or you can teach up to 780 buttons into the HTR-5 from your original remote controls.

With the HTR-5 you can change the button size and shape and edit the text on the button in the LCD, allowing you to customize your remote control exactly to your own preferences. These changes can be directly programmed using just the HTR-5, or you can link the HTR-5 to your personal computer with the supplied cable to make programming easier.

The HTR-5 is easy to program and operate once you understand the way it is organized. We strongly recommend that you read completely through the manual to familiarize yourself and other members of your family with the many features and operating conventions of the HTR-5.

ENG

BATTERY INSTALLATION

HTR-5 uses four AA batteries. Please be sure to match the batteries with the (+) and (-) markings inside the battery compartment during installation. The remote control self-tests for three seconds after the batteries are installed and then automatically moves to the setting mode for programming.

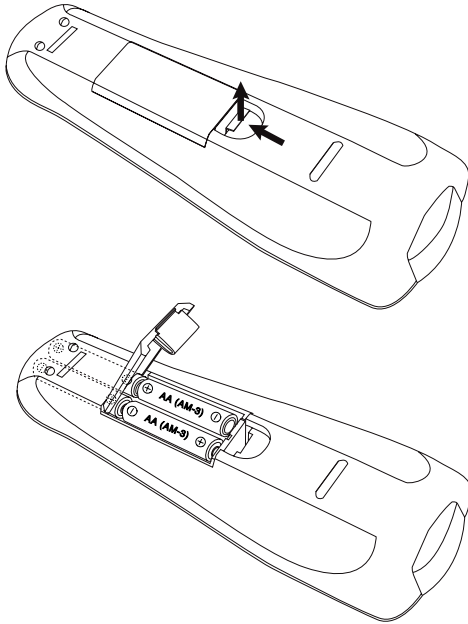

ENG

NOTE

Please do not mix old batteries with new ones or mix different types of batteries.

SUMMARY OF OPERATIONS

DESCRIPTION OF DEVICES

The HTR-5 is designed to operate up to twelve components. They are **Audio, CATV, Satellite, TV, DVD, VCR1, VCR2, Laser Disc, Tuner, CD, Tape** and **AUX**. However, the device button name can be changed to meet your exact needs. You can also create a favorite device page and transfer the frequently used devices to the favorite device page in order to change the device button sizes and shapes. Once you create the favorite device page, it will appear as a default device page. Please refer to COPY in EDITING Section on page 23 for details.

There are also four pages of the LCD screen for each device and you can use them to create, delete or edit any functional buttons to customize with your audio/video components. Please refer to EDITING on page 22 for details.

PRE-PROGRAMMED CODES

The HTR-5 comes with preprogrammed codes for practically all the major audio and video equipment that are on the market. You can operate all of your components with the HTR-5 simply by punching in the three-digit code number that is assigned to your brand. The code numbers for various brands and components are listed in the instruction manual. Please refer to the programming instruction shown on page 11 for details.

LEARNING

The HTR-5 can also learn practically all the codes from your original remote controls. There are 50 LCD screens in the remote control and all the functional buttons in the LCD can be taught. In addition, there are eleven rubber buttons and a joystick that contains five functions. Each of these buttons and the joystick functions can be taught in each of the twelve devices. In general, you can teach up to 780 new functions into the remote control. Please refer to page 14 in the instruction manual for details.

ENG

MACRO OPERATION

The remote control is capable of sending out a series of commands with the single press of a button. There are three types of macro buttons you can use for such macro operations and they are as follows:

- 1 M1, M2 and M3 buttons on MAIN page.** Each of these three buttons are designed to send out up to 28 series of commands you programmed into the buttons. It is generally used to turn on and turn off all of your A/V components with the single press of a button.
- 2 Device buttons on Main page.** There are twelve device buttons on the MAIN page and each of these device buttons can send out up to 14 commands which you have programmed into the device button. It is generally used to send out audio input codes so that the audio receiver will make an automatic input switch when you press the respective device button in the remote control.
- 3 Favorite Channel buttons.** You can create up to 60 favorite channel buttons in the remote control by programming the most often watched channel numbers into these buttons. Each of these buttons can send out up to 14 commands. You can also use them for any other purpose. Please refer to page 19 of the manual for programming the macro operations.

PUNCH THROUGH

This is designed to operate audio equipment volume control buttons (VOLUME UP and DOWN and MUTE) while all the other buttons control video equipment. You can also operate transport functions (PLAY, STOP, REWIND and FAST FORWARD buttons) from VCR, DVD, LD, CD or any other mode while all other buttons in the remote control are operating different components. You can also set up "punch-through" on CHANNEL buttons. Please refer to page 21 in the manual for details.

SUMMARY OF OPERATIONS

EDITING THE BUTTONS ON LCD SCREEN

You can change the size and shape of the buttons on the LCD screen. You can also create, delete, copy and move the buttons from one location to another on the LCD. In addition, you can erase text and write your own on the buttons using different font sizes. This can be done either directly on the remote control without a personal computer or with the aid of a personal computer. Please refer to page 22 in the manual for details.

LOADING PROGRAM

The HTR-5 is capable of receiving software programs and data through the Internet. You can also upload programs and data in the remote control to your personal computer and download them to another HTR-5. Please refer to page 28 in the manual for details.

ALL OTHER OPERATIONS

You can set the duration of the back light or the LCD display to stay on as well as low battery warning level and the "beep" sound level. Please refer to page 18 in the manual for details.

You can also set the time, date and year that are displayed in the remote control by following the procedures shown on page 28 of the manual.

LCD SCREEN AND BUTTON LAYOUT

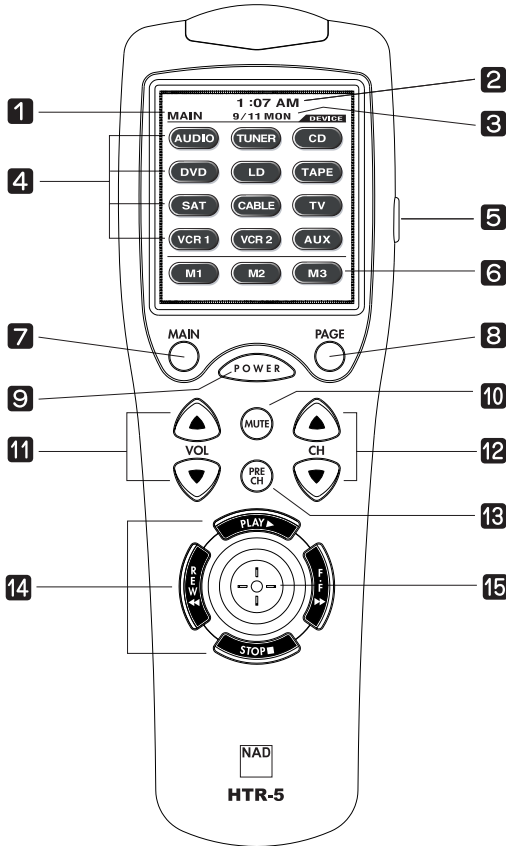

- 1 Displays the name of the device selected
- 2 Displays the data and clock
- 3 Displays page number
- 4 Displays the device names
- 5 LIGHT button
- 6 MACRO buttons
- 7 MAIN DEVICE menu button
- 8 LCD Page change button
- 9 POWER
- 10 MUTE
- 11 VOLUME
- 12 CHANNEL
- 13 Previous channel button
- 14 TRANSPORT functions (PLAY, STOP, REWIND and FF) for VCR, CD and DVD etc.
- 15 JOYSTICK button (UP, DOWN, LEFT, RIGHT and ENTER) to move the cursor and enter the selection by pushing down the joystick.

ENG

GETTING READY WITH SYSTEM SETTING

All the programming is done by first entering the SYSTEM SETTING mode in the remote control. Press both the MAIN and PAGE buttons simultaneously for five seconds to enter the SYSTEM SETTING mode.

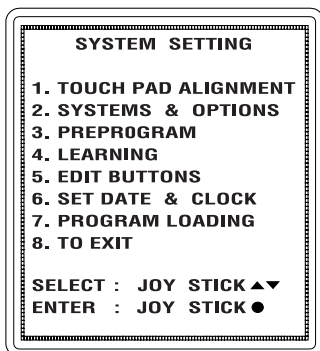

Move the cursor on the screen with the joystick to your selection in the list. Enter the selection by pushing down the joystick.

You can exit the setting mode by simply pressing the MAIN button or bring the cursor to **8. TO EXIT** with joystick and push the joystick down.

PROGRAMMING THE REMOTE CONTROL

You can program the HTR-5 to make it compatible with all of your components by following either the preprogramming method or teaching it using your original remote controls.

PREPROGRAMMING METHOD

USING A THREE-DIGIT CODE NUMBER:

- 1 Turn on the component you plan to operate manually.
- 2 Go to the program setting mode by pressing both the MAIN and PAGE buttons simultaneously for five seconds.
- 3 Using the joystick, move the cursor down in the LCD screen to **3. PREPROGRAM**.
- 4 Push the joystick down to enter the preprogramming mode.
- 5 Select the device on the LCD screen that you wish to program, (e.g. To program DVD, press the DVD device button).

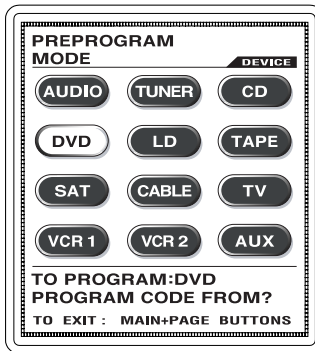

- 6 Select the device from which the three digit code number table will be selected, (e.g. If it is from the DVD code table, press the DVD device button).
- 7 Point the remote control toward the component and enter the three-digit code number you selected for your component from the code table on page 44 - 57. (Please enter the code number within 20 seconds of programming). If there is more than one code number assigned to your brand, try one code number at a time until you find the right code number. (If you entered the right code number, the component will turn off immediately after you entered the number). When the right code number has been entered, save the code by pressing the SAVE button on the LCD.

ENG

PROGRAMMING THE REMOTE CONTROL



- 8 Confirm that you entered the right code number that matches your component by pressing other buttons such as POWER, VOLUME, MUTE and CHANNEL. If any of the buttons do not operate as they should, please repeat from Step 5.
- 9 Continue to program other components by repeating from the above step 5.
- 10 Once you have completed programming all the devices, exit from the programming mode by pressing both the MAIN and PAGE buttons simultaneously.
- 11 You will now be in the setting mode once again. Move the cursor to **8. TO EXIT** and press the joystick down or simply press the MAIN button to exit to main menu.

AUTO SCAN WITH BRAND NAMES

- 1 Manually turn on the component you plan to operate.
- 2 Go to program setting mode in the remote control by pressing both the MAIN and PAGE buttons simultaneously for five seconds.
- 3 Using the joystick, move the cursor down in the LCD screen to **3. PREPROGRAM**.
- 4 Push the joystick down to enter the preprogram mode.
- 5 Select the device you wish to program in the LCD screen, (e.g. To program DVD, press the DVD device button).
- 6 Select the device from which the three digit code number will be selected, (e.g. If it is from the DVD code table, press the DVD device button).

ENG

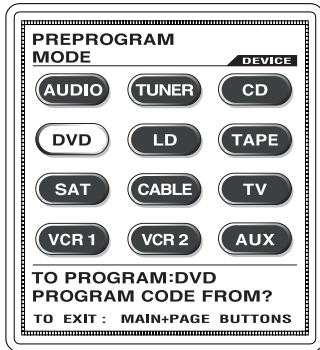

- 7 Point the remote control to the component and press the BRAND button.
- 8 Press the number button on LCD screen that bears the first alphabetical character of your brand name. (Please press the number button within 20 seconds of programming).

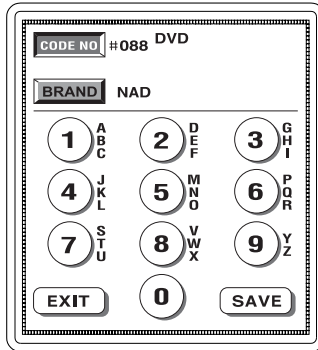

Please note that pressing the number button once will only show the first letter in that alphabet group. You will need to press again to obtain the other letters.

- 9 If the first code number assigned to the brand is the right one, it will turn off the component. If it is not the right one or if it is not the right brand name, press the Channel Up button. It will automatically send out a POWER OFF command either from the next code number from the same brand or the code from the next brand. Keep the Channel Up button pressed until it turns off the component. When the component turns off, save the code by pressing the SAVE button on the LCD. Note: It is quite possible that the code number that works with your component may have a different brand name because of the way it was made by its manufacturer.

NOTE

Confirm that it is the right code number for your component by pressing other buttons such as POWER, VOLUME, MUTE and CHANNEL, etc. If any of the buttons do not operate as they should, please repeat from Step 5.

PROGRAMMING THE REMOTE CONTROL

- 10 Continue to program other components by repeating from Step 5.
- 11 Once you have completed programming all the devices, exit from the programming mode by pressing both the MAIN and PAGE buttons simultaneously.
- 12 You will be in the setting mode. Move the cursor to **8. TO EXIT** and press the joystick down or simply press the MAIN button to exit to the main menu.

LEARNING METHOD

You can also teach any of the buttons in the remote control except the MAIN and PAGE buttons with the following steps:

- 1 Go to the program setting mode by pressing both the MAIN and PAGE buttons simultaneously for five seconds.
- 2 Move the cursor to **4. LEARNING** with the joystick and then push the joystick down to enter the learning mode.
- 3 If you wish to teach any of the functional buttons in the device, keep the cursor to COMMON BUTTON and select the device that you wish to enter. If you wish to teach the twelve device buttons shown on the LCD, press the MUTE button to move the cursor to the DEVICE BUTTON and select the device on the LCD that you wish to teach.

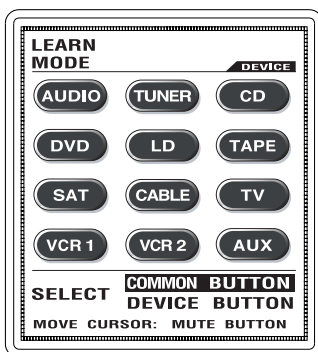

ENG

PROGRAMMING THE REMOTE CONTROL

- 4 Place your original remote control to the HTR-5 head to head about 2-3 inches apart as shown below.

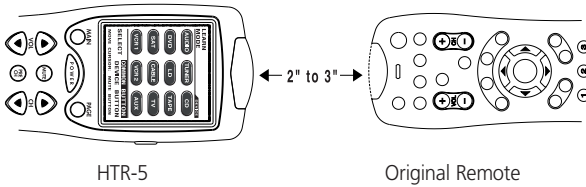

- 5 Press either the device button or functional button, whichever you wish to teach in the HTR-5. It is now ready to learn on the button you selected.
- 6 Press the button on your original remote control that you wish to teach the HTR-5. The HTR-5 will "beep" indicating that it has received the signal and the LCD will show "RETRY". (Please enter the code signal within 20 seconds of programming).
- 7 Press the same button on the original remote control a second time to ensure correct learning. The HTR-5 will beep a second time with "GOOD" flashed on the LCD screen, indicating that it learned the code correctly. If it flashes "FAIL", repeat from Step 5 until it learns successfully.
- 8 Move on to the next button (or device) that you wish to teach by repeating from Step 5. If you are teaching functional buttons, you can also move on to teach the buttons in the next page by pressing the PAGE button.
- 9 Once you complete the teaching and wish to exit from the learning mode, press the MAIN button to go back to the main page of the learning mode. Exit from the Main page by pressing both the MAIN and PAGE buttons simultaneously.
- 10 You will now be in the setting mode once again. Move the cursor to **8. TO EXIT** and press down the joystick or simply press the MAIN button to exit to the main menu.

ENG

PROGRAMMING THE REMOTE CONTROL

TO ERASE THE LEARNED BUTTONS

TO ERASE A SINGLE BUTTON:

- 1 Go to the program setting mode by pressing both the MAIN and PAGE buttons simultaneously for five seconds.
- 2 Move the cursor to **4. Learning** with the joystick and then push the joystick down to enter the learning mode.
- 3 Move the cursor to COMMON BUTTON and select the device that contains the functional button you wish to erase. If you wish to erase the function in the device button, move the cursor to DEVICE BUTTON.

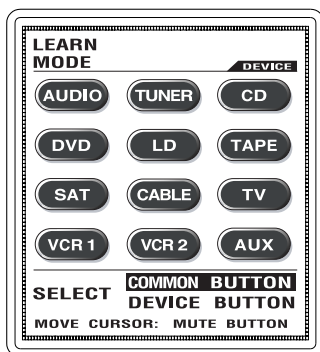

- 4 Press the functional button or device button you wish to erase for three seconds or more and it will flash "ERASED". Repeat this step for other buttons you wish to erase.
- 5 Once you completed erasing and wish to exit from this mode, press the MAIN button to go back to the main page of the learning mode. Exit from the Main page by pressing both the MAIN and PAGE buttons simultaneously.
- 6 You will now be in the setting mode once again. Move the cursor to **8. TO EXIT** and press down the joystick or simply press the MAIN button to exit to the main menu.

TO ERASE ALL THE LEARNED COMMANDS IN A SINGLE DEVICE:

- 1 Go to the program setting mode by pressing both the MAIN and PAGE buttons simultaneously for five seconds.
- 2 Move the cursor to **4. Learning** with the joystick and then push the joystick down to enter the learning mode.

- 3 Press the MUTE button to move the cursor to the DEVICE BUTTON and keep the device button you wish to erase all the learned commands down for five seconds until the LCD shows ERASED. This will erase the function taught in the device button. If you continue to press the device button for another five seconds, it will erase all the functions in the device.
- 4 Once you complete the erasing and wish to exit from this mode, press the MAIN button to go back to the main page of the learning mode. Exit from the Main page by pressing the MAIN and PAGE buttons simultaneously.
- 5 You will be in the setting mode once again. Move the cursor to **8. TO EXIT** and press down the joystick or simply press the MAIN button to exit to the main menu.

TO ERASE ALL THE LEARNED COMMANDS IN ALL TWELVE DEVICES:

- 1 Go to the program setting mode by pressing both the MAIN and PAGE buttons simultaneously for five seconds.
- 2 Move the cursor to **4. LEARNING** with the joystick and then push the joystick down to enter the learning mode.
- 3 Press both the POWER and STOP buttons simultaneously for five seconds in the learning mode. The LCD will show ERASED after it has erased all the learned commands in the remote control.
- 4 Once you complete the erasing and wish to exit from this mode, press both the MAIN and PAGE buttons simultaneously.
- 5 You will be in the setting mode once again. Move the cursor to **8. TO EXIT** and press down the joystick or simply press the MAIN button to exit to the main menu.

NOTE

Preprogrammed code will be automatically restored when the learned function is erased.

SYSTEM AND OPERATIONS SETUP

Go to the program setting mode by pressing both the MAIN and PAGE buttons simultaneously for five seconds. Move the cursor on the LCD screen to **2. SYSTEM & OPTIONS** with the joystick. Enter this mode by pushing the joystick down and the following can be programmed:

SETTING UP THE SYSTEM

The LCD screen will list the following choices:

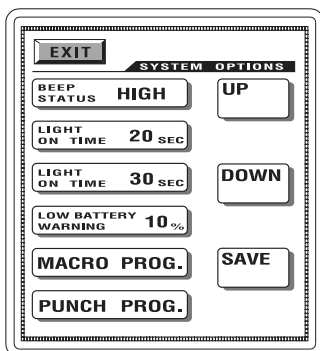

	Range	Default
Buzzer Status:	High, Low, Off	High
Back Light On Time:	0 - 120 seconds	20 seconds
LCD on Time:	5 - 120 seconds	30 seconds
Warning of Low Battery:	10% - 50% level	10 %

Select the button you wish to change from the list first. Press the UP or DOWN buttons on the LCD to set them up. Once you set them up, press the SAVE button to store them.

You will now be in the setting mode once again. To return to the main menu, move the cursor to **8. TO EXIT** and press the joystick down or simply press the MAIN button to exit to main menu.

ENG

MACRO AND PUNCH THROUGH PROGRAMMING

The MACRO and PUNCH THROUGH can be also programmed in this mode. Press the button you wish to program and follow procedures shown below:

MACRO PROGRAMMING

There are three type of macro functions you can program. They are as follows:

- 1 M1, M2 and M3 in the Main menu.** Designed to send out up to twenty eight commands from each of the three buttons.
- 2 Twelve device buttons in the Main menu.** Send out up to fourteen commands from each device button.
- 3 Favorite Channel Buttons.** You can create and design up to 60 buttons as your Favorite Button in video modes. Each favorite channel button can send out up to fourteen commands with one button press.

TO PROGRAM MACRO FUNCTIONS:

Press MACRO PROGRAM button in **2. SYSTEM & OPTIONS**

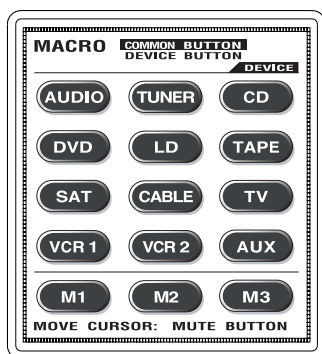

FOR M1 – M3 BUTTON:

- 1** Press one of the three macro buttons, M1 – M3, for which you want to store the macro.
- 2** Select functional buttons you wish to store in the macro button. You can store up to 28 commands.
- 3** Store the commands you selected to the macro button by pressing CH (UP) button. To cancel the macro commands, press CH (DOWN).

ENG

FOR DEVICE BUTTONS:

- 1 Press one of the twelve device buttons you wish to store macro functions with the cursor on DEVICE BUTTON.
- 2 Move the cursor to COMMON BUTTON and select again either the same or another device button whose functional buttons you wish to store in the device macro button you first selected. You can store up to 14 commands in the device macro buttons.
- 3 Store the commands you selected to the macro button by pressing CH (UP) button. To cancel the macro commands press CH (DOWN).

FOR FAVORITE CHANNEL BUTTON:

- 1 Press the device you wish to program favorite channels with cursor on COMMON BUTTON.
- 2 Press one of the favorite channel buttons and enter the channel number you wish to store in the FAVORITE channel button. You can store up to 14 commands.
- 3 Store the commands you selected in the Favorite channel button by pressing Channel UP button. To cancel the macro commands, press CH (DOWN).

Once you complete the macro programming and wish to exit, press both the MAIN and PAGE buttons simultaneously. This will take you to the setting mode. Move the cursor to **8. TO EXIT** in setting mode and press the joystick down to exit or simply press the MAIN button to exit to main menu.

NOTE

Pressing the Volume Up button during the macro programming will add a time delay of 0.5 seconds between the commands, e.g. pressing the Volume Up button twice will cause a pause of 1 second between the commands where the delay was inserted.

TO ERASE MACRO FUNCTIONS

To erase the functions you stored in any of the macro buttons, press the Channel Up button without entering any commands during the macro programming mode.

TO PROGRAM PUNCH THROUGH FUNCTIONS

You can use audio receiver volume control in a different mode (e.g. Audio receiver Volume Up and Volume Down and Mute in Satellite mode) using a volume punch through feature. You can also have four VCR (or DVD) transport buttons, Play, Stop, Fast Forward and Rewind, operate in another mode such as in Satellite, Cable and Audio modes. You can also set CHANNEL for punch through.

PROGRAMMING:

- 1 Press PUNCH THROUGH in the LCD screen in **2. SYSTEMS & OPTIONS** mode.
- 2 Press VOLUME UP button for Volume Punch Through or press the PLAY button for Transport Punch Through. or CHANNEL up button for Channel Punch Through.
- 3 Select the device you wish to punch through to (1st device).
- 4 Select the device you wish to punch through from (2nd device).
- 5 Repeat from Step 2 to program Punch Through to other devices.

Once you complete the Punch Through programming and wish to exit, press both the MAIN and PAGE buttons simultaneously. This will take you to the setting mode. Move the cursor to **8. TO EXIT** in the setting mode and press down the joystick to exit or simply press the MAIN button to exit to main menu.

TO ERASE PUNCH THROUGH FUNCTIONS:

Press the same device button in the PUNCH THROUGH TO? and PUNCH THROUGH FROM? during the Punch Through programming.

TO EDIT THE BUTTONS ON THE LCD

You can add or delete buttons, change the button size and shape, move the button locations and edit the text on the buttons on LCD screen in the EDITING Mode.

- 1 Go into setting mode by pressing both the MAIN and PAGE buttons simultaneously for five seconds.
- 2 Move down the cursor in the LCD screen to **5. EDIT BUTTONS** using joystick.
- 3 Push down the joystick to enter the EDITING mode. The LCD will list the following six choices to choose from and select the button you wish to enter.

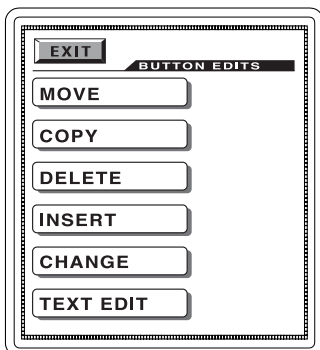

TO MOVE BUTTONS

This operation moves functional buttons to any location on the LCD screen. It also moves the button from one page to another within the selected device.

- 1 Set the cursor to COMMON BUTTON and select the device you wish to enter. Select the functional button you wish to move in the device page and move them with the joystick within the same page or move to the next page by pressing the PAGE button. Once you position the button at the location or page you desire, push the joystick down to save it.
- 2 Repeat the above step to continue to move other buttons in the same device.
- 3 If you wish to move buttons in another device, return to the main menu by pressing the MAIN button and repeat from STEP 1.
- 4 Once the operation is completed and you wish to exit from this mode, return to the main menu by pressing the MAIN button and then exit from the main menu by pressing both the MAIN and PAGE buttons, simultaneously

NOTE

You may first relocate or delete the buttons that are currently at the position you plan to locate the new button. However, you can also relocate or delete the buttons after you superimpose the new button above them.

TO EDIT THE BUTTONS ON LCD

The device buttons in favorite device page can be moved. Please refer to “**To Copy - Creating a Favorite Device Page**”

TO COPY BUTTONS

You can copy any functional button and move them anywhere in the LCD screen or to any other 3 pages within the same device mode.

- 1 Move the cursor either to COMMON BUTTON or DEVICE BUTTON with the MUTE button.
- 2 Select the device you wish to enter.
- 3 Select the functional button you wish to copy and move it with the joystick within the same page or move to the next page by pressing the PAGE button. Once you position the copied button at the location or page you desire, push the joystick down to save it.
- 4 Repeat from Step 2 to continue to copy other buttons in the same device.
- 5 If you wish to copy buttons in another device, return to the main menu by pressing MAIN button and repeat from Step 1.
- 6 Once the operation is completed and you wish to exit from this mode, return to the main menu by pressing the MAIN button and then exit from main menu by pressing both the MAIN and PAGE buttons simultaneously.

TO COPY - CREATING A FAVORITE DEVICE PAGE (MAIN 1)

You can also create your favorite device page and transfer the device buttons you use most often to this page with the following steps:

- 1 Move the cursor to DEVICE BUTTON with the MUTE button.
- 2 Select the device you wish to store in your favorite device page.
- 3 Press the MAIN button. The device you selected will appear in a favorite page you just created. You can also move the device button to a different location in the LCD page with the joystick in this step.
- 4 Press the joystick down to save the device button you copied.
- 5 Repeat Step 2 to Step 4 to copy other device buttons you wish to store to your favorite device page.
- 6 Once you completed it, exit by pressing both the MAIN and PAGE button simultaneously.

NOTE

You may also want to change the size and text of the buttons in the favorite device page using CHANGE and TEXT EDIT in EDIT mode. However, the text on the button should be written on the main device page before the device button is stored in favorite device.

ENG

TO EDIT THE BUTTONS ON LCD

TO DELETE BUTTONS

You can delete any button on the LCD screen except the twelve device buttons in the MAIN page. With this operation you can delete both the device buttons in the favorite page and the functional buttons with the following steps:

- 1 Select the functional button you wish to delete in the device page and push the joystick down for three seconds to delete the button. If you wish to delete the device button in favorite page, press the MAIN button and select the device button you wish to delete. Press down the joystick for three seconds to delete the button.
- 2 Repeat the above step to continue to delete other buttons in the same device
- 3 If you wish to delete functional buttons in another device, return to the main menu by pressing the MAIN button and repeat from Step 1.
- 4 Once the operation is completed and you wish to exit from the delete mode, return to the main menu by pressing the MAIN button and then exit from the main menu by pressing both the MAIN and PAGE buttons simultaneously.

WARNING

The preprogrammed command of the deleted button can be restored only by creating a button at exactly the same location it was originally assigned. It can also be restored by clearing the entire memory in the remote control and a new program loaded to the remote control. The learned functions will be lost permanently with the deletion of the button. Please use caution in deleting the button.

TO INSERT BUTTONS

This is designed to create new functional buttons in any of the twelve devices.

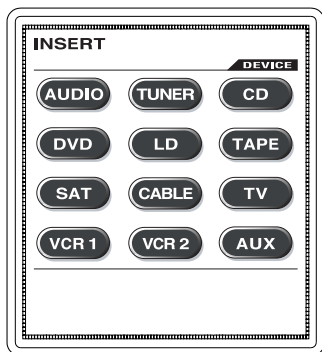

The following choices of button sizes and shapes are available:

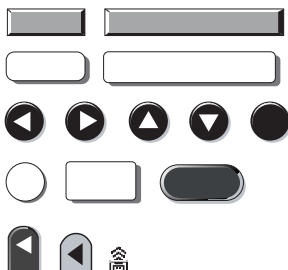

- 1 Select INSERT button in EDITING mode.
- 2 Select the device you wish to create as a new button.
- 3 Move to the page you wish to create a new button by pressing the PAGE button. Press the CHANNEL UP or DOWN buttons and various sizes and shapes of buttons will appear on the top left side of the LCD screen.
- 4 Continue to press the Channel button until you find the button you wish to use.
- 5 Move the button you created to the location you wish to position with the joystick and press the joystick down to save it in that location.
- 6 Repeat from Step 3 to continue to create new buttons in the same device.
- 7 If you wish to create new buttons in another device, return to the main menu by pressing the MAIN button and repeat from STEP 2.
- 8 Once the operation is completed and you wish to exit from this mode, return to the main menu by pressing the MAIN button and exit from the main menu by pressing both the MAIN and PAGE buttons simultaneously.

ENG

TO EDIT THE BUTTONS ON LCD

TO CHANGE BUTTONS

This is designed to change the size and shape of any functional buttons and device buttons (in favorite device page) with the steps shown below:

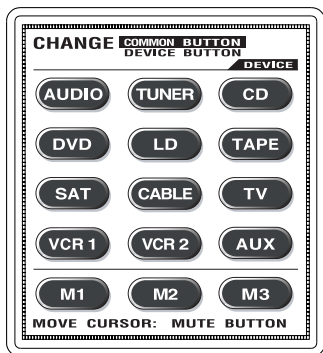

The following choices of buttons are available:

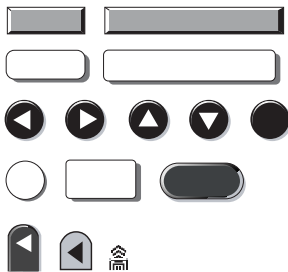

- 1 Press CHANGE button in EDITING MODE.
- 2 If you wish to change the functional buttons, press the device that contains the functional button you wish to change and then select the functional button. If you wish to change the device buttons in the favorite device page, press the MAIN button in main menu and then select the device button you wish to change.
- 3 After selecting the button you wish to change size and shape, press the CHANNEL UP or CHANNEL DOWN button and various sizes and shapes of buttons will appear on the button you selected.
- 4 Continue to press the Channel button until you find the button you wish to use and press the joystick down to save the shape of the button.
- 5 Repeat from Step 3 to continue to change buttons in the same device.
- 6 If you wish to change button sizes and shapes in another device, return to the main menu by pressing the MAIN button and repeat from Step 2.
- 7 If you wish to exit from this mode, return to the main menu by pressing the MAIN button and then exit from the main menu by pressing both the MAIN and PAGE buttons simultaneously.

ENG

TO EDIT A TEXT

This is designed to write a new text on any of the buttons in the LCD screen with the following steps:

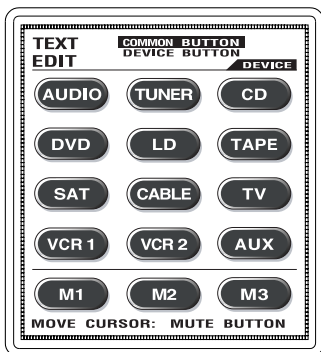

The following choices of fonts are available in two sizes for text editing:

ABCDEFGHIJKLMNOPQRSTUVWXYZ

RSTUVWXYZ{▲}▼_!#%

&'()*+,-./0123456789

::<=>?@

- 1 Select TEXT EDIT button in EDITING MODE.
- 2 If you wish to write on the functional buttons, move the cursor to COMMON BUTTON with the MUTE button and select the device you wish to enter. Select the functional button you wish to write text. If you wish to write on the device buttons or on the M1 - M3 buttons, move the cursor to DEVICE BUTTON and select the device button.
- 3 After the selection of the button you wish to write, move the cursor to the location with joystick to write a text in the button, press the Volume UP or Down button to select the characters you wish to use, press the Channel UP or Channel Down button to move on to next or move back to the previous characters, press the PRE CH button to move to the second line of the text and the POWER button for different font sizes. You can select font sizes by pressing the POWER button either before you start to write the characters or after you write the text. For a space between the characters, press the PLAY button.
- 4 Press the joystick down to save the new text on the button you selected.
- 5 Repeat from Step 3 to continue to change the text on other buttons in the same device.
- 6 If you wish to change the text in another device, return to the main menu by pressing the MAIN button and then repeat from Step 2.
- 7 If you wish to exit from this mode, return to the main menu first by pressing the MAIN button and exit from the main menu by pressing both the MAIN and PAGE buttons simultaneously.

ENG

CLOCK SETTING

Enter the Setting mode by pressing both the MAIN and PAGE button simultaneously for five seconds. Move the cursor on the LCD screen to **6. SET DATE & CLOCK** by using the joystick. Enter this mode by pushing the joystick down.

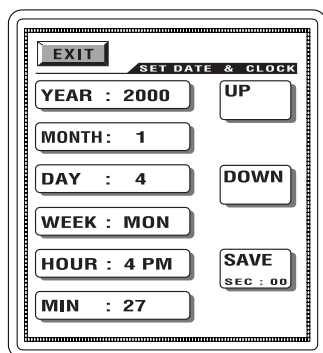

Press the selection you wish to change from the LCD screen and change them using the UP and DOWN buttons.

Once you complete the setting, store them by pressing the SAVE button.

LOADING PROGRAM USING A PC

This program enables you to both upload the program to PC as well as download from PC using the cable that is provided.

Move the cursor in the setting mode to **7. PROGRAM LOADING** using the joystick and press it down to enter the mode.

Please visit our website www.NADelectronics.com for the further instruction.

LCD ALIGNMENT

You may need to align the LCD screen after you download the program to the HTR-5.

Enter the Setting mode by pressing both the MAIN and PAGE button simultaneously for five seconds. Move the cursor on the LCD screen to **1. TOUCH PAD ALIGNMENT** with joystick. Press the joystick down to enter the mode. Align the screen by pressing the three points that appear on LCD one point at a time.

@ - Press Here (1)

To Align LCD Screen:
Press the three points
using pencil tip.

@ - Press here (2)

To Cancel:
Press Main button.

Press Here (3) - @

LCD SCREEN CONTRAST

The contrast of the LCD screen can be adjusted by pressing either the CHANNEL UP or DOWN button while holding down the MAIN button. Release the buttons when you have reached the optimal level of contrast.

ENG

CAUTION WITH LCD SCREEN

Please note that the LCD screen is made of a breakable glass. Please use necessary caution in handling LCD screen.

MEMORY LOCK

The HTR-5 has an internal memory lock system that retains all the programs and learned functions for an extended period.

ERASING ALL THE PROGRAMS

Pressing the button shown through the opening in the battery compartment after removing the batteries from the HTR-5 will erase all the programs in the remote control.

WARRANTY

We guarantee HTR-5 against any manufacturing defects for one year from the date of purchase.

Operating range	13 m ~ 20 m, depending upon components.
Power requirements	Four size AA batteries
Battery life	About 4 months
Weight	209.2 g (not including batteries)
Dimensions	226 mm x 76 mm x 38 mm (W x H x D)

Programmed Code Numbers:

AUDIO	_____
TUNER	_____
CD	_____
DVD	_____
LD	_____
TAPE	_____
SAT	_____
CABLE	_____
TV	_____
VCR1	_____
VCR2	_____
AUX	_____

SET-UP FUNCTION TABLE - AUDIO

Button Name	Audio Functions
Device Name	
POWER	Standby
CH UP	Preset Up
CH DOWN	Preset Down
VOL UP	Volume Up
VOL DOWN	Volume Down
MUTE	Mute
PRE. CH	Tune/Preset

Button Name	Audio Functions
PLAY	
STOP	
REW	
F.F.	
CURSOR ENTER	Enter
CURSOR UP	Cursor Up
CURSOR DOWN	Cursor Down
CURSOR LEFT	Cursor Left
CURSOR RIGHT	Cursor Right

Page 1	Button Name	Audio Functions
	CD	CD
	AUX	Aux
	TUNER	Tuner
	VIDEO 1	LD/Video 1
	VIDEO 2	VCR 1/Video 2
	VIDEO 3	VCR 2/Video 3
	VIDEO 4	Video 4
	VIDEO 5	Video 5
	VIDEO 6	Video 6
	TAPE 1	Tape 1
	TAPE 2	Tape 2
	EXT 5.1	External 5.1
	AM	AM
	FM	FM

Page 2	Button Name	Audio Functions
	ON	Power On
	OFF	Power Off
	SLEEP	Sleep
	SURR MODE	Surround Mode
	THX	THX
	TONE	Tone
	CHANNEL	Channel Select
	DYNAMIC RANGE	Late Night
	TEST	Surround Test
	MULTISOURCE VOL+	MultiSource Volume Down
	MULTISOURCE VOL-	MultiSource Volume Up
	SOURCE	Multi Source

Page 3	Button Name	Audio Functions
	SURR UP	Surround Up
	CNTR UP	Centre Up
	SUB. W UP	Sub Woofer Up
	SURR DOWN	Surround Down
	CNTR DOWN	Centre Down
	SUB. W DOWN	Sub Woofer Down
	CUSTOM PRESET 1	Preset 1
	CUSTOM PRESET 2	Preset 2
	CUSTOM PRESET 3	Main/Preset 3
	CUSTOM PRESET 4	CAR-CDR/Preset 4
	CUSTOM PRESET 5	S-Filter/Preset 5

Page 4	Button Name	Audio Functions
	1	Tuner 1
	2	Tuner 2
	3	Tuner 3
	4	Tuner 4
	5	Tuner 5
	6	Tuner 6
	7	Tuner 7
	8	Tuner 8
	9	Tuner 9
	0	Tuner 0
	DISPLAY	Display
	ENTER	Tuner Enter

SATELLITE - SET-UP FUNCTION TABLE

Button Name	SAT Functions
Device Name	SAT (On)
POWER	On/Off (On)
CH UP	Channel Up
CH DOWN	Channel Down
VOL UP	Volume Up
VOL DOWN	Volume Down
MUTE	Mute
PRE. CH	Prev. Ch.

Button Name	SAT Functions
PLAY	
STOP	
REW	
F.F.	
CURSOR ENTER	Select
CURSOR UP	Cursor Up
CURSOR DOWN	Cursor Down
CURSOR LEFT	Cursor Left
CURSOR RIGHT	Cursor Right

Page 1	Button Name	SAT Functions
	1	1
	2	2
	3	3
	4	4
	5	5
	6	6
	7	7
	8	8
	9	9
	0	0
	DISPLAY	TV/SAT
	ENTER	Enter

Page 2	Button Name	SAT Functions
	MENU	Power On
	GUIDE	Power Off
	EXIT	Sleep
	INFO	Surround Mode
	FAV. CH.	THX
	ACTION	Tone
	ALPHA	Channel Select
	NEXT	Late Night
	VIEW	Surround Test
	ALT AUDIO	MultiSource Volume Down
	REC	MultiSource Volume Up
	FETCH	Multi Source

Page 3	Button Name	SAT Functions
	FAV1	
	FAV2	
	FAV3	
	FAV4	
	FAV5	
	FAV6	
	FAV7	
	FAV8	

Page 4	Button Name	SAT Functions
	FAV9	
	FAV10	
	FAV11	
	FAV12	
	FAV13	
	FAV14	
	FAV15	
	FAV16	

SET-UP FUNCTION TABLE - TV

Button Name	TV Functions
Device Name	
POWER	Standby
CH UP	Channel Up
CH DOWN	Channel Down
VOL UP	Volume Up
VOL DOWN	Volume Down
MUTE	Mute
PRE. CH	Review

Button Name	TV Functions
PLAY	
STOP	
REW	
F.F.	
CURSOR ENTER	Cursor Up
CURSOR UP	Cursor Down
CURSOR DOWN	
CURSOR LEFT	
CURSOR RIGHT	

Page 1	Button Name	TV Functions
	1	Digit 1
	2	Digit 2
	3	Digit 3
	4	Digit 4
	5	Digit 5
	6	Digit 6
	7	Digit 7
	8	Digit 8
	9	Digit 9
	0	Digit 0
	100	100
	ENTER	

Page 2	Button Name	TV Functions
	MENU	
	DISPLAY	Recall
	EXIT	
	TV/VCR	
	TV/CATV	TV/CATV
	INPUT	Video
	SLEEP	Timer/Clock
	CC	
	CH.SCAN	
	AUDIO	Audio
	PICTURE	Picture
	RESET-STD	Reset

Page 3	Button Name	TV Functions
	AUTO:CH	
	ADD	
	DELETE	
	PIP ON	
	PIP OFF	
	SWAP	
	FREEZE	
	POSITION	
	MTS	MTS
	K1	
	K2	
	FAV1	

Page 4	Button Name	TV Functions
	FAV2	
	FAV3	
	FAV4	
	FAV5	
	FAV6	
	FAV7	
	FAV8	

VCR - SET-UP FUNCTION TABLE

Button Name	VCR1,2 Functions
Device Name	VCR (On)
POWER	On/Off (Off)
CH UP	Channel Up
CH DOWN	Channel Down
VOL UP	Volume Up
VOL DOWN	Volume Down
MUTE	Mute
PRE. CH	

Button Name	VCR1,2 Functions
PLAY	Play
STOP	Stop
REW	Rewind
F.F.	Fast Forward
CURSOR ENTER	
CURSOR UP	
CURSOR DOWN	
CURSOR LEFT	
CURSOR RIGHT	

Page 1	Button Name	VCR1,2 Functions
	1	1
	2	2
	3	3
	4	4
	5	5
	6	6
	7	7
	8	8
	9	9
	0	0
	100	1-100
	ENTER	Enter

Page 2	Button Name	VCR1,2 Functions
	PAUSE	Pause
	X2	2x
	REC	Record
	SRCH-	Search-
	SRCH+	Search+
	F.ADV	Frame Advance
	SLOW-	Slow-
	SLOW+	Slow+
	SLOW	Slow
	V/T	VCR/TV
	INPUT	Input
	VCR+	VCR Plus

Page 3	Button Name	VCR1,2 Functions
	MENU-PGM	Program
	DISPLAY	Display
	AUDIO MONITOR	Audio Monitor
	COUNTER	C-Counter
	RESET	Reset
	CLEAR	Clear
	INDEX	Index
	INDEX MARK	Index Mark
	INDEX ERASE	Index Erase
	TAPE SPEED	Tape Speed
	TOMER REC	Timer Rec
	EJECT	Eject

Page 4	Button Name	VCR1,2 Functions
	AUTO TRK	Auto Tracking
	TRK-	Tracking-
	TRK+	Tracking+
	AUTO CH	Auto Ch
	ADD	Add+
	DELETE	Delete-
	EDIT	Edit
	QTR ON	Qtr On
	QTR OFF	Qtr Off
	K1	
	K2	
	K3	

SET-UP FUNCTION TABLE - CABLE

Button Name	Cable Functions
Device Name	Cable (On)
POWER	On/Off (Off)
CH UP	Channel Up
CH DOWN	Channel Down
VOL UP	Volume Up
VOL DOWN	Volume Down
MUTE	Mute
PRE. CH	Prev. Ch

Button Name	Cable Functions
PLAY	
STOP	
REW	
F.F.	
CURSOR ENTER	Select
CURSOR UP	Cursor Up
CURSOR DOWN	Cursor Down
CURSOR LEFT	Cursor Left
CURSOR RIGHT	Cursor Right

Page 1	Button Name	Cable Functions
	1	1
	2	2
	3	3
	4	4
	5	5
	6	6
	7	7
	8	8
	9	9
	0	0
	INPUT	Switch A/B
	ENTER	Enter/Memory

Page 2	Button Name	Cable Functions
	MENU	Menu
	GUIDE	Guide/Recall
	EXIT	Exit
	INFO	Info
	FAV	Fav
	PPV	PPV/Buy
	PAGE-	Page-
	PAGE+	Page+
	BYPASS	Bypass
	DAY-	Day-
	DAY+	Day+
	HELP	*/Help

Page 3	Button Name	Cable Functions
	A	P/Delete
	B	
	C	
	REW	
	PLAY	
	F.F.	
	PAUSE	
	STOP	
	REC	Record
	FAV1	
	FAV2	
	FAV3	

Page 4	Button Name	Cable Functions
	FAV4	
	FAV5	
	FAV6	
	FAV7	
	FAV8	
	FAV9	
	FAV10	
	FAV11	
	FAV12	
	FAV13	
	FAV14	

DVD - SET-UP FUNCTION TABLE

Button Name	DVD Functions
Device Name	
POWER	Standby
CH UP	Skip Forward
CH DOWN	Skip Back
VOL UP	
VOL DOWN	
MUTE	
PRE. CH	

Button Name	DVD Functions
PLAY	Play
STOP	Stop
REW	Scan Back
F.F.	Scan Forward
CURSOR ENTER	Enter
CURSOR UP	Cursor Up
CURSOR DOWN	Cursor Down
CURSOR LEFT	Cursor Left
CURSOR RIGHT	Cursor Right

Page 1	Button Name	DVD Functions
	PAUSE	Pause
	OPEN/CLOSE	Open/Close
	NEXT DISC	
	AUDIO	Audio
	SUBTITLE	Subtitle
	ANGLE	Angle
	TITLE	Title
	MENU	Menu
	RETURN	Return
	ZOOM	Zoom
	DISPLAY	Display
	SET-UP	Set Up

Page 2	Button Name	DVD Functions
	REPEAT	Repeat
	MARKER	Marker
	A-B	Repeat A-B
	MARKER SEARCH	Marker Search
	RANDOM	Random
	RESUME	Resume
	SLOW-	Slow Back
	SLOW+	Slow Forward

Page 3	Button Name	DVD Functions
	1	Digit 1
	2	Digit 2
	3	Digit 3
	4	Digit 4
	5	Digit 5
	6	Digit 6
	7	Digit 7
	8	Digit 8
	9	Digit 9
	0	Digit 0
	PROGRAM	Program
	CLEAR	Clear
	SOUND	

SET-UP FUNCTION TABLE - CD

Button Name	CD Functions
Device Name	
POWER	Standby
CH UP	CD Skip Forward
CH DOWN	CD Skip Back
VOL UP	Volume Up
VOL DOWN	Volume Down
MUTE	Mute
PRE. CH	

Button Name	CD Functions
PLAY	CD Play/Pause
STOP	CD Stop
REW	CD Scan Back
F.F.	CD Scan Forward
CURSOR ENTER	
CURSOR UP	
CURSOR DOWN	
CURSOR LEFT	
CURSOR RIGHT	

Page 1	Button Name	CD Functions
	1	CD 1
	2	CD 2
	3	CD 3
	4	CD 4
	5	CD 5
	6	CD 6
	7	CD 7
	8	CD 8
	9	CD 9
	0	CD 0
	+10	CD +10
	PROGRAM	CD Program
	DELETE	CD Clear/Delete
	DISC	CD Next Disc

Page 2	Button Name	CD Functions
	PAUSE	CD Pause
	EJECT	CD Open/Close
	TIME	CD Time
	EDIT	CD Edit
	RANDOM	CD Random
	INTRO	CD Intro Scan
	REPEAT	CD Repeat
	A-B	CD A-B

Page 3	Button Name	CD Functions
	DISC1	CD Disc 1
	DISC2	CD Disc 2
	DISC3	CD Disc 3
	DISC4	CD Disc 4
	DISC5	CD Disc 5
	DISC6	CD Disc 6
	10	CD 10
	K1	
	K2	
	K3	
	K4	
	K5	
	K6	

Page 4	Button Name	CD Functions
	K7	
	K8	
	K9	
	K10	
	K11	
	K12	
	K13	
	K14	
	K15	
	K16	

LASER DISC - SET-UP FUNCTION TABLE

Button Name	LD Functions
Device Name	LD (On)
POWER	On/Off (Off)
CH UP	Track+ / Skip+
CH DOWN	Track- / Track+
VOL UP	Volume Up
VOL DOWN	Volume Down
MUTE	Mute
PRE. CH	

Button Name	LD Functions
PLAY	Play
STOP	Stop
REW	Rew/Search-
F.F.	FF/Search+
CURSOR ENTER	
CURSOR UP	
CURSOR DOWN	
CURSOR LEFT	
CURSOR RIGHT	

Page 1	Button Name	LD Functions
	1	1
	2	2
	3	3
	4	4
	5	5
	6	6
	7	7
	8	8
	9	9
	0	0
	+10	+10
	DISP	Display

Page 2	Button Name	LD Functions
	PAUSE	Pause
	OPEN/CLOSE	Open/Close
	STILL/STEP-	Search-
	STILL/STEP+	Search+
	PROGRAM	Program
	REPEAT	Repeat
	ALL	All
	A-B	A-B
	SHUFFLE	Shuffle
	FRAME/TIME	Frame
	CLEAR	Clear

Page 3	Button Name	LD Functions
	AUTO PGM	Auto Program
	DISC A	Disc A
	DISC B	Disc B
	AUDIO MONITOR	Audio Monitor
	ANALOG	Analog
	BACK	Back
	AV TIME	Time
	PICTURE CHANGE	Picture Change
	INTRO	Intro
	K1	Random
	K2	Disc
	K3	

Page 4	Button Name	LD Functions
	K4	Disc 1
	K5	Disc 2
	K6	Disc 3
	K7	Disc 4
	K8	Disc 5
	K9	Edit
	K10	
	K11	
	K12	
	K13	
	K14	
	K15	

SET-UP FUNCTION TABLE - TAPE

Button Name	Tape Functions
Device Name	
POWER	Standby
CH UP	
CH DOWN	
VOL UP	Volume Up
VOL DOWN	Volume Down
MUTE	Mute
PRE. CH	

Button Name	Tape Functions
PLAY	Tape B Play
STOP	Tape B Stop
REW	Tape B Rewind
F.F.	Tape B Fast Forward
CURSOR ENTER	
CURSOR UP	
CURSOR DOWN	
CURSOR LEFT	
CURSOR RIGHT	

Page 1	Button Name	Tape Functions
	DECK B REVERSE PLAY	Tape B Reverse Play
	TAPE MON1	Tape 1
	DECK B REC/PAUSE	Tape B Record/Pause
	TAPE MON 2	Tape 2
	DECK B PAUSE	Tape B Pause

Page 2	Button Name	Tape Functions
	DECK A REVERSE PLAY	Tape A Reverse Play
	DECK A PLAY	Tape A Play
	DECK A REC/PAUSE	Tape A Record/Pause
	DECK A STOP	Tape A Stop
	DECK A REW	Tape A Rewind
	DECK A FF	Tape A Fast Forward

AUX - SET-UP FUNCTION TABLE

Button Name	AUX Functions	Button Name	AUX Functions
Device Name	AUX Functions	PLAY	
POWER	AUX (On)	STOP	
CH UP	On/Off (Off)	REW	
CH DOWN	Up	F.F.	
VOL UP	Down	CURSOR ENTER	
VOL DOWN		CURSOR UP	
MUTE		CURSOR DOWN	
PRE. CH		CURSOR LEFT	
		CURSOR RIGHT	

Page 1	Button Name	AUX Functions
	1	1
	2	2
	3	3
	4	4
	5	5
	6	6
	7	7
	8	8
	9	9
	0	0
	DISP	Disp
	ENTER	Enter

Page 2	Button Name	AUX Functions
	K1	
	K2	
	K3	
	K4	
	K5	
	K6	
	K7	
	K8	
	K9	
	K10	
	K11	
	K12	

Page 3	Button Name	AUX Functions
	K13	
	K14	
	K15	
	K16	
	K17	
	K18	
	K19	
	K20	
	K21	
	K22	
	K23	
	K24	

Page 4	Button Name	AUX Functions
	K25	
	K26	
	K27	
	K28	
	K29	
	K30	
	K31	
	K32	
	K33	
	K34	
	K35	
	K36	

SET-UP FUNCTION TABLE - TUNER

Button Name	Tuner Functions
Device Name	
POWER	Standby
CH UP	Preset Up
CH DOWN	Preset Down
VOL UP	Volume Up
VOL DOWN	Volume Down
MUTE	Mute
PRE. CH	Tune/Preset

Button Name	Tuner Functions
PLAY	
STOP	
REW	
F.F.	
CURSOR ENTER	
CURSOR UP	
CURSOR DOWN	
CURSOR LEFT	
CURSOR RIGHT	

Page 1	Button Name	Tuner Functions
	1	Tuner 1
	2	Tuner 2
	3	Tuner 3
	4	Tuner 4
	5	Tuner 5
	6	Tuner 6
	7	Tuner 7
	8	Tuner 8
	9	Tuner 9
	0	Tuner 0
	DISPLAY	Display
	ENTER	Tuner Enter

Page 2	Button Name	Tuner Functions
	AM	AM
	FM	FM
	MONO	Mono
	BLEND	Blend
	ANTENNA	Antenna
	IF	IF Wide/Narrow

Page 3	Button Name	Tuner Functions
	SEARCH UP	Search Up
	TUNING UP	Tune Up
	SEARCH DOWN	Search Down
	TUNING DOWN	Tune Down

Button Name	Audio Functions
Device Name	
POWER	Standby
CH UP	Preset Up
CH DOWN	Preset Down
VOL UP	Volume Up
VOL DOWN	Volume Down
MUTE	Mute
PRE. CH	Tune/Preset

Button Name	Audio Functions
PLAY	
STOP	
REW	
F.F.	
CURSOR ENTER	Enter
CURSOR UP	Cursor Up
CURSOR DOWN	Cursor Down
CURSOR LEFT	Cursor Left
CURSOR RIGHT	Cursor Right

Page 1	Button Name	Audio Functions
	CD	CD
	AUX	Aux
	TUNER	Tuner
	VIDEO 1	LD/Video 1
	VIDEO 2	VCR 1/Video 2
	VIDEO 3	VCR 2/Video 3
	VIDEO 4	Video 4
	VIDEO 5	Video 5
	VIDEO 6	Video 6
	TAPE 1	Tape 1
	TAPE 2	Tape 2
	EXT 5.1	External 5.1
	AM	AM
	FM	FM

Page 2	Button Name	Audio Functions
	ON	Power On
	OFF	Power Off
	SLEEP	Sleep
	SURR MODE	Surround Mode
	THX	THX
	TONE	Tone
	CHANNEL	Channel Select
	DYNAMIC RANGE	Late Night
	TEST	Surround Test
	MULTISOURCE VOL+	MultiSource Volume Down
	MULTISOURCE VOL-	MultiSource Volume Up
	SOURCE	Multi Source

Page 3	Button Name	Audio Functions
	SURR UP	Surround Up
	CNTR UP	Centre Up
	SUB. W UP	Sub Woofer Up
	SURR DOWN	Surround Down
	CNTR DOWN	Centre Down
	SUB. W DOWN	Sub Woofer Down
	CUSTOM PRESET 1	Preset 1
	CUSTOM PRESET 2	Preset 2
	CUSTOM PRESET 3	Main/Preset 3
	CUSTOM PRESET 4	CAR-CDR/Preset 4
	CUSTOM PRESET 5	S-Filter/Preset 5

Page 4	Button Name	Audio Functions
	1	Tuner 1
	2	Tuner 2
	3	Tuner 3
	4	Tuner 4
	5	Tuner 5
	6	Tuner 6
	7	Tuner 7
	8	Tuner 8
	9	Tuner 9
	0	Tuner 0
	DISPLAY	Display
	ENTER	Tuner Enter

SET-UP CODE TABLE - AUDIO

Manufacturer/Brand	Set-Up Code Number
ADC	007
ADCOM	082 092 225 161 269
AIWA	018 104 170 202 203 213 211 188
AKAI	138 189
AMC	125 126 127 128 258 281 282
AMEND	054
AMX	196
ANGSTROM	142
ARCAM	141
AUDIO ACCESS	147
AUDIO ALCHEMY	135
AUDIO DESIGN	194 221 011
AUDIO EASE	021 196 207
AUDIO FILE	071
AUDIO MATRIX	167
AUDIO SOURCE	273
AUDIO TECHNICA	134
B & K	096 097
BOSE	070 170 224
BRYSTON	023
CARVER	006 028 061 071 201 214 226 180 185 022 029 077 284
CASIO	076
CHIRO	140
CINEMA SOUND	034 134
CITATION	148 272
CLARION	026
CURTIS MATHES	076
DENON	002 034 109 215 229 230 027 037 234 259
EIGER	149
ELAN	057
ENLIGHTENED AUDIO	099 098
FISHER	047 214 180 182
FOSGATE	062 231
GE	056 260
GOLDSTAR	008
HAFLER	174
HARMAN KARDON	231 233 254 153 154 118 121 227 277
HITACHI	020
INKEL	197
JBL	263
JCPENNY	076 216
JEFF ROWLAND	206
JENSEN	058
JVC	240 163 191 114 266 279
KENWOOD	026 066 145 146 181 190 197 192 182 199 151 222 180 005 280
KINERGETICS	220 140
KOSS	216
KRELL	150 072
KYOCERA	007
LEXICON	120 235 236 237
LINN	124
LUXMAN	137 139 052 165 115 004 009
LXI	076 056
MAGNAVOX	086 164 152 208
MARANTZ	006 028 031 040 063 185 186 251 265
MCINTOSH	238
MCS	076
MERIDIAN	100 012 013
mitsubishi	242 243 204
MONDIAL	157 158 042 043 081 112
MYRYAD	276
NAD	186 113 283 003

AUDIO - SET-UP CODE TABLE

Manufacturer/Brand	Set-Up Code Number
NAKAMICHI	111 244 245 172 183
NEC	176
ONKYO	017 046 064 107 108 187 079 080 090 179 209 270 275
OPTIMUS	026 041 138
PANASONIC	032 195 219 177
PARASOUND	129 130 132 261
PHAST	196
PHILIPS	249 250 251 063
PIONEER	014 033 039 044 045 050 069 159 168 116 035 078 198
PROCEED	144 268
RCA	010 048 117 156 067
REALISTIC	019 056 073 075 095
REVOX	162
ROTEL	074 083 085
SAMSUNG	016
SANSUI	040 048 110 119 065 228
SANYO	047 059
SCOTT	019 091
SEARS	076
SHARP	026 094 131 175 181
SHERWOOD	024 038 055 102 103 105 106 051 030
SONY	018 093 223 247 248 160 166 015 101 184 218 271
SOUNDESIGN	036
SOUNDSTREAM	084 088
SSI	068
SUMO	171
TAEKWANG	138
TEAC	005 019 049 111 212 217
TECHNICS	122 176 193 219 178 177 200 257 262
THETA DIGITAL	136
TOSHIBA	060 087 198 278
WARDS	180
YAMAHA	026 253 169 067 173 205 264 232 089 264 274 285
ZENITH	143 210

SET-UP CODE TABLE - SAT

Manufacturer/Brand	Set-Up Code Number
ALPHASTAR	123
AMPLICA	050
BIRDVIEW	129 113 051 126
BSR	053
CAPETRONICS	053
CHANNEL MASTER	013 014 015 018 036 055
CHAPARRAL	008 009 012 077
CITOH	054
CURTIS MATHES	050
DRAKE	005 006 007 010 011 112 116 141 052
DX ANTENNA	024 046 056 076
ECHOSTAR	038 040 057 058 093 094 095 096 097 098 099 100 122
ELECTROHOME	089
EUROSAT	114
FUJITSU	017 021 022 027 133 134
GENERAL ELECTRIC	151 106 150
GENERAL INSTRUMENT	003 004 016 029 031 059 101 148
HITACHI	139 140
HOME CABLE	080 044 029
HOUSTON TRACKER	033 037 039 104 057 051
HUGHES	068 154
HYTEK	053
HYUNDAI	149
ICR	023
JANIEL	060 147
KATHREIN	108
LEGEND	057
LUTRON	132
LUXOR	144 062
MACOM	010 059 063 064 065
MEMOREX	057
NEXTWAVE	028 124 125
NORSAT	069 070
PACE	143
PANASONIC	142 060
PANSAT	121
PERSONAL CABLE	117
PHILIPS	071 152 153
PL	023 026
PRESIDENT	019 102
PRIMESTAR	110 030
PROSAT	072
PROSCAN	151 106 150
RCA	151 106 150
REALISTIC	043 074
SAMSUNG	123
SATELLITE SERVICE	028 035 047 085
SONY	103
STARCAST	041
SUPERGUIDE	020 124 125
TEECOM	023 026 075 087 088 090 107 130 137
TOSHIBA	002 127
TOWN & COUNTRY	023 026
UNIDEN	016 025 042 043 044 045 048 049 078 079 080 086 101 135 136
VIEWSTAR	115
WINEGARD	128 146
ZENITH	081 082 083 084 091 120

Manufacturer/Brand	Set-Up Code Number
ADMIRAL	072 081 161 160
AKAI	197 146
AMARK	112 143
AMPRO	073 167 157 183
AMSTRAD	052
ANAM	043 054 056 080 112 131
AOC	197 004 112 058
AUDIOVOX	076
BLAUPUNKT	088
CAIRN	201
CANDLE	197 002 003 004
CAPEHART	058
CETRONIC	043
CITIZEN	197 002 003 004 043 101 103 143
CLASSIC	043
CONCERTO	004
CONTEC	043 050 051
CORONADO	143
CRAIG	043 054
CROWN	043 143
CURTIS MATHES	197 101 004 143
CXC	043
DAEWOO	004 016 043 044 076 103 114 125 127 143
DAYTRON	004 143
DWIN	177
DYNASTY	043
DYNATECH	062
EIKI	187
ELECTROHOME	024 076 143 196
EMERSON	197 004 005 028 043 047 048 050 051 076 096 143 151 153 154 155
FISHER	007 057
FUJITSU	198
FUNAI	028 043
FUTURETECH	043
GE	197 008 009 034 056 073 074 130 144 155 160 161 165 004 091 157 183
GOLDSTAR	004 102 106 112 113 116 119 127 143
HALL MARK	004
HITACHI	004 009 010 011 012 023 075 143 158 163 166 072
INFINITY	164
JBL	164
JCPENNY	197 004 008 009 024 030 065 101 143 156 160
JENSEN	013
JVC	034 038 070 083 145 199
KEC	043
KENWOOD	197 070
KLOSS	002 059
KMC	143
KTV	197 043 143 154
LODGENET	072
LOGIK	072
LUXMAN	004
LXI	166 007 015 052 081 160 164
MAGNAVOX	197 003 004 022 059 060 061 063 064 127 160 164 094
MARANTZ	197 164
MATSUI	164
MEMOREX	007 072 004
METZ	088
MGA	197 004 024 028 042
MINERVA	088
MITSUBISHI	004 024 028 040 042 109 124 146 191
MTC	197 004 062 101

SET-UP CODE TABLE - TV

Manufacturer/Brand	Set-Up Code Number
NAD	015 025
NEC	132 130 134 197 040 016 024 056 019
NIKEI	043
ONKING	043
ONWA	043
OPTONICA	019 081
ORION	096
PANASONIC	034 056 080 092 164
PHILCO	197 003 024 056 059 060 063 064 164 004
PHILIPS	197 003 004 005 038 059 093 164 127
PIONEER	197 018 023 025 116 135 190
PORTLAND	004 143
PROSCAN	144 160 161 165 167
PROTON	004 058 131 143 171 173 193
QUASAR	034 056 092
RADIO SHACK	019 043 143 004 127
RCA	160 161 165 065 156 144 197 004 023 024 056 074 152
REALISTIC	007 019 043 047
ROCTEC	186
RUNCO	168 169 178 179 180 181 182 183 073 157
SAMPO	197 058 004 202
SAMSUNG	004 050 089 101 105 127 143 160
SANYO	166 007 020 053 057 082 187
SCOTT	004 028 043 048 143
SEARS	015 030 004 007 028 057 143 094 160 082 165 166
SELECO	189 200
SHARP	170 081 019 028 029 014 004 022 143 175
SIEMENS	088
SIGNATURE	072
SONY	070 085 139 147 126 185 194
SOUNDESIGN	004 028 003 043
SPECTRICON	112
SSS	004 043
SUPRE MACY	002
SYLVANIA	197 003 059 060 063 064 164 044 160 127
TANDY	081
TATUNG	056 062
TECHNICS	034 080
TECHWOOD	004
TEKNIKA	002 003 004 024 028 043 072 101 143
TELEFUNKEN	037 046 086 087
TELERENT	072
TERA	172
TMK	004
TOSHIBA	007 015 030 040 062 101 138
TOTEVISION	143
UNIVERSAL	008 009
VIDEO CONCEPTS	146
VIDIKRON	174 184 188 192
VIDTECH	004
WARDS	004 008 009 019 028 060 061 063 064 072 074 143 164 034
WESTING HOUSE	076
YAMAHA	197 004
YORK	004
YUPITERU	043
ZENITH	072 073 095 103 157 183
ZONDA	112

Manufacturer/Brand	Set-Up Code Number
AIWA	034 161
AKAI	016 043 046 124 125 142 146
AMPRO	072
ANAM	031
AUDIO DYNAMICS	012 023 039 043
BROOKSONIC	035 037 129
CANON	028 031
CAPEHART	108
CRAIG	003 040 135
CURTIS MATHES	031 041
DAEWOO	005 007 010 065 108 110 111 112 116 117 119
DAYTRON	108
DBX	012 023 039 043
DYNATECH	034 053
ELECTROHOME	059
EMERSON	006 017 025 027 029 031 034 035 036 037 046 101 129 131 138 153 162 116
FISHER	003 008 009 010
FUNAI	034
GE	031 063 072 107 109 144 147
GO VIDEO	132 136 155 040 115
GOLDSTAR	012 013 020 101 106 114 123
HARMAN KARDON	012 045
HITACHI	004 018 026 034 043 063 137 150 160 013
INSTANTREPLAY	031
JCL	031
JCPENNY	012 013 015 040 066 101
JENSEN	043
JVC	012 031 043 048 050 055 060 130 150 152
KENWOOD	014 048 034 047
LLOYD	034
LXI	003 009 017 034 106
MAGIN	040
MAGNAVOX	031 034 041 067 068 156 164
MARANTZ	012 031 067 069
MARTA	101
MATSUI	027 030
MEI	031
MEMOREX	003 010 014 031 034 053 072 101 102 134 139
MGA	045 046 059
MINOLTA	013 020
MITSUBISHI	013 020 045 046 051 059 061 142 151 049
MTC	034 040
MULTITECH	024 034
NEC	012 023 039 043 048
NORDMENDE	043
OPTONICA	053 054
ORION	025
PANASONIC	066 070 083 133 140 145 157 163 074
PENTAX	013 020 031 063
PHILCO	031 034 067
PHILIPS	031 034 054 067 071 101
PILOT	101
PIONEER	013 021 048
PORTLAND	108
PULSAR	072
QUARTZ	002 014
QUASAR	066 145 075
RADIO SHACK	123
RCA	013 020 041 107 109 140 144 145 147 034 040 158
REALISTIC	003 008 010 014 031 034 040 053 054 101
RICO	058

SET-UP CODE TABLE - VCR1

Manufacturer/Brand	Set-Up Code Number
RUNCO	148
SALORA	014
SAMSUNG	032 040 066 102 104 107 109 112 113 115 120 122 125
SANSUI	022 043 048 135
SANYO	003 007 010 014 134 102
SCOTT	017 037 112 129 131
SEARS	003 008 009 010 013 014 081 101 017 073 112
SHARP	031 054 149 159 165
SHINTOM	024
SIGNATURE	034
SONY	003 031 052 056 057 058 076 077 078 149 154
SOUNDESIGN	034
STS	013
SYLVANIA	031 034 059 067
SYMPHONIC	034
TANDY	010 034
TATUNG	039 043
TEAC	034 039 043
TECHNICS	031 070
TEKNIKA	019 031 034 101
THOMAS	034
TMK	006
TOSHIBA	008 013 042 047 059 079 082 112 131 081
TOTEVISION	040 101
UNITECH	040
VECTOR RESEARCH	012
VICTOR	048
VIDEO CONCEPTS	012 034 046 141
VIDEOSONIC	040
WARDS	003 013 017 024 031 034 040 053 054 131
YAMAHA	012 034 039 043
ZENITH	034 048 056 058 072 080 101

CABLE - SET-UP CODE TABLE

Manufacturer/Brand	Set-Up Code Number
ABC	103 003 004 039 042 046 053
AMERICAST	099
ANTRONIX	014
ARCHER	005 007 014
BELL SOUTH	099
CENTURION	092
CENTURY	007
CITIZEN	007
COMBANO	080 081
COMSAT	074
COMTRONICS	030
DIGICABLE	101
EAGLE	020 030 040
EASTERN	057 066
EHOSTAR	106
ELECTRICORD	032
GEMINI	008 054
GENERAL ELECTRIC	072
GENERAL INSTRUMENT	103 074 104
GNC	099
GOLDEN CHANNEL	030
HAMLIN	049 050 055
HITACHI	103 055
JERROLD	103 002 003 004 008 009 010 069 074
MAGNAVOX	010 012 064 079 095 094
MEDIA ONE	107
MEMOREX	052
MITSUBISHI	102
M-NET	037
MOVIE TIME	028 032
NOVAPLEX	092
NSC	015 028 038 071
OAK	031 037 053
PANASONIC	044 047
PARAGON	052
PHILIPS	006 012 013 020 085 095
PIONEER	103 034 051 063 076 105
PRUCER	059
PTS	011 071 074
PULSAR	052
RCA	047
RECOTON	098
REGAL	049 050
REGENCY	057
SAMSUNG	030
SCIENTIFIC ATLANTA	003 011 041 042 043 045 046
SIGNAL	030
SIGNATURE	103
SL MARX	030
SONY	096
SPRUCER	047 078
STARCOM	002 004 008 009
STARGATE	008 030 097 104
TADIRAN	030
TIME WARNER	043
TOCOM	039 040 056
TOSHIBA	052
UNIKA	007 014
UNITED CABLE	004 053
UNIVERSAL	005 007 014 032 035
VIEWSTAR	012 015 018 086 087 088 089
ZENITH	052 060 093 100

SET-UP CODE TABLE - DVD

Manufacturer/Brand	Set-Up Code Number
APEX DIGITAL	087
DENON	007 080
GE	026 027
HARMAN KARDON	084
JVC	012
LG	091 057 074
MAGNAVOX	066
MARANTZ	083
MITSUBISHI	017
NAD	088 091
ONKYO	076 035
PANASONIC	021 042
PHILIPS	066
PIONEER	023 092
PROCEED	086
PROSCAN	026 027
RCA	026 027
SAMSUNG	056 070
SHARP	094
SONY	033
THETA DIGITAL	032
THOMPSON	026 027
TOSHIBA	035 034
YAMAHA	042 089
ZENITH	057 074 091

Manufacturer/Brand	Set-Up Code Number
ADCOM	062 042
AIWA	059 065 088 089 105 122 170 187
AKAI	085 195 202
AMC	231 232
AMEND	118
ARCAM	238
AUDIO ACCESS	119 147
AUDIO EASE	165
AUDIO TECHNICA	046
BSR	037 057
CALIFORNIA AUDIO	103 008
CAPETRONIC	063
CARRERA	057 080
CARVER	185 041 044 050 086 107 130 134 135 138 139 203 204 167
CASIO	111 182
CLARINETTE	182
CREEK	159
CROWN	035
DENON	002 123
EMERSON	042 069 102
FISHER	050 185 134 008
FRABA	111
GENEXXA	010 069 102
GOLDSTAR	080
HAITAI	093
HARMAN KARDON	018 033 047 208
HITACHI	042 175
INKEL	130 143 144
JC PENNY	014 061 092 141
JENSEN	158
JVC	004 022 136 163 213 214 242 243
KENWOOD	185 007 023 055 071 072 142 137
KOSS	061
KRELL	241
KYOCERA	005
LOTTE	102
LUXMAN	011 028 070 076
LXI	059
MAGNAVOX	044 107
MARANTZ	027 041 044 051 077 107 209
MCINTOSH	212
MCS	014 073 092
MEMOREX	010
MISSION	044 107
MITSUBISHI	179
MITSUMI	153
MODULAIRE	182
MONDIAL	147
MYRYAD	244
NAD	006 005 178
NAKAMICHI	217 218 219 095
NEC	014 062
NIKKO	046
NSM	044 107
ONKYO	030 038 039 168 169
OPTIMUS	010 050 057 058 081 082 083 085 093 195
PANASONIC	103 201 172 008 068
PARASOUND	233
PHILIPS	041 044
PIONEER	010 020 025 056 174 175 176
PROCEED	239
PROTON	044 107 228

SET-UP CODE TABLE - CD

Manufacturer/Brand	Set-Up Code Number
QUASAR	103 008
RADIO SHACK	182
RCA	017 042 150
REALISTIC	042 050 051 102 181 182 187
ROTEL	044 107 161 178 250
SAE	044 107
SANSUI	044 069 107 128 171 190 125
SANYO	050
SCOTT	069 102
SHARP	026 031 051 066
SHERWOOD	003 019 051 096 112 115 119 166
SIGNATURE	033
SONY	048 081 097 126 133 177 225 226 164
SOUNDESIGN	251
SUMO	155
SYLVANIA	044 107
SYMPHONIC	052 181
TAEKWANG	195 085
TANDY	010
TEAC	015 034 036 051 052 101 131 140 079
TECHNICS	060 103 200 172 184 008 068
TECHWOOD	076
THETA DIGITAL	234 235
TOSHIBA	006 067 091 160 148
VECTOR RESEARCH	080
VICTOR	004 022 114 124
WARDS	185 033
YAMAHA	024 046 054 186 183 245
YORX	182

Manufacturer/Brand	Set-Up Code Number
DENON	206 207
FUNAI	120
KENWOOD	152 013
MAGNAVOX	032 121
MARANTZ	211
mitsubishi	121
OPTIMUS	049 013
PANASONIC	113
PHILIPS	032
PIONEER	106 117 121
RADIO SHACK	120
RCA	002
REALISTIC	049
RUNCO	127
SANYO	075
SHARP	152 013
SONY	053 110
TECHNICS	113
THETA DIGITAL	032
TOSHIBA	152 106
YAMAHA	043 129

SET-UP CODE TABLE - TAPE

Manufacturer/Brand	Set-Up Code Number
AIWA	015 071 100 114
CARVER	006 008 027 024 036
DENON	105 227 229
FISHER	064
GOLDSTAR	011
HARMAN KARDON	233
JVC	106 116 239 240
KENWOOD	005 013 023 026 064 145 146 181 190
LINN	124
LUXMAN	035 137 139
MAGNAVOX	027
MARANTZ	014 027 056 065 087
MCINTOSH	238
mitsubishi	242 243
NAD	029
NAKAMICHI	244 245 025
ONKYO	002 012 016 017 018 019 115
OPTIMUS	026 054 055
PANASONIC	007 010 032 088 195
PHILIPS	027 087
PIONEER	003 039 047 050 066 098 222
QUASAR	007 088
SANSUI	027 113 119 224
SHARP	026 057 131 175 181
SHERWOOD	038 004 028 030 033 034
SONY	020 022 052 084 089
TEAC	009 059 212
TECHNICS	007 010 076 088 109 122 193
TOSHIBA	112
VICTOR	106
YAMAHA	021 026 031 067 040

AUX - SET-UP CODE TABLE

Manufacturer/Brand	Set-Up Code Number
3M	152
AIWA	164
ARCHER	155
AUTON	191
DMX	156
DRAPER SCREEN	204
DWIN	080
EVERQUEST	206
EXTRON	151
FAROUDJA	184
FUJI	209
JERROLD	153
JVC	185
KENWOOD	185
LITE-TOUCH	208
LUTRON	077 158 159
MAKITA	186 201
MINDPATH	205
NILES	160 187
NSM	161
PIANO DISC PLUS	085
POLKAUDIO	162
REPLAY	075
RUSSOUND	081
SCIENTIFIC ATLANTA	156 163
SIMA	082
SOLO ELECTRONICS	207
SOMFY	078 079
SONY	164 165 166
STARCOM	153
TIVO	090
TURBOSCAN	167
VELODYNE	203
X-10	093 183
XANTECH	168 169 170 171 172 188 189



www.NADelectronics.com

©2002 NAD ELECTRONICS INTERNATIONAL

All rights reserved. No part of this publication may be reproduced, stored or transmitted in any form without the written permission of NAD Electronics International

HTR-5 Manual 01/02 Printed in Korea

Download from Www.Somanuals.com. All Manuals Search And Download.

Free Manuals Download Website

<http://myh66.com>

<http://usermanuals.us>

<http://www.somanuals.com>

<http://www.4manuals.cc>

<http://www.manual-lib.com>

<http://www.404manual.com>

<http://www.luxmanual.com>

<http://aubethermostatmanual.com>

Golf course search by state

<http://golfingnear.com>

Email search by domain

<http://emailbydomain.com>

Auto manuals search

<http://auto.somanuals.com>

TV manuals search

<http://tv.somanuals.com>