

NEC

MICROWAVE OVEN

N924W/N924P

OPERATING INSTRUCTIONS
& COOK BOOK

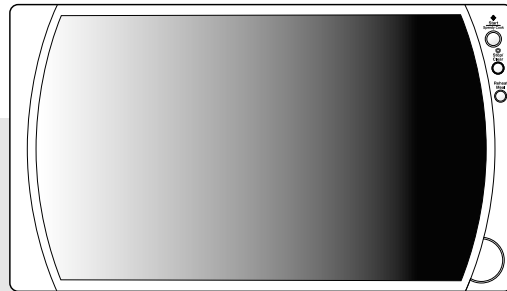

Before operating this oven, please read these instructions completely.

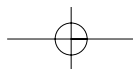

PRECAUTIONS TO AVOID POSSIBLE EXPOSURE TO EXCESSIVE MICROWAVE ENERGY

- (a) **Do not attempt to operate this oven with the door open** since open-door operation can result in harmful exposure to microwave energy. It is important not to defeat or tamper with the safety interlocks.
- (b) **Do not place any object** between the oven front face and the door or allow soil or cleaner residue to accumulate on sealing surfaces.
- (c) **WARNING** : If the door or door seals are damaged, the oven must not be operated until it has been repaired by an authorised NEC repairer : (1) door (bent), (2) hinges and latches (broken or loose), (3) door seals and sealing surfaces.
- (d) **WARNING** : It is hazardous for anyone other than an authorised NEC repairer to carry out any service or repair operation which involves the removal of a cover which gives protection against exposure to microwave energy.
- (e) **WARNING** : Liquids or other foods must not be heated in sealed containers since they are liable to explode.
- (f) **WARNING** : Only allow children to use the oven without supervision when adequate instructions have been given so that the child is able to use the oven in a safe way and understands the hazards of improper use.
 - It is not recommended for use in an environment where excessive vibration could be experienced
 - The appliance is not intended for use by young children or infirm persons without supervision.
 - Young children should be supervised to ensure that they do not play with the appliance

TABLE OF CONTENTS

- PRECAUTIONS TO AVOID POSSIBLE EXPOSURE TO EXCESSIVE MICROWAVE ENERGY.....1
- IMPORTANT SAFETY INSTRUCTIONS2
- EARTHING INSTRUCTIONS3
- INSTALLATION3
- FEATURES DIAGRAM.....4-5
- OPERATION PROCEDURE6
- HOW TO SET THE OVEN CONTROLS7~17
- CARE AND CLEANING18
- SPECIFICATIONS.....19
- IMPORTANT NOTE19
- BEFORE YOU CALL FOR SERVICE.....20
- QUESTIONS AND ANSWERS.....20~21
- COOKING INSTRUCTIONS.....22
- COOKING UTENSILS.....22
- USE YOUR MICROWAVE OVEN SAFELY.....23
- ARCING.....23
- MICROWAVING PRINCIPLES24
- HOW MICROWAVES COOK FOOD.....24
- CONVERSION CHARTS.....24
- COOKING TECHNIQUES25
- DEFROSTING GUIDE26
- DEFROSTING CHART27
- COOKING & REHEATING CHART28
- VEGETABLE CHART29~30
- RECIPES31~33

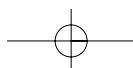

IMPORTANT SAFETY INSTRUCTIONS

READ CAREFULLY AND KEEP FOR FUTURE REFERENCE

WARNING: To prevent fire, burns, electric shock and other hazards please heed the following warnings:

Listed below are certain rules and safeguards to follow to assure high performance from your microwave oven.

1. Do not use the oven for any reason other than food preparation, such as for drying clothes, paper, or any other nonfood items or for sterilizing purposes.
2. Do not use the oven when empty, this could damage the oven.
3. Do not use the oven cavity for any type of storage, such as papers, cookbooks, cookware, etc.
4. Do not operate the oven without the glass tray in place. Be sure it is sitting properly on the rotating base.
5. Make sure you remove caps or lids prior to cooking when you cook food sealed in bottles.
6. Do not put foreign material between the oven surface and door. It could result in excessive leakage of microwave energy.
7. Do not use recycled paper products for cooking. They may contain impurities which could cause sparks and/or fires when used during cooking.
8. Do not pop popcorn unless popped in a microwave approved popcorn popper or unless it's commercially packaged and recommended especially for microwave ovens. Microwave popped corn produces a lower yield than conventional popping; there will be a number of unpopped kernels. Do not use oil unless specified by the manufacturer.
9. Do not pop popcorn longer than the manufacturer's directions. (popping time is generally below 3 minutes). Longer cooking does not yield more popped corn, it can cause scorchings and fire. Also, the cooking tray can become too hot to handle or may break.
10. Do not cook any food surrounded by a membrane, such as egg yolks, potatoes, chicken livers, etc., without first piercing them several times with a fork.
11. If smoke is observed, switch off or unplug the appliance and keep the door closed in order to stifle any flames.
12. When heating food in plastic or paper containers, keep an eye on the oven due to the possibility of ignition.
13. The contents of feeding bottles and baby food jars should be stirred or shaken and the temperature checked before consumption, in order to avoid burns.
14. Always test the temperature of food or drink which has been heated in a microwave oven before you give it to somebody, especially to children or elderly people. This is important because food and drink which has been heated in a microwave oven continue to get hotter even though the microwave oven cooking has stopped.
15. Eggs in their shell and whole hard-boiled eggs should not be heated in microwave ovens since they may explode, even after microwave heating has ended;
16. Keep the waveguide cover clean at all times. Wipe the oven interior with a soft damp cloth after each use. If you leave grease or fat anywhere in the cavity it may overheat, smoke or even catch fire when next using the oven.
17. Never heat oil or fat for deep frying as the temperature cannot be controlled and this may lead to overheating and fire.
18. Microwave heating of beverages can result in delayed eruptive boiling, therefore care must be taken when handling the container.

SAVE THESE INSTRUCTIONS

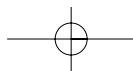

EARTHING INSTRUCTIONS

This appliance must be earthed. In the event of an electrical short circuit, earthing reduces the risk of electric shock by providing an escape wire for the electric current. This appliance is equipped with a cord having a earthing wire with a earthing plug. The plug must be plugged into an outlet that is properly installed and earthed.

WARNING : Improper use of the earthing plug can result in a risk of electric shock. Consult a qualified electrician or serviceman if the earthing instructions are not completely understood, or if doubt exists as to whether the appliance is properly earthed. If it is necessary to use an extension cord, use only a 3-wire extension cord that has a 3-blade earthing plug, and a 3-slot receptacle that will accept the plug on the appliance. The marked rating of the extension cord should be equal to or greater than the electrical rating of the appliance.

INSTALLATION

1. Ventilation

Do not block air vents. If they are blocked during operation, the oven may overheat and eventually cause a failure. For proper ventilation, allow 75mm between oven sides and rear. The minimum free space allowed from the top surface of the microwave is 100mm.

2. Steady, flat location

This oven should be set on a steady, flat surface.
This oven is designed for counter top use only.

3. Leave space behind and side

Clearance around all air vents is necessary. If vents are covered during operation, the oven may overheat and could cause permanent damage.

4. Away from radio and TV sets

Poor television reception and radio interference may result if the oven is located close to a TV, radio antenna, feeder and so on. Position the oven as far from them as possible.

5. Position away from heating appliances and water taps

Position your microwave away from hot air, steam or splash as the insulation could be adversely affected and could cause permanent damage.

6. Power supply

- Check your local power source. This oven requires a current of approximately 6 amperes, 240V, 50Hz.
- Power supply cord is about 0.8 meters long.
- The voltage used must be the same as specified on this oven. Using a higher voltage may result in a fire or other accident causing oven damage. Using low voltage will cause slow cooking. No responsibility will be taken for damage resulting from use of this oven with a voltage of ampere fuse other than those specified.
- If the supply cord is damaged, it must be replaced by the manufacturer or its service agent or a similarly qualified person in order to avoid a hazard.

7. Examine the oven after unpacking for any damage

Examine your oven for damage such as: misaligned door, broken door, a dent in the cavity. If any of these are visible, DO NOT INSTALL your microwave and notify your dealer immediately.

8. Do not operate the oven if it is colder than room temperature

This can occur if delivery occurs in very cold weather. Allow the oven to return to room temperature before operation.

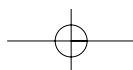

FEATURES DIAGRAM

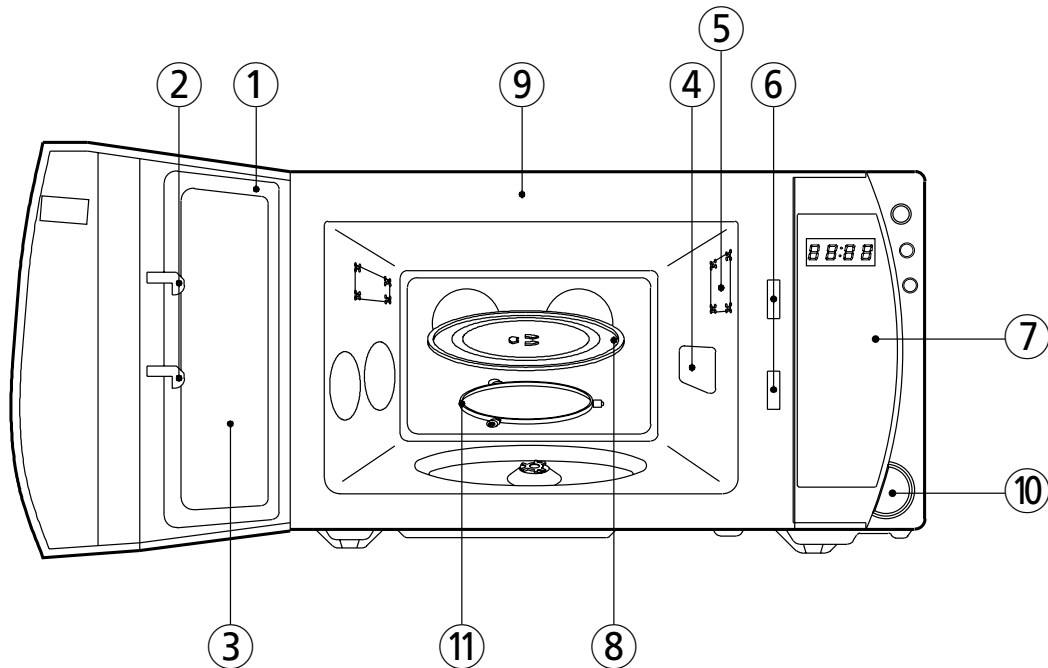

① DOOR SEAL

Door seals maintain the microwaves within the oven cavity and prevents microwave leakage.

② DOOR HOOK

When the door is closed, it will automatically lock shut. If door is opened while oven is operating, the magnetron tube will immediately stop operating.

③ DOOR SCREEN

Allows viewing of food. Microwaves cannot pass through perforations in screen.

④ SPATTER SHIELD

Protects the microwave outlet from splashes of cooking foods.

⑤ OVEN LAMP

Automatically turns on during oven operating.

⑥ SAFETY INTERLOCK SYSTEM

⑦ CONTROL PANEL

⑧ GLASS COOKING TRAY

Made of special heat resistant glass. The tray must always be in proper position before operating. Do not cook food directly on the tray.

⑨ OVEN FRONT PLATE

⑩ DOOR OPENING BUTTON

To open the door push the door opening button. When door is closed, it will automatically lock shut. If door is opened while oven is operating, the magnetron tube will immediately stop operating.

⑪ ROLLER GUIDE

Supports the glass cooking tray.

FEATURES DIAGRAM (continued)

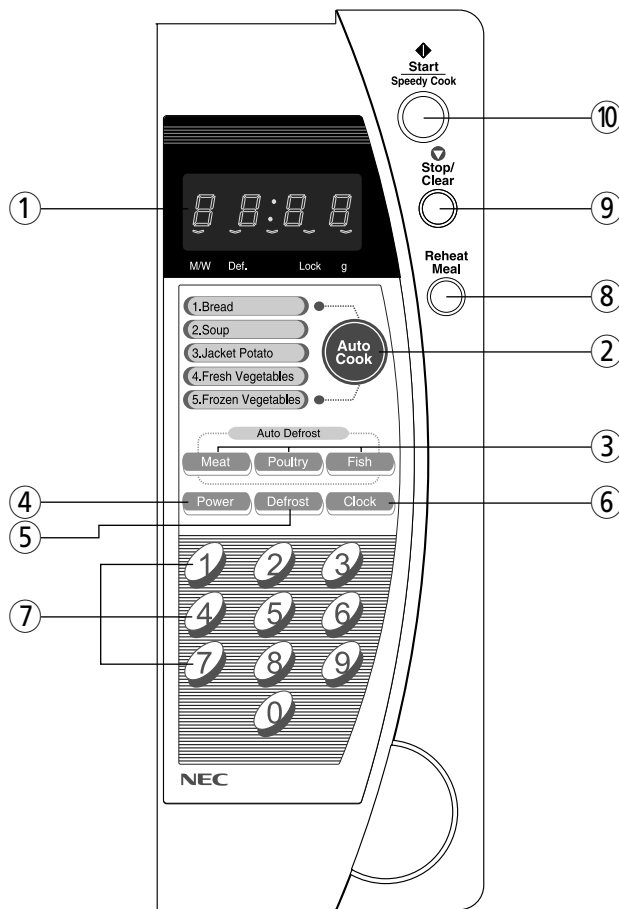

① **Display**
Cooking time, power level, present time are displayed.

② **Auto Cook**
Used to cook using a program or to reheat.

③ **Auto defrost**
Used to defrost food (for weight).

④ **Power**
Used to set power level.

⑤ **Defrost**
Used to defrost food (for time).

⑥ **Clock**
Used to set clock.

⑦ **Time set pad**
Used to set the cooking time and the present time.

⑧ **Reheat Meal**
Used to reheat dinner plate.

⑨ **Stop/Clear**
Used to stop the oven operation or to delete the cooking data.

⑩ **Start/Speedy Cook**
Used to start the oven operation and also increase the reheat time by 30 seconds.

OPERATION PROCEDURE

This section includes useful information about oven operation.

1. Plug power supply cord into a standard 3- pronged 10 Amp, 240V AC 50Hz power outlet.
 2. After placing the food in a suitable container, open the oven door and place it on the glass tray.
The glass tray and roller guide must always be in place during cooking.
 3. Shut the door. Make sure that it is firmly closed.
-
- | | |
|--|---|
| <ol style="list-style-type: none"> 1 The oven light is on only when the microwave oven is operating. 2 The oven door can be opened at any time during operation by touching the door release button on the control panel. The oven will automatically shut off. 3 Each time a pad is touched, a BEEP will sound to acknowledge the touch. 4 The oven automatically cooks on full power unless set to a lower power level. 5 The display will show ":0" when the oven is plugged in. 6 Time clock returns to the present time when the cooking time ends. | <ol style="list-style-type: none"> 7 When the STOP/CLEAR button is pressed during the oven operation, the oven stops cooking and all information retained. To erase all information (except the present time), touch the STOP/CLEAR button once more. If the oven door is opened during the oven operation, all information is retained. 8 If the START/SPEEDY COOK button is pressed and the oven does not operate, check the area between the door and door seal for obstructions and make sure the door is closed securely. The oven will not start cooking until the door is completely closed or the program has been reset. |
|--|---|

Make sure the oven is properly installed and plugged into the electrical outlet.

WATTAGE OUTPUT CHART

- The power-level is set by pressing the POWER pad. The chart shows the display, the power level and the percentage of power.

Touch POWER pad, Once the Touch	Power Level (Display)	Approximate Percentage of Power
POWER	P-HI	100%
9	P-90	90%
8	P-80	80%
7	P-70	70%
6	P-60	60%
5	P-50	50%
4	P-40	40%
3	P-30	30%
2	P-20	20%
1	P-10	10%
0	P-00	0%

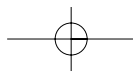

HOW TO SET THE OVEN CONTROLS

SETTING THE CLOCK

When the oven is first plugged in, the display will flash ":0" and a tone will sound. If the AC power ever goes off, the display shows ":0" when the power comes back on.

DO THIS...

THIS HAPPENS...

1. Touch **CLOCK** pad.

CLOCK

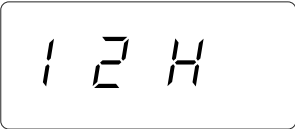

M/W Def. Lock g

This is a 12 hour clock system.

2. Touch **CLOCK** pad once more.

CLOCK

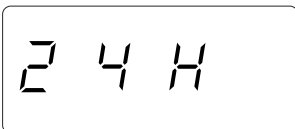

M/W Def. Lock g

This is a 24 hour clock system.

NOTE: This oven is multiple clock system. If you want a 12 hour clock system, omit this step.

3. Enter the correct time of day by touching the numbers in sequence.

1

2

3

0

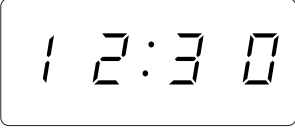

M/W Def. Lock g

The display will then begin blinking.

4. Touch **CLOCK** pad.

CLOCK

The display stop blinking and the colon starts blinking.
 If you selected 12 hour clock system this digital clock allows you to set from 1:00 to 12:59.
 If you selected 24 hour clock system, this digital clock allows you to set from 0:00 to 23:59.



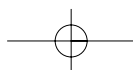

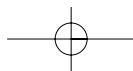
NOTE: If you attempt to enter an incorrect time, the time will not be set and a error signal tone will sound. Touch the CLOCK pad re-enter the time.



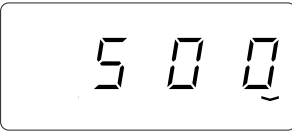

WEIGHT DEFROSTING

WEIGHT DEFROST lets you easily defrost food by eliminating guesswork in determining defrosting time. Follow the steps below for easy defrosting.

DO THIS...	THIS HAPPENS...	
<div data-bbox="245 461 435 544" style="border: 1px solid black; padding: 5px; text-align: center; margin-bottom: 10px;"> AUTO DEFROST </div> <p>1. Touch AUTO DEFROST (MEAT/POULTRY/FISH) pad. example) MEAT</p>	 <p style="text-align: center; font-size: small;">M/W Def. Lock g</p>	<p>The g indicator lights and defrosting weight is displayed.</p>
<div data-bbox="240 719 440 770" style="border: 1px solid black; padding: 2px; text-align: center; margin-bottom: 10px;"> M E A T </div> <p>2. Touch MEAT pad for the defrosting weight you want. example) MEAT touched twice.</p>	 <p style="text-align: center; font-size: small;">M/W Def. Lock g</p>	<p>The display will show defrost weight you pressed in the order you touched.</p>
<div data-bbox="296 981 384 1115" style="text-align: center; margin-bottom: 10px;">  </div> <p>3. Press START/SPEEDY COOK button.</p>	 <p style="text-align: center; font-size: small;">M/W Def. Lock g</p>	<p>WEIGHT DEFROSTING begins. The defrosting time is automatically determined by the food category and weight entered. The g indicator goes off and the Def. indicator blinks and the defrosting time counts down in the display window. The oven beeps during the defrosting cycle to signal that the food needs to be turned or rearranged. When the defrosting time ends, you will hear 3 beeps.</p>

NOTE: Thin areas or edges of food can be shielded with strips of aluminium foil to prevent over defrosting.

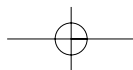

WEIGHT DEFROSTING(continued)

- | | | |
|-------------|--|---|
| MEAT | 1. Touch Meat pad. | The g indicator light and "500" is displayed. |
| | 2. Select the desired defrosting weight.
(Refer to the weight defrost chart below.) | The display will show what you touched. |
| | 3. Press START/SPEEDY COOK button. | MEAT DEFROSTING begins. |

- | | | |
|----------------|--|---|
| POULTRY | 1. Touch Poultry pad. | The g indicator light and "800" is displayed. |
| | 2. Select the desired defrosting weight.
(Refer to the weight defrost chart below.) | The display will show what you touched. |
| | 3. Press START/SPEEDY COOK button. | POULTRY DEFROSTING begins. |

- | | | |
|-------------|---|---|
| FISH | 1. Touch Fish pad. | The g indicator light and "300" is displayed. |
| | 2. Select the desired defrosting weight. (Refer to the weight defrost chart below.) | The display will show what you touched. |
| | 3. Press START/SPEEDY COOK button. | FISH DEFROSTING begins. |

* WEIGHT DEFROST CHART

Touch pad	MEAT	POULTRY	FISH
once	500 g	800 g	300 g
twice	800 g	1000 g	500 g
3 times	1000 g	1200 g	800 g
4 times	1200 g	1500 g	1000 g

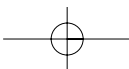

TIME DEFROSTING

When TIME DEFROST is selected, the automatic cycle divides the defrosting time into periods of alternating defrost and stand times by cycling on and off.

DO THIS...

THIS HAPPENS...



1. Touch **DEFROST** pad.

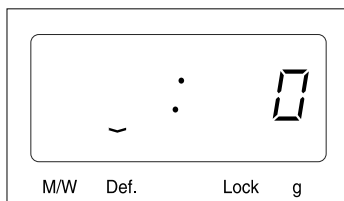

The Def. indicator lights and " :0" is displayed.

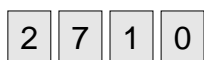

2. Touch number pads for the defrosting time you want.

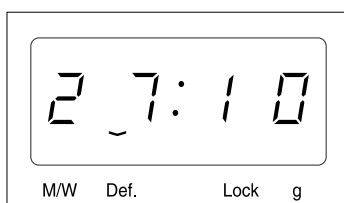

The display will show the numbers you pressed in the order you touched.

NOTE: Your oven can be programmed for 99 minutes 99 seconds. (99:99)



3. Press **START/SPEEDY COOK COOK COOK** button.

When you touch **START** pad, the Def. indicator starts blinking to show the oven is in the TIME DEFROST mode.
The display counts down the time to show you how much defrosting time is left in the TIME DEFROST mode.
The oven beeps during the defrosting cycle to signal that the food needs to be turned or rearranged. When the defrosting time ends, you will hear 3 beeps.

NOTE: Thin areas or edges of food can be shielded with strips of aluminium foil to prevent over defrosting.

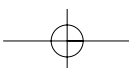

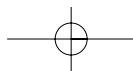

COOKING IN ONE STAGE

DO THIS...

THIS HAPPENS...



1. Touch **POWER** pad.

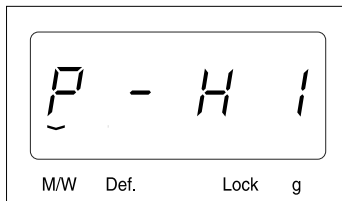

The STAGE 1 indicator lights and "P-HI " is displayed.



2. Touch **POWER** pad for the power level you want.

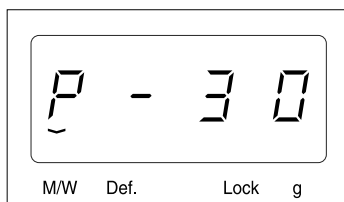

The display will show what you touched. This example shows power level 3.

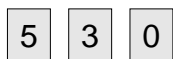

3. Touch number pads for the cooking time.

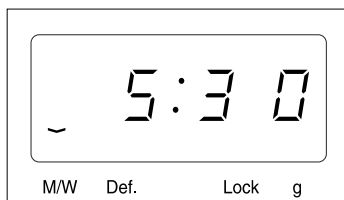

The display will show the numbers you pressed in the order you touched.

NOTE: Your oven can be programmed for 99 minutes 99 seconds. (99:99)

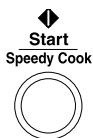

When you press START/SPEEDY COOK button, the M/W indicator starts blinking to show the oven is cooking. The display counts down the time to show how much cooking time is left. When the defrosting time ends, you will hear 3 beeps.

4. Touch **START** pad.



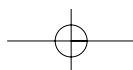

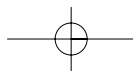
NOTE: It is recommended to use lower power levels and increase the cooking time required for foods such as cheese, milk and the slow cooking of meat.



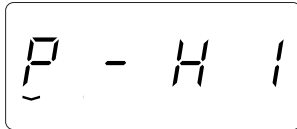
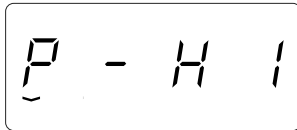

WEIGHT DEFROSTING AND COOKING IN ONE STAGES

Some recipes require frozen foods to be thawed before cooking.
 This oven can be programmed to automatically defrost foods before cooking.

DO THIS...	THIS HAPPENS...	
<div data-bbox="244 472 434 555" style="border: 1px solid black; padding: 5px; text-align: center; margin-bottom: 10px;"> AUTO DEFROST </div> <p>1. Touch AUTO DEFROST (MEAT/POULTRY/FISH) pad. example) POULTRY</p>	 <p style="text-align: center; font-size: small;">M/W Def. Lock g</p>	<p>The Def. indicator lights and "800" is displayed.</p>
<div data-bbox="244 763 434 846" style="border: 1px solid black; padding: 5px; text-align: center; margin-bottom: 10px;"> POULTRY </div> <p>2. Touch POULTRY pads for the defrosting weight you want. example) The pad pressed 4 times.</p>	 <p style="text-align: center; font-size: small;">M/W Def. Lock g</p>	<p>The display will show the defrost weight you pressed in the order you touched.</p>
<div data-bbox="244 1048 434 1131" style="border: 1px solid black; padding: 5px; text-align: center; margin-bottom: 10px;"> POWER </div> <p>3. Touch POWER pad.</p>	 <p style="text-align: center; font-size: small;">M/W Def. Lock g</p>	<p>The M/W indicator lights and "P-HI " is displayed.</p>
<div data-bbox="244 1305 434 1388" style="border: 1px solid black; padding: 5px; text-align: center; margin-bottom: 10px;"> POWER </div> <p>4. Touch POWER pad for the power level you want.</p>	 <p style="text-align: center; font-size: small;">M/W Def. Lock g</p>	<p>This example shows full power (100%).</p>
<div style="display: flex; justify-content: space-around; margin-bottom: 10px;"> <div style="border: 1px solid black; padding: 2px 5px;">5</div> <div style="border: 1px solid black; padding: 2px 5px;">3</div> <div style="border: 1px solid black; padding: 2px 5px;">0</div> </div> <p>5. Touch number pads for the cooking time you want in the first stage.</p>	 <p style="text-align: center; font-size: small;">M/W Def. Lock g</p>	<p>The display will show the numbers you pressed in the order you touched. This example shows 5 minutes 30 seconds at full power.</p>

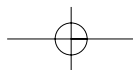

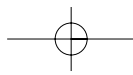
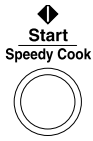
**DO THIS...****THIS HAPPENS...**

6. Press **START/SPEED COOK** button.

When you press START/SPEEDY COOK button, the Def. and M/W indicators lights. The Def. indicator starts blinking to show you that the oven is in Def. mode. The display counts down the time remaining in WEIGHT DEFROST mode. Turn over, break apart and redistribute at the beep.

At the end of WEIGHT DEFROST mode, the oven will beep and start stage one. The Def. indicator goes off and the M/W indicator starts blinking. The display counts down the time remaining in stage, three beeps will be heard.

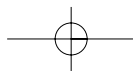

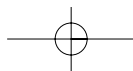

TIME DEFROSTING AND COOKING IN ONE STAGES

Some recipes require frozen foods to be thawed before cooking.
This oven can be programmed to automatically defrost foods before cooking.

DO THIS...	THIS HAPPENS...	
<div data-bbox="244 472 435 555" style="border: 1px solid black; padding: 5px; text-align: center; margin-bottom: 10px;">DEFROST</div> <p>1. Touch DEFROST pad.</p>	<p>The display shows a small dash under the 'Def.' indicator and the number '0' on the right. Below the display are labels: M/W, Def., Lock, g.</p>	<p>The Def. indicator lights and " : 0" is displayed.</p>
<div data-bbox="244 730 411 786" style="display: flex; justify-content: space-around; margin-bottom: 10px;"> 5 3 0 </div> <p>2. Touch number pads for the cooking time you want in the first stage.</p>	<p>The display shows '5:30' with a small dash under the '5'. Below the display are labels: M/W, Def., Lock, g.</p>	<p>The display will show the numbers you pressed in the order you touched. This example shows 5 minutes 30 seconds.</p>
<div data-bbox="244 992 435 1075" style="border: 1px solid black; padding: 5px; text-align: center; margin-bottom: 10px;">POWER</div> <p>3. Touch POWER pad.</p>	<p>The display shows 'P - H I' with a small dash under the 'P'. Below the display are labels: M/W, Def., Lock, g.</p>	<p>The M/W indicator lights and "P-HI" is displayed.</p>
<div data-bbox="244 1249 435 1332" style="border: 1px solid black; padding: 5px; text-align: center; margin-bottom: 10px;">POWER</div> <p>4. Touch the POWER pads for the power level you want.</p>	<p>The display shows 'P - 8 0' with a small dash under the 'P'. Below the display are labels: M/W, Def., Lock, g.</p>	<p>The display will show what you touched.</p>
<div data-bbox="244 1503 411 1559" style="display: flex; justify-content: space-around; margin-bottom: 10px;"> 4 2 0 </div> <p>5. Touch the number pads for the cooking time you want.</p>	<p>The display shows '4:20' with a small dash under the '4'. Below the display are labels: M/W, Def., Lock, g.</p>	<p>The display will show the numbers you pressed in the order you touched. This example shows 4 minutes 20 seconds at power level 8.</p>

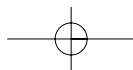

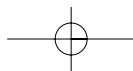

DO THIS...

THIS HAPPENS...

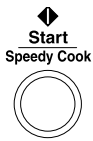

6. Press **START/speedy cook** button.

When you press START/SPEEDY COOK button, the Def. and M/W indicators lights. The Def. indicator starts blinking to show you that the oven is in Def. mode. The display counts down the time remaining in WEIGHT DEFROST mode. Turn over, break apart and redistribute at the beep.

At the end of WEIGHT DEFROST mode, the oven will beep and start stage one. The Def. indicator goes off and the M/W indicator starts blinking. The display counts down the time remaining in stage, three beeps will be heard.

SPEEDY COOK

SPEEDY COOK allows you to reheat for 30 seconds at 100% (full power) by simply pressing the START/SPEEDY COOK button.

By repeatedly pressing the START/SPEEDY COOK button, you can also extend reheating time to by 30 seconds to a maximum of 5 minutes.

DO THIS...

THIS HAPPENS...

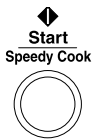

1. Press **START/SPEEDY COOK** button.

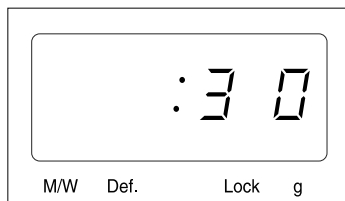

When you press SPEEDY COOK, " :30" is displayed. After 1.5 seconds, the oven starts reheating.

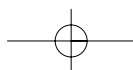

AUTO COOKING

Auto Cook allows you to cook or reheat many of your favorite foods by touching just one pad. To increase quantity, touch chosen pad until number in display is same as desired quantity to cook. (except for MUFFIN & DINNER PLATE)

DO THIS...

THIS HAPPENS...

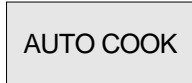

1. Touch **AUTO COOK** pad.

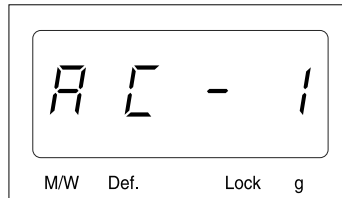

When you touch AUTO COOK pad, "AC-1" is displayed.

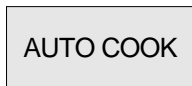

2. Touch **AUTO COOK** pad for menu you want. (Refer to AUTO COOK chart below)

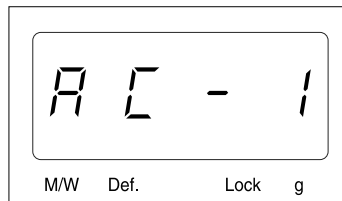

This display shows the cook menu you pressed in the order you touched.

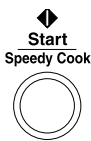

3. Press **START/SPEEDY COOK** button.
example) 1. Bread

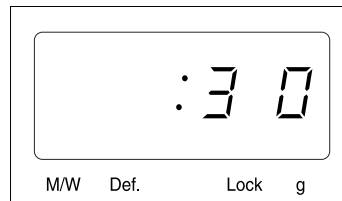

When you press START/SPEEDY COOK button " :30" is displayed, the display counts down the time. It is automatically determined by food category.

* AUTO COOK CHART

Touch pad	Auto Cook menu	Display	Cooking time
once	1. Bread	AC-1	0 : 40
twice	2. Soup	AC-2	2 : 30
3 twice	3. Jacket Potato	AC-3	11 : 00
4 times	4. Fresh Vegetables	AC-4	2 : 20
5 times	5. Frozen Vegetables	AC-5	2 : 30



ONE TOUCH COOKING

DO THIS...



1. Press **REHEAT MEAL** button.

THIS HAPPENS...

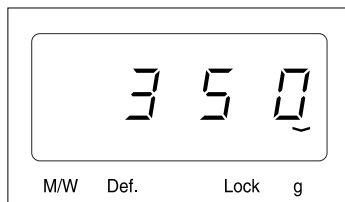

When you press REHEAT MEAL button, "350" is displayed. The g indicator lights. After the 1.5 seconds, the display changed into cooking time of quantity and the oven starts cooking. The g indicator goes off.

* REHEAT MEAL *

- 350g: Press REHEAT MEAL once.
- 450g: Press REHEAT MEAL twice within 1.5 seconds.

CHILD SAFETY LOCK

The safety lock prevents unwanted oven operation by small children. To set, Press STOP/CLEAR for 3 seconds, lock indicator lights. To cancel, press STOP/CLEAR for 3 seconds, lock indicator goes off.

TO STOP THE OVEN WHILE THE OVEN IS OPERATING

1. Press STOP/CLEAR button.
 - You can restart the oven by pressing START/SPEEDY COOK button.
 - Press STOP/CLEAR once more to erase all instructions.
 - You must enter in new instructions.
2. Open the door.
 - You can restart the oven by closing the door and pressing START.

NOTE: Oven stops operating when door is opened.

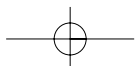



CARE AND CLEANING

Although your oven is provided with safety features, it is important to observe the following:

1. It is important not to defeat or tamper with safety interlocks.
2. Do not place any object between the oven front face and the door or allow residue to accumulate on sealing surfaces. Wipe the sealed area frequently with a mild detergent, rinse and dry. Never use abrasive powders or pads.
3. When open, the door must not be subjected to strain. Any load could cause the oven to fall forward and cause injury and could damage the door. Do not operate the oven if it is damaged, have it repaired by an authorised NEC repairer. It is particularly important that the oven closes properly and that there is no damage to the:
 - i) Door (bent)
 - ii) Hinges and Hooks (broken or loose)
 - iii) Door seals and sealing surfaces.
4. The oven should not be adjusted or repaired by anyone except an authorised NEC repairer.
5. The oven should be cleaned regularly and any food deposits removed.
6. Failure to maintain the oven in a clean condition could lead to deterioration of the microwave oven surface. This can adversely affect the life of the appliance and possibly result in a hazardous situation.

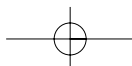

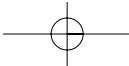

SPECIFICATIONS

POWER SUPPLY	230~240V 50Hz, SINGLE PHASE WITH EARTHING
MICROWAVE POWER CONSUMPTION	1350 W
MICROWAVE ENERGY OUTPUT	900 W
MICROWAVE FREQUENCY	2450MHz
OUTSIDE DIMENSIONS (WXHxD)	495 x 294 x 384mm
CAVITY DIMENSIONS (WXHxD)	320 x 237 x 343mm
NET WEIGHT	APPROX. 13.5Kg
TIMER	99 min. 99 sec.
POWER SELECTIONS	10 LEVELS

* Specifications are subject to change without notice.

IMPORTANT

The wires in this mains lead are coloured in accordance with the following code.

Green-and-yellow	: Earth
Blue	: Neutral
Brown	: Live

As the colours of the wires in the mains lead of this appliance may not correspond with the coloured markings identifying the terminals in your plug, proceed as follows:

The wire which is coloured green-and-yellow must be connected to the terminal in the plug which is marked with the letter 'E' or by the earth symbol or green-and-yellow. The wire which is coloured blue must be connected to the terminal which is marked with the letter 'N' or coloured black.

The wire which is coloured brown must be connected to the terminal which is marked with the letter 'L' or coloured red.

WARNING: This appliance must be earthed.

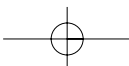

BEFORE YOU CALL FOR SERVICE

Refer to following checklist, you may prevent an unnecessary service call.

* The oven doesn't work :

1. Check that the power cord is securely plugged in.
2. Check that the door is firmly closed.
3. Check that the cooking time is set.
4. Check for a blown circuit fuse or tripped main circuit breaker in your house.

* Sparking in the cavity;

1. Check utensils. Metal containers or dishes with metal trim should not be used.
2. Check that metal skewers or foil does not touch the interior walls.

A list of these stations in included in the oven.

DO NOT ATTEMPT TO SERVICE THE OVEN YOURSELF !

QUESTIONS AND ANSWERS

* **Q : I accidentally ran my microwave oven without any food in it. Is it damaged?**

A : Running the oven empty for a short time will not damage the oven. However, it is not recommended.

* **Q : Can the oven be used with the glass tray or roller guide removed?**

A : No. Both the glass tray and roller guide must always be used in the oven before cooking.

* **Q : Can I open the door when the oven is operating?**

A : The door can be opened anytime during the cooking operation. Then microwave energy will be instantly switched off and the time setting will be maintain until the door is closed.

* **Q : Why do I have moisture in my microwave oven after cooking?**

A : The moisture on the side of your microwave oven is normal. It is caused by steam from cooking food hitting the cool oven surface.

* **Q : Does microwave energy pass through the viewing screen in the door?**

A : No. The metal screen bounces back the energy to the oven cavity. The holes are made to allow light to pass through. They do not let microwave energy pass through.

* **Q : Why do eggs sometimes pop?**

A : When baking or poaching eggs, the yolk may pop due to steam build-up inside the yolk membrane. To prevent this, simply pierce the yolk with a toothpick before cooking. Never cook eggs without piercing their shells.

QUESTIONS AND ANSWERS (continued)

* **Q : Why is a standing time recommended after the cooking operation has been completed?**

A : Standing time is very important.

With microwave cooking, the heat is in the food, not in the oven. Many foods build up enough internal heat to allow the cooking process to continue, even after the food is removed from the oven. Standing time for joints of meat, large vegetables and cakes is to allow the inside to cook completely, without overcooking the outside.

* **Q : What does “standing time” mean?**

A : “Standing time” means that food should be removed from the oven and covered for additional time to allow it to finish cooking. This frees the oven for other cooking.

* **Q : Why does my oven not always cook as fast as the microwave cooking guide says?**

A : Check your cooking guide again, to make sure you’ve followed directions exactly and to see what might cause variations in cooking time. Cooking guide times and heat settings are suggestions to help prevent over-cooking.

Variations in the size, shape and weights and dimensions could require longer cooking time. Use your own judgement along with the cooking guide suggestions to check whether the food has been properly cooked just as you would do with a conventional cooker.

* **Q : Will the microwave oven be damaged if it operates while empty?**

A : Yes. Never run it empty.

* **Q : Can I operate my microwave oven without the turntable or turn the turntable over to hold a large dish?**

A : No. If you remove or turn over the turntable, you will get poor cooking results. Dishes used in your oven must fit on the turntable.

* **Q : Is it normal for the turntable to turn in either direction?**

A : Yes. The turntable rotates clockwise or counterclockwise, depending on the rotation of the motor when the cooking cycle begins.

COOKING INSTRUCTIONS

Only use utensils that are suitable for use in microwave ovens.

UTENSILS TEST

Place the utensil in question next to a glass measure filled with water, in the microwave oven. Microwave at high power for 1-2 minutes. If the water heats up, but the utensil remains cool, the utensil is microwave-safe. However if the utensil becomes warm, microwaves are being absorbed by the utensil and it should not be in the microwave oven. You probably have many items on hand in your kitchen right now that can be used as cooking equipment in your microwave oven. Read through the following checklist.

COOKING UTENSILS

Recommended Use

- **Glass and glass-ceramic bowls and Dishes** - Use for heating or cooking.
- **Microwave browning dish** - Use to brown the exterior of small items such as steaks, chops, or pancakes. Follow the directions provided with your browning dish.
- **Microwaveable plastic wrap** - Use to retain steam. Leave a small opening for some steam to escape and avoid placing it directly on the food.
- **Wax paper** - Use as a cover to prevent spattering.
- **Paper towels, and napkins and cups** - Use for short term heating and covering; they absorb excess moisture when warming food. Pay special attention as over-heating may cause a fire in your oven. Do not use re-cycled paper products, e.g. kitchen roll unless they say they are specifically designed for use in a microwave oven. These products contain impurities which may cause sparks and/or fires when used.
- **Thermometers** - Use only those labeled "Microwave Safe" and follow all directions. Check the food in several places. Conventional thermometers may be used once the food has been removed from the oven.
- **Microwave cling film, microwave roasting bags** - Microwave cling film and bags must be vented for steam to escape, pierce in 4~5 places. Do not use plastic or metal ties as they may melt or catch fire due to electrical 'arcing'.

Limited Use

- **Aluminum foil** - Use narrow strips of foil to prevent overcooking of exposed areas. Using too much foil can damage your oven, so be careful.
- **Ceramic, porcelain, and stoneware** - Use these if they are labeled "Microwave Safe." If they are not labeled, test them to make sure they can be used safely. Never use dishes with metallic trim.
- **Plastic** - Use only if labeled "Microwave Safe." Other plastics can melt.
- **Thin plastic, paper, straw and wooden containers** - Always attend the oven closely. Look at the oven from time to time when cooking or reheating food in disposable containers of plastic, paper or other combustible material. Only use for warming food. Pay special attention as over-heating may cause a fire in your oven.

Not Recommended

- **Glass jars and bottles** - Regular glass can shatter as it is too thin for a microwave.
- **Paper bags** - These are a fire hazard, except for popcorn bags that are designed for microwave use.
- **Styrofoam plates and cups** - These can melt and leave an unhealthy residue on food.
- **Plastic storage and food containers** - Containers such as margarine tubs can melt in the microwave.
- **Metal utensils** - These can damage your oven. Remove all metal before cooking.

USE YOUR MICROWAVE OVEN SAFELY

General Use

Do not attempt to defeat or tamper with safety interlocks.

Do not place any object between the oven front frame and the door or allow residue to build up on sealing surfaces. Wipe with a mild detergent, rinse and dry. Never use abrasive powders or pads.

Do not subject the oven door to strain or weight such as a child hanging on an open door.

This could cause the oven to fall forward resulting in injury to you and damage to the oven.

Do not operate the oven if door seals or sealing surfaces are damaged; or if door is bent; or if hinges are loose or broken.

Do not operate the oven empty. This will damage the oven.

Do not attempt to dry clothes, newspapers or other materials in the oven. They may catch on fire.

Do not use recycled paper products as they may contain impurities which may cause sparks or fires.

Do not hit or strike the control panel with hard objects. This can damage the oven.

Food

Never use your microwave oven for home canning. The oven is not designed for proper home canning. Improperly canned food may spoil and be dangerous to consume.

Always use the minimum recipe cooking time. It is better to undercook rather than overcook foods.

Undercooked foods can be returned to the oven for more cooking. If food is overcooked, nothing can be done.

Heat small quantities of food or foods with low moisture carefully. These can quickly dry out, burn or catch on fire.

Do not heat eggs in the shell. Pressure may build up and eggs can explode.

Potatoes, apples, egg yolks and sausages are examples of food with non-porous skins.

These must be pierced before cooking to prevent bursting.

Do not attempt to deep fat fry in your microwave oven.

Always stir liquids before heating. Heated liquids can erupt, if not mixed with air.

Do not leave the oven unattended while popping corn.

Do not pop corn in a paper bag unless it is the commercially prepared Microwave Popcorn product. The kernels can overheat and ignite a brown paper bag.

Do not put packaged Microwave Popcorn bags directly on the oven tray. Place the package on a microwave safe glass or ceramic plate to avoid overheating and cracking the oven tray.

Do not exceed the Microwave Popcorn manufacturers suggested popping time.

Longer popping does not yield more popcorn but it can result in scorch, burn or fire. Remember, the Popcorn bag and tray can be too hot to handle. Remove with caution and use pot holders.

ARCING

*If you see arcing, press **STOP/CLEAR** button and correct the problem.*

Arcing is the microwave term for sparks in the oven.

Arcing is caused by:

- Metal or foil touching the side of the oven.
- Foil not molded to food (upturned edges act like antennas).
- Metal, such as twist-ties, poultry pins, or gold rimmed dishes, in the microwave.
- Recycled paper towels containing small metal pieces being used in the microwave.

MICROWAVING PRINCIPLES

Microwave energy has been used in this country to cook and reheat food since early experiments with RADAR in World War II. Microwaves are present in the atmosphere all the time, both naturally and manmade sources. Manmade sources include radar, radio, television, telecommunication links and car phones.

HOW MICROWAVES COOK FOOD

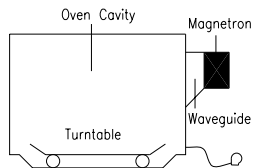

In a microwave oven, electricity is converted into microwave by the **MAGNETRON**.

► TRANSMISSION

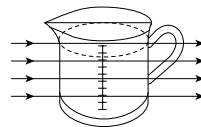

Then they pass through the cooking containers to be absorbed by the water molecules in the food, all foods contain water to a more or lesser extent.

► REFLECTION



The microwaves bounce off the metal walls and the metal door screen.

► ABSORPTION

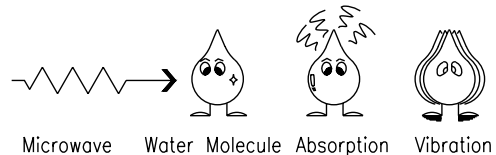

The microwaves cause the water molecules to vibrate which causes **FRICTION**, i.e. **HEAT**. This heat then cooks the food. Microwaves are also attracted to fat and sugar particles, and foods high in these will cook more quickly. Microwaves can only penetrate to a depth of 1½ - 2 inches(4-5cm) and as heat spreads through the food by conduction, just as in a traditional oven, the food cooks from the outside inwards.

CONVERSION CHARTS

WEIGHT MEASURES		VOLUME MEASURES		SPOON MEASURES	
15 g	1/2 oz.	30 ml	1 fl.oz.	1.25 ml	1/4 tsp
25 g	1 oz.	100 ml	3 fl.oz.	2.5 ml	1/2 tsp
50 g	2 oz.	150 ml	5 fl.oz. (1/4 pt)	5 ml	1 tsp
100 g	4 oz.	300 ml	10 fl.oz. (1/2 pt)	15 ml	1 tbsp
175 g	6 oz.	600 ml	20 fl.oz. (1pt)		
225 g	8 oz.				
450 g	1 lb.				

FLUID MEASUREMENTS		
1 Cup	= 8 fl.oz.	= 240 ml
1 Pint	= 16 fl.oz. (UK 20 fl.oz.)	= 480 ml (UK 560 ml)
1 Quart	= 32 fl.oz. (UK 40 fl.oz.)	= 960 ml (UK 1120 ml)
1 Gallon	= 128 fl.oz. (UK 160 fl.oz.)	= 3840 ml (UK 4500 ml)

COOKING TECHNIQUES

STANDING TIME

Dense foods e.g. meat, jacket potatoes and cakes, require standing time (inside or outside of the oven) after cooking, to allow heat to finish conducting to cook the center completely. Wrap meat joints and jacket potatoes in aluminium foil while standing. Meat joints need approx. 10-15 minutes, jacket potatoes 5 minutes. Other foods such as plated meal, vegetables, fish etc require 2-5 minutes standing. After defrosting food, standing time should also be allowed. If food is not cooked after standing time, return to the oven and cook for additional time.

MOISTURE CONTENT

Many fresh foods e.g. vegetables and fruit, vary in their moisture content throughout the season, particularly jacket potatoes. For this reason cooking times may have to be adjusted. Dry ingredients e.g. rice, pasta, can dry out during storage so cooking times may differ.

DENSITY

Porous airy foods heat more quickly than dense heavy foods.

CLING FILM

Cling film helps keep the food moist and the trapped steam assists in speeding up cooking times. Pierce before cooking to allow excess steam to escape. Always take care when removing cling film from a dish as the build-up of steam will be very hot.

SHAPE

Even shapes cook evenly. Food cooks better by microwave when in a round container rather than square.

SPACING

Foods cook more quickly and evenly if spaced apart. NEVER pile foods on top of each other.

STARTING TEMPERATURE

The colder the food, the longer it takes to heat up. Food from a fridge takes longer to reheat than food at room temperature.

LIQUIDS

All liquids must be stirred before and during heating. Water especially must be stirred before and during heating, to avoid eruption. Do not heat liquids that have previously been boiled. DO NOT OVERHEAT.

TURNING & STIRRING

Some foods require stirring during cooking. Meat and poultry should be turned after half the cooking time.

ARRANGING

Individual foods e.g. chicken portions or chops, should be placed on a dish so that the thicker parts are towards the outside.

QUANTITY

Small quantities cook faster than large quantities, also small meals will reheat more quickly than large portions.

PIERCING

The skin or membrane on some foods will cause steam to build up during cooking. These foods must be pierced or a strip of skin should be peeled off before cooking to allow the steam to escape. Eggs, potatoes, apples, sausages etc, will all need to be pierced before cooking. DO NOT ATTEMPT TO BOIL EGGS IN THEIR SHELLS.

COVERING

Cover foods with microwave cling film or a lid. Cover fish, vegetables, casseroles, soups. Do not cover cakes, sauces, jacket potatoes or pastry items.

DEFROSTING GUIDE

- Do not defrost covered meat. Covering might allow cooking to take place. Always remove outer wrap and tray. Use only containers that are microwave-safe.
 - Begin defrosting whole poultry breast-side- down. Begin defrosting roasts fat-side-down.
 - The shape of the package alters the defrosting time. Shallow rectangular shapes defrost more quickly than a deep block.
 - After $\frac{1}{3}$ of the defrost time has elapsed, check the food. You may wish to turn over, break apart, rearrange or remove thawed portions of the food.
 - During defrost, the oven will prompt you to turn food the over. At this point, open oven door and check the food. Follow the techniques listed below for optimum defrost results. Then, close oven door, touch the START pad to complete defrosting.
 - When defrosted, food should be cool, but softened in all areas. If still slightly icy, return to microwave oven very briefly, or let stand a few minutes. After defrosting, allow food to stand 5-60 minutes if there are any icy areas.
Poultry and fish may be placed under running cool water until defrosted
- ⇒ **Turn over** : Roast, ribs, whole poultry, turkey breasts, hot dogs, sausages, steaks, or chops.
- ⇒ **Rearrange** : Break apart or separate steaks, chops, hamburger patties, ground meat, chicken or seafood pieces, chunks of meat such as stew beef.
- ⇒ **Shield** : Use small strips of aluminum foil to protect thin areas or edges of unevenly shaped foods such as chicken wings. To prevent arching, do not allow foil to come within 1-inch of oven walls or door.
- ⇒ **Remove** : To prevent cooking, thawed portions should be removed from the oven at this point. This may shorten defrost time for food weighing less than 3 lbs.(1350g).

DEFROSTING CHART

Item and Weight	Defrosting Time	Standing Time	Special Techniques
BEEF Minced beef 1 lb./454g	8-10 min.	15-20 min.	Break apart and remove thawed portions with fork.
Stew Meat 1 1/2 lbs./675g	9-11 min.	25-30 min.	Separate and rearrange once.
Loin Roast 2 lbs./900g	14-16 min.	45-60 min.	Turn over after half the time. Shield as needed.
Patties 4 (4 oz..110g)	6-8 min.	15-20 min.	Turn over after half the time.
PORK Loin Roast 2 lbs./900g	14-15 min.	45-60 min.	Turn over after half the time. Shield as needed.
Spareibs 1 lb. 450g	5-6 min.	25-30 min.	Separate and rearrange once.
Chops 4 (5 oz./125g)	6-7 min.	25-30 min.	Separate and turn over once.
Minced 1lb./450g	7-9 min.	15-20 min.	Break apart and remove thawed portions with fork.
POULTRY Whole Chicken 2 1/2 lbs./1125g	15-17 min.	45-90 min.	Break side down. Turn over after half the time. Shield as needed.
Chicken Breasts 1lb./450g	7-8 min.	15-30 min.	Separate and rearrange once.
Fryer Chicken(cut up) 2lbs./900g	11-13 min.	25-30 min.	Separate and rearrange once.
Chicken Thighs 1 1/2 lbs./675g	10-12 min.	15-30 min.	Separate and rearrange once.
FISH & SEAFOOD Whole Fish 1lb./450g	5-6 min.	15-20 min.	Turn over after half the time. Shield as needed.
Fish Fillets 1 1/2 lb./675g	6-7 min.	15-20 min.	Separate and turn over once.
Shrimp 1/2 lb./225g	2-3 min.	10-15 min.	Separate and rearrange once.

* The times are approximate because freezer temperatures vary.

COOKING & REHEATING CHART

Item	Power Level	Cooking Time Per lb./450g		
MEAT				
Beef				
Standing / rolled Rib - Rare	P-80	7-9 min.		
- Medium	P-80	8-10 min.		
- well done	P-80	10-12 min.		
Ground Beef (to brown for casserole)	P-HI	4-6 min.		
Hamburgers, Fresh or defrosted (4oz. Each/100g) 2 patties	P-HI	2-4 min.		
4 patties	P-HI	3-5 min.		
Pork				
Loin, Leg	P-80	10-13 min.		
Bacon 4 slices	P-HI	2-3 min.		
6 slices	P-HI	3-4 min.		
NOTE: The above times should be regarded only as a guide, Allow for difference in individual tastes and preferences. The times may vary due to the shape, cut, and composition of the meat.				
POULTRY				
Chicken				
Whole	P-HI	6-8 min.		
Breast(boned) portions	P-80	5-7 min.		
	P-80	5-7 min.		
Turkey				
Whole	P-HI	8-10 min.		
NOTE : The above times should be regarded only as a guide. Allow for difference in individual tastes and preferences. The times may vary due to the shape, cut, and composition of the food.				
FRESH FISH				
Item	Power Level	Cooking Time Per lb./450g	Method	Standing Time
Fish Fillets	P-HI	3-5 min.	Add 15-30 ml(1-2 Tbsp)	2-3 min.
Whole Mackerel, Cleaned and Prepared	P-HI	3-5 min.	-	3-4 min.
Whole Trout, Cleaned and Prepared	P-HI	4-6 min.	-	3-4 min.
Salmon Steaks	P-HI	4-6 min.	Add 15-30 ml(1-2 Tbsp)	3-4 min.
ITEM	POWER LEVEL	Cooking Time	Standing Time	
Lasagna 1 serving(10 1/2 oz./300g)	P-HI	4-6 min.	Place lasagna on microwaveable plate. Cover with plastic wrap and vent.	
Casserole 1 cup	P-HI	1 1/2 -3 min.	Cook covered in microwaveable casserole.	
4 cups	P-HI	4-6 min.	Stir once halfway through cooking.	
Mashed potatoes 1 cup	P-HI	2-3 min.	Cook covered in microwaveable casserole.	
4 cups	P-HI	6-8 min.	Stir once halfway through cooking.	
Baked beans 1 cup	P-HI	2-3 min.	Cook covered in microwaveable casserole. Stir once halfway through cooking.	

ITEM	POWER LEVEL	Cooking Time	Standing Time
Ravioli or pasta in sauce 1 cup 4 cups	P-HI P-HI	2-3 min. 6-9 min.	Cook covered in microwaveable casserole. Stir once halfway through cooking.
Sandwich roll or bun 1 roll	P-HI	20-30 sec.	Wrap in paper towel and place on glass microwaveable rack * Note : Do not use recycled paper towels.

VEGETABLE CHART

* Note : Use power level P-HI unless otherwise noted.

VEGETABLES	AMOUNT	TIME	SPECIAL INSTRUCTIONS
Asparagus Fresh spears Frozen spears	1 lb./450g 10-oz./280g package	3-6 min. 3-5 min.	In medium casserole, place 1/4 cup water. In medium casserole.
Beans Fresh green Frozen green Frozen lima	1 lb./450g cut in half 10-oz./280g package 10-oz./280g package	8-13 min. 7-10 min. 5-8 min.	In medium casserole, place 1/2 cup water. In medium casserole, place 2 tbsp water. In medium casserole, place 1/4 cup. Water.
Beets Fresh, whole	1 bunch(1 1/4 -1 1/2 lbs.) /560-680g	10-14 min.	In medium casserole, place 1/2 cup water.
Broccoli Fresh cut Fresh spears Frozen, chopped Frozen spears	1 bunch(1 1/4 -1 1/2 lbs.) /560-680g 1 bunch(1 1/4 -1 1/2 lbs.) /560-680g 10-oz./280g package 10-oz./280g package	4-8 min. 6-9 min. 3-6 min. 3-6 min.	In large casserole, place 1/2 cup water. In large casserole, place 1/2 cup water. In medium casserole. In medium casserole, place 3 tbsp water.
Cabbage Fresh Wedges	1 medium head (about 2 lbs./900g)	5-8 min.	In large casserole, place 1/4 cup water.
Carrots fresh, sliced frozen	1 lb./450g 10-oz./280g package	3-6 min. 3-5 min.	In large casserole, place 1/2 cup water. In medium casserole, place 2 tbsp water.
Cauliflower flowerets fresh, whole frozen	1 medium head (about 2 lbs./900g) 1 medium head (about 2 lbs./900g) 10-oz./280g package	5-9 min. 5-12 min. 2-6 min.	In large casserole, place 1/2 cup water. In large casserole, place 1/2 cup water. In medium casserole, place 2 tbsp water.
Corn frozen kernel	10-oz./280g package	2-6 min.	In medium casserole, place 2 tbsp water.
Corn on the cob fresh frozen	1-5 ears 1 ear	(per ear) 1-4min. 2-5 min.	In large glass baking dish, place corn. If corn is in husk, use no water; if corn has been husked, add 1/4 cup water. Rearrange after half of time. Place in large oblong glass baking dish. Cover with vented plastic wrap. Rearrange after half of time.

VEGETABLES	AMOUNT	TIME	SPECIAL INSTRUCTIONS
Mixed vegetable frozen	10-oz./280g package	2-5 min.	In medium casserole, place 3 tbsp water.
Peas fresh, shelled frozen	1 lbs.(450g) unshelled 10-oz.(280g) package	4-7 min. 2-6 min.	In medium casserole, place 1/4 cup water. In medium casserole, place 2 tbsp water.
Potatoes fresh, cubed, white fresh, whole, sweet or white	4 potatoes (6-8 oz. /160-220g each) 1 (6-8 oz./160-220g)	9-12 min. 2-4 min.	Peel and cut into 1-inch cubes. Place in large casserole with 1/2 cup water. Stir after half of time. Pierce with cooking fork. Place in the oven, 1-inch apart, in circular arrangement. Let stand 5 minutes.
Spinach fresh frozen, chopped, and leaf	10-16 oz./280-450g 10-oz./280g package	3-6 min. 3-6 min.	In large casserole, place washed spinach. In medium casserole, place 3 tbsp water.
Squash fresh, summer, and yellow winter, acorn, or butternut	1 lb./450g sliced. 1-2 squash (about 1 lb./450g each)	3-5 min. 5-9 min.	In large casserole, place 1/4 cup water. Cut in half and remove fibrous membranes. In large glass baking dish, place squash cut-side-down. Turn cut-side-up after 4 minutes.

RECIPES

TOMATO & ORANGE SOUP

1 oz.(25g) butter
 1 medium onion, chopped
 1 large carrot & 1 large potato, chopped
 1³/₄lb(800g) canned, chopped tomatoes
 juice and grated rind of 1 small orange
 1¹/₂pints(900ml) hot vegetable stock
 salt and pepper to taste

1. Melt the in a large bowl on P-HI for 1 minute.
2. Add the onion, carrot and potato and cook on P-HI for 6 minutes. stir halfway through cooking.
3. Add the tomatoes, orange juice, orange rind and stock. Mix thoroughly. Season with salt and pepper to taste. Cover the bowl and cook on P-HI for 13 minutes. stir 2-3 times during cooking, until the vegetables are tender.
4. Blend and serve immediately.

FRENCH ONION SOUP

1 large onions, sliced
 1 tbsp (15ml) corn oil
 2 oz.(50g) plain flour
 2 pints(1.2 liters) hot meat
 or vegetable stock
 salt and pepper to taste
 2 tbsp (30ml) parsley, chopped
 4 thick slices French bread
 2 oz.(50g) cheese, grated

1. Place the onion and oil a bowl, mix well and cook on P-HI for 2 minutes.
2. Stir in the flour to make a paste and gradually add stock. Season and add the parsley.
3. Cover the bowl and cook on P-70 for 15 minutes.
4. Pour the soup into serving bowls, submerge bread and sprinkle generously with cheese.
5. Cook on P-70 for 2 minutes, until the cheese has melted.

STIR FRIED VEGETABLES

1 tbsp(15ml) sunflower oil
 2 tbsp (30ml) soy sauce
 1 tbsp (15ml) sherry
 1"(2.5cm) root ginger,
 peeled and finely grated
 2 medium carrots, cut into fine strips
 4 oz.(100g) button mushrooms,
 chopped
 2 oz.(50g) beansprouts
 4 oz.(100g) mange-tout
 1 red pepper, seeded and thinly sliced
 4 spring onions, chopped
 4 oz.(100g) canned water chestnuts,
 sliced
 1/4 head of chinese leaves, thinly sliced

1. Place the oil, soy sauce, sherry, ginger, garlic and carrots in a large bowl, mix thoroughly
2. Cover and cook on P-HI for 4-5 minutes, stirring once.
3. Add the button mushrooms, beansprouts, mange-tout, red pepper, spring onions, water chestnuts and chinese leaves. Mix thoroughly.
4. Cook on P-HI for 5-6 minutes, until the vegetables are tender. Stir 2-3 times during cooking.

Stir fried vegetables are ideally served with meat or fish.

HONEYED CHICKEN

4 boneless chicken breasts
 2 tbsp(30ml) clear honey
 1 tbsp(15ml) whole grain mustard
 1/2 tsp(2.5ml) dried tarragon
 1 tbsp(15ml) tomato puree
 1/4 pint(150ml) chicken stock

1. Place the chicken breasts in a casserole dish.
2. Mix all remaining ingredients together and pour over the chicken. Salt and pepper to taste.
3. Cook on P-HI for 11-12 minutes. Rearrange and coat the chicken with the sauce twice during cooking.

BLUE CHEESE & CHIVE JACKETS

2 baking potatoes,
(approx.9 oz.(250g) each)
2 oz.(50g) butter
4 oz.(100g) blue cheese, chopped
1 tbsp(15ml) fresh chives, chopped
2 oz.(50g) mushrooms, sliced
salt and pepper to taste

1. Prick each potato in several places. Cook on P-HI for 10-11 minutes. Halve and scoop the flesh into a bowl, add the butter, cheese, chives, mushrooms, salt and pepper, mix thoroughly.
2. Pile mixture into the potato skins and place in a flan dish, on the rack.
3. Cook on P-50 for 10 minutes.

WHITE SAUCE

1 oz.(25g) butter
1 oz.(25g) plain flour
1/2 pint(300ml) milk
salt and pepper to taste

1. Place the butter in a bowl and cook on P-HI for 1 minute, until melted.
2. Stir in the flour and whisk in the milk. Cook on P-HI for 4-5 minutes, stirring every 2 minutes until thick and smooth. Season with salt and pepper to taste.

STRAWBERRY JAM

1 1/2 lb.(675g) strawberries, hulled
3 tbsp(45ml) lemon juice
1 1/2 lb.(675g) caster sugar

1. Place strawberries and lemon juice in a very large bowl, heat on P-HI for 5 minutes, or until the fruit has softened. Add sugar, mix well.
2. Cook on P-70 for 20-25 minutes, until setting point* is reached, stir every 4-5 minutes.
3. Pour into hot, clean jars. Cover, seal and label.

** setting point : To determine setting point, place 1 tsp(5ml) jam onto chilled saucer. Allow to stand for 1 minute. Move surface of jam gently with your finger, if the surface wrinkles setting point has been reached.*

PLAIN MICROWAVE CAKE

4 oz.(100g) margarine
4 oz.(100g) sugar
1 eggs
4 oz.(100g) self raising flour, sifted
2-3 tbsp(30-45ml) milk

1. line the base of 8" (20.4cm) cake dish with grease-proof paper.
2. Cream the margarine and sugar together until light and fluffy. Beat in the eggs and fold in the sifted flour alternately with the milk.
3. Pour into prepared container. Cook on P-HI for 4-5 minutes, until a skewer comes out cleanly.
4. Leave the cake to stand for 5 minutes before turning out.

OMELETTES

1/2 oz.(15g) butter
4 eggs
6 tbsp(90ml) milk
salt & pepper

1. Whisk together eggs and milk. Season.
2. Place butter in 10"(26cm) flan dish. Cook on P-HI for 1 minute, until melted. Coat the dish with the melted butter.
3. Pour omelette mixture into flan dish. Cook on P-HI for 2 minutes. whisk mixture and cook again on P-HI for 1 minutes.



SCRAMBLED EGG

1/2 oz.(15g) butter
2 eggs
2 tbsp(30ml) milk
salt & pepper

1. Melt the butter in a bowl on P-HI for 1 minute.
2. Add the eggs, milk and seasoning and mix well.
3. Cook on P-HI for 3 minutes, stirring every 30 seconds.

SAVORY MINCE

1 small onion, diced
1 clove garlic, crushed
1 tsp(5ml) oil
7 oz.(200g) can chopped tomatoes
1 tbsp(15ml) tomato puree
1 tsp(5ml) mixed herbs
8 oz.(225g) minced beef
salt and pepper

1. Place onion, garlic and oil in casserole, and cook on P-HI for 2 minutes or until soft.
2. Place all other ingredients in casserole. Stir well.
3. Cover and cook on P-HI for 5 minutes then P-50 for 8-12 minutes or until the meat is cooked.

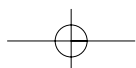



NEC Australia Pty. Ltd.
ABN 86 001 217 527
Home Electronics Group

NEC Service Centres

PH: 131-632

New South Wales

Sydney	184 Milperra Rd, Revesby 2212	(02) 9780 8688
Newcastle	120 Parry Street, Newcastle West 2302	(02) 4926 2466

Victoria

Melbourne	Unit 1/6 Garden Road, Clayton 3168	(03) 8562 6245
-----------	------------------------------------	----------------

Queensland

Brisbane	Unit 4 / 305 Montague Road, WEST END 4101	(07) 3840 5858
Southport	Shop 1, 48 Ferry Road, Southport 4215	(07) 5591 3670

South Adelaide

Adelaide	84A Richmond Rd, Keswick, 5053	(08) 8375 5710
----------	--------------------------------	----------------

Western Australia

Perth	45 Sarich Court, Osborne Park 6017	(08) 9445 5901
-------	------------------------------------	----------------

For Service in outer areas, please contact your NEC retailer for the address of the nearest
 Authorised NEC Service Centre

NEC Australia Pty. Ltd.
Home Electronics Group
244 Beecroft Road EPPING 2121
Tel: 131 632
Fax: (02) 9877 2353

Free Manuals Download Website

<http://myh66.com>

<http://usermanuals.us>

<http://www.somanuals.com>

<http://www.4manuals.cc>

<http://www.manual-lib.com>

<http://www.404manual.com>

<http://www.luxmanual.com>

<http://aubethermostatmanual.com>

Golf course search by state

<http://golfingnear.com>

Email search by domain

<http://emailbydomain.com>

Auto manuals search

<http://auto.somanuals.com>

TV manuals search

<http://tv.somanuals.com>