

## 2 INSTALLATION

This section describes how to set up your MultiSync MT810 LCD projector and how to connect video and audio sources.

### Setting Up Your MultiSync MT810 LCD Projector

Your MultiSync MT810 LCD Projector is simple to set up and use. But before you get started, you must first:

1. Determine the image size
2. Set up a screen or select a non-glossy white wall onto which you can project your image.

**Carrying The LCD Projector** Always carry your LCD projector by the handle. Ensure that the power cord and any other cables connecting to video sources are disconnected before moving the projector. When moving the projector or when it is not in use, cover the lens with the lens cap.

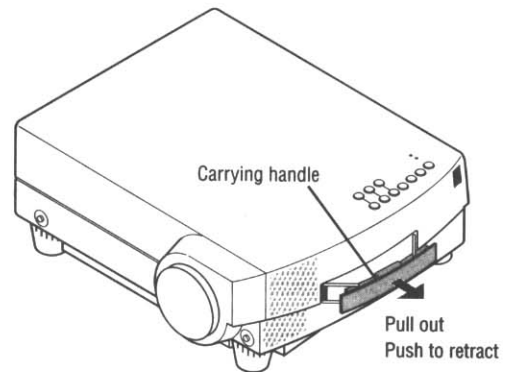

29

**Selecting A Location** The further your LCD projector is from the screen or wall, the larger the image. The minimum size the image can be is approximately 20" (0.5 m) measured diagonally when the projector is roughly 3 feet (1.0 m) from the wall or screen. The largest the image can be is 300" (7.6 m) when the projector is about 40.03 feet (12.2 m) from the wall or screen.

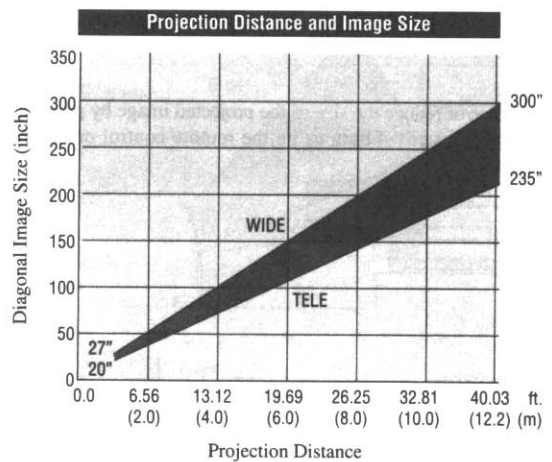
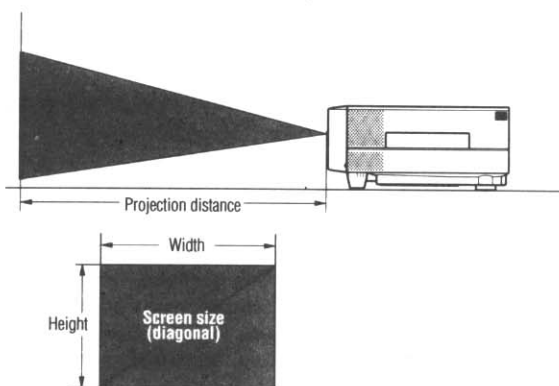

## Using A Tabletop Or Cart

1. Place your LCD projector on a flat level surface at the optimal distance from the screen or wall so you realize the size image you want. (Avoid having bright room lighting or sun light directly on the screen or wall where you'll be projecting the image.)
2. Connect the power cable, remove the lens cap and turn the projector on. (If no input signal is available, the projector will display a background image.)
3. Ensure that the projector is square to the screen.
4. Move the projector left or right to center the image horizontally on the screen. (A)
5. To center the image vertically (B), lift the front edge of the projector and press the buttons on the front of the projector, just above the feet, to release the one-touch tilt feet. (There is approximately 10.5° of up and down adjustment for the front of the projector.)

(A) Top view

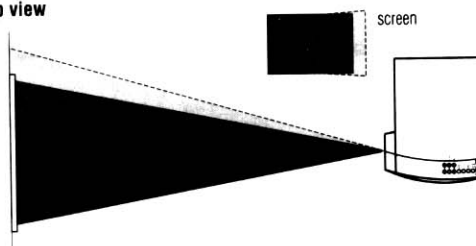

(B) Side view

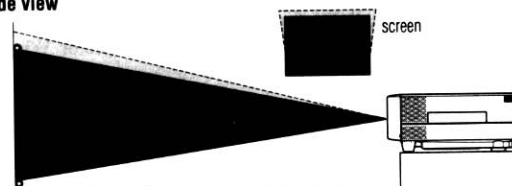

31

6. To fine tune the image's position vertically on the screen, rotate each front foot.
7. Increase or reduce the size of the projected image by pressing the "Zoom" (+) or (-) buttons on the remote control or top of the cabinet.

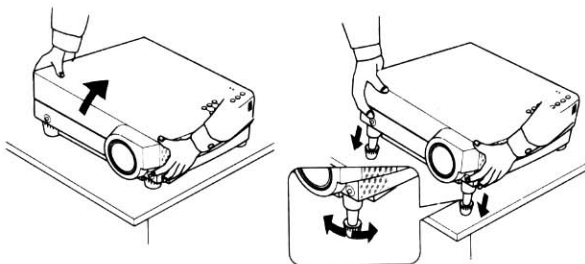

**⚠ WARNING**

- Only use your LCD projector on a solid, level surface. If the projector falls to the ground, you can be injured and the projector severely damaged.
- Do not use the LCD projector where temperatures vary greatly. The projector must be used at temperatures between 32°F (0°C) and 104°F (40°C).
- Do not expose the LCD projector to moisture, dust, or smoke. This will harm the screen image.

- Ensure that you have adequate ventilation around your LCD projector so heat can dissipate. Do not cover the vents on the bottom or the side of the projector.

**Ceiling Installation**

Installing your MultiSync MT810 LCD Projector on the ceiling must be done by a qualified technician. Contact your NEC dealer for more information.

Do not attempt to install the projector yourself.

**NOTE :** Distances may vary ±5%.

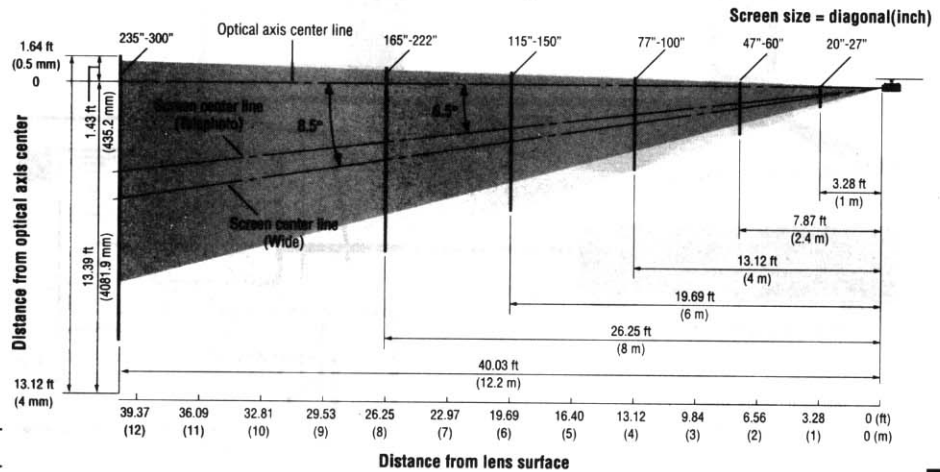

If your projector is mounted on the ceiling and your image is upside down, use the "Menu" and "Select" buttons on your projector cabinet or (▲) (▼) buttons on your remote control to correct the orientation. (See page 60.)

**Reflecting The Image**

Using a mirror to reflect your LCD projector's image enables you to enjoy a much larger image. Contact your NEC dealer if you need a mirror.

If you're using a mirror and your image is inverted, use the "Menu" and "Select" buttons on your projector cabinet or (▲) (▼) buttons on your remote control to correct the orientation. (See page 60.)

**Rear Screen Projection**

You can use your MultiSync MT810 LCD projector to project an image from the rear onto a transparent screen. The distance the projector must be from the screen is the same as if you were projecting the image from the front. Contact your NEC dealer if you need a transparent screen.

If you're projecting the image from the rear and your image is inverted, use the "Menu" and "Select" buttons on your projector cabinet or (▲) (▼) buttons on your remote control to correct the image. (See page 60.)

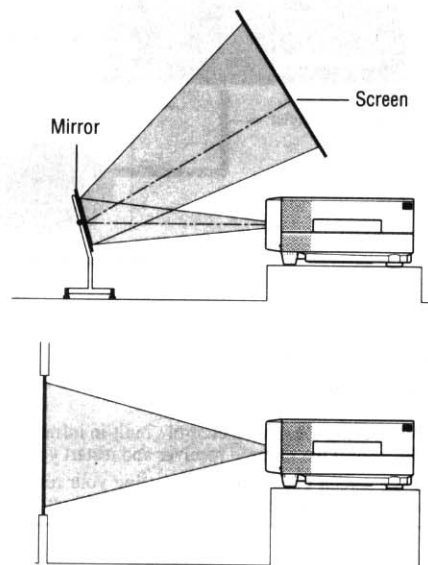

**Wiring Diagram**

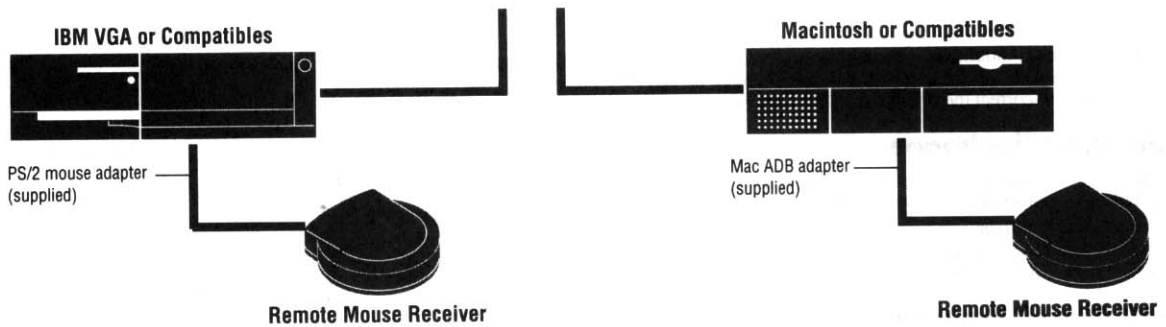
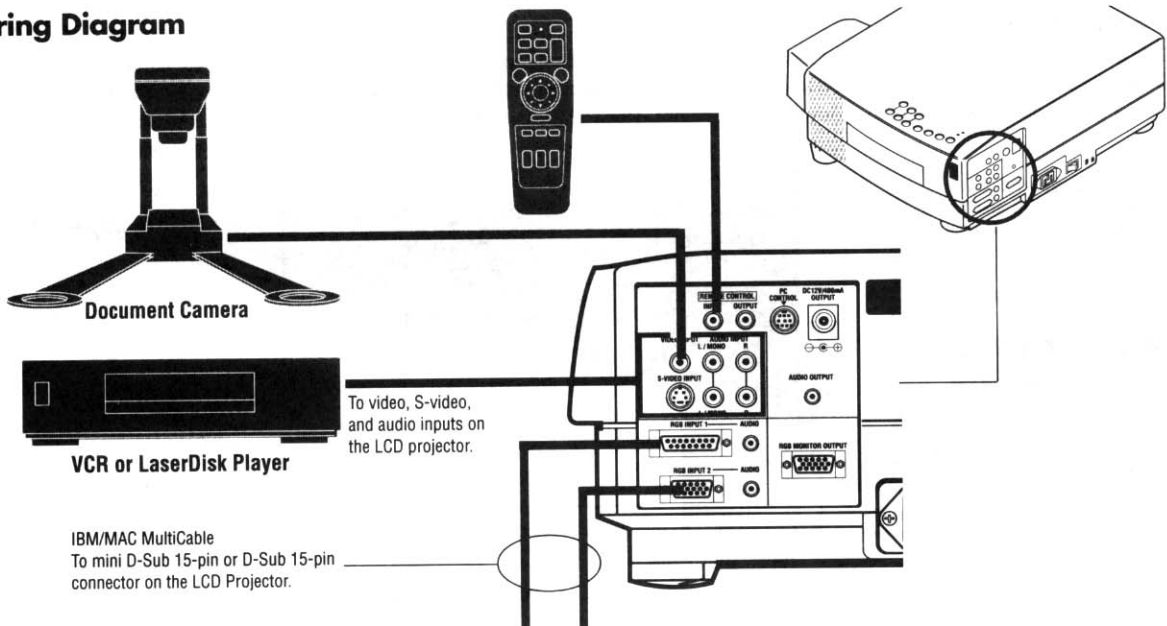

**Remote Control Guideline**

1. Plug the serial cable with the remote mouse receiver into your computer's mouse port and restart your computer to gain remote mouse control.
2. When using the remote control's built-in infrared mouse on a laptop computer, the laptop's mouse, trackball or trackpad will be disabled. Disconnect the infrared receiver and restart your computer to regain trackball or trackpad mouse control.
3. If the screen goes blank while using your remote control, it may be the result of the computer's screen-saver or power management software. If you accidentally hit the OFF button on the remote control, wait one full minute and then press the ON button to resume.

## Connecting Your PC Or Macintosh Computer

Connecting your PC or Macintosh computer to your MultiSync MT810 LCD Projector will enable you to project your computer's screen image for an impressive presentation. All of these following display standards are supported:

VGA 640 × 480 for graphics	VGA 640 × 400 for graphics
VGA 640 × 350 for graphics	VGA 720 × 400 for text
VGA 720 × 350 for text	SVGA 800 × 600
Macintosh at 640 × 480	Macintosh at 832 × 624

To connect to a PC, Macintosh or computer equipped with an SVGA/VGA adapter or compatible graphics adapter, simply:

1. Turn off the power to your LCD projector and computer.
  
2. If your PC does not support SVGA/VGA you will need to install an SVGA/VGA graphics board. Consult your computer's owner's manual for your SVGA/VGA configuration. If you need to install a new board, see the manual that comes with your new graphics board for installation instructions.
  
3. Use the MultiCable that's supplied to connect your PC or Macintosh computer to the LCD projector. For a PC, use the smaller 15-pin connector on the cable to connect to your computer's video port; use the larger 15-pin connector on the cable to connect to the projector's RGB 1 input. For Macintosh, use the larger 15-pin connector on the cable to connect to your computer's video port; use the smaller 15-pin connector on the cable to connect to the projector's RGB 2 input. (You can also use your own video cable if you wish. For a PC cable, use the smaller 15-pin connector RGB 2 on the projector. For a Macintosh cable, use the larger 15-pin connector RGB 1 on the projector.)
  
4. Turn on the LCD projector and the computer.
  
5. If the projector goes blank after a period of inactivity, it may be caused by a screen saver installed on the computer you've connected to the projector.

---

*NOTE: Refer to your computer's owner's manual for more information about your computer's video output requirements and any special identification or configuring your projector's image and monitor may require.*

---

## Changing Video Resolutions

Depending on your computer's graphic capability, you may be able to select one of several resolutions. Generally a computer- either a PC or Macintosh- with 1 meg. of memory will run:

640 × 480 at 16.7 million colors (24 bit Truecolor)

800 × 600 at 65 thousand colors.

1024 × 768 at 256 colors.

As the resolution increases, the number of colors you can run decreases. With 2 meg. of memory a computer will run:

640 × 480 at 16.7 million colors (24 bit Truecolor).

800 × 600 at 16.7 million colors (24 bit Truecolor).

1024 × 768 at 65 thousand colors.

1280 × 1024 at 256 colors.

## Windows 95

There are two methods you can use to change your resolution.

### Method 1

1. Move your cursor to the background image and click.
2. In the "Properties" menu, select "Settings."
3. Change your resolution and click "OK."

## Macintosh

1. Under the Apple menu, select "Control Panels" and open "Monitors."
2. Click and open "Options."
3. Select your new resolution and click "OK."

If you have an NEC monitor connected to your Macintosh, you may have a "DPI-On-The-Fly" extension that enables you to change your resolution directly. The "DPI-On-The-Fly" icon is under your Apple menu.

4. You may be asked to reboot for the changes to take affect, or you'll get a message that "Windows is about to resize your display." You'll be asked if you want to keep your settings. Select "Yes."

### Method 2

1. Click on your "My Computer" icon.
2. Open "Control Panel" and select "Display."
3. Change your resolution and click "OK." after the new resolution is selected.
4. You may be asked to reboot for the changes to take affect, or you'll get a message that "Windows is about to resize your display." You'll be asked if you want to keep your settings. Select "Yes."

## Windows 3.1

1. Click on the "Main" icon and open "Control Panel."
2. Select "Change System Settings" and click on "Option."
3. Choose "Change Display Settings."
4. Select the resolution you want.
5. Choose the current drive or another.
6. Restart Windows for the changes to take affect.

39

## Notebook Computers And Resolution Standards

NEC projectors are designed to project industry standardized video such as VESA (Video Electronics Standards Association) or VGA (Video Graphics Array). Notebook computers do not use industry standards. They use whatever timing is necessary to match their local LCD display. The end result is typically not standards. By turning off your notebook's display, the timing parameters are a bit more like the real VESA or VGA signal.

For an optimal projected image with a notebook computer, it is recommended that you use the CUSTOM 6 memory data. This feature is useful when an SVGA image (800 × 600) is displaying with a notebook computer supported by XGA (1024 × 768). See Source Menu on page 52 for more information.

---

## Connecting Your Document Camera

You can connect your MultiSync MT810 LCD Projector to a document camera. To do so, simply:

1. Turn off the power to your LCD projector and document camera.
2. Use a standard video cable to connect your document camera to the Video input on your projector.
3. Turn on the LCD projector and the document camera.

---

**NOTE:** Refer to your document camera's owner's manual for more information about your camera's video output requirements.

---

## Connecting Your VCR Or Laser Disc Player

Use common RCA cables (not provided) to connect your VCR or laser disc player to your MultiSync MT810 LCD Projector. To make these connections, simply:

1. Turn off the power to your LCD projector and VCR or laser disc player.
2. Connect one end of your RCA cable to the video output connector on the back of your VCR or laser disc player, connect the other end to the Video input on your projector. Use standard RCA audio patch cords to connect the audio from your VCR or laser disc player to your projector (if your VCR or laser disc player has this capability). Be careful to keep your right and left channel connections correct for stereo sound.
3. Turn on the LCD projector and the VCR or laser disc player.

---

**NOTE:** Refer to your VCR or laser disc player owner's manual for more information about your equipment's video output requirements.

---

41

## Connecting An External Monitor

You can connect a separate, external monitor to your LCD projector to simultaneously view on a monitor the image you're projecting. To do so:

1. Turn off the power to your LCD projector and computer, document camera or video source.
2. Use a 15-pin cable to connect your monitor to the RGB MONITOR OUT connector on your LCD projector.
3. Turn on the LCD projector and the computer, document camera or video source.

## Connecting Your Remote Mouse Receiver

The remote mouse receiver enables you to operate your computer's mouse functions from the NEC MultiSync MT810 remote control. It is a great convenience for clicking through your computer-generated presentations.

To connect the remote mouse receiver:

1. Turn off your computer.
2. For PCs: Remove your current mouse and connect the serial cable from the remote mouse receiver to your PC's mouse port. (Use the 6-pin adapter for connecting to a PS/2 computer.)  
For Macintosh: Remove your current mouse from your computer, attach the Macintosh adapter to the remote mouse receiver's serial cable, and connect the receiver to your mouse port.
3. When the remote mouse receiver is installed, it will disable your regular mouse, disconnect the remote mouse receiver and restart your computer.

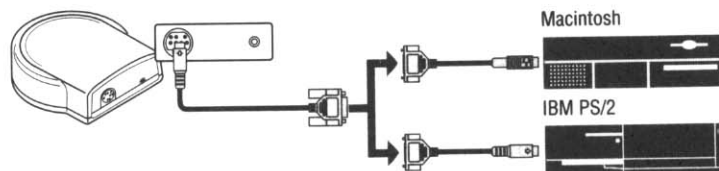
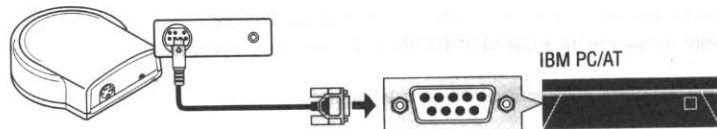



■ The Remote Mouse Receiver as a mouse for your computer

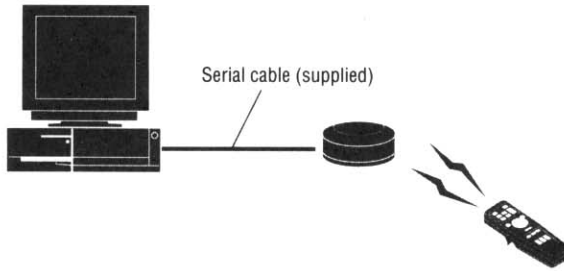

■ The Remote sensors on the projector cabinet work as the remote sensor on the Remote Mouse Receiver

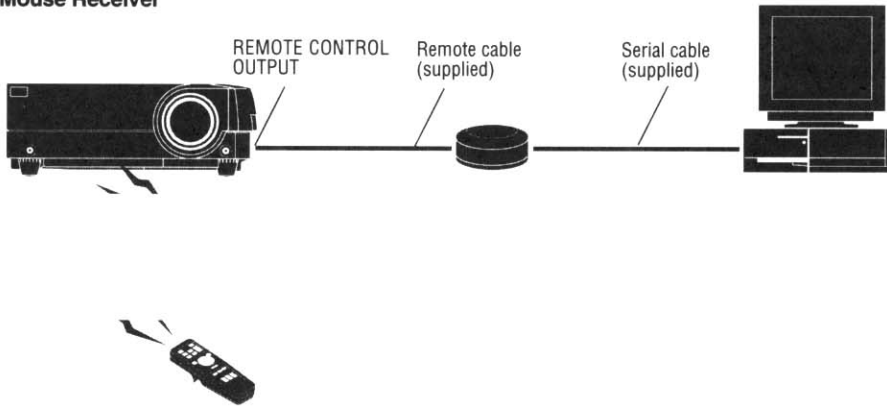

■ You can daisy-chain as many as five LCD projectors and operate them with the same remote control. To do so:

1. Turn off your projectors.
2. Use the remote control cables supplied to connect the Remote Control Output of one projector to the Remote Control Input of the next until all the projectors are connected.

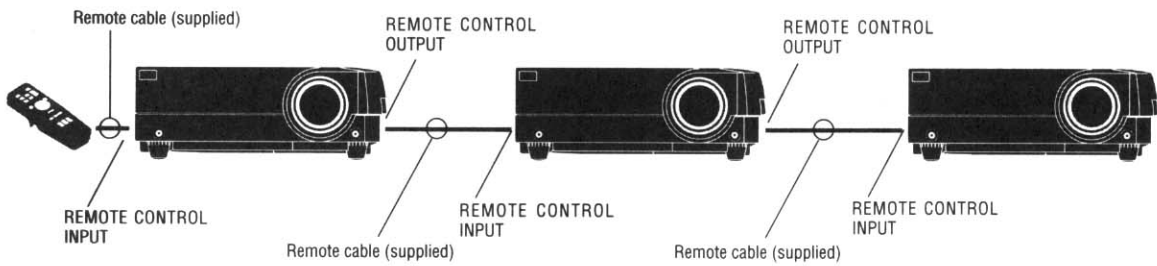

## 3 OPERATION

This section describes how to select a computer or video source and how to adjust the picture and sound.

**General Controls** Before you turn on your MultiSync MT810 LCD Projector, ensure that the computer or video source is turned on and that your lens cap is removed.

1. **Turn On The LCD Projector** The main power switch is on the back panel of the MultiSync MT810 LCD Projector. By turning this switch on, the projector will go into its standby mode and the power light will glow amber. Only after you press the "On" button on the remote control or projector cabinet will the power light turn to green and the projector become ready to use.

---

*NOTE: To turn the LCD projector on and off with just the back panel switch, use the menu and enable the "auto start" feature. (See page 57. )*

---

2. **Select The Computer Or Video Source** Press the "Video" (VCR, document camera, or laser disc player), "S-video", "RGB 1" or "RGB 2" (computer) button on the remote control to display the image. Or press the "Menu" button on the cabinet and use the icons to select your video source: "Video", "S-Video", "RGB 1" or "RGB 2."

47

3. **Adjust The Image Size** Press the "Zoom" button (+) or (-) on the remote control or projector cabinet to make the image larger or smaller.
4. **Focus** Press the "Focus" button (+) or (-) on the remote control or projector cabinet to focus the image.
5. **Turning Off The Projector** First press the "off" button on the remote control or the projector cabinet. The power light will glow amber. Then turn off the main power switch on the back panel. The power light will go out.

### IMPORTANT:

- The LCD projector should be unplugged if it will not to be used for an extended period.
- Turn off the image briefly (five minutes or less), use the "Picture Mute" button instead of turning the projector off and on.
- The LCD projector will display a black, blue, or loop image if no RGB input signal is present. (Not work with video or S-video sources)
- Do not turn the LCD projector off and then immediately back on. The projector needs to cool for a minute before it can be restarted.

## Using The Menus

1. Press the "Menu" button on the remote control or projector cabinet to display the Main Menu.
2. Press the "Select" button on the projector cabinet or (▲) (▼) buttons on your remote control to highlight the menu for the item you want to adjust.
3. Press the "Enter" button on the projector cabinet or the "Left Click" button on the remote control to select a submenu or item.
4. Adjust the level or turn the selected item on or off by using the "Adjust" (+) or (-) buttons on the remote control or cabinet. The on-screen gauge will show you the amount of increase or decrease. [The (+) button is "on" and (-) is "off".]
5. The change is stored until you adjust it again.
6. Repeat steps 2-5 to adjust an additional item, or press "Menu" on your remote control or cabinet to quit the menu display.

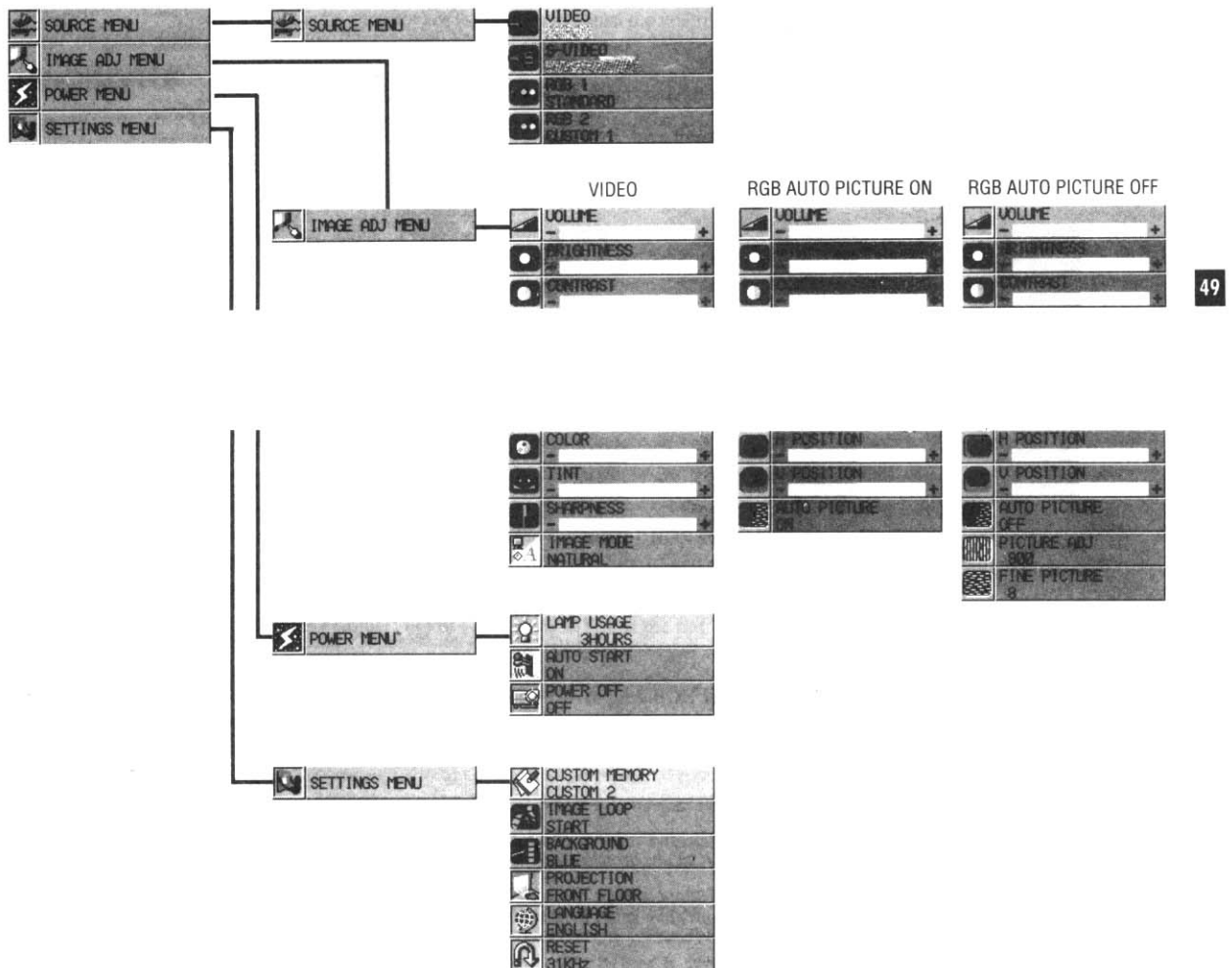

## Menu Descriptions & Functions

### Source Menu



Enables you to select a video source such as a VCR, laser disk player, computer or document camera depending on what is connected to your inputs. Press the "Select" button on the projector cabinet or (▲) (▼) buttons on your remote control to highlight the menu for the item you want to adjust

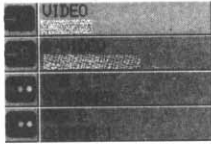

### Video

Selects what is connected to your Video input-VCR, laser disk player or document camera.

### S-Video

Selects what is connected to your S-Video input-VCR, or laser disk player.

### RGB 1

Selects what is connected to your RGB 1 input — a computer. Use the "Adjust" (+) or (-) buttons to select a standard\* or one of six\*\* custom settings you can create. Press the "Enter" button on the cabinet or the "Left Click" button on the remote control to save your selection.

### RGB 2

Selects what is connected to your RGB 2 input — a computer. Use the "Adjust" (+) or (-) buttons to select a standard\* or one of six\*\* custom settings you can create. Press the "Enter" button on the cabinet or the "Left Click" button on the remote control to save your selection.

---

#### NOTE:

\* Standard is normally used and it can be user changed and automatically recalled.

\*\* "Custom 6" is read only. This feature is useful when an SVGA image (800×600) is displayed with a notebook computer supported by XGA (1024×768).

---

**Image Adjustment Menu**



Provides access to controls for your image and sound. Use the "Select" button on the projector cabinet or (▲) (▼) buttons on your remote control to highlight the menu for the item you want to adjust.

The volume, brightness, contrast, color, tint, and sharpness controls are available for Video or S-Video sources.

The volume, brightness, contrast, horizontal position, vertical position and auto picture controls are available for RGB 1 or RGB 2 sources.

When the RGB 1 or RGB 2 source is selected, the volume, brightness, contrast, horizontal position, vertical position, and auto picture are available.



**Volume**

Use the "Adjust" (+) or (-) buttons to adjust the volume.

**Brightness**

Use the "Adjust" (+) or (-) buttons to adjust the brightness.

**Contrast**

Use the "Adjust" (+) or (-) buttons to adjust the contrast.

**Color\***

Use the "Adjust" (+) or (-) buttons to adjust the color.

**Tint\***

Use the "Adjust" (+) or (-) buttons to adjust the tint.

**Sharpness\***

Use the "Adjust" (+) or (-) buttons to adjust the sharpness.

**Image Mode\***

Use the "Adjust" (+) or (-) buttons to choose "Normal" for a regular picture "Natural" for true color reproduction, or "Document Camera" for a document camera or other low APL picture.

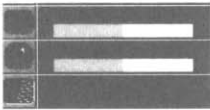

**Horizontal Position\*\***

Use the “Adjust” (+) button to move the image right; (-) to move it left.



**Vertical Position\*\***

Use the “Adjust” (+) button to move the image up; (-) to move it down.

**Auto Picture\*\***

Use the “Adjust” (+) button to turn this feature on so “Picture” and “Fine Picture” adjustments are made automatically. Use the “Adjust” (-) button to turn this feature off so you can make “Picture and Fine Picture” adjustments manually.

**Picture Adjustment \*\* (when AUTO PICTURE is off)**

Use this icon with the “Fine Picture Adjustment” to fine tune the computer image or to remove any vertical banding that might appear. This function adjusts the clock frequencies that eliminate the horizontal banding in the image. Press the “Adjust” (+) and (-) buttons until the banding disappears. This adjustment may be necessary when you connect your computer for the first time. This adjustment is made automatically when the Auto Picture is turned on.

**Fine Picture \*\* (when AUTO PICTURE is off)**

Use this icon to adjust the clock phase or to reduce video noise, dot interference or cross talk. (This is evident when part of your image appears to be shimmering.) Use the “Adjust” (+) and (-) buttons to adjust the image. Use the Fine Adjustment only after the Picture Adjustment is complete. This adjustment is made automatically when the Auto Picture is turned on. Press “Enter” on the cabinet or the “Left Click” on your remote control to save the new setting.

**NOTE:**

- \* Color, Tint and Sharpness controls will not work with an RGB source. The Tint control will not work with a PAL or SECAM source.
- \*\* Horizontal and Vertical position controls, and Picture, Fine Picture and Auto Picture adjustments will not work with a Video or S-Video source.

**Power Menu**



Provides access to Lamp Usage information and the Auto Start and Power Management features. Use the “Select” button on the projector cabinet or (▲) (▼) buttons on your remote control to access a submenu. Then press “Adjust” (+) or (–) to choose a specific option.



**Lamp Usage**

This tells you how long the lamp has been in operation. It is recommended that you replace a lamp after 2000 hours of service. After you install a new lamp, select this icon and press and hold the “Power On” button on the remote control for ten seconds to reset the lamp clock back to zero.

---

*NOTE: The projector will turn off and go into stand by mode after 2100 hours of service. If this happens, press the “Power Off” button on the remote control for ten seconds to reset the lamp clock back to zero. Do this only after replacing the lamp.*

---

**Auto Start**

Turns the LCD projector on automatically when the main power switch is turned on. This eliminates the need to always use the “Power” button on the remote control or projector cabinet. Press (+) to turn this feature on and (–) to turn it off.

**Power Management**

When “Power Off” is on and there is no RGB video input for five minutes or more, the projector will automatically turn itself off. Press the (+) to turn this feature on and (–) to turn it off. This feature does not work with Video or S-Video sources.

## Settings Menu

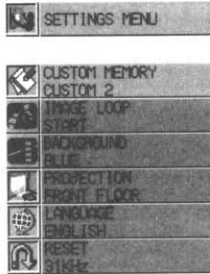

Enables you to set preferences and other operating options. Use the "Select" button on the projector cabinet or (▲) (▼) buttons on your remote control to access the submenu you want.

### Custom Memory

This enables you to save your current settings for an RGB source in one of five memories, Custom 1-5.

To use this feature:

1. Connect your computer to the MultSync MT810.
2. Select the "STANDARD" in RGB 1 or RGB 2 source.
3. Adjust the horizontal/vertical position, Picture, and Fine adjustments.
4. Select the Custom Memory icon.
5. Press the "Adjust" (+) or (-) buttons to choose a memory location, then press "Enter" on the cabinet or the "Left Click" on your remote control to save the new settings.

### Image Loop

This feature enables you to "capture" an image from a source that is currently being displayed. Up to 8 images can be stored.

Press the "Adjust" (+) or (-) buttons to select "Start" for the image you want to loop and "Capture" for the image you want to capture or to select "Delete" and delete all captured images from memory. Press "Enter" on the cabinet or the "Left Click" on your remote control to save your image loop

changes. To stop an image loop, switch to another input with the "Video", "S-Video", "RGB1" or "RGB2" button, or using the Source menu.

### Background

Use this feature to display a black or blue screen or to start an image loop when no input signal is available.

Press the "Adjust" (+) or (-) buttons to choose the back screen you want — blue, black or an image loop. Press "Enter" on the cabinet or the "Left Click" on your remote control to save your change.

### Projection

This reorients your image for your type of projection. Press the "Adjust" (+) or (-) button until it is correct. The options are: front floor projection, rear ceiling projection, rear floor projection, and front ceiling projection.

Press "Enter" on the cabinet or the "Left Click" on your remote control to save the new setting.

### Language

Use the "Adjust" (+) or (-) to choose one of six languages for on-screen instructions. The options are: English, German, French, Italian, Spanish and Swedish.

Press "Enter" on the cabinet or the "Left Click" on your remote control to save the new setting.

### Reset

Changes all adjustments to the factory preset levels for each source individually. To activate, you must hold down the "Adjust" (+) button on the cabinet or remote control for at least two seconds. The adjustments that will be reset are horizontal and vertical control (for the current source only), picture and fine picture adjustment, brightness, contrast, color, tint, and sharpness.



## 4 MAINTENANCE

This section describes the simple maintenance procedures you should follow to replace the lamp, clean or replace the filter, and replace the batteries in the remote control.

### Replacing The Lamp

After your lamp has been operating for 2000 hours or longer, the "status" light in the cabinet will go on. Even though the lamp may still be working, replace it at 2000 hours to maintain optimal projector performance.

**CAUTION**

- DO NOT TOUCH THE LAMP immediately after it has been used. It will be extremely hot. Allow at least one hour for the lamp to cool before handling.
- DO NOT REMOVE ANY SCREWS except the lamp cover set screw and two lamp case screws. You could receive an electric shock.
- Turn off the main power to the projector and disconnect the power cord. Allow at least one hour for the lamp to cool.
- The projector will turn off and go into stand by mode after 2100 hours of service. If this happens, be sure to replace the lamp. If you continue to use the lamp after 2000 hours of use, the lamp bulb may shatter, and pieces of glass may be scattered in the lamp case. Do not touch them as the pieces of glass may cause injury. If this happens, contact your NEC dealer for lamp replacement.

**To replace the lamp:**

1. Remove the single screw that secures the lamp housing cover and remove the cover.
2. Remove the two screws securing the lamp case. (There is an interlock on this case to prevent the risk of electrical shock. Do not attempt to circumvent this interlock.)
3. Remove the lamp by pulling out the complete assembly.
4. Install a new lamp case assembly and secure it in place with the two screws.

**CAUTION:** Do not use a lamp other than the NEC replacement lamp. Order this from your NEC dealer using your projector's model number.

5. Reattach the lamp cover and reinstall the single screw.
6. After you install a new lamp, select the lamp Usage icon and press and hold the "Power On" button on the remote control for ten seconds to reset the lamp time clock to zero.

*NOTE: If resetting the lamp clock back to zero after 2100 hours of service, press the "Power Off" (not "Power On") button on the remote control for ten seconds.*

*NOTE: When you replace the lamp, it is also wise to replace the filter. The filter comes in the same package with your replacement lamp.*

**CAUTION:** Do not put the LCD projector on end except to replace the air filter.

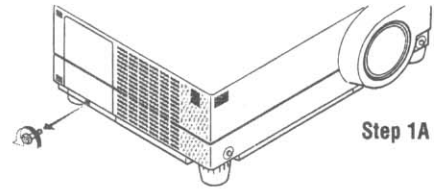

Step 1A

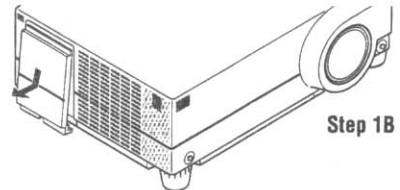

Step 1B

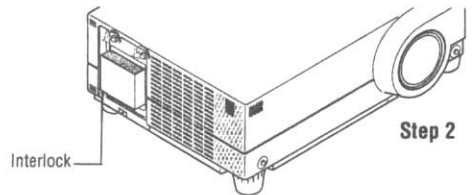

Step 2

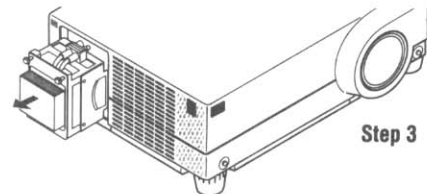

Step 3

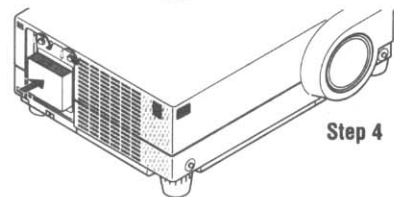

Step 4

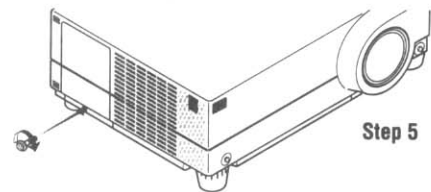

Step 5

## Cleaning Or Replacing The Filter

The air-filter sponge keeps the inside of the MultiSync MT810 LCD Projector free from dust or dirt and should be cleaned after every 100 hours of operation (more often in dusty conditions). If the filter is dirty or clogged, your projector may overheat.

**NOTE:** Clean your filter after every 100 hours of operation.

### CAUTION

- Turn off the LCD projector and wait for the fan to stop. Turn off the main power and unplug the projector before replacing the filter.
- Only clean the outside of the filter cover with a vacuum cleaner.
- Do not attempt to operate the projector without a filter.
- Your LCD projector will not operate unless the filter is installed correctly.
- Do not put the LCD projector on end except to replace the filter.

To clean the air-filter:

1. Turn over the projector. Put the LCD projector on end so that the bottom is visible.
2. Vacuum the filter through the filter cover.
3. Place the projector back in a horizontal position.

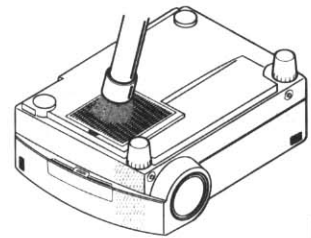

63

To replace the air-filter:

1. Remove the filter panel by pushing up on the catch of the cover with a flat-head screwdriver until you feel it detach.
2. Remove the filter and replace it.
3. Reinstall the filter panel.

**NOTE:** Do not detach the sponge from the filter cover. Do not wash the filter with soap and water. Soap and water will damage the filter membrane. Before replacing the air-filter, remove dust and dirt from the projector cabinet. Keep out dust and dirt during filter replacement.

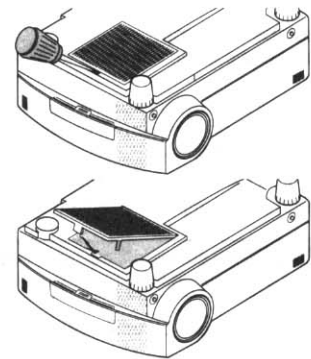

## Remote Control Battery Installation

1. Press firmly and slide the battery cover off.
2. Remove both old batteries and install new ones (AA). Ensure that you have the batteries' polarity (+/-) aligned correctly.
3. Slip the cover back over the batteries until it snaps into place.

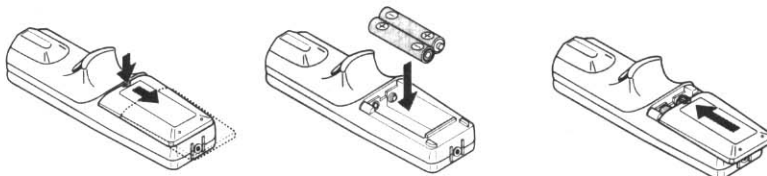

MAINTENANCE

64

Cette section décrit les procédures simples d'entretien que vous aurez à suivre pour remplacer la lampe, nettoyer ou remplacer le filtre et remplacer les piles de la télécommande.

## Remplacement de la lampe

Lorsque la lampe a été utilisée pendant 2000 heures ou plus, le voyant "Status" (état) du coffret s'allume. Même si la lampe peut encore fonctionner, remplacez-la au bout de 2000 heures pour conserver une performance optimale de votre projecteur.

### ⚠ PRECAUTION

- NE TOUCHEZ PAS A LA LAMPE juste après qu'elle a été utilisée. Elle est très chaude. Laissez-la refroidir pendant au moins une heure avant de la manipuler.
- NE RETIREZ AUCUNE VIS mis à part la vis qui fixe le couvercle de lampe et les deux vis du compartiment de lampe. Vous risquez de recevoir une décharge électrique.
- Mettez le projecteur hors circuit et débranchez le cordon d'alimentation. Laissez refroidir la lampe pendant au moins une heure.
- Le projecteur s'éteindra et restera en attente après 2100 heures d'utilisation. Dans ce cas, remplacez la lampe. Si vous continuez d'utiliser la lampe après 2000 heures d'utilisation, l'ampoule peut se briser et des brisures de verre peuvent être éparpillées dans le compartiment de la lampe. Ne les touchez pas car elles peuvent vous blesser. Dans ce cas, contactez votre revendeur NEC afin de procéder au remplacement de la lampe.

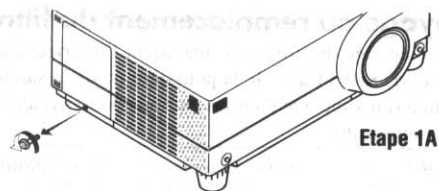

Etape 1A

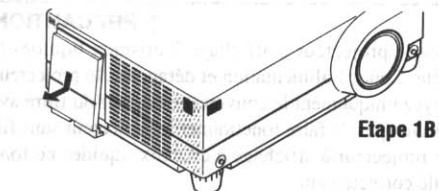

Etape 1B

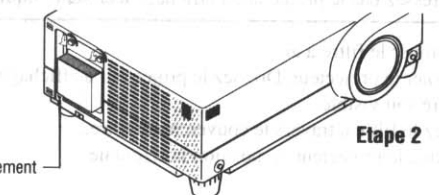

Etape 2

Enclenchement

65

### Pour remplacer la lampe :

1. Retirer l'unique vis qui fixe le couvercle de lampe et retirez le couvercle.
2. Retirez les deux vis qui fixent le compartiment de lampe. (Afin de prévenir contre un risque de décharge électrique, il y a un enclenchement sur ce compartiment. Ne tentez pas de détourner cet enclenchement.)
3. Retirez la lampe en tirant tout l'assemblage.
4. Installez un nouvel assemblage de compartiment lampe et fixez-le avec les deux vis.

⚠ **PRECAUTION:** N'utilisez pas d'autres lampes qu'une lampe de rechange NEC. Commandez-la auprès de votre vendeur NEC en donnant le numéro de modèle du projecteur.

5. Fixez de nouveau le couvercle de lampe et remplacez la vis unique.
6. Une fois la nouvelle lampe installée, sélectionnez l'icône d'utilisation de lampe et appuyez et maintenez la touche "Power On" (alimentation activée) de la télécommande pendant dix secondes afin de remettre à zéro l'horloge de lampe.

**REMARQUE :** Pour remettre à zéro l'horloge de lampe après 2100 heures d'utilisation, appuyez sur la touche "Power Off" (alimentation désactivée) (et non "Power On" (alimentation activée)) de la télécommande pendant dix secondes.

**REMARQUE:** Lorsque vous remplacez la lampe, il est recommandé de changer également le filtre. Le filtre se trouve dans le même emballage que la lampe de rechange.

⚠ **PRECAUTION:** Ne dressez pas le projecteur debout sauf pour changer le filtre à air.

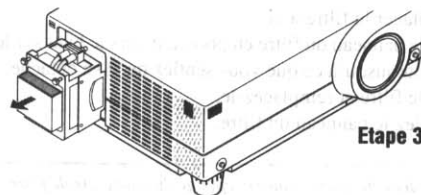

Etape 3

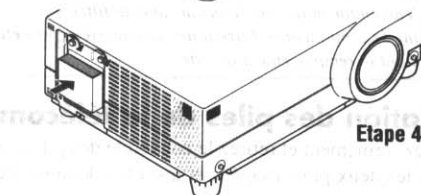

Etape 4

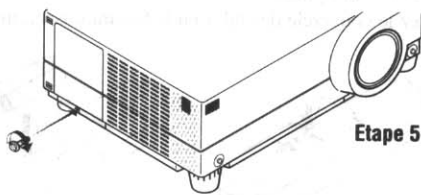

Etape 5

## Nettoyage ou remplacement du filtre

Le coussin éponge du filtre à air maintient l'intérieur du projecteur à affichage à cristaux liquides MultiSync MT810 à l'abri de la poussière ou de la saleté et doit être nettoyé toutes les 100 heures d'utilisation (plus souvent dans les endroits poussiéreux). Si le filtre est sale ou bouché, le projecteur risque de surchauffer.

**REMARQUE:** Nettoyez le filtre toutes les 100 heures d'utilisation.

### ⚠ PRECAUTION

- Mettez le projecteur à affichage à cristaux liquides hors circuit et attendez que le ventilateur s'arrête. Coupez l'alimentation et débranchez le projecteur avant de remplacer le filtre.
- Nettoyez uniquement le couvercle extérieur du filtre avec un aspirateur.
- N'essayez pas de faire fonctionner le projecteur sans filtre.
- Votre projecteur à affichage à cristaux liquides ne fonctionnera pas tant que le filtre ne sera pas installé correctement.
- Ne dressez pas le projecteur à affichage à cristaux liquides debout sauf pour remplacer le filtre.

Pour nettoyer le filtre à air :

1. Retourner le projecteur. Dressez le projecteur à affichage à cristaux liquides debout de façon à ce que l'arrière soit visible.
2. Aspirez le filtre à travers le couvercle de filtre.
3. Remettez le projecteur en position horizontale.

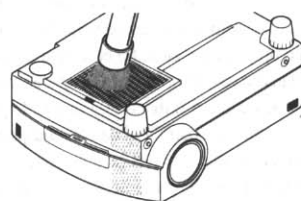

67

Pour remplacer le filtre à air :

1. Retirez le panneau du filtre en poussant vers le haut sur le cliquet du couvercle à l'aide d'un tournevis à tête plate jusqu'à ce que vous sentiez qu'il se détache.
2. Retirez le filtre et remplacez-le.
3. Réinstallez le panneau du filtre.

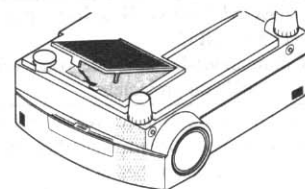
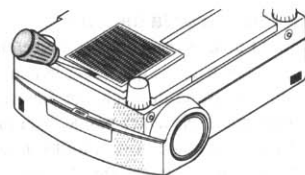

**NOTE:** Ne détachez pas le coussin éponge du couvercle de filtre. Ne lavez pas le filtre au savon et à l'eau. Le savon et l'eau endommageront la membrane du filtre.

Avant de remplacer le filtre à air, dépoussiérez et nettoyez le coffret du projecteur. Maintenez propre pendant le remplacement du filtre.

## Installation des piles de la télécommande

1. Appuyez fermement et retirez le couvercle des piles en le faisant glisser.
2. Retirez les deux piles usagées et installez de nouvelles piles (AA). Assurez-vous de respecter la polarité (+/-) des piles.
3. Remettez le couvercle des piles en le faisant glisser, jusqu'à ce qu'il s'emboîte.

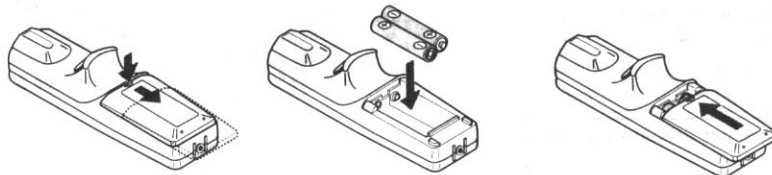

MAINTENANCE

68

## Free Manuals Download Website

<http://myh66.com>

<http://usermanuals.us>

<http://www.somanuals.com>

<http://www.4manuals.cc>

<http://www.manual-lib.com>

<http://www.404manual.com>

<http://www.luxmanual.com>

<http://aubethermostatmanual.com>

Golf course search by state

<http://golfingnear.com>

Email search by domain

<http://emailbydomain.com>

Auto manuals search

<http://auto.somanuals.com>

TV manuals search

<http://tv.somanuals.com>