

NETGEAR

Installation Guide

Connect with Innovation™

ProSafe Plus 8-Port Gigabit Switch with 4-Port PoE GS108PE



Step 1. Connect equipment

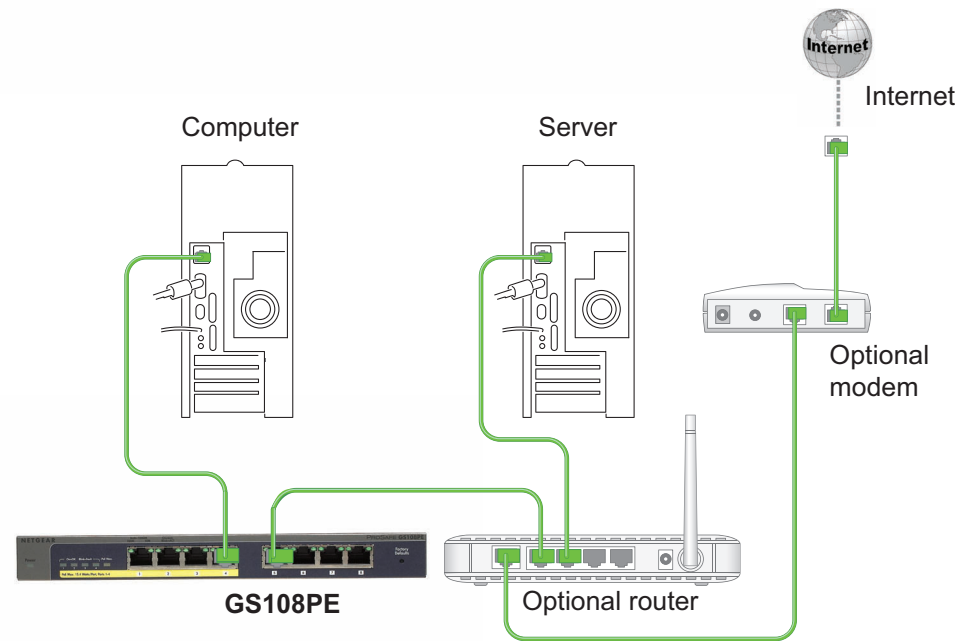



Step 2. Connect power





Step 3. Check status







Power LED

-  On
-  Off





PoE Max. LED

-  Less than 7W of PoE power is available
-  PoE MAX LED was active in the previous 2 minutes (blinking)
-  PoE ports are working normally (off)

PoE LEDs

-  PoE in use
-  PoE not provided (slow blinking)
-  PoE halted (fast blinking)
-  No PoE use (off)

Port LEDs

-  1000 Mbps link (both LEDs)
-  100 Mbps link (left LED)
-  10 Mbps link (right LED)
-  Activity (blinking)
-  No link (off)

Set up the Switch Configuration Utility

Plus switches are plug and play. You can install a configuration utility to select additional options to manage and customize the switch for your network. This utility is on the resource CD that was shipped with the switch.

Note: The configuration utility is installed on your computer and is only supported on Windows.

Install the configuration utility:

1. Insert the resource CD into a computer that is connected to the switch.
2. Click **Install ProSafe Plus Utility** and follow the prompts to install the program. The switch configuration utility is installed in the program directory of your computer and a **ProSafe Plus Utility** icon is placed on your desktop.

Configure the switch:

1. Double-click the **ProSafe Plus Utility** icon. The configuration home screen displays a list of plus switches that it discovers on the local network.
2. Select the switch that you want to configure. You are asked to enter the password for the switch.
3. Enter the switch's password in the password field. The switch's default password is password.
4. Use the utility to configure the switch. For a description of plus features, see the *ProSafe Plus Switch Configuration Utility User Guide*. You can access the user guide through links on the Help tab of the utility or on the resource CD.

Specifications

Specification	Description
Network interface	RJ-45 connector for 10BASE-T, 100BASE-TX, or 1000BASE-T
Network cable	Category 5e (Cat 5e) or better Ethernet cable
Ports	8
Power adapter	48V @ 1.25A DC input
Power consumption	60W max
PoE power budget	45W max. all PoE ports (1-4), 15.4 W max. per PoE port
Weight	0.624 Kg (1.37 lbs)
Dimensions (W x D x H)	235 mm x103 mm x 27 mm 9.25 in. x 4.06 in. x 1.06 in.
Operating temperature	0–50° C (32–122° F)
Operating humidity	10%–90% relative humidity, noncondensing
Electromagnetic compliance	CE Class A, FCC 15 Class A, VCCI Class A, C-Tick Class A, CCC
Safety agency approvals	CE mark, CB, CCC

Technical Support

After installing your device, locate the serial number on the label of your product and use it to register your product at <https://my.netgear.com>.

You must register your product before you can use NETGEAR telephone support. NETGEAR recommends registering your product through the NETGEAR web site. For product updates and web support, visit <http://support.netgear.com>.



201-16461-01



September 2012

For the complete EU Declaration of Conformity, visit http://support.netgear.com/app/answers/detail/a_id/11621/.

Statement of Conditions: In the interest of improving internal design, operational function, and/or reliability, NETGEAR reserves the right to make changes to the products described in this document without notice. NETGEAR does not assume any liability that may occur due to the use or application of the product(s) or circuit layout(s) described herein.



This symbol was placed in accordance with the European Union Directive 2002/96 on the Waste Electrical and Electronic Equipment (the WEEE Directive). If disposed of within the European Union, this product should be treated and recycled in accordance with the laws of your jurisdiction implementing the WEEE Directive.

NETGEAR, the NETGEAR logo, and Connect with Innovation are trademarks and/or registered trademarks of NETGEAR, Inc. and/or its subsidiaries in the United States and/or other countries. Information is subject to change without notice. Other brand and product names are registered trademarks or trademarks of their respective holders. © NETGEAR, Inc. All rights reserved.

For indoor use only in all EU countries and Switzerland.

Free Manuals Download Website

<http://myh66.com>

<http://usermanuals.us>

<http://www.somanuals.com>

<http://www.4manuals.cc>

<http://www.manual-lib.com>

<http://www.404manual.com>

<http://www.luxmanual.com>

<http://aubethermostatmanual.com>

Golf course search by state

<http://golfingnear.com>

Email search by domain

<http://emailbydomain.com>

Auto manuals search

<http://auto.somanuals.com>

TV manuals search

<http://tv.somanuals.com>