



E v o l u t i o n

O w n e r ' s

M a n u a l

&

S e t u p

G u i d e

IMPORTANT SAFETY INSTRUCTIONS



CAUTION

RISK OF ELECTRIC SHOCK
DO NOT OPEN



CAUTION: TO REDUCE RISK OF ELECTRICAL SHOCK, DO NOT REMOVE COVER (OR BACK). NO USER SERVICEABLE PARTS INSIDE. REFER TO QUALIFIED SERVICE PERSONNEL.



The lightning flash with the arrowhead symbol, within an equilateral triangle, is intended to alert the user to the presence of uninsulated "dangerous voltage" within the product's enclosure that may be of sufficient magnitude to constitute a risk of electric shock to persons.



The exclamation point within an equilateral triangle is intended to alert the user to the presence of important operating and maintenance (servicing) instructions in the literature accompanying the appliance.

WARNING: TO REDUCE THE RISK OF FIRE OR ELECTRIC SHOCK, DO NOT EXPOSE THIS APPLIANCE TO RAIN OR MOISTURE. THE APPARATUS SHALL NOT BE EXPOSED TO DRIPPING OR SPLASHING AND THAT NO OBJECTS FILLED WITH LIQUIDS, SUCH AS VASES, SHALL BE PLACED ON THE APPARATUS

1. **READ INSTRUCTIONS** - All safety and operating instructions should be read before the appliance is operated.
2. **RETAIN INSTRUCTIONS** - Safety and operating instructions should be retained for future reference.
3. **HEED WARNINGS** - All warnings on the appliance and in operating instructions should be adhered to.
4. **FOLLOW INSTRUCTIONS** - All operating and use instructions should be followed.
5. **WATER AND MOISTURE** - The appliance should not be used near water - near bathtub, washbowl, kitchen sink, laundry tub; in a wet basement near a swimming pool, etc.
6. **CARTS AND STANDS** - Do not place this product on an unstable cart, stand, tripod, bracket, or table. The appliance should be used only with a cart or stand that is recommended by the manufacturer.
7. **VENTILATION** - The appliance should be situated so that its location and position do not interfere with proper ventilation. The appliance should not be situated on a bed, sofa, rug, or any surface that may obstruct cabinet openings.
8. **HEAT** - The appliance should be situated away from heat sources such as radiators, heat registers, stoves, or other devices (including amplifiers) that produce heat.
9. **POWER SOURCES** - This product should be operated only from the type of power source indicated on the marking label. If you are not sure of the type power supply in your home, consult your product dealer or local power company. For products intended to operate from battery power or other sources, refer to the operating instructions.
10. **POWER CORD PROTECTION** - Power supply cords should be routed so that they are not likely to be walked upon or pinched by items placed upon or against them, paying attention to cords and plugs, convenience receptacles, and the point where they exit from the appliance.
11. **POLARIZED PLUG** - This appliance is equipped with a polarized line plug (a plug having one blade wider than the other). This plug will fit into the power outlet only one way. This is a safety feature. If you are unable to insert the plug fully into the outlet, try reversing the plug. If the plug still fails to fit, contact your electrician to replace your obsolete outlet. Do not attempt to defeat this safety feature.
12. **LIGHTNING** - For added protection for this product during a lightning storm, or when it is left unattended and unused for long periods of time, unplug it from the wall outlet and disconnect the antenna or cable system. This will prevent damage to the product due to lightning and power line surges.
13. **OVERLOADING** - Do not overload wall outlets, extension cords, or integral convenience receptacles, as this can result in a risk of fire or electric shock.
14. **CLEANING** - Unplug this product from the wall outlet before cleaning. Do not use liquid cleaners or aerosol cleaners. Use a damp cloth for cleaning.
15. **NON-USE PERIODS** - This amplifier should be unplugged from the outlet when the appliance is left unused for a long period of time.
16. **OBJECT AND LIQUID ENTRY** - Never push objects of any kind into this product through openings, as they may touch dangerous voltage points or short-out parts that could result in a fire or electric shock. Never spill liquid of any kind on this product.
17. **DAMAGE REQUIRING SERVICE** - The appliance should be serviced by qualified personnel when:
 - a. The power supply cord or plug has been damaged; or
 - b. Objects have fallen on or liquid has been spilled into the appliance; or
 - c. The appliance has been exposed to rain; or
 - d. The appliance does not appear to operate normally or exhibits a marked change in performance; or
 - e. The appliance has been dropped or the enclosure is damaged.
18. **SERVICING** - Do not attempt to service this product yourself, as opening or removing covers may expose you to dangerous voltage or other hazards. Refer all servicing to qualified service personnel. For service warranty information call the NHT Hotline number: 1-800-NHT-9993.
19. **REPLACEMENT PARTS** - When replacement parts are required, be sure the service technician has used replacement parts specified by the manufacturer or that have the same characteristics as the original part. Unauthorized substitution may result in fire, electric shock, or other hazards.
20. **SAFETY CHECK** - Upon completion of any service or repairs to this product, ask the service technician to perform safety checks to determine that the product is in proper operating condition.



CAUTION

TO PREVENT ELECTRIC SHOCK, DO NOT USE THIS (POLARIZED) PLUG WITH AN EXTENSION CORD, RECEPTACLE OR OTHER OUTLET UNLESS THE BLADES CAN BE FULLY INSERTED TO PREVENT BLADE EXPOSURE.

Evolution User Guide - Contents

- 1.0 Intro
 - 1.1 Introduction, About This Owner's Manual
 - 1.2 Description By Model
 - 1.3 Identifying Your System
- 2.0 Getting Organized
 - 2.1 Unpacking
 - 2.2 Parts List
- 3.0 Speaker Placement
 - 3.1 2 Channel Stereo
 - 3.2 5.1 Digital Surround Sound
 - 3.3 Enhanced Digital Surround Formats
 - 3.4 Center Channel
 - 3.5 Subwoofers
 - 3.6 Electronics
- 4.0 System Assembly
 - 4.1 Supplies and Tools
 - 4.2 Monitor Parts Assembly
 - 4.3 T5 and T6 Tower Assembly
 - 4.4 Assembling Monitors to Pedistals
- 5.0 Wiring Your Speakers
 - 5.1 General Guides to Wire Layout
 - 5.2 Speaker Phase
 - 5.3 Connecting Speaker Wire
 - 5.4 T5 and T6 Tower Wiring
 - 5.5 Wiring For Monaural Bass
 - 5.6 System Wiring Diagrams
- 6.0 Connecting Evolution Electronics to Your System
 - 6.1 Signal Connections
 - 6.2 Power Connections
- 7.0 Basic Settings for the X1 Active Crossover
- 8.0 X1 Bass Manager/ Active Crossover
 - 8.1 Design
 - 8.2 Placement
 - 8.3 Explanation of Features
 - 8.4 System Status Indicators
 - 8.5 Fine Tuning
- 9.0 A1 Monaural Amplifier
 - 9.1 Design
 - 9.2 Placement
 - 9.3 Rack Mounting the X1 and or A1
 - 9.4 Power/Standby Mode
 - 9.5 Courtesy Lights
 - 9.6 System Status Indicators
 - 9.7 Replacing the Fuse
 - 9.8 Changing the Line Voltage Setting
- 10.0 Maintaining Your System
- 11.0 Evolution Technology
 - 11.1 Monitor Technology
 - 11.2 What is Virtual F.I.G.?
 - 11.3 Boundary Switch
 - 11.4 High Dynamic Range/Low Power Compression
 - 11.5 Orientation Independent Dispersion
- 12.0 Glossary of Terms
- 13.0 Trouble Shooting
- 14.0 Specifications

1.1 Introduction, About this Owner's Manual

Congratulations on your purchase of an Evolution System. We believe Evolution to be the most flexible, high performance loudspeaker collection available. Along with this manual, we have included the following tools to assist you with the setup of your Evolution system:

NHT Combination #2/#3 Phillips Screwdriver
NHT Binding Post Wrench with Bonus Bottle Opener
Black Cotton Gloves

This Owner's Manual will provide instructions for initial assembly and connection of your system and serve as an ongoing reference tool. The assembly required is very simple and not time consuming. The Manual is organized in logical steps that will quickly take you from unpacking to sitting back and enjoying the amazing sound of Evolution.

If you require assistance at any time during the assembly or installation of your Evolution system, contact your authorized NHT dealer or call our Customer Hotline at 1-800-NHT-9993 (648-9993).

1.2 Description by Model

Monitors

M5 - Designed for small to medium sized rooms. The compact M5 is a 3-way, acoustic suspension, magnetically shielded monitor employing (2) 5.25" woofers, a 3" midrange and a 1" aluminum dome tweeter.



M6 - Designed for medium to large rooms. The high output M6 is a 3-way, acoustic suspension, magnetically shielded monitor employing (2) 6.5" woofers, a 4" midrange and a 1" aluminum dome tweeter.



Free Standing Subwoofers

W1 - The cabinet portion of the U1 Powered Subwoofer system. The W1 subwoofer module employs dual, opposing 12" aluminum cone woofers in a surprisingly compact enclosure.



W2 - The cabinet portion of the U2 Powered Subwoofer system. The W2 subwoofer is only available and used in pairs. Each cabinet contains a 12" front firing, aluminum cone woofer. This system is ideal for in-cabinet or built in applications.



Tower Subwoofers

B5 - The B5 subwoofer bass module, when mated with M5 Monitor,



becomes the Evolution T5 tower. It employs the Evolution 12" aluminum cone woofer. The B5 cabinets are mirror imaged to allow for proper woofer orientation.

B6 - The B6 subwoofer bass module mates with the M6 to form the T6 tower system. Designed for larger rooms, the mirror imaged B6 modules each contain two 12" aluminum cone woofers.



K5 / K6 - Parts kit needed to assemble one T5 or T6 tower.



Pedestals

P5 - The pedestal matched to the M5. Allows the monitor to be used free standing with separate subwoofers or placed as a rear channel speaker.



P6 - The pedestal matched to the M6. Allows the monitor to be used free standing with separate subwoofers or placed as a rear channel speaker.



Electronics

A1 - A full range (20Hz-20kHz), 250 watt (@ 6ohms), monaural class G amplifier for use with all Evolution subwoofers and tower bass modules, or to power an Evolution Monitor.



X1 - A dedicated, active crossover for use with all Evolution subwoofer and tower systems.



1.3 Identifying Your System

To the right is a chart by model, indicating the various components and accessory kits included with your purchase of either the T5/T6 tower or U1/U2 subwoofer system. The M5/M6 and P5/P6 are packaged individually with their required hardware and accessories.

	T5 Towers	T6 Towers	U1 Subwoofer	U2 Subwoofer
OK Owners Kit	1	1	1	1
M5	2			
M6		2		
B5 Left	1			
B5 Right	1			
B6 Left		1		
B6 Right		1		
K5 Tower Kit	2			
K6 Tower Kit		2		
W1 Subwoofer Cabinet			1	
W2 Subwoofer Cabinet				2
X1 Bass Management/ Active Crossover	1	1	1	1
A1 Amplifier	1	2	1	1

2.0 Getting Organized.

CAUTION: Some of the Evolution product is heavy. We recommend you enlist help in unpacking, assembling and moving the larger speaker components.



The cartons for all tower speaker components and assembly kits are color coded. The print on the 5 series cartons (M5, B5, K5, P5) is red; the print on the 6 series cartons (M6, B6, K6, P6) is blue. All other Evolution product cartons use black print.

2.1 Unpacking

We suggest you use an open area to unpack and assemble your system, particularly if you purchased a tower system. Remember, all Evolution speaker components are finished in fine lacquer. To avoid damage, assemble the speakers on a soft surface, e.g. a carpet or blanket.

Take care in unpacking your NHT products to avoid marring the cabinets. It's best to use gravity to your advantage. Open each carton as shown, gently turning it upside down and pulling the carton up and off of the speaker. Remove the protective end caps, plastic bag and the micro-foam. Avoid putting your hands directly on the speaker drivers as they can be damaged if handled roughly.

Once you have everything unpacked, inspect and familiarize yourself with the contents. There is a complete parts list for each product carton in the next section.

Note: If possible, we recommend that you store the shipping cartons and packing material in case the system needs to be moved in the future.

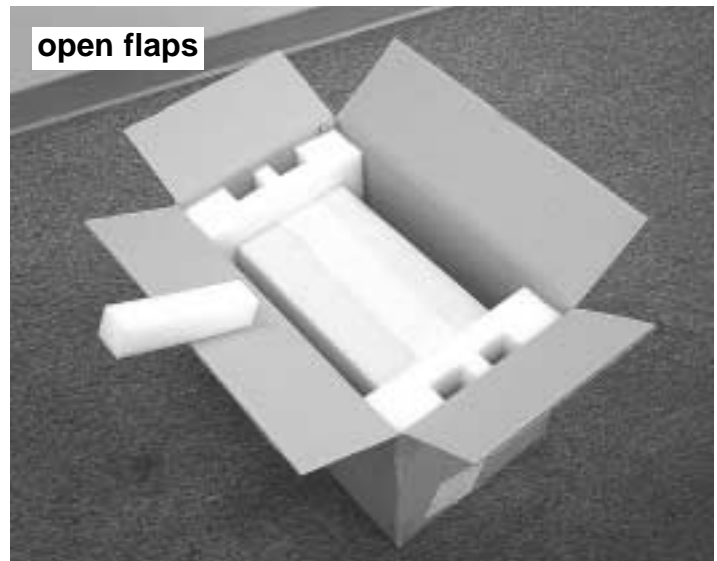

2.2 Parts List

M5 or M6 Monitor Carton:

M5 or M6 monitor

Grille carton:

Grille

Logo

Third foot

(2) Thumbscrews

(2) Plastic washers

(4) Rubber feet

Warranty card

W1 Carton:

Subwoofer cabinet for the U1 System

(4) Rubber feet

Warranty card

W2 Carton:

Subwoofer cabinet for the U2 System

(4) Rubber feet

Warranty card

X1 Carton:

X1 Active crossover

Power supply

Warranty card

A1 Carton:

A1 Amplifier

Power cord

Dual Subwoofer Adapter

Warranty card

K5 or K6 (tower assembly kit) Carton:

Mounting buttress

Monitor connection harness

(2) Aluminum stabilizer bars (for B5 or B6)

(4) $\frac{1}{4}$ - 20 spikes with lock nuts

(4) Metal cups

(4) $\frac{1}{4}$ - 20 machine screws

(7) 10-24 machine screws

(6) Rubber feet

B5 or B6 (left or right) Bass Module Carton:

Tower Base enclosure

Warranty card

P5 or P6 Carton:

P5 or P6 Pedestal

Metal mounting plate

Stabilizer bar carton:

(4) $\frac{1}{4}$ - 20 spikes with lock nuts

(4) $\frac{1}{4}$ - 20 machine screws

(5) 10-24 machine screws

(2) Wire channel brackets

(1) Wire channel

(4) 6 - $\frac{3}{4}$ flathead screws

(2) Aluminum stabilizer bars (for

P5 or P6)

(4) Metal cups

(8) Rubber feet

Warranty card

3.0 Speaker Placement

Now is a good time to finalize your plans for speaker placement. This section outlines the important issues to consider in configuring your system for optimum performance.

The M5 and M6 monitors are designed to perform almost identically whether placed horizontally or vertically. Below are some fundamental guidelines on Monitor orientation:

- 1) You do not need to “toe-in” the monitors toward the listening area; position them facing straight ahead into the room, perpendicular to the wall in behind the speaker.
- 2) When oriented vertically, the tweeters should be placed inward as shown below.

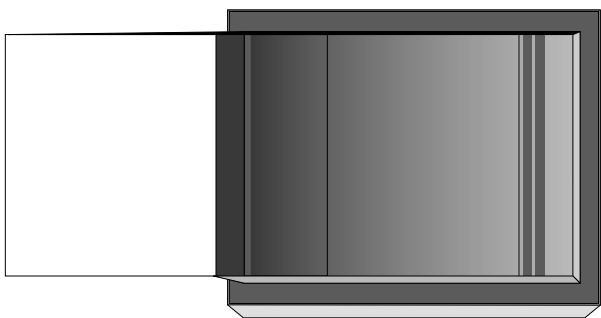

- 3) When using the M5 or M6 monitor for a center channel, it should be placed horizontally.
- 4) When Evolution monitors are placed horizontally in a cabinet, the tweeter orientation (top or bottom) depends on the placement height. If

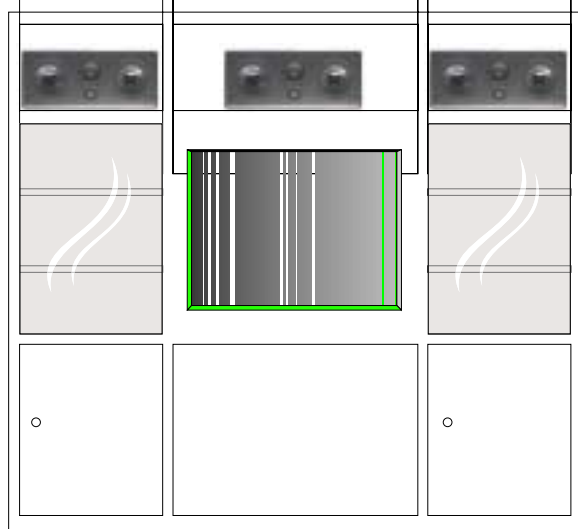

the monitor is placed above the listener's ear, the tweeter should be below the midrange driver as shown in the photo. If the monitor is placed below the listener's ear, the tweeter should be above the midrange driver.

Once you have determined how you will orient your monitors, examine the terminal plate on the back of your Evolution Monitor. You will find a Boundary Switch on the plate that is used to adjust the speaker's response based on its placement. If you intend to place the monitor in a cabinet, on a shelf, on top of a television set or against a wall, move the boundary switch to the “1” position. If the monitor is two feet or more from any surface described above, the switch should be in the “0” position. If the Monitor is used as part of a T5 or T6 Tower system, the Boundary Switch should generally be in the “0” position. If the Tower system is placed very close to a corner, set the switch to the “1” position.

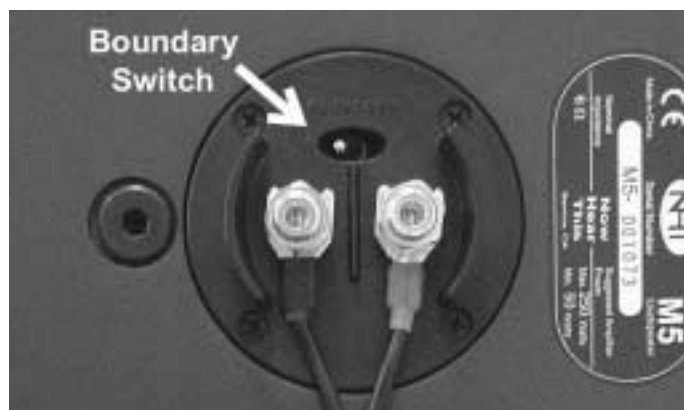

Note: The terminal plate comes from the factory oriented for horizontal placement. This allows speaker wire to hang down neatly from the speaker. The terminal plate should be rotated for vertical use. Instructions for rotating the cup can be found in section 4.2.

An explanation of the technology behind the guidelines described above can be found in section 11 of this manual.

3.1 Two Channel Stereo

The diagram below illustrates the desired monitor and subwoofer placement for two channel (stereo) listening. If you are not using an Evolution tower or pedestal and are orienting the monitors vertically, try to place the M5 or M6 so the tweeters are at or near ear level.

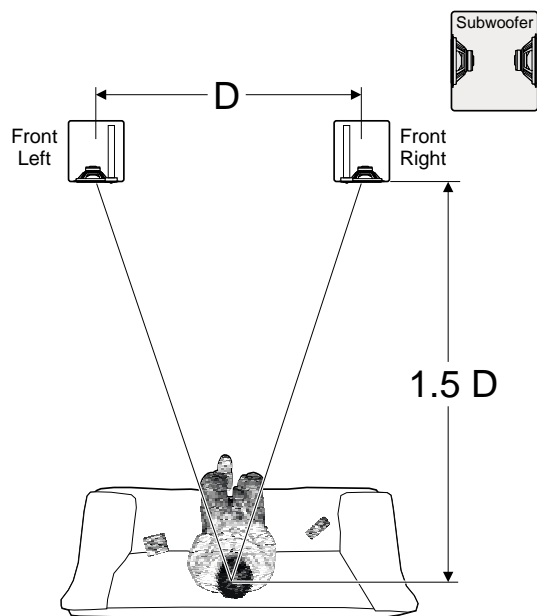

3.2 5.1 Digital Surround

The diagrams below illustrate two options for positioning your speakers in a 5.1 surround system. The first option is ideal, assuming you have sufficient space to place the front and rear channel speakers equidistant from the listening position.

If you are primarily listening from a position near or against a rear wall as shown in the next illustration, you can place the rear channel monitors to the sides. Surround processors and receivers have adjustable delay settings that allow you to equalize the arrival times for the rear channels. Refer to your Surround Processor/AV Receiver manual to find the correct delay setting.

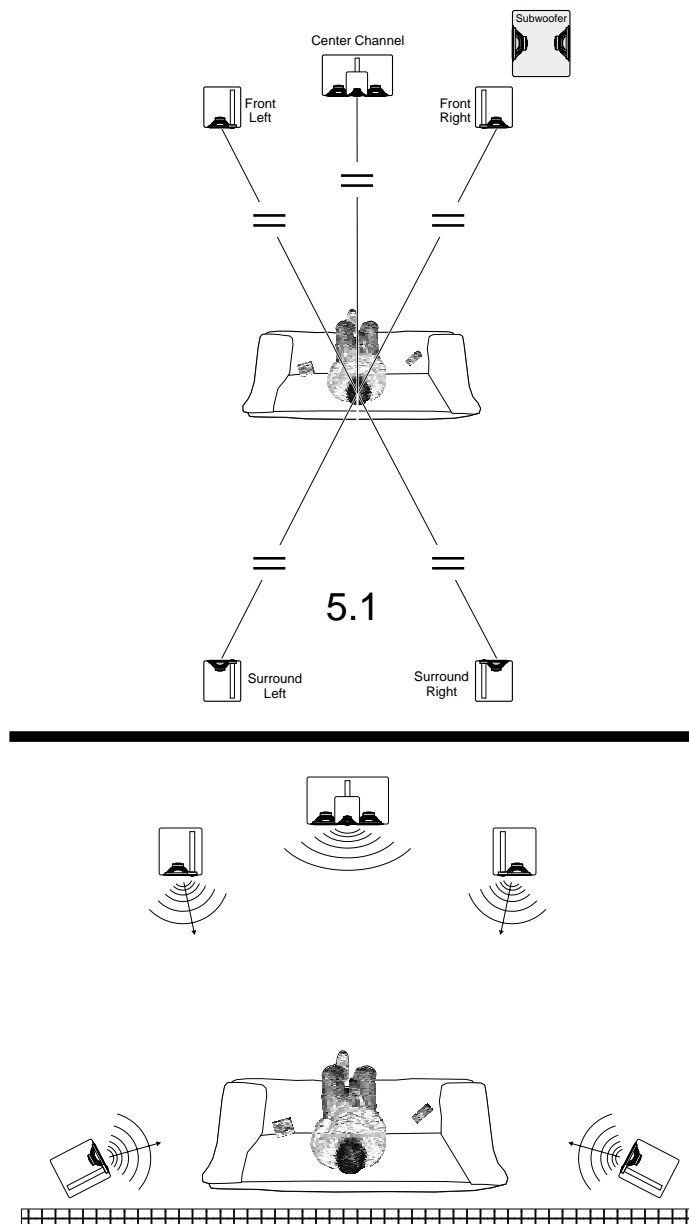

We realize it may be impossible to arrange your room to accommodate the ideal surround setup. Because every home is unique, we suggest you consult your authorized NHT dealer for alternative placement advice or call our Customer Hotline at 1-800-NHT-9993 (648-9993).

3.3 Enhanced Digital Surround Formats

Different surround formats use different numbers of surround speakers. 5.1 systems use two surround speakers, 6.1 systems use three and 7.1 systems use four. Some AV receivers and separate Surround Processors are equipped with 6.1 or 7.1 surround formats. 6.1 refers to the Dolby Digital Surround EX™ or DTS Surround ES™ standard. The diagrams below illustrate the suggested positions for 6.1 and 7.1 systems.

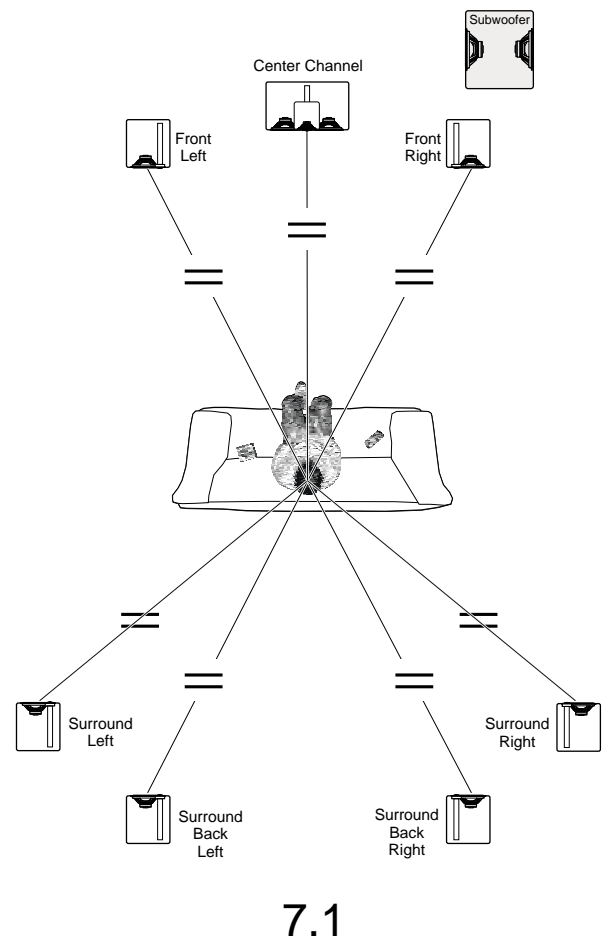
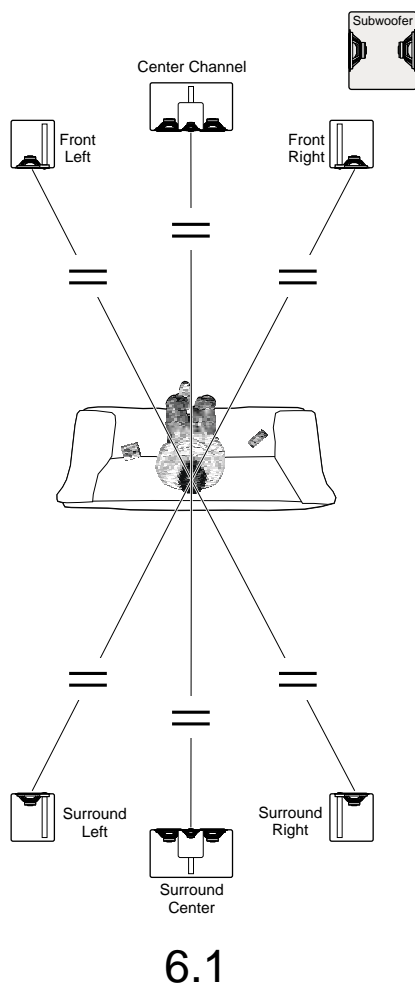

Be aware that there are other surround formats that are not covered in this setup guide. Consult your authorized NHT dealer if you are unsure about your particular system configuration.

Note: Pay attention to the orientation of the monitors (horizontal or vertical) and tweeters (top/bottom or inside/outside) in your installation for correct system performance.

3.4 Center Channel

The M5 and M6 monitors can be placed in a home entertainment center or directly on top of a TV as shown below. Remember, for proper center channel sound dispersion, the Monitor should be placed horizontally.

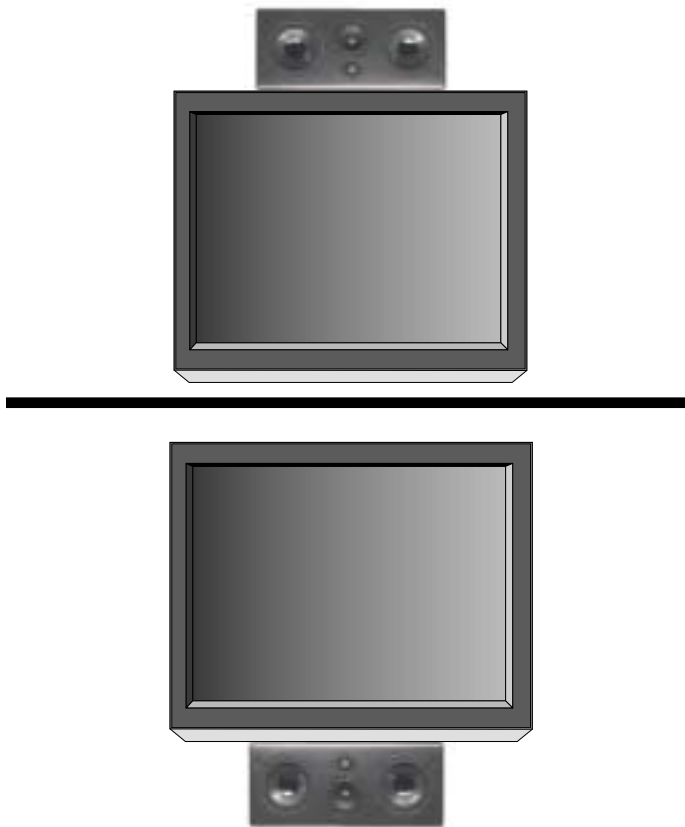

If you intend to place your center channel on a television with a shallow top so that the Monitor overhangs the television as illustrated below, you will need to attach the included Third Foot for proper support (see Section 4.2 for detailed instructions).

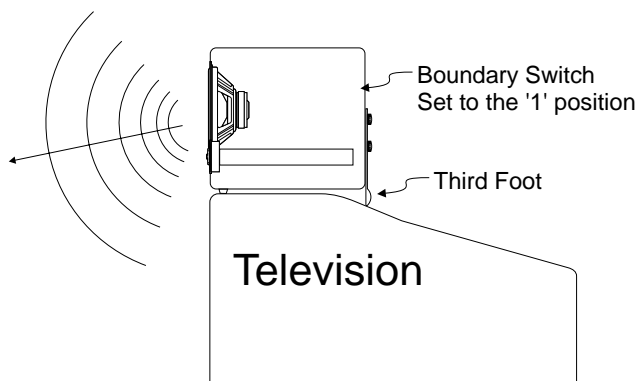

3.5 Subwoofers

Subwoofers produce low frequencies that have long wavelengths. These wavelengths are similar to the dimensions of the room, so the sound energy strongly interacts with the room boundaries. Fortunately, Evolution's flexible subwoofer options, combined with the X1 active crossover, solve most of the acoustic problems caused by room interaction with bass frequencies. Experimenting with subwoofer location is the key to finding the best performance in your listening environment. Position a subwoofer cabinet so that its driver(s) are not directly against a wall or piece of furniture. If you are using two subwoofers, some improvement in low frequency response can be achieved by placing the second subwoofer asymmetrically in the room.

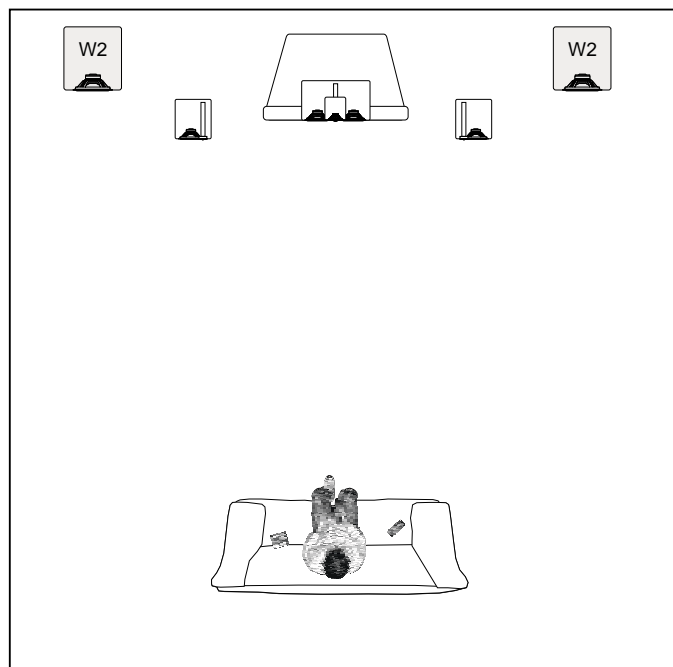

Note: Because of the massive motor structure used in the Evolution subwoofer driver, it is not possible to magnetically shield it. Make sure you place the subwoofer at least 18" from any television to avoid discoloration.

Evolution freestanding subwoofers offer tremendous flexibility in placement. The following suggestions illustrate a few of the possibilities available to you. If you have a unique placement requirement or intend to use multiple subwoofer systems, consult your authorized NHT dealer or call our Customer Service Hotline at 1-800-NHT-9993 for advice.

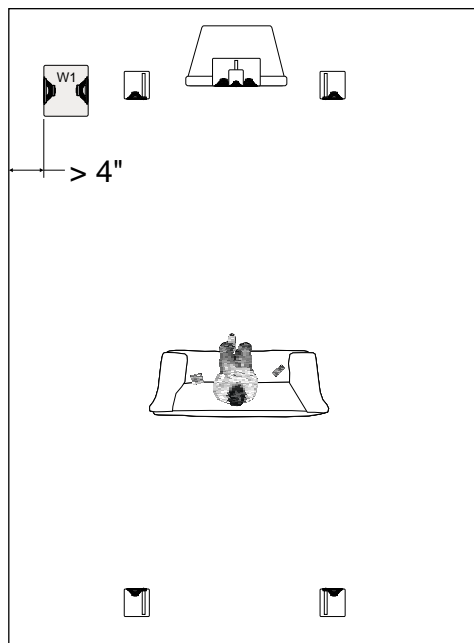

U1 Subwoofer System: The U1 subwoofer enclosure is a dual, side-firing design. If the U1 is going to be located in a corner or against a wall, we recommend that you keep the face with the grille at least 4" from any boundary to obtain optimum performance.

U2 Subwoofer System: The compact, front-firing, dual cabinets in the U2 system can be conveniently placed near corners, or placed in cabinets as illustrated below.

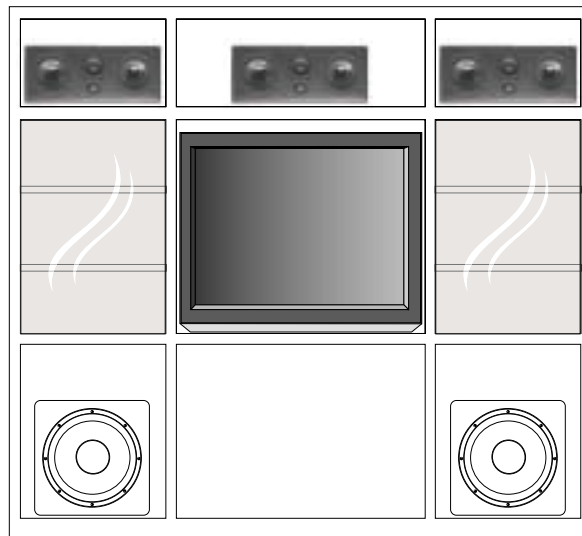

3.6 Electronics

Evolution electronics should be placed with the rest of your electronic components. Both the A1 amplifier and the X1 Active Crossover can be rack mounted if desired. Instructions for rack mounting can be found in section 9.3 of this manual.

4.0 System Assembly

This section covers the assembly required for specific Evolution product configurations. The operations are simple and easy to accomplish quickly.

4.1 Supplies and tools

The tools you will need are:

- Combination #2/#3 Phillips screwdriver (provided in your Owner's Kit)
- NHT binding post wrench (provided)
- Wire strippers
- Speaker wire (10 to 14 gauge)
- Tape measure or ruler

CAUTION: Some of the Evolution components are heavy. If possible, have someone available to assist you during assembly and placement of the tower and/or subwoofer modules.

4.2 Monitor Parts Assembly

Step 1: Terminal Plate Orientation

The M5 and M6 are delivered with the Terminal Plate oriented for horizontal monitor placement. For vertical monitor placement, the Terminals should be rotated so that the speaker wire hangs straight down the rear of the speaker.

Place the monitor on a soft surface in the desired orientation. See section 3.0 for illustration of proper tweeter orientation. **DO NOT** lay the front baffle of the Monitor down on any surface, as this will damage the drivers.

Remove the four screws from the Terminal Plate on the back of the Monitor with the supplied #2

screwdriver. Gently pull the Terminal Plate away from the cabinet and rotate it 90 degrees so that the Boundary Switch is at the top. Reinstall the screws in the pilot holes as shown. Make sure the screws are snug, but be careful not to over tighten them.

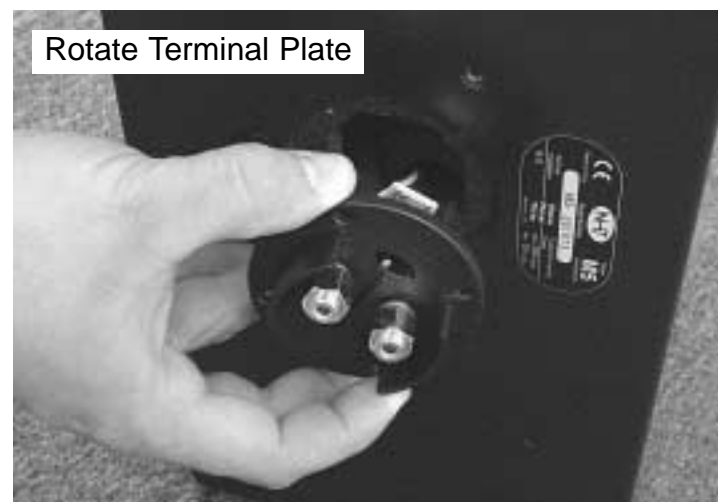

Step 2: NHT Third Foot for Center Channel Use

The M5 and M6 cartons include a “Third Foot”, a support that stabilizes the monitor when it is mounted on a television. If the top of the television is shallower than the Monitor is deep, the rear of the Monitor will not be fully supported. The Third Foot will provide the necessary support in this case. The Third Foot can also be used to aim the Monitor down towards the listening area if the television is significantly above eye level.

There are two parts supplied with the Third Foot for assembly: (2) plastic washers and (2) thumbscrews. The plastic washers go between the Third Foot and the cabinet to protect the cabinet’s lacquer finish. Assemble these parts as shown and screw the two thumbscrews partially into the two threaded holes next to the terminal plate.

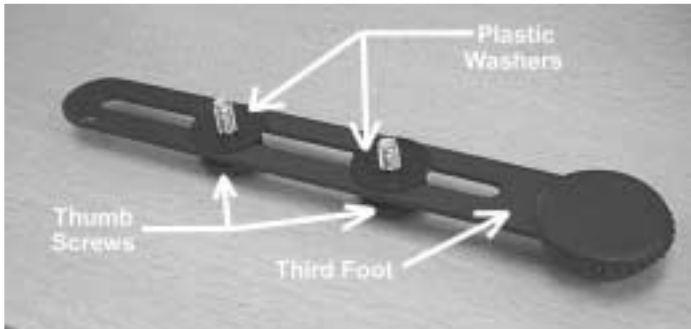

Attach the two rubber feet about an inch from the bottom front edge of the monitor. Set the monitor on the television and adjust the length of

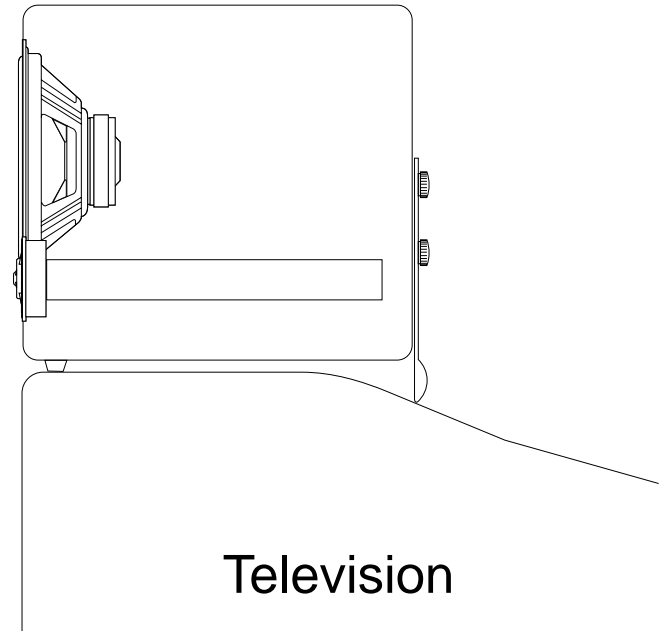

the third foot so that it rests on the TV set as shown. Hand tighten the thumbscrews.

Step 3: Logo Placement

The M5 and M6 are supplied with a metal NHT logo that can be attached to the grilles when the speakers are placed in the vertical position only. The logo should be attached at the bottom of the grille. To attach the logo, hold the grille up to a light to locate the two holes in the frame through the cloth. Line up the two posts on the back of the logo with the holes and press the logo firmly through the cloth and into the grille frame until it is fully seated against the grille.

Note: The logo badge is not attachable when the speaker is placed horizontally.



Step5: Attaching Monitor Grilles

The M5 and M6 are designed to sound the best when the grilles are used (they may sound slightly bright if played without the grilles). To install them, line up the four pins on the back of the grille with the four rubber cups located in the corners of the Monitor's front baffle. Firmly press all four corners of the grille until the pins seat against the rubber cups.

Note: The M5 and M6 grilles are intentionally curved. The grille curve is a design element that completes a larger curve when a Monitor is attached to a B5/B6 subwoofer module or either pedestal stand. The curve is shallow enough that it may go unnoticed when the monitors are placed on shelves. The illustration to the right shows how an Evolution tower looks when the grille is installed.

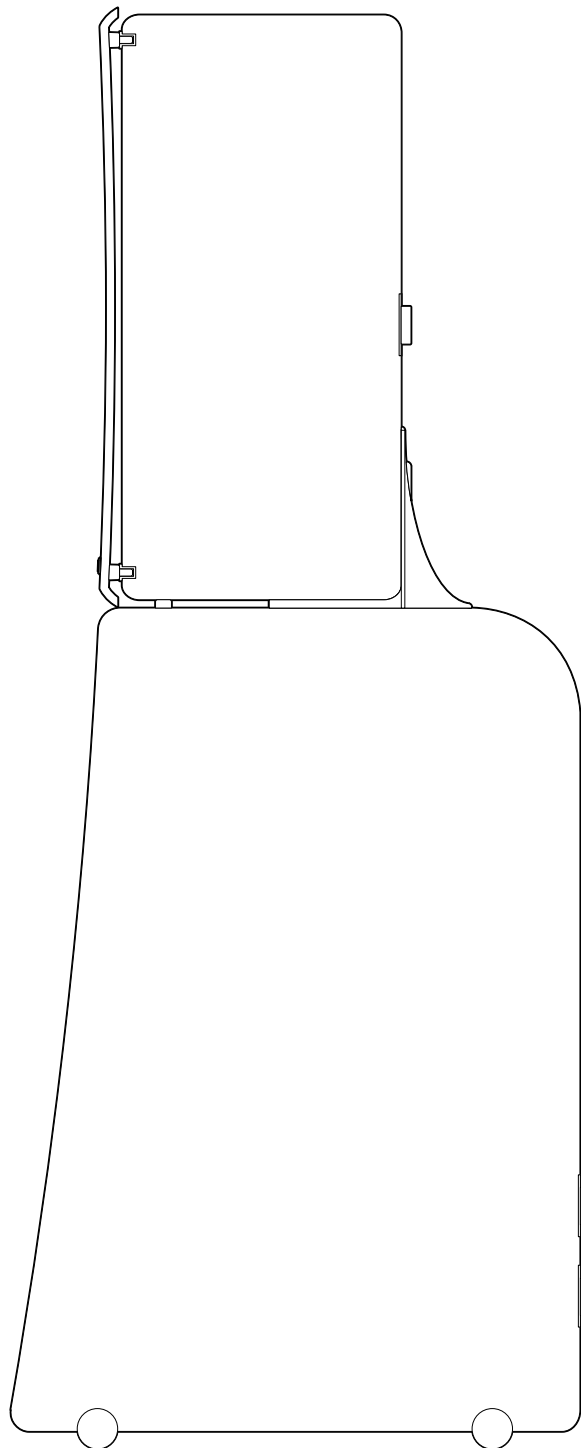
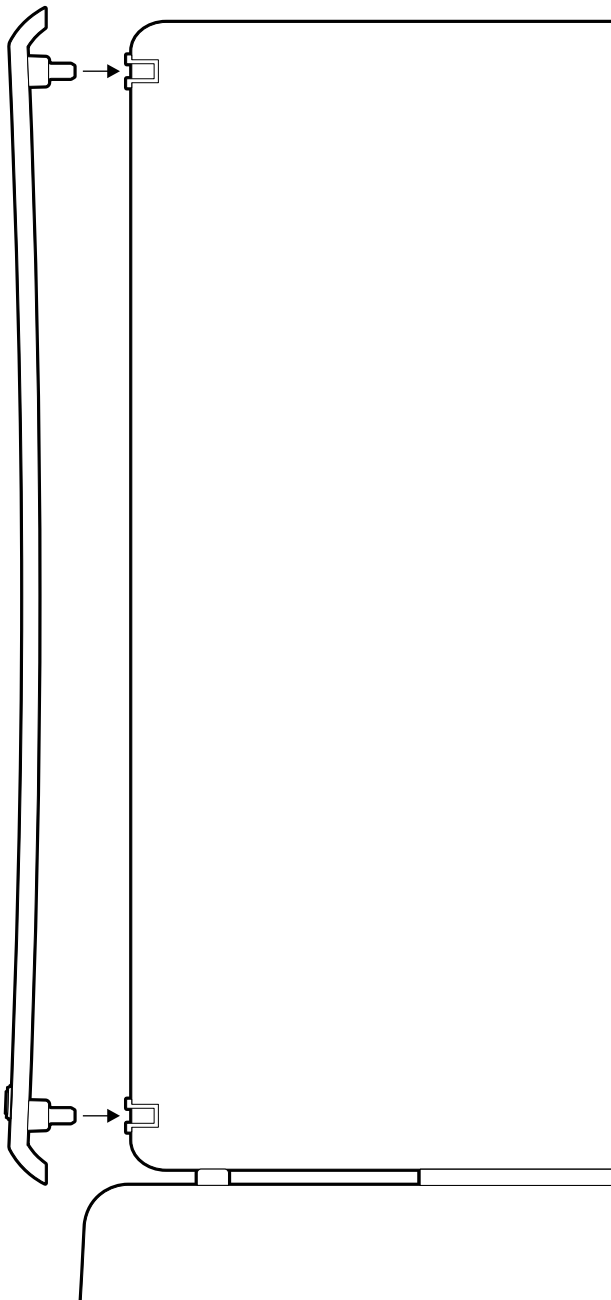

4.3 T5 and T6 Tower Assembly

Depending on which model you purchased, you will now need the parts contained in either the K5 or K6 assembly kit.

Step 1: Installing the Stabilizer Bars

The aluminum bars attach to the bottom of the bass module to provide stability for the tower system. Carefully turn the B5 or B6 bass module upside down on a soft surface. There are four threaded holes on the bottom of the cabinet. Gently place the stabilizer bars over the threaded holes. Start the four large (1/4-20) screws by hand. Once all the bolts are started, tighten them with the supplied #3 Phillips screwdriver.



Note: If you intend to use spikes with the stabilizers, do not install them at this time. The towers are difficult to move once the spikes are in place. Spike installation is covered in Step 9.

Step 2: Adhering the Rubber Feet

Once the stabilizers are mounted, carefully turn the bass module upright. Peel the paper cover off the back of the two round rubber feet and



attach them to the top front of the B5 or B6. There are slight indentations on the cabinet to help you position the rubber feet properly.

Step 3: Attaching the Monitor Connection Harness

The Monitor Connection Harness connects the Monitor's speaker terminals to the terminal cup on top of the subwoofer module. This terminal cup is internally wired to the uppermost of the two terminal cups at the bottom rear of the subwoofer module. Remove the two gold-plated screws from the terminal cup on the top of the B5 or B6 with the #2 screwdriver. Insert the ring terminal ends of the cable onto the screws and fasten them into the terminal cup. Check that the wire is oriented vertically and that you have connected the red ring terminal to the bass module terminal marked in red (and the black ring terminal to the bass module terminal marked with black).



Step 4: Installing the Mounting Buttrass

The mounting buttrass secures the monitor to the bass module. Place the buttrass over the four threaded holes on the top of the bass module. Start four of the smaller screws (10-24) with the #2 screwdriver. Center the buttrass by measuring the distance between the base of the buttrass and the speakers' edge in a few places as illustrated. Once you have checked alignment you may tighten the screws, making sure they are snug, but do not over tighten them.



Step 5: Route Monitor Connection Harness

Route the harness through the channel inside the buttrass as shown below.



Step 6: Bass Module Orientation

At this point you need to decide in which orientation to place the subwoofers. There are two options, woofers facing inwards or outwards as shown in the illustration.

If there is going to be a large object located between the towers (a television or large piece of furniture), place the subwoofer modules so that the woofers face to the outside (away from the television). If there are no large objects between the towers, orient the subwoofers so that the woofers face to the inside (towards each other). Remember that the subwoofer modules should be at least 18" from the sides of a television to prevent discoloration of the screen.

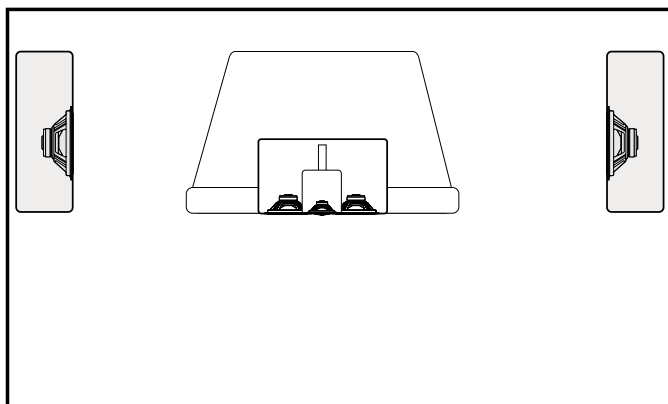
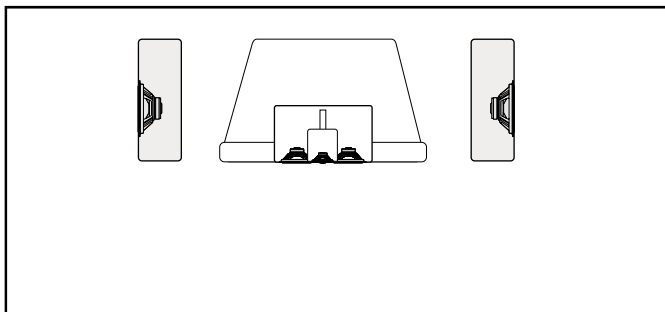

Step 7: Mounting a Monitor to the Bass Module

Place the monitor on the butress as shown. The front of the monitor should be resting on the round rubber feet. Line up the threaded holes in the back of the monitor with the holes in the butress. Fasten the monitor to the butress with three small (10-24) screws using the #2 screwdriver. Start the center screw first, and then start the outer screws. Make sure that the Monitor Connection Harness extends from the top of the butress as illustrated below.



Step 8: Connecting the Monitor Connection Harness to the Monitor

Loosen the nuts on the binding post terminals enough to allow the spade terminals on the Harness to fit under them. Make sure you match wire colors for proper polarity, (red to red, black to black). The cable should lay flat against the back of the monitor. Tighten the terminal nuts using the NHT wrench.



Step 9: Install spikes (optional)

Spikes couple the speaker to the floor, improving the performance of the system.

Note: Position the speakers in their permanent location before installing the spikes. It is very difficult to move the

assembled speakers once the spikes are in place. We suggest two people for this operation, one to hold the speaker and the other to install and adjust the spikes.

Install the locking nuts on the threaded spikes and screw them all the way down the shaft until they



stop. Carefully tilt the tower speaker to one side and screw the metal spikes into the bottom of the front and rear aluminum stabilizer bars (at least 3/8") to the desired height. Hand tighten the nut to lock it in position. When both sides are installed, check to ensure that the speaker does not rock. If necessary, tilt the speaker, loosen the nut and adjust the height until the speaker rests firmly on all four spikes. You can use a small wrench to further tighten the nuts.

Be aware that wood or tile floors can be damaged by the spike's sharp tip. Four small metal cups are included with the tower assembly kit to fit under each spike and protect your floors. Once the spikes have been mounted to the stabilizer bar, slip a cup under each spike as you gently lower the tower to the floor.



4.4 Assembling Monitors On Pedestals

Step 1: Install Aluminum Stabilizer Bars

Carefully turn the P5 or P6 bass module upside down on a soft surface, being careful not to scratch the paint. Find the four threaded holes on the bottom of the pedestal. Gently place the stabilizer bars over the threaded holes. Start the four large (1/4-20) screws by hand. Once they have been started, tighten them with the #3 Phillips screwdriver.



Step 2: Attaching Rubber Feet

Attach the four round rubber feet to the top of the pedestal. Peel the paper backer from each foot, and press them into the shallow indentations on the cabinet surface.



Step 3: Install Metal Mounting Plate

Begin by attaching the metal mounting plate to the pedestal base with two of the small (10-24) screws and the #2 Phillips screwdriver. Note that the notch in the metal plate should be facing downwards. Do not tighten them all the way until the monitor is in position.

Gently place the Monitor on the pedestal top with its back against the mounting plate. Make sure that you have determined the proper tweeter orientation (see Section 3). Start the three small screws (10-24) through the mounting plate and into the threaded holes in the back of the Monitor. Tighten all five screws until snug.

Gently place the monitor on the pedestal top with back against the mounting plate. Make sure that you have the proper tweeter orientation (see Section 3). Start 3 smaller bolts (10-24) through the mounting plate and into the threaded holes in the back of the monitor. Tighten all five bolts until snug.



Step 4: Install Wire Channel Assembly

The wire channel assembly for the P5 and P6 pedestals neatly routes the speaker wire down the back of the pedestal. It consists of two plastic U shaped brackets, one plastic channel and four 6-3/4 screws.

To install, first strip $\frac{1}{2}$ " - $\frac{3}{4}$ " of insulation from the ends of your speaker wire and connect them to the monitor's binding post by loosening the binding post nuts and slipping the wire into the hole behind each nut. Tighten the nuts with your NHT wrench. Remember to check for the correct polarity (see section 5.3 and 5.3).

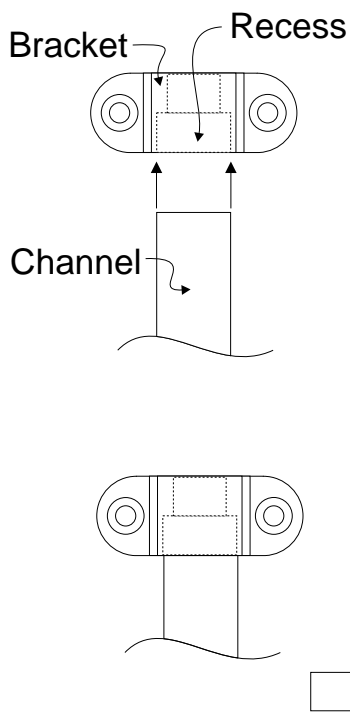

Slip the channel over the speaker wire. The brackets are recessed on one side to accept the

ends of the wire channel. These recesses should face each other when the channel is installed. There are small pilot holes in the rear of the pedestal to accept the 6-3/4 bracket screws. Fasten the channel to the pedestal with the brackets and the four screws as shown.

Step 5: Install Spikes (optional)

Spikes provide additional stability when the pedestal is placed on thick carpet or on an uneven surface. Position the speakers in or close to their permanent location before installing the spikes. It is difficult to move the speakers once the spikes are in place.

Install the locking nuts on the threaded spikes and screw them all the way down the shaft until they stop. Attach the spikes on one side of the pedestal at a time. Tilt the pedestal as shown in the photograph and



screw the metal spikes into the bottom of the aluminum stabilizer bars. Tighten the locking nuts by hand. Move to the other side and repeat the procedure.

Be aware that wood or tile floors can be damaged by the spike's sharp tip. Four small metal cups are included with the pedestal to fit under each spike and protect the floor. Once the spikes have been mounted to the stabilizer bar, slip a cup under each spike as you gently lower the tower to the floor.

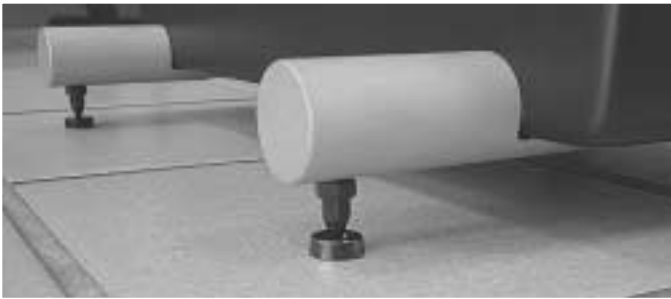

5.0 Wiring Your Speakers

Before beginning to wire your system, we suggest you review the following guidelines and wiring diagrams to find the Evolution system(s) you have purchased.



Tools Required:

NHT Wrench (included)

Wire strippers

Tape measure

Speaker Wire (10 - 14 gauge)

Component Interconnect Cables

5.1 General Guides to Wire Layout

To minimize noise problems, try to segregate cables by function, and separate them by the maximum practical distance. Where audio and video cables intersect, cross them at right angles. Try not to twist or tie AC power cords and speaker cables together.

The minimum size speaker cable recommended for runs of 20 feet or less is 14awg. Heavier special purpose cable can be used for longer runs. For best results, use equal length runs of cable for the left and right speakers (or for the left, center and right speakers).

5.2 Speaker Phase

For proper response, the speakers must be wired in-phase with each other. That is, the Red (+) terminal on the amplifier speaker output must be connected to the corresponding Red (+) terminal on the speaker. The same is true of the Black (-) terminals. All speaker cable or wire

has a marking along one or both conductors to help you make the correct connections. Weak bass and the lack of a well-defined image are indications that speakers are wired out of phase. A well-defined image is one in which you can easily locate the positions of performers in the sound field.

5.3 Connecting Speaker Wire

The gold plated binding posts on all Evolution speakers will accept raw wire or virtually any type of special purpose terminal. If you plan to use raw wire, strip 1/2" to 3/4" of insulation from the ends, twisting the exposed wire strands tightly. Remove the binding post nuts on the terminal and slip the wire through the hole in the binding post. Replace the nuts on the binding post and tighten until snug with the NHT wrench.

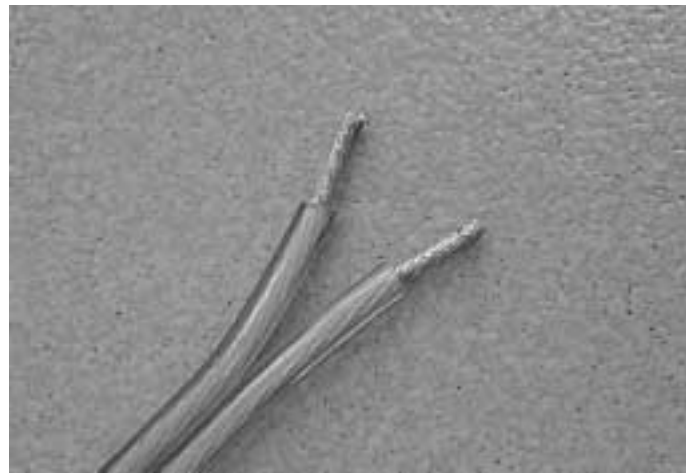

5.4 T5 and T6 Tower Wiring

You will be running 2 pairs of speaker wires to either Evolution tower model. The M5 and M6 are wired through the B5 or B6 cabinet to keep the speaker cables near the floor and to reduce their visibility. There are two Terminal Plates on the backside of the B5 and B6. The top terminal plate connects an M5 or M6 to your AV Receiver or amplifier. The bottom terminal plate connects a B5 or B6 to an A1 subwoofer amplifier.

5.5 Wiring for Monaural Bass

The B5 bass modules and the dual W2 subwoofer cabinets require one additional wiring step. The speaker wire coming from the B5 or W2 cabinets must be connected in parallel at the A1 subwoofer amplifier. The Dual Subwoofer Adapter has been supplied with the A1 amplifier for this purpose (see illustration).

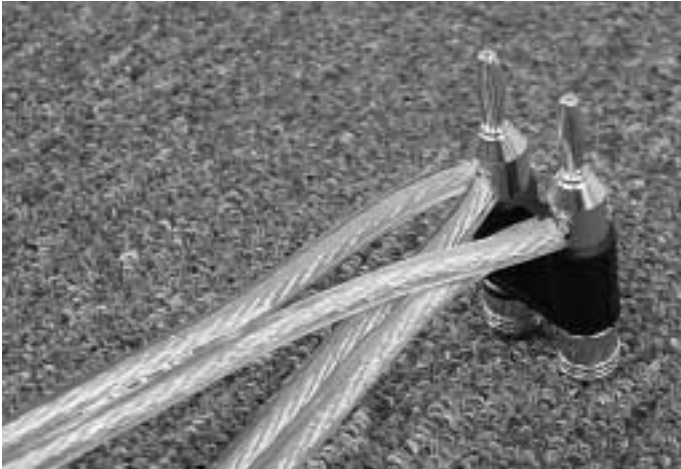

Loosely twist the "+" wires from each subwoofer (or tower base) together, then repeat for the "-" wires. Loosen the red and black thumbscrews on the Adapter until the hole in the shaft is fully revealed. Insert the twisted pair of "+" speaker wire to the hole marked with red. Tighten until the wire is securely clamped. Repeat the procedure for the "-" speaker wire and black thumbscrew. The Adapter can now be inserted into the A1 amplifier's "speaker out" terminal posts.



5.6 System Wiring Diagrams

The following pages contain diagrams illustrating proper wiring for each Evolution model:

Monitor Wiring Diagram

U1 Wiring Diagram

U2 Wiring Diagram

T5 Wiring Diagram

T6 Wiring Diagram

M5 / M6 Wiring Diagram

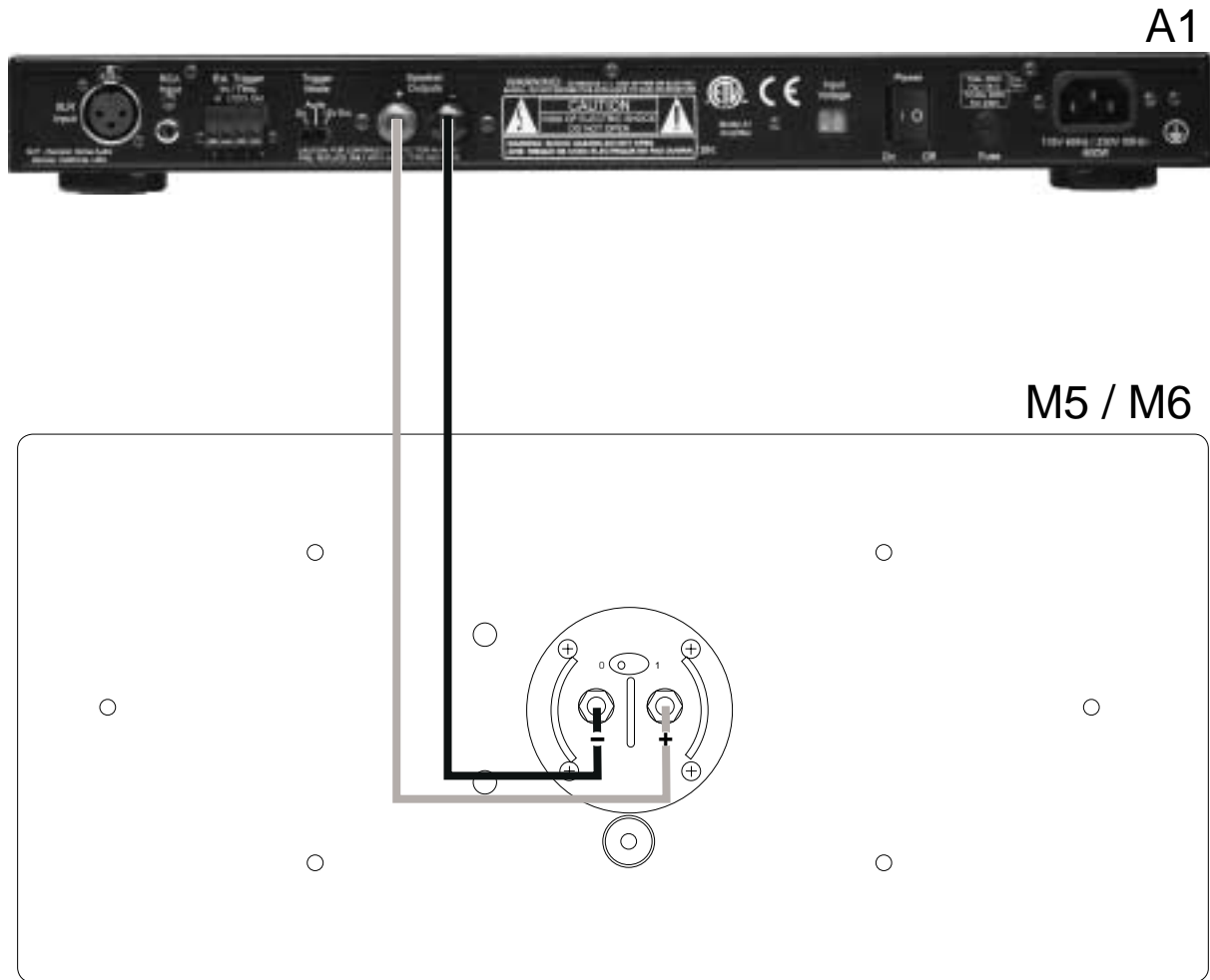

U1 Wiring Diagram

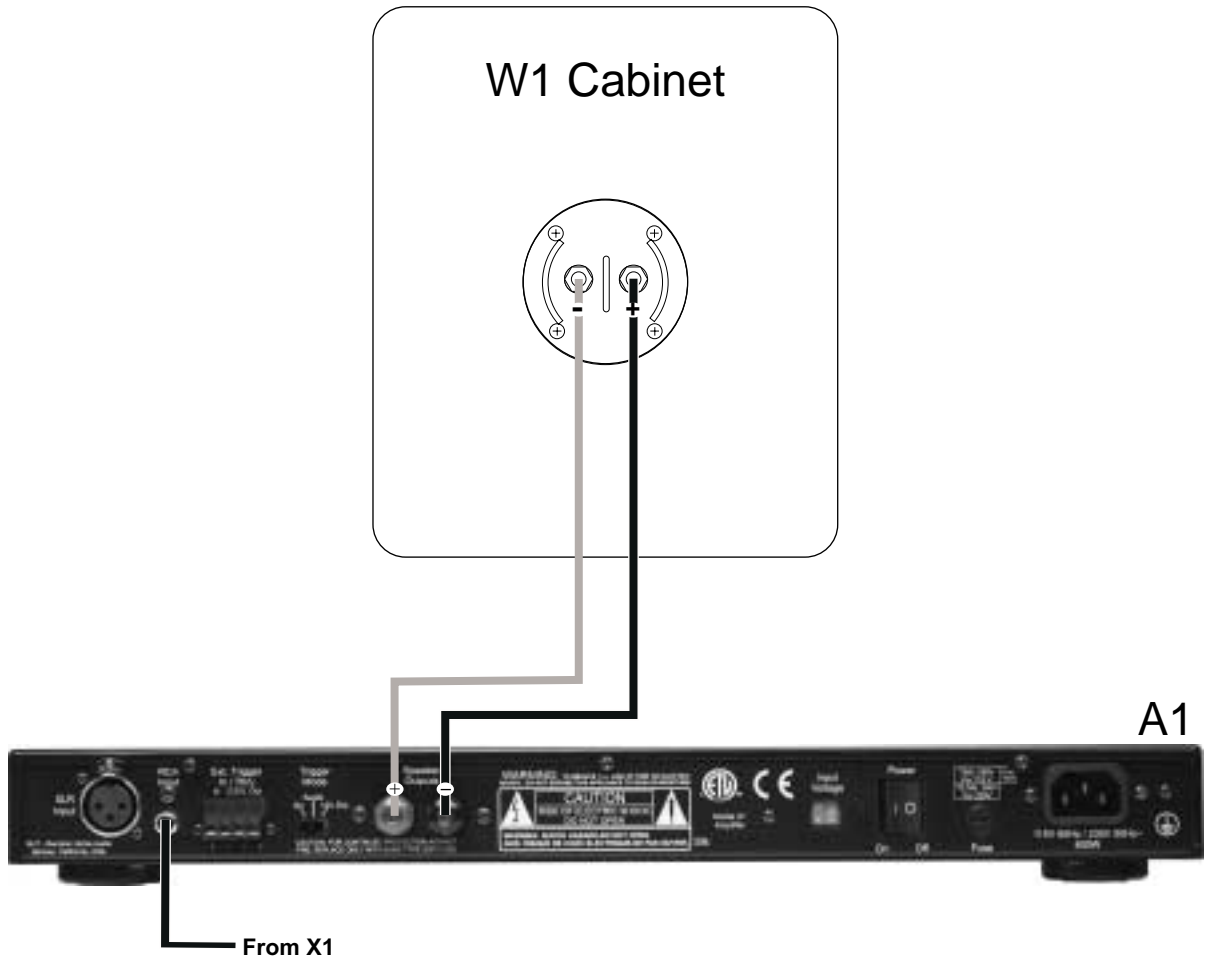

U2 Wiring Diagram

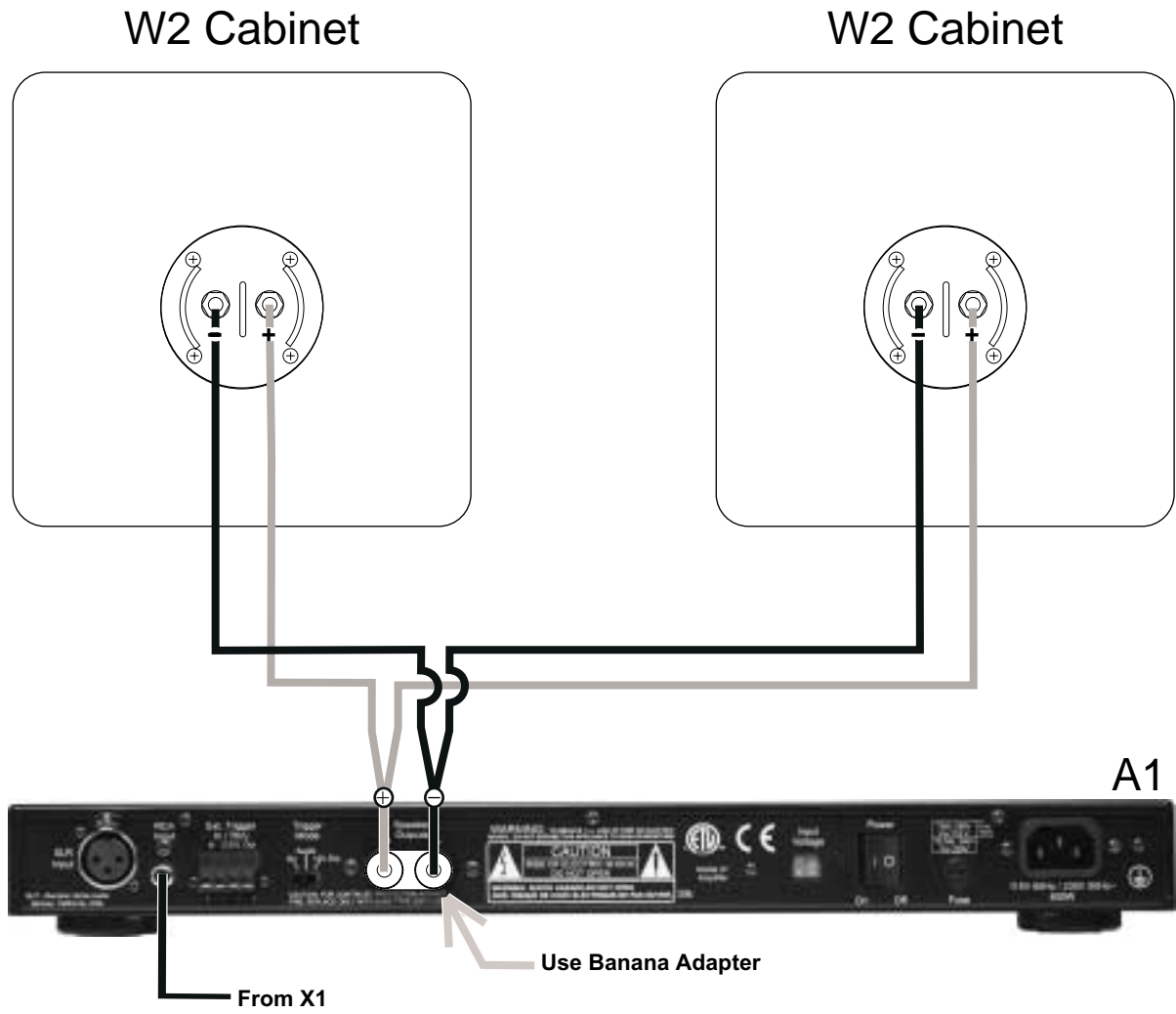

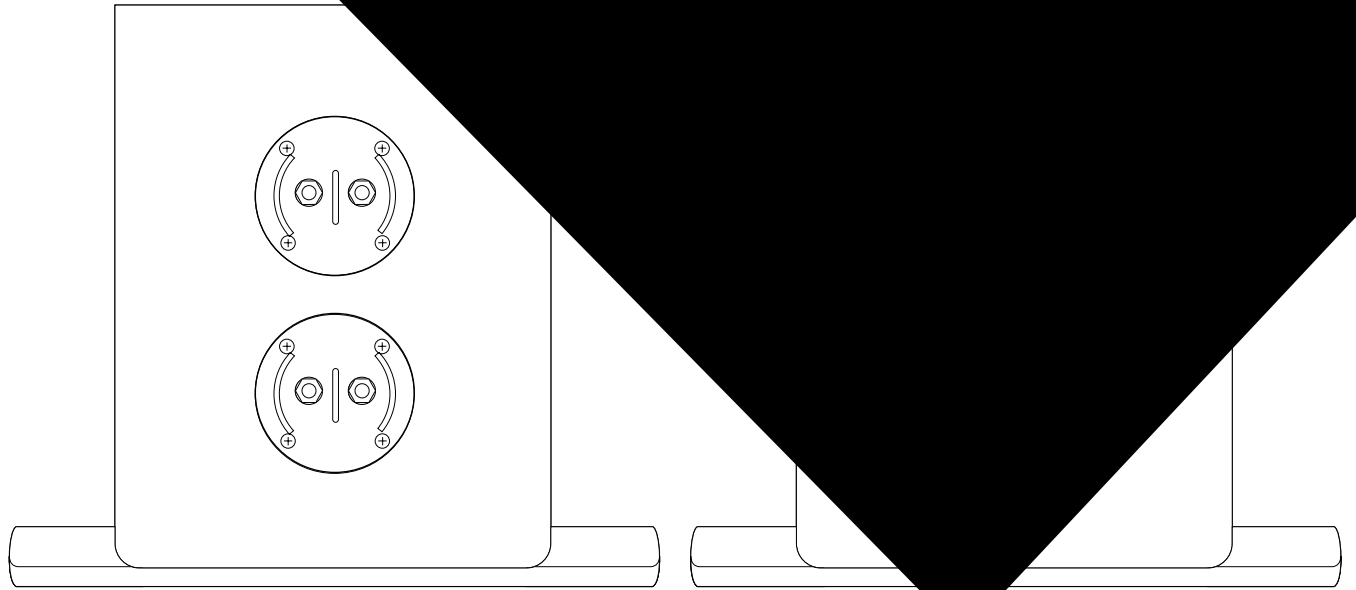

T6 Wiring Diagram

T6 Tower Left

T6 Tower Right

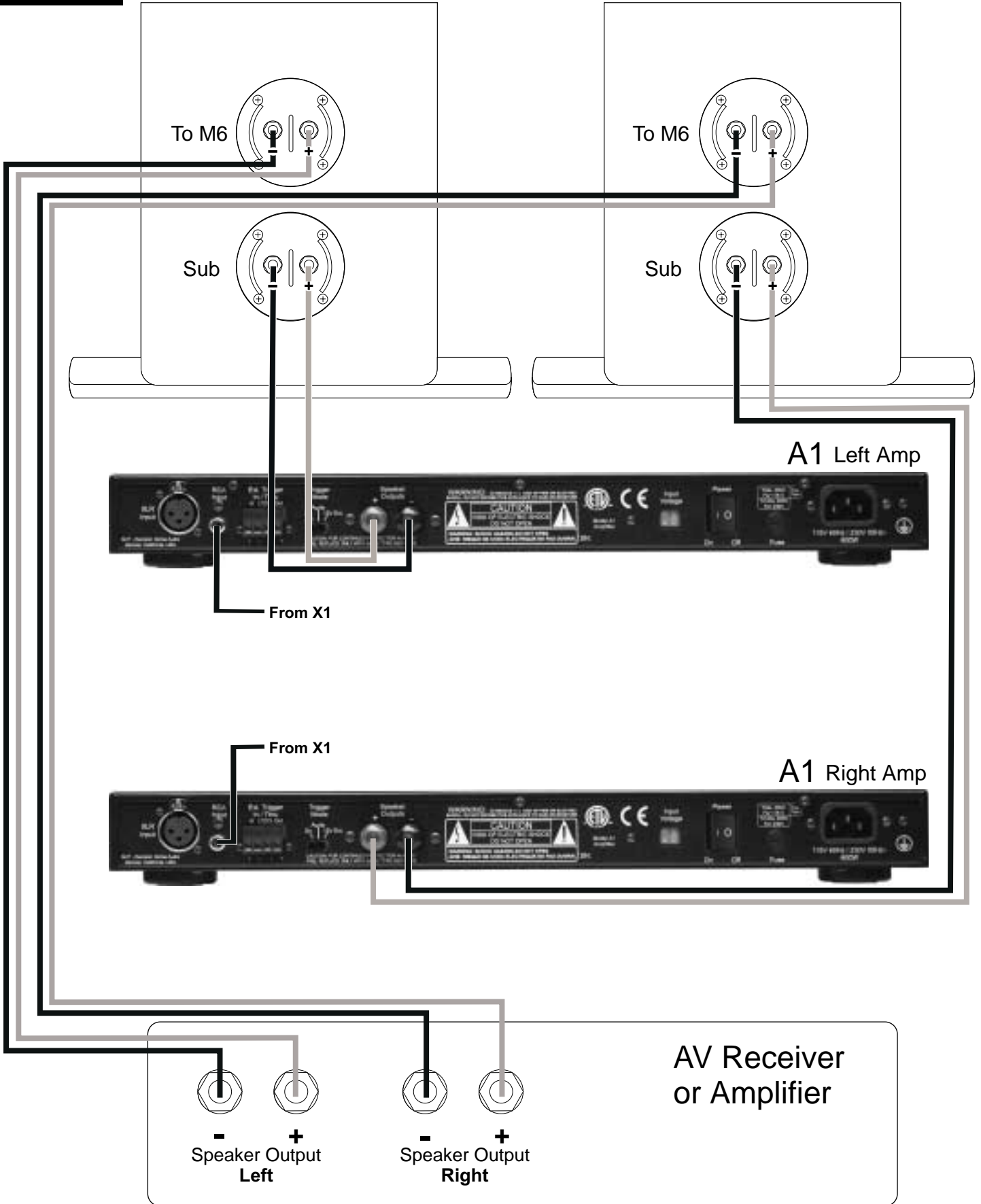

6.0 Connecting Evolution Electronics to Your System.

There are a number of methods by which you can connect the X1 Active Crossover and A1 Amplifier to the rest of your system. The method you choose will be determined largely by the surround components in your system. This becomes particularly important in the management of bass frequencies. The Evolution electronics were designed with flexibility and compatibility in mind.

The following section will take you through the steps in making the final connections in your system. If for some reason the methods described in this Owner's Manual don't work properly in your system, consult your NHT dealer or call us at 1-800-NHT-9993 (648-9993)

6.1 Signal Connections

Review the following connection method descriptions and use the one that describes your surround receiver or processor:

Method 1 - Use if there is a Subwoofer Output (sometimes labeled "LFE") on your AV Receiver.

Method 2 - Use if there is a pre-amp out/main in section on your AV Receiver.

Method 3 - Use this method if have a separate Surround Processor and Amplifier(s).

Method 1

Integrating the X1 into your surround system is simple and straightforward when using this connection method. Your AV Receiver will control all crossover functions and the X1 will control gain, phase and boundary equalization (see 8.3 below).

Connect the Subwoofer/LFE Output on your AV Receiver to the LFE IN on the X1 active crossover.

Method 1 - Recommended Surround Settings

We recommend setting the speaker size in your processor or receiver to "small" when using either the M5 or M6 monitors. The "small" set-

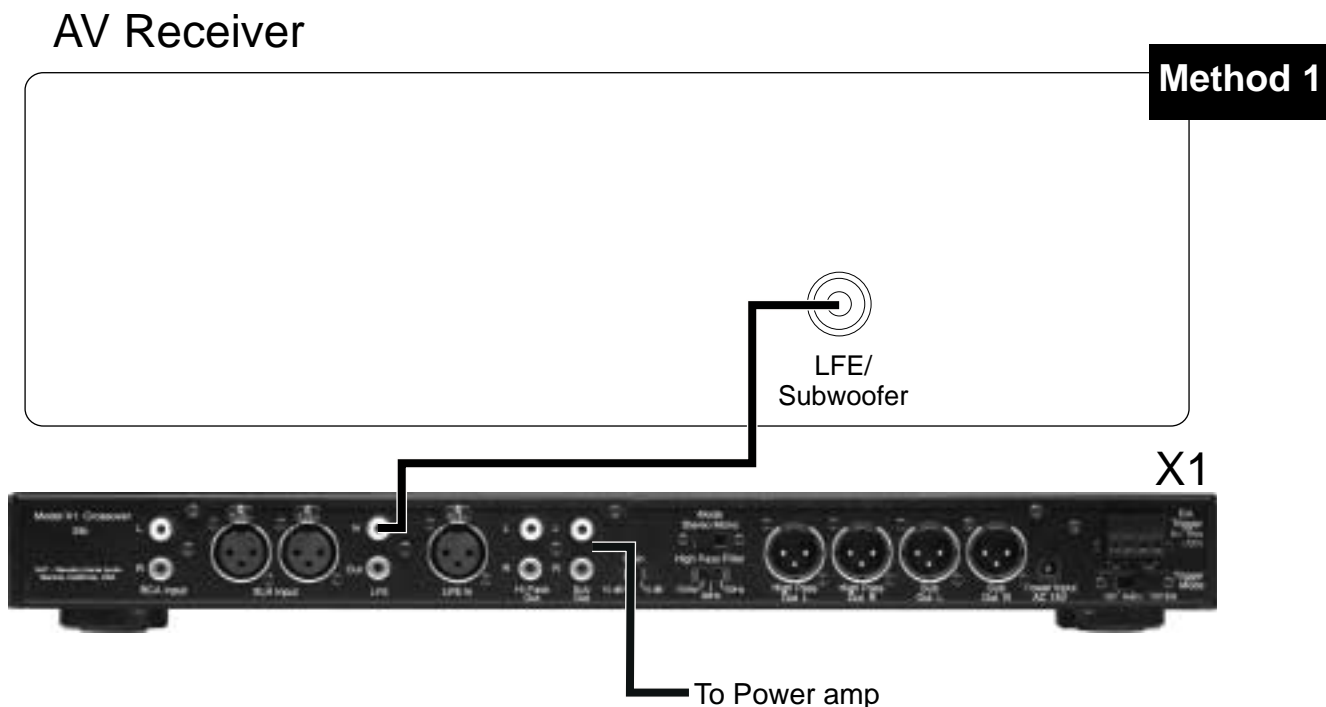

ting will prevent low bass frequencies from reaching the Monitors. The removal of the low bass will make integration of the Monitors with your Evolution subwoofer easier and has the additional benefit of increasing the Monitor's dynamic range and power handling capability.

Method 2

This is the connection method to use if your AV Receiver has a pre-amp out/main in section. This connection method is preferred over Method 1.

- Remove the jumper connections between the pre-amp L/R front outputs and the main L/R inputs.
- Connect the Left and Right pre-amp outputs from your AV Receiver to the Left and Right inputs on the X1.
- Connect the Left and Right Hi Pass outputs from the X1 to the Left and Right main inputs on your AV Receiver.
- Connect a single cable from the Subwoofer/LFE output on the AV Receiver to the LFE input on the X1.

- Finally, using another single cable, connect one of the Sub outputs on the X1 to the input on the A-1. Set the mode switch on the X1 to Mono.

Note: If you are using two A1 amplifiers for stereo bass, as with the T6 tower system, set the mode switch on the X1 to Stereo and use the remaining Sub output on the X1 and connect to the input on the second A1. Make sure the left and right channels are wired correctly.

Method 2 - Recommended Surround Settings

Set your Left and Right front speakers to "large" in your AV receiver. Set all other speakers that are not capable of producing low bass frequencies to "small". The "large" setting will send a full range signal to the X1. The Hi Pass and Lo Pass controls on the X1 crossover will then be used to set the crossover frequencies for the front L and R monitors and the subwoofer (see section 7). The Subwoofer(s) receive bass information from the front Left and Right channels and the Subwoofer/LFE output (see section 8.3).

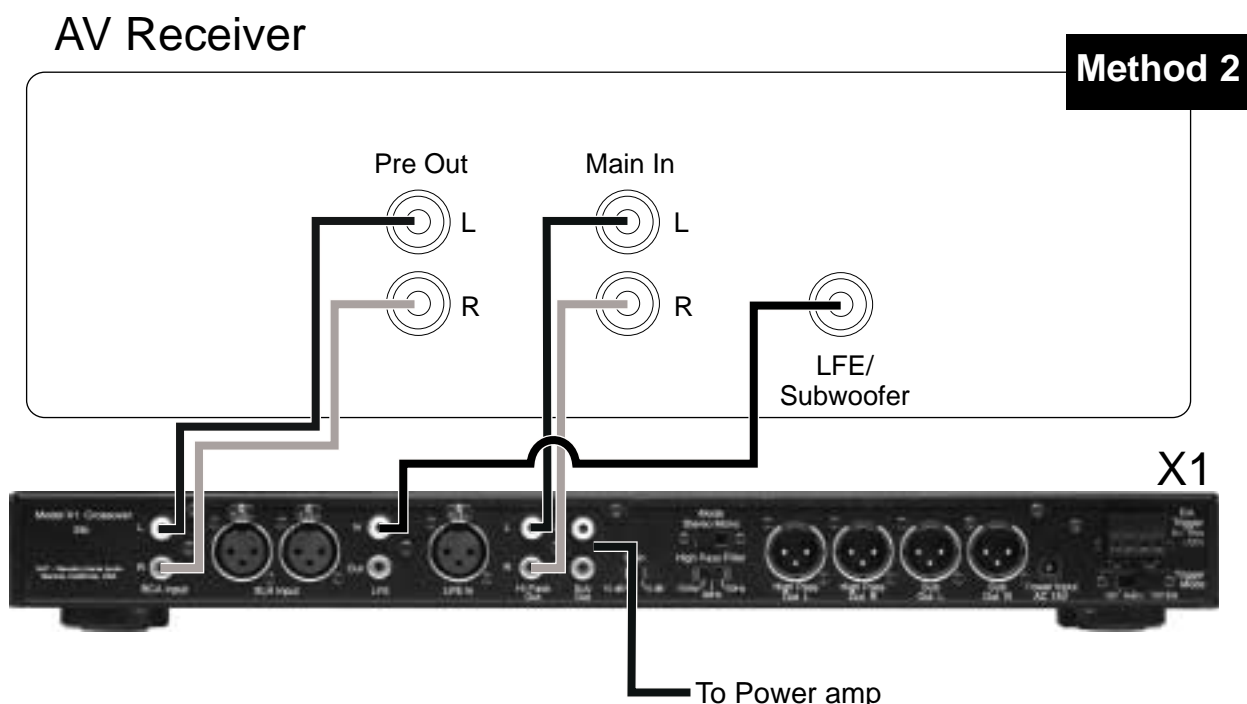

Method 3

Use this connection method if you have a separate Surround Processor and Amplifier(s).

- Connect the front Left and Right pre-amp outputs from your Surround Processor to the Left and Right inputs on the X1.
- Connect the Left and Right Hi Pass outputs on the X1 to inputs of the amplifier that is driving the front Left and front Right speakers.
- Using a single cable, connect the Subwoofer/LFE output from the Surround Processor to the LFE input on the X1.

Method 3 - Recommended Surround Settings

Set your Left and Right front speakers to “large” on your AV receiver. Set all other speakers that are not capable of producing low bass frequencies to “small”. The “large” setting will send a full range signal to the X1. You will then use the Hi Pass and Lo Pass controls on the X1 to set the crossover points for the front monitors and the subwoofer (see section 7). The Subwoofer receives bass information from the front Left and Right channels and the Subwoofer/LFE output (see section 8.3).

Note when using methods #2 and #3: Some Surround Processors and AV Receivers offer an additional LFE/Subwoofer setting, often referred to as “Extended Bass” or “Reinforced Bass”. If your equipment offers this option we strongly recommend that you do not select it. The X1 processor will automatically sum the LFE channel with the left and right subwoofer information.

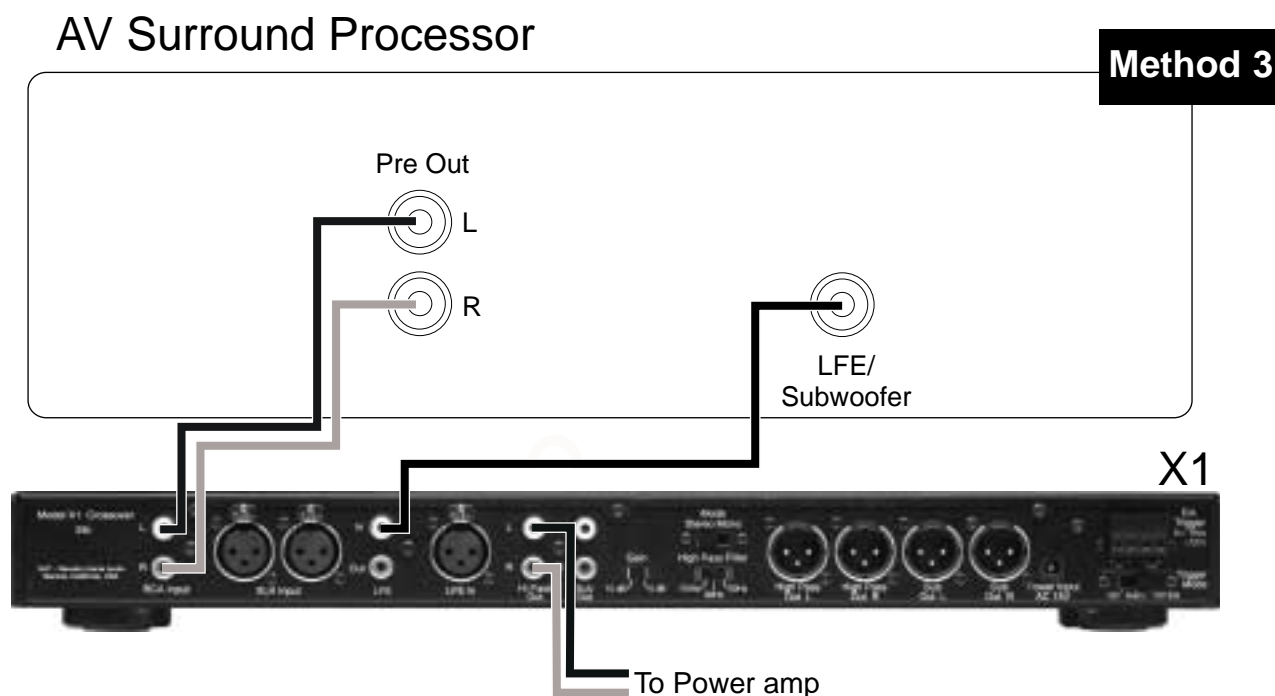

6.2 Power Connections

The X1 crossover receives power via the LL-1 power supply.



The A1 amplifier receives power via the detachable IEC style power cord.

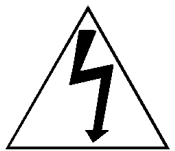
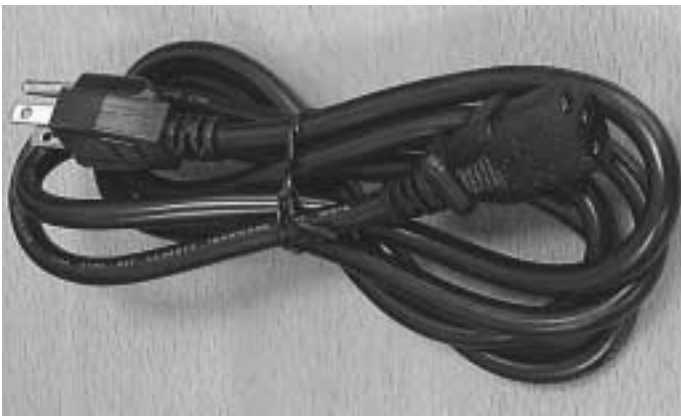

Caution: Prior to connecting the A1 amplifier to your audio system, make sure that all your other electronic equipment is turned off or unplugged.

7.0 Basic Settings for the X1 Active Crossover

The following diagrams will provide starting points for each control feature on the X1. The diagrams are organized by Evolution model. Begin with these basic settings and then move to Section 8 which describes each X1 control function in detail and provides advice for fine tuning the X1 to your listening room.

Note: If you are using main speakers other than Evolution, use the initial settings described for the U1 or U2 subwoofer.

U1

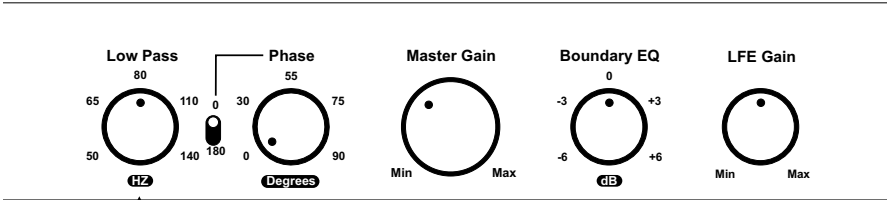

Not used in Method #1

One W1 = Mono
Two W1 = Stereo

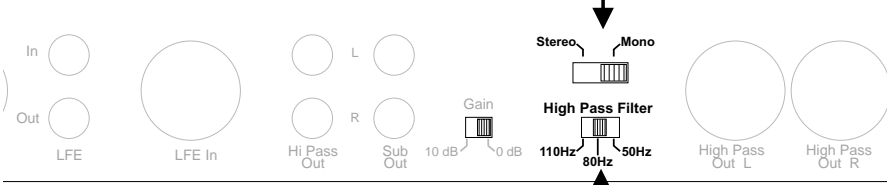

M5 or M6
Not used in Method #1

U2

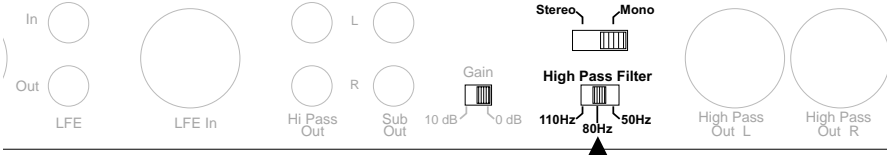
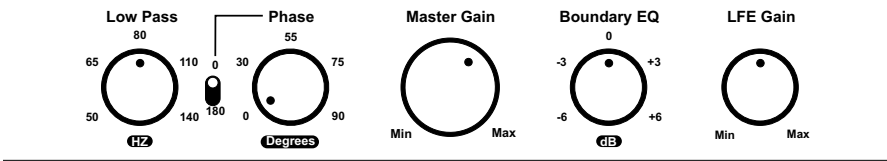

M5 or M6
Not used in Method #1





T6

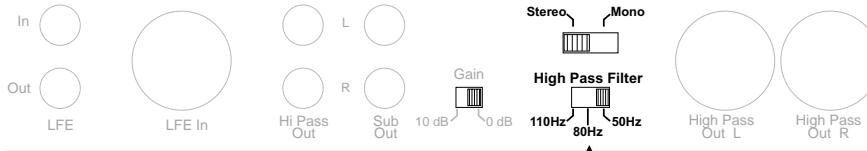

Not used in Method #1



8.0 X1 Active Crossover

8.1 Design

The NHT X1 active crossover is designed to provide convenient front-panel adjustment of the controls necessary to integrate the Evolution subwoofers with Evolution Monitors or other satellites. It also provides unbalanced RCA and differential balanced XLR inputs and outputs for connection with all types of receivers or separate audio components.

NOTE: The X1 contains special equalization circuitry specifically designed for Evolution subwoofers and tower bass modules only. Do not use with non-Evolution subwoofers.

The X1 Active Crossover can operate as either a mono (single channel) or stereo unit. In the stereo mode, you may add an additional subwoofer without purchasing an additional crossover. Two subwoofers can be used for stereo bass (which is desirable for music reproduction) or for additional mono bass reinforcement (for movie soundtracks).

Note: Do not use both the unbalanced (RCA) and balanced (XLR) inputs at the same time. The unbalanced (RCA) and balanced (XLR) outputs are buffered separately and may be used simultaneously.

8.2 Placement

The X1 Crossover may be used on a shelf, or in a standard 19" equipment rack using the optional rack ears and hardware. See section 10.3 for instructions on rack mounting.

Ideally, the X1 should be placed in close proximity to the receiver or surround processor. Minimizing cable lengths reduces the chance of noise contamination. If long runs (more than 20 feet) of signal cables are required, we recommend using the balanced (XLR) inputs and outputs on the crossover.

If you are using the X1 in combination with the Evolution A1 amplifier, we recommend that you place the X1 underneath the A1 amplifier. Or, in a stereo configuration, place the X1 between two A1 amplifiers. The A1's are equipped with lamps under the front edge, which illuminate the X1 controls. See section 9.2 for more detail.

8.3 X1 Features and Controls

This section describes the various controls and functions of the X1. Make sure that your X1 controls initially are set as described in Section 7 for your Evolution model before continuing.

Power/Standby Mode (Rear Panel)

Your X1 crossover does not have a power switch but has been designed with the ability to turn on and off under various conditions. There are three methods for activating the X1.

Once the X1 is plugged into the wall outlet it is on - there is no main power switch. The X1 has a standby mode that can be trig-



gered internally or externally. On the rear panel of the X1 is a 3-position switch that determines the trigger mode:

- 1) On; the X1 is always on.
- 2) Audio; the X1 will automatically turn on when it detects an audio signal and turn off after 20 minutes with no signal.
- 3) 12V Ext; the X1 can be remotely turned on or off when it detects a DC control signal from another component in your system. The external trigger will accept 5 - 24 volt (DC) signals. For more information regarding external triggers, consult your authorized dealer.

Master Gain (Front Panel)

The Master Gain control allows you to adjust the volume of the subwoofer relative to the monitors. Use the Master Gain judiciously. A properly calibrated subwoofer blends seamlessly with the Monitors or satellites without calling attention to itself. Here are some general guidelines for setting the Master Gain control:



Begin by playing some stereo music you are familiar with. Set your AV Receiver or Surround Processor volume to a comfortable listening level. Slowly increase or decrease the Master Gain on the X1 crossover, listening for a natural frequency balance between the subwoofer (or tower bass module) and the front left and right monitors. When properly balanced, you will hear natural bass extension, without being aware that it is coming directly from the subwoofer.

Once the Master Gain is set, the volume control on your AV Receiver or Surround Processor will control the volume of your entire system, including the subwoofer.

LFE Gain Control (Front Panel)



LFE is short for 'Low Frequency Effects'. Low Frequency Effects originally were low frequency sounds added to movie soundtracks in order to increase their impact. For consumer electronics, there is no standard concerning what type of signal might be present on the LFE channel. Therefore, we have added an LFE input and gain control to the X1 so that you can integrate whatever is present on the LFE channel with the signal being reproduced by the rest of the system.

After you have set the Master Gain level as described above, play a multi-channel signal through your system (as from a movie). Sources with lots of bass output will be the most useful. Adjust the LFE gain control until the bass produced by the subwoofer reaches the desired level. Most users initially set the level of the LFE gain control at too high a level, so be prepared to adjust the control over a long period of time. You have reached an appropriate level setting when movies soundtracks have impact and music sources have punchy bass, but the overall character of the bass produced by the subwoofer is not thick and ill defined.

The level of the signal on the LFE channel varies considerably from source to source, so you may need to use the LFE level trim featured in most receivers and processors to adjust the LFE level on a source-by-source basis.

There is an LFE "Thru" output on the back of the X1. For more information concerning the use of this output, visit our website, www.nhthifi.com/technicalhelp/evolution.

High Pass Filter Switch (Rear Panel) - Connection Method 2 and 3 Only



Note: If you are using Connection Method #1, the X1 High Pass Filter is not in the circuit path. Your monitors will reproduce the frequency range selected by your AV Receiver.

The High Pass Filter determines the range of frequencies that the main speakers ("satellites") will reproduce. For example, a high pass setting of 80Hz means that the main speakers receive a signal containing only frequencies above 80Hz. The 3-position High Pass Filter is selectable between 50Hz, 80Hz, and 110Hz to accommodate a variety of speaker sizes.

If you are using Evolution monitors, the setting for this control shown in Section 7 should be sufficient. If using speakers other than Evolution monitors and Connection Methods 2 or 3, use the guidelines below.

Set the High Pass Filter to a frequency above the rated low frequency limit of the main speakers. For example, if your speakers have a rated low frequency response of 40Hz, use the 50Hz high-pass setting. If your speakers have a rated low frequency response of 90Hz, use the 110Hz high-pass setting. Check the owner's manual for their rated low frequency response.

Low Pass Filter Control (Front Panel) - Connection Methods 2 and 3 Only



The continuously variable Low Pass Filter determines the range of frequencies produced by the subwoofer. For example, a low pass setting of 100Hz means that the subwoofer reproduces only frequencies below

100Hz. The LFE input is not affected by this control.

Adjust the Low Pass Filter to approximately the same setting as the High Pass Filter as a starting point. Adjust the Low Pass Filter in small increments up or down until the blend between the Evolution Subwoofer and your main speakers is seamless and the subwoofer does not call attention to itself. Music featuring male vocals, cello and acoustic bass, bass guitar and certain wind instruments (like saxophone and trombone) is useful for setting the low pass frequency.

Phase Controls (Front Panel)

The Subwoofer Phase switch and continuously variable knob set the phase of the subwoofer output anywhere from 0° to 270° relative to the high pass output. Proper subwoofer phase is important in achieving smooth bass response. An improper phase setting can cause large peaks and dips in the frequency response of the combined subwoofer/satellite system at the listening position. The result of the peaks and dips is low frequency production that is very pronounced at certain frequencies and a lack of seamless integration between the satellites and subwoofer.



The optimal phase setting will differ according to room conditions and placement. While fine tuning phase settings, have a familiar stereo CD available. You should listen to the same song while alternating phase settings. Find the best setting while sitting at the primary listening position.

The initial settings described in Section 7 should be an adequate starting place for your Evolution

system. However, if you want to experiment or are using main speakers other than Evolution Monitors, use the following procedure: Begin by setting the phase knob at 0°, alternating the switch position between 0° and 180°. From the listening position, choose the switch position that yields the most bass output and leave the switch there. Then use the knob to fine-tune the phase setting. Slowly twist the knob, listening for the point at which the bass at the listening position is the loudest. Small changes in phase generally produce subtle changes in bass output. You may have to adjust the knob now and again over a period of a few weeks to find the best setting for your listening room.



Gain Switch (Rear Panel)

The Subwoofer Gain switch allows you to increase the gain of the X1 subwoofer output by 10dB. Normally, the factory default "0" position will give you a wide range of volume adjustment. However, if the sensitivity of your satellite speakers is greater than 93dB, your range of volume adjustment on the X1 may be limited. In this case, set the Gain Switch to 10dB.

Boundary EQ (Front Panel)

The Boundary EQ is a feature unique to NHT Evolution products. Reflective boundaries (such as walls) reinforce a speaker's bass output (3dB for two walls, 6dB for a corner) if the subwoofer is placed near them. Conversely, placing a subwoofer out in the room results in a relative decrease of bass output. Boundary reinforcement may lead to low frequency response that is uneven. Some frequencies will sound exaggerated relative to others, or the subwoofer will sound thin and lack impact. The Boundary EQ control allows you to compensate for the effects of room boundaries on the frequency response

of the subwoofer. Adjusting the control enables you to achieve smooth low frequency output from the subwoofer regardless of its location in your room.

The following diagrams show the correlation between subwoofer placement and Boundary EQ. These diagrams are guidelines only. Your room acoustics and personal tastes will ultimately dictate the final setting.

Half Space		
Whole Space		
Quarter Space		
Quarter/ Half Space		
Half/ Whole Space		

8.4 System Status Indicators (Front Panel)



Located on the right hand side of the front panel are two LEDs. They are used to indicate the functional status of the X1 Crossover.

P - Power LED (green) - indicates the X1 is on and in a ready condition.

S - Standby LED (amber) - indicates the X1 crossover is in "standby" mode.

8.5 Fine Tuning Chart

The chart below was developed to assist you in the further fine tuning of your subwoofer or tower system. Should you be unable to achieve satisfactory performance from your Evolution subwoofer system using the fine-tuning chart, contact your authorized NHT dealer or call our Customer Hotline at 1-800-NHT-9993 (648-9993).

Fine Tuning Flow Chart

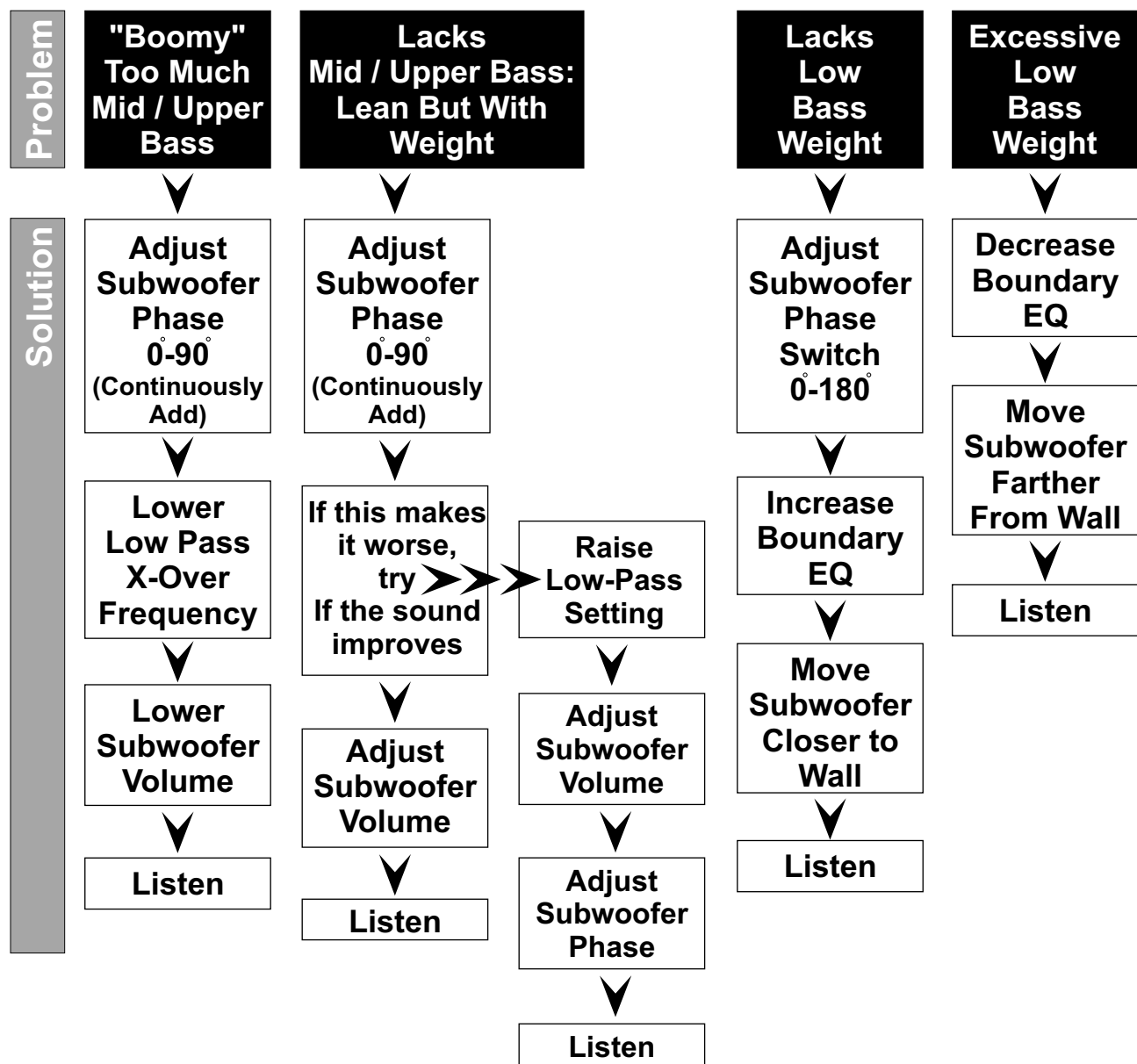



9.0 A1 Monaural Amplifier

9.1 Design

The A1 is a full range (20Hz - 20kHz) audio power amplifier. It provides RCA and XLR inputs for connection with all types of receivers or separate audio components. The A1 is a single channel or monaural amplifier and can be used with Evolution subwoofer and tower products or to power individual Evolution monitors.

The A1 is a Class G design, which operates at lower temperatures than other amplifier classes and is typically more efficient. The A1 offers the wide dynamic range and low distortion typical of more conventional class AB designs.

9.2 Placement

The A1 amplifier may be placed on a shelf, or in a standard 19" equipment rack using the optional rack ears and hardware. See instructions on rack mounting below.

Ideally, the A1 should be placed in close proximity to the receiver or surround processor. Minimizing cable lengths reduces the chance of noise contamination. If long runs (more than 20') of signal cable are required we recommend using the balanced (XLR) input on the amplifier.

9.3 Rack Mounting the A1 and or X1

You may need assistance to hold the A1 or X1 in place while mounting them to the rack.

Note: When rack mounting, we recommend you leave at least one rack space between components (particularly amplifiers) for proper cooling.

Step One: Remove the two screws on each side of the X1 or A1 with the #2 Phillips screwdriver.



Step Two: Position the rack ears over the threaded holes. Replace the two screws and tighten both securely.

Step Three: Arrange the mounting screws included with the rack ears and the plastic insulating washers as shown.

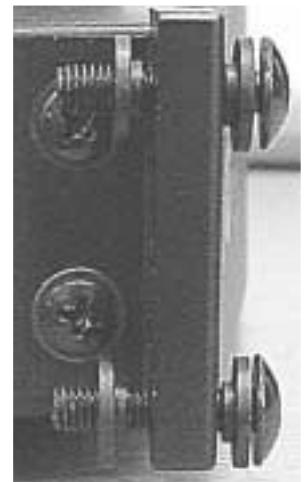

Step Four: Start all four bolts, then tighten securely.

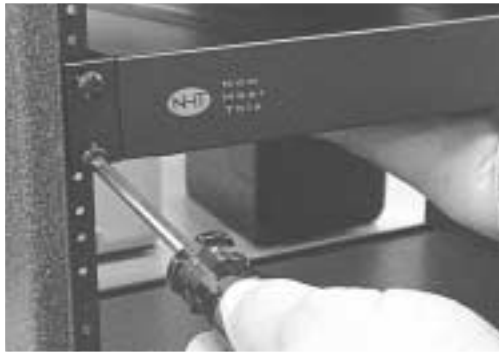

9.4 Power/Standby Mode

The main power switch for the A1 is located on the rear panel and does not normally need to be used. The A1 has a standby mode that can be triggered internally or externally. On the rear panel of the A1 is a 3-position switch that determines the trigger mode:

- 1) On: The A1 is always on.
- 2) Audio: The A1 will automatically turn on when it detects an audio signal and turn off after 20 minutes with no signal.
- 3) 12V Ext: The A1 can be remotely turned on or off when it detects a DC control signal from another component in your system. The external trigger will accept 5 - 24 volt (DC) signals. For more information regarding external triggers, consult your authorized dealer.



9.5 A1 Courtesy Lights

The A1 amplifier is equipped with courtesy lights to illuminate the controls of the X1. This feature is controlled by a 3-position switch for HI, LO and OFF that can be accessed from the bottom of the amplifier just behind the center of the front panel. The A1 courtesy lights are set in the HI position at the factory.



To adjust intensity or turn off the lights, unplug the A1 from the wall. Use a small flat blade screwdriver and move the switch according to the diagram. The courtesy lights will shutoff automatically when the amplifier is in "standby" mode.

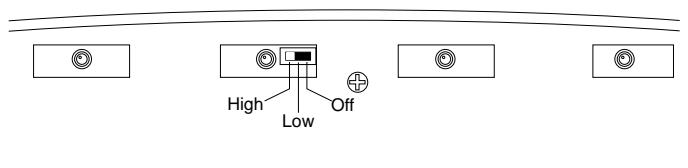
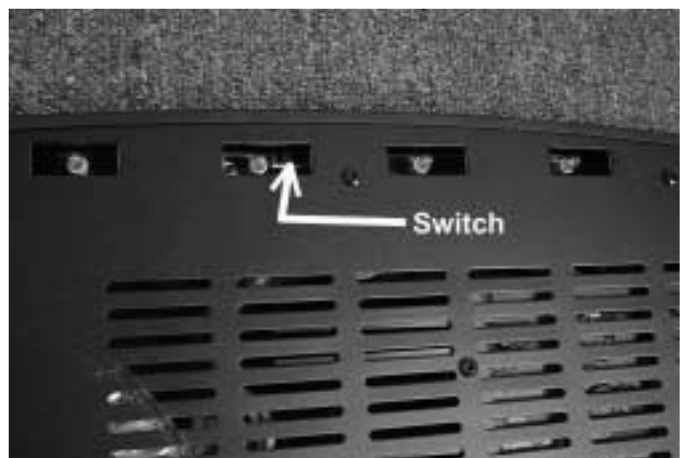

9.6 System Status Indicators

Located on the right hand side of the front panel are three LEDs. They are used to indicate the status of the A1 amplifier.

P - Power LED (green) - indicates the A1 amplifier is on and in a ready condition.

S - Standby LED (amber) - indicates the A1 amplifier is in "standby" mode.

F - Fault/Protection LED (red) - indicates the A1 amplifier is in a shutdown condition.



Fault/Protection: The A1 can shutdown in Protection mode for several reasons. A common reason is that the speaker output wires have shorted together. Another could be that the amplifier has overheated. Should either of these conditions occur, repairing the cause of the output short or allowing the amplifier to cool will solve the problem. To reset the A1, turn the power switch (rear panel) off and then on. If the problem persists, contact your NHT dealer.

9.7 Replacing the Fuse

The A1 amplifier's fuse is user-serviceable.

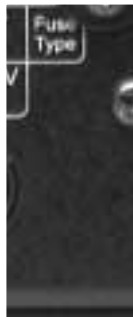

To replace the fuse:

1. Turn the power off.
2. UNPLUG the power cord.
3. Remove the fuse holder cover (next to power cord) with a flat blade screwdriver.
4. Remove the fuse from holder and replace it with the appropriate type.
5. Reinstall fuse holder.

Always replace the fuse with one of the exact same specifications.

For systems operating at 115VAC, use only a 5x20 mm, T5AL, 250V slow-blow fuse.

For systems operating at 230VAC, use only a 5x20mm, T2.5AL, 250V slow-blow fuse.

9.8 Changing the Line Voltage Setting

The A1 was designed to operate on two line voltage settings, 115VAC and 230VAC. In the event that it is necessary to change the line voltage setting, begin by turning the power switch to the off position. Remove all the connections from the amplifier, including the detachable power cord. Using a flat blade screwdriver, slide the switch to the correct position. Use the 115VAC position for 110 to 120 VAC, and the 230VAC position for 220 to 240 VAC. Next you will likely need a power cord that fits the AC receptacle and you will need to replace the fuse (see "Changing the Fuse" above)

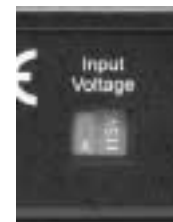

10.0 Maintaining your system

Your NHT Evolution speakers and electronics require minimal maintenance under normal use. The cabinet may be cleaned using a soft cloth. There is usually no need to use fluids such as cleaners or wax to clean the surface of the speakers. The durable lacquer finish is designed for minimal maintenance. To clean the grille, first remove it from the speaker, then brush lightly with a soft brush or use a vacuum on its lowest setting. Do not attempt to clean the actual drivers. To remove dust, you may use a feather duster. Do not expose the speakers to direct sunlight, high temperatures, or moisture.

Electronic components should be wiped with a dry, soft cloth to remove dust. Do not use any liquid near or on the electronics as it may cause electrical shock.

11.0 Evolution Technology

11.1 Monitor Technology

NHT chose the word Evolution to describe our new products for two reasons. Evolution represents our belief that loudspeaker design must evolve to meet the requirements of multi-channel, digital media both technologically and ergonomically. Secondly, it represents the evolution of the fundamental technologies unique to NHT over our 15-year history.

The simple, elegant lines of our Evolution loudspeakers and subwoofers belie the tremendous amount of technology built into them. This section describes the attention to detail and high performance contained in this unique collection.

Inside the Evolution Monitors:

Both the M5 and M6, while offering different driver compliments, offer similar performance. The distinguishing characteristic between the two monitors is how loud they will play; the M5 is designed for small to medium sized rooms, the M6 for large rooms. The construction methods and internal technological features that deliver such high performance are the same.

A View Inside an Evolution Monitor

A) The cabinet is constructed of 3/4" MDF. Lamination on the inside increases structural rigidity.

B) Where necessary the cabinets are braced to minimizing unwanted resonances.

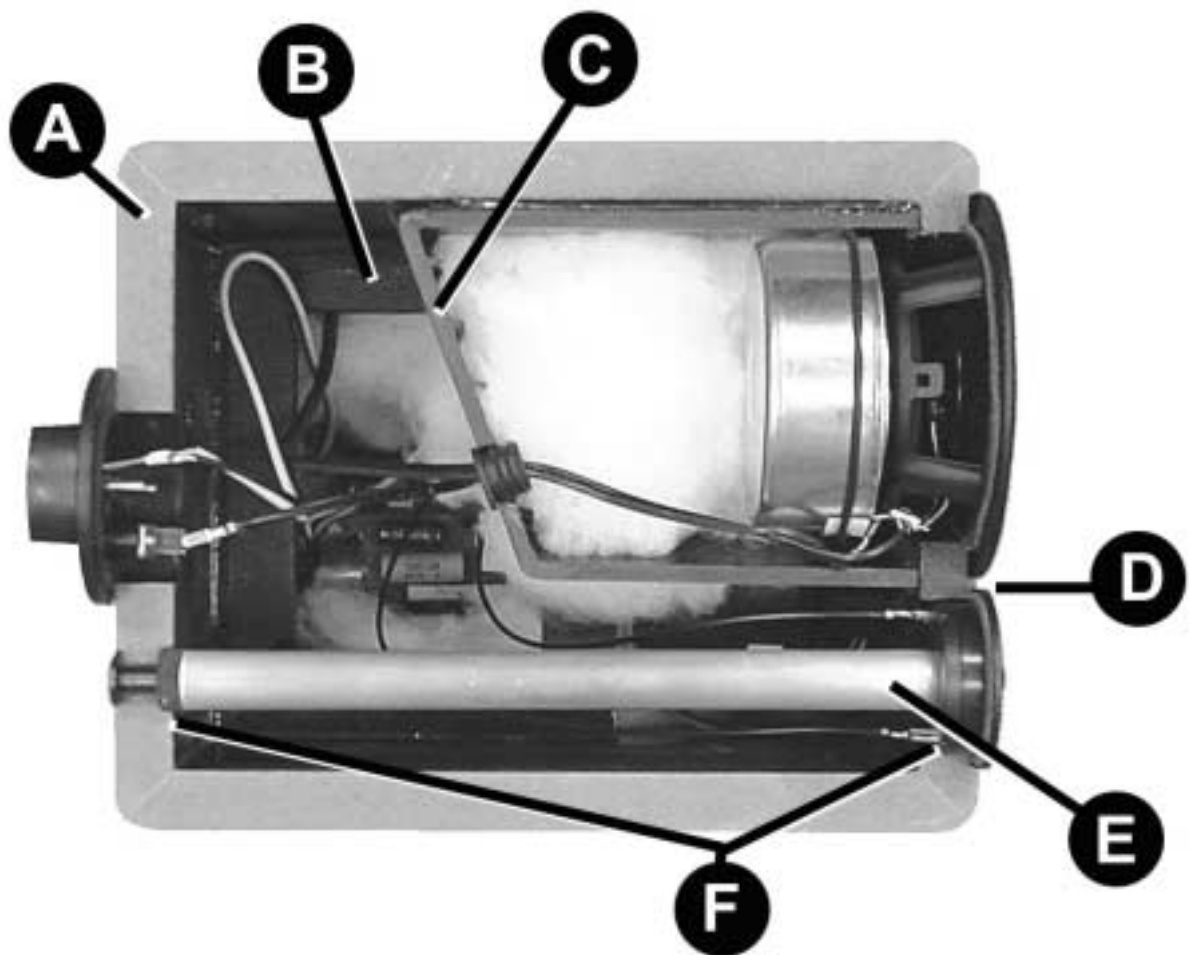

C) The internal midrange chamber features non-parallel internal surfaces that randomize standing waves, eliminating comb-filtering and improving clarity and detail. The chamber is also sized to the midrange driver so that it is acoustically small. This further reduces the possibility of standing waves.

D) The small footprint of the Neodymium tweeter allows closer placement to the midrange driver, improving mid-range coherence.

E) The tweeter is mounted to a solid aluminum "Wonder" bar that acts as a massive heatsink, providing high power handling and less power compression.

F) The Wonder Bar is mounted to the tweeter from the rear of the cabinet, further increasing cabinet rigidity.

Evolution incorporates a "virtual" adaptation of F.I.G. Rather than an angled cabinet, we increase the energy at the listening position using the crossover.

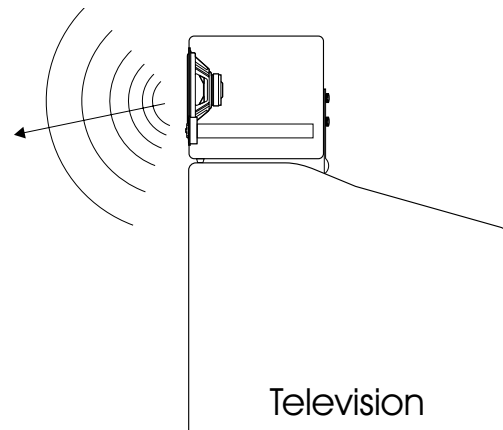

When Evolution monitors are vertically oriented and the tweeters on the inside edge of the cabinet the null created in the crossover between the mid and high frequency drivers is directed at the sidewalls. The graph below shows the decrease in energy, or reflected sound towards the wall (C) and the compared to the direct sound radiating at listening area (A & B). This improves detail and provides a 3-dimensional soundstage.

11.2 What is "Virtual" Focused Image Geometry?

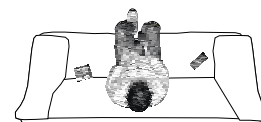
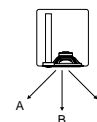
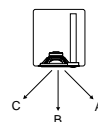
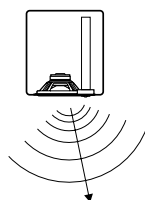

NHT's hallmark for many years was a uniquely angled which we described as Focused Image Geometry (F.I.G.). The angled cabinet focused the mid-range and high frequencies into the listening room and away from room boundaries increasing the ratio of direct to reflected sound. This resulted in loudspeakers systems universally praised for their imaging and detail to a wide listening area.

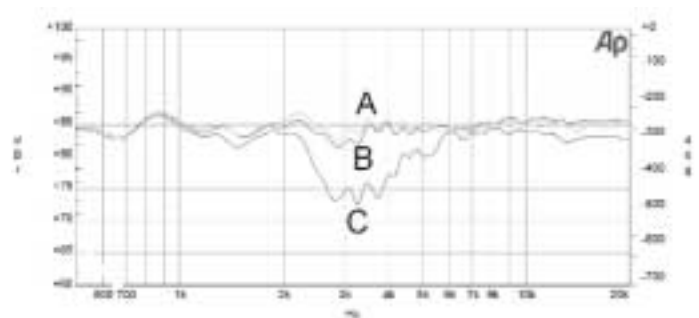

When oriented horizontally, the null is directed at the ceiling or floor (depending on tweeter position) improving mid-range detail.

11.3 Boundary Switch

A loudspeaker's mid-bass response is very dependant on its room placement. For example, if a speaker is tuned for placement away from walls and is then placed on a bookshelf, the reinforcement of mid-bass frequencies will make the speaker sound somewhat "thick". The M5 and M6 feature a unique dual mode crossover that adjusts the monitor's response in the mid-bass range for either placement situation. The graph below illustrates the decrease in bass energy from 80Hz to 500Hz when the switch is in the "1" position, making placement on a shelf or television possible while maintaining proper frequency response. The "0" position optimizes the monitor for placement away from room boundaries.

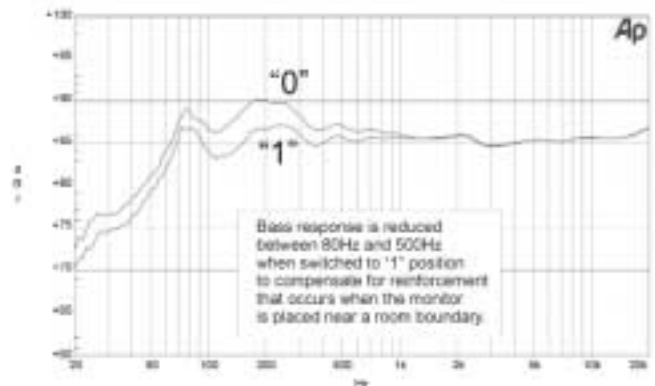
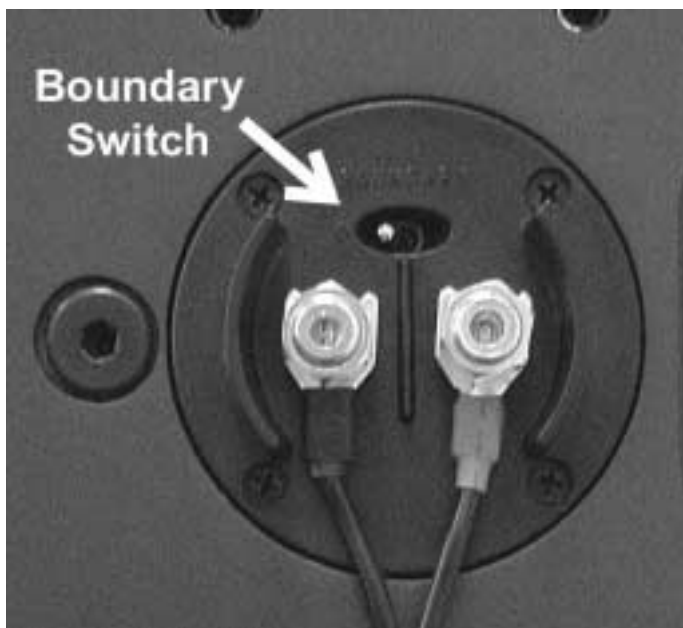

11.4 High Dynamic Range/Low Power Compression

The increased dynamic range of digital media can make much greater demands on the output capabilities of speakers than in the past. As speakers are pushed towards their limits, the temperature of the drivers rises. Heat causes the drivers impedance (resistance to AC current flow) to increase, reducing the amount of power the amplifier can deliver to the driver. Dynamic range is reduced, distortion increases and sound quality suffers.

Evolution monitors and subwoofers are designed to minimize this phenomena in a number of important ways.

- 1) The 12" woofer contained in all Evolution subwoofers and tower bass modules employs, in addition to a massive motor structure, an aluminum cone attached to an aluminum former. The cone acts as a heat sink for the driver, minimizing the rise in impedance and resulting distortion.
- 2) The Wonder Bar, mounted to the tweeters in the Evolution monitors, dissipates heat from the most fragile driver in any loudspeaker.
- 3) Evolution monitors are 3-way systems with dual woofers. The input power is spread over multiple drivers, minimizing heat build up and distortion.

11.5 Orientation Independent Dispersion

The Evolution monitors are optimized for use in either a horizontal or vertical orientation. This is achieved by means of the relative placement, size and crossover frequencies of the drivers. The very small separation between the midrange and tweeter drivers allows dispersion that is very wide and well controlled. When combined with the low crossover frequency between the woofers and midrange, the resulting sound-field permits the speaker to be used in a horizontal or vertical orientation without significant changes in frequency response and imaging characteristics.

12.0 Glossary of Terms

Active: Uses electrical power.

Amplifier: An electronic device that increases the current and/or voltage of a signal, providing power to the loudspeakers (i.e. power amplifier, integrated amplifier, receiver).

Bass: The range of audio frequencies below 160Hz, characterized by low pitch.

Crossover: An electronic circuit that divides an audio signal into different frequency ranges.

Distortion: Any deviation from the original signal.

Driver: The moving part of a loudspeaker, which radiates sound energy.

Dynamics: Variations in loudness of sound.

Frequency: A rate of vibration, which corresponds to musical pitch, expressed in Hertz (Hz).

Low Bass	Mid Bass	Upper Bass	Lower Mid	Mid	Upper Mid	High
Below 50Hz	50Hz ↓ 100Hz	100Hz ↓ 180Hz	180Hz ↓ 300Hz	300Hz ↓ 700Hz	700Hz ↓ 3KHz	3KHz and Above

Full Range: A signal encompassing the entire frequency spectrum.

Hertz (Hz): A unit equal to one cycle per second, used to measure the frequency of a signal or sound.

High-Pass Filter: A filter that passes only high frequencies above a lower limit.

Impedance: A measure of the total opposition to current flow in an alternating current circuit, measured in ohms.

In Phase: The polarity of an audio signal when connected as follows: (+) to (+) and (-) to (-).

Integrated Amplifier: A preamplifier and amplifier built into one chassis.

Interconnect Cable: A length of shielded wire with plugs at both ends for feeding signals from one electronic device to another.

L.F.E.: "Low Frequency Effects"; The .1 channel

of information recorded on most multichannel digital sound formats.

Line-Level Connection: Low level RCA/phono or XLR type connection.

Load: A term used to describe the impedance that a speaker presents to an amplifier.

Low-Pass Filter: A filter that passes only low frequencies below a higher limit.

Main Speakers: Front L & R channel speakers, sometimes referred to as satellites.

Main-In: A line-level RCA/XLR power amplifier input on the back of a receiver, integrated amplifier or power amplifier.

Midrange: The frequency span in the middle of the audio range, roughly 160Hz - 1300Hz. Also used to describe the driver that reproduces these frequencies.

Ohm: A unit of electrical resistance. That which opposes an electric current in a conductor. In audio, a measure of the load presented by a device to an electrical source.

Out-of-Phase: The polarity of an audio signal when connected as follows: (+) to (-) and (-) to (+).

Passive: Uses no electrical power.

Phase: An expression of the relative polarities of two signals.

Power Handling: The ability of a loudspeaker to operate without large increases in distortion when given varying amounts of input power.

Preamplifier: An electronic device that selects sources and passes line-level signals to an amplifier.

Pre-Out: A preamp line-level RCA output on the back of a receiver, integrated amplifier or pre-amplifier.

Receiver: A preamplifier, amplifier and tuner built into one chassis.

Satellite: Front L & R speakers when used with a subwoofer. Referred to as "main speakers".

Sensitivity: A ratio of voltage across the speaker load to the acoustic power output, measured

in decibels.

Sub Out: An line level output for connection to a subwoofer or subwoofer signal processor.

Subwoofer: A driver designed to operate over the low bass portion of the audio range. Also refers to a system consisting of a woofer and its enclosure, which are physically separate from the upper range loudspeakers.

Surround Speakers: Speakers located in the side or rear for surround channel effects.

Treble: The upper part of the frequency spectrum, consisting of frequencies above about 1300Hz.

Tweeter: A small driver designed to reproduce high frequencies.

Watt: A measure of electrical power, combining the voltage with the electrical current required to drive the loudspeaker.

Weight: Low frequencies below 50Hz.

Woofer: A driver designed to operate over the bass portion of the audio range.

13.0 Trouble Shooting

Problem	What To Do
Unit fails to illuminate when the power is connected.	<ol style="list-style-type: none">1) Check to see if your AC outlet has power.2) X1 protection fuse may be blown and needs to be replaced. Contact your NHT dealer for assistance.3) A1 protection fuse may be blown and needs to be replaced. See section 10.6 changing the fuse.
Unit has no sound output	<ol style="list-style-type: none">1) Verify that the 'P' (Green) LED is illuminated.2) If only the 'S' (Amber) LED is illuminated verify that the trigger mode switch is in the 'Audio' position.3) If the trigger mode switch is in the '12V Ext' position make sure there is 12VDC signal present.4) Verify system hookup is correct and your unit is receiving signal.5) (A1 Only) If the 'F' fault (RED) LED is illuminated, check for shorted speaker wires. Turn unit off/on to reset.

14.0 Specifications

A1 Amplifier

Frequency response: 10Hz - 65KHz +/-3.0 dB

20Hz - 20KHz +/- 0.5 dB

Distortion: <0.01% 20Hz-1KHz

< 0.075% 10Hz - 20Khz

Power Output:

200W rms into 8 ohms at rated distortion

250W rms into 6 ohms at rated distortion

300W rms into 4 ohms at rated distortion

Signal to noise ratio: 100dB (unwtd)

Input Impedance: >10K ohms

Damping Factor: >100 into 6 ohms

Gain: +27dB (1.7V sensitivity) for full output

Input connectors:

RCA jack for unbalanced line level input

XLR jack for balanced line level input

Detachable terminal block for external trigger in/thru

Output connectors: Pair of 5-way binding post

Standby Mode: Selectable internal and external.

Internal automatic when no signal is present for >20 minutes

Power Consumption: 600W Max

Standby Mode Power Consumption: <3W

Weight: 18 lbs.

Dimensions: 1.5"H x 17"W x 11.5"D

Finish: matte black anodized front panel, black painted chassis

X1 Bass Management / Active Crossover

Frequency response: 20Hz - 140Hz +/-3dB

through L/R input (continuously variable)

20 - 220Hz +/-3dB through LFE input (fixed)

50,80,110Hz-100KHz +/-3dB

Distortion: < 0.01% subwoofer output @ 100Hz, 1V

< 0.001% hi-pass output @ 1KHz, 1V

Signal to noise ratio: >105dB at Hi-pass output

>100dB at subwoofer output

Crossover: Low-pass continuously variable between 50-140Hz,

12dB/octave

Low-pass fixed at 220Hz,12dB/octave

High-pass selectable between 50, 80, 110Hz, 12dB/octave

Input connectors:

Gold plated L and R RCA jacks for line level input

XLR jacks for line level input

Gold plated RCA jack for LFE input

XLR jack for LFE input

Detachable terminal block for external trigger in/thru

2.1mm x 5.5mm x 9.5mm power connector

Output connectors:

Gold plated L and R RCA jacks for line level high-pass output

Gold plated RCA jack for LFE thru

XLR jacks for line level high-pass output

Gold plated RCA jacks for line level sub woofer output

XLR jacks for line level subwoofer output

Phase Control:

Variable between 0 and 90 degrees

Switchable 0 - 180 degrees

Gain Control: +10dB and 0dB input sensitivity

Stereo / Mono Switch: Stereo or mono operation

Standby Mode: Selectable internal and external.

Internal automatic when no signal is present for >20 minutes

Power Consumption: 3W

Weight: 9 lbs.

Dimensions: 1.5"H x 17"W x 11.5"D

Finish: matte black anodized front panel, black painted chassis

M5 Monitor

System type	3-way, Acoustic Suspension
Woofers	5.25" laminated cone
Midrange	3" paper cone
Tweeter	1" aluminum dome
Magnetic Shielding	Yes
Impedance (Minimum)	3.6Ω
Impedance (Nominal)	6Ω
Recommended Power	100 watts
Power Peak	300 watts
Power RMS	150 watts
Sensitivity	85dB (2,83V @ 1 meter)
Crossover Frequency	450Hz, 3kHz
Crossover Slopes (dB/octave)	12dB high pass, 12dB low pass
Response	66Hz - 20kHz
-6 dB LF Cutoff	51 Hz
Input Connectors	5-way binding posts
Dimensions (HxWxD)	7.75" x 17.75" x 8.5"
Weight	22 lbs.
Enclosure Material:	.75" MDF with backer

M6 Monitor

System type	3-way, Acoustic Suspension
Woofers	6.5" laminated cone
Midrange	4" paper cone
Tweeter	1" aluminum dome
Magnetic Shielding	Yes
Impedance (Minimum)	3.6Ω
Impedance (Nominal)	6Ω
Recommended Power	200 watts
Power Peak	400 watts
Power RMS	250 watts
Sensitivity	87dB (2,83V @ 1 meter)
Crossover Frequency	350Hz, 3kHz
Crossover Slopes (dB/octave)	12dB high pass, 12dB low pass
Response	61Hz - 20kHz
-6 dB LF Cutoff	45 Hz
Input Connectors	5-way binding posts
Dimensions (HxWxD)	8.25" x 20" x 10.25"
Weight	36 lbs.
Enclosure Material:	.75" MDF with backer

B5 Subwoofer Module

System type	Acoustic Suspension Subwoofer
Woofers	12" aluminum cone
Midrange	
Tweeter	
Magnetic Shielding	No
Impedance (Minimum)	9Ω
Impedance (Nominal)	12Ω
Recommended Power	125 watts
Power Peak	250 watts
Power RMS	125 watts
Sensitivity	88dB (2,83V @ 1 meter)
Crossover Frequency	
Crossover Slopes (dB/octave)	
Response	26Hz - 140Hz
-6 dB LF Cutoff	24 Hz
Input Connectors	5-way binding posts
Dimensions (HxWxD)	25" x 7.75" x 17.25"
Weight	42 lbs.
Enclosure Material:	.75" MDF with backer

B6 Subwoofer Module

System type	Acoustic Suspension Dual Subwoofer
Woofers	(2) 12" aluminum cone
Midrange	
Tweeter	
Magnetic Shielding	No
Impedance (Minimum)	4.5Ω
Impedance (Nominal)	6Ω
Recommended Power	250 watts
Power Peak	500 watts
Power RMS	250 watts
Sensitivity	94dB (2,83V @ 1 meter)
Crossover Frequency	
Crossover Slopes (dB/octave)	
Response	26Hz - 140Hz
-6 dB LF Cutoff	24 Hz
Input Connectors	5-way binding posts
Dimensions (HxWxD)	27.1" x 8.25" x 23.65"
Weight	71 lbs.
Enclosure Material:	.75" MDF with backer

W1 Subwoofer

	Acoustic Suspension Dual Opposing Woofer Subwoofer
System type	
Woofer	(2) 12" aluminum cone
Midrange	
Tweeter	
Magnetic Shielding	No
Impedance (Minimum)	4.5Ω
Impedance (Nominal)	6Ω
Recommended Power	250 watts
Power Peak	500 watts
Power RMS	250 watts
Sensitivity	94dB (2,83V @ 1 meter)
Crossover Frequency	
Crossover Slopes (dB/octave)	
Response	26Hz - 140Hz
-6 dB LF Cutoff	24 Hz
Input Connectors	5-way binding posts
Dimensions (HxWxD)	22" x 13.5" x 16.65"
Weight	71 lbs.
Enclosure Material:	.75" MDF with backer

W2 Subwoofer

	Acoustic Suspension Subwoofer
System type	
Woofer	12" aluminum cone
Midrange	
Tweeter	
Magnetic Shielding	No
Impedance (Minimum)	9Ω
Impedance (Nominal)	12Ω
Recommended Power	125 watts
Power Peak	250 watts
Power RMS	125 watts
Sensitivity	88dB (2,83V @ 1 meter)
Crossover Frequency	
Crossover Slopes (dB/octave)	
Response	26Hz - 140Hz
-6 dB LF Cutoff	24 Hz
Input Connectors	5-way binding posts
Dimensions (HxWxD)	14" x 14" x 14"
Weight	38 lbs.
Enclosure Material:	.75" MDF with backer

P5 Pedestal

System type	Stand For M5 Monitor
Dimensions (HxWxD)	25" x 7.75" x 11.75"
Weight	16 lbs.
Enclosure Material:	.75" MDF with backer

P6 Pedestal

System type	Stand For M6 Monitor
Dimensions (HxWxD)	27.1" x 8.25" x 14.25"
Weight	18 lbs.
Enclosure Material:	.75" MDF with backer

T5 Tower

	M5 Monitor integrated with a B5 subwoofer module
System type	
Dimensions (HxWxD)	43" x 7.75" x 17.25"
Weight	40 lbs.

T6 Tower

	M6 Monitor integrated with a B6 subwoofer module
System type	
Dimensions (HxWxD)	47.1" x 8.25" x 23.65"
Weight	103 lbs.

Free Manuals Download Website

<http://myh66.com>

<http://usermanuals.us>

<http://www.somanuals.com>

<http://www.4manuals.cc>

<http://www.manual-lib.com>

<http://www.404manual.com>

<http://www.luxmanual.com>

<http://aubethermostatmanual.com>

Golf course search by state

<http://golfingnear.com>

Email search by domain

<http://emailbydomain.com>

Auto manuals search

<http://auto.somanuals.com>

TV manuals search

<http://tv.somanuals.com>