



User's Manual



Model

SubOne i

Powered Subwoofer

IMPORTANT SAFETY INSTRUCTIONS



CAUTION

RISK OF ELECTRIC SHOCK
DO NOT OPEN



CAUTION: TO REDUCE RISK OF ELECTRICAL SHOCK, DO NOT REMOVE COVER (OR BACK). NO USER SERVICEABLE PARTS INSIDE. REFER TO QUALIFIED SERVICE PERSONNEL.



The lightning flash with the arrowhead symbol, within an equilateral triangle, is intended to alert the user to the presence of uninsulated "dangerous voltage" within the product's enclosure that may be of sufficient magnitude to constitute a risk of electric shock to persons.



The exclamation point within an equilateral triangle is intended to alert the user to the presence of important operating and maintenance (servicing) instructions in the literature accompanying the appliance.

WARNING: TO REDUCE THE RISK OF FIRE OR ELECTRIC SHOCK, DO NOT EXPOSE THIS APPLIANCE TO RAIN OR MOISTURE.

1. READ INSTRUCTIONS - All safety and operating instructions should be read before the appliance is operated.
2. RETAIN INSTRUCTIONS - Safety and operating instructions should be retained for future reference.
3. HEED WARNINGS - All warnings on the appliance and in operating instructions should be adhered to.
4. FOLLOW INSTRUCTIONS - All operating and use instructions should be followed.
5. WATER AND MOISTURE- The appliance should not be used near water - near bathtub, washbowl, kitchen sink, laundry tub; in a wet basement near a swimming pool, etc.
6. CARTS AND STANDS - Do not place this product on an unstable cart, stand, tripod, bracket, or table. The appliance should be used only with a cart or stand that is recommended by the manufacturer.
7. VENTILATION - The appliance should be situated so that its location and position do not interfere with proper ventilation. The appliance should not be situated on a bed, sofa, rug, or any surface that may obstruct cabinet openings.
8. HEAT - The appliance should be situated away from heat sources such as radiators, heat registers, stoves, or other devices (including amplifiers) that produce heat.
9. POWER SOURCES - This product should be operated only from the type of power source indicated on the marking label. If you are not sure of the type power supply in your home, consult your product dealer or local power company. For products intended to operate from battery power or other sources, refer to the operating instructions.
10. POWER CORD PROTECTION - Power supply cords should be routed so that they are not likely to be walked upon or pinched by items placed upon or against them, paying attention to cords and plugs, convenience receptacles, and the point where they exit from the appliance.
11. POLARIZED PLUG - This appliance is equipped with a polarized line plug (a plug having one blade wider than the other). This plug will fit into the power outlet only one way. This is a safety feature. If you are unable to insert the plug fully into the outlet, try reversing the plug. If the plug still fails to fit, contact your electrician to replace your obsolete outlet. Do not attempt to defeat this safety feature.
12. LIGHTNING - For added protection for this product during a lightning storm, or when it is left unattended and unused for long periods of time, unplug it from the wall outlet and disconnect the antenna or cable system. This will prevent damage to the product due to lightning and power line surges.
13. OVERLOADING - Do not overload wall outlets, extension cords, or integral convenience receptacles, as this can result in a risk of fire or electric shock.
14. CLEANING - Unplug this product from the wall outlet before cleaning. Do not use liquid cleaners or aerosol cleaners. Use a damp cloth for cleaning.
15. NON-USE PERIODS - This amplifier should be unplugged from the outlet when the appliance is left unused for a long period of time.
16. OBJECT AND LIQUID ENTRY - Never push objects of any kind into this product through openings, as they may touch dangerous voltage points or short-out parts that could result in a fire or electric shock. Never spill liquid of any kind on this product.
17. DAMAGE REQUIRING SERVICE - The appliance should be serviced by qualified personnel when:
 - a. The power supply cord or plug has been damaged; or
 - b. Objects have fallen on or liquid has been spilled into the appliance; or
 - c. The appliance has been exposed to rain; or
 - d. The appliance does not appear to operate normally or exhibits a marked change in performance; or
 - e. The appliance has been dropped or the enclosure is damaged.
18. SERVICING - Do not attempt to service this product yourself, as opening or removing covers may expose you to dangerous voltage or other hazards. Refer all servicing to qualified service personnel. For service warranty information call the NHT Hotline number: 1-800-NHT-9993.
19. REPLACEMENT PARTS - When replacement parts are required, be sure the service technician has used replacement parts specified by the manufacturer or that have the same characteristics as the original part. Unauthorized substitution may result in fire, electric shock, or other hazards.
20. SAFETY CHECK - Upon completion of any service or repairs to this product, ask the service technician to perform safety checks to determine that the product is in proper operating condition.

CAUTION

TO PREVENT ELECTRIC SHOCK, DO NOT USE THIS (POLARIZED) PLUG WITH AN EXTENSION CORD, RECEPTACLE OR OTHER OUTLET UNLESS THE BLADES CAN BE FULLY INSERTED TO PREVENT BLADE EXPOSURE.

Table of Contents

Specifications	2
Diagrams of SubOne i Subwoofer and Controller	3
Placement	4
Four Connection Methods	4
Which connection options are available in my system?	5
Explanation of Features	5
SubOne i Connection Method #1	8
SubOne i Connection Method #2	9
SubOne i Connection Method #3	10
SubOne i Connection Method #4	11
Fine Tuning the Subwoofer	12
Operation	13
Maintenance	13
Troubleshooting	13
Glossary of Terms	13
Warranty Information	15

Thank you for your purchase of the NHT SubOne i Powered Subwoofer System. Please take a few moments to read through this Owner's Manual prior to installing your new subwoofer. The information provided can help you to obtain maximum performance from your audio system. For your convenience, a glossary on page 13 explains some technical terms. If you have questions or require assistance at any time during the installation or operation of your new powered subwoofer system, please call your local NHT dealer or our Toll-Free Customer Service Hotline at:

1-800-NHT 9993

Please retain the SubOne i packaging to protect the system in the event that you move or transport it.

SubOne i Specifications

- **System type:** Vented subwoofer with built-in amplifier and outboard controller
- **Driver complement:** 12" long-throw polypropylene woofer
- **Power output:** 250 watts mono into 6 ohms, under license from Sunfire[®] Corporation
- **Frequency response:** 25Hz - 180Hz +/-3dB
- **Distortion:** Less than 0.3% at full power
- **Crossover:** Low-pass continuously variable between 40-180Hz, 18dB/octave
Selectable high-pass at 50, 75, and 110Hz, 12dB/octave (line-level)
Fixed high-pass at 100Hz (8 ohms), 6dB/octave (high-level)
- **Controller input connectors:** Gold plated RCA jacks for line level and LFE input
Gold plated barrier strip for speaker level input
- **Controller output connectors:** Gold plated RCA jacks for line level high-pass output
Gold plated barrier strip for speaker level high-pass output
Gold plated RCA jack for subwoofer output
- **Subwoofer input connectors:** Gold plated RCA jack from controller
- **Phase Control:** 2 position selectable at 0 and 180 degrees
- **Standby Mode:** (defeatable) Automatic when no signal is present for 45 minutes
- **Weight:** Subwoofer - 47 lbs.
Controller - 3 lbs.
- **Dimensions:** Subwoofer - 16"H x 16"W x 16"D
Controller - 2"H x 11"W x 7"D
- **Finish:** Subwoofer - high gloss black piano lacquer finish
Controller - matte black anodized front panel, black powder coated chassis

● Design

NHT products are designed to deliver refined, musical sound from attractive and affordable packages. Our efforts are guided by the study of human hearing and are optimized for real-world use. Every NHT product undergoes rigorous testing and quality control at the factory to ensure you years of listening pleasure.

The NHT SubOne i Powered Subwoofer System is a compact, versatile and powerful subwoofer designed to provide low frequency reinforcement for high-performance audio and home theater systems. The system is powered by a built-in 250-watt amplifier using patented Sunfire[®] technology that allows it to deliver extraordinarily dynamic high current output.

The SubOne i features an outboard Controller that allows convenient adjustment of volume, filtering and phase controls. It also provides line-level and speaker-level inputs and outputs for connection with all types of receivers or separate audio components. To accommodate the differing listening preferences common for music and home theater, the Controller offers a Flat / Video Contour switch that maintains flat response for music listening and adds extra midbass output for video playback. The SubOne i subwoofer and Controller are connected via the supplied 20' RCA cable.

Subwoofer Back



Controller Front

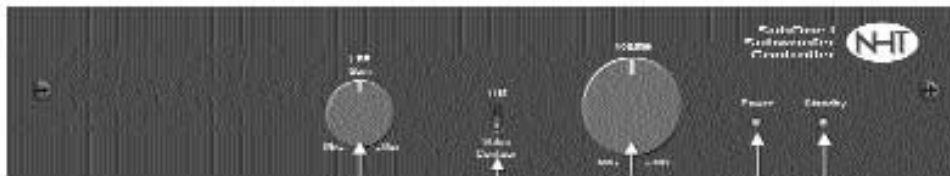

Controller Back

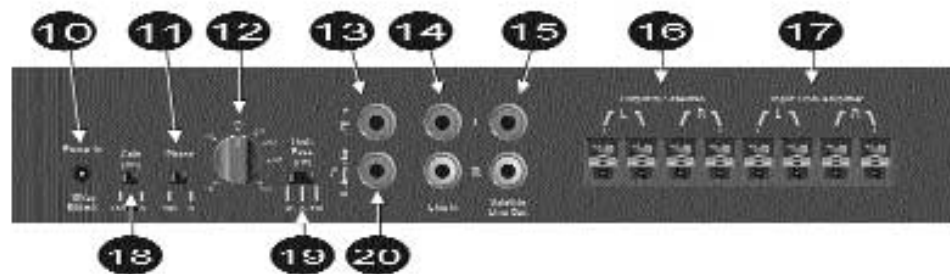

- | | |
|-----------------------------------------------------------------------------------------------------------------------------------------------------------------------------------------------------------------------------------------------------------------------------------------------------------------------------------------------------------------------------------------------------------------------------------------------------------------------------------------------------------------------------------------------------------------------------------------------------------------------------------------------------------------------------------------------------------------------------------------------------------------------------------------------------------------------------------------------------|--------------------------------------------------------------------------------------------------------------------------------------------------------------------------------------------------------------------------------------------------------------------------------------------------------------------------------------------------------------------------------------------------------------------------------------------------------------------------------------------------------------------------------------------------------------------------------------------------------------------------------------------------------------------------------------------------------------------------------------------------------------------------------------------------------------------------------------------------------------------------------------------------------------------------------------|
| <p>(1) Power Switch - Activates power for subwoofer</p> <p>(2) AC Power Input - Power cord receptacle.</p> <p>(3) Subwoofer Input - Input for RCA connector from Controller.</p> <p>(4) Power Indicator - The light shows green when the system is on, shows red in standby</p> <p>(5) Standby Indicator - The amber light is lit when the subwoofer is in standby mode.</p> <p>(6) Power Indicator - The green light is lit when the system is on.</p> <p>(7) Volume Control - Adjusts the loudness of the subwoofer independently of the main speakers.</p> <p>(8) Flat / Video Contour Switch - Selects response mode of subwoofer.</p> <p>(9) LFE Gain Control - Adjusts amount of LFE in the mix</p> <p>(10) Power Input - To accept power from the LL1 power supply</p> | <p>(11) Subwoofer Phase Selector - 2-position selectable phase control for subwoofer.</p> <p>(12) Low Pass Filter - Continuously variable low pass crossover control.</p> <p>(13) LFE Input - Line Level RCA Low Frequency Effects input.</p> <p>(14) Line In - Line-level RCA input connectors.</p> <p>(15) Satellite Line Out - Line-level RCA output jacks to receiver / main amplifier.</p> <p>(16) Output to Satellites - Barrier strip for speaker-level connection to main speakers.</p> <p>(17) High Level Input - Barrier strip for speaker-level input from receiver / amplifier.</p> <p>(18) Subwoofer Gain Selector - Allows optional attenuation of SubOne i gain.</p> <p>(19) High Pass Filter - 3-way selectable high pass crossover for satellite line out.</p> <p>(20) Subwoofer Output - RCA cable for connection to SubOne i subwoofer.</p> |
|-----------------------------------------------------------------------------------------------------------------------------------------------------------------------------------------------------------------------------------------------------------------------------------------------------------------------------------------------------------------------------------------------------------------------------------------------------------------------------------------------------------------------------------------------------------------------------------------------------------------------------------------------------------------------------------------------------------------------------------------------------------------------------------------------------------------------------------------------------|--------------------------------------------------------------------------------------------------------------------------------------------------------------------------------------------------------------------------------------------------------------------------------------------------------------------------------------------------------------------------------------------------------------------------------------------------------------------------------------------------------------------------------------------------------------------------------------------------------------------------------------------------------------------------------------------------------------------------------------------------------------------------------------------------------------------------------------------------------------------------------------------------------------------------------------|

● Placement

Experimentation is the key to finding the best location for the SubOne i in your listening environment. When possible, place the subwoofer in the same horizontal plane and along the same wall as the main speakers. Low frequencies produce long wavelengths and thus interact with room boundaries significantly. Placing the subwoofer nearer to a room boundary (walls, corners) will tend to increase its bass output, but may result in “boomy” or “muddy” sound. Conversely, placing the subwoofer farther away from room boundaries will tend to decrease its bass output, but may result in improved articulation and clarity.



Note: To prevent the SubOne i subwoofer amplifier from overheating, always be sure to provide adequate space for proper ventilation. Do not place the subwoofer directly against the wall or any other surface.

Position the subwoofer so that it does not radiate sound directly into a wall or floor, and ensure that it faces into the room, unobstructed by large furnishings. If you are using two subwoofers, the greatest improvement in low frequency response is usually achieved by placing the second subwoofer asymmetrically on the opposite side of the room from the first. For example, if one sub is placed in the front left corner of the room, the second should be placed along the front (same) wall about 1/3 of the way into the room from the right corner. Avoid placing two subwoofers symmetrically (such as in two corners), as it will tend to exaggerate standing waves. As the SubOne i is not shielded, do not place it in close proximity to a television, or picture discoloration will occur.

The SubOne i Controller is most conveniently placed in a rack with other equipment, although it may also be placed on top of the subwoofer.

● Four Connection Methods



Caution: Prior to connecting the SubOne i to your audio system, it is important that all AC power connections to associated components (receivers, amplifiers, preamplifiers, processors, etc.) are either unplugged or turned off. Do not plug in or connect the SubOne i subwoofer to AC power until all connections have been made.

The SubOne i subwoofer and Controller are connected via a single 20-foot-long RCA cable. The subwoofer is plugged directly into an AC outlet in the wall. The SubOne i Controller receives power via the LL1 15VAC Power Supply. If the distance between the subwoofer and Controller in your room is greater than 20 feet, your NHT dealer offers RCA cables in varying lengths.

A subwoofer’s performance in the context of your audio / video system is highly dependent upon its interaction with your main (largest) speakers. Since a subwoofer is designed only to provide low frequency response, it is important to connect it in a manner that ensures seamless integration with your speakers. There are four possible connection methods outlined in this manual. The best method for you depends on the size of your front L & R speakers and the connection options available on your receiver or preamplifier (see next section). To help you determine the best way to connect the subwoofer to your system, consider the following suggestions:

1. If you have large (full-range) main speakers...

- 1st Choice: Method #1** (line-level with or without LFE connection with high pass filter loop)
- 2nd Choice: Method #2** (line-level and/or LFE input connection with no high pass filter loop)
- 3rd Choice: Method #4** (speaker-level connection with no high pass filter loop)

If your main speakers have generous bass response and you are adding a subwoofer, the resulting sound could be “muddy.” You have the option of sending the main speakers a high-pass filtered signal (Method #1). With the low bass information removed from the signal before it reaches the speakers, all low frequencies are reproduced exclusively by the subwoofer. With this configuration it is usually easier to achieve smooth low frequency response, as the subwoofer reproduces a different frequency range than the speakers. Use the 50Hz high pass setting.

If you want to run the main speakers full-range, or if you have a receiver with no “Pre-Out” and “Main-In” (see next section), you can use the subwoofer only to provide low bass reinforcement (Connection

Methods #2 and #4). The downside is that sending the speakers a full-range signal can make it difficult to integrate them with the subwoofer, as their combined low frequency output can cause irregularities (peaks and dips) in the room's low frequency response. In this case, the subwoofer's low pass setting should be quite low and used only to fill in the lowest octave.

Method #3 is not recommended with large main speakers.

2. If you have small (bookshelf) main speakers...

1st Choice: Method #1 (line-level and/or LFE input connection with high-pass filter loop and Dolby® Digital receiver set to 'small')
2nd Choice: Method #3 (speaker-level connection with fixed high-pass filter)

If your main speakers are smaller bookshelf-type models with limited bass response, it is advisable to send them a high-pass filtered signal (Method #1 or #3). All low bass information is removed from the signal before it reaches the speakers, and all low frequencies are reproduced exclusively by the subwoofer. Because the L & R speakers receive a signal containing only information that falls within their specified frequency response range, they exhibit reduced distortion, greater dynamic range and power handling. Use the 75Hz or 110Hz high pass setting.

Alternately, you can run small main speakers full range and use the subwoofer to reproduce all the low bass frequencies below their response capabilities (Methods #2 and 4). While simple, this configuration does not remove the burden of low frequencies from the L & R speakers and may limit their output at higher volumes.

● What connection options are available in my system?

- 1) If you have a separate preamplifier and main amplifier, all four of the connection methods are available to you. Method #1 is recommended.
- 2) If you have an integrated amplifier or receiver (hereafter called "receiver") with "Pre-Out" and "Main-In" connections, all four of the connection methods are available to you. Method #1 is recommended.
- 3) If you have a receiver with "Pre-Out" or "Line-Out" connections, but no main in connections, you may use Methods #2, #3 or #4.
- 4) If you have a receiver with "Pre-Out" or "Line-Out" connections, you may use Methods #2, #3 or #4.
- 5) If your receiver or processor has a "Subwoofer Out" or "LFE Out" connection, you may use any of Methods #1 through #4, or simply connect the "Subwoofer Out" or "LFE Out" jack to the SubTwo I Controller. See the **Use of the LFE Input and LFE Gain Control** section for more information.

Detailed descriptions and diagrams of all four connection methods are found on pages 8-11.

● Explanation of Features

The **VOLUME CONTROL** allows you to adjust the volume of the subwoofer relative to the rest of the system. Many listeners make the mistake of setting subwoofers too loud, which can cause excess bloat and loss of detail and musicality. A properly calibrated subwoofer blends in with the speakers and does not call attention to itself. Observe the following guidelines for volume setting:

Turn down the volume control on the SubOne i Controller to its lowest position (counter-clockwise). Turn on your audio system, including the SubOne i. Play some music you are familiar with and set your receiver/pre-amplifier volume to a comfortable listening level. Slowly increase the volume on the SubOne i Controller, listening for proper frequency balance. When the subwoofer output is balanced with the rest of the system, you will hear improved bass extension, but you should be unaware that it is coming from the subwoofer! From this point on, the volume control on your receiver/preamplifier will control the overall volume of your system, including the subwoofer.

Use of the LFE Input and LFE gain Control (LFE = Low Frequency Effects)

If your receiver/processor has a "subwoofer out" or "LFE out" jack, you can connect that jack to the LFE Input on the back of the SubOne i Controller. You can configure your system as follows:

(a) This is the recommended method as it is the most likely to lead to optimum results for both music and movies. Connect your receiver/processor as shown in the section labeled Connection Method #1. Connect the LFE output of your receiver to the LFE Input of the Controller as discussed above. Using music, adjust the Controller so that the main speakers and the subwoofer are well integrated (see the fine tuning section for help). Set up your receiver/processor so that the main speakers are run in the "large" mode and set the subwoofer to "on" or "yes." Use the LFE gain control to add the desired level of low frequency effects (in conjunction with the Audio/Video switch) for home theater use. Also, in the set up of your receiver/processor, set the crossover frequency for the subwoofer to the highest frequency available (typically 200Hz) so that the crossover in the receiver does not interfere with the crossover in the SubOne i Controller. Also, disable any bass equalization controls that may be available in the receiver/processor.

Note: Setting the speakers as "large" means that they will be fed a full range signal. They may or may not receive the information from the low frequency effects channel depending on the bass management features of your receiver/processor. Therefore we recommend that you set the subwoofer setting to "on" as above to insure that the SubOne i receives input from the LFE channel. Setting the speakers to "small" means that they are rolled off below 80Hz, limiting the amount of bass information they must reproduce (and they receive no information from the low frequency effects channel). Setting the main speakers to small is not necessary when they are properly integrated with the SubOne i since the subwoofer and main speakers together form a full range system.

(b) Run an interconnect from the LFE output on your receiver/processor to the LFE Input on the SubOne i Controller. **DO NOT CONNECT THE RECEIVER TO THE LINE IN AND SATELLITE OUT CONNECTORS ON THE CONTROLLER (THERE SHOULD BE ONLY ONE INTERCONNECT GOING FROM THE RECEIVER/PROCESSOR TO THE CONTROLLER).** Use the receiver/processor to adjust the settings for crossover frequency and level for the main speakers and subwoofer. Set the Low Pass filter on the Controller to its highest setting (180Hz) so that it doesn't interfere with the receiver/processor setting. Set the LFE Gain control and volume control on the Controller so that the indicator marks on each are pointing straight up. Adjust as necessary to accommodate the controls provided by your receiver/processor. Note: The control settings offered by most receiver/processors are somewhat generic, so we recommend method A above since it allows you to customize the subwoofer settings to your particular system.

The front panel **FLAT / VIDEO CONTOUR** switch allows you to optimize the SubOne i's performance for music listening or movie viewing. When listening to music, many listeners prefer a flat bass response that does not emphasize any individual frequencies. Flat bass response more realistically reproduces the sound of live instruments. However, when watching movies in a home theater system, many listeners prefer a punchier, "boomier" sound that emphasizes sounds like explosions and gunfire. Subwoofers with more output in the mid-bass regions tend to deliver this punch, at the expense of flat response.

The Flat / Video Contour switch allows you the best of both worlds. In the "Flat" mode, the SubOne i's response is flat for accurate musical reproduction. In the "Video Contour" mode, the SubOne i has boosted output between 40Hz and the low pass frequency, and rolls off response below 35Hz to provide greater power handling at elevated listening levels.

If your main speakers are large with generous bass response and you are connecting them full-range, you will most likely be using the SubOne i only for very low bass reinforcement (usually below about 40Hz). In this case, the "Video Contour" mode will not yield an increase in bass output at these frequencies, but will actually decrease its output, so the "Flat" mode may work better.

The continuously adjustable **LOW PASS FILTER** determines the range of frequencies that the subwoofer will reproduce. For example, a low pass setting of 100Hz means that the subwoofer reproduces only frequencies below 100Hz. The Low Pass Filter is variable between 50Hz (low bass) to 200Hz (upper bass), to accommodate a variety of speaker configurations.

If you are using Connection Method #1, your main speakers are reproducing only the frequency range selected by the High Pass Filter (see next section). As a starting point, set the Low Pass Filter at

about the same frequency you have set the High Pass Filter. For example, if the High Pass Filter sends only signals above 75Hz to your main speakers, begin with the Low Pass Filter set at 75Hz. See the “Fine Tuning” section for further adjustment guidelines.

If you are using Connection Method #2 or #4, your main speakers are reproducing the entire frequency range (including bass) and it is advantageous for the subwoofer to reproduce only those frequencies below the rated response of the main speakers. For example, if your main speakers have a rated low frequency response of 60Hz, begin with the Low-Pass Filter set at 60Hz. See the “Fine Tuning” section for further adjustment guidelines.

If you are using Connection Method #3, your main speakers are reproducing only frequencies above 100Hz, due to the fixed 100Hz high pass filter at the speaker-level output barrier strip. As a starting point, set the Low Pass Filter at 100Hz. See the “Fine Tuning” section for further adjustment guidelines.

The selectable **HIGH PASS FILTER** determines the range of frequencies that the main speakers (“satellites”) will reproduce. For example, a high pass setting of 50Hz means that the main speakers receive a signal containing only frequencies above 50Hz. The benefit of high pass filtering is improved dynamic range and lower distortion in the main speakers, as they are spared the task of low frequency reproduction. There are three available high pass settings: 50Hz, 75Hz and 110Hz.

The High Pass Filter should initially be set to a frequency above the rated low frequency limit of the main speakers. For example, if your speakers have a rated low frequency response of 40Hz, use the 50Hz high-pass setting. If your speakers have a rated low frequency response of 90Hz, use the 110Hz high-pass setting.

To select the appropriate high pass setting for your main speakers, check the owner’s manual for their rated low frequency response. If you are unable to obtain this information, here are some common high-pass settings:

Small speaker	Medium speaker	Large speaker
110Hz	75Hz	50Hz

The **SUBWOOFER PHASE** selector sets the phase of the subwoofer at the 0° position (normal phase) and the 180° position (reverse phase). The ability to adjust subwoofer phase is a great advantage for achieving smooth bass response in your system. The combined low frequency sound waves from the subwoofer and the main speakers can sometimes cause peaks and dips in the frequency response at the listening position. In these cases, adjusting the subwoofer phase may improve the blending and overall performance of the system.

The optimal phase setting will differ according to room conditions and placement, and the main speakers used. Experiment with phase settings by listening to a familiar CD from the listening seat, alternating phase settings on the same track. Do not attempt to evaluate the best sound while standing above the subwoofer or amplifier, as the sound at the listening position will be significantly different.

The **SUBWOOFER GAIN** switch allows you to attenuate the line-level input sensitivity of the SubOne i by 10dB. This is useful if your receiver or preamplifier has very high line-level output voltage that limits your range of volume adjustability on the SubOne i Controller. Engaging the 0dB attenuation will give you a wider range of volume adjustment for the SubOne i.

The SubOne i has a **STANDBY MODE** feature that is automatic and requires no user adjustment. When no signal is present for 45 minutes, the SubOne i goes into Standby Mode, and it will use a minimum of power to remain “asleep.” When the system is used again, it immediately turns on as soon as a signal is received. There is no need to turn the SubOne i on and off every time it is used.

SubOne i Connection Method #1

Connect the SubOne i Controller between a receiver's "Pre-Out" and "Main-In", with high-pass filter loop

Use if:

- You wish to send your L & R speakers a high-pass filtered signal and/or LFE signal
- You have a receiver with "Pre-Out" and "Main-In" jacks
- You have a separate preamplifier and main amplifier

This method allows your main speakers to receive a high-pass filtered signal (not full range), and the subwoofer to be utilized for low-to mid-bass reproduction. The full-range line-level signal coming from the receiver's "Pre-Out" passes through the SubOne i Controller's selectable high-pass filter, which removes the low frequencies from the signal before sending it back to the receiver's "Main-In." This configuration effectively increases the receiver and speakers' dynamic range and power output by sparing them the difficult task of reproducing low frequency information.

1) Your L & R speakers are connected directly from your amplifier / receiver.

2a) If you have a receiver with "Pre-Out" and "Main-In" jacks, patch in the SubOne i Controller between these. With an RCA interconnect cable, connect the receiver's "Pre-Out" to the SubOne i Controller's **LINE IN**. Connect a second RCA interconnect cable from the SubOne i Controller's **SATELLITE LINE OUT** back to the receiver's "Main-In."

2b) If you have a separate preamplifier and main amplifier, connect the preamplifier output to the SubOne i Controller's **LINE IN**. Connect a second interconnect cable from the SubOne i Controller's **SATELLITE LINE OUT** to the main amplifier's line-level inputs. With this configuration, your preamplifier is not connected directly to your amplifier; instead the signal passes through the SubOne i Controller before it reaches the amplifier.

3) Connect the SubOne i Controller's **SUBWOOFER OUTPUT** to the SubOne i input terminal with the supplied RCA cable.

4) See page 6 for instruction on using the **LFE Input** and **LFE Gain** control

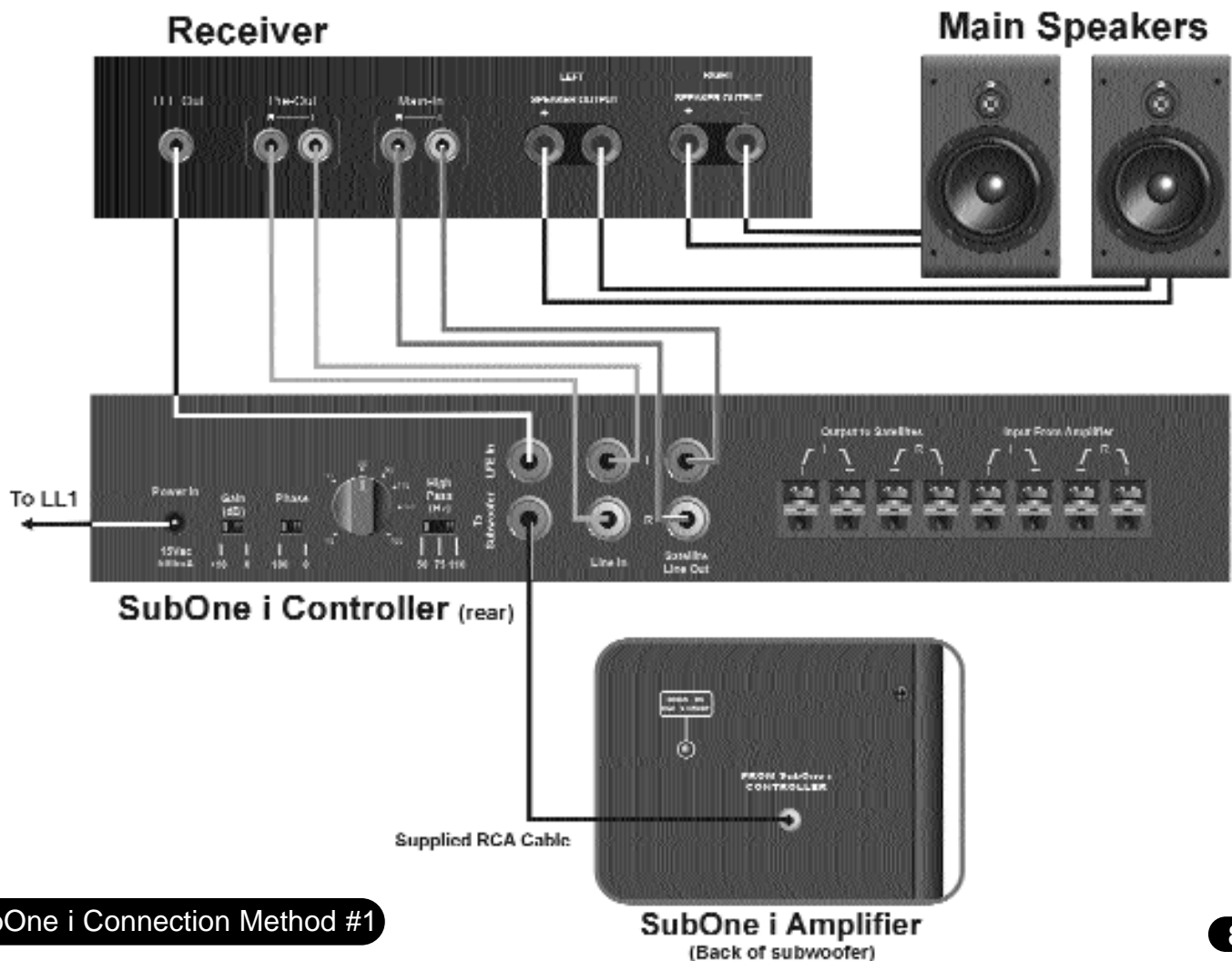

SubOne i Connection Method #2

Connect the SubOne i Controller from a receiver / preamplifier's "Subwoofer (LFE) Out," "Pre-Out" or "Line Out" with no high-pass filtering

Use if:

- You wish to run your L & R speakers full-range
- You have a receiver with "Subwoofer (LFE) Out" jacks
- You have a receiver with "Pre-Out" jacks but no "Main-In" jacks

This method of connection allows your main speakers to receive the full-range audio signal (no high-pass filtering), and the subwoofer to be utilized for low bass extension only.

- 1) Your L & R speakers are connected directly from your amplifier / receiver.
- 2a) If you have a receiver with "Pre-Out" (or "Line Out") jacks but no "Main-In," you may connect the SubOne i Controller from the "Pre-Out" without having to route the signal back into the receiver. Using an RCA interconnect cable, connect the "Pre-Out" to the SubOne i Controller's **LINE IN**.
- 2b) If you have a separate preamplifier and amplifier, and the preamplifier has two pairs of "Line Out" jacks, connect one pair directly to your main amplifier, and the second pair to the SubOne i Controller's **LINE IN**. If your preamplifier has only one pair of "Line Out" jacks, you may utilize two "Y"-splitters to send the line-level signal into both the main amplifier and the SubOne i Controller.
- 3a) Many integrated amplifiers and receivers feature a "Subwoofer Out" or "LFE Out" jack. If your receiver's "Subwoofer Out" consists of a single RCA jack, you should plug it into the **LFE IN** jack on the SubOne i Controller.
- 3b) Check your receiver's owner's manual to see if the "Subwoofer Out" signal is full-range or low-pass filtered. On many Dolby Digital 5.1-channel receivers, the low-pass is built-in at a certain frequency (80Hz, for example), which means the signal coming out this jack has already passed through an internal filter in the receiver. If possible, bypass the low-pass filter in the receiver. Otherwise, be sure to set the SubOne i low-pass filter at its highest point (180Hz) to avoid having two low-pass filters affect the signal.
- 4) Connect the SubOne i Controller **SUBWOOFER OUTPUT** to the SubOne i input terminal with the supplied RCA cable.
- 5) See page 6 for instruction on using the **LFE Input** and **LFE Gain** control

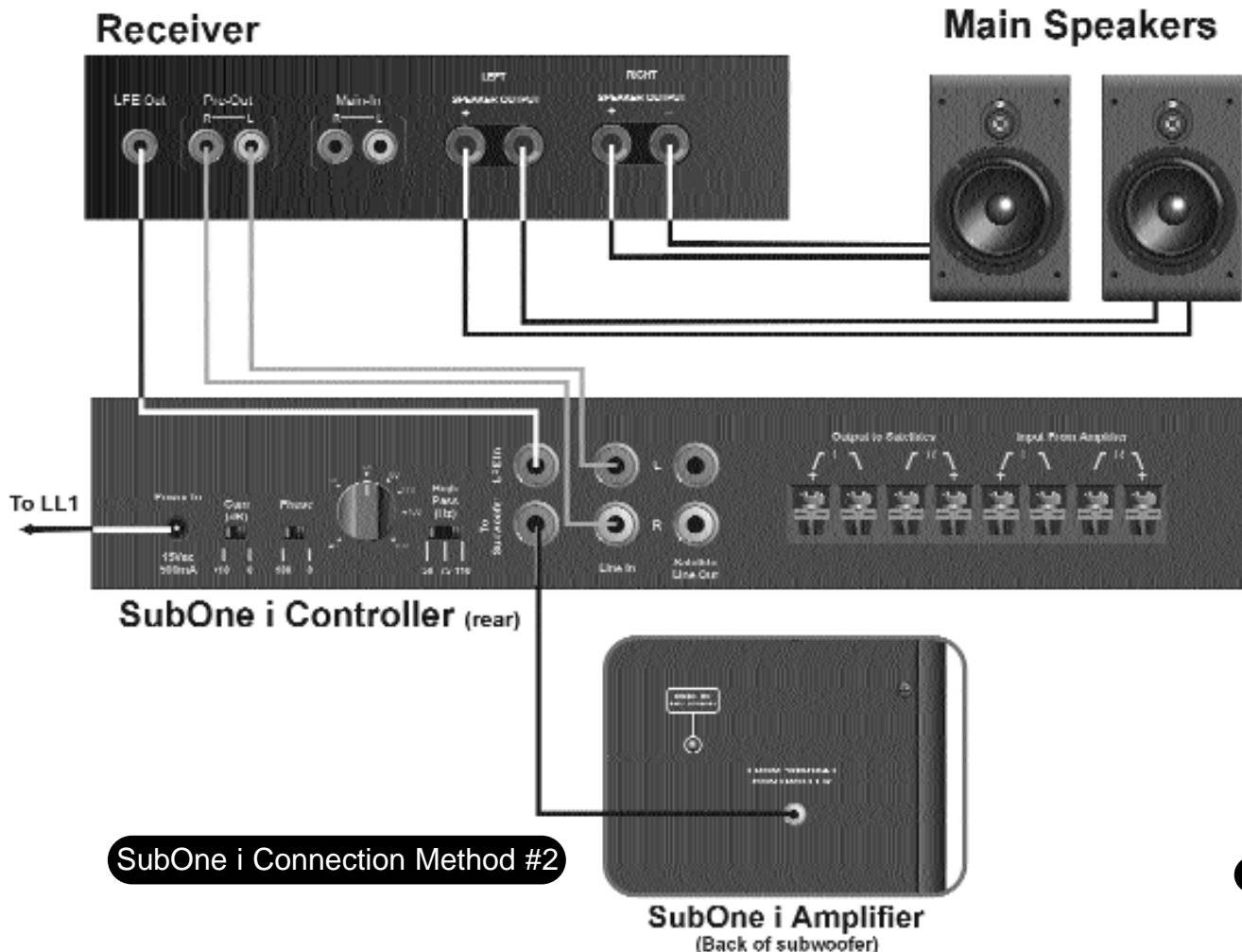

SubOne i Connection Method #3

Connect the SubOne i Controller at speaker level from the receiver's speaker outputs, with fixed high-pass filter

Use if:

You wish to send your L & R speakers a high-pass filtered signal
Your receiver has no "Pre-Out", "Line Out" or "Subwoofer Out" jacks

This method of connection is recommended if you have a receiver with no line level preamplifier output of any sort and you want your L & R speakers to receive a high-pass filtered signal. The SubOne i Controller may be connected to the system at speaker level between the receiver and the speakers. The SubOne i Controller's speaker-level output has a fixed 100Hz high-pass filter that removes frequencies below 100Hz before sending the signal on to the speakers. The speaker-level high-pass filter is not adjustable. This method is not recommended if the L & R speakers are large, full range models.

- 1) Connect a pair of speaker cables from your receiver's front L & R speaker output terminals to the SubOne i Controller's **INPUT FROM AMPLIFIER** barrier strip.
- 2) Connect a second pair of speaker cables from the SubOne i Controller's **OUTPUT TO SATELLITES** barrier strip to the front L & R speakers.
- 3) If your receiver is equipped with a "Subwoofer Out" or "LFE Out" jack, you may connect from this jack to the **LFE Input** on the Controller with an RCA cable. See page 6 for information on the LFE Input and the LFE Gain control.
- 4) Connect the SubTwo i Controller's **SUBWOOFER OUTPUT** to the SubTwo i input terminal with the supplied RCA cable.

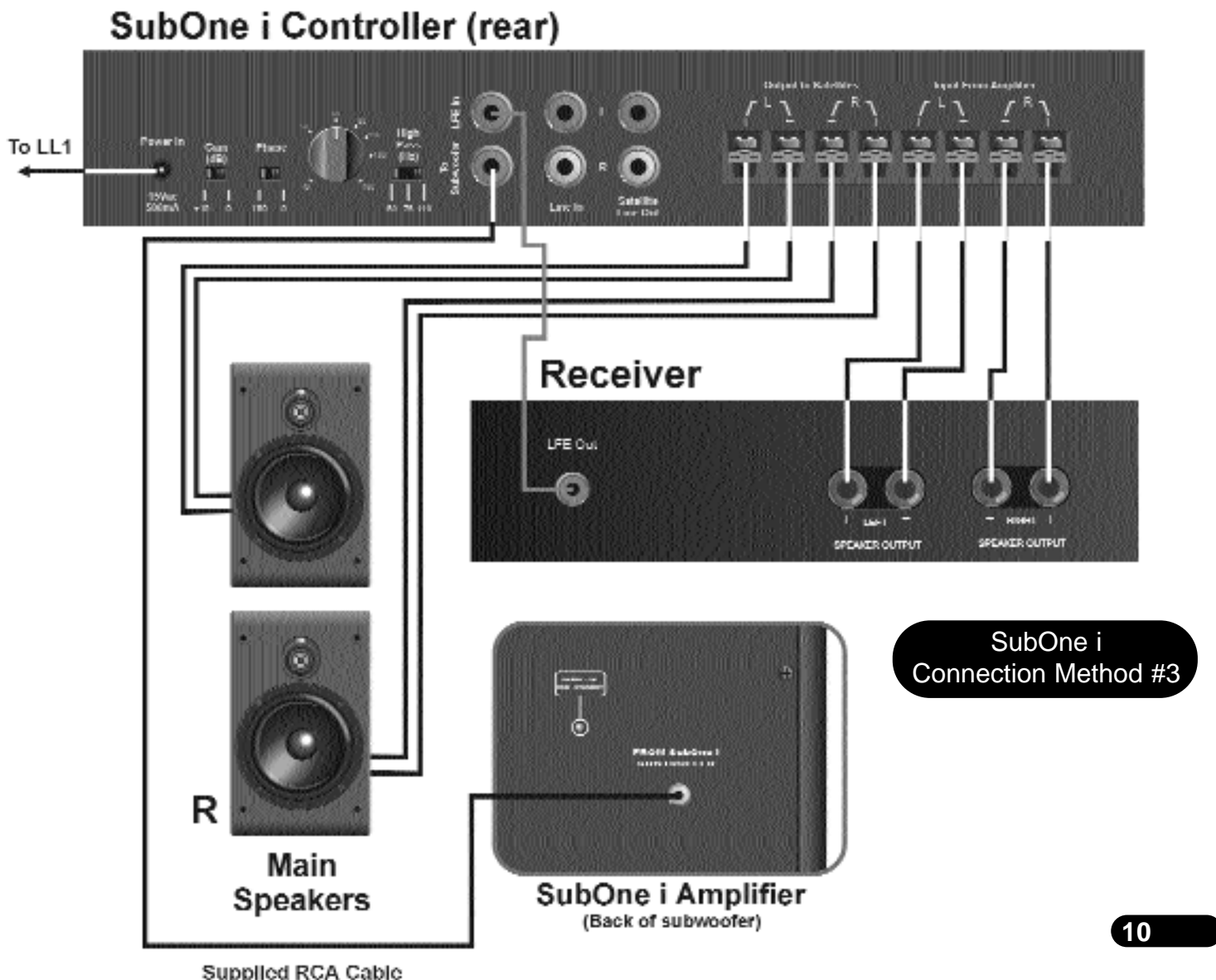

SubOne i Connection Method #4

Connect the SubOne i Controller at speaker level from the receiver's speaker outputs, with no high-pass filter

Use if:

- You wish to send your L & R speakers a full range signal
- Your receiver has no "Pre-Out", "Line Out" or "Subwoofer Out" jacks
- Your receiver has two sets of speaker output terminals: "Speaker A" and "Speaker B"

This method of connection is recommended when you have a receiver with no line level preamplifier output of any sort and you want to run your speakers full range (no high-pass filtering). If your receiver features two sets of speaker output terminals ("Speaker A" and "Speaker B"), you may use "Speaker B" to connect the SubOne i Controller.

- 1) Connect a pair of speaker cables from your receiver's "Speaker A" outputs directly to your main speakers.
- 2) Connect a second pair of speaker cables from your receiver's "Speaker B" outputs to the SubOne i Controller's **INPUT FROM AMPLIFIER** barrier strip.
- 3) If your receiver is not equipped with "Speaker A" and "Speaker B" output terminals, you may connect both the L & R speakers and the SubOne i Controller in parallel from the same terminal. Connect one pair of speaker cables from the receiver's speaker output terminal to the L & R speakers. Connect a second pair of speaker cables from the receiver's same output terminal to the SubOne i Controller's **INPUT FROM AMPLIFIER** barrier strip. The SubOne i Controller's barrier strip input does not present a significant load to the receiver and will not compromise its output to the L & R speakers.
- 4) If your receiver is equipped with a "Subwoofer Out" or "LFE Out" jack, you may connect from this jack to the **LFE Input** on the Controller with an RCA cable. See page 6 for information on the LFE Input and the LFE Gain control.
- 5) Connect the SubTwo i Controller's **SUBWOOFER OUTPUT** to the SubTwo i input terminal with the supplied RCA cable.

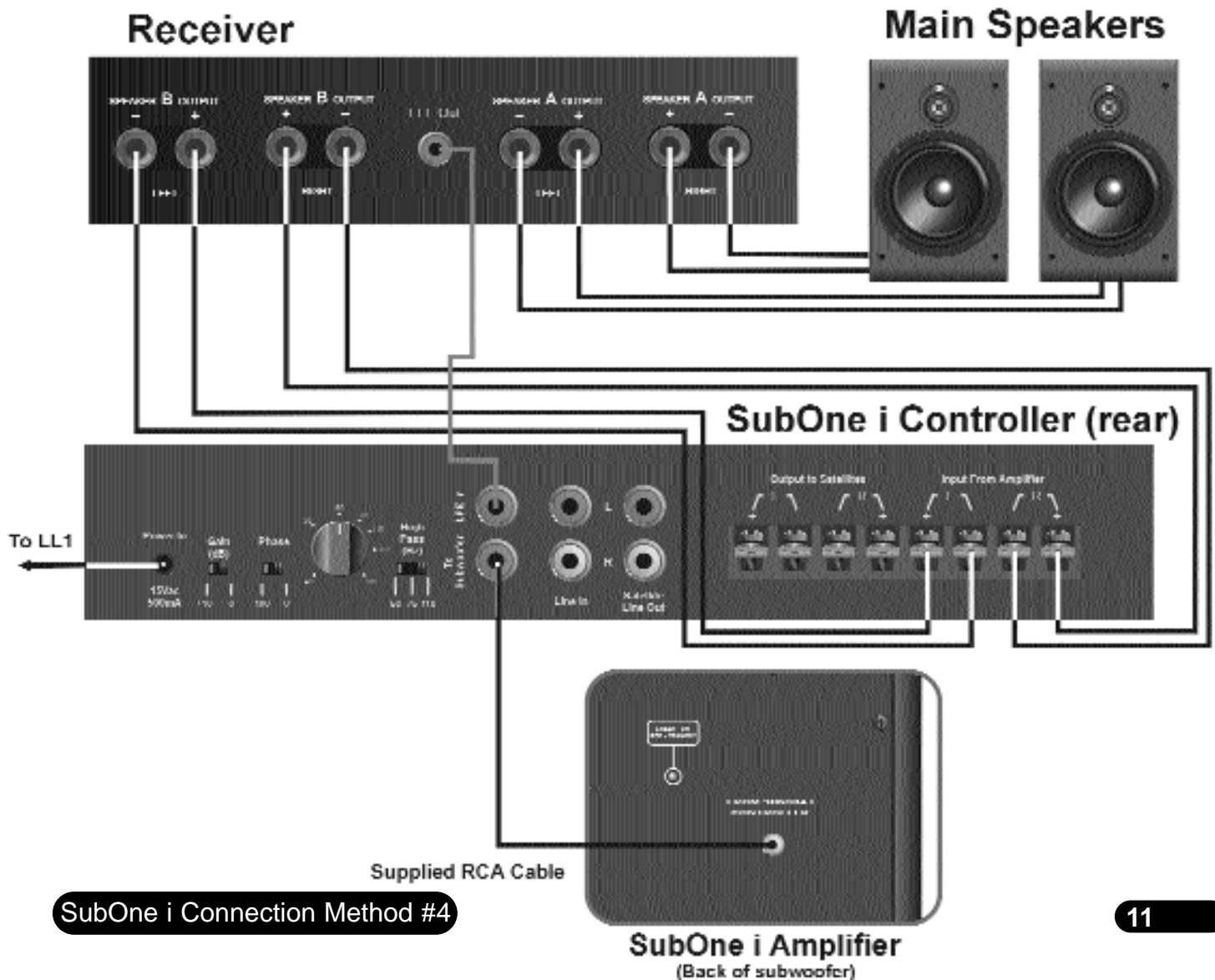

● Fine Tuning the Subwoofer

The frequency chart below lists some terms commonly used to describe different bands of the frequency spectrum. The key to good subwoofer / speaker integration is repeated listening, followed by small re-adjustments of the subwoofer controls. The most important bass tuning functions you will control are the **LOW PASS FILTER**, followed by the **VOLUME CONTROL** settings and then **PHASE SELECTOR**.

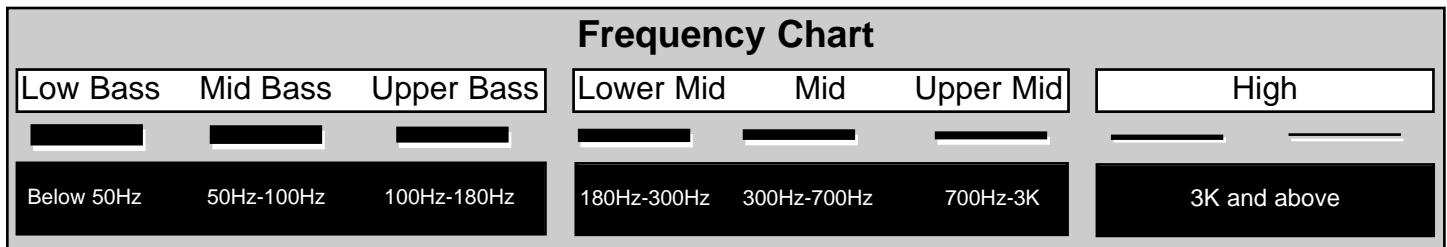

Listen to your system and make adjustments to achieve a seamless blend between your main speakers and the SubOne i. Four common problems are outlined below. Follow the flow chart to correct these. See the glossary for any terms you are unfamiliar with.

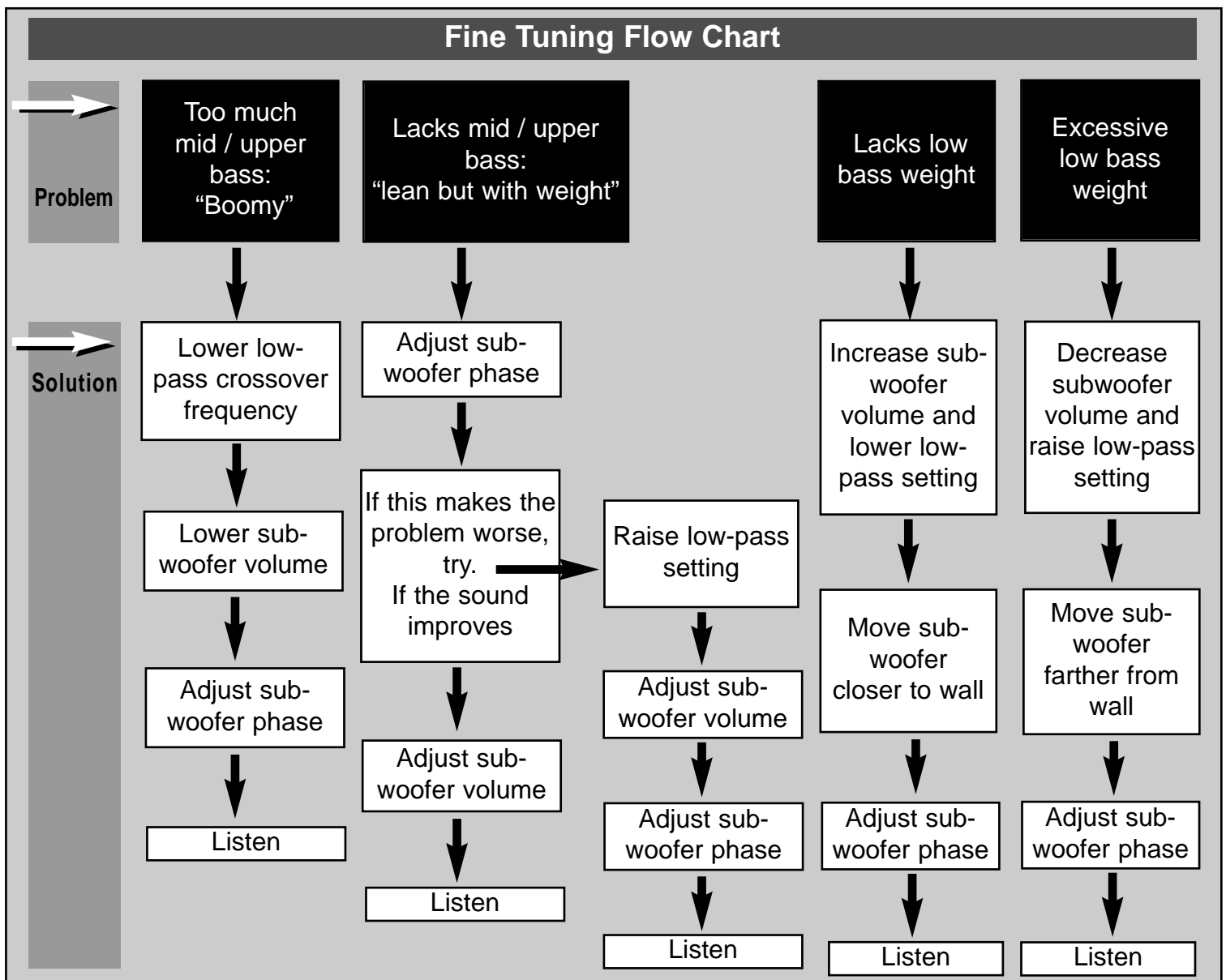

● Operation

When the SubOne i is turned on, there will be an audible “pop.” Do not be alarmed! This is inherent to the amplifier design and will not damage the subwoofer or your audio system. We do recommend, however, that the SubOne i’s power is left “on” at all times, allowing its built-in Standby Mode feature to disable the subwoofer when not in use.

The SubOne i was designed to handle a wide range of listening levels, but every component has limits. It is important to use common sense and listen for signs of possible distress from the subwoofer. Noticeable distortion or harsh breakup is an indication that the subwoofer is running beyond its capacity, and the volume should be decreased. If you feel heat emanating from the front of the woofer, reduce the level immediately. Speaker damage most often occurs from sustained high volume levels, not from transient sounds or brief musical peaks. Excessive boosting of bass, treble, or equalizer controls can worsen the problem and is not recommended.

● Maintenance

Your SubOne i has been designed for years of trouble-free operation and requires minimal maintenance under normal use. The SubOne i cabinet may be cleaned using a damp cloth or a mild, non-abrasive glass cleaner. To clean the grille, first remove it from the subwoofer, then brush lightly with a soft brush or use a vacuum on its lowest setting. The SubOne i Controller may be cleaned by wiping with a lint-free cloth. Do not expose the SubOne i or the Controller to direct sunlight, high temperatures or moisture. In the event that service is required, do not open the SubOne i amplifier or Controller. Refer the unit to a qualified service technician.

● Troubleshooting



If the SubOne i fails to operate when the Power switch is turned on, check the power cord and all input and output connections thoroughly. Failure to operate could be caused by incorrect wiring, short circuits, or excessive volume. Turn the Power switch on the subwoofer to "off" for two or more seconds to reset. If the LED indicator fails to illuminate, it is possible that mis-wiring or an electrical power surge has caused the protection fuse to blow. It must be replaced with one of correct type and value. Contact your local Authorized NHT dealer or NHT immediately for assistance.

● Glossary of Terms

Active: Uses electrical power.

Amplifier: An electronic device that increases the current of a signal, providing power to the loudspeakers (i.e. power amplifier, integrated amplifier, receiver).

Barrier Strip: A row of speaker connectors with screw-type locking mechanisms.

Bass: The range of audio frequencies below 160Hz, characterized by low pitch.

Crossover: An electronic circuit that divides an audio signal into different frequency ranges.

Distortion: Any deviation from the original signal, caused by any type of equipment.

Driver: The moving part of a loudspeaker which radiates energy.

Dynamics: Variations in loudness of sound.

Frequency: A rate of vibration which corresponds to musical pitch in the audio band, expressed in Hertz (Hz).

Full Range: A signal encompassing the entire frequency spectrum, not filtered above or below a certain frequency.

Hertz (Hz): A unit of equal to one cycle per second, used to measure the frequency of a signal or sound.

High-Pass Filter: A filter that passes only frequencies above a certain lower limit; electronically removes low frequencies from a full range signal.

Impedance: A measure of the total opposition to current flow in an alternating current circuit, described in ohms.

In Phase: The polarity of an audio signal when connected as follows: (+) to (+) and (-) to (-).

Integrated Amplifier: Has preamplifier and amplifier built into one chassis.

Interconnect Cable: A length of shielded wire with plugs at both ends for feeding signals from one electronic device to another.

L.F.E.: "Low Frequency Effects"; an RCA output for connection to a subwoofer.

Line-Level Connection: Low level RCA/phono type connection.

Load: A term used to describe the impedance which a speaker presents to an amplifier.

Low-Pass Filter: A filter that passes only frequencies below a certain upper limit; electronically removes high frequencies from a full range signal.

Main Speakers: Front L & R channel speakers, sometimes referred to as satellites.

Main-In: A line-level RCA input on the back of a receiver, integrated amplifier or power amplifier.

Midrange: The frequency span of the middle of the audio range, roughly 160Hz - 1300Hz. Also used to describe the driver which reproduces these frequencies.

Ohm: A unit of electrical resistance; that which opposes an electric current in a conductor. In audio, a measure of the load presented by a device to an electrical source.

Out-of-Phase: The polarity of an audio signal when connected as follows: (+) to (-) and (-) to (+).

Passive: Uses no electrical power.

Phase: An expression of the relative polarities of two identical signals.

Power Handling: The ability of a loudspeaker to operate without distortion when given varying amounts of power.

Preamplifier: An electronic device that selects sources and passes line-level signal to amplifier.

Pre-Out: A line-level RCA output on the back of a receiver, integrated amplifier or preamplifier.

Receiver: Has preamplifier, amplifier and tuner built into one chassis.

Satellite: Front L & R speakers when used with a subwoofer. Referred to as "main speakers".

Sensitivity: A ratio of how much of the input electrical power is converted into acoustic power, measured in decibels.

Signal: The series of continually changing electrical voltages that correspond to variations in the loudness of the original sound.

Speaker-Level Connection: The connection between a loudspeaker and an amplifier.

Sub Out: An RCA output for connection to a subwoofer.

Subwoofer: A driver designed to operate over the low bass portion of the audio range. Also refers to a system consisting of a woofer and its enclosure which are physically separate from the upper range loudspeakers.

Surround Speakers: Speakers located in the side or rear for surround channel effects.

Treble: The upper part of the frequency spectrum, consisting of frequencies above about 1300Hz.

Tweeter: A small driver designed to reproduce high frequencies.

Watt: A measure of electrical power, combining the voltage with the electrical current required to drive the loudspeaker.

Weight: Low frequencies below 50Hz.

Woofer: A driver designed to operate over the bass portion of the audio range.

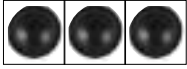

Limited Warranty Valid Only in the U.S.A.



Warranty Period

For a period of 5 years for parts and 5 years for labor (1 year parts and 90 days labor for electronics) from the date this product is first purchased from an authorized NHT dealer, Now Hear This (NHT) warrants that if it fails to function properly due to a manufacturing defect, despite its being installed and operated according to these instructions and used under normal conditions, it will be either replaced or repaired with new or rebuilt parts (both at NHT's option) with a unit of comparable value without charge to you.

What's Not Covered

Altered, defaced or removed serial numbers void this warranty.

This warranty does not cover any product used in trade, business, industrial or commercial applications.

This warranty also does not cover the cabinet or appearance factors, or costs, defects or damage resulting from misuse, abuse, accident, improper maintenance, alterations or modifications not authorized in writing by NHT, or parts or labor from any source other than an authorized NHT service location.

Damage due to power exposure in excess of the speaker's published power ratings; ie, overpowering, lightning or power surges, are also not covered.

Your Rights

This warranty gives you specific legal rights, and you may have other rights which vary from state to state.

NHT limits this warranty to the purchase price of the product, excludes incidental or consequential damages, and limits its obligations under any implied warranties under state laws to a period not exceeding their warranty periods. As some states do not allow the above limitations, however, they may not apply to you.

To Obtain Service

NHT has appointed a number of authorized service companies throughout the USA who can provide warranty service upon your presenting your sales receipt showing place and date of original owner's transaction.

To find the name and address of the nearest authorized NHT service location, call or write:

AB Tech Services, 17C Airport Drive, Hopedale, MA 01747. 1-800-225-9847

info@abtechservices.com

For your future convenience, please keep this warranty with your sales receipt, and record date and place of purchase for further reference.

Free Manuals Download Website

<http://myh66.com>

<http://usermanuals.us>

<http://www.somanuals.com>

<http://www.4manuals.cc>

<http://www.manual-lib.com>

<http://www.404manual.com>

<http://www.luxmanual.com>

<http://aubethermostatmanual.com>

Golf course search by state

<http://golfingnear.com>

Email search by domain

<http://emailbydomain.com>

Auto manuals search

<http://auto.somanuals.com>

TV manuals search

<http://tv.somanuals.com>