

USER MANUAL

FOR NEUNEO MPEG4 DVD PLAYER

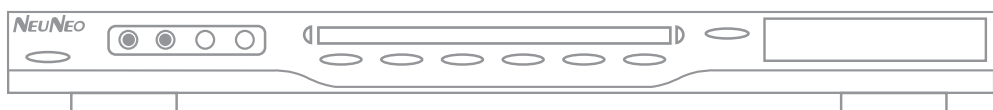

NEUNEO

<http://www.neodigits.com>

CONTENTS

IMPORTANT NOTICE	1
SAFETY INSTRUCTION	1
GET TO KNOW THIS PLAYER	2
UNIQUE FEATURE OF THIS PLAYER	2
TECHNICAL SPECIFICATIONS	3
WHAT'S ON THE FRONT PANEL	4
WHAT'S ON THE BACK PANEL	4
WHAT'S ON THE REMOTE CONTROL	5
START TO USE THIS PLAYER	6
HOW TO OUTPUT VIDEO TO THE TV OR PC MONITOR	6
HOW TO OUTPUT AUDIO TO THE TV OR AMPLIFIER	7
POWER ON THE PLAYER AND TV	8
ENTER THE SETUP MENU	8
THE NAVIGATION SYSTEM IN THE SETUP	9
GENERAL SETUP	9
AUDIO SETUP	10
VIDEO SETUP	13
PREFERENCE SETUP	14
PASSWORD SETUP	15
USE THIS PLAYER TO PLAY DVD/VCD/SVCD/CD/HDCD	16
GENERAL INSTRUCTION	16
USE THIS PLAYER TO PLAY MPEG4/MP3/WMA/JPEG FILES	17
HOW TO USE THE FILE NAVIGATION SYSTEM	17
HOW TO CREATE A PLAY LIST	18
STORE FILES ON A RECORDABLE DISC	19
ADDITIONAL FEATURES	19
OTHER FEATURES	20
USING KARAOKE	20
CHANGING REGION CODE OF THIS PLAYER	20
OTHERS	21
USEFUL NOTES	21
TROUBLESHOOTING	21

SAFETY INSTRUCTION

Warning:

To prevent the risk of fire or electric shock, do not expose this unit to rain or moisture. High voltage components in it so do not attempt to open the enclosure. Only qualified personnel are allowed for maintenance.

Caution:

This DVD player contains laser system.

Read this manual carefully and get familiar with the instructions before operating.

After reading this manual, please keep it for future reference.

To prevent direct laser radiation, do not attempt to open the enclosure. Visible laser beam will radiate when the enclosure is opened or when the interlock device is released. Do not stare at the laser-beam.

To avoid damaging the loader of the unit, please don't pull or drag the tray of the loader when operating and switch off the power supply only when "NO DISC" is displayed.

Never place other things or articles upon the player, otherwise it may cause improper playback.

The logo for NEU NEO is displayed in a stylized, outlined font. The letters 'NEU' are in a larger, bold font, and 'NEO' is in a slightly smaller, bold font. The entire logo is rendered in a light gray color with a white outline.

<http://www.neodigits.com>

UNIQUE FEATURES OF THIS PLAYER

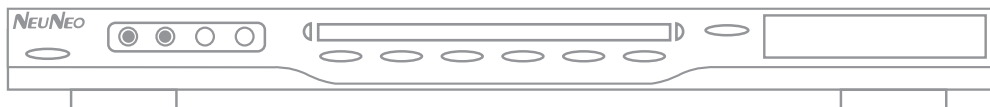

- Based on next generation MPEG4 Chipset --- MTK1389, MTK1389 is DivX™ Certified and support raw MPEG1/MPEG2/MPEG-4 Avi, DivX™* (all version includes ver 3.11, 4, 5 and up), Xvid, VBR MP3, WMA, Jpeg, PhotoCD, HDCD, burn your favorite PC format files into CDR and watch on big screen TV!
- Offers the best MPEG4 playback quality and compatibility, supports high level MPEG4 feature like Qpel (Quarter pixel), GMC (Global Motion Compensation) and advance noise reduction.
- 100% hardware based MPEG4 decoder, can fast forward/back forward MPEG4 video upto 32X speed. 100% compatible with old DivX™ 3.11 version codec.
- Build-in six 12-bit, 108Mhz video DACs, offers video quality which only available in highend DVD players before. New MDDi (Media Direct De-Interlacing) Progressive scan technology.
- Supports all recordable media format -- CDR/RW, DVD-R/RW and DVD+R/RW. Put multiple movie files in one single DVDR and play them all!
- DVD (Region Code Free), DVD-R/RW , DVD+R/RW, VCD and SVCD. Support DVD Aspect Ratio 4:3 Pan Scan, 4:3 Letter Box, and 16:9 Wide Screen. Parental lock, Multi Language(Sound Track), Multi Subtitle and Multi Angle for DVD playback. Plays Pal 16:9 Anamorphic DVD on an NTSC TV without the "squeeze effect"
- Support Firmware upgrade. New firmware will be released by MTK and will support future new codec.
- PAL and NTSC S-Video, Component Video (YPbPr), VGA and Composite output. Play PAL movie on NTSC TV or Play NTSC movie on PAL TV
- Optical, Coaxial S/PDIF and RCA output. Support Dolby 5.1 and DTS digital output or 2 Channels analog stereo output. Build-in Dolby 5.1 decoder, support 5.1 channel output.

TECHNICAL SPECIFICATIONS

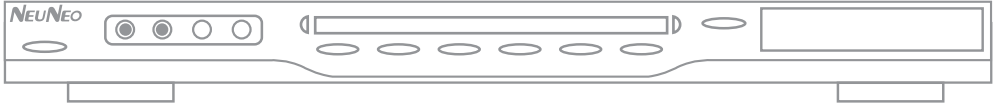

Support Meida Type	CDROM, CD-R/RW, DVD, DVD-R/RW, DVD+R/RW, Audio CD, Video CD, Supoer Video CD, HDCD, Kodak PhotoCD
Support Codec	Divx (3.11 ~ 5.x), XVID, MPEG1, MPEG2, MPEG4, MP3(VBR), WMA, JPEG, PhotoCD
Firmware	Upgradable
Audio response	20Hz-20kHz
Audio s/n ratio	>95dB
THD	0.003%
Channel Separation	85 dB
Audio DAC	96Khz/ 24 bit Audio D/A Converter
Video DAC	six pair 12 bit 108Mhz Video D/A Converter
Video Resolution	520 lines or higher(Progressive Scan)
Video S/N	60 dB
Audio output (analog)	Electric level output: 2V resistance: 10 Kohm
Audio output (digital)	Electric level output: 0.5Vp--p resistance: 75ohm
Video output	Electric level output:1Vp--p resistance: 75ohm unbalanced negative
S-Video output	Electric level output: brightness (Y) 1Vp-p, chrominance (C): 0.286Vp-p, resistance: 75ohm
Power	Universal Auto Switching 100-240V, 50/60Hz
Power consumption	25W
Dimensions	17 x 9.8 x 1.45 Inch (430x 250 x 37 mm)
Weight	4 lb (1.8KG)

WHAT'S ON THE FRONT PANEL

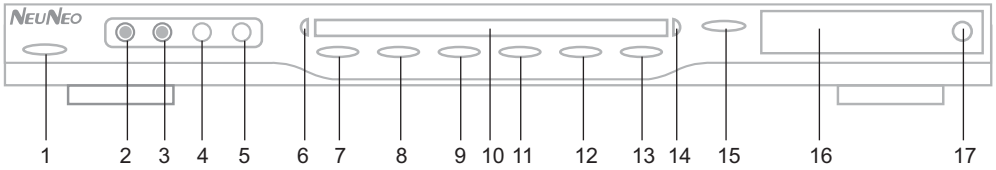

- | | |
|------------------------|----------------------------------|
| 1. Power button | 10. Disc tray |
| 2. Microphone Jack 1 | 11. Left / Right channel switch |
| 3. Microphone Jack 2 | 12. Play / Pause |
| 4. Microphone Volume 1 | 13. Stop |
| 5. Microphone Volume 2 | 14. Power LED Light |
| 6. Power LED Light | 15. Disc tray open/close button |
| 7. Previous | 16. Display window |
| 8. Next | 17. Remote control signal sensor |
| 9. NTSC/PAL switch | |

WHAT'S ON THE BACK PANEL

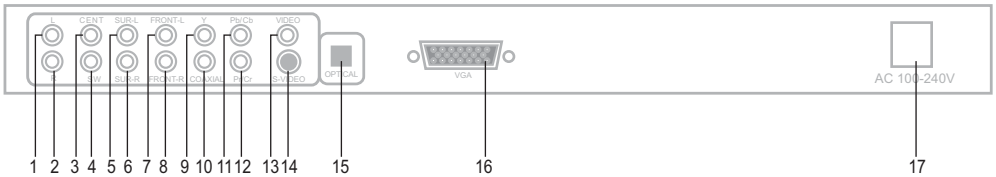

- | | |
|--|---|
| 1. 2 channel stereo left channel output | 10. Coaxial output |
| 2. 2 channel stereo right channel output | 11. Component Pb/Cb output (to blue line) |
| 3. 5.1 channel center speaker output | 12. Component Pr/Cr output (to red line) |
| 4. 5.1 channel subwoofer output | 13. Composite video output |
| 5. 5.1 channel left surround speaker output | 14. S-video output |
| 6. 5.1 channel right surround speaker output | 15. Optical output |
| 7. 5.1 channel left front speaker output | 16. VGA output |
| 8. 5.1 channel right front speaker output | 17. Power cable to 110-240V power source |
| 9. Component Y output (to yellow line) | |

WHAT'S ON THE REMOTE CONTROL

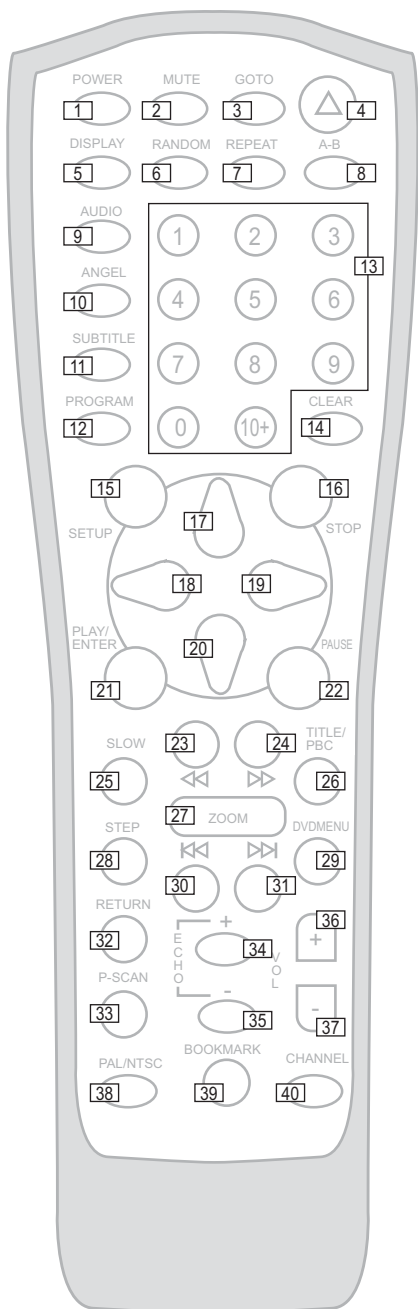

1. Power on/off.
2. Mute button, press once to mute,twice to un-mute
3. Goto. Play from the desired location.
4. Eject. Open or close disc tray.
5. Display. Display or hide play information.
6. Random. Random play.
7. Repeat. Repeat play.
8. A-B Repeat the selected.
9. Audio. Switch audio track.
- 10.Angel. Switch play angel.
- 11.Subtitle. Switch subtitle.
- 12.Program. Enter the play list edit mode.
- 13.Number buttons.
- 14.Clear. Clear input numbers.
- 15.Setup. Enter setup menu for this player.
- 16.Stop.
- 17.Up cursor.
- 18.Left cursor.
- 19.Right cursor.
- 20.Down cursor.
- 21.Play/Enter. Playback / Select button.
- 22.Pause.
- 23.Fast backward button.
- 24.Fast forward button.
- 25.Slow. Slow motion playback.
- 26.Title/PBC. Enter DVD title menu or VCD 2.0 PBC menu.
- 27.Zoom. Zoom in / out button.
- 28.Step. Play frame by frame.
- 29.Prev. Skip backward.
- 30.Next. Skip forward.
- 31.DVD menu. Enter DVD root menu.
- 32.Return. Back to previous menu/clearing input numbers.
- 33.P-Scan. Switch between progressive scan and interlace.
- 34.Echo +. Rise tone.
- 35.Echo -. Fall tone.
- 36.Vol+. Increase volume.
- 37.Vol-. Decrease volume.
- 38.PAL/NTSC. Switch between PAL and NTSC system.
- 39.Bookmark. Bookmark the playback material / add item to play list.
- 40.Channel. Switch to left/right sound channel.

HOW TO OUTPUT VIDEO TO THE TV OR PC MONITOR

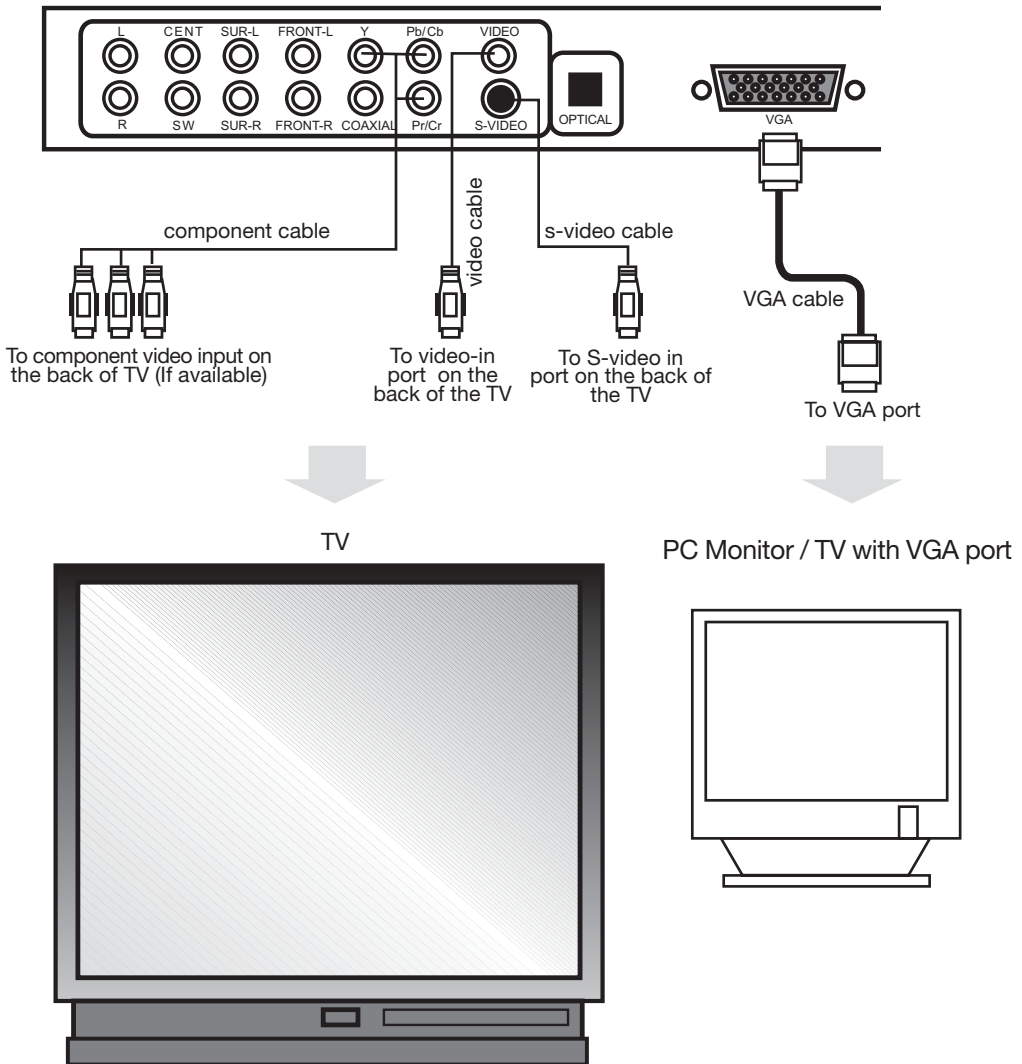

HOW TO OUTPUT AUDIO TO THE TV / AMPLIFIER

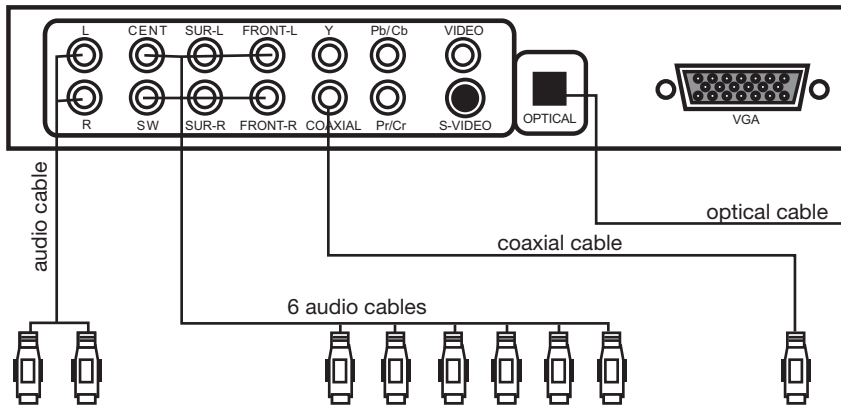

2 channel audio connect to the left / right audio input on

6 audio cables connect to left/right /center/left surround/right surround and subwoofer audio input on the back for the amplifier accordingly.

Connect either coaxial cable or optical cable to the coaxial port or optical port on the back of the amplifier.

TV

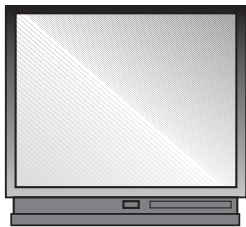

2 Channel Stereo Amplifier

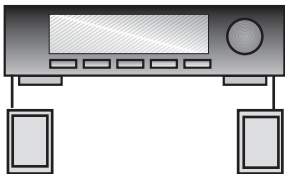

left speaker right speaker

5.1 Channel Amplifier

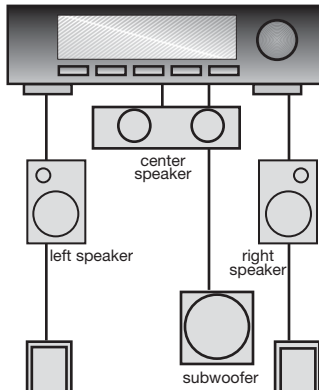

left surround speaker right surround speaker

5.1 Channel Amplifier with built-in Dolby Digital / DTS decoder

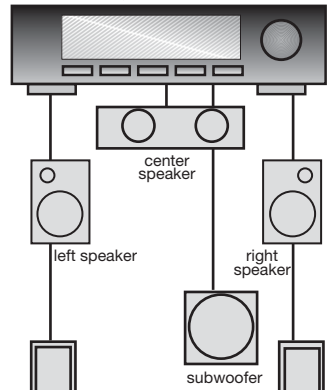

left surround speaker right surround speaker

POWER ON THE PLAYER AND TV

1. Connect this player with your TV / PC Monitor / Projector, amplifier (if available) and power source.
2. Turn on this player by click the power button on the front panel.
3. Turn on TV and switch it to the appropriate video mode (composite video input, S-video input or component video input).
4. If you connect the TV via component video input and get no image on the TV screen, please press “P-SCAN” button on the remote control a couple times until the TV shows image.
5. If you get black/white image on the TV screen, click “PAL/NTSC” button on the remote control to switch the player to the appropriate TV system (PAL or NTSC).
6. You should be able to see the welcome screen on the TV by now.

ENTER SETUP MENU

1. Click “SETUP” button on the remote control.
2. You will see the general setup page show up on the screen.

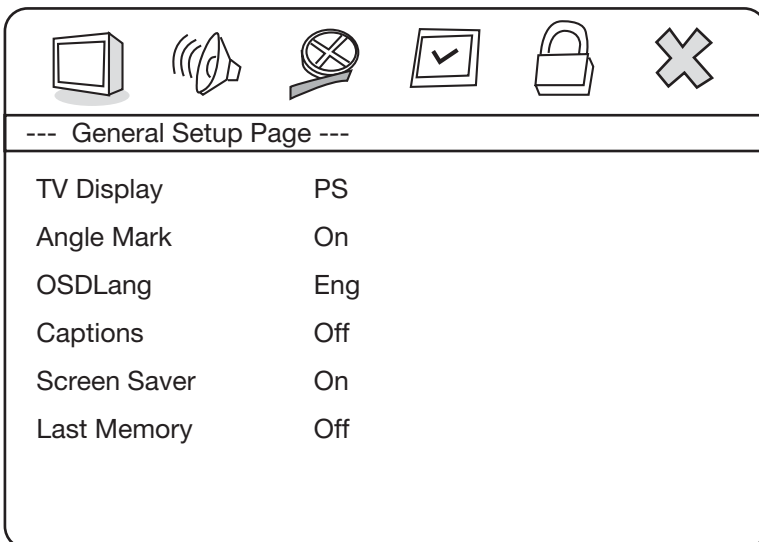



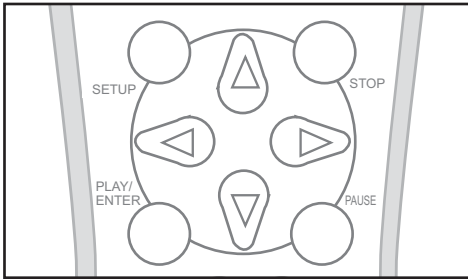



THE NAVIGATION SYSTEM IN THE SETUP



1. Left / right / up / down button let you choose the menu cursor left / right / top / down.
2. Left button-- back to the previous menu.
3. Right button -- enter sub-menu
4. Enter -- make selection
5. Menu -- enter the menu / exit the menu

GENERAL SETUP

--- General Setup Page ---

TV Display	PS
Angle Mark	On
OSDLang	Eng
Captions	Off
Screen Saver	On
Last Memory	Off

TV Display

To set the aspect ratio of this player's output image.
 Optional settings: Normal/PS (Pan-scan), Normal/LB (Letterbox format), Wide (16:9 format).

Angel Mark

When a DVD title with multi-angle is played, the user will be able to view a particular angle.
 Optional settings: On/off

GENERAL SETUP

- OSD Lang** This item is used to set the prompts language on the screen.
Optional settings: English / Chinese
- Captions** To play the enclosed captions on some DVD title.
Optional settings: On/off
- Screen Saver** Open or close the screen saver function.
Optional settings: On/off
- Last Memory** When play DVD / CD / VCD, after you press “stop” button, the player will remember the position of current playing program. Next time you turn on this player, you just need to click “play” button and the player will jump to the “last memory” position.
Optional settings: On/off

AUDIO SETUP

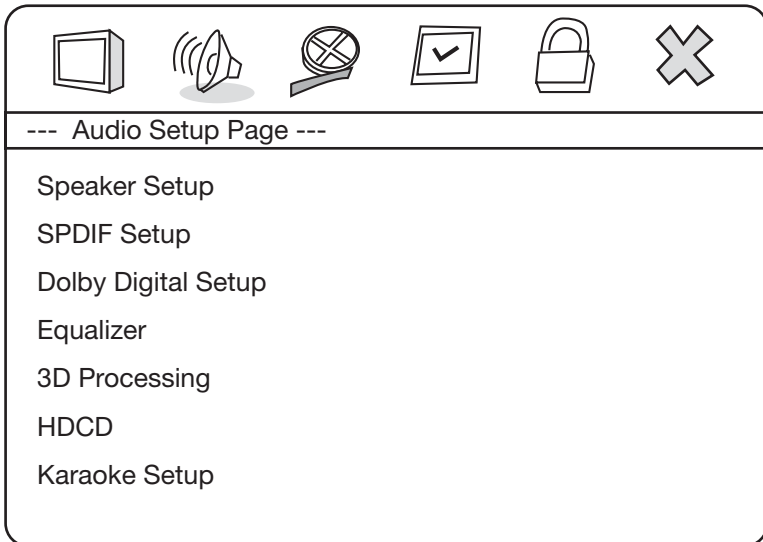

AUDIO SETUP

Speaker Setup



Downmix

You don't need do anything in speaker setup when you are using digital audio output (optical / coaxial). This is for user who are using this player's built-in 5.1 channel output function.

If you only need 2 channels to enjoy music, it is recommended to select "Stereo" option. When you use this player's built-in Dolby Digital decoder to play 5.1 channel sound, please select "off".

Front Speaker
Center Speaker
Rear Speaker

To select speaker size. You can select "Large" or big size speaker, "Small" for small size speaker. You can turn off the Center/Rear speaker when you choose "off"
Optional settings: Large, Small, Off.

Sub Woofer

You can turn on/off the sub woofer speaker.
Optional settings: On, Off

Test Tone

To play test tone to test each speaker connect to the player. Optional settings: On, Off

Dialog

This function is to adjust the volume of dialog in the playing material. (Only available when you choose Downmix to 2 channels option. Optional settings: On, Off

Post DRC

This option is for compress audio signal with wide dynamic range proportionally to reduce intense impact to speakers.
Optional settings: On, Off

SPDIF Setup



Spdif output

This option is from users who are using digital audio output (optical / coaxial).

This is for choosing the digital audio format from optical/coaxial output. If you are using an ampfillier with built-in Dolby/DTS decoder, please choose "SPDIF/RAW".
Optional settings: SPDIF OFF, SPDIF/RAW, SPDIF/PCM, Manual.

AUDIO SETUP

Spdif output This is for choosing the digital audio format from optical/coaxial output. If you are using an amplifier with built-in Dolby/DTS decoder, please choose "SPDIF/RAW".
Optional settings: SPDIF OFF, SPDIF/RAW, SPDIF/PCM, Manual.

LPCM Out Set LPCM output rate.
Optional settings: 48K, 96K

Dolby Digital Setup



Dual mono Optional settings: Stereo, L-mono, R-mono, Mix-mono.

Dynamic To set the linear compression ratio to get different compression result. Optional settings: Off, 1/4, 1/2, 3/4, Full.

Channel Delay

To set delay time of the center/surround/subwoofer speaker.

Equalizer Setup



EQ Type To set EQ mode.
Optional settings: None, Rock, Pop, Live, Dance, Techno, Classic, Soft.

Bass boost To open/close bass boost. Optional Settings: On, Off.

Super bass To open/close super bass. Optional Settings: On, Off.

Treble bass To open/close treble bass. Optional Settings: On, Off.

3D Processing Setup



Reverb To set Reverb mode.
Optional settings: Off, Concert, Living Room, Hall, Bathroom, Cave, Arena, Church.

AUDIO SETUP

HDCD Setup



Filter

To setup HDCD playback filter.
Optional settings: 1X (44.1K), 2X (88.2K)

Karaoke Setup



MIC

To turn on/off microphone for Karaoke.
Optional settings: On/Off

VIDEO SETUP

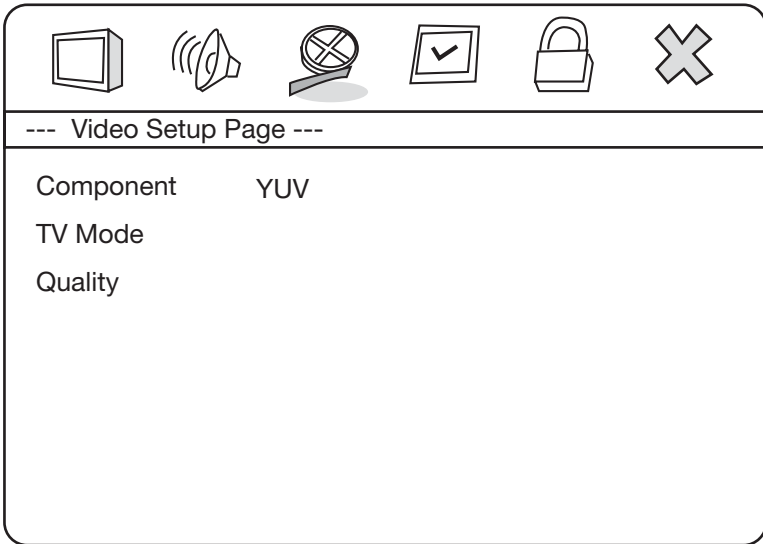

Component

To set the component output mode, YUV for normal component connection, VGA for enable VGA output.
Optional Settings: Off, YUV, VGA

TV Mode

To switch from Progressive Scan and normal Interlace Scan.
Optional Settings: Interlace, P-Scan (Progressive Scan)

Quality

To adjust output video quality.
Optional Settings: Brightness, Contrast, Hue, Saturation.

PREFERENCE SETUP

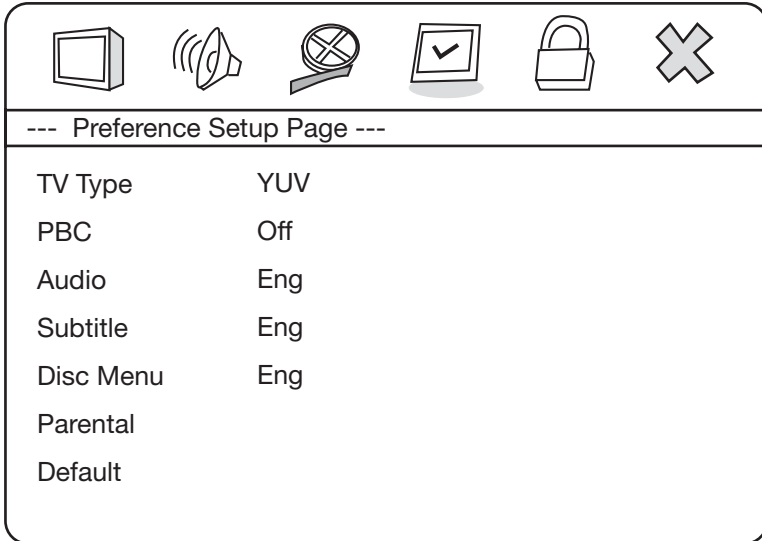

- TV Type** To set the TV system. Optional Settings: PAL, NTSC, Multi.

- PBC** To enable PBC (Play Back Control) menu for VCD 2.0 version VCD or Super VCD (SVCD). Optional Settings: On, Off.

- Audio** To set the default audio language when playing DVD.
Optional Settings: English, French, Spanish, Chinese, Japanese, Korean, Russian, Thai.

- Subtitle** To set the default subtitle when playing DVD.
Optional Settings: English, French, Spanish, Chinese, Japanese, Korean, Russian, Thai.

- Disc Menu** To set the default language menu when playing DVD.
Optional Settings: English, French, Spanish, Chinese, Japanese, Korean, Russian, Thai.

- Parental** To enable parental lock when playing DVD. User require to enter password (can be set in the password setup) when playing certain rating DVD titles. Optional Settings: KID, G, PG, PG13, PGR, R, NC17, Adult, Off.

Default Reset to default setting. Optional Settings: On, Off.

PASSWORD SETUP

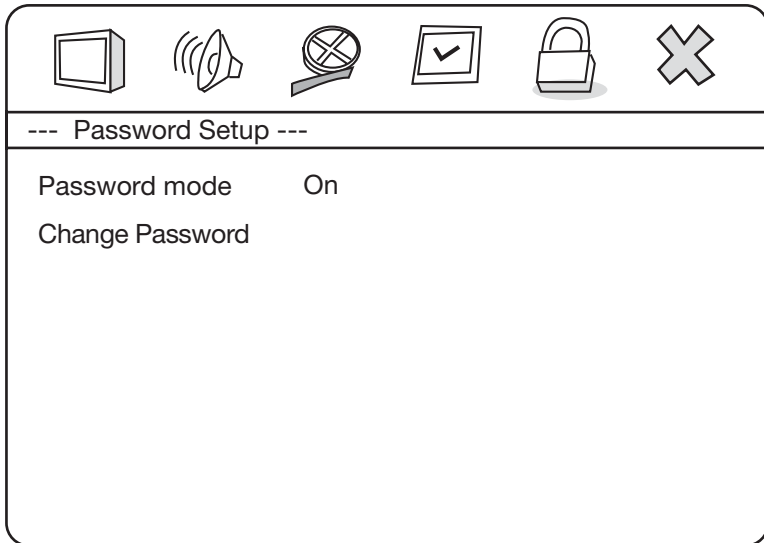

- Password mode** Enable Password for changing parental lock.
Optional Settings: On, Off.
- Change Password** Change the password.
Default password: 136900

GENERAL INSTRUCTION

Put DVD/CD/SVCD/CD/HDCD disc inside the disc tray, then close the tray. The player will automatically start to play these materials.

Some DVD has built-in title menu. The player will automatically show the title menu of the player. You can always go back to the title menu by pressing Title/PBC button or go back to the initial menu by pressing DVD Menu button.

Some VCD, Super VCD has PBC (Playback control) menu, the player will show this menu first unless you disable the "PBC" function in preference setup. You can always jump back to PBC menu by pressing "Title/PBC" button.

You can jump directly to certain chapter of DVD/VCD or sound track on music CD by pressing the chapter number directly on the remote control.

You can fast forward / back forward (upto 32x) or slow playback (upto 1/16) on DVD/VCD/SVCD.

Upto 4X zoom is available for all video materials (DVD/SVCD/VCD). (Using zoom button)

While playing CD, you can choose 4 different play mode (single, repeat, shuffle, random) by using repeat button.

HOW TO USE THE FILE NAVIGATION SYSTEM

When put a disk with MPEG4 / MP3 / WMA / JPEG files into the player, the file navigation window will show up.

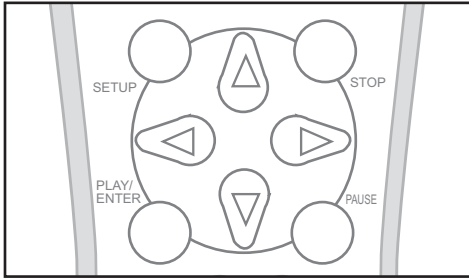

Left / right / up / down button let you choose the cursor left / right / top / down.

ENTER/PLAY: to enter/leave a directory or play a selected file.

Program and Bookmark: to create a play list.

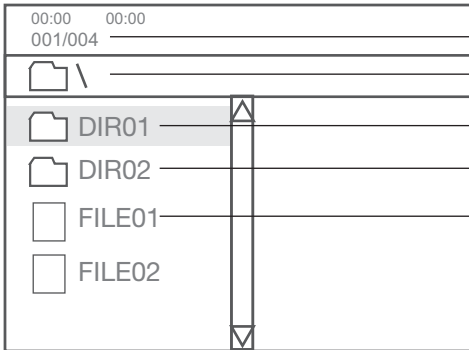

Selected file number / Total file number

Directory Location

Selected/high lighted file / folder

Folder

Playable file

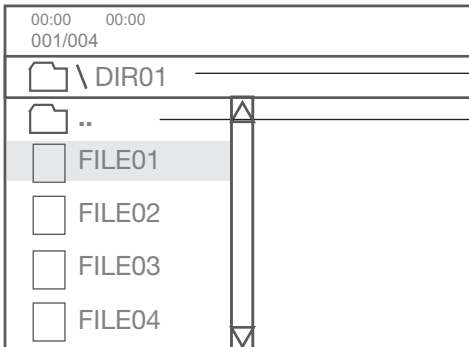

Directory Location

Go back to the previous directory

HOW TO USE THE FILE NAVIGATION SYSTEM

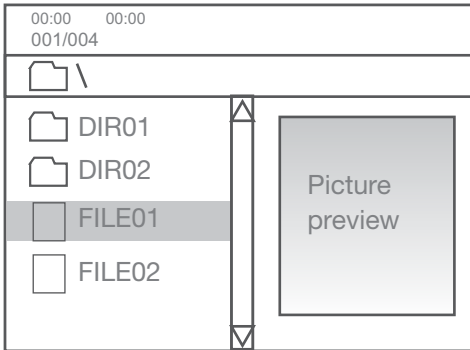

Jpeg file preview will be displayed on the right window when a jpeg file is selected.

When display a JPEG picture on the TV screen, you can use left/right/up/down cursor button to rotate the image in any direction.

When playing MP3, you can still go to different folder to view JPEG files.

HOW TO CREATE A PLAY LIST

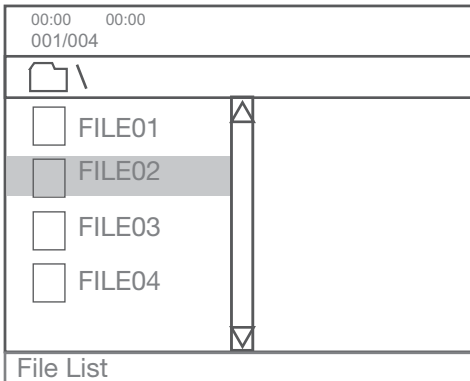

Press program button on the remote control, enter the file list mode. In this mode, all the files (includes files in all different directories if available) will all display in this file list window.

Select file you want to put in play list by press bookmark button.

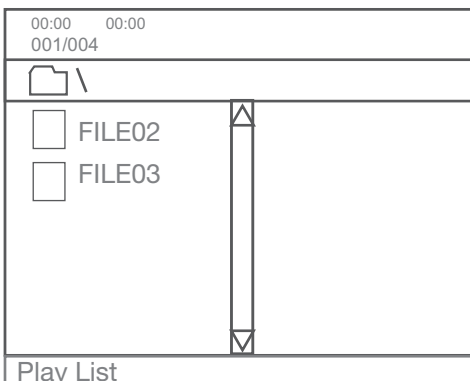

Press program button again to enter play list mode. In this window, all files you have selected in the previous window will be displayed. You can start to play the play list by click "enter" on any file in this play list.

STORE FILES ON A RECORDABLE DISC

You can store any MPEG4 (DivX / Xvid), MPEG1/2, MP3, WMA, JPEG files on a recordable disk and then play on this player. CD-R, CD-RW, DVD-R, DVD-RW, DVD+R, DVD+RW are supported.

There is no limitation about how many files you can put on one disk. Folders are supported. One folder can store upto 999 different files. For example, you can put about 5-7 DivX movies on one DVD+R disk, or you can put 100-200 MP3 songs on one CD-R. You can put different type media files on one disk, for example, you can put Jpeg files, MP3, WMA, MPEG4 files on one single disk.

This player determine the file type by reading the extension name of each file. Extension name *.avi, *.mpg, *.mpeg, *.mp3, *.wma, *.jpg are supported. If your file has a different extension name, it will not be recognized by this player. For example, if you want to put several SVCDs on one DVD-R, you can rename the SVCD file (*.dat) to *.mpg file.

Please burn the recordable disk in normal ISO9660 disc format. Long file name is supported.

ADDITIONAL FEATURES

For all files in one disk, you can use repeat button to choose 6 play mode (Repeat, Shuffle, Single, Repeat All, Repeat Folder, Random), then the player will play all files on the disk automatically according to the play mode you choose.

You can fast forward / back forward upto 32X on any video file (MPEG4, DivX, Xvid and etc). (Using fast forward / back forward button).

You can zoom in/out upto 4X on any video file or Jpeg file. (Using zoom button)

USING KARAOKE

In the Audio Setup, turn on the microphone input.

Plug the microphone into the mic slot on the front panel. You can adjust microphone volume by adjusting the mic vol control on the front panel.

While playing Karaoke VCD / CD, you can switch the sound channel by using "channel" button.

You can adjust the echo level by using the echo+ and echo- buttons.

CHANGING REGION CODE OF THIS PLAYER

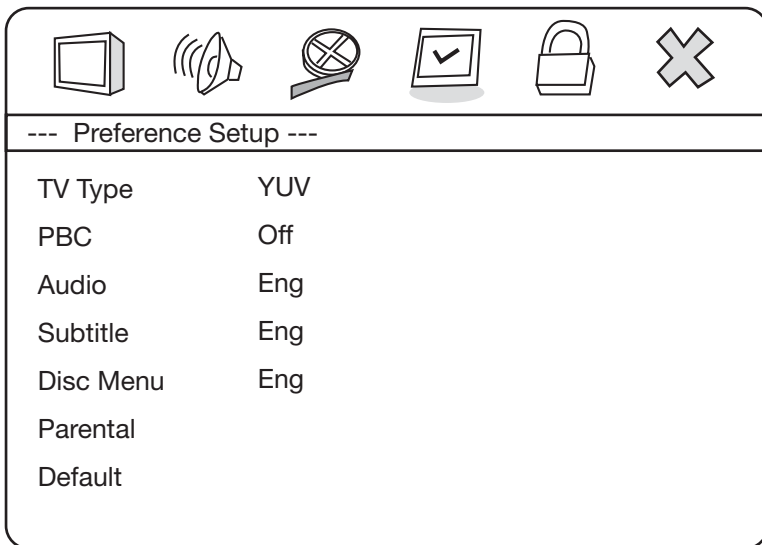

Goto Preference Setup Page.

Press 1006.

The region code adjust window will show up. Use left/right cursor button to adjust region code (0 -- region code free, 1--6 region code 1-- 6), PLAY/ENTER to confirm the change.

USEFUL NOTES

In order to prolong the service life of your player, it is recommend to wait at least 30 seconds before you turn it on again after switching it off.

Turn off power after operation.

Only use the power supply of the nominal voltage, otherwise the player will not be operational or even be damaged.

In case of occasional player halt, please turn it off and turn it on again.

Don't turn off this player while it is still showing "loading" on the display.

TROUBLESHOOTING

Symptom	Cause	Solutions
No sound	Signal not properly connected Disc warped or dirty. Player in mute status.	Connect signal securely. Clean your disc. Press MUTE button again.
No picture	Signal not properly connected. TV not set for proper system.	Connect signal securely. Reset the AV/TV status of your TV set.
No color	TV system not right. TV set color not properly adjusted.	Press PAL/NTSC button. Adjust color of the TV set.
No disc reading	No disc in the player. Disc not properly loaded. Condensation on the laser head.	Load a disc. Reloaded a disc, with the label side facing up. Turn on the player, unload the disc and leave it on for about an hour.
Remote control failure	Remote control not pointing to the sensor window. Remote control's operating distance more than 8 meters away from the TV. Batteries low.	Use the remote control properly. Use the remote control within 8 meters range. Replace the batteries.
Temporary function failure	Mal-fabricated disc used. Wrong buttons pressed. Static leakage into the player from outside.	Wait 5-10 secs and the player will return to normal. Operate once more. Turn off the player for 1 to 2 mins, turn it on again.
Picture rolling	TV set not properly adjusted.	Re-adjust system of the TV set.

*NEU*NEO

<http://www.neodigits.com>

Free Manuals Download Website

<http://myh66.com>

<http://usermanuals.us>

<http://www.somanuals.com>

<http://www.4manuals.cc>

<http://www.manual-lib.com>

<http://www.404manual.com>

<http://www.luxmanual.com>

<http://aubethermostatmanual.com>

Golf course search by state

<http://golfingnear.com>

Email search by domain

<http://emailbydomain.com>

Auto manuals search

<http://auto.somanuals.com>

TV manuals search

<http://tv.somanuals.com>