

NESCO®

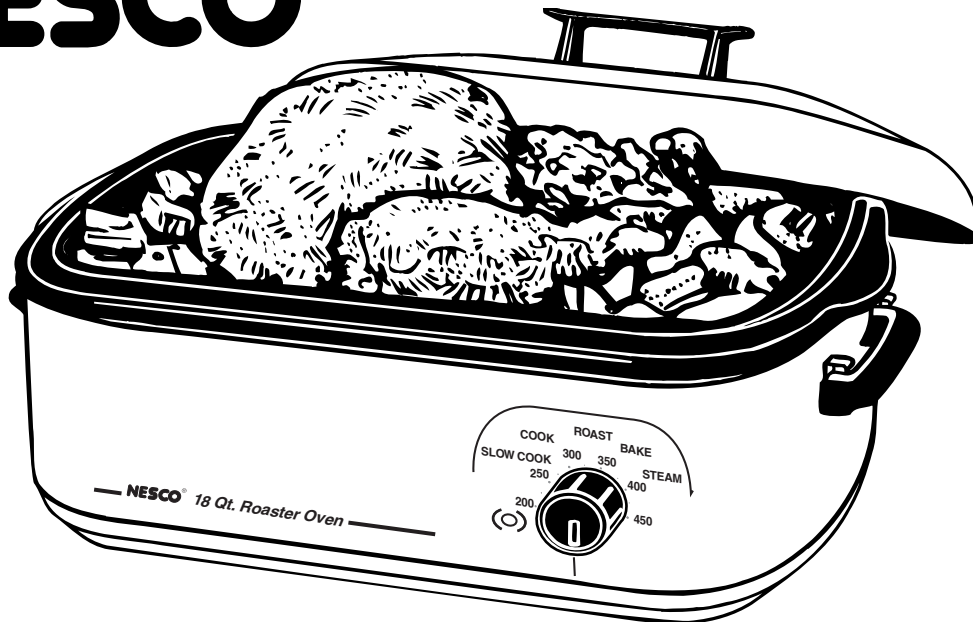

18-Qt. ROASTER OVEN

USE/CARE AND RECIPE GUIDE

ROASTS!

COOKS!

BAKES!

STEAMS!

SLOW COOKS!

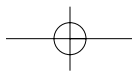

Contents

IMPORTANT SAFEGUARDS	1
INTRODUCTION	2
GET TO KNOW YOUR ROASTER OVEN	2
HOW TO USE AND CARE FOR YOUR ROASTER OVEN	3-4
RECIPES, HINTS, AND HELPFUL CHARTS	
ROAST CHART	5
BAKE CHART	6
ROAST	7
COOKING FOR A GROUP	11
COOKING FOR A FAMILY	16

NESCO® and CIRCLE OF HEAT® are registered trademarks of The Metal Ware Corporation.

The Metal Ware Corporation
1700 Monroe St., P.O. Box 237
Two Rivers, WI 54241-0237
Phone: 920-793-1368
Fax: 920-793-1086

Visit our Website at <http://www.nesco.com>
©The Metal Ware Corp., 2000
Made in the U.S.A. Printed in the U.S.A.

Revised 10/00

NESCO® 18-Qt. Roaster Oven

Congratulations!

Congratulations on the purchase of your new NESCO Roaster Oven! Please spend a few minutes reviewing this booklet. By doing so, you will learn how to get the most satisfaction out of your NESCO Roaster Oven. Enjoy your cooking with our compliments!

Important Safeguards

When using electrical appliances, basic safety precautions should always be followed, including the following:

- 1. READ ALL INSTRUCTIONS.**
- Do not touch hot surfaces. Use handles or knobs.
- Always plug appliance cord into the wall outlet, then adjust temperature control to the desired temperature. To disconnect, turn control to lowest setting, then remove plug from wall outlet.
- To protect against electrical shock, do not immerse this appliance, including cord and plug, in water or other liquid.
- Close supervision is necessary when any appliance is used by or near children.
- Unplug from outlet when not in use and before cleaning. Allow to cool completely before putting on or taking off parts, and before cleaning.
- Do not operate any appliance with damaged cord or plug or after the appliance malfunctions or has been damaged in any manner. Return appliance to NESCO Factory Service Department for examination, repair or adjustment.
- The use of accessory attachments not recommended by the manufacturer may cause injuries.
- Do not use outdoors.

- Do not let cord hang over edge of table or counter, or touch hot surfaces.
- Do not place on or near a hot gas or electric burner or in a heated oven.
- Extreme caution must be used when moving an appliance containing hot oil or hot liquids.
- Do not use appliance for other than its intended use, as described in this manual.
- Do not use metal scouring pads on the exterior surface of the Roaster Oven. Pieces can break off the pads and touch electrical parts creating a shock hazard.
- Always place the Roaster Oven on a non-flammable, non-burnable, heat resistant surface when cooking. Never place it on carpet, furniture, or other combustible materials. Operate oven in a well-ventilated area away from walls and other combustible materials.

Save These Instructions

This Appliance Is For Household Use.

A short power-supply cord is to be provided to reduce the risk resulting from becoming entangled in or tripping over a longer cord. Longer detachable power supply cords or extension cords are available and may be used if care is exercised in their use. If a longer detachable power-supply cord or extension cord is used, the marked electric rating of the cord set or extension cord should be at least as great as the electrical rating of the appliance, and the cord should be arranged so that it will not drape over the countertop or tabletop where it can be pulled on by children or tripped over unintentionally.

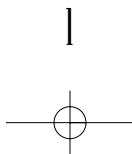

Introduction

Now you are ready to discover more ways to make meals that are both healthful and delicious. And you are now ready to experience first-hand the convenience and versatility of this compact portable electric cooking appliance.

Take a few minutes to read through this Guide. You'll find out how to better use the Roaster Oven. And you'll find a selection of healthful and fun recipes – all carefully tried and tested for your enjoyment.

The NESCO Roaster Ovens have a long tradition in family home cooking, beginning the the 1930s. Yet, very few cooking appliances can demonstrate that they are as up-to-date and useful today as they were in the past. NESCO Roaster Ovens have truly kept pace with cooking styles, preferences, occasions and family sizes.

In a short time, you will see the many ways to use your 18-Qt. Roaster Oven. Its portability makes it a movable main cooking appliance at some times, and a valued supplementary appliance at other times. Use it at home on your countertop in your kitchen (no more kitchen heat!)...or in a covered patio, basement or garage...or away from home in a cabin. Whenever you use your Roaster Oven, you can prepare a wide range of favorite foods in different ways: baked, slow cooked, roasted, steamed or poached. And serve your foods buffet-style or at table-side, right in the Roaster Oven. Moist and good tasting foods are yours because of NESCO's special CIRCLE OF HEAT® construction. You will taste the difference the very first time you use the Roaster Oven.

So, start cooking with NESCO. Explore all the ways to get the most out of this special home cooking appliance.

Get To Know Your 18-Qt. NESCO Roaster Oven

COVER. Heavy gauge high-profile aluminum Cover is designed to control heat and moisture efficiently. Two vent-holes are provided to allow just the right amount of moisture to escape during cooking. During the cooking process, steam will accumulate inside the cookwell. Always stand to the side when removing the lid, and tilt the cover away to divert escaping steam.

RACK. A chrome-plated steel or non-stick Rack provides cooking flexibility. The Rack fits into the Cookwell and has convenient lift-out handles.

COOKWELL. The porcelain enamel or non-stick Cookwell has a full 18-Qt. capacity. It is removable for easy cleanup in the dishwasher or sink, or for food storage in the refrigerator.

HEATWELL and BODY. The sides of the 18-Qt. Roaster Oven contain the exclusive CIRCLE OF HEAT® element for even, moist cooking, plus the added advantages of thick insulation and a full-range automatic oven temperature control. **NEVER PLACE FOOD OR WATER DIRECTLY IN THE HEATWELL.**

AUTOMATIC TEMPERATURE CONTROL. Regulates cooking temperature to maintain the dial setting in the Roaster interior.

SIGNAL LIGHT. The glow of the light indicates the Roaster is heating. When the desired temperature is reached, signal light goes out. It goes off and on during cooking indicating that the temperature is automatically maintained.

TEMPERATURE GUIDE. The conveniently placed guide gives recommended temperatures for commonly roasted foods.

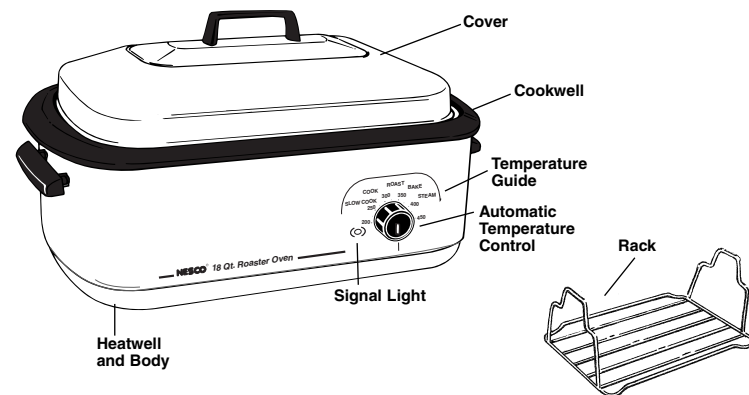

NESCO® 18-Qt. Roaster Oven

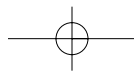

How To Use And Care For Your 18-Qt. NESCO Roaster Oven

BEFORE USING FOR THE FIRST TIME

1. Unpack your NESCO Roaster Oven completely. Remove the Cookwell and remove all packing materials and information labels. **Place the Roaster Oven in a well-ventilated area on a heat resistant surface.** Set the temperature control dial to its minimum setting. Plug the cord into a 120 volt AC outlet, set the control dial to its maximum setting 450°F. Operate the Roaster Oven empty (without the Cookwell and Cover) for about 60 minutes, or until any odor or smoke disappears. Some smoke and odor is a normal part of "curing" the heating element, and will not occur while cooking. When curing is completed, turn the temperature control to its lowest setting, unplug the unit, and allow it to cool.
2. Wash the Cover, Cookwell and Rack in warm, sudsy water. Rinse and dry. See "Care and Cleaning" section for complete cleaning instructions.

To Operate Your Roaster Oven

1. Place the Cookwell into the Heatwell. **Always use the Cookwell for food. NEVER PLACE FOOD OR WATER DIRECTLY IN THE HEATWELL.**
2. Preheating is recommended. To preheat, place the Cookwell into the Heatwell and cover. Be sure the temperature control is turned to the lowest setting, and plug the cord into the 120 volt AC outlet. Set the temperature control to desired temperature. Preheat 20 minutes or until red signal light goes off. Carefully, using hot pads, add food to the Cookwell.
3. The Rack may be used for baking or fat-free roasting. Other foods, such as meats, soups and stews, are prepared without the Rack.
4. Replace the Cover. Always cook with the Cover in place.
5. If the Roaster Oven has not been preheated, turn the temperature control to Off. Plug the cord into a 120 volt AC outlet. Set the temperature control to the desired temperature. Fill the Cookwell with food as desired.
6. Cook the food for the desired amount of time. When finished, turn the temperature control to lowest setting and unplug the cord from the 120 volt AC outlet. Allow the Roaster Oven to cool, and clean as recommended .
NOTE: COOKWELL, BODY, COVER AND ACCUMULATED STEAM WILL BE HOT. USE CAUTION, AND HOT PADS, TO LIFT COVER OR REMOVE COOKWELL FROM HEATWELL.

*The Roaster Oven Cookwell is easily removed after cooking for clean up.
Just wash it in warm sudsy water or place in the dishwasher.*



NESCO® 18-Qt. Roaster Oven

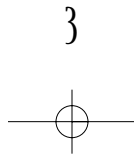

Care And Cleaning

1. After the NESCO Roaster Oven has cooled, remove Cover, Rack (if used) and Cookwell. **Wash Rack and Cookwell in warm sudsy water or place in the dishwasher. CAUTION: Do not put Cover in the dishwasher.**
2. PORCELAIN ENAMEL COOKWELL has a strong finish and provides easy cleaning and years of use. It will not stain and stays attractive, even when used often. However, it will chip if subjected to sharp blows or is mistreated. Water spots or mineral deposits (characterized by a white film on surface) may be removed with household vinegar or non-abrasive cleansers.
3. NON-STICK COOKWELL is made of durable carbon steel. In order to maintain the non-stick surface, the use of rubber, plastic or wooden utensils is recommended. Avoid cutting food in the Cookwell. Use of a non-stick spray on the interior surface is optional. Avoid storing items in the Cookwell which may scratch the surface. When roasting or baking at high temperatures, you may notice an irregular band of discoloration around the sidewalls of the Cookwell. This discoloration is characteristic of the super tough non-stick coating used on the interior of the Cookwell and in no way affects the performance or durability of the finish. With continued use, the discoloration will become less noticeable.
4. Cooked-on food may be removed by using a non-abrasive cleaning pad and a non-abrasive cleanser, such as Soft Scrub® or Bon Ami®. Do not use abrasive cleansers or steel wool as the finish may scratch. **HINT:** To easily remove baked-on food residue, place Cookwell in Heatwell; then fill Cookwell with hot water. Cover and heat at 350°F for 30 minutes. Turn off and allow to cool completely. Wash Cookwell as directed above.
5. **NEVER IMMERS THE ROASTER OVEN IN WATER.** To clean, wipe outside of Roaster Oven with a damp cloth and dry. Do not use abrasive cleansers on exterior surface.

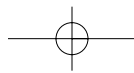

Helpful Hints

ROASTER OVEN SHOULD ALWAYS BE PREHEATED FOR 20 MINUTES.

ROAST

- Roasting meat in your NESCO Roaster Oven keeps it moist and tender. For additional browning, you can add 1/2 Tsp. browning sauce to oil or margarine and brush over skin before roasting.
- Simmering less tender cuts of meat will make them very tender. Adding a gravy or sauce will make them extra flavorful.
- To sear meat, Preheat Roaster Oven at 450°F. Add margarine, Cover, then sear meat for 10 to 15 minutes per side until lightly browned. Stir ground meat once. Time will vary depending on the quantity of meat.
- Alternative browning method for self-basting turkeys: Follow recipe directions with these exceptions: Preheat NESCO Roaster Oven and set temperature at 400°F. Roast turkey at 400°F for the first hour. Reduce heat to 350°F using time in recipe, 13 to 18 minutes per pound. During the last hour of roasting, remove all juice from Cookwell and return temperature to 400°F.

COOK

- Cut-up meats and vegetables should be of uniform size pieces.
- Remember, little moisture escapes during slow cooking so add additional liquid sparingly.

BAKE

- Use the baking rack to place casserole dishes and baking pans on during cooking time. This will allow for more even baking.
- Two loaf pans will fit into the Cookwell. A meat and a vegetable, or two loaves of bread, may be baked at the same time.
- Cover the baking Rack with aluminum foil and use as a baking sheet.
- Most 1 & 2 Qt. casserole dishes, 9-inch pie plates, and most 9x13 baking pans will fit into the Cookwell. Place dish on baking rack for more even baking.
- Three 1-1/2 Qt. pans fit into the Cookwell. Ideal for preparing meat, vegetables and potatoes at the same time. When baking bread, either one or two loaf pans are recommended.
- Convenience foods can be baked in the Roaster Oven. Follow package directions.

STEAM

- No fat is used when steaming, so it's an easy way to cook tasty and nutritious low calorie foods.

SLOW COOK

- When slow cooking, heat is very gradual. This allows a very slow simmer, which is aided by keeping the Cover on; no stirring is necessary.
- To convert a standard recipe to slow cooking: for **each** 30 minutes required in a standard recipe, slow cook about 1-1/2 hours at 200°F to 250°F.
- When slow cooking meats and poultry, it is not necessary to use the Rack. The low temperature prevents the meat from sticking to the bottom of the Cookwell.
- Remember, little moisture escapes during slow cooking, so add additional liquid sparingly.

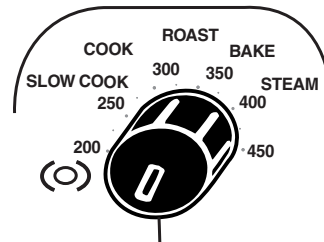

The Automatic Temperature Control provides a wide range of temperature settings which allow you to slow cook, cook, roast, bake, steam – as well as sear and brown foods.

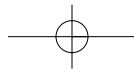

ROAST CHART

Preheat Roaster Oven to roasting temperature before adding meat. Minutes per pound are ONLY A GUIDE. Set meat on Rack in Preheated Cookwell.

	<u>Meat</u>	<u>Avg. Weight In Pounds</u>	<u>Temp. Setting Preheat/Roast</u>	<u>Approximate Minutes Per Pound</u>
BEEF	Corned Beef	3-1/2 to 4	350/300°F	15 to 20 medium-well
	Pot Roast, boneless	4 to 6	350/300°F	15 to 22 medium-well
	Sirloin Tip	3 to 5	350/350°F	20 to 25 rare-medium
	Standing Rump	4 to 6	350/325°F	20 to 25 rare-medium
	Tenderloin	3-1/2 to 4	450/450°F	8 to 12 rare-medium
LAMB	Leg, Sirloin	5 to 8	400/350°F	25 to 30 medium-well
	Shoulder, boneless	3 to 4	400/350°F	25 to 30 medium-well
PORK	Chops, center cut 1 inch	4 to 5	450/325°F	15 to 20 well
	Loin Roast, center	3 to 5	400/350°F	25 to 30 well
	Shoulder rolled	4 to 6	400/350°F	35 to 40 well
	Ribs, lean country	8 to 10	250/250°F	15 to 20 medium-well
	<i>Precook to tender; finish in 450°F. Roaster Oven or on outdoor grill.</i>			
SMOKED PORK	Ham, bone in, shankless	10 to 15	350/350°F	20 to 25 well
	Ham, boneless	8 to 12	350/325°F	15 to 20 well
	Ham, precooked	5 to 10	350/325°F	13 to 28 heated
VEAL	Loin	4 to 6	350/325°F	30 to 35 well
	Shoulder, bone	3 to 5	350/325°F	30 to 35 well
POULTRY	Chicken, pieces	6 to 8	400/375°F	8 to 10 well
	Chicken, whole	3-1/2 to 5	400/375°F	13 to 18 well
	Cornish Hens (4)	3-1/2 to 4-1/2	450/450°F	15 to 20 well
	Duck	4 to 5	450/425°F	20 to 25 well
	Turkey, prebasted	10 to 14	400/350/400°F	12 to 17 well
	Turkey, prebasted	14 to 20	400/350/400°F	13 to 18 well
	Turkey, whole fresh	10 to 14	400/350/400°F	15 to 20 well

*To obtain additional browning on poultry, mix 1/4 Cup melted margarine with 1 Tsp. browning sauce; brush evenly over skin before roasting.

*For crisper skin, baste, then remove liquid during roasting. *Roast turkeys at 400°F. for first and last hour; roast at 350°F. for remaining time.

NESCO® 18-Qt. Roaster Oven

5

BAKE CHART

Preheat 18-Qt. Roaster Oven for 20 minutes. Place bake pan on Rack; set Rack in preheated Cookwell.

Type of Food	Size of Bake Pan	Temperature Setting	Bake Time In Minutes
Baking Powder Biscuits	Bake Sheet	425°F	15 to 20
Refrigerated Quick Rolls	Bake Sheet	375°F	13 to 15
Muffins	12 Cup	425°F	25 to 35
Quick Bread	9x5-inch Loaf Pan	400°F	65 to 75
Yeast Bread	9x5-inch Loaf Pan	400°F	40 to 45
Yeast Rolls	Bake Sheet	400°F	25 to 30
Cookies	Bake Sheet	375°F	11 to 13
Cupcakes	12 Cup	375°F	20 to 25
Package Cake	9x13-inch	375°F	30 to 35
Scratch Cake	9x13-inch	350°F	40 to 45
Brownies	9x13-inch	350°F	25 to 30
Bar Cookies	9x13-inch	375°F	25 to 30
Pound Cake	9x5-inch	375°F	55 to 60
Cheesecake	9-inch	400°F	55 to 65
Fruit Pie	9-inch Pie Plate	425°F	60 to 65
Custard Pie	9-inch Pie Plate	400°F	55 to 65
Pastry Shell	9-inch	425°F	10 to 13
Pizza (9-inch)	On Rack	425°F	20 to 25
Baking Potatoes	On Rack	400°F	60 to 70
Sweet Potatoes	On Rack	400°F	55 to 65
Scalloped Potatoes	2 Qt. Casserole	350°F	75 to 90
Winter Squash (Butternut, Buttercup, Acorn)	On Rack	400°F	45 to 60
Baked Apples	Custard Cups	350°F	35 to 45

R O A S T

Roast Turkey

- 1 (15 to 18 Lb.) Whole fresh turkey**
- 1/4 Cup Margarine, melted**
- 2 Tsp. Browning sauce (Kitchen Bouquet)**
- 1 Tbsp. Chopped parsley**
- 2 Tsp. Poultry seasoning**
- 1 Tsp. Paprika**

Preheat Roaster Oven to 400°F.

Place turkey on Rack. Combine margarine and browning sauce; brush evenly over turkey.

Sprinkle on seasonings.

Set Rack in preheated Cookwell. Cover; roast turkey 13-18 minutes per pound at 350°F. (or until internal temperature reaches 180° on meat thermometer).

For additional browning, see Roasting Chart on Page 5.

For stuffed turkey, add 30 minutes to the roasting time.

Turkey may be held at 200°F until ready to serve.

Serves 12 to 14.

Wild Rice and Fruit Dressing

- 1/4 Cup Margarine**
- 2 Medium Onions, chopped**
- 2 Stalks Celery, thinly sliced**
- 3 Cups Dry bread cubes**
- 2 Cups Cooked wild rice**
- 1 Can (15-1/2 Oz.) Pineapple tidbits, undrained**
- 1 Can (11 Oz.) Mandarin orange segments, drained**
- 2 Large Baking apples, cored, seeded, coarsely chopped**
- 1 Cup Turkey drippings or chicken broth**
- 1 Tsp. Sage**
- 1 Tsp. Marjoram**
- 1/2 Tsp. Thyme**

Salt and ground black pepper, to taste

Preheat Roaster Oven to 350°F.

Melt margarine in large frying pan over medium heat. Add vegetables; cook until tender. Add bread cubes; rice; then remaining ingredients. Stir until well mixed. Spoon into 9x13-inch baking pan.

Place pan on Rack. Set Rack into preheated Cookwell. Cover; bake 50 to 60 minutes or until center is set.

Serves 12 to 14.

NESCO® 18-Qt. Roaster Oven

R O A S T

Roast Ham

- 1 (13 to 15 Lb.) Boneless ham**
 - 3 Cups White soda**
 - 3 Cups Orange juice**
 - 1 Tsp. Pumpkin pie spice**
- Raisin Sauce, to serve (See next recipe on this page)**

Preheat Roaster Oven to 300°F.

Place ham, fat side up, on Rack. Set Rack in preheated Cookwell. Add White soda, juice and spice. Cover; roast 2-1/2 to 3 hours, basting ham each half hour, or until internal temperature reaches 170°F. on meat thermometer.

Serve with Raisin Sauce.

To hold: Reduce temperature to 200°F and hold up to 1 hour.

Serves 25 to 30.

Raisin Sauce

- 1 Jar (10 Oz.) Apple jelly**
- 1 Can (8 Oz.) Crushed pineapple, undrained**
- 1/4 Cup Honey**
- 1 Cup Seedless raisins**

Combine ingredients in medium saucepan. Cook over medium heat until sauce comes to a boil, stirring constantly. Pour into 9x5-inch loaf pan. Place pan on end of Rack next to ham roast to keep sauce hot.

Makes approximately 1-1/2 Cups.

Country BBQ Ribs

- 20 to 22 Lb. Country-style lean ribs**
- 3 Large Onions, chopped**
- 4 Bay leaves**
- Hot water to cover ribs**
- 1 Quart Ketchup**
- 1/2 Cup Lemon juice**
- 1/2 Cup Brown sugar, firmly packed**
- 1-1/2 Tbsp. Celery seeds**
- 1 Tbsp. Italian herb seasoning**
- 1 to 2 Cloves Garlic, minced**

Preheat Roaster Oven at 400°F.

Set Rack in preheated Cookwell. Arrange meat on Rack. Add onion, bay leaves, and enough water to cover meat. Cover; roast for 2-1/4 to 2-1/2 hours or until meat is tender.

Meanwhile, combine sauce ingredients in large saucepan; stir to blend. Cover; simmer 45 to 60 minutes or until sauce thickens and flavors blend. Remove from heat; set aside.

Carefully lift Rack out onto large tray with sides. Remove Cookwell; slowly pour out and discard hot water. Clean Cookwell.

Set Cookwell into Heatwell. Cover; preheat to 400°F. Dip meat into BBQ sauce. Set on Rack in preheated Cookwell. Cover; roast 40 to 60 minutes or until sauce is set and edges begin to brown.

To hold: Reduce temperature to 250°F and hold up to 1 hour.

Serves 25.

R O A S T

Meatballs

- 5 Lb. Lean ground beef
- 2 Pkg. (1-1/4 Oz.) Dry onion soup mix
- 4 Large Eggs

Preheat Roaster Oven to 425°F.

Combine all ingredients; stir until well mixed. Form into 1-inch meatballs. Place meatballs into preheated Cookwell. Cover; bake 30 to 45 minutes. Stir occasionally to brown all sides of meatballs.

Makes approximately 200 meatballs.

Cocktail Meatballs

- 1/2 Recipe Meatballs, cooked (from above)
- 1 Jar (18 Oz.) Grape jelly
- 1 Jar (16 Oz.) Chili Sauce
- 1 Pkg. (1-1/4 Oz.) Brown gravy mix.

Preheat Roaster Oven to 325°F.

Place meatballs in Cookwell; add sauce ingredients. Stir. Cover; cook 45 to 60 minutes or until hot and bubbly.

To bold: Reduce temperature to 250°F. to bold for several hours and during serving.

Makes approximately 100 meatballs.

Roast Beef

- 2 (4-1/2 to 5 Lb. ea.) Beef Sirloin tip roasts
- 1/4 Cup Cider vinegar
- 1 Pkg. (1-1/4 Oz.) Dry onion soup mix
- 1 Tbsp. Italian herb seasoning
- 1/2 Tsp. Dry mustard
- 1/2 Tsp. Ground black pepper

Preheat Roaster Oven to 400°F.

Brush vinegar evenly over roasts. Combine soup and seasonings; rub over meat. Place meats on Rack. Set Rack in preheated Cookwell. Cover; roast 20 to 25 minutes per pound or until internal temperature reaches 150°F on meat thermometer. Skim fat from meat drippings; discard fat. Pour drippings over meat before serving.

Serves 25.

NESCO® 18-Qt. Roaster Oven

R O A S T

Swiss Steak

- 12 Lb. Thick round steak, cut into 50 pieces
- 4 Cups All purpose flour
- 1 Tbsp. Black pepper
- 1 Tbsp. Italian herb seasoning
- 2 Tsp. Grated lemon peel
- 1 Lb. Butter or margarine
- 2 Pkg. (1-1/4 Oz. ea.) Dry onion soup mix, divided
- 1 Quart Beef broth
- 2 Cans (29 Oz. ea.) Whole tomatoes, cut up
- 1/4 Cup Cornstarch, to thicken
- 1/2 Cup Cold water

Preheat Roaster Oven to 350°F.

Pound meat to tenderize. Combine flour, pepper, seasoning and lemon peel in flat bowl. Dredge meat. Brown meat in melted butter in large frying pans over medium-high heat. Place meat in layers in preheated Cookwell; divide soup mix and sprinkle over each layer of meat.

Cover; roast 1 hour. Reduce temperature to 250°F. Add broth and tomatoes; stir gently to cover meat. Cover; slow cook 4 to 5 hours or until tender. Thicken juice with mixture of cornstarch and 1/2 Cup cold water.

Serves 50.

NOTES

.....

.....

.....

.....

.....

.....

.....

.....

.....

.....

.....

.....

.....

.....

.....

.....

.....

.....

.....

.....

.....

.....

COOKING FOR A GROUP

Creamy Herb Pasta

- 3 Lb. Wide egg noodles, cooked, drained
- 2 Cups Half and Half
- 2 Cups Milk
- 4 Pkg. (8 Oz. ea.) Cream cheese, softened, cut into cubes
- 1 Cup Butter or margarine, room temperature
- 2 Tbsp. All purpose flour
- 1/2 Cup Chopped parsley
- 1/4 Cup Chopped chives
- 1 to 2 Tbsp. Italian herb seasoning
- Salt and pepper to taste

Preheat Roaster Oven to 350°F.

Combine all ingredients in Cookwell; stir gently until well mixed. Cover; bake 45 to 60 minutes or until set.

To hold: Reduce temperature to 250°F. add milk if pasta begins to dry.

Serves 25.

Spaghetti with Meatballs and Sauce

- 1 Recipe Meatballs, cooked (from page 9)
- 8 Lb. Spaghetti noodles
- 3 Tbsp. Salt
- 6 Tbsp. Vegetable oil
- 1/2 Cup Butter or margarine, melted
- Fresh grated Parmesan cheese

Sauce:

- 4 Cans (29 Oz. ea.) Stewed tomatoes
- 4 Cans (29 Oz. ea.) Tomato puree
- 4 Cans (12 Oz. ea.) Tomato paste
- 1 Large Onion, finely diced
- 1/2 Cup Granulated sugar
- 1/2 Cup Italian herb seasoning
- 1 Tbsp. Salt

Preheat Roaster Oven to 350°F.

Combine all sauce ingredients in Cookwell; stir until well mixed. Cover; cook 2-1/2 to 3 hours or until thick.

Add cooked meatballs; stir until covered with sauce. Reduce temperature to 300°F. Cover; cook 45 to 60 minutes or until meat is heated through.

Cook noodles in hot boiling water in three large pots. Add 1 Tbsp. salt and 2 Tbsp. oil to each pot. Stir noodles gently during cooking. Drain; toss with melted margarine. Serve immediately with hot sauce and meatballs; sprinkle on Parmesan cheese.

Serves 50.

NESCO® 18-Qt. Roaster Oven

COOKING FOR A GROUP

Baked Eggs Scrambled

54 Large Eggs

1 Pint Sour cream or plain low-fat yogurt

1 Cup All purpose flour

Salt and pepper, to taste

1 Can (10-3/4 Oz.) Cheddar soup

1/2 Cup Milk

1/4 Cup Chopped parsley

**Optional: Crumbled cooked bacon, sliced mushrooms, diced ham,
diced red and green peppers**

Remove Cookwell. Preheat covered Heatwell to 325°F.

Combine eggs, sour cream, flour, salt and pepper in Cookwell; whisk until blended.

Set Cookwell into preheated Heatwell. Cover; bake 25 minutes. Add optional ingredients.

Gently stir eggs once, stirring outside cooked portion into center. Combine soup and milk; stir until smooth. Spoon soup mixture over eggs; sprinkle on parsley. Cover; bake 30 to 45 minutes or until set.

To hold: Reduce temperature to 225°F to hold for 1 hour and during serving. To keep eggs moist after top half is served, an additional can of soup and milk may be mixed, warmed and spooned over remaining eggs.

Serves 50.

Irish Stew Casserole

1/4 Cup Butter or margarine

2 Cups All purpose flour

1 Tsp. Black pepper

7 Lb. Boneless lamb, cut into cubes

1 Small Cabbage, shredded

14 Large Red potatoes, peeled, cubed

14 Large Carrots, peeled, thickly sliced

8 Stalks Celery, thickly sliced

6 Medium Parsnips, peeled, thickly sliced

4 Large Onions, quartered

2 Cups Beef broth

2 Tbsp. Worcestershire sauce

1/4 Cup Cornstarch, to thicken

Preheat Roaster Oven to 450°F.

Place butter in preheated Cookwell. Cover; cook until butter melts. Combine flour and pepper; dredge meat. Place meat in Cookwell; stir. Cover; cook meat 15 to 20 minutes or until browned. Add vegetables. Cover; reduce temperature to 250°F. Slow cook 1-1/2 to 2 hours or until meat and vegetables are tender. Add half the broth and Worcestershire sauce. Combine remaining broth and cornstarch; whisk until smooth. Stir into stew. Cover; slow cook 30 minutes or until thickened, stirring once. Ladle into bowls to serve.

Serves 25.

COOKING FOR A GROUP

Shredded Potatoes

- 4 Lb. Frozen hash brown potatoes
- 2-1/2 Cups Milk
- 1 Pint Sour cream
- 2 Cups Grated Cheddar or Swiss cheese
- 2 Cans (10-3/4 Oz. ea.) Cream of Celery soup
- 4 Green onions, thinly sliced
- 1/4 Cup Chopped parsley
- 1 Tbsp. Italian herb seasoning
- Salt and pepper, to taste

Remove Cookwell. Preheat covered Heatwell to 350°F.

Combine all ingredients in Cookwell; stir until well mixed. Set Cookwell into preheated Heatwell. Cover; bake 1-1/2 hours or until center is set. Gently stir edge into center once halfway through baking time.

To hold: Reduce temperature to 200°F. Pour 1 cup milk over top if potatoes begin to dry.

Serves 25.

Parmesan Potatoes

- 12 Large Baking potatoes (approximately 6 Lb.)
- 1/2 Cup All purpose flour
- 1/2 Cup Grated Parmesan cheese
- 2 Tbsp. Chopped parsley
- Salt and ground black pepper, to taste
- 2/3 Cup Butter or margarine, melted

Preheat Roaster Oven to 375°F.

Peel potatoes; cut in half lengthwise. Combine flour, cheese, parsley, salt and pepper; stir until blended. Dip potatoes in melted butter, then in dry mixture to coat.

Arrange potatoes on Rack. Set Rack in preheated Cookwell. Cover; bake 1-1/2 to 2 hours or until done.

Serves 16-20.

NESCO® 18-Qt. Roaster Oven

Baked Beans

- 1 Lb. Dried Great Northern navy beans
- 1 Lb. Dried pinto or brown beans
- 1 Lb. Dried black-eyed peas
- 6 Cups Hot water
- 2 Cups Dark molasses
- 1 Cup Cider vinegar
- 1 Cup Brown sugar
- 1 Lb. Thick-sliced bacon, cut up
- 2 Large Onions, diced
- 2 Tbsp. Mustard
- 1 Cup Ketchup

Add beans to unheated Cookwell; cover with 4 quarts hot water. Let stand several hours or overnight; drain.

Preheat Roaster Oven to 300°F.

Add remaining ingredients, except ketchup, to beans. Stir in 6 Cups hot water. Cover; bake 2 hours or until beans are tender. Reduce temperature to 250°F. Stir; cover and bake 5 hours. Stir in ketchup; cover and bake 1 hour.

To hold: reduce temperature to 200°F. Add hot water or tomato juice if beans begin to dry.

Serves 25. Recipe may easily be doubled to serve 50.

B

COOKING FOR A GROUP

Hot Turkey and Cranberry Salad

- 12 Cups Cubed, cooked turkey
- 1 Bunch Celery ribs, thinly sliced
- 4 Green onions, thinly sliced
- 12 Oz. Cranberries, rinsed, coarsely chopped
- 8 Oz. Sliced almonds
- 2 Cans (10-3/4 Oz. ea.) Cream of Chicken soup
- 2 Cups Mayonnaise or salad dressing
- 1/4 Cup Chopped parsley
- 1 Tbsp. Poultry seasoning
- 1 Tbsp. Grated lemon peel
- 1 Lb. Grated Swiss cheese

Remove Cookwell. Preheat covered Heatwell to 325°F.

Combine all ingredients in Cookwell; stir until well mixed. Sprinkle cheese over top.

Set cookwell into preheated Heatwell. Cover; bake 60 to 75 minutes or until hot and bubbly and center is set.

To hold: Reduce temperature to 200°F. to hold for 1 hour and during serving.

Serves 25.

Chili

- 1/4 Cup Margarine
- 5 Lb. Ground beef
- 2 Large Onions, chopped
- 2 Cloves Garlic, minced
- 1 Can (29 Oz.) Stewed tomatoes
- 3 Cans (10-3/4 Oz. ea.) Tomato soup, undiluted
- 1 Can (8 Oz.) Tomato sauce
- 3 Cans (16 Oz. ea.) Red kidney beans, drained
- 1/4 Cup Chili powder
- 1 Tbsp. Italian herb seasoning
- 1 Tbsp. Brown sugar

Preheat Roaster Oven to 425°F.

Lightly spray Cookwell with spray cooking oil. Break apart meat; place in preheated Cookwell. Add onions and garlic. Cover; cook 15 to 20 minutes or until meat is browned, stirring once. Stir in remaining ingredients until well mixed. Reduce temperature to 350°F.; cover; cook 1 to 1-1/2 hours or until flavors blend.

Serves 25 to 30.

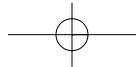

NOTES

A large rectangular area containing horizontal dotted lines for taking notes, divided into two columns by a vertical dotted line.

NESCO® 18-Qt. Roaster Oven

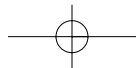

COOKING FOR A FAMILY

Macaroni and Cheese

- 1/4 Cup margarine
- 8 Cups Cooked elbow macaroni
- 1 Small Onion, chopped
- 2 Cans (10-3/4 Oz. ea.) Cream of Mushroom soup
- 1 to 1-1/4 Cups Milk
- 1 Cup (4 Oz.) Grated Cheddar cheese
- 1 Cup (4 Oz.) Grated Colby cheese

Preheat Roaster Oven to 350°F.

Lightly spray Cookwell with spray cooking oil. Add margarine to preheated Cookwell. Cover; cook until melted. Add remaining ingredients; stir until well mixed.

Cover; cook 45 to 55 minutes or until set. Stir once halfway through cooking time.

Serves 12 to 15.

Chicken and Vegetable Soup

- 2 Quarts Chicken broth
- 2 Medium Onions, chopped
- 4 Stalks Celery, thinly sliced
- 6 Carrots, thinly sliced
- 2 Cans (15 Oz. ea.) Stewed tomatoes
- 1 Pkg. (20 Oz.) Frozen mixed vegetables
- 2 Cans (10 Oz. ea.) Whole kernel corn
- 2 Bay leaves
- 1 Tsp. Salt (or to taste)
- 2 to 3 Tsp. Italian herb seasoning
- 1 Tsp. Celery seed
- 1/2 to 1 Tsp. Ground black pepper
- 2 Lb. Cooked chicken, skinned, boned, and cut up.

Preheat Roaster Oven to 400°F.

Lightly spray Cookwell with spray cooking oil. Add half the chicken broth and fresh vegetables. Cover; cook 15 to 20 minutes or until broth is hot and vegetables soften. Add remaining ingredients. Stir to mix. Reduce temperature to 325°F. Cover; cook 45 to 60 minutes or until vegetables are tender and soup is hot.

Serves 10 to 12.

COOKING FOR A FAMILY

Creamy Cheesecake

For Crust:

- 40 Vanilla wafers, crushed
- 1/4 Cup Finely chopped pecans
- 1/4 Cup Margarine, melted
- 2 Tbsp. Granulated sugar

For Filling:

- 2 Pkg. (8 Oz. ea.) Cream cheese, softened
- 1/2 Cup Granulated sugar
- 1 Tsp. Vanilla extract
- 3 Large Eggs

Preheat Roaster Oven to 400°F.

Combine crust ingredients; stir until well mixed. Pour into 9-inch springform pan; pat down with back of fork; set aside.

Place cream cheese, sugar and vanilla extract in large mixing bowl; beat until smooth. Add eggs one at a time, beating well after each addition. Beat for 2 minutes on medium speed. Pour over crust.

Place springform pan on Rack. Set Rack in preheated oven. Cover; bake 55 to 65 minutes or until set and evenly browned. Let cake cool on cooling rack, away from drafts.

Cover; refrigerate until serving time. Serve with fresh seasonal fruit, if desired.

Makes 8 to 12 pieces.

Baked Turkey Melts

- 4 Cups Ground turkey
- 1/2 Cup Minced sweet pickles
- 2 Green onions, chopped
- 1 Small Red pepper, seeded, chopped
- 1 Cup Mayonnaise or salad dressing
- 1 Tbsp. Lemon juice
- 16 Whole wheat buns
- 3 large Tomatoes, sliced
- 16 Slices (1 Oz. ea.) Swiss cheese
- Aluminum foil, to wrap

Preheat Roaster Oven to 350°F.

Combine first 6 ingredients; stir until well mixed. Spread evenly on half the buns; top with tomato and cheese slices. Top with remaining buns. Wrap each bun in a piece of aluminum foil.

Place buns on Rack. Set Rack in preheated Cookwell. Cover; bake 30 to 40 minutes or until buns are heated through.

Reduce temperature to 200°F to keep buns warm. Serve as needed.

Makes 16 sandwiches.

NESCO® 18-Qt. Roaster Oven

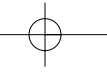

NOTES

A large rectangular area containing horizontal dotted lines for writing notes, divided into two columns by a vertical dotted line.

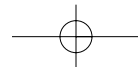

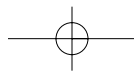

ONE YEAR LIMITED WARRANTY

This appliance is warranted for one year from date of original purchase against defects in material and workmanship. This warranty does not cover transportation damage, misuse, accident or similar incident. This warranty gives you special legal rights and you may have other rights which vary from state to state.

Defective products may be returned, postage prepaid, with a description of the defect to: The Metal Ware Corporation, 1700 Monroe St., Two Rivers, Wisconsin 54241, for no-charge repair or replacement at our option.

SERVICE. Service and genuine NESCO® replacement parts may be obtained from NESCO® FACTORY SERVICE DEPARTMENT.

For service in warranty, follow instructions set forth in warranty. When ordering new parts, make sure that you always mention the model number of the product, which is found on the bottom of the Roaster Oven.

n. strom
1-800-288-4545

NESCO®

© 2000, The Metal Ware Corporation

Printed in U.S.A. Made in U.S.A.
#63492

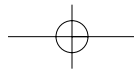

Free Manuals Download Website

<http://myh66.com>

<http://usermanuals.us>

<http://www.somanuals.com>

<http://www.4manuals.cc>

<http://www.manual-lib.com>

<http://www.404manual.com>

<http://www.luxmanual.com>

<http://aubethermostatmanual.com>

Golf course search by state

<http://golfingnear.com>

Email search by domain

<http://emailbydomain.com>

Auto manuals search

<http://auto.somanuals.com>

TV manuals search

<http://tv.somanuals.com>