

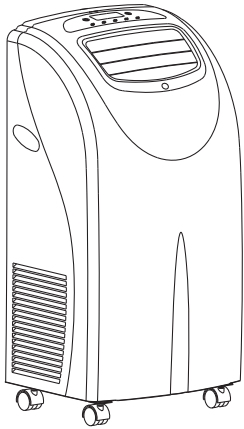

ACP-1300E Portable Air Conditioner
Owner's Manual



Please read all instructions carefully before operating

Contents

1. Safety Instructions	
(1) Warning.....	2
(2) Precautions.....	3
(3) Maintenance.....	4
2. Parts List	
(1) ACP-1300E Unit and Accessories.....	5
(2) Control Panel	6
(3) Remote Control.....	7
3. Operating Instructions	
(1) Operating the ACP-1300E for the First Time; Operating Modes; and Thermostat.....	8
(2) Setting the Timer.....	9
(3) Adjusting the Airflow.....	9
(4) Installing the Battery for the Remote Control.....	10
(5) Emptying the Auxiliary Water Tank.....	11-12
(6) Setting up the Exhaust Hose.....	13-14
4. Troubleshooting Tips.....	15
5. Electrical Diagram	16
6. Electrical Specifications	17

1. Safety Instructions

Warning

- Connect the ACP-1300E's plug into an appropriate power outlet.
- Do not turn off the power supply by pulling the power cord; use the On/Off power button.

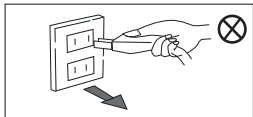
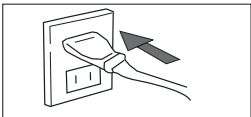

- Be careful not to damage the power cord, and do not operate the ACP-1300E if the cord appears to be damaged.
- Do not use a power strip or an extension cord.

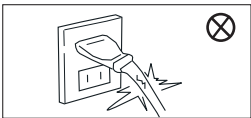

- Before operating the ACP-1300E, make sure your hands are clean and dry.
- To avoid injury, keep fingers and foreign objects out of the unit.

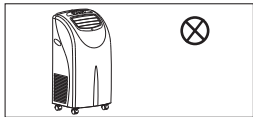

- Make sure the air conditioner's ground wire is connected.
- If you notice smoke or an odd odor coming from the ACP-1300E, turn the unit off and disconnect the power plug.

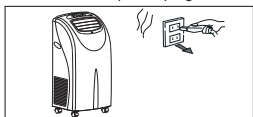
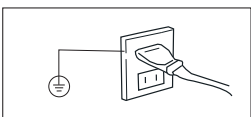

If problems persist or if the unit malfunctions, please contact your NewAir dealer or a professional repair center.

1. Safety Instructions

Precautions

- Leave the ACP-1300E in an upright position for at least two hours before operating.
- The unit must be installed in accordance with national and local wiring regulations.
- The ACP-1300E's supply cord requires a Y-type attachment. If the supply cord is damaged, it must be replaced by the manufacturer, an authorized service agent, or a qualified repair professional in order to avoid further damage, to prevent voiding the warranty, and to avoid bodily injury.
- Never operate the ACP-1300E in an area where flammable gasses or chemicals are present.
- To prevent electromagnetic interference, place the unit at least three feet away from radios or televisions.
- When connecting or disconnecting the power cord, hold the plug itself - never pull the power cord.
- When not using the unit for an extended period of time, disconnect the power cord and drain any water from the auxiliary water tank.
- When cleaning the ACP-1300E, do not spray liquid directly onto the unit. Moreover, do not use harsh chemicals or cleansers to clean the unit. Instead, apply water or a mild cleanser to a soft cloth and wipe the ACP-1300E clean.
- The ACP-1300E is not intended to support heavy objects, be used as a step-stool, or be shaken or bumped into. Keep this in mind when deciding where to place the unit.
- If you choose to use the continuous drain function on the ACP-1300E, make sure the condensate can drain off into an appropriate receptacle.
- To ensure adequate air circulation, place the air conditioner at least four inches away from walls and furnishings. Be aware of draperies or other items which may interfere with the intake vents and cause restricted airflow.
- Place the ACP-1300E on a level, flat surface. Do not operate the unit on an angle of more than 4 inches.

1. Safety Instructions

Maintenance

- To avoid electrical shock, be sure to disconnect the power cord before cleaning the unit.
- Avoid using chemicals such as benzene, alcohol, gas, or turpentine when cleaning the unit.
- It is recommended that the air filter be replaced every two months (more frequently if the filter is visibly soiled). Built-up dust and debris on the filter will decrease airflow and impact the air conditioner's cooling efficiency.
- When removing the filter from the ACP-1300E, following these steps:
 1. Gently lift up the air filter cover.
 2. Grasp the air filter and separate it from the cover.

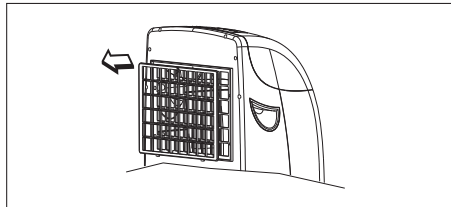

Please Note:

When cleaning the air filter, use only warm water or a mild detergent. Once the filter has been cleaned, allow it to completely dry in a cool place. Also remember that the external case should only be cleaned with a soft, moist cloth.

4

2. Parts List

Parts and Accessories

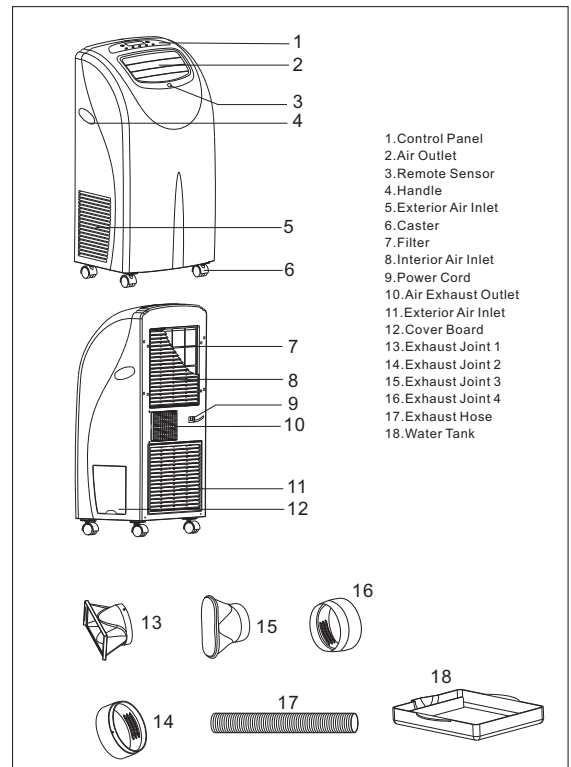

1. Control Panel
2. Air Outlet
3. Remote Sensor
4. Handle
5. Exterior Air Inlet
6. Caster
7. Filter
8. Interior Air Inlet
9. Power Cord
10. Air Exhaust Outlet
11. Exterior Air Inlet
12. Cover Board
13. Exhaust Joint 1
14. Exhaust Joint 2
15. Exhaust Joint 3
16. Exhaust Joint 4
17. Exhaust Hose
18. Water Tank

5

2. Parts List

Display Panel

Display Panel Icons

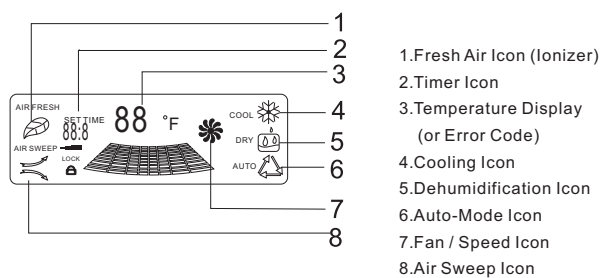

1. Fresh Air Icon (Ionizer)
2. Timer Icon
3. Temperature Display (or Error Code)
4. Cooling Icon
5. Dehumidification Icon
6. Auto-Mode Icon
7. Fan / Speed Icon
8. Air Sweep Icon

Control Panel Buttons

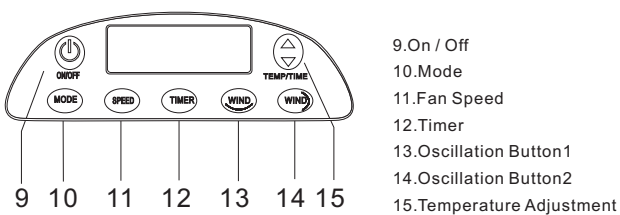

9. On / Off
10. Mode
11. Fan Speed
12. Timer
13. Oscillation Button 1
14. Oscillation Button 2
15. Temperature Adjustment

Please Note: Not all controls will require adjustment, as some controls may be designed for other NewAir models.

6

2. Parts List

Remote Control

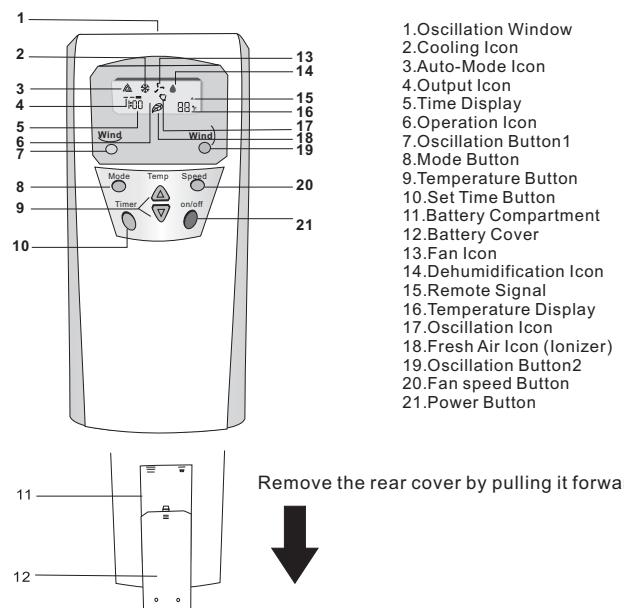

1. Oscillation Window
2. Cooling Icon
3. Auto-Mode Icon
4. Output Icon
5. Time Display
6. Operation Icon
7. Oscillation Button 1
8. Mode Button
9. Temperature Button
10. Set Time Button
11. Battery Compartment
12. Battery Cover
13. Fan Icon
14. Dehumidification Icon
15. Remote Signal
16. Temperature Display
17. Oscillation Icon
18. Fresh Air Icon (Ionizer)
19. Oscillation Button 2
20. Fan speed Button
21. Power Button

Remove the rear cover by pulling it forward.



Please Note: Not all controls will require adjustment, as some controls may be designed for other NewAir models.

7

3. Operating Instructions

1. When first plugging in the ACP-1300E, a tone indicating that the power is connected will sound. After pressing the "On" button, the unit will start in Auto Mode and display the current room temperature.

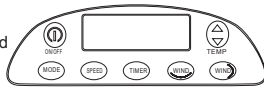

2. To select the mode, press the "Mode" button. This will then cycle the ACP-1300E through the "Auto," "Fan," "Cooling," and "Dehumidify" options.



3. When adjusting the temperature, keep in mind that the ACP-1300E is adjustable between 60° and 88° F. To set the temperature, press the "Temperature" button until the desired temperature is displayed. The air conditioner will now cool the room to that temperature. After five seconds of setting your desired temperature, the display will then revert back to displaying the current room temperature.

4. To adjust the fan speed, press the "Speed button." This will allow the ACP-1300E to cycle through the "High," "Medium," and "Low" speed options.

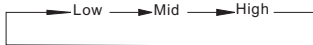

5. To turn off the unit, press the "Off" button. The air conditioner will cease operation and a tone will sound.

6.1. For fresh air, press the "Fresh Air" button while the unit is running. This will then engage the built-in ion generator.

Please Note:

While in dehumidification mode, the unit will automatically set the fan speed to "Low". The ACP-1300E will not allow fan speed adjustments, nor will adjusting the temperature affect the unit's operation.

In addition, while in fan mode, adjusting the temperature will not affect the unit's operation. If the ACP-1300E is in standby mode, the remote control's memory function will turn on. Your settings will be stored in the unit's memory, and when used next, it will operate according to the last saved settings only the timer function will need to be reset (if you are using this function).

3. Operating Instructions

Setting the Timer Function:

- To set the timer function, press the "Timer" button and enter the time that you would like the unit to shut down. You will then have the option of setting the time for the unit to resume function (ranging from half an hour to 12 hours, in half hour increments). You can also exit the timer function at that time.
- While the unit is in standby mode, you can also set the operation times by pressing the "Timer" button. Enter the time in which you would like the air conditioner to begin operating, and you will then be able to program the time at which you want the unit to go back into standby mode (ranging from half an hour to 12 hours, in half hour increments). You can also exit the timer function at that time (Note: While in the set time frame, the air conditioner will display a countdown of the remaining time until the next mode is initiated).
- To adjust the airflow, if you would like to have the airflow oscillated from the ceiling to the floor, press the "Oscillation" button on the remote control. Right to left airflow can then be set by manually adjusting the louvers.

Please Note:

When turning off the unit, VFD indicators will appear "Off" until the sweep shuts down.

3. Operating Instructions

Battery Installation:

1. Open the battery compartment by sliding down the battery cover panel.
2. Remove and discard old batteries replace with new batteries
3. Replace the battery panel back onto the remote.

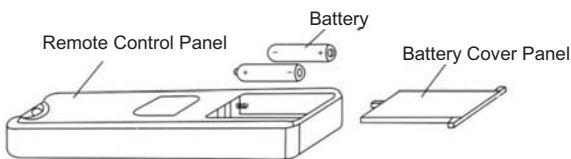

Please Note:

1. The polarity of the batteries must match the indicator in the remote control.
2. Do not mix old and new batteries in the remote control.
3. To prevent corrosion, remove the batteries if the remote control will not be used for an extended period of time.

3. Operating Instructions

Drainage

When the ACP-1300E is in operation, the condensed water will be drained into the water tank. If the water tank is full, a buzzer will sound 20 times, and the VFD indicator will display an "E2" error warning. At that time, the unit will cease operation, and if you wish to restart the unit, the water tank must be emptied by taking the following steps:

1. Turn off the unit.
2. Remove the rubber plug. The condensed water will then flow out.
3. After the water is emptied, replace the rubber plug.
4. Restart the unit.

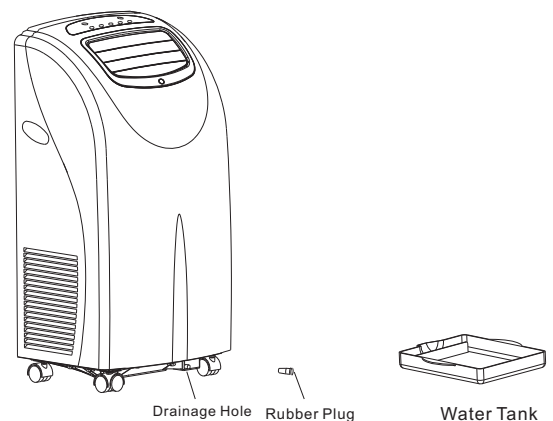

3. Operating Instructions

Air Exhaust Hose

The hot air exhaust conducts the hot, moist air produced by the unit away from the space you are cooling. The window kit and exhaust hose can also be moved from room to room with the unit. You can exhaust the ACP-1300E by following one of the following two methods:

1. Exhaust the hot air through a window or sliding glass door (a window kit extension may be necessary). Open the window or sliding glass door, install the window kit, and connect the exhaust hose.

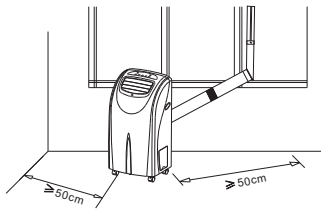

2. If an existing window or sliding glass door cannot be used, a custom opening through a wall or ceiling can be cut out in order to facilitate the exhaust hose.

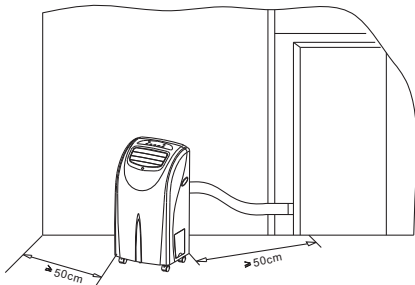

Please Note:

The hot air must be exhausted in order for the unit to produce a cooling effect. When the ACP-1300E is not in use, safely store away the exhaust hose in a clean, dry place.

12

3. Operating Instructions

Exhaust Hose

1. The exhaust hose can extend from 1.8 feet to 6.5 feet. The shorter the hose, the better the cooling effect.

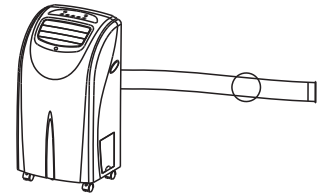

2. The hose should be as straight as possible, as sharp or unnecessary bends in the hose will prevent effective airflow. This will subsequently result in overheating and possible shut-down of the unit.

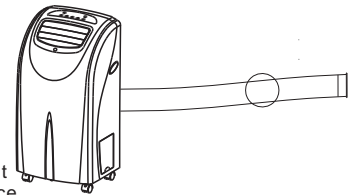

3. The length of the exhaust hose should not be extended past 6.5 feet. Replacement hoses are available for purchase through your NewAir vendor. We also recommend that you use only certified NewAir replacement parts.

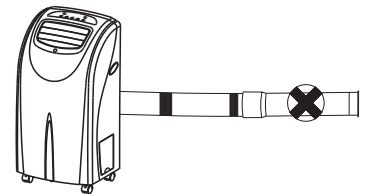
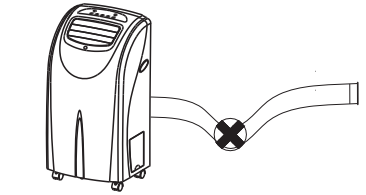

13

4. Troubleshooting

Troubleshooting Your ACP-1300E Portable Air Conditioner

Before investing in repairs, check to see if any of the following apply to you:

Problems	Possible Causes	Suggested Solutions
The unit doesn't work.	There could be power trouble. 1. The power cord is not plugged in. 2. The circuit breaker has been tripped. 3. There is a problem with the socket or outlet. 4. Either the power cord is damaged, or the fuse needs to be replaced.	1. Connect the power cord correctly. 2. Reset the circuit at the breaker box. 3. Change the socket or outlet. 4. Take the unit to a qualified technician and have the fuse replaced (fuse specification: 3A/250V).
The unit stops working on its own.	Either the timer has been activated or the temperature in the room is lower than the set temperature.	Either turn the timer off or wait for the room temperature to rise.
There is no cool air coming out of the unit when it is in cooling mode.	1. The room temperature is lower than the set temperature. 2. The evaporator is frosted over.	1. Wait for the room temperature to rise to resume normal operation. 2. Allow the evaporator to defrost and normal operation will resume.
There is no cool air coming out of the unit when it is in dehumidifying mode.	1. The evaporator is frosted over. 2. The unit is eliminating frost.	Allow the evaporator to defrost and normal operation will resume.
Error code E2 is displayed on the control panel.	The water tank is full.	Empty the water tank and restart the unit.
Error code E4 is displayed on the control panel.	The coil pipe is damaged.	Replace the coil pipe.
Error code E1 is displayed on the control panel.	1. The voltage is too high or too low. 2. The unit is damaged.	1. Restart the unit when the voltage is normal. 2. Have the unit repaired by your NewAir dealer or at a professional repair center.

Please Note:

Never service your ACP-1300E portable air conditioner by yourself. If your unit needs to be repaired, please contact your NewAir dealer or a professional repair center for assistance.

14

5. Electric Diagram

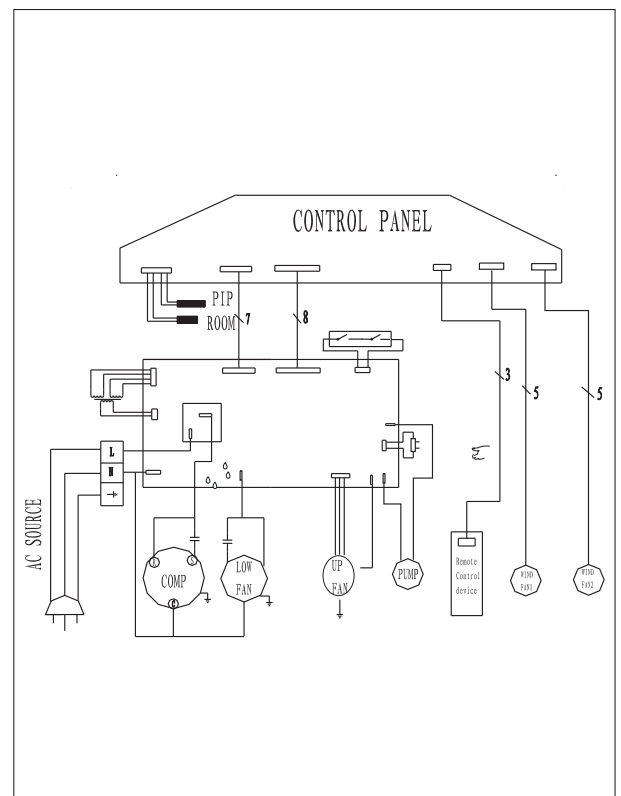

15

6. Technical Specifications

Model Number		ACP-1300E
Cooling Capacity (Btu/h)		13000(MAX)
Dehumidifying(Pints/day)		120(MAX)
Power Supply		120V/60Hz
Power Consumption	Cooling	1250W/10.8 A
	Dehumidifying	950W/ 8.2A
Water Tank Capacity (Liters)		2L
Temperature Set Range		61°F-88°F
Noise Level(dB)		≤52
Unit Weight (Lb)		88
Unit Dimensions (inches)		13.8X17.4X34.2
Refrigerant		R22(21.2oz)

Please Note:

The cooling capacity of the unit may be affected by several factors such as the height of the ceiling, the quality of insulation, number of windows, etc.

Free Manuals Download Website

<http://myh66.com>

<http://usermanuals.us>

<http://www.somanuals.com>

<http://www.4manuals.cc>

<http://www.manual-lib.com>

<http://www.404manual.com>

<http://www.luxmanual.com>

<http://aubethermostatmanual.com>

Golf course search by state

<http://golfingnear.com>

Email search by domain

<http://emailbydomain.com>

Auto manuals search

<http://auto.somanuals.com>

TV manuals search

<http://tv.somanuals.com>