

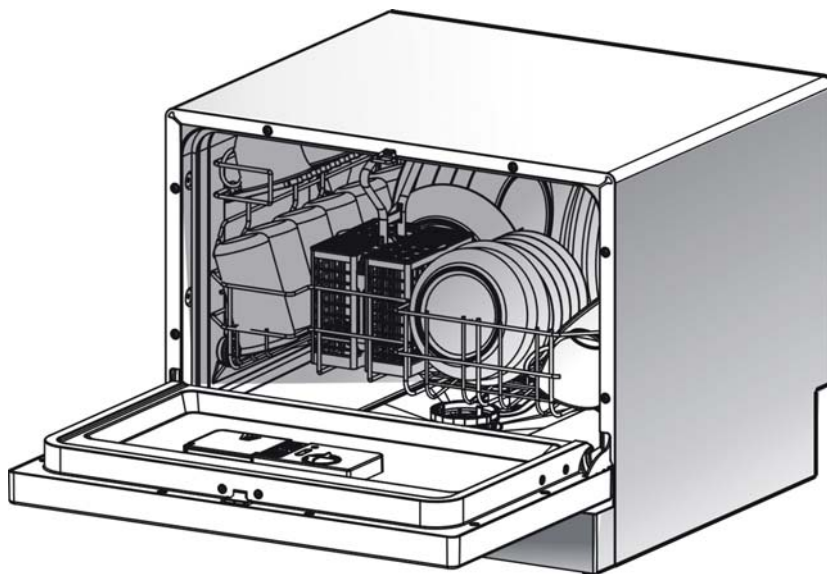

Please read and save these instructions.

NewAir ADW-2600W Portable Dishwasher

Instruction Manual



Read This Manual



Dear Customer,

This instruction manual will provide you with valuable information necessary for the proper care and maintenance of your new appliance. Please take a few moments to carefully read this manual, as it contains safety, operating and installation instructions, as well as troubleshooting tips. We also recommend retaining it for future reference and giving it to any subsequent owners of this appliance.

Before Calling for Service



Occasionally a minor problem may arise and a service call may not be necessary. Please refer to our troubleshooting tips located in the back of the manual for a possible solution. If the problem persists, please contact an authorized service department or customer service.

Note:



Due to a policy of constant product development and updates, the manufacturer may make modifications without giving prior notice.

Table of Contents

1) Safety Information	1
2) Operating Instructions	2
Control Panel	2
Dishwasher Features	2
3) Before Using for the First Time	3
A. Filling the Rinse Aid Dispenser	3
B. Using Detergent	4
C. Loading the Dishwasher Basket	6
Loading the Basket	7
The Cutlery Basket	8
4) Starting a Wash Cycle	9
Wash Cycle Table	9
Turning on the Appliance	9
Changing Wash Cycles	10
At the End of the Wash Cycle	10
5) Maintenance and Cleaning	11
Filtering System	11
Maintaining Your Dishwasher	12
6) Installation Instructions	13
Positioning the Appliance	14
Power Connection	14
Water Connection	15
Starting the Dishwasher	16
7) Troubleshooting Tips	17
Before Calling for Service	17
Error Codes	19
Technical Information	20
Detailed Parts Diagram	21
Electrical Diagram	22

1. IMPORTANT SAFETY INFORMATION: READ ALL INSTRUCTIONS BEFORE USING THIS APPLIANCE

WARNING! Follow the precautions below when using your dishwasher.

GROUNDING INSTRUCTIONS

- This appliance must be grounded. In the event of a malfunction or breakdown, grounding will reduce the risk of electric shock by providing a path of least resistance to the electric current. This appliance is also equipped with a power cord with an equipment grounding conductor and a grounding plug.
- The plug must be plugged into an appropriate outlet that is in accordance with all local codes and ordinances.
- **WARNING!** Improper use of the grounded plug can result in electric shock.
- Check with a qualified electrician or service representative if you have any questions about the electrical connection. Do not modify the plug provided with the appliance. If it does not fit with your existing outlet, have one properly installed by a qualified electrician.

SAFETY PRECAUTIONS

- Do not sit or stand on the door or dish rack.
- Do not touch the heating element during or immediately after use (only applicable with a visible heating element).
- Do not operate your dishwasher unless all enclosure panels are properly in place. Open the door carefully if the dishwasher is in operation, as water may leak out.
- Do not place heavy objects on the door when it is open. Doing so can cause the appliance to tip forward.
- When loading items into the dishwasher:
 1. Be aware of sharp items and make sure they cannot damage the door seal.
 2. Warning! All knives and utensils with sharp points must be loaded into the basket with the points facing down. They can also be placed horizontally in the dishwasher.
- When using your dishwasher, prevent plastic items from coming into contact with the heating element (only applicable with a visible heating element).
- Make sure the detergent receptacle is empty after a wash cycle is completed.
- Do not wash plastic items in the dishwasher unless they are marked dishwasher safe. For plastic items that are not marked as such, check with the manufacturer.
- Only use detergent and rinse additives that are designed for automatic dishwashers.
- Never use soap, laundry detergent or regular dishwashing detergent in the dishwasher. Also keep these products out of reach of children.
- Keep children away from detergent and rinse aids. Also keep children away from the dishwasher if the door is open, as there could still be some detergent left inside.
- This appliance is not intended for use by persons (including children) with reduced physical, sensory or mental capabilities, unless they have been given supervision or instruction concerning its use by a person responsible for their safety.
- Supervise children and make sure they do not play with the appliance.
- Dishwashing detergents are strongly alkaline and can be extremely dangerous if swallowed. Avoid contact with skin and eyes, and keep children away from the dishwasher if the door is left open.
- Do not leave the door in the open position for extended periods of time, as this can present a tripping hazard.
- If the power cord is damaged, it must be replaced by the manufacturer, a service agent or a similarly qualified person in order to avoid a hazard.
- Remove the dishwasher door when discarding the unit.
- Please dispose of packing materials properly.
- Use the dishwasher only for its intended function.
- During installation, the power supply must not be excessively bent or flattened.
- The appliance must be connected to the water line using new hose sets. Do not reuse old hose sets.
- The maximum number of place settings to be washed is 6.
- The maximum permissible inlet water pressure is 1 Mpa.
- The minimum permissible inlet water pressure is 0.04 Mpa.

SAVE THESE INSTRUCTIONS

2. OPERATING INSTRUCTIONS

IMPORTANT: To ensure optimal performance, please read all operating instructions carefully before using this appliance for the first time.

Control Panel

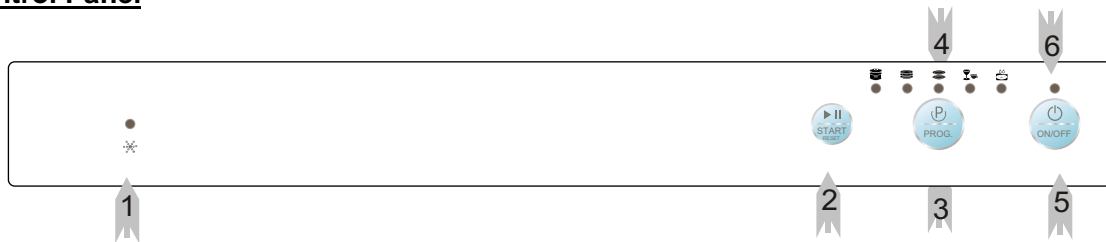

1. **Rinse Aid Warning Indicator Light:** Turns on when the rinse aid dispenser needs to be refilled.
2. **Start/Reset Button:** Press this button to start or pause the dishwasher. The corresponding indicator light will blink when the unit is starting.
3. **Wash Cycle Button:** Press this button to select a wash cycle.
4. **Wash Cycle Indicator Light**
5. **ON/OFF Button:** Turns the power supply on or off.
6. **Power Indicator Light:** Turns on when the ON/OFF button is pressed.

Interior

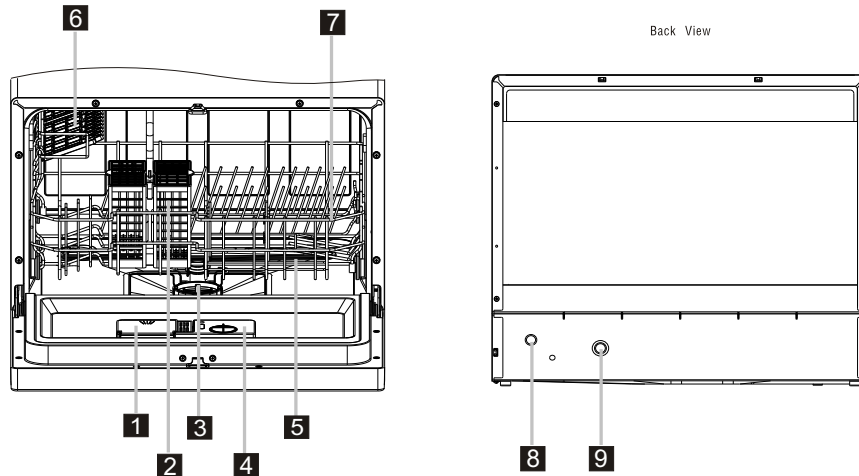

1. **Detergent Dispenser**
2. **Cutlery Basket**
3. **Filter Assembly**
4. **Rinse Aid Dispenser**
5. **Spray Arms**
6. **Cup Shelf**
7. **Basket**
8. **Drain Pipe Connector**
9. **Inlet Pipe Connector**

3. BEFORE USING FOR THE FIRST TIME

A. Filling the Rinse Aid Dispenser

Rinse Aid Dispenser

Rinse aid is released during the final rinse to prevent water from forming droplets on your dishes, which can leave spots and streaks. Using rinse aid also improves drying by allowing water to sheet off dishes. Your dishwasher is designed to use liquid rinse aids. The rinse aid dispenser is located inside the door next to the detergent dispenser. To fill the rinse aid dispenser, open the cap and pour rinse aid into the dispenser until the level indicator turns dark. The volume of the rinse aid container is approximately 110 ml.

Rinse Aid Function

The rinse aid is automatically added during the last rinse to ensure thorough rinsing and spot/streak-free drying.

Attention!

Only use rinse aid designed for dishwashers. Do not fill the rinse aid dispenser with any other substances such as dishwashing liquid or detergent. Doing so can damage the dishwasher.

Refilling the Rinse Aid Dispenser

If the rinse aid warning indicator light is not on, you can see how much rinse aid is left by looking at the color of the rinse aid level indicator "C" located next to the cap. When the rinse aid container is full, the indicator will be dark. As rinse aid level decreases, the size of the dot will decrease. Do not let the rinse aid get below 1/4 full.

As the rinse aid level decreases, the size of the black dot on the rinse aid level indicator will change as illustrated below:

- Full
- 3/4 Full
- 1/2 Full
- 1/4 Full
- Empty

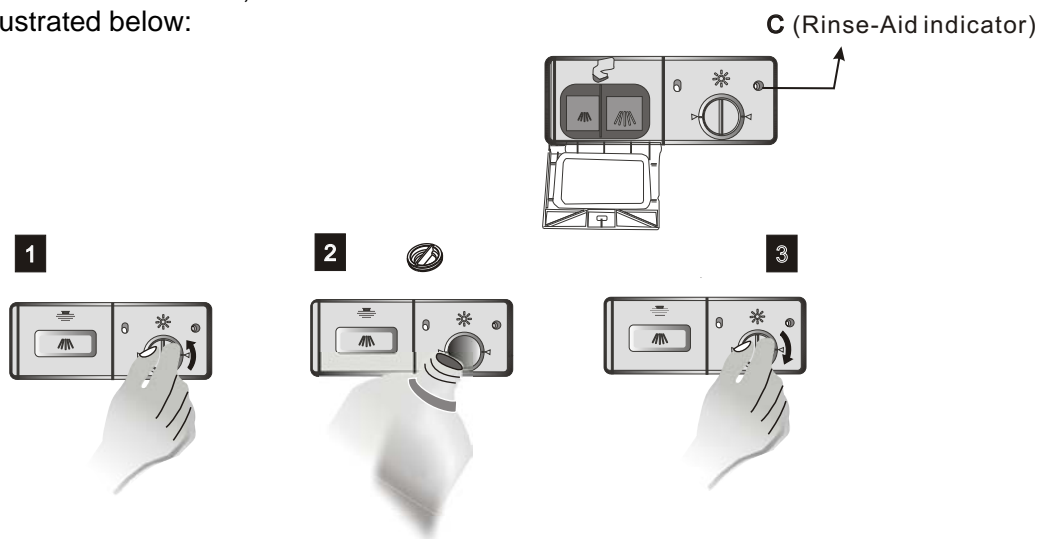

1. To open the rinse aid dispenser, turn the cap to the left arrow and lift it out.
2. Pour the rinse aid into the dispenser and be careful not to overfill.
3. Replace the cap and turn the cap to the right arrow to close the dispenser.

NOTE: Clean up any rinse aid that has spilled with an absorbent cloth to avoid excessive foaming during the next wash. Always replace the rinse aid cap before closing the dishwasher door.

Adjusting the Rinse Aid Dispenser

The rinse aid dispenser has 4 settings. The recommended setting is “3”. If dishes are still not drying properly or are spotted, adjust the dial to the next higher number, “4”.

NOTE: Increase the amount of rinse aid if there are still water droplets on your dishes. Reduce the amount of rinse aid if there are white stains on your dishes or if there is a bluish film on glassware or cutlery.

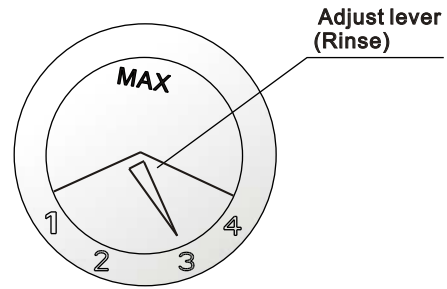

B. Using Detergent

Proper Use of Detergent

Detergents remove debris from your dishes and then help remove them from your dishwasher. Only use detergent specifically designed for dishwashers. Keep detergent fresh and dry, and do not put powdered detergent into the dispenser until you are ready to wash dishes.

Types of Detergent

There are 3 types of detergent:

- Phosphate and chlorine
- Phosphate without chlorine
- Without phosphate or chlorine

Most pulverized detergents will be phosphate-free. Since phosphate is a natural water softening agent, if you are using a phosphate-free detergent, we recommend putting salt in the container even when the water hardness is only 6°dH. If phosphate-free detergents are used in hard water, white spots will often appear on dishes and glassware. If this is the case, add more detergent to achieve better cleaning results. Detergent without chlorine may not be able to remove large/heavy stains. In this case, please choose a wash cycle with a higher temperature.

Concentrated Detergent

Based on their chemical composition, dishwashing detergents can be split into 2 basic types:

- Conventional, alkaline detergents with caustic components
- Low alkaline detergents with natural enzymes

The use of “normal” washing programs in conjunction with concentrated detergents reduces pollution and is good for your dishes. These wash programs are specifically designed to be used with concentrated detergent. For this reason, “normal” wash programs with concentrated detergent can achieve the same results that can otherwise only be achieved using “intensive” programs.

Detergent Tablets

Depending on the brand, detergent tablets can dissolve at different speeds. For this reason, some detergent tablets cannot dissolve and develop their full cleaning power during short programs. Please use a longer wash program/cycle when using detergent tablets to ensure complete removal of residual detergent.

Note: Detergent tablets can only be used in dishwashers with 3-in-1 functionality or 3-in-1 programs.

Detergent Dispenser

The detergent dispenser must be refilled prior to the start of each wash cycle. This dishwasher uses less detergent and rinse aid than a conventional dishwasher. Generally, only one tablespoon of detergent will be required for a normal wash load. For more heavily soiled dishes, use more detergent. Always add the detergent just before starting the dishwasher, otherwise it will not dissolve properly.

Proper Amount of Detergent

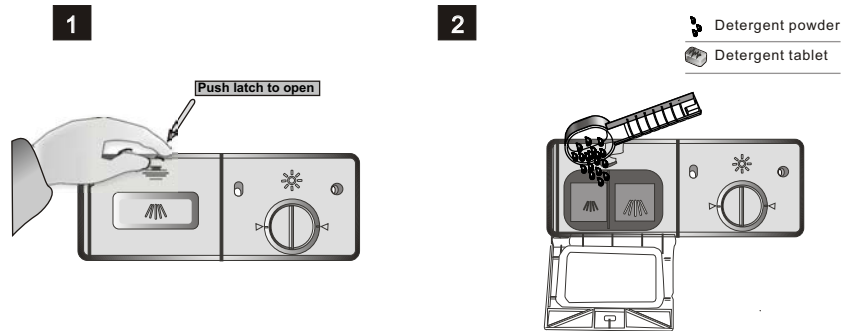

Note:

- If the detergent dispenser lid is closed, press the latch to open it.
- Always add detergent just before starting a wash cycle.
- Only use branded detergent for your dishwasher.

WARNING: Dishwashing detergent is corrosive. Keep it out of reach of children.

Filling the Detergent Dispenser

Fill the detergent dispenser with detergent according to the dosage levels as illustrated on the right:

- A. Accommodates 15g of detergent
- B. Accommodates 25g of detergent

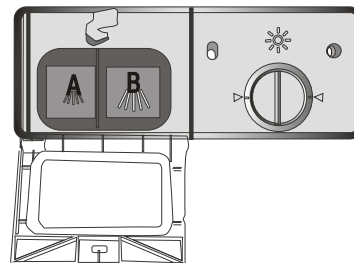

Please observe the manufacturer's dosing and storage recommendations as stated on the detergent packaging.

After filling the detergent dispenser, close the lid and make sure it locks into place.

If dishes are heavily soiled, put more detergent into the pre-wash detergent chamber. This detergent will be used during the pre-wash phase.

Note:

- Information on the amount of detergent for a single program is listed on the last page.
- Please be aware that the amount of detergent you should use will vary depending on the soilage level and hardness level of your water.
- Please observe manufacturer's recommendations on the detergent packaging.

4. LOADING THE DISHWASHER BASKET

Recommendations

- Use utensils that are dishwasher safe.
- Use a mild detergent that is “kind to dishes.” Seek further information from the detergent manufacturer if necessary.
- For delicate items, use a washing program with a low temperature.
- To prevent damage, do not remove glass or cutlery from the dishwasher immediately after the wash cycle has ended.

Washing Guidelines

The following is a list of items that are not suitable and somewhat suitable for use in the dishwasher:

Not Suitable:

- Cutlery with wood, horn china or mother of pearl handles
- Plastic items that are not heat resistant
- Older cutlery with glued parts that are not temperature resistant
- Bonded cutlery or dishes
- Pewter or copper items
- Crystal or glass items
- Steel items that may be subject to rusting
- Wooden platters
- Items made from synthetic fibers

Limited Suitability:

- Some glasses may become dull after several washes
- Silver and aluminum products have a tendency to discolor during washing
- Glazed patterns may fade if frequently machine washed

Dishwasher Basket Loading Guidelines

For best performance, follow these guidelines before and after loading the dishwasher basket. Basket and cutlery baskets may vary according to model.

- Scrape off large amounts of leftover food from your dishes. Soften and remove burnt food remnants from pans. It is not necessary to rinse dishes before washing.
- Place objects in the dishwasher in the following manner:
 - A. Place cups, glasses, pots/pans, etc., face down.
 - B. Curved items or those with recesses should be loaded at an angle or slant so that water can run off.
 - C. All utensils are must be stacked securely so that they do not tip over.
 - D. Place all utensils in the same direction so that the spray arms can rotate freely during the wash cycle.

Note: Very small items should not be washed in the dishwasher, as they can easily fall out of the basket.

- Load hollow items such as cups, glasses, pans, etc., with the opening facing downwards so that water cannot collect in the container.

- Dishes and cutlery should lie inside one another or cover each other.
- Glasses should not touch, as this can cause damage.
- Load large, difficult to clean items into the basket.
- Knives with long blades should not be stored in an upright position.
- Long and/or sharp items and cutlery should be positioned horizontally in the basket.
- Do not overload the dishwasher. This is important for optimal results and for energy conservation.

Loading the Basket

Position dishes and cutlery according to the diagram and corresponding numbers below:

- 1 Cups
- 2 Serving Bowls
- 3 Glasses
- 4 Saucers
- 5 Fruit Bowls
- 6 Oval Platter
- 7 Dinner Plates
- 8 Bread and Butter Plates
- 9 Cutlery Basket

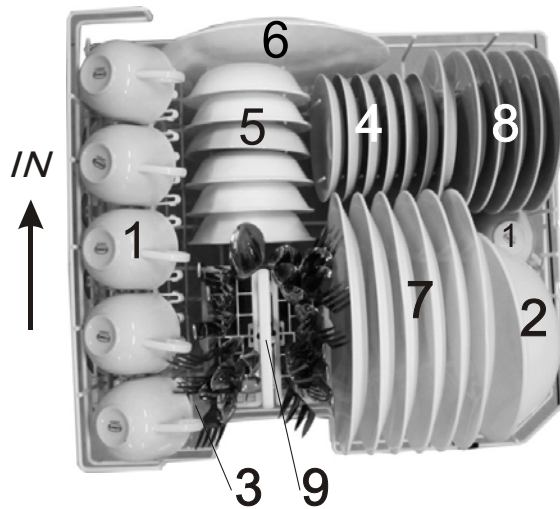

Basket Plate Racks

The basket is fitted with plate racks which may be stowed horizontally if needed.

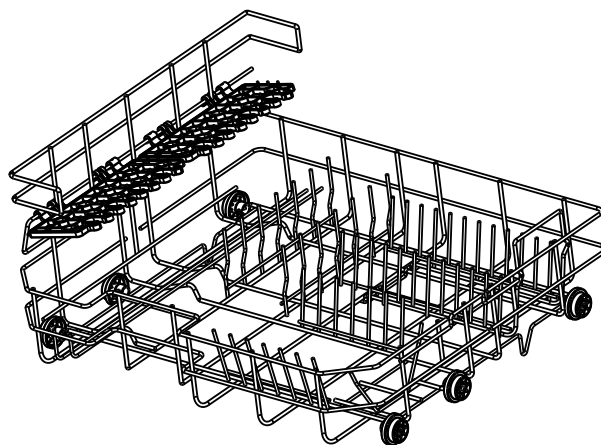

The Cutlery Basket

Cutlery should be placed in the cutlery basket with the handles at the bottom. If the rack has side baskets, spoons should be loaded individually into the appropriate slots. Especially long utensils should be placed in the horizontal position at the front of the upper basket as shown.

- 1 Dinner Forks
- 2 Salad Forks
- 3 Knives
- 4 Teaspoons
- 5 Serving Spoons
- 6 Serving Forks

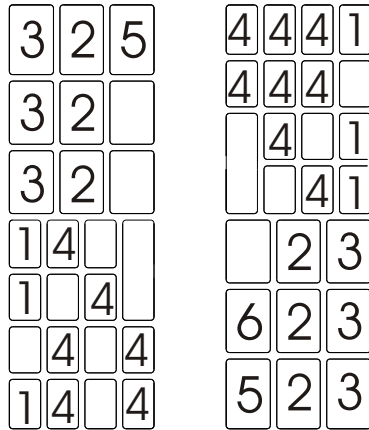

⚠ WARNING!

- Do not let any items extend through the bottom of the basket.
- Always load sharp utensils with the sharp points pointing down.

For personal safety and optimal performance, place silverware according to these guidelines:





- **Do not nest them together.**
- **Place silverware with the handles facing down.**
- **Place knives and other sharp objects with the handles facing up.**

5. Starting a Wash Cycle

Wash Cycle Table

Note:

- (★) Indicates that you will need to fill rinse aid dispenser
- *AHAM DW-1-2005: This program is the test cycle; the recommended rinse aid dispenser setting is 6.

Program	Cycle Selection Information	Description of Cycle	Detergent Pre/Main	Run Time (Minutes)	Energy (Kwh)	Water (Liters)	Rinse Aid
Heavy 	For extremely soiled loads including pots, pans and dishes with food that has dried and hardened.	Pre-wash Pre-wash 122° F (50° C) Pre-Wash 122° F (50° C) Wash 140° F (60° C) Wash 122° F (50° C) Rinse Rinse 149° F (65° C) Drying	3/15g	110	0.499	15.9	★
Normal *(AHAM) 	For normally soiled loads including plates, glassware and lightly soiled pans.	Pre-wash Pre-wash Pre-wash Wash 131° F (55° C) Rinse Rinse 149° F (65° C) Drying	3/15g	85	0.344	13.6	★
Light 	For lightly soiled loads, including plates, glassware and bowls.	Pre-wash Pre-Wash 122° F (50° C) Wash 122° F (50° C) Rinse Rinse 140° F (60° C) Drying	3/15g	75	0.317	11.5	★
Speed 	For quickly washing lightly soiled loads that do not require drying.	Pre-Wash Pre-Wash 122° F (50° C) Wash 122° F (50° C) Rinse Rinse 131° F (55° C)	15g	45	0.236	11.5	
Soak 	For rinsing dishes you plan to wash at a later time.	Pre-wash	N/A	10	0.01	2.5	

Turning on the Appliance

To start a wash cycle:

Pull out the dishwasher basket. See section "Loading the Dishwasher Basket."

Pour in dishwashing detergent. See section "Using Detergent."

Insert the plug into appropriate outlet. Remember: the power supply is 120V/60 Hz.

Make sure that the water supply is turned to full pressure.

Select appropriate wash program.

Heavy Normal Light Speed Soak

Press the Start/Reset button. The dishwasher will start.

Note:

If you press the Start/Reset button while the dishwasher is running, the selected program light will stop blinking and the dishwasher will beep every minute until Start/Reset is pressed again.

Changing Wash Cycles

If the dishwasher has only been running for a short period of time, you can change the wash cycle. However, if the machine has run long enough that the detergent has already been released, it is also possible that the wash water has already been drained. In this case, you will need to refill the detergent dispenser and then choose the appropriate cycle. See section "Using Detergent."

Press the Start/Reset button and hold for three seconds. This will put the dishwasher into standby mode and allow you to change your wash cycle to the appropriate program. After choosing the appropriate wash cycle, press the Start/Reset button one more time. The dishwasher will resume washing in approximately 10 seconds.

Note: Opening the door while the dishwasher is running will cause the dishwasher to momentarily pause. To start the wash again, close the door and push the Start/Reset button. The dishwasher will resume washing in approximately 10 seconds.

Indicator Lights:

- | | |
|-------------------------------------|----------|
| A. All program lights off: | Stand-by |
| B. One program light is illuminated | Paused |
| C. One program light is blinking | Running |

Note: If you open the door while the dishwasher is running, the dishwasher will pause. After closing the door and pushing Start/Reset, the dishwasher will resume in approximately 10 seconds.

Adding a Dish

You can add an additional dish at any time before the detergent has been released from the detergent dispenser.

1. Press the Start/Reset button.
2. Open the door slightly to pause the washing.
3. After spray arms have stopped, you can open the door completely.
4. Add any additional dishes.
5. Close the door.
6. Press the Start/Reset button. Dishwasher will begin to run again in approximately 10 seconds.

At the End of the Wash Cycle

When the dishwasher cycle has completed, the dishwasher will sound an alarm for 8 seconds and then stop. Turn off your dishwasher by pressing the ON/OFF button, then turn off the water supply and open the door. Extremely hot dishes are more susceptible to breaking, so wait approximately 15 minutes before unloading. Dishes will also dry better if given time to properly cool.

- **Turn off the dishwasher.**
Check to make sure all indicator lights are off, signaling that the wash cycle has ended. Turn off your dishwasher by pressing the ON/OFF button.
Turn off tap water.
- **Carefully open the door.**
Hot dishes are more susceptible to breaking. Allow them to cool for 15 minutes before removing.
Open the dishwasher door and leave it open to allow cool air to circulate. This will improve your drying.
- **Unload the dishwasher.**
It is normal for the dishwasher to remain wet inside after the wash cycle has finished.

WARNING! It is dangerous to open the door while the machine is washing; hot water has the potential to scald and/or burn.

6. MAINTENANCE AND CLEANING

Filtering System

The filter is designed to prevent stray pieces of food and small objects from getting inside the pump.

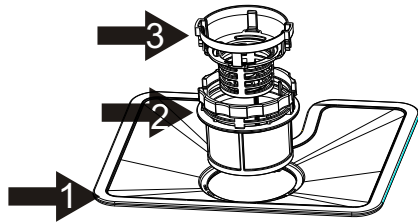

1. Main Filter

Food and soil particles trapped by the main filter are pulverized by a special jet on the spray arm and washed down the drain.

2. Fine Filter

The fine filter holds soil and food residue in the sump area to prevent it from being redeposited on dishes during the wash cycle.

3. Coarse Filter

The coarse filter traps larger items like bone or glass that could potentially block the drain. To remove items caught by the coarse filter, gently squeeze the side tabs on the filter and lift out.

Filter Assembly

The filter will efficiently remove all food particles from the wash water, making it fit to be re-used again during the cycle. For best performance and results, you should clean the filter assembly regularly. Remove the large food particles trapped in the coarse filter after each wash cycle by rinsing the filter under running water. To remove the filter assembly, simply pull up on the handle.

WARNING!

- **Never run the dishwasher if the filters are not in place.**
- **The dishwasher should never be used without filters.**
- **Improperly replacing the filter will reduce the performance level of the dishwasher and potentially damage your dishes and utensils.**

Step 1: Turn the coarse filter in a counter-clockwise motion

Step 2: Lift up



Step 3: Lift the main filter out

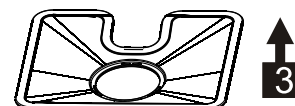

NOTE: Replace the filter assembly by reversing steps 3 through 1. Insert the main filter back in place, insert the fine filter and coarse filter, and screw the coarse filter back in place by turning it in a clockwise motion.

Remember:

- Inspect all filters before every cycle to ensure there are no food particles.
- By unscrewing the coarse filter, the entire filter assembly can be removed. Always remove food remnants and clean the filters by placing them under running water.

NOTE: The entire filter assembly should be cleaned once a week.

Cleaning the Filter

Use a cleaning brush to clean both the coarse filter and the fine filter. Reassemble all filter parts as shown in the diagram and re-insert entire filter assembly into the dishwasher by positioning and pressing down.

WARNING: When cleaning the filters, do not hit them against a surface. This could cause the filters to become misshaped and potentially affect the dishwasher's performance.

Maintaining Your Dishwasher

Clean your control panel by using a lightly damp cloth. Finish by drying thoroughly.

To clean the exterior, use a wax specifically designed for dishwashers.

Never use any sharp objects, scouring pads or harsh chemical cleaners on any part of your dishwasher.

Cleaning the Door

Clean the edge around the door with a soft cloth that is lightly damp. Never use any type of spray cleaners to ensure that water does not enter the door lock and affect electrical components.

WARNING!

- **Never use a spray cleaner to clean the door panel. The door lock and electrical components may be damaged.**
- **Never use abrasive cleaning products or rough towels to avoid scratching or leaving spots on the stainless steel surface.**

Protection against Freezing

During the winter months, implement the following procedures after each wash cycle to prevent water lines from potential damage:

1. Cut off all electrical power to the dishwasher.
2. Turn off the water supply and disconnect the water inlet pipe from the water valve.
3. Drain water from both the inlet pipe and the water valve. You can use a pan to catch any water.
4. Reconnect the water inlet pipe to the water valve.
5. Remove the filter at the bottom of the dishwasher tub. You can use a sponge to soak up excess water in the sump.

NOTE: If your dishwasher stops working due to ice, please contact an authorized service department.

Cleaning the Spray Arms

You can easily remove the spray arms to for periodically cleaning the nozzles. This will prevent possible clogging. To remove a spray arm, simply grasp in the middle and pull upwards. Wash nozzles by placing under a stream of running water. Carefully replace them, making sure that they can rotate freely.

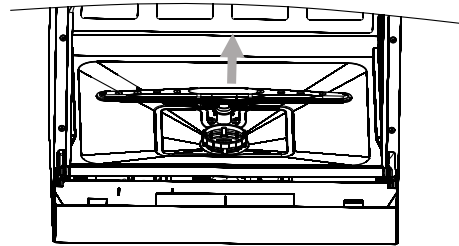

Keep Your Dishwasher Running Smoothly

- **After Every Wash**
After every wash, turn off the water supply and leave the door slightly open to ensure that any lingering moisture and odor can properly escape.
- **Remove Electrical Plug**
Before any type of cleaning or maintenance, always unplug your dishwasher from the electrical outlet.
- **No Solvents or Abrasive Cleaning Products**
Never use solvents or abrasive cleaning products when cleaning the exterior or rubber parts of your dishwasher.
Always use a soft cloth and warm, soapy water
To clean spots or stains on the interior surface, use a soft cloth with vinegar or a product specifically designed for interior use on dishwashers.
- **Vacation**
If you plan on leaving for an extended period of time, run one wash cycle with the dishwasher completely empty. Then unplug your dishwasher from the electrical outlet, turn off the water supply and leave the door slightly open. The door seals will last longer and you will eliminate the potential for any odors to accumulate.
- **Cleaning the Seals**
If food becomes trapped within the seals, odors can quickly form. To prevent this, clean all seals periodically with a damp cloth.

7. INSTALLATION INSTRUCTIONS

Attention: The installation of the pipes and electrical equipment should always be done by a professional.

WARNING: Electrical Shock Hazard

Disconnect all electrical power before you install your dishwasher.

Failure to do so can result in electrical shock, injury or death.

Preparing for Installation

For ideal use, install your dishwasher near an existing inlet, drain hose and power code. Choose one side of your dishwasher to use for connecting drain hoses.

POSITIONING THE APPLIANCE

Place your dishwasher in the desired location, ensuring that there is a wall for the back to rest against. Your dishwasher is equipped with water supply and drain hoses that can be positioned on either the right or left in order to meet varying installation needs.

POWER CONNECTION

WARNING!

To ensure your safety:

- **NEVER USE AN EXTENSION CORD OR ADAPTER PLUG WITH THIS DISHWASHER.**
- **DO NOT, UNDER ANY CIRCUMSTANCES, CUT OR REMOVE THE GROUNDING PRONG FROM THE POWER CORD.**

Electrical Requirements:

View the rating label on your dishwasher for the proper voltage requirements and then connect the dishwasher to the appropriate power supply. Use the required fuse 10 amp, time delay fuse, or circuit breaker as recommended and provide a separate circuit that will only be used with this dishwasher.

WARNING: Ensure proper grounding exists before use.

Electrical Connection

Always check to make sure that the voltage and frequency of the power you are using corresponds to those listed on the dishwasher rating plate. Only insert the plug into an electrical outlet that is properly grounded. If the electrical outlet is not appropriate, replace the outlet. Do not use adapters or anything similar; they can cause overheating and burns.

Grounding Instructions:

This dishwasher must be grounded. If there is any type of malfunction or breakdown, grounding will reduce the risk of electric shock by providing the path of least resistance for the current to travel. This dishwasher is equipped with a power cord and 3 prong grounding plug. It must be plugged into a 3-prong outlet that has been installed and grounded in accordance with all local standards and requirements.

WARNING!

- **Improperly grounding this dishwasher can result in electric shock.**
- **Always have a certified electrician check to make sure that your dishwasher is properly grounded if you are ever unsure.**
- **Never alter or modify the 3-prong plug that is installed on the electrical cord. If it does not fit into your wall outlet properly, please contact a certified electrician.**

WATER CONNECTION

Back View

Back of Dishwasher:

1. Drain port
2. Power Cord
3. Inlet port

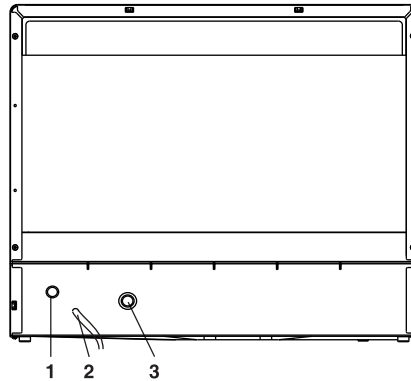

Your dishwasher comes equipped with a “quick connect” assembly that includes the inlet and drain hose. However, the faucet adapter must be installed on your faucet before you can connect the dishwasher. The adapter is compatible with faucets that have either inside (female) or outside (male) threaded connections.

Quick Connect Assembly

Drain Hose:

1. Drain port connection
2. Quick connect connection

Inlet Hose

3. Inlet port connection
4. Quick connect connection

Faucet Adapter

5. Faucet adapter
6. Faucet washer

Quick Connect:

7. Pressure relief valve
8. Faucet adapter connection
9. Locking collar
10. Inlet hose connection
11. Drain hose connection

Quick Connect Assembly

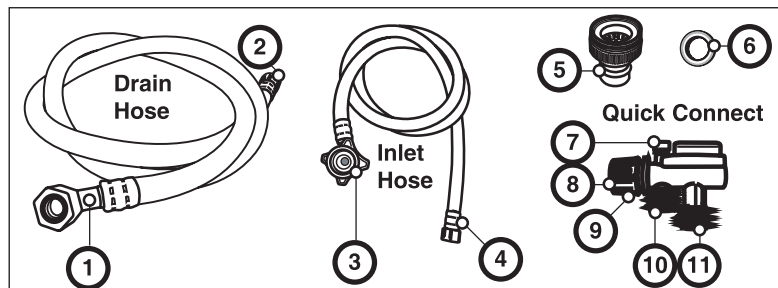

WARNING!

In order to avoid unnecessary water in the hose, close the faucet after use.

1. Screw the faucet adapter onto/into your faucet. Check to make sure there are no leaks. You can use Teflon tape to temporarily eliminate leaks if necessary.
2. Connect the six-sided connection of the drain hose to the drain port on the back of your dishwasher. Make sure not to damage the threads by over-tightening.
3. Connect the star shaped connection of the inlet hose to the inlet port on the back of the dishwasher. Make sure not to damage the threads by over tightening.
4. Connect the circular connection of the drain hose to the longer (bottom) male connection on the quick connect.
5. Connect the circular connection of the inlet hose to the shorter (top) male connection on the quick connect.
6. To attach the quick connect onto the faucet adapter, pull down on the outer locking collar of the quick connect while pushing the quick connect upward into the faucet adapter.
7. When the quick connect snaps onto the faucet adapter, release the locking collar. Check to make sure that the connection is secure.
8. Slowly open the hot water line and check to see if there are any water leaks at the hose connections. If you see a leak, immediately turn off the water supply and repair the connection.

Important:

1. Once the water supply is open, even if you close it immediately after, the inlet hose will become pressurized.
2. To relieve water pressure from inside the inlet hose, first make sure the water line (faucet) is closed, then press and hold the red pressure relief button on the quick connect until the water stops flowing.

WARNING

Failure to relieve water pressure before disconnecting the quick-connect from the faucet will result in back-pressure and over-spray. This water can be very hot and can potentially cause severe burns and/or scalding.

DANGER

Do not let children disconnect the dishwasher. Closely supervise all children near the dishwasher.

Note:

Hard water conditions will negatively affect your dishwasher's washing performance. Hard water can also contribute to a white filmy substance, also known as "lime," on the stainless steel surface of the dishwasher tub and heating element. To minimize the buildup of lime, periodically run the dishwasher empty with 1 cup of white vinegar. For optimal results, do this on a weekly basis.

To Disconnect your Dishwasher

1. Completely shut off the water supply at the faucet.
2. Unplug the electrical cord from the outlet.

STARTING THE DISHWASHER

Before starting your dishwasher, you should check to make sure:

1. The dishwasher is level
2. The inlet valve is open
3. None of the connections are leaking
4. All wires are tightly connected
5. Power is turned on
6. The inlet and drain hoses are not knotted
7. Remove all packing materials and printed inserts from inside the dishwasher.

Attention: After installation, keep this manual for easy reference. The contents will be very helpful for ensuring optimal performance.

8. TROUBLESHOOTING TIPS

Before Calling for Service

Please refer to these troubleshooting tips for possible solutions to minor problems. If the problem persists, please contact an authorized service department or customer service.

	Problem	Possible Causes	What to Do
Technical Problems	Dishwasher will not start.	A fuse may be blown or the circuit breaker may have tripped.	Replace the fuse or reset your circuit breaker. Turn off other appliances that may be sharing the same circuit.
		The power supply isn't turned on.	Make sure that the dishwasher is turned on. Check to make sure that the power cord is properly plugged into the wall outlet.
		Dishwasher door hasn't been properly closed.	Re-close the dishwasher door and make sure that it has properly latched.
	Water is not pumped out.	There's a kink in the drain hose.	Check to make sure the drain hose doesn't have any kinks or bends.
		The filter is plugged.	Check the coarse filter to make sure there are no food particles lodged inside. See "Cleaning the Filter."
		Kitchen sink is plugged.	Check to make sure that your kitchen sink is draining properly. If not, you may need to contact a professional plumber.
General Problems	Lingering detergent suds	Wrong detergent	You must use the proper dishwasher detergent to eliminate sud build-up. If suds do accumulate, open the door and allow them to evaporate. Then pour in a gallon of cold water to the bottom of the dishwasher, close the door and turn the machine to the "Soak" cycle to allow the water to drain. Repeat as many times as necessary.
		Rinse aid was spilled.	If you do spill rinse aid, make sure to wipe it up immediately to avoid suds.
	Stains on inside of dishwasher	Detergent with colorant was used.	Use a non-colorant detergent.
	White film on the inside surface	Hard water	Wear rubber gloves and scrub the interior with a damp sponge and dishwasher detergent.
	Cutlery has rust stains	Your cutlery is not corrosion resistant.	Use corrosion resistant cutlery
		Traces of salt got into the wash cycle.	After adding dishwasher salt, make sure to run the Quick Wash cycle with an empty load. (Do not choose Turbo cycle if it is an option).
	The lid of the water softener container is loose.	Check lid and make sure it is securely closed.	
Noise	Noise in interior of dishwasher	The spray arm is hitting an item in the	Pause the wash cycle and rearrange the dishes.

		basket.	
	Rattling noise in interior	An item is not securely placed in the basket.	Pause the wash cycle and rearrange the dishes.
	Noise in the water pipes	Potentially an installation problem or loose connections at cross-sections in the piping	Will not harm your dishwasher's performance. Contact your plumber.
Unsatisfactory Washing Results	Dishes aren't clean	Dishes were improperly loaded	See "Loading the Dishwasher."
		The wash cycle selected was not strong enough	Select a stronger wash cycle, see "Wash Cycle Table."
		There wasn't enough detergent	Use more detergent or opt for a more powerful detergent.
		Dishes blocked the spray arms	Rearrange dishes, ensuring that the spray arms can move freely.
		Filter system is not clean or is improperly fitted. This can also cause the spray arms to become clogged.	Check to make sure the filter is clean and properly inserted. Clean the spray arm jets. See "Cleaning the Spray Arms"
	Glasses look cloudy	Soft water and too much detergent	Use less detergent if you have soft water, and choose the shortest cycle possible for washing glassware.
	Dishes appear to have black or gray marks	Aluminum cutlery has been rubbed against the dishes	A mild abrasive cleaner will eliminate the marks.
Detergent dispenser still has detergent remaining after the wash.	Dishes were likely blocking the dispenser and preventing it from opening properly	Re-load the dishes properly and re-wash.	
Unsatisfactory Drying Results	The dishes are not dry	Improperly loaded	Load the dishwasher properly as suggested in "Loading the Dishwasher."
		Not enough rinse aid used	Increase/Re-fill the rinse aid dispenser.
		Removing dishes too early	Never empty your dishwasher immediately after washing. Open the door slightly and allow steam to escape and unload dishes only when they have cooled. Always empty the low basket first to prevent the top dishes from dripping water onto those beneath.
		Wrong wash cycle	Shorter wash cycles also have a lower washing temperature. Choose a wash cycle that's longer and has a higher temperature.
		Cutlery has a poor quality coating	Water will not drain properly with low or poor quality cutlery. These type of dishes are not suitable for the dishwasher.

ERROR CODES

In the event of a malfunction, the dishwasher will display error codes:

Code	Meaning	Possible Cause
The Start/Reset light blinks intermittently.	Longer inlet time	Faucet is not open, water intake is restricted, or the water pressure is too low.
	Overflow	The dishwasher is leaking.

WARNING!

- **If overflow occurs, turn off the main water supply and call an authorized service department or customer service.**
- **If there is lingering water in the tub due to an overflow or leak, be sure to remove the water before starting the dishwasher again.**

TECHNICAL INFORMATION

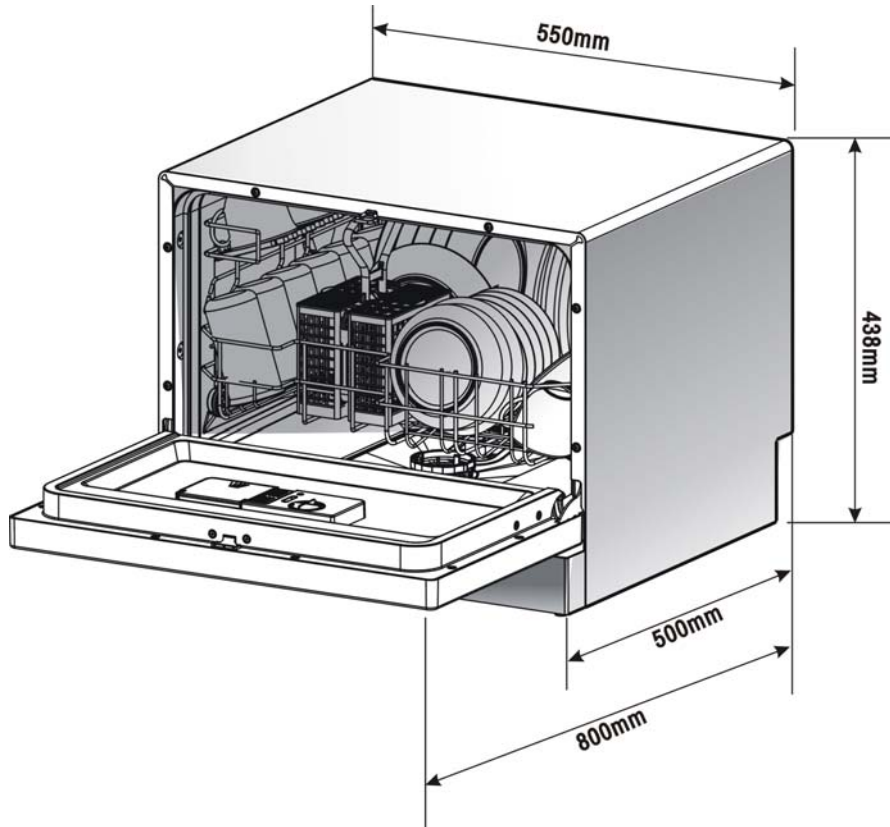

Height	17.25 inches
Width	21.70 inches
Depth	19.70 inches
Voltage:	See Rating Label
Water Pressure	0.04-1.0MPa
Hot Water Connection:	Max: 140° F 60 ° C
Power Supply:	See Rating Label
Capacity	6 place settings

DETAILED PARTS DIAGRAM

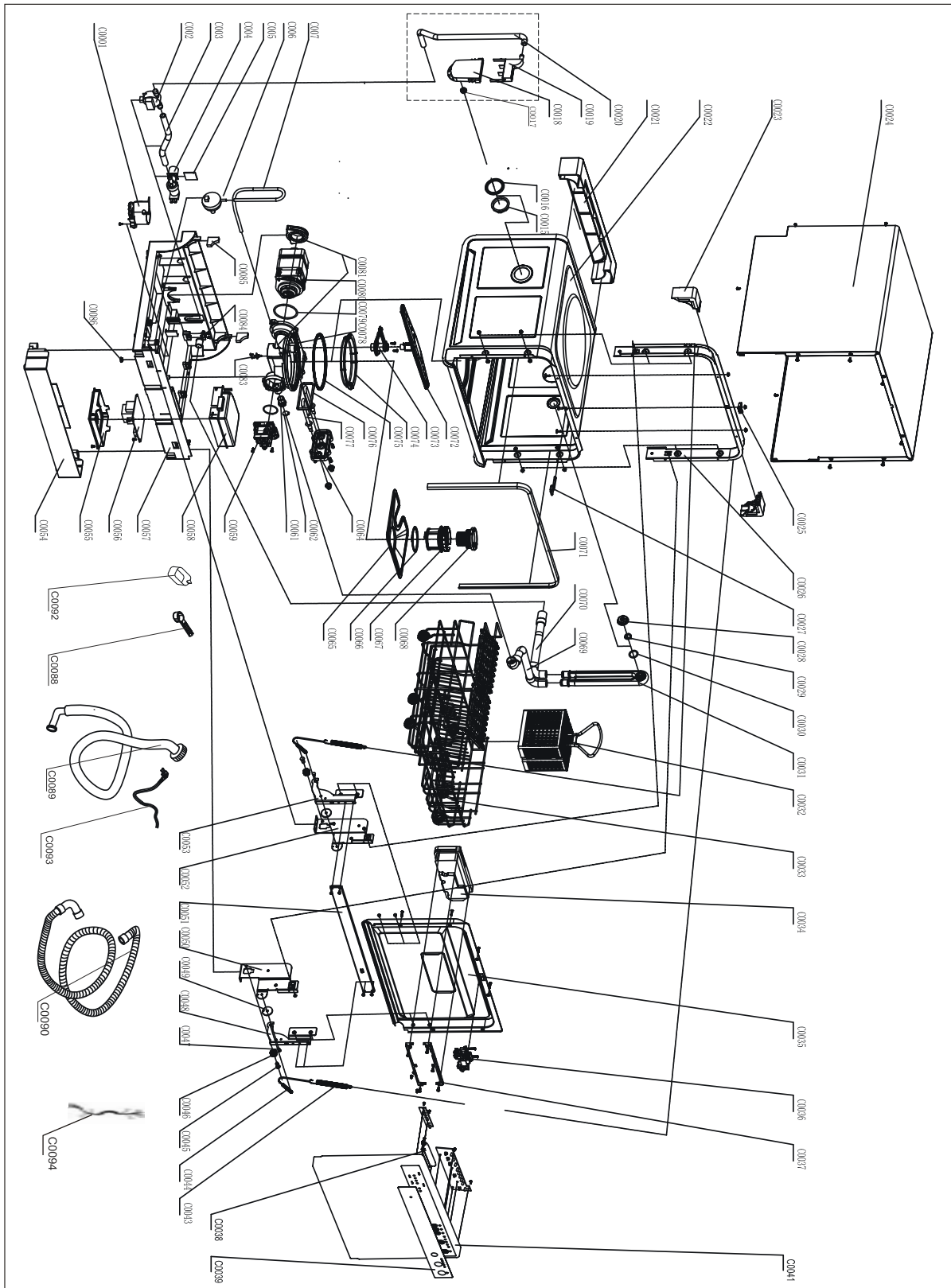

Free Manuals Download Website

<http://myh66.com>

<http://usermanuals.us>

<http://www.somanuals.com>

<http://www.4manuals.cc>

<http://www.manual-lib.com>

<http://www.404manual.com>

<http://www.luxmanual.com>

<http://aubethermostatmanual.com>

Golf course search by state

<http://golfingnear.com>

Email search by domain

<http://emailbydomain.com>

Auto manuals search

<http://auto.somanuals.com>

TV manuals search

<http://tv.somanuals.com>