

# *PORTABLE DVD PLAYER*

SLOT-IN TYPE

---

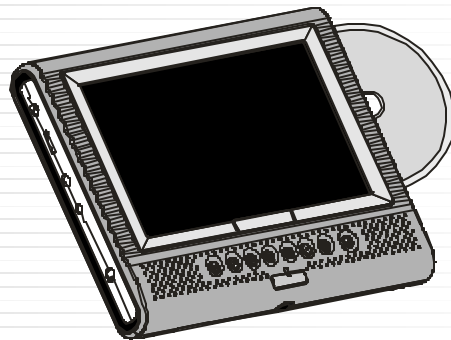

## Operating Instructions



## IMPORTANT SAFETY INSTRUCTIONS

1. Read these instructions.
2. Keep these instructions.
3. Heed all warnings.
4. Follow all instructions.
5. Do not use this apparatus near water.
6. Clean only with dry cloth.
7. Do not block any ventilation openings. Install in accordance with the manufacturer's instructions.
8. Do not install near any heat sources such as radiators, heat registers, stoves, or other apparatus (including amplifiers) that produce heat.
9. Do not defeat the safety purpose of the polarized or grounding-type plug. A polarized plug has two blades with one wider than the other. A grounding type plug has two blades and a third grounding prong. The wide blade or the third prong are provided for your safety. If the provided plug does not fit into your outlet, consult an electrician for replacement of the obsolete outlet.
10. Protect the power cord from being walked on or pinched particularly at plugs, convenience receptacles, and the point where they exit from the apparatus.
11. Only use attachments/accessories specified by the manufacturer.
12. Use only with the cart, stand, tripod, bracket, or table specified by the manufacturer, or sold with the apparatus. When a cart is used, use caution when moving the cart/apparatus combination to avoid injury from tip-over.



13. Unplug this apparatus during lightning storms or when unused for long periods of time.
14. Refer all servicing to qualified service personnel. Servicing is required when the apparatus has been damaged in any way, such as power-supply cord or plug is damaged, liquid has been spilled or objects have fallen into the apparatus, the apparatus has been exposed to rain or moisture, does not operate normally, or has been dropped.
15. To Reduce the Risk of Fire or Electric Shock, Do not Expose This Appliance To Rain or Moisture.
16. The Shock Hazard Marking and Associated Graphical Symbol is provided on the bottom panel of unit.
17. Apparatus shall not be exposed to dripping or splashing and no objects filled with liquids, shall not be placed on the apparatus.

**NOTE:**

This battery pack (Sb11, SB11-X,) is just for SDV17, SDVX7, SDVX7-XXX series use only.

## Precautions

---

Thank you for purchasing Portable DVD player. Please read this manual carefully before operating and reserve it for future reference. It will be helpful to you if you encounter any operational problem.

**WARNING:** TO REDUCE THE RISK OF FIRE OR ELECTRIC SHOCK, DO NOT EXPOSE THIS APPLIANCE TO RAIN OR MOISTURE, DRIPPING OR SPLASHING AND THAT NO OBJECTS FILLED WITH LIQUIDS, SUCH AS VASES, SHALL BE PLACED ON THE APPARATUS. DANGEROUS HIGH VOLTAGES ARE PRESENT INSIDE THE ENCLOSURE. DO NOT OPEN THE CABINET. REFER SERVICE TO QUALIFIED PERSONNEL ONLY.

**ATTENTION:** TO PREVENT ELECTRIC SHOCK, MATCH WIDE BLADE OF PLUG TO WIDE SLOT, FULLY INSERT.

**LASER:** This Digital Video Disc player employs a Laser System. To ensure proper use of this product, please read this owner's manual carefully and retain for future reference. Should the unit require maintenance, contact an authorized service location - see service procedure.

Use of controls, adjustments or the performance of procedures other than those specified may result in hazardous radiation exposure.

To prevent direct exposure to laser beam, do not try to open the enclosure.

Visible and invisible laser radiation when open and interlocks defeated.

**DO NOT STARE INTO BEAM**

LASER	
Type	Semiconductor laser GaAlAs
Wavelength	650nm/780nm
Output Power	5mW
Beam divergence	60degree



## Precautions

---

**WARNING:**

To reduce the risk of fire or electric shock, do not expose this appliance to rain or moisture.

**CAUTION:**

Use of controls or adjustments or performance of procedures those specified may result in hazardous radiation exposure.

**CAUTION**

**RISK OF ELECTRIC SHOCK. DO NOT OPEN**

To reduce the risk of electric shock, do not remove cover (or back). No user serviceable parts inside. Refer servicing to qualified service personnel.



The lightning flash with arrowhead symbol, with in an equilateral triangle, is intended to alert user to the presence of uninsulated dangerous voltage within the product enclosure that may be of sufficient magnitude to constitute a risk of electric shock to persons.



The exclamation point within an equilateral triangle is intended to alert the user to the presence of important operating and maintenance (servicing) instruction in the literature accompanying the appliance.



**CAUTION:**

**IN VISIBLE LASER RADIATION WHEN OPEN AND INTERLOCK FAILED OR DEFEATED. AVOID DIRECT EXPOSURE TO LASER BEAM.**

## Precautions

---

**MACROVISION:** This product incorporates copyright protection technology that is protected by U.S. patents and other intellectual property rights. Use of this copyright protection technology must be authorized by Macrovision, and is intended for home and other limited viewing uses only unless otherwise authorized by Macrovision. Reverse engineering or disassembly is prohibited.

**FCC NOTICE:** This device complies with part 15 of the FCC Rules. Operation is subject to the following two conditions: (1) this device may not cause harmful interference, and (2) this device must accept any interference received, including interference that may cause undesired operation.

**DOLBY:** Manufactured under license from Dolby Laboratories. "Dolby" and the double-D symbol are trademarks of Dolby Laboratories.

## TableOfContents

<b>INTRODUCTION</b>	
PRECAUTIONS.....	<b>1</b>
TABLE OF CONTENTS.....	<b>4</b>
CAUTIONS ON USING THIS PLAYER.....	<b>6</b>
PRECAUTIONS FOR BATTERY PACK OPERATION.....	<b>8</b>
Operation of the battery pack.....	8
Storage.....	8
Service life and disposal.....	8
TYPES OF DISCS PLAYABLE ON THIS PLAYER.....	<b>9</b>
Marks indicated on DVDs.....	9
Disc structure.....	10
USING THESE OPERATING INSTRUCTIONS.....	<b>11</b>
<b>BEFORE USING</b>	
CHECKING THE ACCESSORIES.....	<b>12</b>
REMOTE CONTROL UNIT AND MAIN UNIT PREPARATIONS.....	<b>13</b>
Notes on using the remote control unit.....	13
Replacing the battery.....	13
Remote control unit operating range.....	14
<b>PARTS AND FUNCTIONS.....</b>	<b>15</b>
Liquid crystal display.....	15
Main unit control section.....	15
Main unit left side.....	16
Main unit right panel.....	17
Main unit rear side.....	18
How to stand.....	18
Main unit bottom side.....	18
Remote control unit (frequently used buttons).....	19
Remote control unit (other buttons).....	20
Names of battery parts and their functions.....	21
<b>CONNECTING THE PLAYER TO OTHER DEVICES.....</b>	<b>22</b>
Connecting to a TV.....	22
Connecting to a Dolby Digital/DTS/MPEG decoder or an amplifier with built-in decoder.....	23
Connecting to a digital amplifier that is not Dolby Digital/DTS/MPEG compatible.....	24
Connecting to active speaker systems.....	25
Connecting gear phone.....	26
<b>USING THE BATTERY... ..</b>	<b>27</b>
Recharging the battery pack.....	27
Notes for recharging.....	28
Attaching the battery pack to the player.....	28
AC power operation.....	29
Removing the battery pack from the player.....	29

## TableOfContents

<b>BASIC OPERATIONS</b>		<b>SYSTEM SETUP</b>
TURNING ON THE POWER.....	<b>30</b>	TV SYSTEM.....39
PLAYBACK FUNCTIONS.....	<b>31</b>	SCREENSAVER.....39
Loading.....	31	TV TYPE.....40
Playing.....	32	PASSWORD.....41
If a menu screen appears.....	32	RATING.....41
Stopping playback.....	33	DEFAULT.....41
Pausing playback.....	33	
Returning to the previous chapter or track (DVDs, video CDs and CDs).....	34	
Moving to the next chapter or track (DVDs, video CDs and CDs).....	34	
Removing the disc.....	34	
TURNING OFF THE POWER.....	<b>35</b>	<b>LANGUAGE SETUP</b>
		OSD LANGUAGE.....42
<b>ADVANCED OPERATIONS</b>		AUDIO LANGUAGE.....42
ADVANCED FUNCTIONS.....	<b>36</b>	SUBTITLE LANGUAGE.....43
Searching for a specific scene... ..	36	MENU LANGUAGE.....43
Viewing in slow motion DVDs and video CDs.....	36	
Repeating DVDs, video CDs and CDs.....	36	
Selecting angle (multi-angle).....	36	
Changing from AVOUT to AVIN.....	37	
<b>SETUP THE PLAYER</b>		<b>AUDIO SETUP</b>
GENERAL STEPS OF SETUP.....	38	AUDIO OUT.....44
		<b>VIDEO SETUP</b>
		BRIGHTNESS.....45
		CONTRAST.....45
		HUE.....46
		SATURATION.....46
		<b>DIGITAL SETUP</b>
		DIGITAL SETUP.....47
		<b>CAUTIONS ON USING..</b>
		<b>48</b>
		<b>TROUBLESHOOTING..</b>
		<b>49</b>

## Cautions on Using this Player

---

### Do not move the player during playback

During playback, the disc spins at high speed, so do not lift or move the player. Doing so may damage the disc.

### Transporting the player

When transporting the player be sure to remove the disc and turn off the power, then unplug the power cord.

### Place of installation

Select a stable place near the TV or stereo system to which you are going to connect the player. Do not place the player on top of a TV or color monitor. Install the player away from cassette decks or other devices which are easily affected by magnetic forces.

### Do not place objects on top of the player

Do not place any objects on top of the player.

### Turn off the power when not using the player

If the player is connected to your TV but not in use then switch the power off. This will prevent interference with your normal TV picture. Noise problems may also be experienced if used near a radio.

### Special Note regarding use of player in vehicles

- We strongly advise against using the player while driving.
- Most countries and states have laws which prohibit or severely restrict the use of the player in vehicles while driving.
- Do not leave the player or the battery pack in places where the temperature is extremely low (about -10 or lower) or extremely high (about 60 or higher), such as inside the passenger cabin or trunk in midsummer. Doing so may warp the outer case or reduce the performance or quality of the battery pack.

### When carrying on planes

Heed the airline company's rules.

### When carrying in hospitals

Heed the hospital's rules.



## Cautions on Using this Player

---

### When using with car power cable in cars

Please turn on the engine and then connect with the car power cable for using.

### Cleaning the player

Normally clean the player using a soft, dry cloth. For tough dirt, apply some neutral detergent diluted in 5 to 6 parts water to a soft cloth, wring out thoroughly, wipe off the dirt, then wipe the player with a dry cloth. Note that alcohol, thinner, benzene, insecticides, etc., may cause the printer coating to peel off. Also avoid leaving rubber or plastic products in contact with the player for long periods of time, as this may damage the cabinet. When using chemically treated cloths, read the cloth's instructions carefully. Always unplug the power cord from the power outlet before cleaning the player.

To clean dirt off the liquid crystal display, wipe the display gently with a soft, dry cloth (such as a eyeglass cleaning cloth). Note that leaving water droplets on the display for long periods of time may result in discoloration or stains. For tough dirt, use a commercially available liquid crystal display cleaner.

### Copyrights

Unauthorized duplication, broadcast, public performance or rental of discs is prohibited by law.

## Precautions for Battery Pack Operation

---

### Operation of the battery pack

- Charge the battery pack fully before using it for the first time.
- When the surrounding temperature is high, the battery pack may sometimes be unusable due to activation of protection circuitry.
- When the portable DVD player is powered from the battery pack and if the player has not been operated for about 10 minutes with the power switched on, the player will turn off automatically. (Auto power off) The battery pack becomes hot after use and the portable DVD player also becomes hot during use. This is not a malfunction.
- When the battery pack is not to be used for a long period, be sure to remove it from the portable DVD player. If the battery pack is left attached, continual flow of weak current renders it overdischarged and eventually unusable even when you try to charge it later.
- If the portable DVD player is switched on while the battery pack is not fully charged, the operation may sometimes be unstable. Be sure to charge the battery pack fully before use.

### Storage

- The battery pack should be stored under a surrounding temperature between 15 and 25. Avoid storing it under extremely low temperatures, in a place with high temperature and high humidity or in a place subject to

soot, etc.

- When the battery pack is stored for a long period, at least once a year it is recommended to discharge it fully on the portable DVD player, recharge it fully and store it again.

### Service life and disposal



- When the charging time or available operation time becomes extremely short, the battery may be reaching the end of its life. The battery pack can be used for about 300 cycles of recharging and operations.
- To dispose of a used battery pack, wrap a piece of tape around the terminal section and treat it in compliance with your local regulations.

### Caution:

- Danger of explosion if battery is incorrectly replaced. Replace only with the same or equivalent type.

## Types of Discs Playable on this Player

- The discs listed on the table below can be played on this player without an adapter.
- The marks shown on the table below are indicated on the disc's label, package or jacket.





Types of playable discs and their marks	Diameter/Playable sides	Playback time
DVD-Video disc 	DVDvideo 12cm/single-sided 12cm/double-sided 1 layer 2 layer 1 layer 2 layer	Playbacktime (MPEG2format) 133minutes(4.7GB) 242minutes(8.5GB) 266minutes(9.4GB) 484minutes(17GB)
	CD 12 cm/single-sided	74 minutes

Note:

Do not support 8cm discs.

### Marks indicated on DVDs

DVD discs or packages include the marks shown below. These marks indicate the type of video or audio signals recorded on the disc and the function that can be used.

Mark	Meaning
	
	Indicates the number of audio tracks.
	Indicates the number of angles.
	Indicates the selectable picture aspect ratio.

Indicates the playable region number.

## Types of Discs Playable on this Player

### Disc structure

CDs are divided in units called tracks. (Generally one track corresponds to one song. Tracks are sometimes further divided into indexes.)

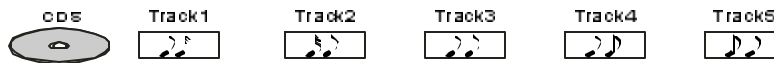

DVDs are divided in units called titles, which are further divided in chapters. They also include menu screens that do not belong to any title. With movies, normally one movie corresponds to one title. On karaoke discs, one song corresponds to one title. Some discs are not divided in this way, however, so be careful when using these search and programming functions.

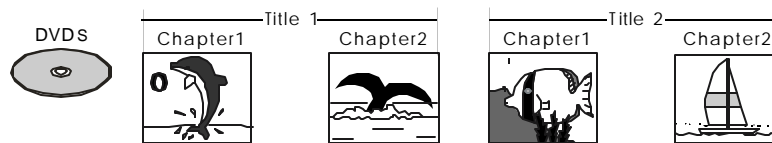

## Using These Operating Instructions

---

**Be sure to read the operating instructions carefully before using the player. It can ensure you taking maximum advantage of all functions of this player.**







When this player is connected to a TV or AV amplifier, these setup screens should be displayed. Choose the various corresponding settings according to the connected equipment.

With DVD it is possible to use setup to change the subtitle and audio languages and select the desired sound mode from among multiple soundtracks.

In order to take full advantage of the many functions of this player, be sure to store this OPERATING INSTRUCTIONS in an accessible place.

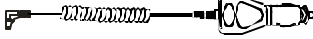
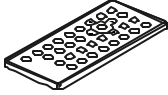
## Checking the Accessories

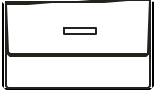
After unpacking, check that all the accessories listed below are included.

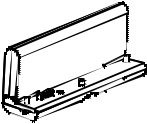
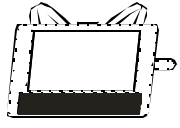
<b>AC/DC adapter</b> 	<b>AV cable</b> 
<b>Earphone</b> 	<b>Car power cable</b> 
<b>Card-type remote control unit</b> 	<b>Operating instructions (this manual)</b> 
<b>Soft carrying bag</b> 	<b>Accessories bag</b> 
<b>Battery pack</b> 	<b>Short car bag</b> 

## Remote Control Unit and Main Unit Preparations

### Notes on using the remote control unit

- Do not drop or step on the remote control unit or subject it to shocks. Doing so may damage it.
- Note that the remote control unit may not work if there are obstacles between it and the remote sensor.
- Do not expose the remote sensor to strong light. Doing so may make operation impossible.
- Use the remote control unit within the specified operating range.

### Replacing the battery

- 1** Insert your fingernails into A and B on the diagram below, press A according to the direction, then pull out the battery holder.

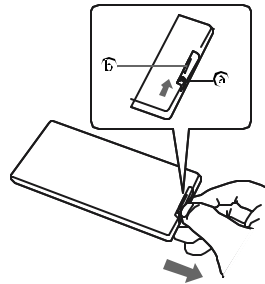

- 2** Remove the old battery, then insert the new battery into the battery holder with the + side facing upwards.

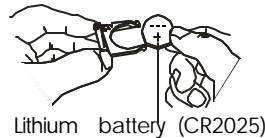

Lithium battery (CR2025)

- 3** Fit the battery holder back to its place.

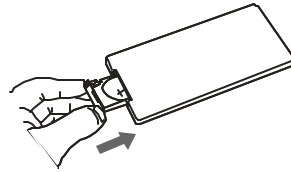

#### Note:

To prevent leakage of fluid from the lithium battery, remove the battery when not using the remote control unit for long periods of time (one month or more). If the battery leaks fluid, carefully wipe it out of the battery case, then change to a new lithium battery.

## Remote Control Unit and Main Unit Preparations

---

### Remote control unit operating range

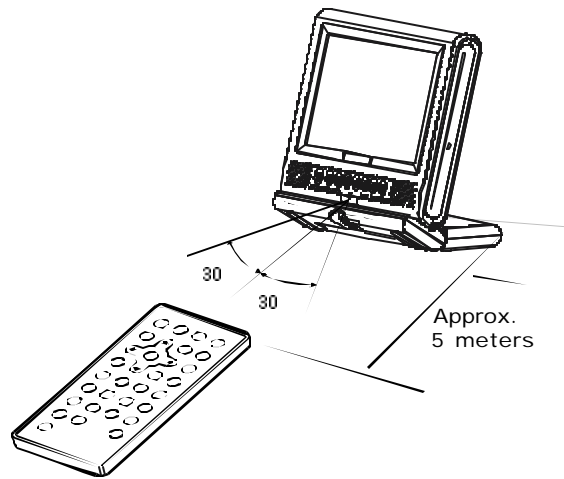

The remote control unit can operate within a distance of approximately 5 meters.

**Note:**

Most of the player's operations can be done by using the remote control unit.  
Some operations, however, can only be done by using the main unit buttons.



## Parts and Functions

### Liquid crystal display

The portable DVD player is equipped with liquid crystal display.

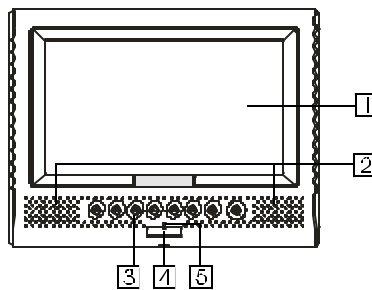

**1** Liquid crystal display

**2** Speakers

**3** Control section  
Control buttons

**4** Remote sensor  
The remote control signals are received here.

**5** Power indicator  
Off: No power connection.  
Red: The player is set to standby mode.  
Blue: The player is on. Turn on the power using ON button on the main unit or the STANDBY button on the remote control unit.

### Main unit control section

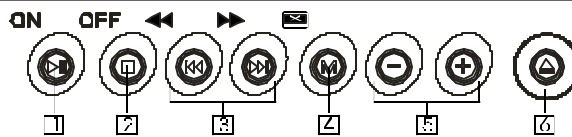

## Parts and Functions

### 1 Play/pause button

Press to play. When pressing during playback mode, pause mode is set. Press again to resume playback.

**Keep pressing it for about 1.5 seconds to power on the unit.**

### 2 Stop/off button

Press to stop playback.

**Keep pressing it for about 1.5 seconds to turn off the unit (standby status).**

### 3 Previous/next buttons

Use it to locate at the beginning of previous/next tracks or chapters.

**Keep pressing it for about 1.5 seconds during playback to switch playing speed of backward/forward through X2, X4, X8, X20, X2.**

### 4 Mode button

Use +/- key to adjust after entering on mode.

BRIGHTNESS: Level 0 to 8.

COLOR: Level 0 to 8.

TFTMODE: switch screen between 16:9 and 4:3.

VIEWMODE: switch screen between reverse and observe.

AV INPUT/OUTPUT: switch the AV function between input and output.

**Keep pressing the button about 1.5 seconds to turn off the display, and press it to resume.**

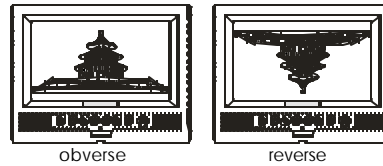

### 5 +/- buttons

Press to adjust display mode.

### 6 OPEN button

Press to pop out the disc.

### Main unit left side

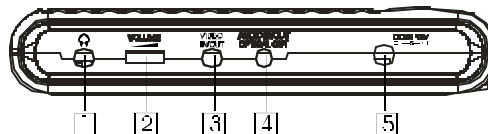

## Parts and Functions

---

**1** Phonejack

For connecting stereo headphone or an amplifier.

**2** Volume control

Use it to adjust the volume of the speakers or headphone.

**3** Video in/out jack

Input or output video signal to connected device by setting AV IN/OUT mode value. The included AV cable is connected here.

**4** Audio in/out and optical output jack

Input or output audio signal to connected device by setting AV IN/OUT mode value. Output optical audio signal to connected device. The included AV cable or optical digital cable is connected here.

**5** DC in

Connect the included AC adapter here.

### Main unit right panel

**1** Loader status indicator LED

Indicate loader status.

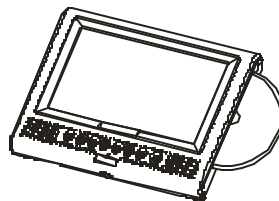
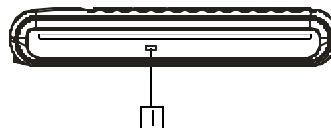

## Parts and Functions

### Main unit rear side

#### 1 Support

The unit can stand with this device.

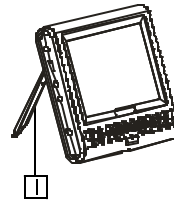
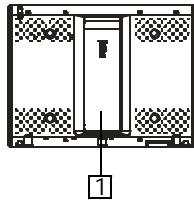

### How to stand

- 1 Pull out the support.
- 2 Draw out the support to a proper position.
- 3 Pull down the button to lock it.

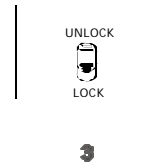
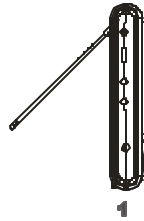

### Main unit bottom side

- 1 Hole for Battery Pack
- 2 Nut for Battery Pack
- 3 Battery connector

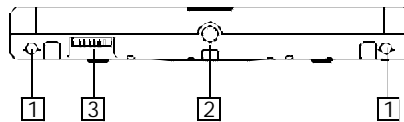

#### Note:

Remember to insert back the rubber cover to 3. BATTERY CONNECTOR after using the battery pack.

## Parts and Functions

### Remote control unit (frequently used buttons)

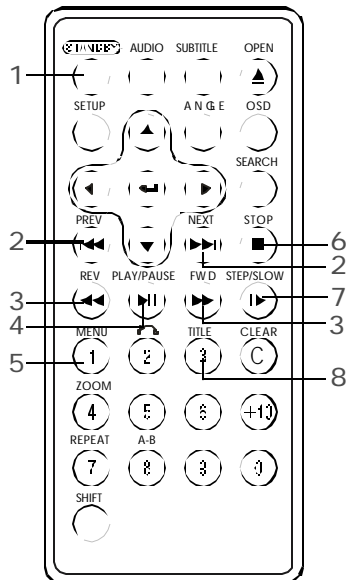

**1** STANDBY button  
Press this button to turn on or off the power.

**2** PREVIOUS/NEXT button (◀◀ and ▶▶)  
Use these buttons to search for the beginning of tracks or chapters.  
◀◀ : Backward direction  
▶▶ : Forward direction

**3** Scan buttons (◀ and ▶)  
Use these buttons to switch playing speed of playing forward or backward.

▶▶ : Forward direction  
◀◀ : Backward direction

**4** PLAY/PAUSE button (▶||)  
Use this button to play or pause playback.

**5** MENU button  
Press this button to display the DVD's menu screen.

**6** STOP button (■)  
Press this button to stop playback.

**7** STEP/SLOW button (▶|)  
Press this button to slow playback at 1/2, 1/4, 1/6, 1/7 speed. If at pause status, press this button to playback step-by-step.

**8** TITLE button  
Press this button to display the DVD's title.

## Parts and Functions

### Remote control unit (other buttons)

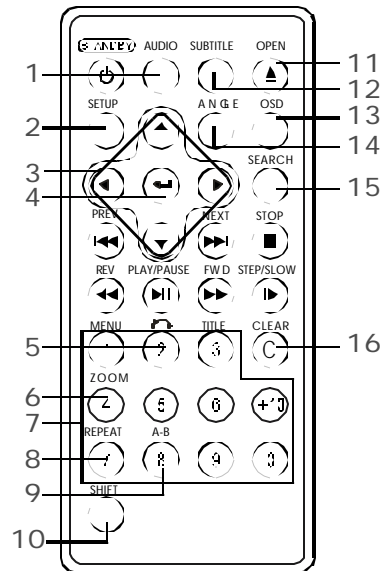

- 1 AUDIO**button  
Press this button to switch the audio language.
- 2 SETUP**button  
Press this button to display setup screen when at stop status.  
Press this button to display Video Enhance screen during playback.
- 3 Cursor**buttons  
Use these buttons to move the cursor up, down, left and right when selecting setting items.
- 4 ENTER**button  
Press it to enter/confirm setting item.
- 5 RETURN**button  
Press it to return back the previous item.
- 6 ZOOM**  
Zoom the picture on screen.
- 7 Number**buttons  
Press these buttons to input numbers. Pressing the SHIFT button to switch from function to number if necessary.
- 8 REPEAT**button  
For DVDs, use this button to play titles or chapters repeatedly. For CDs, use this button to play tracks or the entire disc repeatedly.
- 9 A-B REPEAT**button  
Press this button during playback to set two points and play these sections between them repeatedly.
- 10 SHIFT**button  
Press the shift button to switch number & function. (Default: function)
- 11 OPEN**  
Pop out disc.
- 12 SUBTITLE**button  
Press it to switch the DVD's subtitle language.
- 13 OSD**button  
Press this button to display the disc information.
- 14 ANGLE**button  
Press it to switch angle.
- 15 SEARCH**button  
Locate a title/ chapter/ time and play.
- 16 CLEAR**button  
Clear the numbers inputted before.

(Only for VCD, PBC on)

## Parts and Functions

### Names of battery parts and their functions

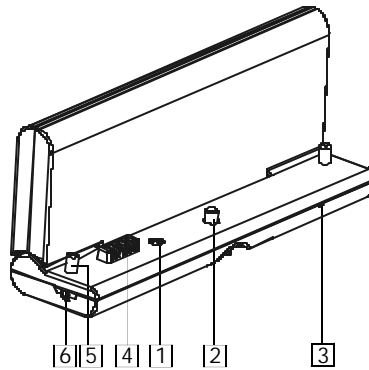

- 1** DC IN connector  
Connect the power adapter to recharge (AC/DC adapter).
- 2** Battery knob  
Twist to tighten/detach the battery pack.
- 3** Battery indicator LED.  
When the battery is discharging, LED is off.  
When recharging the battery, LED is red.  
When the LED turns from RED to off, means finishing recharge.
- 4** Player terminals  
Supply power to the player.  
**CAUTION:**  
Do not short-circuit the terminals.
- 5** Fix pole  
Fix the battery to the player when installing battery.
- 6** DC OUT (non-standard jack)  
Output DC 7.4/7.2V. Especially for supplying power to TV Tuner Box (optional accessory).

## Connecting the Player to Other Devices

---

### Before connecting

Turn off the power of the player and the device to be connected.

### Connecting to a TV

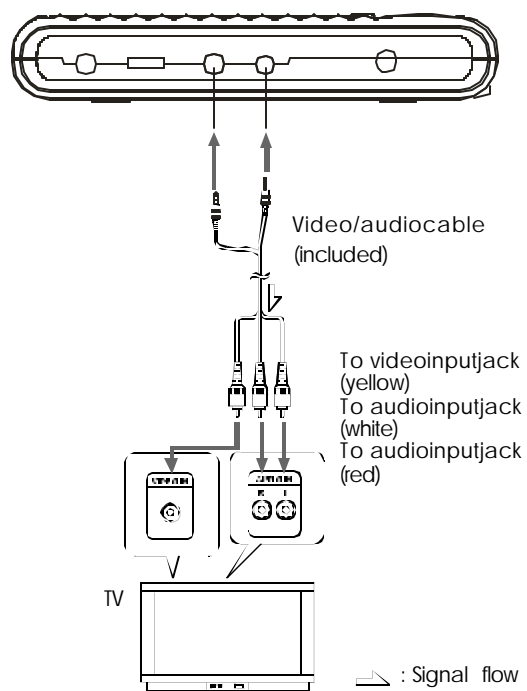



## Connecting the Player to Other Devices

### Connecting to a Dolby Digital / DTS / MPEG decoder or an amplifier with built-in decoder

With this player, you can enjoy powerful Dolby Digital, DTS or MPEG sound. Output the digital signals from the player's digital output to a decoder or amplifier with built-in decoder.

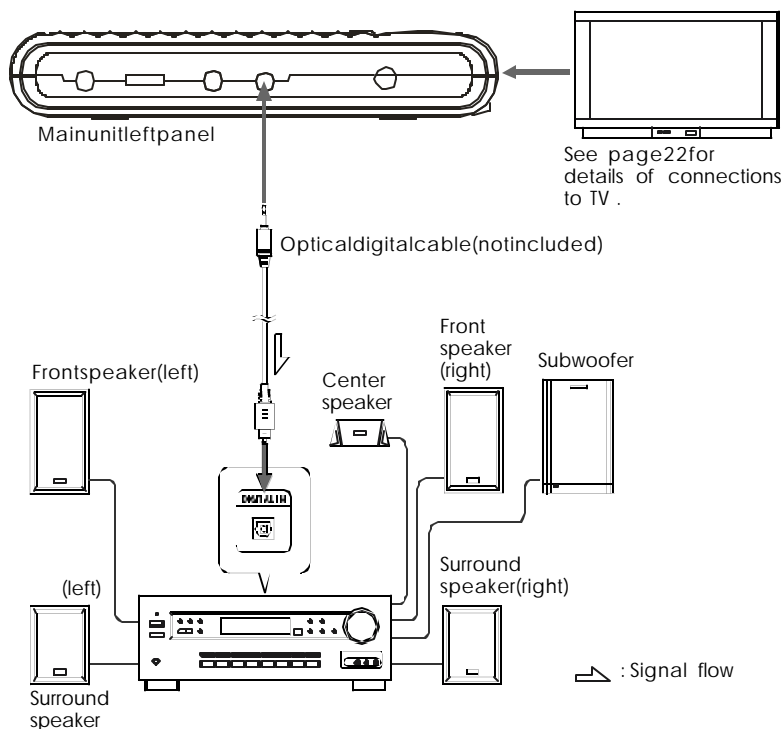

**Hint:**

For a compatible decoder or amplifier, 5 speakers (front left/right, center and surround left/right) and a subwoofer are required to enjoy Dolby Digital /DTS 5.1-channel sound.

## Connecting the Player to Other Devices

### Connecting to a digital amplifier that is not Dolby Digital / DTS / MPEG compatible

Output the digital signals from the player's digital output to a digital amplifier that is not Doby/DTS/MPEG compatible.

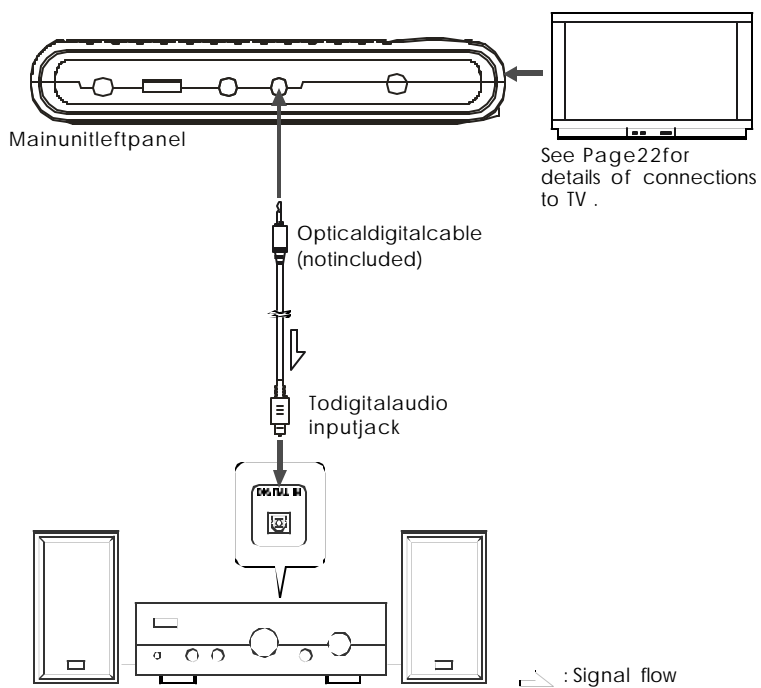

#### Notes:

- Carefully check the player's digital output settings before connecting the player to an amplifier equipped with a digital audio input jack which is not Dolby Digital/DTS/MPEG compatible.

Do not play DVDs when the audio settings are not correct. Or may cause strong noise and damage your speakers.

## Connecting the Player to Other Devices

### Connecting to active speaker systems

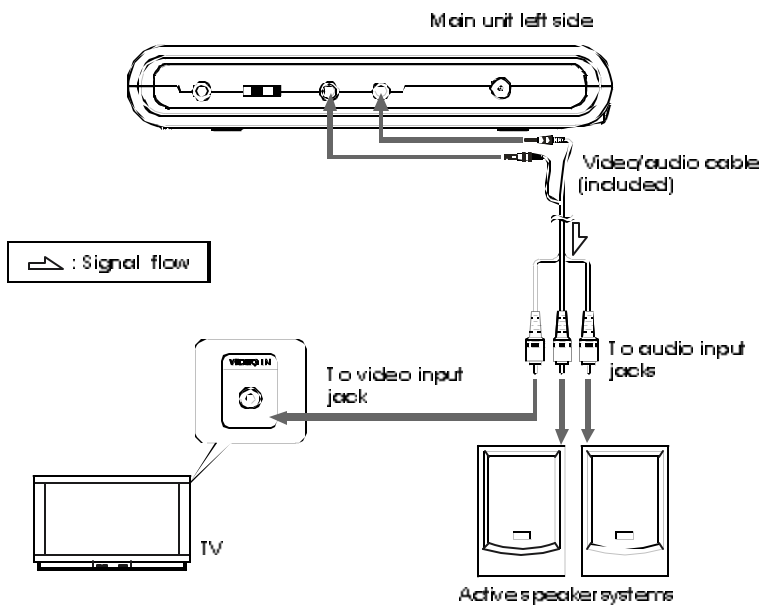

## Connecting the Player to Other Devices

---

### Connecting earphone

Connect the earphone's plug securely to the PHONE JACK on the player. To listen to music through the earphone, first use the VOLUME CONTROL on the left side of the main unit to lower the volume to minimum level, then adjust the volume to a comfortable level. Be careful not to set the volume to too high level when using earphone.

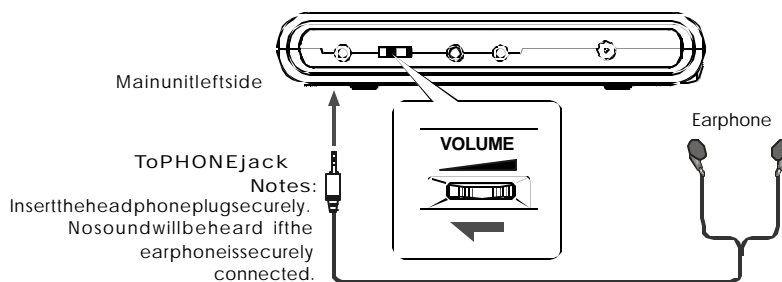

#### Note:

It is not possible to hear the sound of DTS-compatible DVD's over earphone. Strong noise is produced when DTS discs are replayed, so do not listen to such discs through earphone.

## Using the Battery

### Recharging the battery pack

Recharging the battery pack as described below.

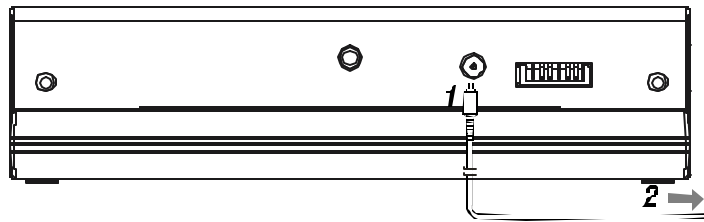

**1** Connect the output plug of AC/DC adapter to the battery pack.

**2** Connect the AC/DC adapter to the power outlet.

- When recharging starts, the recharge LED lights in red.
- The recharge LED turns off when recharging completes. Remove the power cord from battery pack.
- Recharging usually completes in about 3.5~4.5 hours.

Charge the battery pack fully before using it for the first time.

#### CAUTION

- Place the battery pack and AC/DC adapter on a flat surface for recharging.
- Do not short-circuit the terminals of the battery pack and AC/DC adapter.

#### Notes:

- The battery charger (AC/DC adapter) is compatible with supply voltage between 100 and 240 VAC and can be used universally.
- When you want to use it on an overseas travel, be sure to prepare a power plug adapter matching the local power outlet.

## Using the Battery

### Notes for recharging

- When the battery pack is hot, it may take a long time than usual for recharging or may sometimes be unusable to be recharged. Wait for the battery pack to cool down before retrying recharging.
- If the recharge LED cannot be lit, check whether the AC adapter and battery pack are connected firmly to have perfect contact.
- To protect the battery pack, do not recharge a fully charged battery pack repeatedly. Repeated overcharging may deteriorate the battery performance.
- The battery pack becomes hot after recharging, but this is not malfunction.
- The battery pack may not be recharged fully if recharging at a hot place. Do not recharge it under a very hot environment, it may cause explosion.
- The surrounding temperature during recharging affects the recharge efficiency. Recharge is the most efficient between 10 and 30 . Recharging the battery pack at a place within this temperature range whenever possible.

### Attaching the battery pack to the player



Attach the battery pack to the player as described below.

- 1** Attach the battery pack to the unit.
- 2** Align the guide hole of the player with the guide rod on the battery pack. Turning the battery knob clockwise until the battery pack is tight with the player.
- 3** Now the player can be operated.

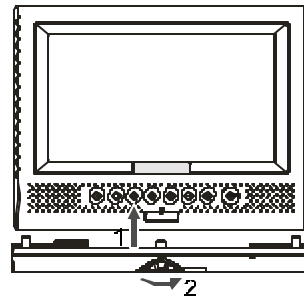
- If the battery pack is fully recharged, the player can play DVDs continuously for over 3 hours.



## Using the Battery

- If the power is switched on while the battery pack is not fully charged, the player operation may sometimes become unstable. Be sure to charge the battery pack fully before using.
- The battery pack is being recharged slowly while the player is playing with AC adapter connected.
- The battery pack is being recharged as recharged separately while the player is at STANDBY mode with AC adapter connected.
- After connecting the battery pack and power on, press OSD button on remote control at PLAY PAUSE or STOP status to show symbol "  ". This symbol indicates capability of the battery pack.
- While the battery pack has lower capacity, "  " will be flashed to remind you.

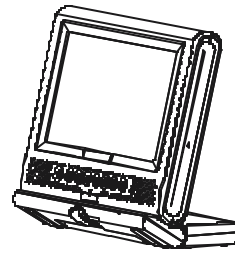

### AC power operation

- 1** Connect the DC output plug of the AC adapter to the DC IN jack on the player.
- 2** Connect the AC adapter to a power outlet. Now the player can be operated.

#### CAUTION:

Be sure to use the AC adapter provided with the player.  
Before inserting or removing the DC output plug of the AC adapter, always be sure to turn off the power of the portable DVD player.

### Removing the battery pack from the player

The battery pack can be removed from the player as described below.

- 1** Turn off the power of the player.
- 2** Turning the battery knob anti-clockwise to remove battery pack.

## Turning On the Power

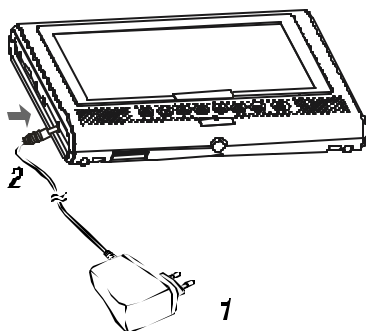

**1** Connect the AC adapter to a power outlet.

**2** Connect the DC output plug of the adapter to the DC input jack on the main unit.

**3** Keep pressing the ON button on the main unit for about 1.5 seconds.

■ The power LED is lit blue.  
The player can be used now.

■ At standby mode (when the power LED is lit red), the power can also be turned on by pressing the standby button on the remote control unit.

Main unit (front panel)

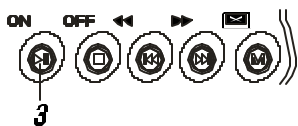

Remote control unit

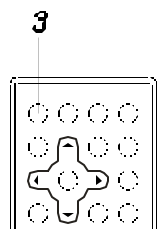

### Hint:

The included AC adapter is compatible with voltage from 100 to 240V, you can use it on trips overseas.

Note that you need a converter plug (available in stores) suited for the region in which you are travelling.



## Playback Functions

---

### Loading

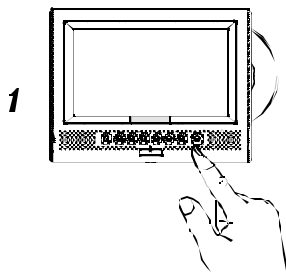

**1** Press OPEN button to open. The disc will go out as figure 1 shows. If no disc then nothing happens.

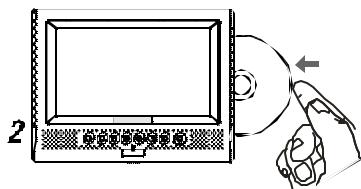

**2** Push the disc into disc window and the disc will be slotted in automatically.

#### Notes:

- Set the disc securely. Failure to set it securely could result in damage.
- Do not use cracked or warped discs. Doing so could result in damage.
- Push single-sided DVDs or CDs in with the label (printed) side facing upwards. For double-sided DVDs, check each side carefully, then push the disc in securely.
- For CDs or one-sided DVDs, you do not have to worry about touching the label (printed) side of the disc with your fingers. Since two-sided DVDs, however, have signals recorded on both sides, so be careful not to scratch them when removing them from the player.

**3** The player starts loading.

## Playback Functions

### Playing

#### 1 Load the disc.

- One of the following messages appears on the screen:  
DVD, VCD, CD.
- For some discs, playback starts automatically when the disc is slotted in.
- For the disc which had been programmed and stored in memories, playback starts automatically in the programmed order.

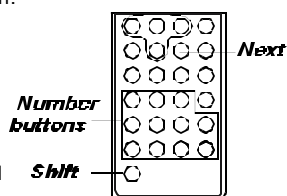

#### 2 Press the play/pause button.

- Playback starts.
- For some discs, a menu screen appears. For video CDs, they are played according to the instructions on the disc's menu screen which is called PBC (playback control).

#### Hint:

- For video CDs, it is also possible to play a disc without displaying the menu screen. For example, press 1 (number button) while at STOP mode to play track 1.
- For CDs, in order to save power, the screen display will be closed automatically if no button is pressed for 1 minute during playing. Press any button to wake it up.

### If a menu screen appears

For DVDs with menu screen or video CDs with playback control (PBC), a menu screen appears.

#### DVD

Use the cursor buttons (▲/▼/◀/▶) to select the item, then press the ENTER button.

In order to use the number buttons on the remote control unit to select the item, first press the SHIFT button until NUMBER is displayed on screen, then press number button to select the item.

## Playback Functions

---

### VideoCD

Select by pressing the **number buttons** after pressing the **SHIFT** button to switch to display NUMBER on screen.

### To display the menu screen

The way in which the menu screen is displayed differs from disc to disc. Press the MENU, TITLE button during playback of DVDs, the RETURN button during PBC playback of video CDs. For details, refer to the documentation included with the disc.

### Stopping playback

Press the STOP button. Playback will be stopped.

Resume function (DVDs and Video CDs, except VCD2.0 with PBC function):

After the STOP button is pressed, if the play button is pressed, playback will start from the position at which it was stopped. If the disc is removed or the STOP button is pressed again, the resume function is cancelled.

### Note:

- For some discs, playback may not start from the position at which it was stopped.

### Pausing playback

Press the play/pause button to pause playback.

Press this button again to resume playback.

## Playback Functions

---

### Returning to the previous chapter or track(DVDs, video CDs and CDs)

Pressthepreviousbuttonduringplayback.  
Afterpressingthepreviousbutton,playbackreturnstothebeginningoftheprevious  
chapterortrack.

### Moving to the next chapter or track(DVDs, video CDs and CDs)

Pressthenextbuttonduringplayback.  
Afterpressingthenextbutton, playbackmovesforwardtothebeginningofthenext  
chapterortrack.

### Removingthedisc

- 1 PresstheSTOPbutton.
- 2 Press ▲ topoutthedisc.
- 3 Removethedisc.

#### Note:

ForCDsorone-sidedDVDs,youdonothavetoworryabouttouchingthelabel(printed  
sideofthediscwithyourfingers.Two-sidedDVDs,however,havesignalsrecordedon  
bothsides,sobecarefulnottocratchthemwhenremovingthemfromtheplayer.

## Turning Off the Power

---

- 1 When the power is on, press OFF and hold it for about 1.5S.  
The power LED becomes red and the standby mode is set.  
The power can also be turned off by pressing the STANDBY button on the remote control unit.
- 2 Unplug the power cord from the power outlet.
- 3 Disconnect the AC adapter from the player's DC input jack.

### CAUTION:

When connecting the player to an external TV monitor, please make sure that (for better audio and visual performance) you switch/adjust the "TV system" (Marked ) to the corresponding one.

Example: Change from NTSC (default setting) to PAL as the below SETUP MENU shows:

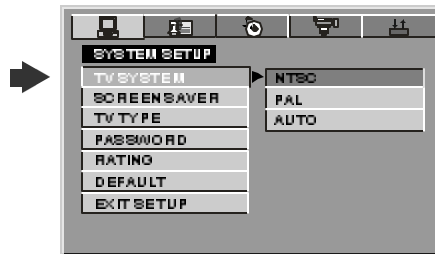

### Note:

Please turn the player to the correct TV system before changing from AV OUTPUT to AV INPUT or you can only see the black and white picture.

## Advanced Functions

### Searching for a specific scene

- 1 Press the SEARCH button.
- 2 Press the number button to input specific time or title/chapter.
- 3 Press the PLAY button or ENTER button. Playback starts from the specified position.

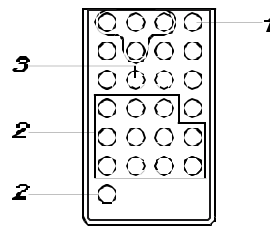

### Viewing in slow motion (DVDs and video CDs)

Press the SLOW button during playback, the playback speed changes to 1/2, 1/3, 1/4 or 1/5, 1/6, 1/7 of the normal speed.

### Repeating DVDs, video CDs and CDs

Repeat a Title, Chapter, or Track

Press the REPEAT button.

Select the title, chapter, or track you want to repeat.

Repeat a section between point A and B.

During playback, press A-B button on the remote control unit at the starting point of the section you want to repeat. (point A)

Press A-B button again at the ending point of the section you want to repeat. (Point B)

The repeating starts.

Press A-B button again to cancel the A-B repeat function.

### Selecting angle (multi-angle)

Press the ANGLE button while playing a scene with multiple angles.

If your DVD disc is not recorded with multiple angles, press ANGLE button will not have function.

## Advanced Functions

---

### Changing from AVOUT to AVIN

You can change the player from AVOUT (output AV signal to TV, etc) to AVIN (input AV signal from other device) and use it as a TFT Monitor. Default setting is AVOUT.

1 Press MODE button on main unit and switch LCD mode to AVIN/OUT.

2 Press + or - button to switch between AVOUT and AVIN.

#### Note:

Avoid to input AV signals from AV JACK when the player is set to AVOUT, or interference will be caused to affect current playback and lower down playing quality.

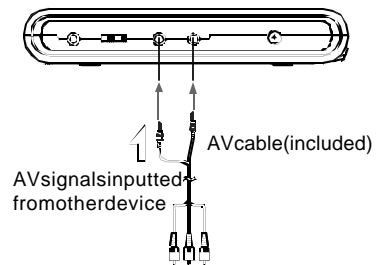

## Setup ThePlayer

### GENERAL STEPS OF SETUP

1 Press the SETUP button on the remote control, the main setup menu appears.



2 Press the LEFT and RIGHT buttons to highlight the icon of the desired page, then press the DOWN or UP button to activate that page.



3 Press the DOWN button to highlight the desired option. Press ENTER or press Right to select, the choices of that option appear.



4 Press LEFT/RIGHT/UP/DOWN buttons to highlight the EXIT SETUP option, then press ENTER or SETUP again to exit SETUP MENU.

#### NOTE:

The pressing of the following buttons will turn off the setup menu, and the choices that have been changed will be saved: Subtitle, Title, Return, Stop, Play/Pause, Step, Next, Prev, Zoom, Program, Repeat, Angle, Mute.



## System Setup

The system setup options are illustrated below :

### TV SYSTEM

If you want to connect the player to a TV, please choose a correct TV system first.

- AUTO: Choose this setting if your DVD player is connected to a multi-system TV.
- NTSC: Choose this setting if your DVD player is connected to a NTSC TV.
- PAL: Choose this setting if your DVD player is connected to a PAL TV.
- The default setting is NTSC.



### NOTE:

Setting with incorrect TV system will result in black and white picture on your TV screen.

### SCREENSAVER

If the screensaver is on, when your DVD player is at STOP or NODISC status, or there is a frame frozen for a little long time, the screensaver will be displayed. This feature can protect the screen from damage.

- ON: Choose this setting to activate the screensaver.
- OFF: Choose this setting to cancel the screensaver.
- The default setting is ON.

## System Setup

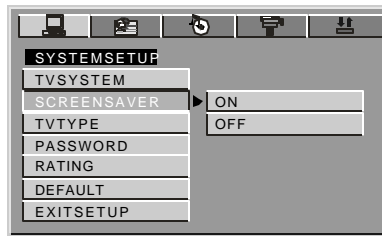

### TVTYPE

16:9 (WideScreen): Choose this setting if your DVD player is connected to a widescreen TV. If you choose this setting and you don't have a widescreen TV, the images on the screen may appear distorted due to vertical compression.

4:3LB (LetterBox): Choosing this setting if your DVD player is connected to a normal ratio TV. You'll see the movie in their original aspect ratio (height-to-width ratio). You'll see the entire frame of the movie. The movie might appear with black bars at the top and bottom of the screen.

4:3PS (Pan & Scan): Choosing this setting if your DVD player is connected to a normal ratio TV. You can fill the movie to the entire screen of your TV. This might mean that parts of the picture (the left and right edges) won't be seen.



### NOTES:

- The image display ratio is related to the recorded disc format. Some discs cannot be displayed in the aspect ratio chosen.
- If you play a disc recorded in 4:3 format on a widescreen TV, black bars will appear on the left and right side of the screen.
- You must adjust the screen setting depending on the type of the TV.

## System Setup

### PASSWORD

- 1 The player is locked with a default password 0000 and you cannot change the rating. In order to change the rating, choose the password option and input the correct password to unlock the player.
- 2 After the player is unlocked, you can choose the rating option and change it, then you can choose the password option and change to a new password with 4-digit numbers and press OK button to lock it again.

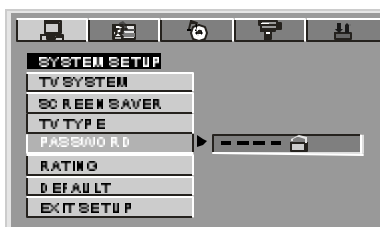

### RATING

The Rating feature works with DVD discs that have been assigned a rating. This helps you to control the types of DVD that the player can be watched.

- There are eight limited rating options:  
KIDSAFE, G, PG, PG13, PGR, R, NC17, ADULT.
- The default setting is ADULT.

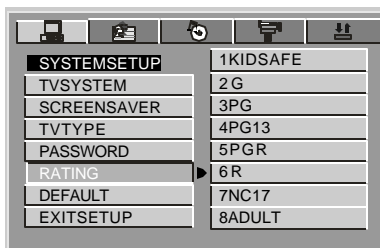

### NOTE:

If the password option is locked, you cannot change rating.

### DEFAULT

Choose this option to resume factory settings.

## Language Setup

The language setup options are illustrated below:

### OSD LANGUAGE

Highlight OSD LANGUAGE option, and press LEFT/RIGHT/UP/DOWN to choose the OSD language you prefer. Press ENTER to confirm, then the OSD will be displayed in that language. There are 5 optional OSD languages: English, German, Spanish, French and Italian.



### AUDIOLANGUAGE

Highlight the AUDIO LANG option, and press LEFT/RIGHT/UP/DOWN to choose audio language you prefer. Press ENTER button to confirm. If the disc you are replaying has that language available, it will output audio in that language. There are 8 optional audio languages: Chinese, English, Japanese, French, Spanish, Portuguese, Latin and German.



## Language Setup

### SUBTITLE LANGUAGE

Highlight the SUBTITLE LANG option, and press LEFT/RIGHT/UP/DOWN to choose subtitle language you prefer. Press ENTER to confirm. If the disc you are replaying has that language available, it will display subtitles in that language. There are 7 optional subtitle languages: Chinese, English, Japanese, French, Spanish, Portuguese and German.



### MENULANGUAGE

Highlight the MENULANG option, and press LEFT/RIGHT/UP/DOWN to choose menu language you prefer. Press ENTER to confirm. If the disc you are replaying has that language available, it will display menu in that language. There are 8 optional menu languages: Chinese, English, Japanese, French, Spanish, Portuguese, German and Latin.



#### NOTE:

If your preferred language isn't available, the disc's default language will be played. The default language of your DVD player is English.

## AudioSetup

---

### AUDIOOUT

Highlight the AUDIOOUT option, and press LEFT/RIGHT/UP/DOWN to choose audio output mode you prefer. Press ENTER to confirm: There are 3 optional audio output modes: SPDIF/OFF, SPDIF/RAW and SPDIF/PCM.

- SPDIF/OFF: Choose this setting to output analog signal, and no signal is outputted from optical jack.
- SPDIF/RAW: Choose this setting if your DVD player is connected to a power amplifier with an optical cable. When playing a disc recorded with Dolby Digital, DTS and MPEG audio formats, the corresponding digital signals will be outputted from the Optical Output jack.
- SPDIF/PCM: Choose this setting if your DVD player is connected to a 2-channel digital stereo amplifier. When playing a disc recorded with Dolby Digital and MPEG audio formats, audio signals will be modulated into a 2-channel PCM signal, and it will be outputted from the Optical Output jack.

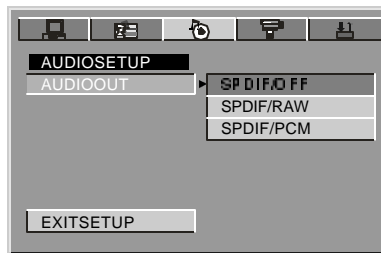

## VideoSetup

---

The videosetup options are illustrated below:

### BRIGHTNESS

Use the UP and DOWN buttons to move the scroll and adjust the brightness.

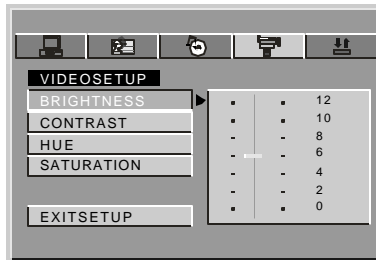

### CONTRAST

Use the UP and DOWN buttons to move the scroll and adjust the contrast.

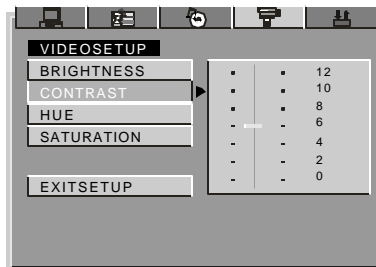

## VideoSetup

---

### HUE

Use the UP and DOWN buttons to move the scroll and adjust the hue.

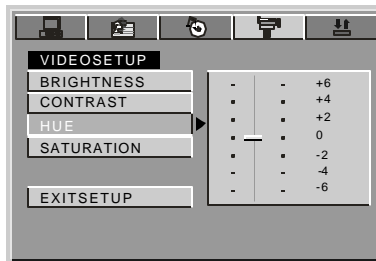

### SATURATION

Use the UP and DOWN buttons to move the scroll and adjust the saturation.

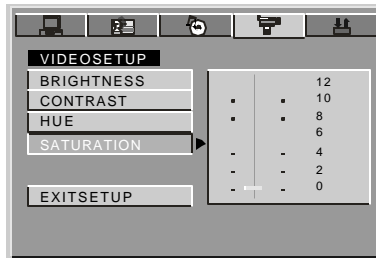



## Digital Setup

---

The digital setup options are illustrated below:

### DIGITAL SETUP

**DYNAMIC RANGE:** Choose this setting to adjust the line out compressing ratio and get different effect. If adjusting to FULL, the audio signal peak value will be compressed minimum, while adjusting to OFF, maximum.

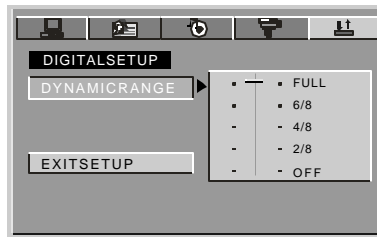

## Caution on Using

### Handling discs

#### Handling

When holding  
with both hands



When holding  
with one hand



- Donot use damaged (cracked or warped) discs.
- Donot scratch the signal surface or let it get dirty.
- Donot attach paper or seal to discs.
- The player may be damaged if there is any exposed glue, etc., on discs. For rental discs in particular, extra labels are often attached to the discs. Check carefully for any exposed glue before using such discs.

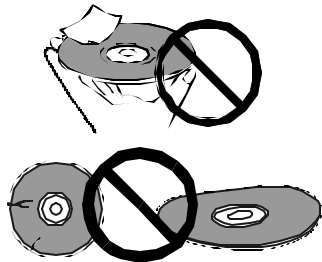

#### Storing discs

- Always place discs in their case and store them vertically. Avoid storing discs in hot or humid places, places exposed to direct sunlight and places in which the temperature is extremely low.
- Read any cautions included with the disc carefully.

#### Cleaning discs

- Fingerprints or dust on discs may reduce sound or picture quality. Remove them by gently wiping the disc from the center toward the edges using a soft cloth.

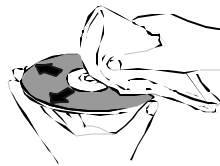

- Donot use benzene, thinner or other volatile chemicals. Donot use records spray or antistatic spray either.
- We recommend using these separately sold cleaning sets to clean discs.
- For tough dirt, apply some water to a soft cloth, wring out thoroughly, wipe off the dirt, then wipe the disc with a dry cloth.

#### Irregular shaped discs

Irregular shaped discs (heart-shaped discs, hexagonal discs, etc.) cannot be played on this player. Doing so could damage the player. Never use such discs.

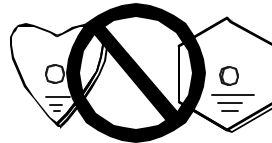

## Trouble shooting

**Picture is distorted when playing a DVD recorded by a VCR.**

- ➔ This player incorporates copyright protection technology. Some discs include signals protected against copied by a VCR. Such recorded discs can not be played properly.

**Player cannot be operated with the remote control unit**

- ➔ Remote control unit is too far from the main unit or has too large angle with the remote sensor.
- ➔ Remote control unit's battery is worn out.

**TV or other device operates erroneously**

- ➔ The player's remote control unit may cause some TV's with wireless remote control to operate erroneously.

**No sound is produced from speakers or sound is distorted**

- ➔ For some discs, 96kHz digital output of linear PCM audio signals is prohibited.
- ➔ Disc is dirty.
- ➔ Pause or slow play mode is set.
- ➔ Main unit's volume is set to minimum.
- ➔ Earphone is plugged in.

**Volume is different for DVDs and CDs**

- ➔ This is due to the different recording methods.

**The player restarts**

- ➔ Turn off power of the player and turn on again.
- ➔ Press OPEN button when Loading... appears on screen to pop out the disc.
- ➔ Ask qualified technician.

**8cm disc cannot be popped out**

- ➔ Slap on the player with disc window downward.
- ➔ Ask qualified technician.

**No sound is produced or sound is distorted when connected to a TV, amplifier, etc.**

- ➔ Connection cables are not firmly plugged in or not contacted well.
- ➔ Connection plugs or jacks are dirty.
- ➔ Audio cables are not properly connected.
- ➔ Audio digital output is connected to a non-compatible AV amplifier, etc.
- ➔ Have wrong DTS setting.

**Bad playback quality**

- ➔ The player is set to AV OUT but there are other AV signals inputted from AV jack.

**Player get shot**

- ➔ This is normal.

### Notes:

The player may stop operation properly due to static electricity or other external influences. In this case, usually solve the problem by unplugging the power cord and then plugging it in again. If still cannot solve it, consult with the nearest service center.

### Liquid crystal display

A few picture elements may be black or a particular color is displayed on the LCD screen. This is normal.

**•S DV373 Q.ENG. NB.B0.**

## Free Manuals Download Website

<http://myh66.com>

<http://usermanuals.us>

<http://www.somanuals.com>

<http://www.4manuals.cc>

<http://www.manual-lib.com>

<http://www.404manual.com>

<http://www.luxmanual.com>

<http://aubethermostatmanual.com>

Golf course search by state

<http://golfingnear.com>

Email search by domain

<http://emailbydomain.com>

Auto manuals search

<http://auto.somanuals.com>

TV manuals search

<http://tv.somanuals.com>