

[WWW.N2.COM.HK](http://WWW.N2.COM.HK)



1. Read these instructions.
2. Keep these instructions.
3. Heed all warnings.
4. Follow all instructions.
5. Do not use this apparatus near water.
6. Clean only with dry cloth.
7. Do not block any ventilation openings. Install in accordance with the manufacturer's instructions.
8. Do not install near any heat sources such as radiators, heat registers, stoves, or other apparatus (including amplifiers) that produce heat.
9. Do not defeat the safety purpose of the polarized or grounding-type plug. A polarized plug has two blades with one wider than the other. A grounding type plug has two blades and a third grounding prong. The wide blade or the third prong are provided for your safety. If the provided plug does not fit into your outlet, consult an electrician for replacement of the obsolete outlet.
10. Protect the power cord from being walked on or pinched particularly at plugs, convenience receptacles, and the point where they exit from the apparatus.
11. Only use attachments/accessories specified by the manufacturer.
12. Use only with the cart, stand, tripod, bracket, or table specified by the manufacturer, or sold with the apparatus. When a cart is used, use caution when moving the cart/apparatus combination to avoid injury from tip-over.



13. Unplug this apparatus during lightning storms or when unused for long periods of time.
14. Refer all servicing to qualified service personnel. Servicing is required when the apparatus has been damaged in any way, such as power-supply cord or plug is damaged, liquid has been spilled or objects have fallen into the apparatus, the apparatus has been exposed to rain or moisture, does not operate normally, or has been dropped.
15. To reduce the risk of fire or electric shock, do not expose this appliance to rain or moisture.
16. The shock hazard marking and the associated graphical symbol is provided on the bottom panel of the unit.
17. Apparatus shall not be exposed to dripping or splashing and no objects filled with liquids, shall be placed on the apparatus.



Thank you for purchasing this tablet DVD player. Please read this manual carefully before operating and reserve it for future reference. It will be helpful to you if you encounter any operational problem.

**WARNING:** TO REDUCE THE RISK OF FIRE OR ELECTRIC SHOCK, DO NOT EXPOSE THIS APPLIANCE TO RAIN OR MOISTURE, DRIPPING OR SPLASHING AND THAT NO OBJECTS FILLED WITH LIQUIDS, SUCH AS VASES, SHALL BE PLACED ON THE APPARATUS. DANGEROUS HIGH VOLTAGES ARE PRESENT INSIDE THE ENCLOSURE. DO NOT OPEN THE CABINET. REFER SERVICING TO QUALIFIED PERSONNEL ONLY.

**ATTENTION:** TO PREVENT ELECTRIC SHOCK, MATCH WIDE BLADE OF PLUG TO WIDE SLOT, FULLY INSERT.

**LASER:** This Digital Video Disc player employs a Laser System. To ensure proper use of this product, please read this owner's manual carefully and retain it for future reference. Should the unit require maintenance, contact an authorized service location - see service procedure.

Use of controls, adjustments or the performance of procedures other than those specified may result in hazardous radiation exposure.

To prevent direct exposure to laser beam, do not try to open the enclosure.

Visible and invisible laser radiation when open and interlocks defeated.

DO NOT STARE INTO BEAM

#### LASER

Type	Semiconductor laser GaAlAs
Wave length	650 nm/780nm
Output Power	5mW
Beam divergence	60degree

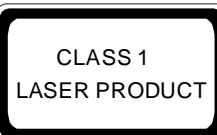



**CAUTION:**

These servicing instructions are for use by qualified service personnel only. To reduce the risk of electric shock, do not perform any servicing other than that contained in the operating instructions unless you are qualified to do so.

**WARNING:**

To reduce the risk of fire or electric shock, do not expose this appliance to rain or moisture.

**CAUTION:**

Use of controls or adjustments or performance of procedures other than those specified may result in hazardous radiation exposure.

**CAUTION**

**RISK OF ELECTRIC SHOCK. DO NOT OPEN**

To reduce the risk of electric shock, do not remove cover (Or back). No user serviceable parts inside. Refer servicing to qualified service personnel.



SA 1965

**DANGEROUS VOLTAGE**

The lightning flash with the arrowhead symbol, within an equilateral triangle, is intended to alert the user to the presence of uninsulated "dangerous voltage" within the product enclosure that may be of sufficient magnitude to constitute a risk of electric shock to persons.



SA 1966

**INSTRUCTION**

The exclamation point within an equilateral triangle is intended to alert the user to the presence of important operating and maintenance (Servicing) instruction in the literature accompanying the appliance.



**CAUTION:**

**INVISIBLE LASER RADIATION WHEN OPEN AND INTERLOCK FAILED OR DEFEATED. AVOID DIRECT EXPOSURE TO LASER BEAM.**

DVD



**MACROVISION:** This product incorporates copyright protection technology that is protected by U.S. patents and other intellectual property rights. Use of this copyright protection technology must be authorized by Macrovision. If not, the use of this technology is only permitted for domestic use and other limited playback uses. Reverse engineering or disassembly is prohibited.

**DOLBY:** Manufactured under license from Dolby Laboratories. "Dolby" and the double-D symbol are trademarks of Dolby Laboratories.

DVD

04

■ ENJOY YOUR MOVIE ANYWHERE.



**IMPORTANT SAFETY INSTRUCTIONS**

IMPORTANT SAFETY INSTRUCTIONS..... 1

**PRECAUTIONS**

PRECAUTIONS.....2

**TABLE OF CONTENTS**

TABLE OF CONTENTS.....5

**CAUTIONS ON USING THIS PLAYER**

CAUTIONS ON USING THIS PLAYER.....7

**DISCS PLAYABLE**

TYPES OF DISCS PLAYABLE ON THIS PLAYER..... 9  
PLAYABLE FORMATS.....9

**PACKAGE CONTENTS**

PACKAGE CONTENTS.....10

**PARTS AND CONTROLS**

FRONT SIDE.....11  
RIGHT SIDE.....11  
BUTTON DEFINITION.....12  
MAIN UNIT REAR SIDE.....13  
HOW TO STAND.....13  
REMOTE CONTROL.....14  
KEY DESCRIPTION OF REMOTE CONTROL.....15  
NOTES ON USING THE REMOTE CONTROL UNIT.....16  
REPLACING THE BATTERY.....16  
FITTING HEADREST MOUNT.....17  
FITTING TABLET DVD PLAYER TO HEADREST MOUNT.....17

**AUDIO/VIDEO CONNECTIONS**

CONNECTING THE PLAYER TO A TV SET.....18  
CONNECTING THE ADAPTER TO THE DC IN 12V SOCKET.....19  
USING THE EARPHONE.....19

**CONNECTING THE PLAYER TO OTHER DEVICES**

CONNECTING TO A DOBLY DIGITAL/MPEG DECODER OR AN AMPLIFIER WITH BUILT-IN DECODER.....20  
CONNECTING TO A DIGITAL AMPLIFIER THAT IS NOT DOBLY DIGITAL/MPEG COMPATIBLE.....21  
CONNECTING TO ACTIVE SPEAKER SYSTEMS.....22

**BASIC OPERATIONS**

TURNING ON THE POWER.....23  
TURNING OFF THE POWER.....23  
LOADING.....24  
REPLACE 6 PCS AA BATTERIES.....25  
PLAYBACK.....26  
STOP PLAYBACK.....26  
PAUSE PLAYBACK.....26  
PLAYING AT FAST SPEED.....27  
PLAYBACK IN SLOW MOTION.....27  
A-B/REPEAT PLAYBACK.....27  
ZOOM FUNCTION.....28  
SEARCHING FOR A SPECIFIC SCENE.....28  
SELECTING SUBTITLE.....28  
CHANGING THE ANGLE.....28  
CHANGING THE AUDIO LANGUAGE.....28  
PROGRAM PLAYBACK.....29  
USING THE ON-SCREEN DISPLAY.....30



PLAYING A MP3 FORMAT DISC AND JPEG CD.....	30
USING THE USB PORT.....	31

### SETUP THE PLAYER

GENERAL STEPS OF SETUP.....	32
-----------------------------	----

### SYSTEM SETUP

TV SYSTEM.....	33
SCREEN SAVER.....	33
TV TYPE.....	34
PASSWORD.....	35
RATING.....	35
DEFAULT.....	35

### LANGUAGE SETUP

OSD LANGUAGE.....	36
AUDIO LANGUAGE.....	36
SUBTITLE LANGUAGE.....	37
MENU LANGUAGE.....	37

### AUDIO SETUP

AUDIO SETUP.....	38
------------------	----

### VIDEO SETUP

BRIGHTNESS.....	39
CONTRAST.....	39
HUE.....	40
SATURATION.....	40

### DIGITAL SETUP

OP MODE.....	41
DYNAMIC RANGE.....	41

### OTHERS

SIZE AND PARAMETER.....	42
TROUBLE SHOOTING.....	43

**CAUTIONS ON USING THIS PLAYER****1. DO NOT MOVE THE PLAYER DURING PLAYBACK**

During playback, the disc spins at high speed. So do not lift or move the player.  
Doing so may damage the disc.

**2. TRANSPORTING THE PLAYER**

Before transporting the player, be sure to remove the disc and turn off the power,  
then unplug the power cord.

**3. PLACE OF INSTALLATION**

Select a stable place near the TV or stereo system to which you are going to  
connect the player.

Do not place the player on top of a TV or color monitor.

Install the player away from cassette decks or other devices which are easily  
affected by magnetic forces.

**4. DO NOT PLACE OBJECTS ON TOP OF THE PLAYER**

Do not expose this apparatus to rain, moisture, dripping or splashing and no objects  
filled with liquids, such as vases, shall be placed on the apparatus.

**5. TURN OFF THE POWER WHEN NOT USING THE PLAYER**

If the player is connected to your TV but not in use, switch the power off.

It can avoid interference to your normal TV picture.

Noise problems may also be experienced if used near a radio.

**6. SPECIAL NOTE REGARDING USE OF PLAYER IN VEHICLES**

- We strongly advise against using the player while driving.
- Most countries and states have laws which prohibit or severely restrict the  
use of the player in vehicles while driving.
- Do not leave the player in places where the temperature is extremely low  
(About -10°C or lower) or extremely high (About 60°C or higher), such as inside  
the passenger cabin or trunk in midsummer. Doing so may warp the outer case  
or reduce the performance.





### 7. WHEN USING WITH CAR POWER CABLE IN CARS

Please turn on the engine first and connect the car power cable for using.

### 8. CLEANING THE PLAYER

Normally clean the player with a soft, dry cloth. For tough dirt, apply some neutral detergent diluted in 5 to 6 parts water to a soft cloth, wring out thoroughly. Wipe off the dirt, then wipe off the player with a dry cloth. Note that alcohol, thinner, benzene, insecticides, etc., may cause the print or coating to peel off. Also avoid leaving rubber or plastic products in contact with the player for long periods of time, as this may damage the cabinet. When using chemically treated cloths, read the cloth's instructions carefully. Always unplug the power cord from the power outlet before cleaning the player.

### 9. COPYRIGHTS

Unauthorized duplication, broadcast, public performance or rental of discs are prohibited by law.



## PACKAGE CONTENTS

After unpacking, first check the contents of your DVD player package, as listed below:

Operating manual

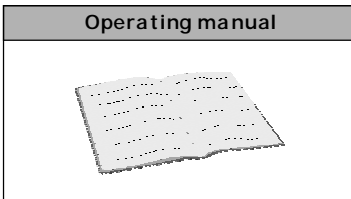

Main unit

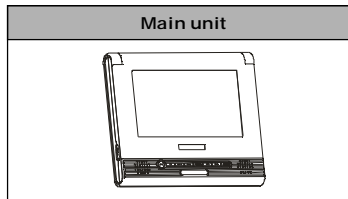

AC / DC adapter

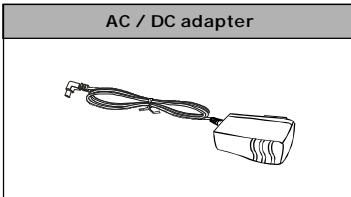

Car power cable

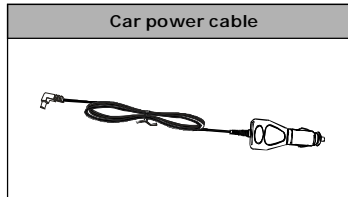

Card-type remote control unit

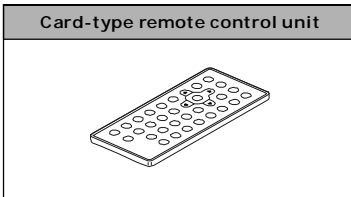

Headrest mount

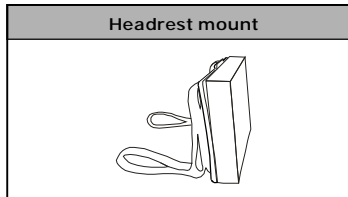

NOTES: Actual products' appearance might vary slightly from the pictures shown.

## FRONT SIDE

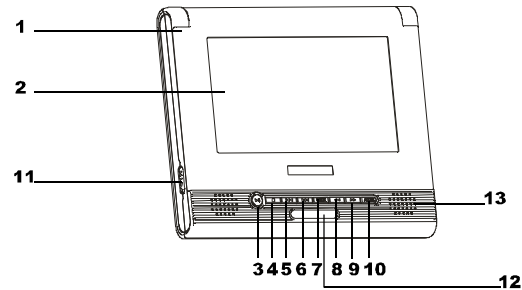

- |                          |   |
|--------------------------|---|
| 1 Disc compartment cover | 7 MODE button                               |
| 2 TFT Screen             | 8 REV button                                |
| 3 PLAY / PAUSE button    | 9 FWD button                                |
| 4 STOP button            | 10 AUDIO button                             |
| 5 PREVIOUS button        | 11 OPEN button (Push it to open the cover.) |
| 6 NEXT button            | 12 Remote control sensor                    |
|                          | 13 Loudspeaker                              |

## RIGHT SIDE

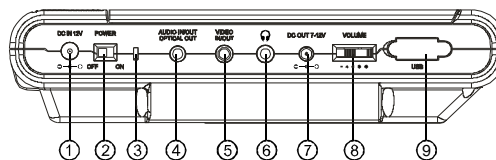

- |                                |                          |
|--------------------------------|--------------------------|
| 1 DC IN jack (DC 12V)          | 6 EARPHONE jack          |
| 2 POWER ON / OFF               | 7 DC OUT jack (DC 7~12V) |
| 3 LED indicator                | 8 VOLUME CONTROL         |
| 4 AUDIO IN / OUT / OPTICAL OUT | 9 USB port               |
| 5 VIDEO IN / OUT               |                          |



## BUTTON DEFINITION

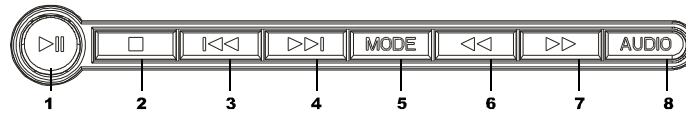

1. **PLAY / PAUSE** button  
Press it to play. When pressing during playback, pause mode is set. Press again to resume playback.
2. **STOP** button  
Press it to stop playback.
3. **PREVIOUS** button  
Press it to locate the beginning of the previous track or chapter.
4. **NEXT** button  
Press it to locate the beginning of next track or chapter.
5. **MODE** button  
Press it to enter AV IN/OUT adjustment, brightness, color, TFT mode and view mode.  
Press the button once to enter AV IN / OUT adjustment. Use ►► / ◀◀ to adjust.  
Press the button again to enter BRIGHTNESS mode. Use ►►/ ◀◀ button to adjust levels between 0 and 8.  
Press the button again to enter COLOR mode. Use ►►/ ◀◀ button to adjust levels between 0 and 8.  
Press the button again to enter TFT mode. Use ►►/ ◀◀ button to switch between 16:9 and 4:3.  
Press the button again to enter VIEW mode. Use ►►/ ◀◀ button to switch between obverse picture and reverse picture.  
Hold the button for about 1.5 seconds to turn off the TFT display and press it again to resume display.
6. **REV** button  
Press it during playback to backward the playing speed through X2, X4, X8, X20, X1.
7. **FWD** button  
Press it during playback to forward the playing speed through X2, X4, X8, X20, X1.
8. **AUDIO** button  
Press it to switch the audio language.

**MAIN UNIT REAR SIDE****Support**

The unit can stand with this device.

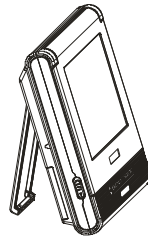
**HOW TO STAND**

1. Pull out the support.
2. Draw out the support to a proper position .

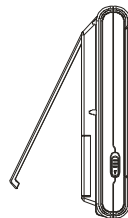

REMOTE CONTROL

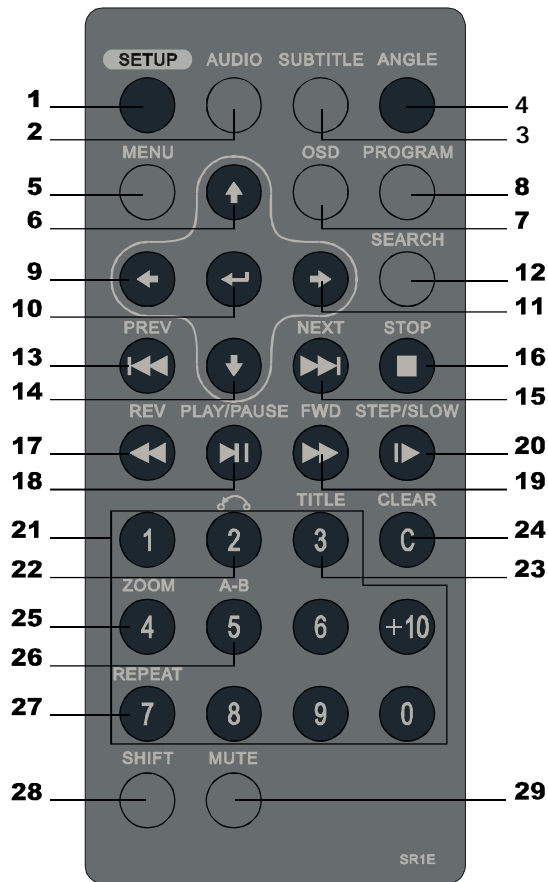

DVD



## KEY DESCRIPTION OF REMOTE CONTROL

- |   |   |
|---|---|
| <b>1 SETUP</b><br>Press this button to display setup screen when at stop status.  | <b>14 ( ↓ )</b><br>Move the cursor down.  |
| <b>2 AUDIO</b><br>Press this button to switch the audio language.   | <b>15 NEXT ( ►► )</b><br>Jump to the next track.  |
| <b>3 SUBTITLE</b><br>Press this button to switch the DVD's subtitle language.   | <b>16 STOP ( ■ )</b><br>Press this button to stop playback.   |
| <b>4 ANGLE</b><br>Press this button to switch angles.   | <b>17 REV ( ◀◀ )</b><br>Fast backward key.  |
| <b>5 MENU</b><br>Press this button to display the DVD's menu screen.<br>While playing VCD disc, press it to switch between menu on and off. | <b>18 PLAY/PAUSE ( ►   )</b><br>Press this button to play or pause playback.  |
| <b>6 ( ↑ )</b><br>Move the cursor up.   | <b>19 FWD ( ►► )</b><br>Fast forward key.   |
| <b>7 OSD</b><br>Press this button to display the disc information.  | <b>20 STEP/SLOW (  ► )</b><br>Press this button to slow playback at 1/2, 1/3, 1/4, 1/5, 1/6, 1/7 speed. If at pause status, press this button to play step-by-step. |
| <b>8 PROGRAM</b><br>Program playing order of tracks.  | <b>21 NUMBER KEYS</b><br>Input number.  |
| <b>9 ( ← )</b><br>Move the cursor left.   | <b>22 RETURN</b><br>Return back to menu screen.<br>If menu setting is off when playing VCD, the key is invalid.   |
| <b>10 ENTER ( ◀ )</b><br>Enter the selected item.   | <b>23 TITLE</b><br>Press this button to display the DVD's title.  |
| <b>11 ( → )</b><br>Move the cursor right.   | <b>24 CLEAR</b><br>Clear the numbers inputted before.   |
| <b>12 SEARCH</b><br>Locate title/chapter/ playtime to play.   | <b>25 ZOOM</b><br>Zoom the picture on the screen.   |
| <b>13 PREV ( ◀◀ )</b><br>Jump to previous track.  | <b>26 A-B REPEAT</b><br>Press this button during playback to set two points and play the section between them repeatedly.   |



**27 REPEAT**

For DVDs, use this button to play titles or chapters repeatedly. For CDs, use this button to play tracks or the entire disc repeatedly.

**28 SHIFT**

Press this button to switch between number & function. (Default: function)

**29 MUTE**

Press this button to mute the player.

**NOTES ON USING THE REMOTE CONTROL UNIT**

- Do not drop or step on the remote control unit or subject it to shocks.
- Note that the remote control unit may not work if there are obstacles between the remote sensor and itself.
- Do not expose the remote sensor to strong light. Doing so may make operation impossible.
- Use the remote control unit within the specified operating range.

**REPLACING THE BATTERY**

1. Insert your finger nails into A and B on the diagram below, press A according to the direction, then pull out the battery holder.

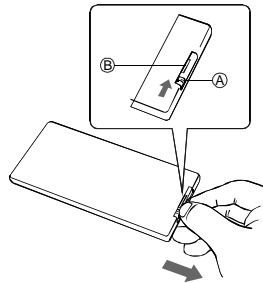

3. Fit the battery holder back to its place.

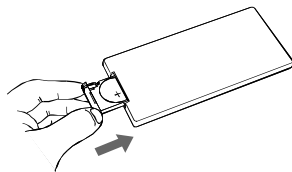

2. Remove the old battery, then insert the new battery into the battery holder with the + side facing upwards.

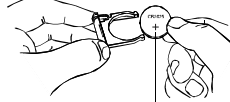

Lithium battery (CR2025)

**NOTE:**

- To prevent leakage of fluid from the lithium battery, remove the battery when not using the remote control unit for long periods of time (One month or more). If the battery leaks fluid, carefully wipe it out of the battery case, then change to a new lithium battery.
- Caution: The battery may present a risk of fire if mistreated. Do not recharge, disassemble, or heat it above 100°C.
- Replace battery with the same type. Dispose of used battery properly, keep away from children and do not dispose of in fire.

### FITTING HEADREST MOUNT

The headrest mount is designed to fit a wide variety of shapes and sizes of the headrests in modern cars. The foam pad allows you to set the angle of the screen and will eliminate vibration when the car is moving.

1. Place the two mounting straps over your headrest with the mount's sponge facing the headrest, and the release button on top.
2. Adjust to your desired viewing angle, then firmly secure the mount by tightening the straps. See diagrams below.

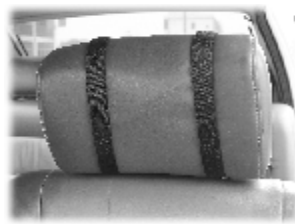

### FITTING TABLET DVD PLAYER TO HEADREST MOUNT

Gently slide the Portable DVD player down by aligning the backpanel groove with the headrest mount, until you hear the click sound. See diagram below.





## CONNECTING THE PLAYER TO A TV SET

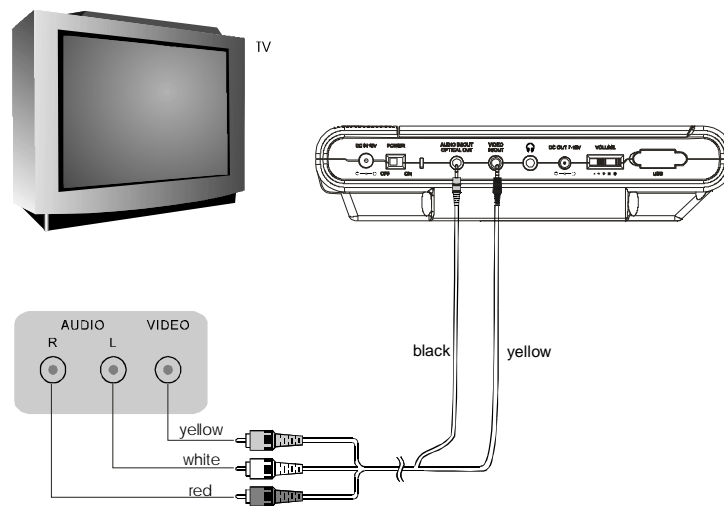

DVD

18

■ ENJOY YOUR MOVIE ANYWHERE.

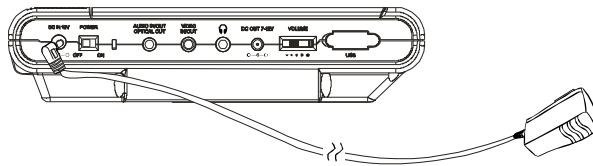
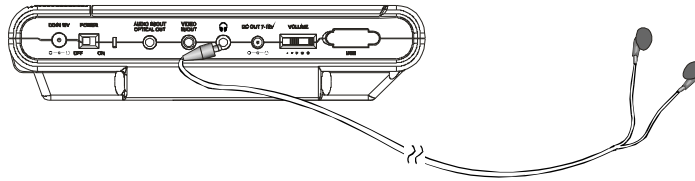
**CONNECTING THE ADAPTER TO THE DC IN 12V SOCKET****USING THE EARPHONE**

1. Set the volume control to minimum sound level.
2. Connect the earphone plug to the player's "🎧" jack.
3. Adjust the volume control to the preferred sound level.

### CONNECTING TO A DOLBY DIGITAL / MPEG DECODER OR AN AMPLIFIER WITH BUILT-IN DECODER

With this player, you can enjoy powerful Dolby Digital or MPEG sound. Output the digital signals from the player's digital output to a decoder or amplifier with the built-in decoder.

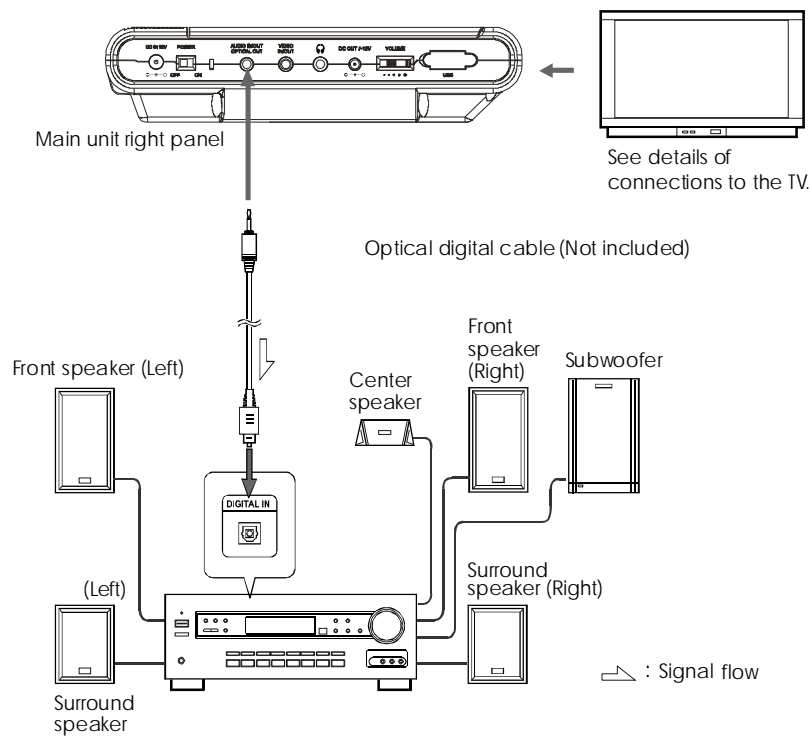

#### Hint:

For a compatible decoder or amplifier, 5 speakers (Front left/right, center and surround left/right) and a subwoofer are required to enjoy Dolby Digital.

### CONNECTING TO A DIGITAL AMPLIFIER THAT IS NOT DOLBY DIGITAL / MPEG COMPATIBLE

Output the digital signals from the player's digital output to a digital amplifier that is not Dolby/MPEG compatible. For instructions of audio settings, refer to AUDIO OUT of AUDIO SETUP.

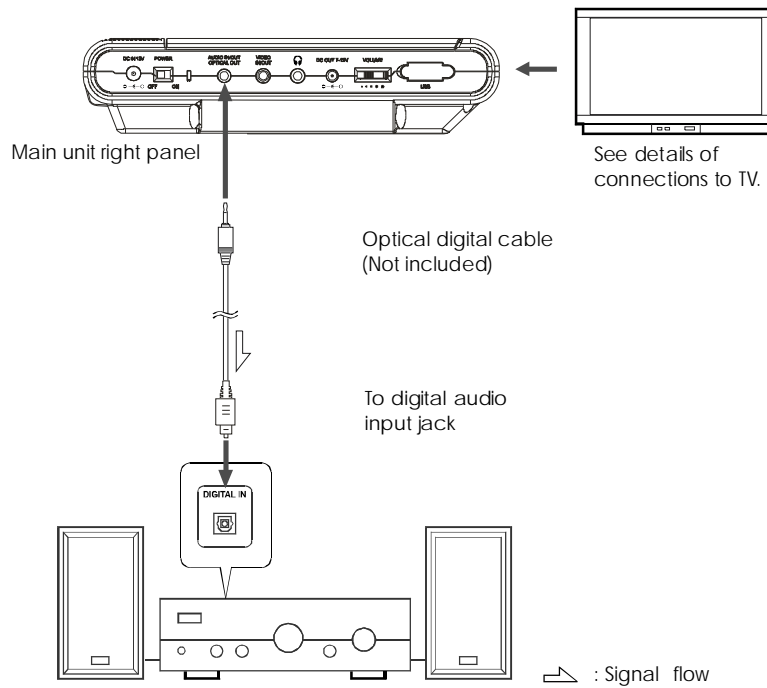

#### Notes:

- Carefully check the player's digital output settings before connecting the player to an amplifier equipped with a digital audio input jack which is not Dolby Digital / MPEG compatible.

**Do not play DVDs when the audio settings are not correct. Or it may cause strong noise and damage your speakers.**



CONNECTING TO ACTIVE SPEAKER SYSTEMS

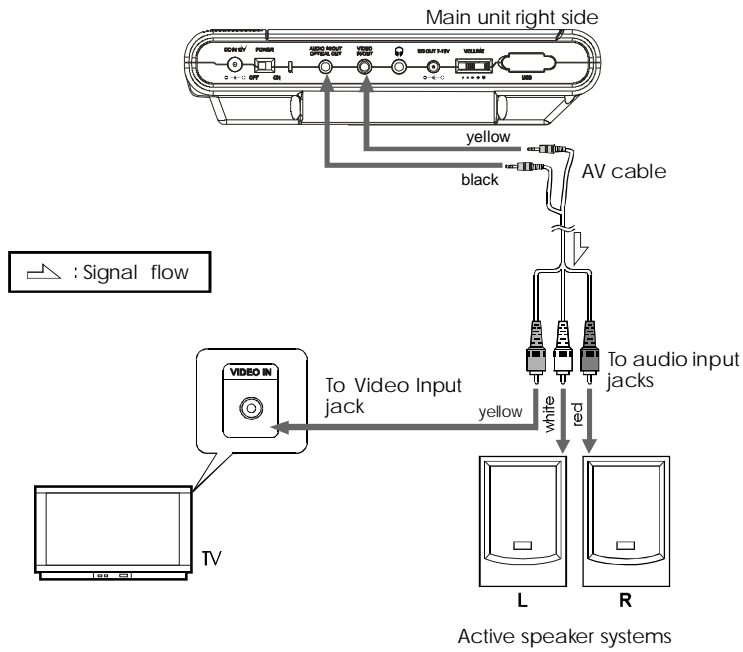

## TURNING ON THE POWER

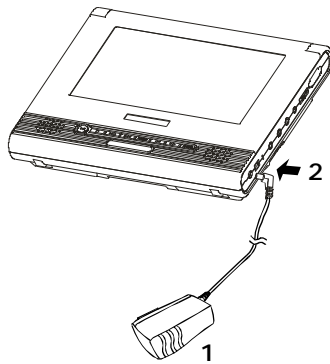

1. Connect the AC/DC adapter to the socket.

2. Connect the DC output plug of the adapter to the DC input jack on the main unit.

3. Switch the POWER button to ON position.

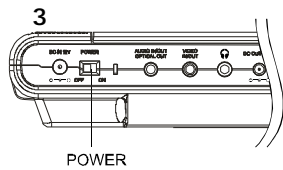

### Hint:

The included AC/DC adapter is compatible with voltage from 100 V to 240 V, you can use it on trips overseas.

Note that you need a converter plug (Available in stores) suited for the region in which you are travelling.

## TURNING OFF THE POWER

1. When the power is on, switch the power button to OFF position.
2. Unplug the power cord from the power outlet.
3. Disconnect the AC/DC adapter from the player's DC input jack.



## LOADING

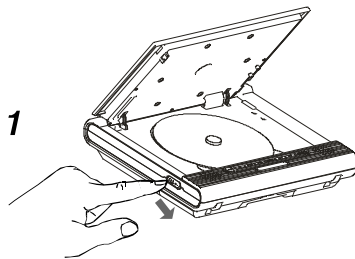

1. Press OPEN button to open the cover.

2. Place in a disc and press it down with your fingers near the center hole.

A click is heard.

**Notes:**

- Set the disc securely. Failure to set it securely could result in damage.
- Do not use cracked or warped discs. Doing so could result in damage.
- Place single-sided DVDs or CDs in with the label (Printed) side facing upwards.  
For double-sided DVDs, check each side carefully, then place the disc in securely (Until a click is heard).
- For CDs or one-sided DVDs, you do not have to worry about touching the label (Printed) side of the disc with your fingers. Since two-sided DVDs have signals recorded on both sides, be careful not to scratch them when removing them from the player.

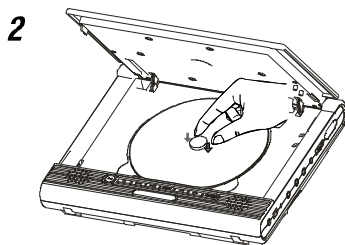

3. Close the disc cover.

**REPLACE 6 PCS AA BATTERIES**

1. Open the batteries cover.
2. Replace the 6 PCS AA batteries.
3. Generally speaking, DVD playback time will be more than two hours with 6 PCS Ni-MH batteries of 2300 mAh.

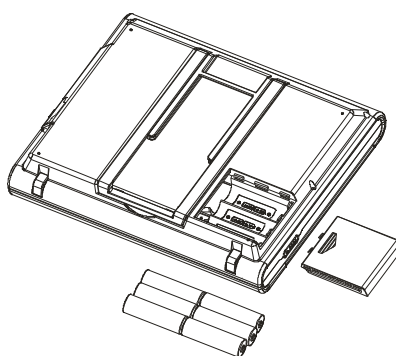
**NOTE:**

1. The playback time of the batteries has much to do with discs and operation factors etc..
2. It is suggested to use at least 2300mAh or better rechargeable batteries for best performance.
3. Remove the batteries when the player is not turned on.
4. Rechargeable batteries cannot be charged with the player.

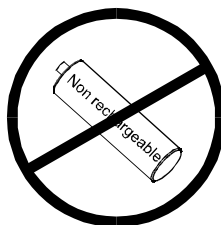
**WARNING:**

Non rechargeable batteries may not work properly with this device.



## PLAYBACK

1. Turn on the power of the player.
2. Open the disc cover.
3. Insert a disc correctly.
4. Close the cover.
5. The player will load the disc and play automatically. If the disc does not play, push the ► button.

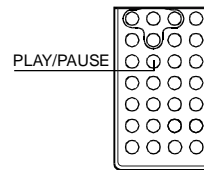

## STOP PLAYBACK

1. Press ■ on the key board or on the remote control while playing.
2. The player remembers the stopping place.
3. Resume playback from the point where it stopped by pressing the ► key.
4. To clear stopping mark, press ■ again at stop status. The player will not play from the stopping place when pressing ► next time.

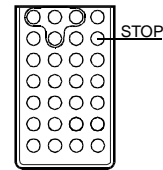

## PAUSE PLAYBACK

1. Press ►/|| on the key board or on the remote control during playback.
2. Press ►/|| again to resume normal playback.

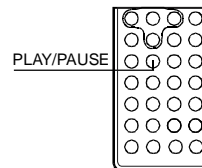

### PLAYING AT FAST SPEED

1. Press ►► or ◀◀ button on the key board or on the remote control during playback.
2. The playback speed will be changed each time you press the ►► or ◀◀ .  
The speed will be changed to 2X, 4X, 8X, 20X, 1X each time you press the button.

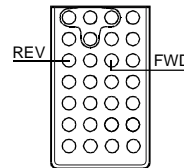

### PLAYBACK IN SLOW MOTION

1. Press the ► button on the remote control during playback. The playback speed becomes 1/2, 1/3, 1/4, 1/5, 1/6 or 1/7 of the normal speed each time you press the button.
2. When pressing ► during pause status, the player will show a still picture on the screen. The picture will be changed one frame each time the button is pressed.

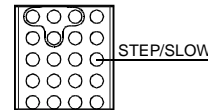

#### NOTE:

During fast or slow motion playback, the sound is muted expect playing a CD or MP3 disc. To resume normal playback, press ► .

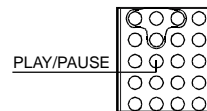

### A-B/REPEAT PLAYBACK

1. A-B playback
  - When pressing A-B button on the remote control during playback, the current point would be located on the remote control, and REPEAT A- appears on the screen.
  - Press A-B button again, B point would be located and the player would play from A point to B point repeatedly.
  - Press A-B button again. A-B playback would be cancelled and the player will resume normal playback.
2. Repeat a Title, Chapter or Track
  - Press the REPEAT button on the remote control during playback.
  - The chapter or the title(For DVD) and the track or entire disc (For CD) will be played repeatedly.
  - The REPEAT mode will be changed each time the repeat button is pressed.

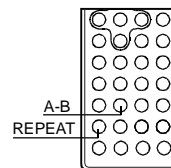

### ZOOM FUNCTION

1. Press ZOOM on the remote control during playback. The picture on the screen will be zoomed.
2. The zooming rate changes each time the ZOOM button is pressed. The sequence is 2X, 3X, 4X, 1/2X, 1/3X, 1/4X, 1X.

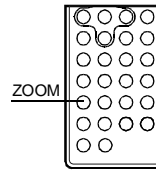

### SEARCHING FOR A SPECIFIC SCENE

1. Press the SEARCH button on the remote control.
2. Press the UP, DOWN and ENTER button to move to a desired section.
3. Input a valid number to choose specific time or title, chapter or track.
4. Press the ENTER button to play the specific scene.
5. Press the SEARCH button to resume normal screen.

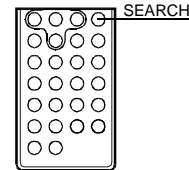

### SELECTING SUBTITLE

You can select a preferred subtitle from those included on the DVD video disc by pressing the SUBTITLE button on the remote control during playback.

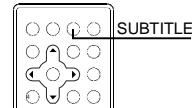

### CHANGING THE ANGLE

Press the ANGLE button on the remote control while playing a scene recorded with multiple angles. If your DVD disc is not recorded with multiple angles, pressing ANGLE button will not effect at all.

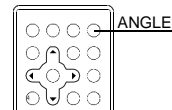

### CHANGING THE AUDIO LANGUAGE

1. Press the AUDIO button on the remote control during playback. You can select different audio languages included on the DVD video disc.
2. For VCD or CD, you can choose the channels to play.

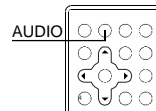



**PROGRAM PLAYBACK**

The program playback function can automatically play titles, chapters, or tracks in accordance with the programmed order.

1. Insert a disc and then press the PROGRAM button on the remote control.

The menu appears as below.

PROG			
TC	TC	TC	TC
1--:--	5--:--	9--:--	13--:--
2--:--	6--:--	10--:--	14--:--
3--:--	7--:--	11--:--	15--:--
4--:--	8--:--	12--:--	16--:--
<PLAY> <CLEAR>			

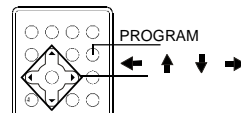

2. Use **← / ↑ / ↓ / →** and the number buttons to select the title and chapter in your preferred order.

PROG			
TC	TC	TC	TC
01:01	--:--	--:--	--:--
01:02	--:--	--:--	--:--
--:--	--:--	--:--	--:--
--:--	--:--	--:--	--:--
<PLAY> <CLEAR>			

3. Use **← / ↑ / ↓ / →** to move the cursor to **PLAY** and press the ENTER button. The player starts PROGRAM playback.
4. To exit, press the PROGRAM again.

**NOTES:**

- When the DVD video player is turned off or the discs are removed, the programmed items will be removed.
- Referring the disc, some may not have this function.
- Selecting an inexistent title or chapter, program playback cancels automatically.

## USING THE ON-SCREEN DISPLAY

1. This DVD video player allows you to view the operational status and disc information on the screen.
2. Press the OSD button on the remote control during playback. The disc information will be displayed on the screen.
3. Press the OSD button again, the information will disappear.

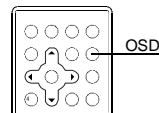

## PLAYING A MP3 FORMAT DISC AND JPEG CD

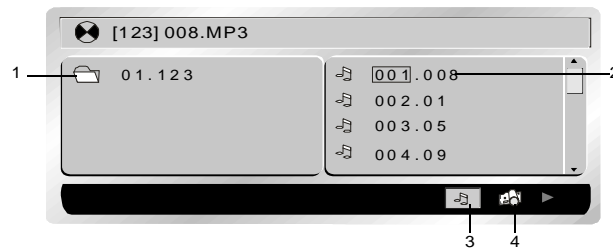

1. **Folder**
2. **Files**
3. **MP3 ICON**
4. **JPEG ICON**

- Use /// to move the cursor to a folder, a file, MP3 ICON or JPEG ICON.
- In order to play Mp3 files, move the cursor to MP3 ICON and press the ENTER button. In order to play JPEG files, move the cursor to JPEG ICON and press the ENTER button.
- Choose the desired file and press ENTER to play.
- Press the A-B button to get A-B REPEAT function. Press the REPEAT button to switch repeat mode(REP1,REP DIR, REP ALL, REP OFF).  
REP1 means repeating the track; REP DIR means repeating the folder; REP ALL means repeating the whole disc.

**USING THE USB PORT**

1. Turn on the power of the player.
2. Plug the USB card into the USB port of the DVD player.  
The USB card will be read automatically.

**NOTE:**

1. If the disc is playing, the USB card can not be read.
2. The player may not work properly if using the USB connecting cable. It is suggested not to use it.
3. Supply USB 1.1 use.



## GENERAL STEPS OF SETUP

1. Press the SETUP button on the remote control, the main setup menu appears.

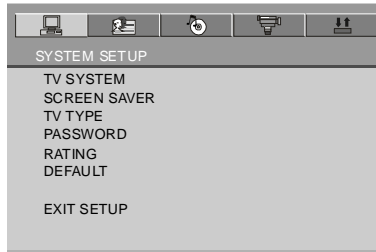

2. Press the LEFT and RIGHT buttons to highlight the icon of the desired page, then press the DOWN or UP button to activate that page.



3. Press the DOWN button to highlight the desired option. Press ENTER or RIGHT to select the choices of the options that appear.

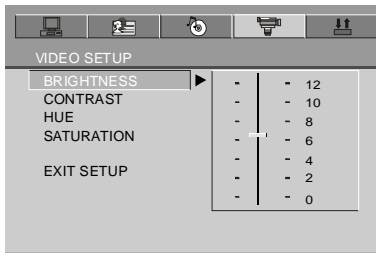

4. Press LEFT/RIGHT/UP/DOWN button to highlight the EXIT SETUP option, then press ENTER or SETUP again to exit the SETUP MENU.

### NOTE:

The pressing of the following buttons will turn off the setup menu, and the choices that have been changed will be saved at the same time: Subtitle, Title, Return, Stop, Play / Pause, Step, Next, Prev, Zoom, Program, Repeat, Angle, Mute.

The system setup options are illustrated below:

## TV SYSTEM

If you want to connect the player to a TV, please choose a correct TV system first.

- AUTO: Choose this setting if your DVD player is connected to a multi-system TV.
- NTSC: Choose this setting if your DVD player is connected to a NTSC TV.
- PAL: Choose this setting if your DVD player is connected to a PAL TV.
- The default setting is NTSC.

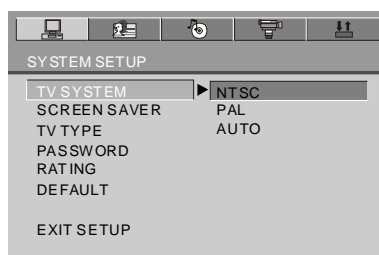

### NOTE:

Setting with the incorrect TV system will result in a black and white picture on your TV screen.

## SCREEN SAVER

Set the screen saver option to ON status. When your DVD player is at STOP or NO DISC status, or when it is paused for a long time, the screen saver will be displayed. This feature can protect the screen from damage.

- ON: Choose this setting to activate the screen saver.
- OFF: Choose this setting to cancel the screen saver.
- The default setting is ON.

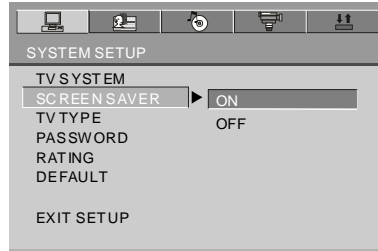

## TV TYPE

**16 : 9 (Wide Screen):** Choose this setting if your DVD player is connected to a wide screen TV. If you choose this setting and you don't have a wide screen TV, the images on the screen may appear distorted due to vertical compression.

**4 : 3 LB (Letter Box):** Choosing this setting if your DVD player is connected to a normal ratio TV. You'll see the movies in their original aspect ratio (Height-to-width ratio). You'll see the entire frame of the movie. The movie might appear with black bars at the top and bottom of the screen.

**4 : 3 PS (Pan & Scan):** Choosing this setting if your DVD player is connected to a normal ratio TV. You can fill the movie to the entire screen of your TV. This might mean that parts of the picture (The left and right edges) won't be seen.

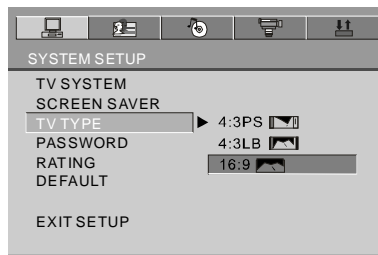
**NOTES:**

- The image display ratio is related to the recorded disc format. Some discs can not be displayed in the aspect ratio preferred.
- If you play a disc recorded in 4:3 format on a wide screen TV, black bars will appear on the left and right side of the screen.
- You must adjust the screen setting depending on the type of the TV.

## PASSWORD

Step1: For first time use: enter 0000 as password or assigned password to unlock.

Step2: Once parental control is unlocked, go to rating menu and assign rating.

Step3: Enter a new password of your choice in 4 digits to lock the player rating.

If you forget your assigned password, you can use 0000 to unlock the rating again.

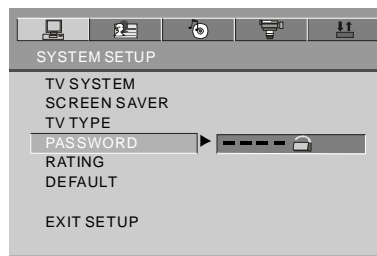

## RATING

The RATING feature works with DVD discs that have been assigned a rating. This helps you to control the types of DVDs that the player can play.

- There are eight limited rating options:  
KID SAFE, G, PG, PG13, PG-R, R, NC-17, ADULT.
- The default setting is ADULT.

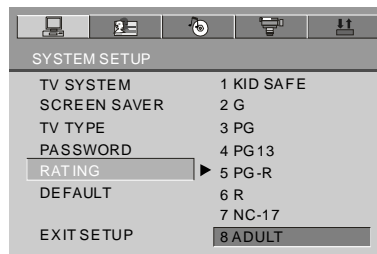

### NOTE:

If the password option is locked, you cannot change the rating.

## DEFAULT

Choose this option to resume factory settings.

The language setup options are illustrated below:

### OSD LANGUAGE

Highlight the OSD LANGUAGE option, and press the arrow buttons to choose the OSD language you prefer. Press ENTER to confirm, and it will display the OSD in the language you have chosen. There are 5 optional OSD languages: English, German, Spanish, French and Italian.



### AUDIO LANGUAGE

Highlight the AUDIO LANG option, and press the arrow buttons to choose the audio language you prefer. Press ENTER to confirm. If the disc you are playing has that language available, it will output audio in that language. There are 8 optional audio languages: Chinese, English, Japanese, French, Spanish, Portuguese, Italian and German.

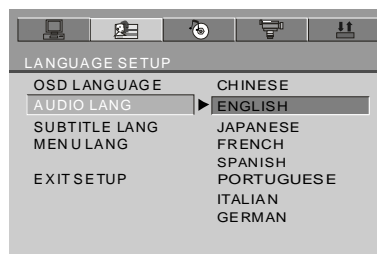

## SUBTITLE LANGUAGE

Highlight the SUBTITLE LANG option, and press the arrow buttons to choose the subtitle language you prefer. Press ENTER to confirm. If the disc you are playing has that language available, it will display subtitles in that language. There are 7 optional subtitle languages: Chinese, English, Japanese, French, Spanish, Italian and German.

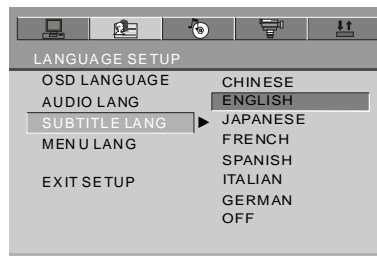

## MENU LANGUAGE

Highlight the MENU LANG option, and press the arrow buttons to choose the menu language you prefer. Press ENTER to confirm. If the disc you are playing has that language available, it will display menu in that language. There are 8 optional menu languages: Chinese, English, Japanese, French, Spanish, Portuguese, German and Italian.

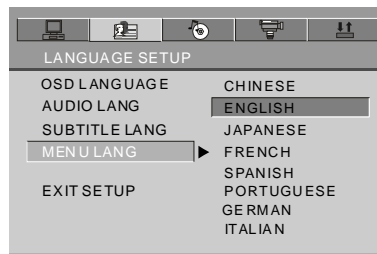

### NOTE:

If your preferred language isn't available, the disc's default language will be played. The default language of your DVD player is English.

## AUDIO OUT

Highlight the AUDIO OUT option, and press the arrow buttons to choose the audio output mode you prefer. Press ENTER to confirm:

There are 3 optional audio output modes: SPDIF / OFF, SPDIF / RAW and SPDIF / PCM.

- SPDIF / OFF: Choose this setting to output analog signal, and there will be no signal output from optical jack.
- SPDIF / RAW: Choose this setting if your DVD player is connected to a power amplifier with an optical cable. When playing a disc recorded with Dolby Digital and MPEG audio formats, the corresponding digital signals will be outputted from the optical Output jack.
- SPDIF / PCM: Choose this setting if your DVD player is connected to a 2-channel digital stereo amplifier. When playing a disc recorded with Dolby Digital and MPEG audio formats, audio signals will be modulated into a 2-channel PCM signal, and it will be outputted from the optical Output jack .



The video setup options are illustrated below:

## BRIGHTNESS

Use the UP and DOWN buttons to move the scroll and adjust the brightness.

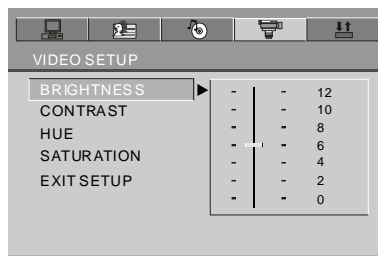

## CONTRAST

Use the UP and DOWN buttons to move the scroll and adjust the contrast.

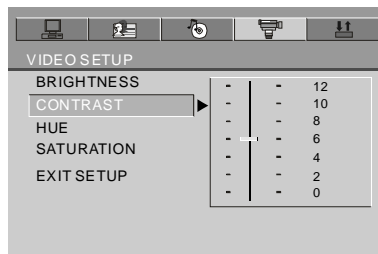



**HUE**

Use the UP and DOWN buttons to move the scroll and adjust the hue.

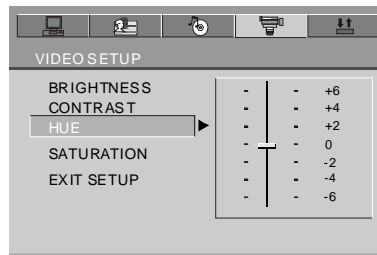
**SATURATION**

Use the UP and DOWN buttons to move the scroll and adjust the saturation.

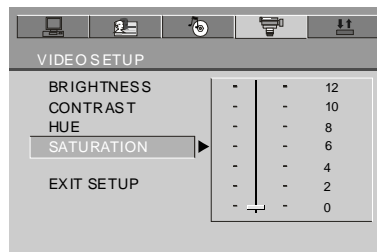

The digital setup options are illustrated below:

### OP MODE

There are two output modes: one is LINE OUT; the other is RF REMOD.

LINE OUT: To carry out the linear compression function for input signal.  
Choose it in the evenings for the sake of its low volume.

RF REMOD: Choose it during the daytime for the sake of its high volume.

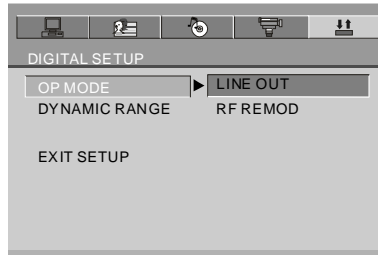

### DYNAMIC RANGE

Choose this setting to adjust the line out compressing ratio and get different effects. If adjusting to FULL, the audio signal peak value will be compressed to be minimum; while adjusting to OFF, to be maximum.

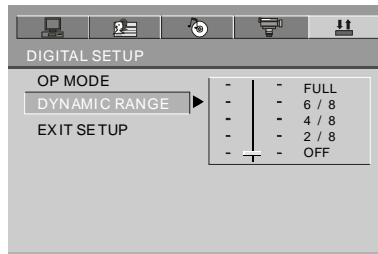

## SIZE AND PARAMETER

Product name:	TABLET DVD player
Power:	DC12V
Consumption:	<8.5W
Audio out:	R/L 2ch,OPTICAL
Video out:	Composite
Size:	210X175X40mm
Weight:	710g (W/O battery)

## TROUBLE SHOOTING

Symptoms	Possible causes	Remedies
The disc does not play	Disc is loaded incorrectly.	Load the disc with the label side up, and firmly press into the center.
	Disc is dirty or scratched.	Make sure the disc is free from scratches or fingerprints.
	Wrong region disc.	Use the right region disc.
No display	AV cable is disconnected.	Connect the cable firmly.
	Wrong setting or connection for the player or TV.	Setting or connecting correctly with your player or TV.
No sound	AV cable is disconnected.	Connect the cable firmly.
	Wrong setting or connection for the player or TV.	Setting or connecting correctly with your player or TV.

Maintenance and clean the unit only as recommended in the operational instructions.

**DAMAGE REQUIRING SERVICE**

Have the unit serviced by a qualified service technician if:

- The unit has been exposed to rain or water.
- The unit does not seem to operate normally.
- The unit exhibits a marked change in performance.

**DO NOT ATTEMPT TO SERVICE THE UNIT BY YOURSELF!**

DVD



SDV47-A-ENG-N2-A1

## Free Manuals Download Website

<http://myh66.com>

<http://usermanuals.us>

<http://www.somanuals.com>

<http://www.4manuals.cc>

<http://www.manual-lib.com>

<http://www.404manual.com>

<http://www.luxmanual.com>

<http://aubethermostatmanual.com>

Golf course search by state

<http://golfingnear.com>

Email search by domain

<http://emailbydomain.com>

Auto manuals search

<http://auto.somanuals.com>

TV manuals search

<http://tv.somanuals.com>